

# Compact Disc Player **SL-PS770D**

## Operating Instructions

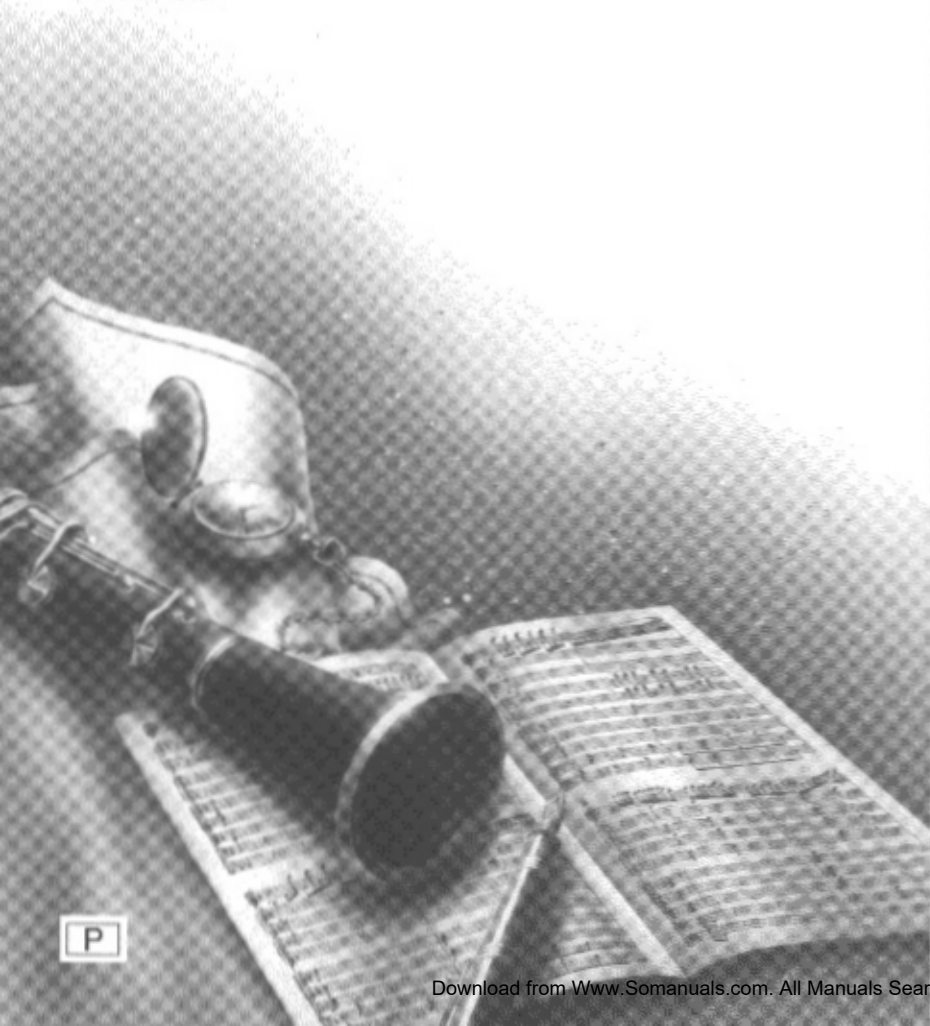

COMPACT  
**disc**  
DIGITAL AUDIO



# Technics®

Before connecting, operating or adjusting this product, please read these instructions completely. Please save this manual.

P

RQT4532-P

Thank you for purchasing this product. For optimum performance and safety, please read these instructions carefully.

The model number and serial number of this product can be found on either the back or the bottom of the unit. Please note them in the space provided below and keep for future reference.

MODEL NUMBER SL-PS770D

SERIAL NUMBER \_\_\_\_\_

User memo:

DATE OF PURCHASE \_\_\_\_\_

DEALER NAME \_\_\_\_\_

DEALER ADDRESS \_\_\_\_\_

TELEPHONE NUMBER \_\_\_\_\_

**CAUTION!**  
 THIS PRODUCT UTILIZES A LASER. USE OF CONTROLS OR ADJUSTMENTS OR PERFORMANCE OF PROCEDURES OTHER THAN THOSE SPECIFIED HEREIN MAY RESULT IN HAZARDOUS RADIATION EXPOSURE. DO NOT OPEN COVERS AND DO NOT REPAIR YOURSELF. REFER SERVICING TO QUALIFIED PERSONNEL.

**WARNING:**  
 TO REDUCE THE RISK OF FIRE, ELECTRIC SHOCK OR PRODUCT DAMAGE, DO NOT EXPOSE THIS APPLIANCE TO RAIN, SPLASHING, DRIPPING OR MOISTURE.

**Supplied accessories** ..... 2  
**Listening caution** ..... 3  
**Precautions** ..... 4  
 Safety ..... 4  
 Installation ..... 4  
 Maintenance ..... 4  
 Service ..... 4  
**Connections** ..... 5  
**Concerning the remote control** ... 5  
 Battery installation ..... 5  
 Correct method of use ..... 5  
**Controls** ..... 6  
**Sequential play** **Basic Play** ..... 7  
**Direct access play** ..... 8  
**Random play** ..... 8  
**Program play** ..... 9  
**Other CD playback functions** ... 10  
 Repeat ..... 10  
 A-B repeat ..... 10  
 Output level control ..... 10  
 Time fade ..... 11  
 Time mode selection ..... 11  
 Auto cue ..... 12  
 Peak search ..... 12  
**CD edit recording** ..... 13  
**To listen with headphones** ..... 14  
**Concerning CDs** ..... 15  
**Maintenance** ..... 15  
**Product service** ..... 15  
 Product information ..... 15  
**Troubleshooting guide** ..... Back cover  
**Technical specifications** ..... Back cover

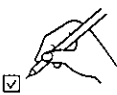
 Please check and identify the supplied accessories.

Use numbers indicated in parentheses when asking for replacements parts. **To order accessories contact 1-800-211-7262 or web site(<http://www.panasonic.com>).**

AC power supply cord (SJA172) ..... 1 pc.

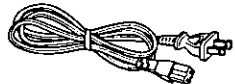

Stereo connection cable (SJP2249-3) ..... 1 pc.

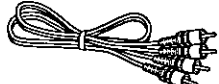

Remote control (EUR642101) ..... 1 pc.

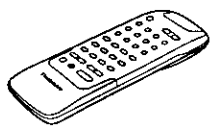

Batteries for remote control ..... 2 pcs.

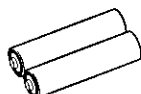



**CAUTION:**

This equipment has been tested and found to comply with the limits for a Class B digital device, pursuant to Part 15 of the FCC Rules.

These limits are designed to provide reasonable protection against harmful interference in a residential installation. This equipment generates, uses and can radiate radio frequency energy and, if not installed and used in accordance with the instructions, may cause harmful interference to radio communications. However, there is no guarantee that interference will not occur in a particular installation. If this equipment does cause harmful interference to radio or television reception, which can be determined by turning the equipment off and on, the user is encouraged to try to correct the interference by one of the following measures:

- Reorient or relocate the receiving antenna.
- Increase the separation between the equipment and receiver.
- Connect the equipment into an outlet on a circuit different from that to which the receiver is connected.
- Consult the dealer or an experienced radio/TV technician for help.

Any unauthorized changes or modifications to this equipment would void the user's authority to operate this device.

This device complies with Part 15 of the FCC Rules. Operation is subject to the following two conditions: (1) This device may not cause harmful interference, and (2) this device must accept any interference received, including interference that may cause undesired operation.

Selecting fine audio equipment such as the unit you've just purchased is only the start of your musical enjoyment. Now it's time to consider how you can maximize the fun and excitement your equipment offers. This manufacturer and the Electronic Industries Association's Consumer Electronics Group want you to get the most out of your equipment by playing it at a safe level. One that lets the sound come through loud and clear without annoying blaring or distortion—and, most importantly, without affecting your sensitive hearing.

We recommend you to avoid prolonged exposure to excessive noise.

Sound can be deceiving. Over time your hearing "comfort level" adapts to higher volumes of sound. So what sounds "normal" can actually be loud and harmful to your hearing.

Guard against this by setting your equipment at a safe level BEFORE your hearing adapts.



To establish a safe level:

- Start your volume control at a low setting.
- Slowly increase the sound until you can hear it comfortably and clearly, and without distortion.

Once you have established a comfortable sound level:

- Set the dial and leave it there.

Taking a minute to do this now will help to prevent hearing damage or loss in the future. After all, we want you listening for a lifetime.

	<b>CAUTION</b> <b>RISK OF ELECTRIC SHOCK</b> <b>DO NOT OPEN</b>	
<p><b>CAUTION:</b> TO REDUCE THE RISK OF ELECTRIC SHOCK, DO NOT REMOVE SCREWS. NO USER-SERVICEABLE PARTS INSIDE. REFER SERVICING TO QUALIFIED SERVICE PERSONNEL.</p>		



The lightning flash with arrowhead symbol, within an equilateral triangle, is intended to alert the user to the presence of uninsulated "dangerous voltage" within the product's enclosure that may be of sufficient magnitude to constitute a risk of electric shock to persons.



The exclamation point within an equilateral triangle is intended to alert the user to the presence of important operating and maintenance (servicing) instructions in the literature accompanying the appliance.

## Precautions

Before using this unit please read these operating instructions carefully. Take special care to follow the warnings indicated on the unit itself as well as the safety suggestions listed below. Afterwards keep them handy for future reference.

### Safety

1. **Power Source**—The unit should be connected to power supply only of the type described in the operating instructions or as marked on the unit.
2. **Polarization**—If the unit is equipped with a polarized AC power plug (a plug having one blade wider than the other), that plug will fit into the AC outlet only one way. This is a safety feature. If you are unable to insert the plug fully into the outlet, try reversing the plug. If the plug should still fail to fit, contact your electrician to replace your obsolete outlet. Do not defeat the safety purpose of the polarized plug.
3. **Power Cord Protection**—AC power supply cords should be routed so that they are not likely to be walked on or pinched by items placed upon or against them. Never take hold of the plug or cord if your hand is wet, and always grasp the plug body when connecting or disconnecting it.
4. **Nonuse Periods**—When the unit is not used, turn the power off. When left unused for a long period of time, the unit should be unplugged from the household AC outlet.

### Installation

#### Environment

1. **Water and Moisture**—Do not use this unit near water—for example, near a bathtub, washbowl, swimming pool, or the like. Damp basements should also be avoided.
2. **Condensation**—Moisture may form on the lens in the following conditions...
  - immediately after a heater has been turned on.
  - in a steamy or very humid room.
  - when the unit is suddenly moved from a cold environment to a warm one.If moisture forms inside this unit, it may not operate properly. To correct this problem, turn on the power and wait about one hour for the moisture to evaporate.
3. **Heat**—The unit should be situated away from heat sources such as radiators and the like. It also should not be placed in temperatures less than 5°C (41°F) or greater than 35°C (95°F).

### Placement

1. **Ventilation**—The unit should be situated so that its location or position does not interfere with its proper ventilation. Allow 10 cm (4") clearance from the rear of the unit.
2. **Foreign Material**—Care should be taken so that objects do not fall into and liquids are not spilled into the unit. Do not subject this unit to excessive smoke, dust, mechanical vibration, or shock.
3. **Magnetism**—The unit should be situated away from equipment or devices that generate strong magnetic fields.
4. **Stacking**—Do not place heavy objects, other than system components, on top of the unit.
5. **Surface**—Place the unit on a flat, level surface.
6. **Carts and Stands**—The unit should be used only with a cart or stand that is recommended by the manufacturer. The unit and cart combination should be moved with care. Quick stops, excessive force, and uneven surfaces may cause the unit and cart combination to overturn.
7. **Wall or Ceiling Mounting**—The unit should not be mounted to a wall or ceiling, unless specified in this operating instructions.



### Maintenance

Clean the cabinet, panel and controls with a soft cloth lightly moistened with mild detergent solution. Do not use any type of abrasive pad, scouring powder or solvent such as alcohol or benzene.

### Service

1. **Damage Requiring Service**—The unit should be serviced by qualified service personnel when:
  - (a) The AC power supply cord or the plug has been damaged; or
  - (b) Objects have fallen or liquid has been spilled into the unit; or
  - (c) The unit has been exposed to rain; or
  - (d) The unit does not appear to operate normally or exhibits a marked change in performance; or
  - (e) The unit has been dropped, or the enclosure damaged.
2. **Servicing**—The user should not attempt to service the unit beyond that described in the operating instructions. All other servicing should be referred to an authorized service personnel.

**For the address of an authorized servicer :**  
*In the U.S.A. 1-800-211-7262 or web site (<http://www.panasonic.com>)  
In Canada 905-624-5505 or web site ([www.panasonic.ca/ldbckca.htm](http://www.panasonic.ca/ldbckca.htm))*

## Connections

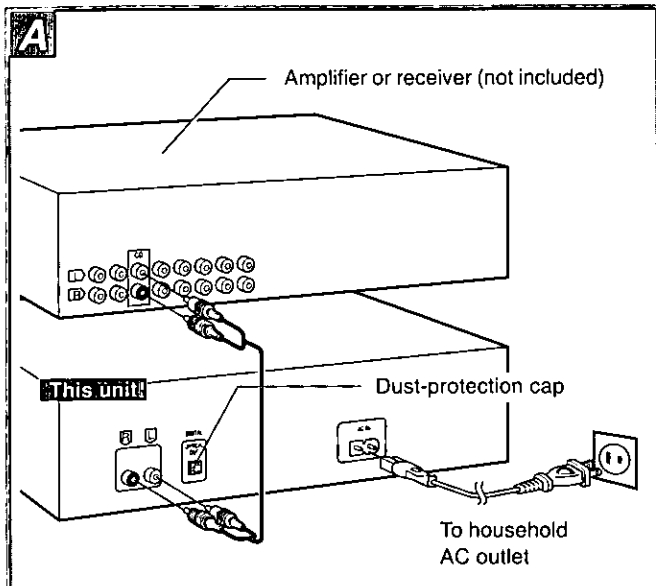

Before making connections, be sure that the power of this unit and all other system components is first turned off. **A**

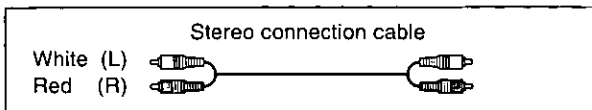

### Note

Although the figure shows the AC power supply cord being connected to a household AC outlet, if the amplifier (or receiver) is equipped with a AC outlet, connect the cord to that outlet.

## To connect a digital amplifier **B**

### Note

Remove the dust-protection cap which is inserted in the DIGITAL OPTICAL OUT terminal only if you connect a digital amplifier. When this terminal is not being used, attach the cap as shown in the illustration.

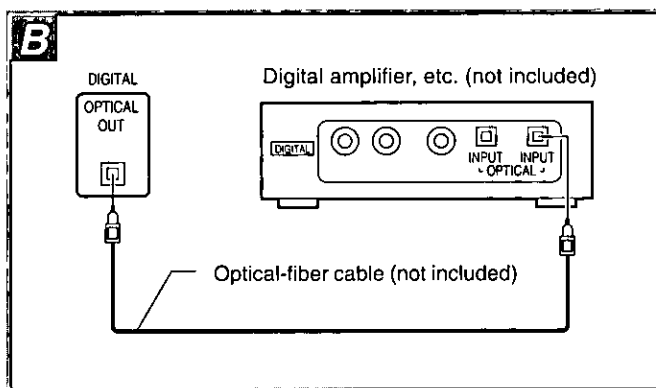

## Concerning the remote control

## Battery installation **C**

### Use of batteries

- Do not mix old and new batteries, or batteries of different types (manganese and alkaline, etc.).
- Never subject batteries to excessive heat or flame; do not attempt to disassemble them; and be sure they are not short-circuited.
- If the remote control is not to be used for a long period of time, remove the batteries and store them in a cool, dark place.
- Do not attempt to recharge alkaline or manganese batteries.
- Do not use rechargeable type batteries.

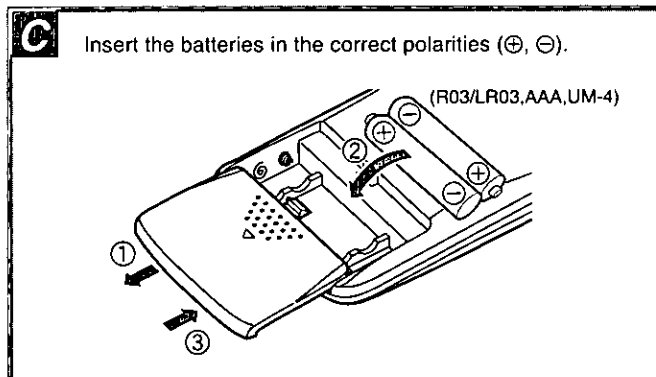

## Correct method of use **D**

### Operation notes

- Do not place obstacles between the remote control signal sensor and remote control unit.
- Do not expose the remote control signal sensor to direct sunlight or to the bright light of an inverter fluorescent light.
- Take care to keep the remote control signal sensor and end of the remote control unit free from dust.
- If this system is installed in a rack with glass doors, the thickness and color of the glass doors might make it necessary to use the remote control a shorter distance from the system.

## To prevent damage



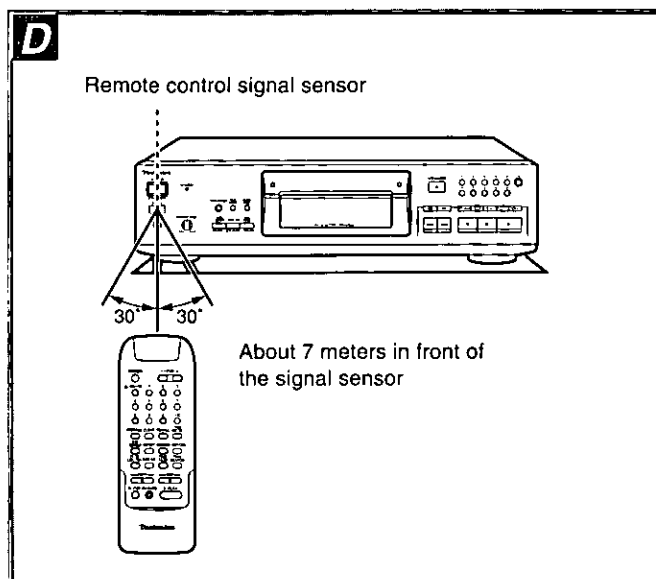

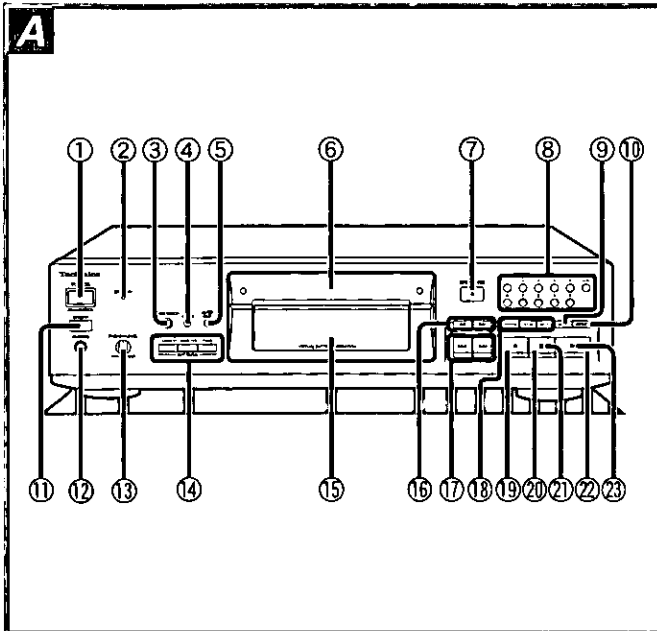

- Do not place heavy items on the unit.
- Do not disassemble or reconstruct it.
- Do not spill water or other liquids onto it.



## Controls



### Main unit

- ① Power "STANDBY /ON" switch ( POWER, STANDBY  )
- ② Standby indicator ( STANDBY )
- ③ Peak search button ( PEAK SEARCH )
- ④ Time mode select button ( TIME MODE )
- ⑤ Auto cue button ( AUTO CUE )
- ⑥ Disc tray
- ⑦ Disc tray open/close button (  OPEN/CLOSE )
- ⑧ Numeric buttons ( 1-9, 0,  $\geq 10$  )
- ⑨ Random play button ( RANDOM )
- ⑩ Repeat button ( REPEAT )
- ⑪ Remote control signal sensor ( SENSOR )
- ⑫ Headphones jack ( PHONES )
- ⑬ Headphones volume control ( PHONES LEVEL )
- ⑭ CD edit record buttons ( EDIT GUIDE )
  - Tape length button ( TAPE LENGTH )
  - Tape side select button ( SIDE A/B )
  - Time fade button ( TIME FADE )
- ⑮ Display panel
- ⑯ Search buttons ( ,  )
- ⑰ Skip buttons ( ,  )
- ⑱ Program play buttons
  - Program button ( PROGRAM )
  - Clear button ( CLEAR )
  - Recall button ( RECALL )
- ⑲ Stop button (  )
- ⑳ Pause button (  )
- ㉑ Pause indicator (  )
- ㉒ Play button (  )
- ㉓ Play indicator (  )

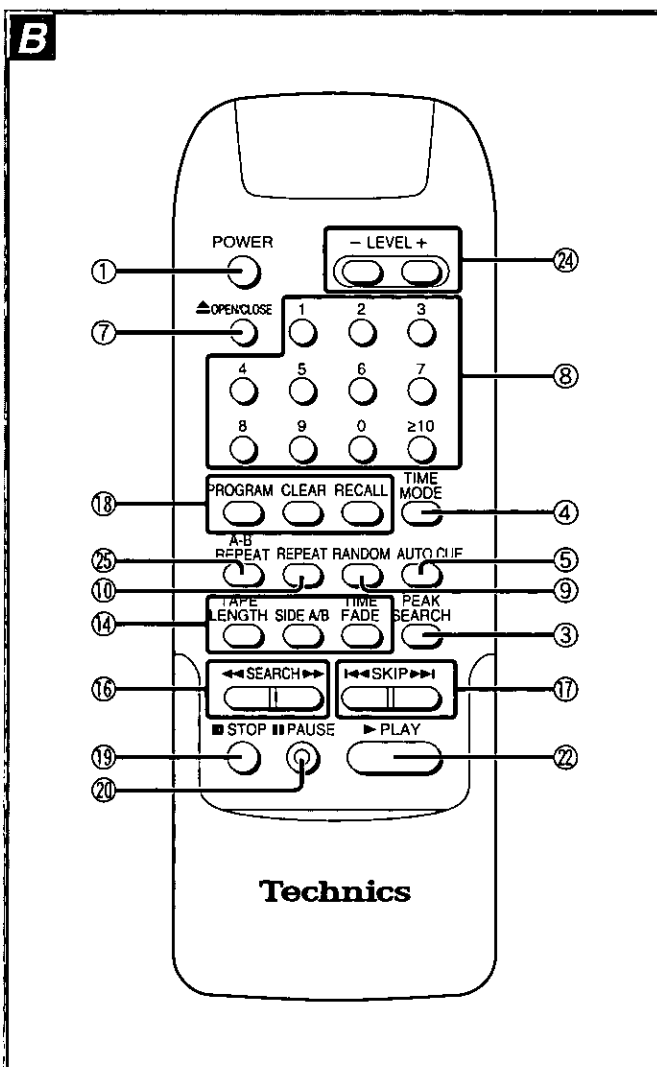

### Remote control

With the exception of ㉔ and ㉕, the buttons on the remote control function the same as the buttons on the main unit.

- ㉔ Level control ( - LEVEL + )
- ㉕ A-B repeat button ( A-B REPEAT )

## Sequential play **Basic Play**

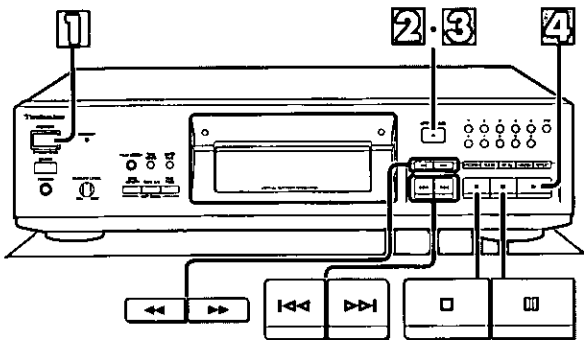

- 1** Press **POWER** (power goes on).
  - "no DISC" indicates that a CD has not been inserted.
  - If a CD is already in the disc tray, it automatically begins playing from the first track.
- 2** Press **△ OPEN/CLOSE** to open the tray and insert a disc.
- 3** Press **△ OPEN/CLOSE** to close the tray.
- 4** Press **▶ (play begins)**.
  - The play indicator illuminates green.
  - Play stops automatically after all tracks have been played.

**1** POWER

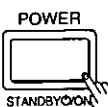

STANDBY/ON



**2** OPENCLOSE

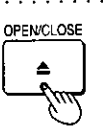
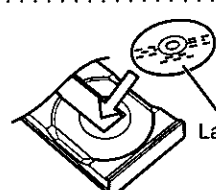

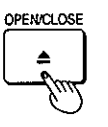

Label must face upward

**3** OPENCLOSE

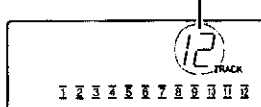

Total number of tracks



Total playing time

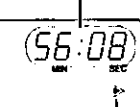

Displayed if there are 21 or more tracks on the disc.

**4** ▶

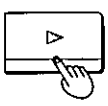

Track currently playing

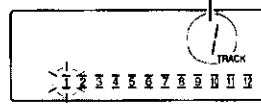

Index number



Elapsed time

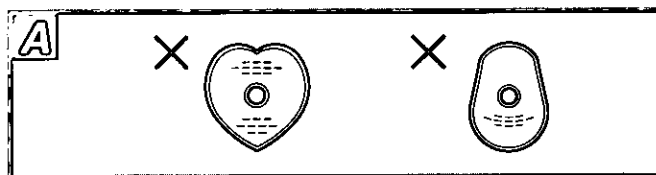

### To stop the disc play

Press **■**.

To pause	Press <b>■</b> during playback. The pause indicator illuminates orange. To resume playback, press <b>▶</b> .
To search forward/backward (SEARCH)	Hold down <b>◀◀</b> (backward) or <b>▶▶</b> (forward) during playback.
To skip forward/backward (SKIP)	Press <b>◀◀</b> (backward) or <b>▶▶</b> (forward) during playback.

### For your reference

- If you skip step 3 and press **▶**, the tray automatically closes and play begins from the first track.
- When you use the timer with another unit, be sure to turn this unit on.

### Virtual battery operation

This unit has a circuit (virtual battery) which operates to remove the small amount of noise contained in the mains when playing.

### Notes

- Do not use irregular shape CDs. **A**
- **During random play** (see page 8):
  - You cannot skip backward to previous tracks.
  - You can search only in the current track.
- **During program play** (see page 9):
  - Skipping is performed in the programmed order.
  - You can search only in the current track.
- **During A-B repeat** (see page 10):
  - Searching can be performed beyond the A-B segment. (A-B repeat will not be cancelled.)



## Direct access play

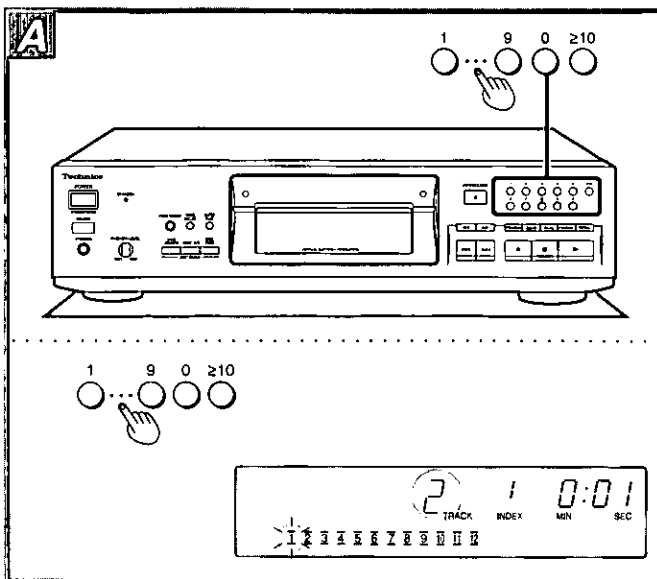

With this function, a disc is played from a desired track to the last track and then stops automatically.

### Press the numeric buttons.

Play will begin from the selected track number.

### To select a two-digit track

Press  $\geq 10$  and then the two numbers you want within 7 seconds.

### For example

Track No. 25:  $\geq 10 \rightarrow 2 \rightarrow 5$

Track No. 30:  $\geq 10 \rightarrow 3 \rightarrow 0$

## Random play

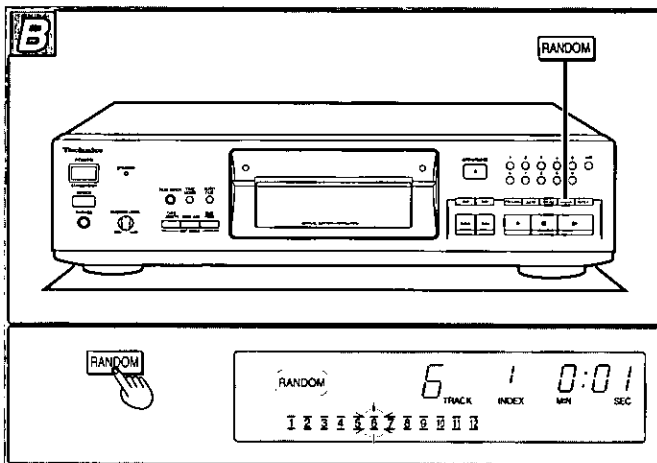

With this function, all tracks on a disc are played one time each in random order, and then play stops automatically.

### Press RANDOM.

Random play is cancelled when play is stopped.

### To cancel random play

Press RANDOM.

### For your reference

#### During program play:

The programmed tracks will be played in random order.



## Program play

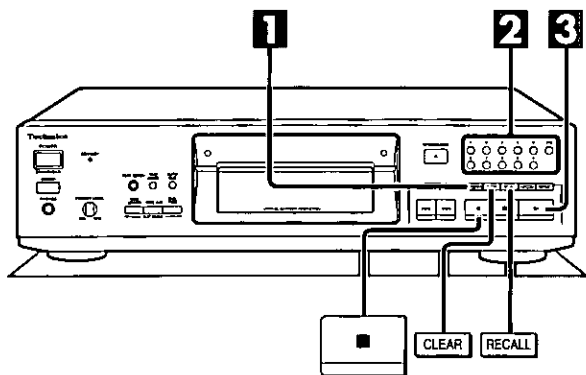

With this function, you can program up to 20 tracks in any order you like.

### 1 While the disc is stopped: Press PROGRAM .

If the button is pressed while the disc is playing, that track is programmed as the first.

### 2 Press the numeric buttons to specify the track numbers in order.

If you make a mistake when pressing a track number, press CLEAR.

### 3 Press ▶ .

Tracks are played in the programmed order, and then play stops automatically.

Program contents are stored even after playback ends.

To play the same program contents again, press ▶ .

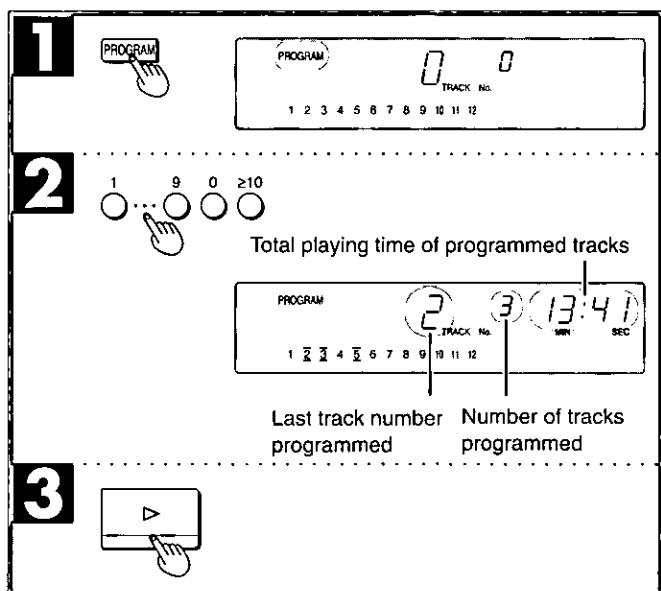

### To cancel program mode

Press PROGRAM.

### To select a two-digit track

Press  $\geq 10$  and then the two numbers you want within 7 seconds.

### For example

Track no. 25:  $\geq 10 \rightarrow 2 \rightarrow 5$

Track no. 30:  $\geq 10 \rightarrow 3 \rightarrow 0$

### Checking program contents

Press RECALL.

Each time the button is pressed, a track number and sequence number are displayed.

### To program additional tracks

Press the numeric buttons.

### To erase programmed tracks

#### • To erase the last programmed track

While the disc is stopped:

Press CLEAR.

One track is erased each time the button is pressed.

#### • To erase a track within the program

Press RECALL to display the track to be erased, and then press CLEAR to erase the displayed track.

#### • To erase all tracks

While the disc is stopped:

Press ■.

Program mode is also switched off.

### For your reference

"-F" appears on the display:

When 21 tracks have been specified (no further programming possible).

"----" appears on the display:

• When the total playing time of the programmed tracks exceeds 99 minutes and 59 seconds.

• When a track numbered 21 or higher has been specified. In these instances, the total playing time will not be displayed, but up to 20 tracks can still be programmed.

## Other CD playback functions

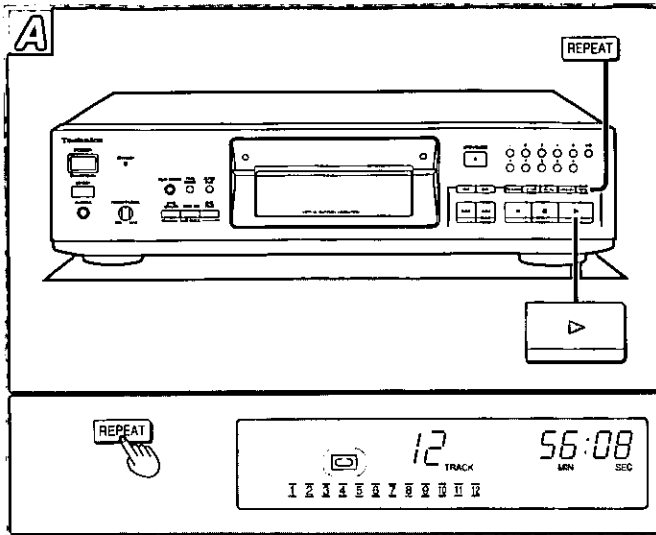

### Repeat

Playback of all tracks or desired tracks will be repeated.

Press REPEAT before or during play.

#### To cancel repeat

Press REPEAT.

#### To repeat only one track or specific tracks

- Specify the track numbers.  
Perform steps 1 and 2 on page 9.
- Press REPEAT.
- Press ►.

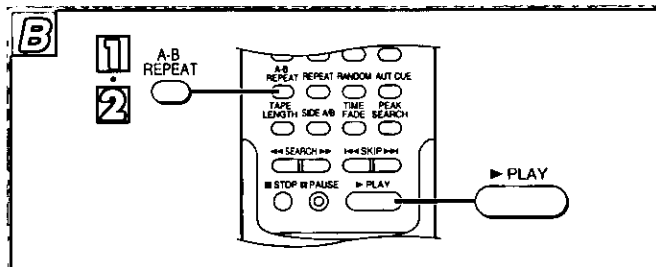

### A-B repeat

(Available only from the remote control)

While a disc is playing, if you specify a start point (point A) and an end point (point B), that segment will be repeated.

- While the disc is playing:  
Press A-B REPEAT at the start point (point A).
- Press A-B REPEAT at the end point (point B).  
The segment between A and B is played repeatedly.

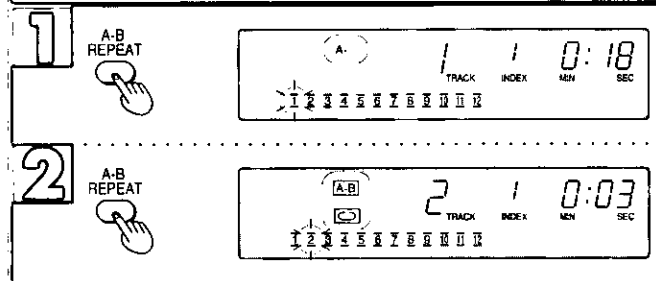

#### To cancel A-B repeat

Press A-B REPEAT.

#### For your reference

- A-B repeat is not possible during random play (see page 8) and program play (see page 9).
- If you press ► during A-B repeat, playback returns to point A.
- If you only specify point A, playback will still return to point A if you press ► at any point.

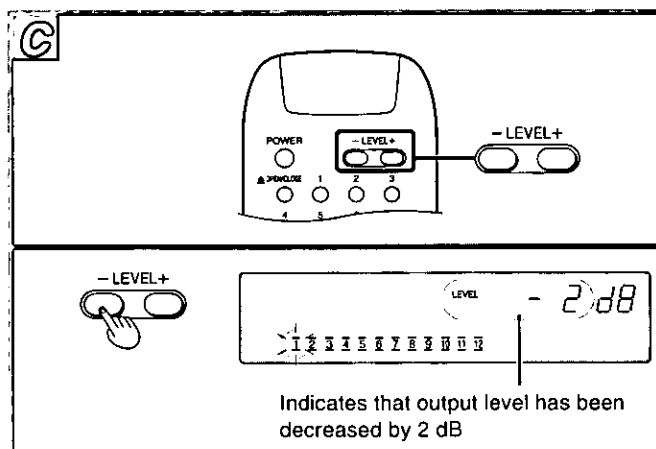

### Output level control

(Available only from the remote control)

Rather than adjusting the volume of the amplifier, you can temporarily lower the sound by decreasing the output of the CD player.

#### Press - LEVEL to decrease the volume.

Each time the button is pressed, the volume changes as follows.  
0dB → -2dB → -4dB ... → -12dB

#### To increase the output after it has been decreased

Press LEVEL +.

#### Note

During CD edit recording (see pages 13 and 14), in order to maintain a constant recording level, the output level cannot be adjusted.

#### For your reference

- If the unit is turned off and then turned on again, the output level returns to 0 dB (normal sound level).
- When the output level is decreased, the headphone volume decreases as well.

## Other CD playback functions

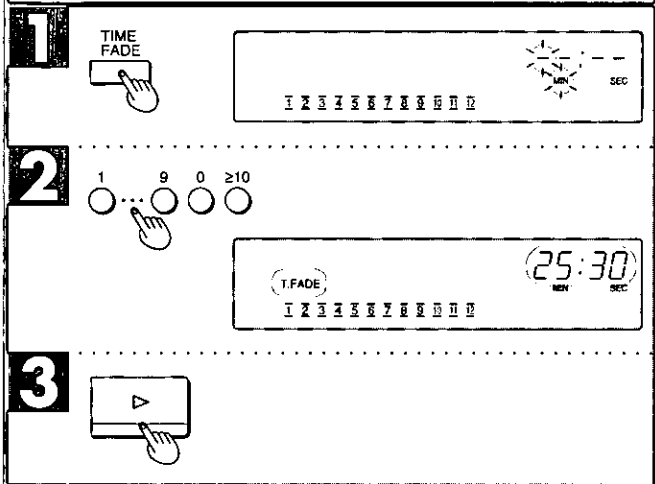
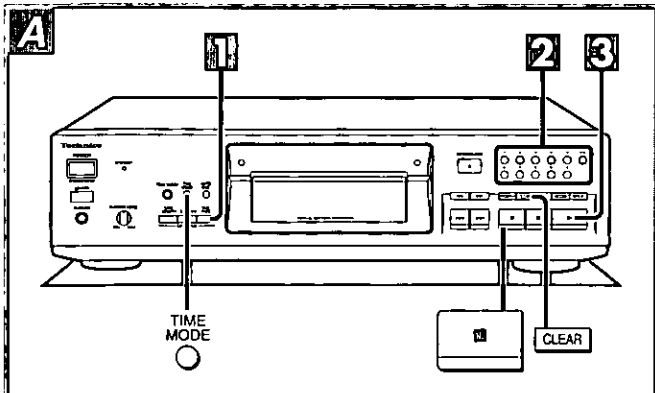

### Time fade

With this function you specify a time, and when that time is reached, the volume is gradually decreased and playback ends.

**1** While the disc is stopped or paused:  
Press **TIME FADE**.

**2** Press the numeric buttons to specify the playback time.

(5 seconds through 99 minutes and 59 seconds)

For example, to play a disc for 25 minutes and 30 seconds and then stop: 2 → 5 → 3 → 0

If you make a mistake while specifying the time, press **CLEAR** and specify it again.

**3** Press **▶**.

Five seconds before the specified time "T.FADE" flashes, the volume is gradually decreased, and the disc is paused. Time fade is canceled simultaneously.

**To cancel time fade**

Press **⏏**.

**To check the time remaining until fade out**

Press **TIME MODE** three times during playback.

#### Note

This function may not work properly if the disc is scratched or soiled.

### Time mode selection

While the disc is playing or paused:

Press **TIME MODE**.

Each time the button is pressed, the display changes in the order shown in the illustration.

If playback is stopped and then started again, the display returns to its original state.

#### For your reference

The following exceptions exist:

- **During playback of tracks numbered above 20;**

Display ③ appears as "----".

- **During program play;**

Time for programmed tracks appears for displays ② and ④.

- **During random play;**

Display ② appears as "----", and display ④ as "----".

- **During CD edit recording (see pages 13 and 14);**

Display ② shows the time remaining on the side of the tape being recorded on.

- **During time fade;**

The time remaining until fade out is displayed between displays ③ and ④.

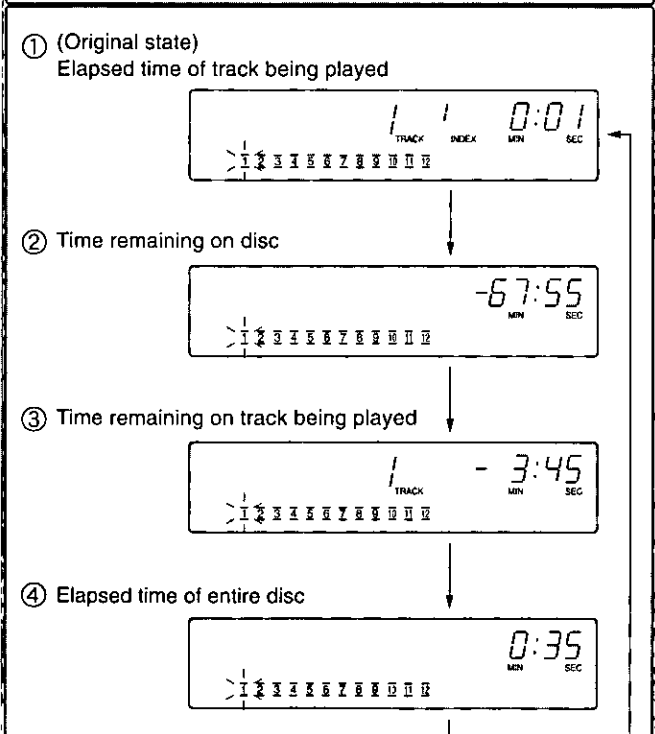
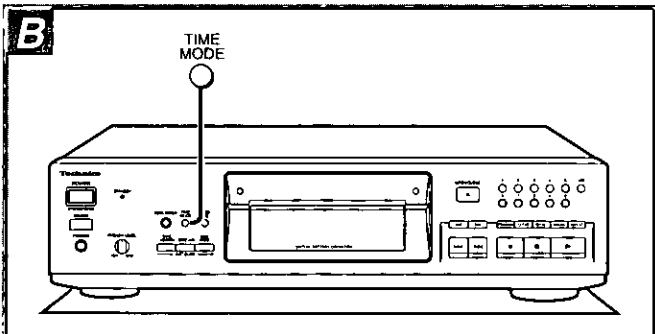

## Other CD playback functions

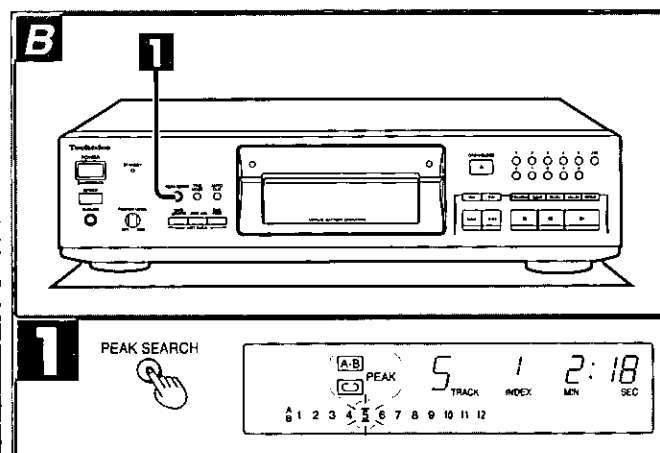
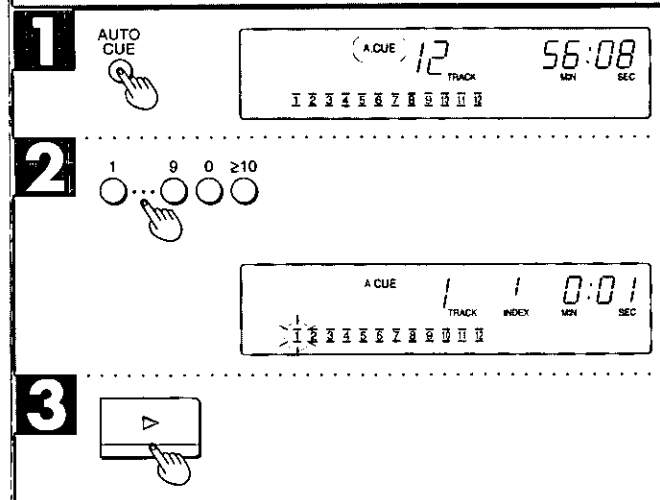
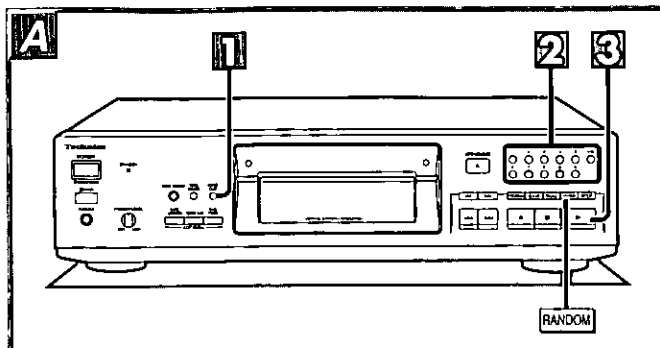

### Auto cue

With this function, playback is paused at the beginning (where sound can be heard) of all tracks, one track at a time.

#### 1 Press AUTO CUE.

If the disc was playing, playback is paused at the beginning of the next track.

#### 2 Press the numeric buttons to select the track number.

The unit switches to the play standby mode.

The pause indicator illuminates and the play indicator flashes.

#### 3 Press ▶.

Sound can be heard immediately.

To play tracks successively, press ▶ for each track.

### To cancel auto cue

While the disc is playing:

Press AUTO CUE.

### In combination with program play

Instead of step 2 above, program tracks following steps 1 and 2 on page 9 and then press ▶.

### In combination with random play

Instead of step 2 above, press RANDOM.

### Note

This function may not work properly on tracks which have soft sounds at the beginning, or on tracks which have large amounts of noise, etc.

### Peak search

This function searches for the peak level on the disc.

This is convenient when adjusting the recording level on a cassette deck.

#### 1 Press PEAK SEARCH.

The search for the peak level is started.

Searching for the peak level takes about 2 minutes and 30 seconds for a 60 minute CD. When the peak level is found, the unit repeatedly produces an approximately 6 second segment around the peak level.

#### 2 Adjust the recording level on the cassette deck.

Refer to the operating instructions of your cassette deck for details on this procedure.

### For your reference

Since multiple peaks exist on compact discs, even for the same disc a different peak level may be found each time a peak search is performed on a disc.

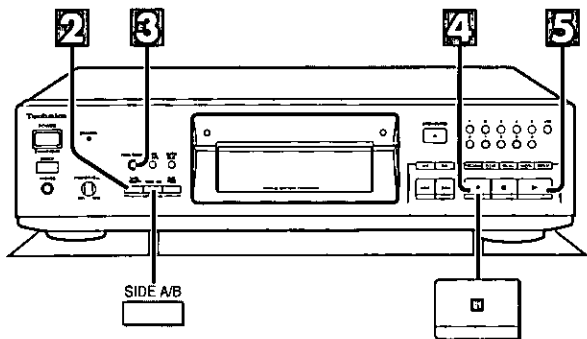

CD edit recording allows you to specify a tape length and then it automatically performs editing such that no tracks get cut off at the end of the tape.

With this function, an interval is automatically added between tracks if an interval doesn't already exist (auto space function). This is so tape search functions that use 4 second intervals to find the beginnings of tracks will work correctly.

## 1 Prepare the cassette deck.

1. Wind the leader tape and insert the tape.
2. Select noise reduction.
3. (Double-side playback decks only)  
Set the reverse mode to single side playback (  $\rightleftarrows$  ), and set the running direction of the tape to  $\blacktriangleright$ .
4. Set the cassette deck to recording standby mode.  
(For details, refer to the operating instructions for the cassette deck.)

## 2 Press TAPE LENGTH to specify the tape length.

This function divides the tracks on a disc between the two sides of a tape.

Each time the button is pressed, the tape length changes as illustrated.

- To select an arbitrary recording length, see below.
- To add tracks in the extra space on the tape, see page 14.
- To check the edit contents for side B or make changes, press SIDE A/B.

## 3 Press PEAK SEARCH to search for the peak level on the disc, and adjust the recording level on the cassette deck.

(See page 12)

## 4 Press $\square$ .

## 5 Press $\blacktriangleright$ at the same time you begin recording on the cassette deck.

### • When the tracks allotted to side A have been recorded:

The CD player pauses at the beginning of the first track on side B. The cassette deck continues to record to the end of side A and then stops automatically.

### • To record side B:

1. Remove the tape to wind the leader.
2. (For a double-side playback deck)  
Re-insert the tape and set the running direction to  $\blacktriangleleft$ .  
(For a single-side playback deck)  
Turn the tape around and re-insert it.
3. Press  $\blacktriangleright$  at the same time you begin recording on the cassette deck.

## To cancel CD edit mode

Press  $\square$ .

## To select an arbitrary recording length $\square$

Press TAPE LENGTH to select "C---" and enter the total time for both sides of the tape with the numeric buttons (1 to 99 minutes).

### For example

To select 30 minutes: 3  $\rightarrow$  0

To select 5 minutes: 0  $\rightarrow$  5

If you make a mistake when entering this value, select "C---" again.

(Continued on next page)

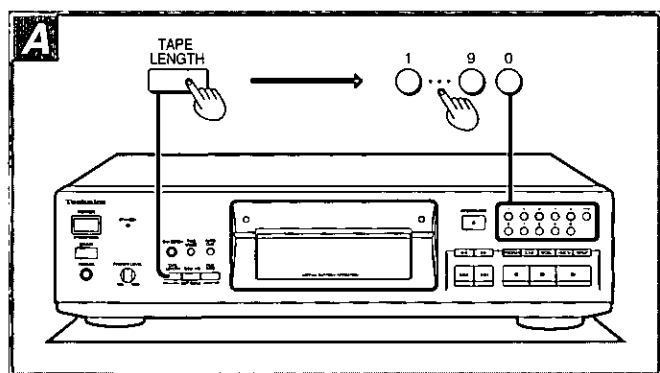
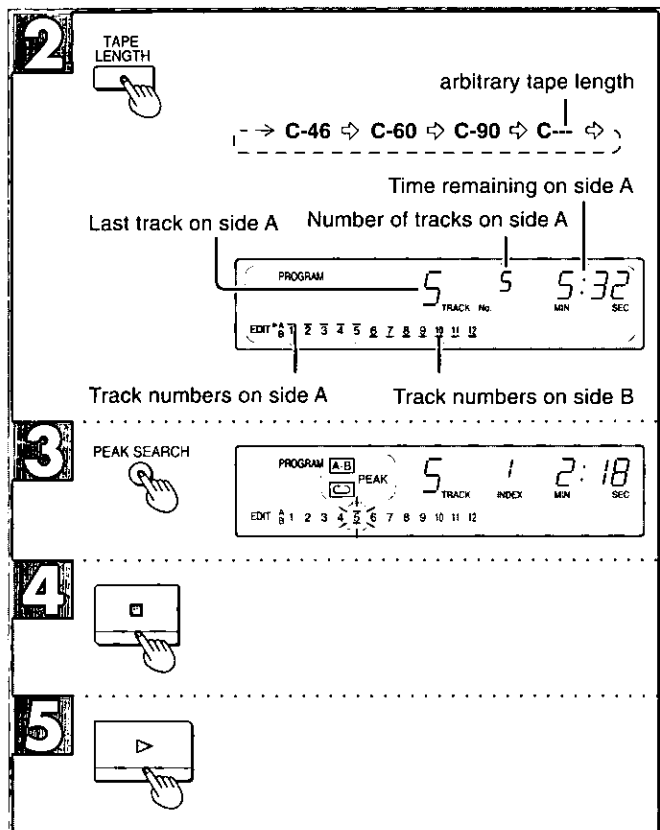

## CD edit recording

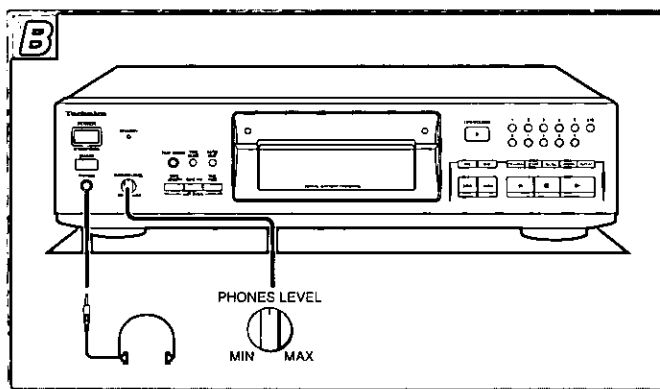
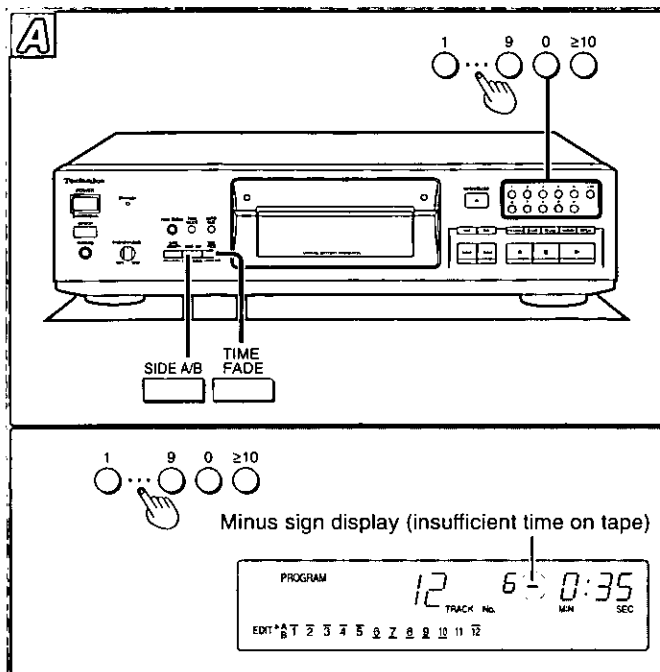

### To add tracks in the extra space on the tape **A**

After step 2 on page 13, press the numeric buttons to specify the track number.

When a minus sign appears on the display, it indicates that the time remaining on the tape is insufficient.

### To fade out at the end of the tape when the minus sign is displayed

Press TIME FADE.

At the end of the tape the sound will gradually decrease and recording will end.

If you want to fade out at the end of side B, press SIDE A/B, then repeat the above procedure.

#### Note

Editing cannot be performed on more than 20 tracks or on tracks numbered above 20.

In such instances, don't use the edit recording function, simply perform recording in the normal playback mode.

### To edit record programmed tracks

Program your tracks as in steps 1 and 2 on page 9 and then follow the steps on page 13.

Program tracks so that the total playing time is less than the length of the tape.

### To listen with headphones **B**

Reduce the volume, and connect the headphones.  
Plug type: 3.5 mm stereo

### To adjust the headphones volume

Adjust the volume with PHONES LEVEL.

#### Note

Avoid listening for prolonged periods of time to prevent hearing damage.

## Concerning CDs

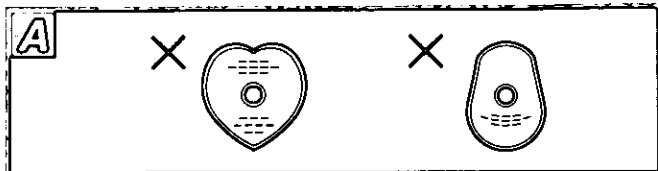

With this system, you can only play CDs having this mark. However, do not use irregular shape CDs. CDs of the sort can damage the unit. **A**

COMPACT  
**disc**  
DIGITAL AUDIO

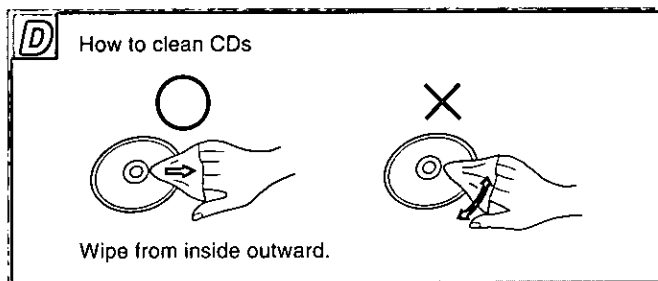
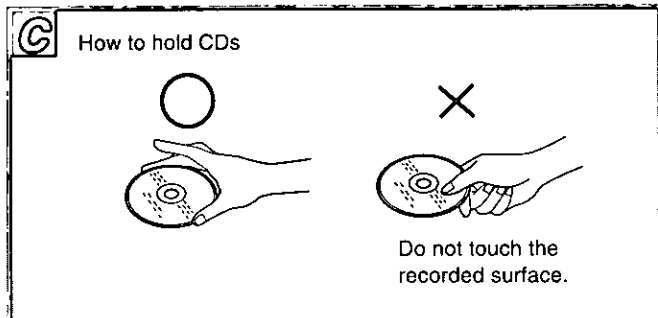
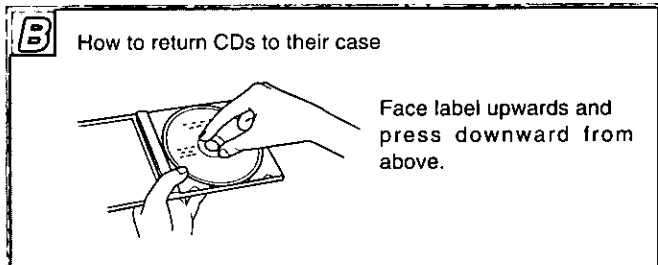

## Handling precautions **B - D**

- If you are taking the CD from a cold to a warm environment, moisture may form on the CD. Wipe this off with a soft, dry, lint-free cloth before using the CD.
- Do not write on the label side with a ball-point pen or other writing instrument.
- Do not use record cleaning sprays, benzene, thinner, static electricity prevention liquids or any other solvent.
- Do not attach labels or stickers to CDs. (Do not use CDs with exposed adhesive from tape or left over peeled off stickers.)
- Do not use scratch-proof protectors or covers other than those specified for use with this system.

## Storage precautions

Be sure to store CDs in their cases to protect them from dust, scratches, and warping.

### Do not place or store CDs in the following places

- Locations exposed to direct sunlight
- Humid or dusty locations
- Locations directly exposed to a heat vent or heating appliance
- In the glove compartment or on the rear deck of an automobile

## Maintenance

### To clean this unit, wipe with a soft, dry cloth.

If the surfaces are extremely dirty, use a soft cloth dipped in a soap-and-water solution or a weak detergent solution.

- Never use alcohol, paint thinner, or benzene to clean this unit.
- Before using chemically impregnated cloth, read the instructions that came with the cloth carefully.

## Product service

Do not attempt to remove the cover(s) or repair the unit yourself. Refer servicing to qualified personnel only.

## Product information

For product service, product information or assistance with product operation, refer to the servicenter directory.

## Troubleshooting guide

Before requesting service for this unit, check the chart below for a possible cause of the problem you are experiencing. Some simple checks or a minor adjustment on your part may eliminate the problem and restore proper operation.

If you are in doubt about some of the check points, or if the remedies indicated in the chart do not solve the problem, refer to the directory of Authorized Service Centers (enclosed with this unit) to locate a convenient service center, or consult your dealer for instructions.

**For detailed instructions, contact an authorized servicer in the U.S.A. and Panasonic Canada Inc. Customer Care Center in Canada.**

**In the U.S.A. 1-800-211-7262 or web site(<http://www.panasonic.com>)  
In Canada 905-624-5505 or web site([www.panasonic.ca/faq.html](http://www.panasonic.ca/faq.html))**

Problem	Probable cause(s)	Suggested remedy	Reference page(s)
After inserting a disc, the tray will not close even after pressing $\blacktriangle$ OPEN/CLOSE.	Is the disc inserted properly ?	Re-insert the disc.	7
Even after inserting a disc, the total number of tracks and other indicators do not appear on the display.  Even after pressing $\blacktriangleright$ , disc playback does not begin.	Is the disc inserted upside-down ?	Re-insert the disc.	7
	Is the disc dirty ?	Wipe with a soft cloth.	15
	Is the disc scratched ?	Use another disc.	/
	Is the disc extremely warped ?		
	Are you using a non-standard disc ?		
Has moisture condensed in the unit ?	Wait an hour before using.		
Specific areas do not play properly.	Is the disc dirty ?	Wipe with a soft cloth.	
The remote control does not work.	Are the batteries inserted with the $\oplus$ and $\ominus$ ends reversed ?	Insert with the $\oplus$ and $\ominus$ oriented correctly.	5
	Are the batteries worn out ?	Replace batteries.	5

## Technical specifications

### • Audio

No. of channels	2 (left and right, stereo)
Frequency response	2–20,000 Hz, $\pm 0.3$ dB
Output voltage	2 V (at 0 dB)
Dynamic range	100 dB
S/N	115 dB
Harmonic distortion	0.0018 % (1 kHz, 0 dB)
Total harmonic distortion	0.0023 % (1 kHz, 0 dB)
Wow and flutter	Below measurable limit
DA converter	MASH (1 bit)
Output impedance	Approximate 600 $\Omega$
Load impedance	More than 10 k $\Omega$
Headphone output level	15 mW max. 32 $\Omega$ (adjustable)

### • Pickup

Wavelength	780 nm
Laser Power	No hazardous radiation is emitted

### • General

Power supply	AC 120 V, 60 Hz
Power consumption	15 W
Dimensions (W X H X D)	430 X 114 X 290 mm (16 <sup>9</sup> / <sub>16</sub> " X 4 <sup>1</sup> / <sub>2</sub> " X 11 <sup>9</sup> / <sub>32</sub> " )
Weight	4.0 kg(8.8 lb)

### Note

Specifications are subject to change without notice.  
Weight and dimensions are approximate.

MASH is a trademark of NTT.

Panasonic Consumer Electronics  
Company, Division of Matsushita  
Electric Corporation of America  
One Panasonic Way Secaucus,  
New Jersey 07094  
<http://www.panasonic.com>

Panasonic Sales Company,  
Division of Matsushita Electric of  
Puerto Rico, Inc. ("PSC")  
Ave. 65 de Infanteria, Km. 9.5  
San Gabriel Industrial Park, Carolina,  
Puerto Rico 00985



RQT4532-P  
M0398X0



## Free Manuals Download Website

<http://myh66.com>

<http://usermanuals.us>

<http://www.somanuals.com>

<http://www.4manuals.cc>

<http://www.manual-lib.com>

<http://www.404manual.com>

<http://www.luxmanual.com>

<http://aubethermostatmanual.com>

Golf course search by state

<http://golfingnear.com>

Email search by domain

<http://emailbydomain.com>

Auto manuals search

<http://auto.somanuals.com>

TV manuals search

<http://tv.somanuals.com>