

Technika

EXCLUSIVELY FROM **TESCO**

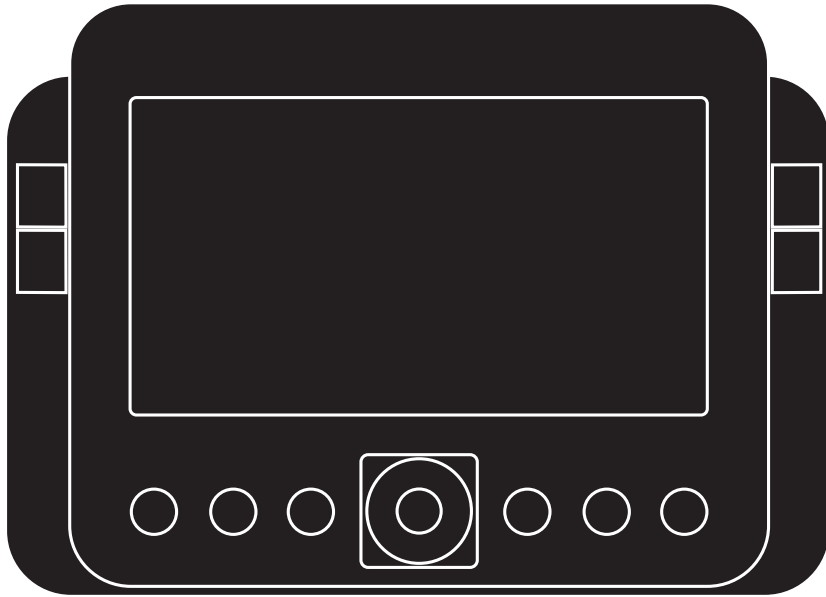

CR-114iPH

Owner's Handbook

Digital picture frame clock radio with iPod dock



IMPORTANT SAFETY INFORMATION

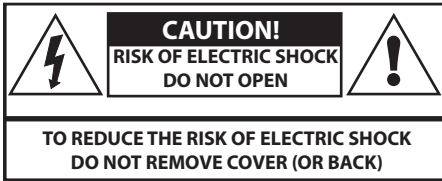

This symbol indicates that there are important operating and maintenance instructions in the literature accompanying this unit.



This symbol indicates that dangerous voltage constituting a risk of electric shock is present within this unit.

Read these instructions.

Keep these instructions.

Heed all warnings.

Follow all instructions.

Do not use this apparatus near water.

Clean only with a slightly damp cloth.

Do not block any ventilation openings.

Install in accordance with the manufacturer's instructions.

Do not install or operate near any heat sources such as radiators, stoves, or other apparatus that produce heat.

Unplug this apparatus during lightning storms or when unused for long periods of time.

Refer all servicing to qualified service personnel. Servicing is required when the apparatus has been damaged in any way, such as the power-supply cord or plug is damaged, liquid has been spilled or objects have fallen into the apparatus, the apparatus has been exposed to rain or moisture, does not operate normally, or has been dropped.

Warning: To reduce the risk of fire or electrical shock, do not expose this product to rain or moisture. The product must not be exposed to dripping and splashing and no object filled with liquids such as a vase of flowers should be placed on the product.

No naked flame sources such as candles should be placed on the product.

Caution: Changes or modifications not expressly approved by the manufacturer could void the user's authority to operate this device.

Caution: Usage of controls or adjustments or performance of procedures other than those specified herein may result in hazardous exposure.

IMPORTANT

This equipment generates, uses and can radiate radio frequency energy and, if not installed and used in accordance with the instructions, may cause harmful interference to radio communication. However, this is no guarantee that interference will not occur in a particular installation. If this equipment does cause harmful interference to radio or television reception, which can be determined by turning the equipment off and on, the user is encouraged to try to correct the interference by one of the following measures:

- Reorient or relocate the receiving antenna.
- Increase the separation between the equipment and receiver.
- Connect the equipment into an outlet on a circuit different from that to which the receiver is connected.
- Consult the dealer or an experienced radio/TV technician for help.

ELECTRICAL INFORMATION

Use this appliance only with the supplied AC Adaptor. Using non-approved power supplies will void the warranty.

Mains Supply: The mains operating voltage of the AC Adaptor is marked on a rating plate on the AC Adaptor.

The means of disconnecting this appliance from the mains supply is the AC adaptor. This should be unobstructed and readily operable at all times.

INDEX

INDEX

Important safety information	1
Introduction	2
Controls and Connectors	3
Getting Started, Adjusting the sound	5
Clock display and options	7
Loading USB Flash drives and memory cards	8
Viewing photos from USB drives and memory cards	9
Playing music from USB drives and memory cards	10
iPod adaptors	11
Docking an iPod/iPhone and playing music	12
Viewing photos stored on an iPod/iPhone	13
Watching videos stored on an iPod/iPhone	14
Listening to the radio	15
Radio options including presets	16
Using the alarms	17
System settings	18
Troubleshooting	19
Care & Maintenance	20
Specifications	20
Warranty	20

INTRODUCTION

The CR-114iPH is a versatile digital picture frame with a 7"/175mm display unit, built-in FM/AM radio and twin stereo speakers.

The media ports for flash card and USB drive enable photos slideshows or playback of music stored on these media.

The CR-114iPH also features a retractable iPod dock, enabling you to play music, photos and videos from a docked iPod.

PRELIMINARIES

UNPACKING

Carefully unpack the unit. If it is damaged, please return it to your nearest Tesco store for replacement. Remember to take your purchase receipt with you.

Retain the User Handbook. If you pass the unit on to a third party make sure you pass on the handbook.

We suggest you retain the packaging. If you dispose of it, do so having regard to any recycling regulations in your area.

CONTENTS

The carton should contain:

- The CR-114iPH clock radio
- AC adaptor
- AM loop aerial
- Operating Manual

If any items are missing or damaged, contact your nearest TESCO store for a replacement. Have your receipt ready when you call. Retain the packaging. If you dispose of it, do so having regard to any recycling regulations in your area.

LOCATION

Place the unit on dry stable surface away from heat and damp and where it is unlikely to fall or be knocked over.

CONTROLS AND CONNECTORS

FRONT VIEW

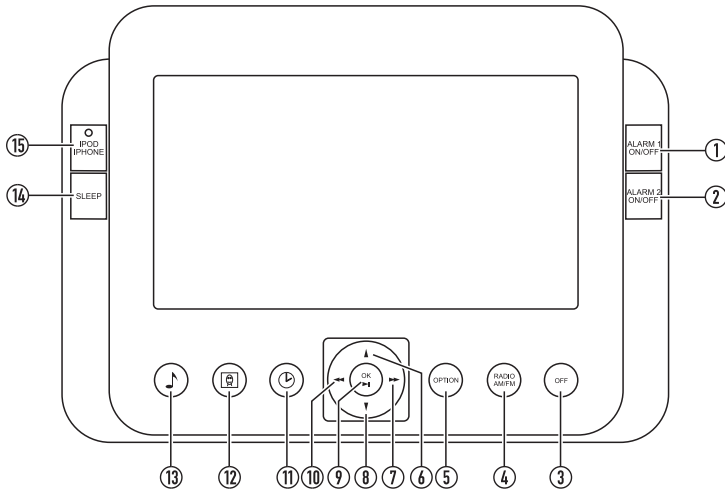

BACK VIEW

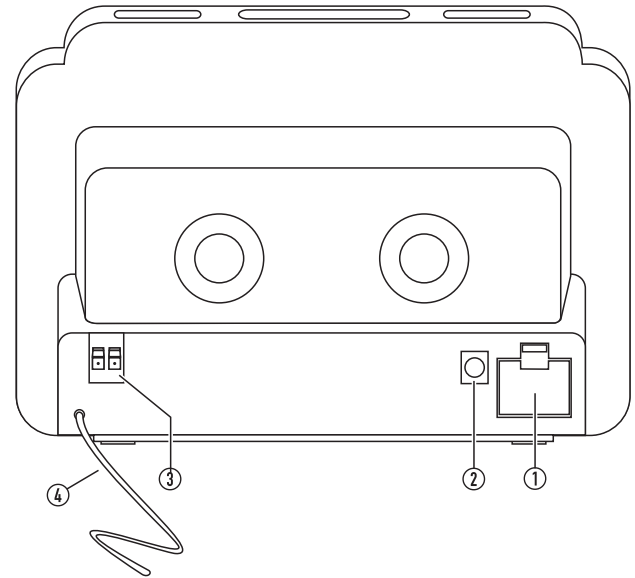

- | | |
|------------------------------------|-------------------------------|
| ① Alarm 1 on/off button | ⑨ Play/Pause/OK button |
| ② Alarm 2 on/off button | ⑩ Previous/Left cursor button |
| ③ Off button | ⑪ Clock function button |
| ④ Radio function/FM/AM band switch | ⑫ Photo function button |
| ⑤ Setting option button | ⑬ Music function button |
| ⑥ Up cursor button | ⑭ Sleep button |
| ⑦ Next/Right cursor button | ⑮ iPod function button |
| ⑧ Down cursor button | |

- | |
|------------------------------|
| ① Backup battery compartment |
| ② DC-In jack |
| ③ AM aerial connectors |
| ④ FM aerial wire |

CONTROLS AND CONNECTORS

TOP VIEW

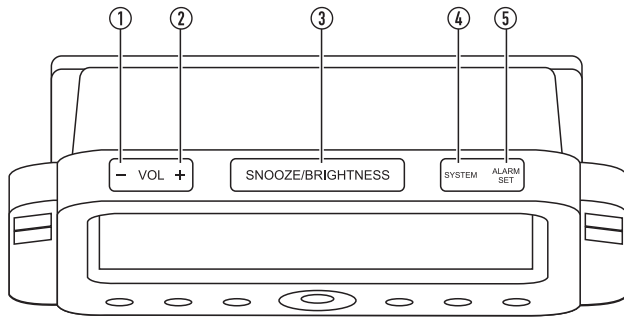

- ① Volume down button
- ② Volume up button
- ③ Snooze/Display dimmer button
- ④ System menu button
- ⑤ Alarm setting button

SIDE VIEWS

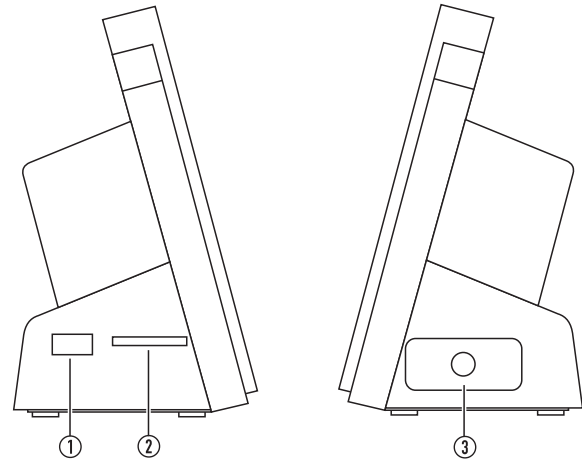

- ① USB jack
- ② SD Card jack
- ③ Retractable iPod dock

GETTING STARTED

FM RADIO AERIAL

Before using your unit for FM reception, unwrap and fully extend the aerial wire. You may need to adjust the position of the aerial wire for maximum signal strength.

AM RADIO LOOP AERIAL

If you plan to listen to AM radio stations, you will need to assemble and connect the AM loop aerial.

Assembling the AM aerial:

1. The aerial stand is located inside the loop aerial.
2. Fold the stand outside the loop.
3. Raise the loop to a vertical position and tuck the clips on the loop into the slots in the base.
4. When correctly assembled the loop aerial will stand as shown.



Connecting the AM aerial:

The bare wire ends from the AM aerial connect to the two terminals on the back panel marked AM ANTENNA.

- Place the AM aerial in a convenient location, standing on its base.
- Hold the latch down and insert one of the bare wire ends from the AM aerial into an AM ANTENNA terminal (polarity is not important).
- Release the latch to secure the wire.
- Connect the second aerial wire to the other terminal in the same way.

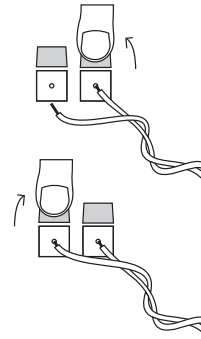

Placement of the AM aerial:

The AM aerial is very sensitive to position. If possible, position it away from electronic equipment and metal objects. It may be necessary to adjust or rotate the aerial for the best signal.

BACKUP BATTERIES

Backup batteries may be fitted to your photo frame. With backup batteries fitted, the unit will retain time and alarm settings.

The backup battery compartment is located on the back of the unit.

To fit a backup battery:

1. Referring to the drawing, locate the battery compartment and press the catch down to open the door.

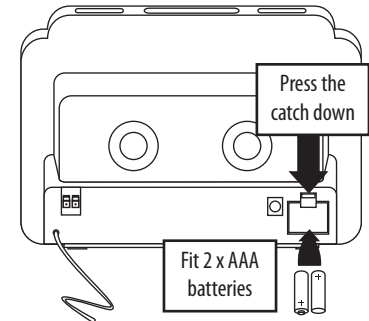

2. Lift out the battery cover.
3. Fit 2 x AAA batteries, observing polarity as shown.
4. Replace the battery cover.

Battery disposal:

Dispose of used batteries with regard to the recycling regulations in your area. Do NOT short circuit batteries or throw them into water, the general rubbish or in a fire.

Weak batteries can leak and damage the unit. Replace them in good time!

CONNECTING POWER

Check that the mains voltage on the rating plate of the AC adaptor is the same as the voltage in your area.

Plug the DC cord from the adaptor into the unit, plug the adaptor into the wall socket and switch the mains power on. The unit is now ready for use.

Unplug the AC adaptor if you are leaving the unit unattended for a long period of time, for example during holidays.

NOTE:- The AC adaptor may become warm during operation - this is normal.

FUNCTION SELECT AND POWER CONTROL

POWER CONTROL

The photo frame clock display is always switched on with a clock and dolphin 'wallpaper' display when power is connected.

The sound or slideshow function switches on when the iPod, Radio or a Flash media source is selected.

To select a function:

- Press one of the function buttons to switch a sound/slideshow function on.

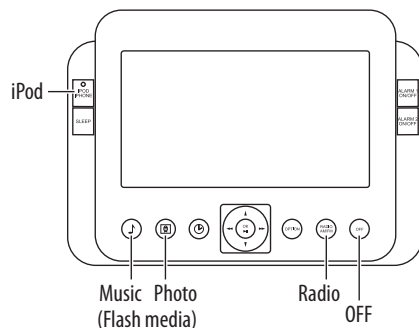

To turn the sound/slideshow functions off:

- Press the OFF button.
The clock will be displayed.

ADJUSTING THE SOUND

VOLUME CONTROL

To increase the volume:

- Press the **VOL+** button.

To decrease the volume:

- Press the **VOL-** button.

The volume bargraph will pop up to show the volume level you are setting

CLOCK DISPLAY

You can choose from three different formats for the clock display.

- Press the clock mode button  repeatedly to scroll through the available clock display modes -

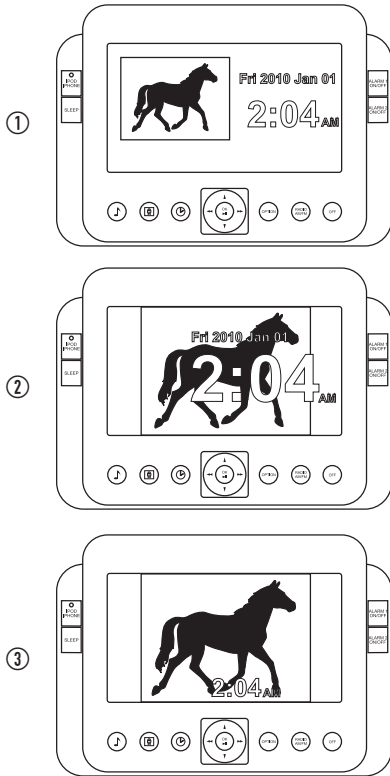

SETTING THE CLOCK

Setting the time and date:

Check that the Photo Frame is set to display the time in one of the clock display formats shown on the left. If not, press the clock mode button  to set the display to Clock mode.

- Press the **OPTION** button.

The Clock setting menu will be displayed. You can set the clock to a 12 hour or 24 hour display, set the current date and set the current time.

- Press the **▲** or **▼** button to select the item you want to change.
- Press the **OK ►||** button to highlight that item.
- Press the **▲** or **▼** button to change the item.
- If you need to change more than one item on a line, press the **►►** or **◄◄** button to select the next item to change.
- To save changes on a menu line, press the **OK ►||** button.
- Press the **▲** or **▼** button to move to another line if there are more settings to be made.

SLIDESHOW AND WALLPAPER

The clock setting menu also includes two settings for the clock background 'wallpaper'.

Wallpaper setting:

- Set the Wallpaper setting to 'Off' to show the dolphin pictures from the internal memory of the Photo frame as background 'wallpaper' for the clock display.
- Set the Wallpaper setting to 'On' if you want the Photo Frame to show a picture from a loaded USB drive or Memory card as the clock wallpaper. When you change this setting to 'On' you will see options to select USB drive or Memory card, then to choose the picture from your selected source.

NOTE: If the USB drive or Memory card that includes this picture is removed, the Wallpaper setting will revert to 'Off'.

Slideshow setting:

- Set the Slideshow setting to 'Off' to display a single picture from the Photo Frame's internal memory (or from a USB drive or Memory Card if Wallpaper is set 'On').
- Set the Slideshow setting to 'On' to display a slideshow of pictures from the Photo Frames internal memory (or from a USB drive or Memory Card if Wallpaper is set 'On').

DISPLAY DIMMER

The display brightness can be set to one of 3 levels.

- Press the **SNOOZE/BRIGHTNESS** button repeatedly to set the display brightness to one of the options of high, medium or low.

FLASH DRIVES AND CARDS

You can display digital photos or play music stored on USB Flash drives or Memory Cards up to a maximum size of 32GB.

USB media may include the following

- USB Flash drives.

Compatible Memory cards

- MMC cards
- SD cards
- MS cards

Compatible file formats

File formats that are compatible with your player are -

- JPG photo files
- MP3 or WMA music files

File organisation

You can mix music and photo files on the same drive, then play the music files as background music to a slideshow.

You can also choose to run a slideshow from a drive or card, whilst playing music from the other source, or a docked iPod.

Folders

Your photo frame is also compatible with photo and music files that are stored in folders. When you load a Drive or Card, all files are indexed to play, whether stored in the root directory or in folders.

CONNECTING USB DRIVES

To connect a USB flash drive:

Insert the drive into the USB jack on the left side panel.

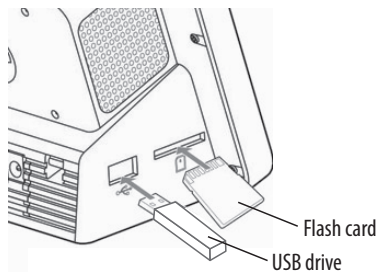

LOADING MEMORY CARDS

You can also load media saved to a Memory Card from your Digital Camera, Computer or other device. The unit is compatible with SD, MMC and MS Memory Cards.

To load a Flash Card:





- Gently insert the Memory Card into the Memory Card slot on the left side panel of the unit.

NOTE:- Memory Cards are polarised and can only be inserted one way round. If the Memory Card will not load easily you may need to reverse it. Never force a Memory Card into the Card Reader slot.

NOTE:- If you load both a USB flash drive and a Memory Card at the same time, you can choose which you want to use in the next section.

VIEWING PHOTOS STORED ON USB DRIVES OR MEMORY CARDS

VIEWING PHOTOS

- Load a USB Drive and/or Memory Card as described on the previous page.
- Press the  button to select Photo mode.
- Press the  or  button to choose the USB Drive or Memory Card where your pictures are stored.
- Press the **OK**  button to confirm your choice.

A thumbnail view of your photos will be displayed.

You can now choose to display one of the photos from the thumbnail view, or start a slideshow of all photos.





Starting a slideshow of all photos on the USB Drive or Memory Card:

- To start a slideshow of all the photos, press the **OK**  button.

The slideshow will begin, displaying each picture in turn.

Displaying one photo from the thumbnail display:

When the thumbnail view is displayed, the top left photo will be highlighted.

- Press the  or  and  or  buttons to move around the thumbnails.
- Press the **OK**  button to choose the highlighted photo.

A slideshow will start, beginning from this photo.

- If you want to pause the slideshow and display only this photo, press the **OK**  button.

SLIDESHOW CONTROL

When a slideshow is running.

To pause a slideshow:



- Press the  button.

The pause symbol will be displayed.

To re-start the slideshow:

- Press the  button again.



To skip to the next or previous photo in the slideshow:

- Pause the slideshow.
- Press the  or  button to skip to the next or previous photo.

SLIDESHOW SETTINGS

You can make changes via the Options Menu to customise your slideshows.

Opening the options menu:

- While photos are being displayed, press the **OPTION** button to open the Options Menu.
- Use the  or  buttons to navigate the menu options and the  button to select an option.

Choose slideshow options from this menu -

Rotate: You can choose to rotate the photo displayed.

Slideshow interval: You can select a time period between 5 seconds and 1 minute for each photo to be displayed.

Display mode: You can choose 'Fit to screen' to display photos in their original format or 'Full screen' to adjust the photo to fill the screen.

Wallpaper: Set Wallpaper 'On' to choose the current photo as background for your clock display.

Slideshow transition: You can select different options for slideshow transitions.

Background music: If you set background music 'On' for your slideshow, a sub-screen will be displayed where you can choose the source for your background music, then to a screen to choose the track you want to begin with.

NOTE: Press the **OPTION** button when the track display is showing to choose repeat or shuffle modes for the music.

Delete: This option enables you to delete the picture displayed from your USB drive or Memory Card.

Exit: Choose Exit to exit the Option Menu and return to photo display.

PLAYING MUSIC STORED ON USB DRIVES OR MEMORY CARDS

PLAYING MUSIC

- Load a USB Drive and/or Memory Card.
- Press the **♪** button to select Music mode.
- Press the **▶▶** or **◀◀** button to choose the USB Drive or Memory Card where your music files are stored.
- Press the **OK ▶||** button to confirm your choice.

A tracklist of the music on your USB Drive/Memory Card will be displayed.

- Press the **▲** or **▼** button to select the track you want to play.
 - Press the **OK ▶||** button to start the music playing.
- Your selected track will play, then the other tracks from your memory store will follow in sequence.*

PLAYBACK CONTROL

Play/Pause (Still for Movies):

- Press the **▶||** button to toggle between Play and Pause modes at any time.

Previous/Next Track selection:

- Press the **▶▶** or **◀◀** button to skip to the next or previous track.

Fast Search:

- Press and **hold** the **▶▶** or **◀◀** button to fast search forward or back through music tracks.

When you release the button, normal play will resume.

MUSIC PLAYBACK OPTIONS

You can select your choice of play modes from the Options Menu. You can open the Music Option Menu when the track selection screen is displayed.

Opening the options menu:

- Press the **♪** button to select Music mode.
- Press the **▶▶** or **◀◀** button to choose the USB Drive or Memory Card where your music files are stored.
- Press the **OK ▶||** button to confirm your choice.

The tracklist is displayed.

- At this point, press the **OPTION** button to open the Options Menu.
- Use the **▲** or **▼** buttons to navigate the menu options and the **▶||** button to select an option.

From the menu you can choose to change the following options -

Play mode: Selecting Play mode will open a sub-screen where you can select from -

- **Normal play:** (play all the tracks and stop),
- **Repeat one:** (Repeat the track selected),
- **Repeat all:** (Repeat all tracks on the Drive/Card) or
- **Shuffle:** (Play all tracks on the Drive/Card in a random order).

Delete: This option enables you to delete the track playing from your USB drive or Memory Card.

Exit: Choose Exit to exit the Option Menu and return to photo display.

RETRACTABLE iPod DOCK

This model features a retractable iPod/iPhone dock that is built-in to the right side of the unit.

To open the retractable dock:

- Press the surface of the retractable dock.

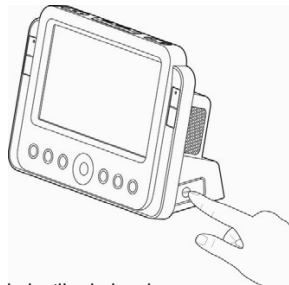

- The dock will unlock and pop open.
- Pull the dock out fully before docking your iPod.

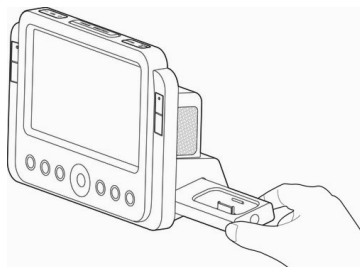

NOTE: Ensure that the open end of the dock is supported *before* docking your iPod.

To close the retractable dock:

- Remove your iPod (if it is docked).
- Press the retractable dock gently home.
- The catch will click and the dock will lock into place.

iPod ADAPTORS

Before docking your iPod you must first check if your iPod has a docking connector. Early iPod models do not have one and cannot be docked to your unit. The docking connector is located on the base of the iPod as shown below.

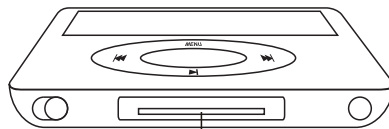

Docking Connector

Before docking your iPod, you must first fit the correct iPod adaptor to the docking bay. Each iPod adaptor matches the shape of a particular iPod and is necessary to ensure that your iPod is securely held when docked.

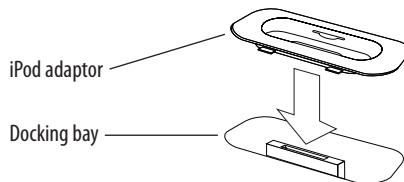

Fitting the iPod adaptor

When your iPod was new it may have been supplied with a standard dock adaptor in the packaging. If so, fit the adaptor by pressing it gently into the Docking Bay as shown above.

NOTE: Do not dock an iPod without fitting the correct adaptor, you may damage the iPod and your unit.

If you don't have a dock adaptor

If your iPod was not supplied with a standard dock adaptor, or if you have lost the adaptor, you can buy one from Apple on-line. To determine the exact model of your iPod, refer to this web-link - <http://support.apple.com/kb/HT1353>. You can then browse the iPod accessories page on the Apple website to find an adaptor for your iPod model that can be purchased on-line.

DOCKING AN iPod

DOCKING YOUR iPod

To dock your iPod:

- Check that the correct iPod adaptor is fitted to the docking bay.
- Locate the iPod on the Docking Connector and press it gently down onto the dock.

To remove your iPod:

- Grip the sides of the iPod and remove it gently from the dock.

CHARGING AN iPod

When an iPod is docked and the unit is switched on, the iPod will begin to charge automatically.

NOTE:- The iPod will continue charging if the unit is switched off (clock is displayed).

PLAYING MUSIC FROM AN iPod or iPhone

Playing music stored on an iPod (*all models except iPhone and iPod touch*):

- Dock the iPod.
- Press the **iPod/iPhone** button.

You can now choose to play music or view photos/videos from your iPod.

- Press the ►► or ◀◀ button to highlight the Music option.
- Press the **OK ►||** button to confirm your choice.
- The display will switch to show the iPod music information screen.
- After a short delay, the screen will revert to the clock display, with a music information banner at the top of the screen.

Playback control:

When the iPod is playing, the following playback functions are available from the control panel of your Photo Frame -

- Press the ►|| button to switch between Play and Pause mode at any time.
- When playing, press the ►► or ◀◀ button to select the next or previous track.
- When playing a music track, press and **hold** the ►► or ◀◀ button to fast search forward or back. Release the button to return to normal play.

Menu navigation:

To navigate playlists and other music selection features of your iPod, use the iPod controls.

Playing music stored on an iPhone or iPod touch:

NOTE: iPhone in this section refers to iPhone and iPod touch.

- Switch off the unit.

The clock is displayed.

- Dock the iPhone.

The iPhone will switch on.

- Slide the bar on the screen and unlock your iPhone.
- Press the **iPod/iPhone** button.
- Press the ►► or ◀◀ button to highlight the Music option.
- Press the **OK ►||** button to confirm your choice.
- The display will switch to show the iPod music information screen.
- After a short delay, the screen will revert to the clock display, with a music information banner at the top of the screen.

Playback control:

When the iPhone is playing, the following playback functions are available from the control panel of your Photo Frame -

- Press the ►|| button to switch between Play and Pause mode at any time.
- When playing, press the ►► or ◀◀ button to select the next or previous track.
- When playing a music track, press and **hold** the ►► or ◀◀ button to fast forward or back. Release the button to return to normal play.

Menu navigation:

To navigate playlists and other music selection features of your iPhone, use the iPhone controls.

VIEWING PHOTOS STORED ON AN iPod OR iPhone

Photos stored on a docked iPod can also be displayed if the iPod is a model equipped with TV out.

Viewing photos stored on an iPod (*all models except iPhone and iPod touch*):

- Dock the iPod.
 - Press the **iPod/iPhone** button.
- You can now choose to play music or view photos/videos from your iPod.*
- Press the ►► or ◀◀ button to highlight the Photo/Video option.
 - Press the **OK ►||** button to confirm your choice.

The following message will be displayed - iPod/iPhone cannot play video and photo automatically. Please manually start playing video or photo from the iPod/iPhone unit.

- Using the controls on the iPod, navigate to the main menu.
- Select the 'Photos' option.
- Use the centre button and clickwheel on the iPod to navigate to a thumbnail view of the photo album you want to display.
- Use the clickwheel to browse the thumbnails and find the picture you want to display.
- Press the centre button on the iPod to display this picture full-screen on the iPod.
- Press the centre button again.

The iPod will count down, then begin a slide-show of your pictures on the display.

IMPORTANT NOTE:- Photos can only be viewed from an iPod model that is equipped with TV OUT. Some iPod models can store photos, but do not feature TV OUT. Check with Apple if you are in any doubt that your iPod is equipped with TV OUT.

Viewing photos stored on an iPhone or iPod touch:

NOTE: iPhone in this section refers to iPhone and iPod touch.

- Switch off the unit.
- The clock is displayed.*
- Dock the iPhone.
- The iPhone will switch on.*
- Slide the bar on the screen and unlock your iPhone.
 - Press the **iPod/iPhone** button.
 - Press the ►► or ◀◀ button to highlight the Photo/Video option.

The following message will be displayed - iPod/iPhone cannot play video and photo automatically. Please manually start playing video or photo from the iPod/iPhone unit.

- Press the Home button on the iPhone.
 - Touch the 'Photos' application on the iPhone to enter the Photos menu.
 - Touch the photo album you wish to display.
- The photo album will open on the iPhone screen.*
- Touch the ► symbol at the bottom of the iPhone screen.

The photos will be displayed on your Photo Frame screen in a Slideshow.

VIEWING VIDEOS STORED ON AN iPod OR iPhone

Videos stored on a docked iPod can be displayed if the iPod is a model equipped with TV out.

Viewing videos stored on an iPod (*all models except iPhone and iPod touch*):

- Dock the iPod.
- Press the **iPod/iPhone** button.

You can now choose to play music or view photos/videos from your iPod.

- Press the ►► or ◀◀ button to highlight the Photo/Video option.
- Press the **OK ►||** button to confirm your choice.

The following message will be displayed -

iPod/iPhone cannot play video and photo automatically. Please manually start playing video or photo from the iPod/iPhone unit.

- Using the controls on the iPod, navigate to the main menu.
- Select the 'Videos' option.
- Use the centre button and clickwheel on the iPod to navigate to the video you want to watch.

The video will start to play on the Photo Frame screen.

Playback control:

When the iPod is playing, use the controls on the iPod to control playback of the video.

Viewing videos stored on an iPhone or iPod touch:

NOTE: iPhone in this section refers to iPhone and iPod touch.

- Switch off the unit.

The clock is displayed.

- Dock the iPhone.

The iPhone will switch on.

- Slide the bar on the screen and unlock your iPhone.
- Press the **iPod/iPhone** button.
- Press the ►► or ◀◀ button to highlight the Photo/Video option.

The following message will be displayed -

iPod/iPhone cannot play video and photo automatically. Please manually start playing video or photo from the iPod/iPhone unit.

- Press the Home button on the iPhone.
- Touch the 'iPod' application on the iPhone to enter the iPod menu.
- Select the video library on the iPhone screen.

The videos available will be listed.

- Touch the video you want to play in the list.

The video will begin to play on the Photo Frame screen.

Playback control:

When the iPhone is playing, use the controls on the iPhone to control playback of the video.

LISTENING TO THE RADIO

To listen to the radio:

- Press the **RADIO** button to select radio operation.

The radio tuning screen will be displayed.

To change from FM band to AM band:

- After selecting Radio mode, press the **RADIO** button repeatedly to switch between FM and AM bands.

The tuning display will show the selected band.

Scanning for a station:

- Press and **hold** the **▶▶** or **◀◀** button to scan up or down the band.

When the next station is reached, scanning will stop and the station frequency will be displayed.

If reception quality is poor, try adjusting the position of the aerial wire (FM) or loop aerial (AM) for the best sound.

Manual tuning:

- Press the **▶▶** or **◀◀** button on the front panel **briefly** to tune manually.

Browsing the preset stations:

- Press the **▲** or **▼** button to step through the preset stations.

The preset number will change, the radio will re-tune and the frequency of the preset selected will be displayed.

NOTE: Refer to the Radio Options section on the next page for details of storing preset stations.

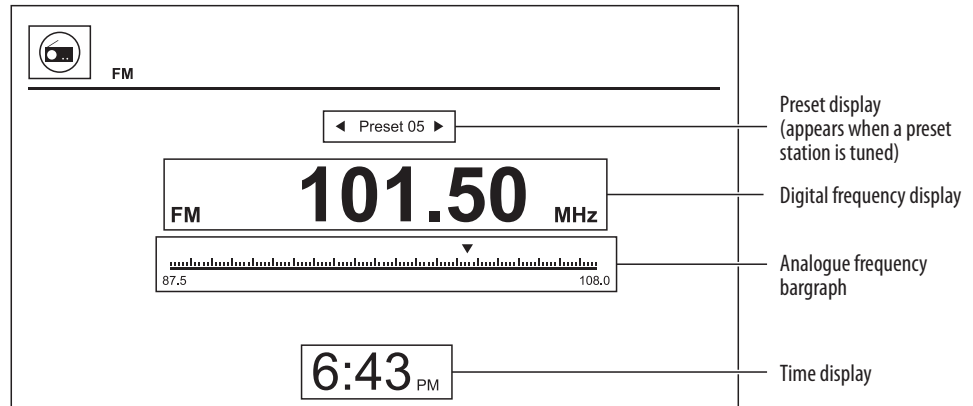

RADIO OPTIONS INCLUDING PRESETS

RADIO OPTIONS:

The Radio Options menu enables you to store, recall or delete presets, also to change FM and AM tuning settings.

Opening the options menu:

- While the radio tuning screen is displayed, press the **OPTION** button to open the Options Menu.

NOTE: If the radio tuning screen is not displayed, press the **RADIO** button, then the **OPTION** button.

- Use the the **▲** or **▼** buttons to navigate the menu options and the **▶||** button to select an option.

Saving a preset station:

You can store up to 20 of your favourite FM, and 10 AM stations as presets.

- Tune to the band and station you want to store.
- Open the Options Menu and choose the 'Add to preset' option.

The preset list will be displayed.

- Press the **▲** or **▼** button to highlight the preset number you want to store.
- Press the **OK** button to store the station.

Tuning to a preset station:

- Open the Options Menu and choose the 'Load preset' option.

The preset list will be displayed.

- Press the **▲** or **▼** button to highlight the preset number you want to tune to.
- Press the **OK** button to tune to the station.

The radio will retune to the preset station selected.

Deleting a preset station:

- Open the Options Menu and choose the 'Delete one' option.

The preset list will be displayed.

- Press the **▲** or **▼** button to highlight the preset number you want to delete.
- Press the **OK** button to delete this station from the preset list.

Deleting all preset stations:

CAUTION: Choosing this option will delete all stored preset stations.

- Open the Options Menu and choose the 'Delete all' option.

All preset stations will be deleted.

FM step setting:

The FM step setting sets the frequency spacing of each tuning step for the FM band. In the UK and Europe this setting should be 50kHz.

- Check that the FM band is selected.
- Open the Options Menu and choose the 'FM step' option.
- Press the **▲** or **▼** button to highlight the 50kHz option.
- Press the **OK** button to store the station.

AM step setting:

The AM step setting sets the frequency spacing of each tuning step for the AM band. In the UK and Europe this setting should be 9kHz.

- Check that the AM band is selected.
- Open the Options Menu and choose the 'AM step' option.
- Press the **▲** or **▼** button to highlight the 9kHz option.
- Press the **OK** button to store the station.

NOTE: If the AM and FM step settings are not correct, some stations may not be found when tuning.

USING THE ALARMS

Your clock radio has two alarms (Alarm 1 and Alarm 2). You can set either or both alarms to wake you at your preferred time and choose to wake up to the sound of a buzzer, radio, music from a USB drive/Memory card or music from an iPod.

Setting the alarm times:

- Switch the unit off.
- Press the **ALARM SET** button.

Alarm 1 and Alarm 2 indicators will be displayed.

- Press the **▶▶** or **◀◀** button to highlight the alarm you want to set.
- Press the **OK ▶▶** button to confirm this choice.

The alarm setting screen will appear for the alarm you selected.

You can now set the alarm time, volume, repeat and wake-up mode. You can also set your preferred time for the Snooze function.

- Press the **▲** or **▼** button to select the item you want to change.
- Press the **OK ▶▶** button to highlight that item.
- Press the **▲** or **▼** button to change the item.
- If you need to change more than one item on a line, press the **▶▶** or **◀◀** button to select the next item to change.
- To save changes on a menu line, press the **OK ▶▶** button.

*When you have finished setting this alarm, press the **ALARM SET** button to set the other alarm or press the **☺** button to return to the clock display.*

Setting the alarms to wake you:

You can set either or both alarms to wake you.

- Press the **ALARM 1** button to set Alarm 1 to wake you.

The Alarm 1 banner will appear on the display screen when the alarm is set.

- Press the **ALARM 2** button to set Alarm 2 to wake you.

The Alarm 2 banner will appear on the display screen when the alarm is set.

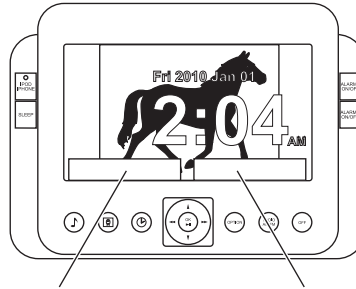

Alarm 1 banner

Alarm 2 banner

IMPORTANT NOTES:

- If you have chosen radio as wake-up mode, remember to tune to a station.
- If you have chosen to play music from a USB drive or Memory card, check that this is loaded before going to bed.
- If you have chosen iPod as wake-up mode, remember to dock your iPod, set to play music (not photos etc).

If the music source (iPod etc) is not found when the alarm sounds, the unit will automatically wake you with a buzzer.

WHEN THE ALARM WAKES YOU

The alarm will sound at your preset time and the Alarm banner will flash. You can then choose to set snooze, which will temporarily reset the alarm for a further period, or to switch it off.

NOTE: The duration of the Snooze period may be set when setting the alarm times.

To set snooze:

- To set snooze, press the **SNOOZE/DIMMER** button when the alarm sounds.

The alarm will stop sounding and the alarm indicator will flash. After the snooze delay, the alarm will sound again.

To switch off the alarm:

- To switch off the alarm, press the **OFF** button.

The alarm will stop sounding.

ALARM REPEAT

The alarm(s) will sound at the same time each day when set.

BACKUP BATTERIES

Fitting backup batteries are highly recommended. When backup batteries are fitted, clock and alarm settings will be retained during a power cut. If the power cut persists through the alarm time, a backup alarm buzzer, powered by the backup batteries will sound at a low level when the alarm time is reached.

SYSTEM SETTINGS

Opening the System Settings menu:

- Press the **SYSTEM** button to open the System settings Menu.

The System Settings menu will open.

- Use the the ▲ or ▼ buttons to navigate the menu options and the ►|| button to select an option.

From the menu you can choose to change the following options -

Language:

Change the language for the menus and display screens.

Reset:

Choosing this option will restore all user setting to 'factory original'. If you choose the reset option a box will open requesting your confirmation before reset takes place.

NOTE:- Any stored radio presets will also be erased.

Version:

This item is non-selectable. The software version installed in your unit is displayed. You may be asked for this information if you need to call for service of your product at any time.

TROUBLESHOOTING

FLASH CARD/DRIVE OPERATION

Unable to view photos

Not all JPEG files are compatible. If JPEG files will not play, try viewing them with a computer. If you can view them with a computer, try re-saving them.

Photo viewing is slow

The photo resolution may be too high. Try re-saving the images with lower resolution.

Unable to play music files (or music files not visible when browsing media)

The format of the files may not be compatible with the player. Try re-saving your music files in a different format (MP3 recommended).

Unable to view Movies

Not all MPEG4 (*.avi) files are compatible. If files will not play, try playing them with a computer. If you can play them with a computer, try re-saving them in a different format.

Flash card is incompatible

If the card is an MS Duo, MSDuo Pro, MS M2 or MS PRO-HG Flash Card, a Memory Stick Duo replacement Adaptor or Memory Stick Micro Adaptor (not supplied) will be required.

iPod OPERATION

No sound when playing music:

Check if the iPod is paused. If so, press the ►|| button to start play.

Movie files stored on an iPod are not playing:

The movie files may not be compatible with your iPod. Check that the movie plays on your iPod before docking it to the unit.

A photo is displayed on the iPod screen, but not on the photo frame screen:

Press the centre button on the iPod to start the slideshow and switch the iPod photo display to your photo frame.

Photos are displayed on the iPod screen, but not on the photo frame screen:

Your iPod may be a model that does not support TV OUT. Check the specification of your iPod.

RADIO OPERATION

Poor quality radio reception

The aerial signal may not be adequate. Try repositioning the FM aerial wire and AM aerial or moving the unit to a different location.

AM radio stations not tuning

Check that the AM aerial is connected correctly to the terminals on the back panel.

Check that the AM channel spacing is set correctly in the radio 'options' menu. The correct setting for the UK and Europe is 9kHz.

ALARM OPERATION

Alarm not sounding

Check that you have set the correct alarm time, and set the alarm to wake you (wake-up mode symbol(s) will be displayed).

Check that the Time Display Format is set correctly (12H/24H).

Check also that the unit is set to Standby before you go to bed.

Alarm not sounding (iPod wake-up mode)

Check that the iPod is set to play music before going to bed. If the iPod is set to play photos, the alarm will not sound.

Alarm sound not audible or too loud:

Make sure that the alarm volume is set to the correct level (the alarm volume is set when you set the alarm time).

GENERAL

Controls lock up

Your photo frame is a complex electronic product and there may be occasions when playback of certain media combinations could cause the control system to 'lock'. In this case, turn off the power, remove the backup batteries (when fitted) and wait for 5 seconds.

Re-fit the backup batteries and turn the unit back on again.

This will reset the control system of the player.

CARE AND MAINTENANCE

AFTER USING THE PLAYER

- Set the unit to Standby.
- Remove any loaded media.
- Switch the unit off at the mains and unplug it for greater safety.

CARE AND CLEANING

Care and cleaning operations should be carried out with the unit unplugged from the mains.

Clean the plastic parts with a barely damp cloth and then dry carefully.

Do NOT touch the screen with bare fingers, hard or pointed objects. Clean the screen carefully with a special cloth, such as a Calotherm cloth available from chemists and opticians.

SPECIFICATIONS

SPECIFICATIONS

Supply Voltage, Current :. 6V ---, 3A

AC Adaptor input:..... 100-240V~, 50/60Hz, 0.5A max.

File formats from iPod

Audio files: All formats compatible with iPod

Video files: All formats compatible with iPod

Photo files: All formats compatible with iPod

File formats from Flash Media

Audio files: MP3/WMA

Video files: MPEG-4 *.avi.

Photo files: JPEG

Flash media capacity..... 32GB max.

Net Weight: 0.75kg



Class II construction double insulated.

This product must not be connected to earth.



WARRANTY

Your Tesco appliance is covered by a warranty for 12 months from the date of purchase. If a fault develops during this period, please contact the TESCO electrical help line on 0845 456 6767. Please have your original purchase receipt with you when you call. This warranty in no way affects your consumer rights.



UK: Waste electrical products /batteries should not be disposed of with household waste. Separate disposal facilities exist, for your nearest facilities.

See www.recycle-more.co.uk or in-store for details.

ROI: Produced after 13th August 2005. Waste electrical products/batteries should not be disposed of with household waste. Please recycle where facilities exist. Check with your Local Authority or retailer for recycling advice.

Technika

Tesco Stores Ltd,
Delamare Road, Cheshunt, Herts, EN8 9SL

► **Technika Helpline: 0845 456 6767** (Calls cost up to 4p per minute from a BT landline, other providers may vary)

CR114iPHV0.1

Free Manuals Download Website

<http://myh66.com>

<http://usermanuals.us>

<http://www.somanuals.com>

<http://www.4manuals.cc>

<http://www.manual-lib.com>

<http://www.404manual.com>

<http://www.luxmanual.com>

<http://aubethermostatmanual.com>

Golf course search by state

<http://golfingnear.com>

Email search by domain

<http://emailbydomain.com>

Auto manuals search

<http://auto.somanuals.com>

TV manuals search

<http://tv.somanuals.com>