

Technika

EXCLUSIVELY FROM **TESCO**

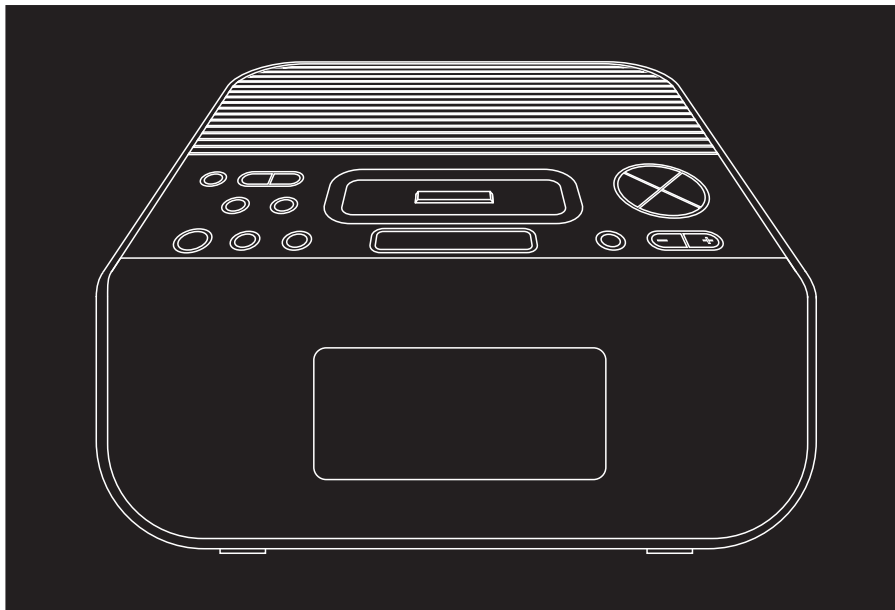

CR121DAB

Owner's Handbook

Clock radio with dock for iPod





IMPORTANT SAFETY INFORMATION



This symbol indicates that there are important operating and maintenance instructions in the literature accompanying this unit.



This symbol indicates that dangerous voltage constituting a risk of electric shock is present within this unit.

Read these instructions.

Keep these instructions.

Heed all warnings.

Follow all instructions.

Do not use this apparatus near water.

Clean only with a slightly damp cloth.

Do not block any ventilation openings.

Install in accordance with the manufacturer's instructions.

Do not install or operate near any heat sources such as radiators, stoves, or other apparatus that produce heat.

Unplug this apparatus during lightning storms or when unused for long periods of time.

Refer all servicing to qualified service personnel. Servicing is required when the apparatus has been damaged in any way, such as the power-supply cord or plug is damaged, liquid has been spilled or objects have fallen into the apparatus, the apparatus has been exposed to rain or moisture, does not operate normally, or has been dropped.

Warning: To reduce the risk of fire or electrical shock, do not expose this product to rain or moisture. The product must not be exposed to dripping and splashing and no object filled with liquids such as a vase of flowers should be placed on the product. No naked flame sources such as candles should be placed on the product.

Caution: Changes or modifications not expressly approved by the manufacturer could void the user's authority to operate this device.

Caution: Usage of controls or adjustments or performance of procedures other than those specified herein may result in hazardous exposure.

IMPORTANT

This equipment generates, uses and can radiate radio frequency energy and, if not installed and used in accordance with the instructions, may cause harmful interference to radio communication. However, this is no guarantee that interference will not occur in a particular installation. If this equipment does cause harmful interference to radio or television reception, which can be determined by turning the equipment

off and on, the user is encouraged to try to correct the interference by one of the following measures:

- Reorient or relocate the receiving antenna.
- Increase the separation between the equipment and receiver.
- Connect the equipment into an outlet on a circuit different from that to which the receiver is connected.
- Consult the dealer or an experienced radio/TV technician for help.

ELECTRICAL INFORMATION

Mains Supply: The mains operating voltage is marked on a rating plate on the underside of the case.

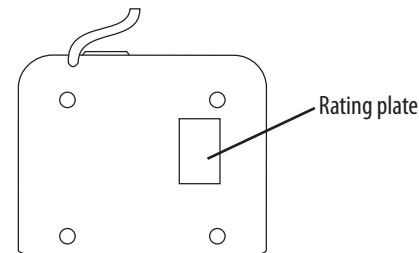

Before connecting the power, check that the mains voltage on the rating plate is the same as the voltage in your area.

The means of disconnecting this appliance from the mains supply is the mains plug. This should be unobstructed and readily operable at all times.



INDEX

INDEX

Important safety information.....	1
Introduction	2
Unpacking	2
Controls & Connections.....	3
Getting started	5
Setting the clock.....	5
Adjusting the volume	5
DAB Scanning	6
DAB Display modes.....	6
Selecting a source.....	7
FM reception.....	7
Radio presets.....	7
Docking or connecting an iPod	8
Playing an iPod.....	9
Using the alarms.....	10
Advanced operation.....	11
Sleep function	12
Troubleshooting	12
Care & Maintenance.....	12
Specifications	12
Warranty	12

INTRODUCTION

The CR121DAB is a full-function DAB clock radio with dual alarms and a dock for an iPod.

The CR121DAB also features a large-format backlit display for easy night reading.

PRELIMINARIES

UNPACKING

Carefully unpack the unit. If it is damaged, please return it to your nearest Tesco store for replacement. Remember to take your purchase receipt with you.

Retain the User Handbook. If you pass the unit on to a third party make sure you pass on the handbook.

We suggest you retain the packaging. If you dispose of it, do so having regard to any recycling regulations in your area.

CONTENTS

The carton should contain:

- The CR121DAB clock radio
- Operating Manual

If any items are missing or damaged, contact your nearest TESCO store for a replacement. Have your receipt ready when you call. Retain the packaging. If you dispose of it, do so having regard to any recycling regulations in your area.

LOCATION

Place the unit on dry stable surface away from heat and damp and where it is unlikely to fall or be knocked over.



CONTROLS AND CONNECTIONS

TOP VIEW

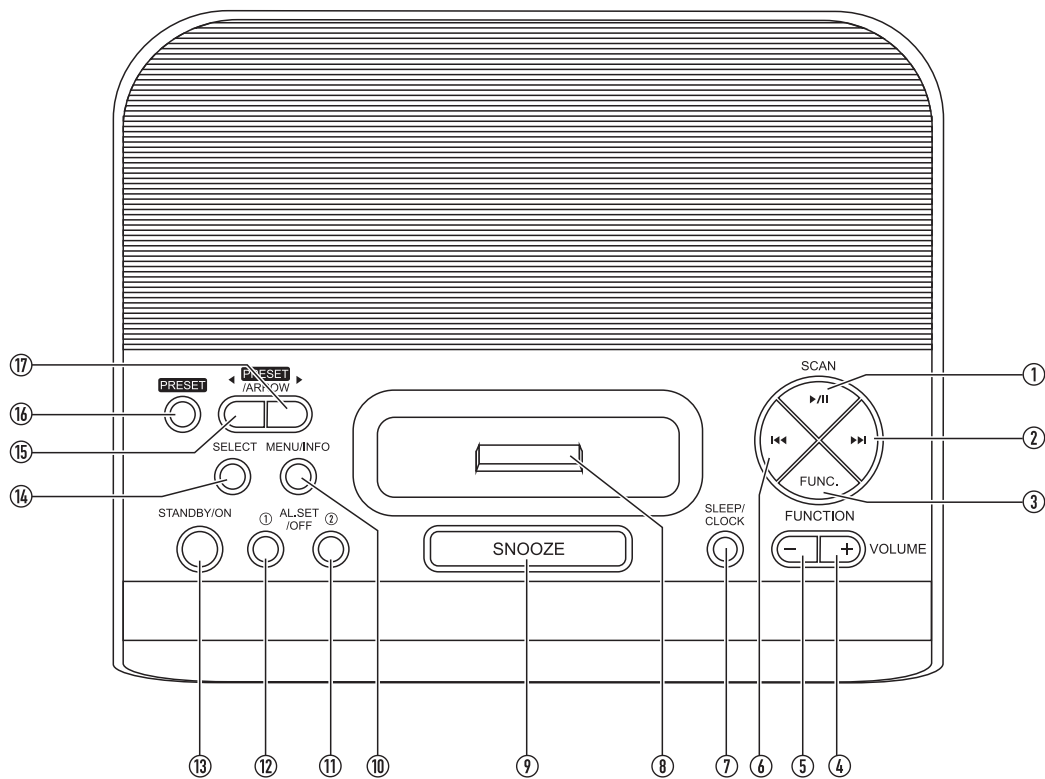

- ① Play/Pause/Scan button
- ② Next button
- ③ Function button
- ④ Volume up button
- ⑤ Volume down button
- ⑥ Previous button
- ⑦ Sleep/Clock button
- ⑧ iPod dock connector
- ⑨ Snooze/dimmer button
- ⑩ Menu/Info button
- ⑪ Alarm 2 button
- ⑫ Alarm 1 button
- ⑬ Standby/On button
- ⑭ Select button
- ⑮ Preset/Arrow down button
- ⑯ Preset mode button
- ⑰ Preset/Arrow up button

CONTROLS AND CONNECTIONS

FRONT VIEW

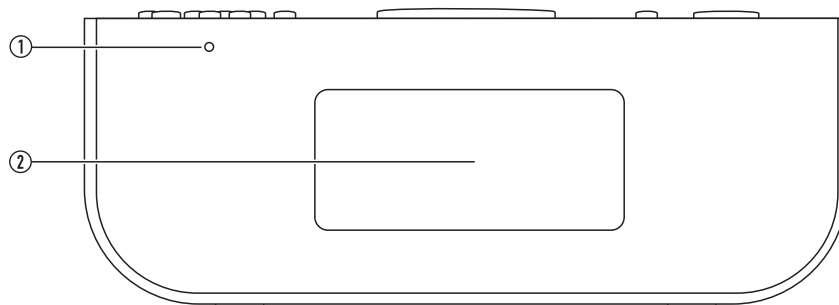

BACK VIEW

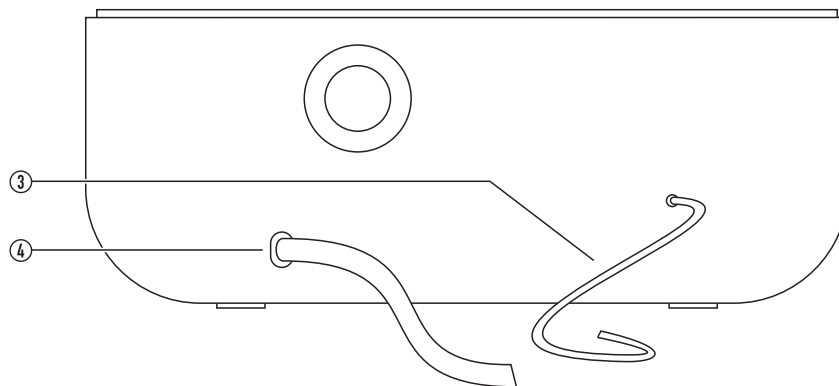

- ① Standby indicator
- ② Display
- ③ DAB/FM aerial
- ④ Mains lead

GETTING STARTED

DAB/FM AERIAL

Before using your radio for DAB or FM reception, unwrap and fully extend the aerial wire. You may need to adjust the position of the aerial wire for maximum signal strength.

CONNECTING POWER

Before connecting the power, check that the mains voltage on the rating plate is the same as the voltage in your area.

- Plug the mains plug into the wall socket and switch the mains power on.

The unit is now ready for use.

When first connected to the power, the clock display will show 'zeros'.

SETTING THE CLOCK

The clock on your radio is automatically set within the first few minutes of playing a DAB radio station for the first time.

If a DAB station is not available, the clock may be set manually.

To set the clock manually:

- Set the radio to Standby.
- Press the SLEEP/CLOCK button.

'Clock Time Set' will be displayed and the date (in the format YYYY-MM-DD) and time will be displayed. The year digits will flash.

- Press the PRESET/ARROW ► or ◀ button to set the year.
- Press the SELECT button to save this setting.

The month digits will flash.

- Repeat the previous two steps until you have set the date and time correctly.

POWER CONTROL

STANDBY CONTROL

To turn the radio on:

- Press the STANDBY/ON button.

The Standby indicator will switch off, the display will brighten and the radio will switch on.

To set the radio to standby:

- Press the STANDBY/ON button.

The display will dim, the radio will switch off and the Standby indicator will light. The clock will continue to run whilst mains power is connected.

INITIAL SCAN

When your radio is switched on for the first time the scanning display will be shown while the scanning process takes place:

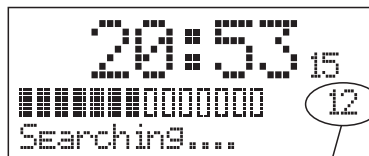

Number of stations found

The radio scans all usable stations (full scan) and stores them alphanumerically - 1 Radio, 2 Radio, AA Radio, AB Radio... The initial scan will take a few minutes. After the scan, the clock will be set and the radio will play the first station in the sequence.

BROWSING FOR A STATION

To browse for another DAB station

- Press the ►► or ◀◀ button repeatedly to browse through the station list.
- Stop browsing when you find the station name you want.

After a short delay, the radio will tune to the station. The display will show the station details.

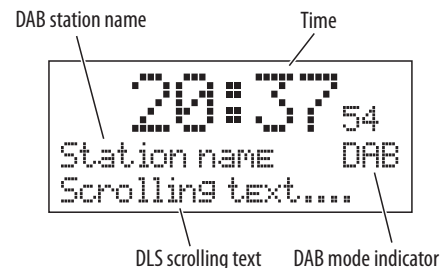

ADJUSTING THE VOLUME

To increase the volume:

- Press the VOLUME + button.

To decrease the volume:

- Press the VOLUME - button.

When the volume is adjusted the display will change to show the current volume setting on a bargraph.

DISPLAY DIMMER

The display brightness can be switched in steps from high to low settings by pressing the SNOOZE button on the top panel or remote control.

DAB SCANNING

RE-SCANNING FOR DAB STATIONS

When first used, your radio scanned the DAB band for available stations. The station services found were then stored in your system's memory.

You can re-scan the band at any time if you move to a different area or just to refresh the stored list of available stations.

There are two types of scan - Quick scan and Full scan. A Quick scan will scan the UK DAB channels, a Full scan will scan all channels in the tuning range of the radio.

To quick scan for DAB stations:

- Select the DAB band.
- Press the ►II/SCAN button briefly.

To Full scan for DAB stations:

- Select the DAB band.
- Press and hold the ►II/SCAN button.

The scanning process will take a few minutes. The number of services found during the scan will be shown at the right side of the display.

After the scan, the clock will be set and the radio will play the first station in the sequence.

DAB DISPLAY MODES

DISPLAY MODE OPTIONS

The bottom line of the display can be switched to show different items of information that may be transmitted with a DAB station.

Choosing the information display:

Press the MENU/INFO button repeatedly to change the information displayed while playing a DAB radio station.

The full range of display options are shown below. Some stations may not broadcast all of these options.

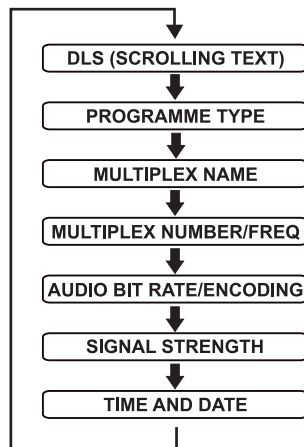

DLS (Dynamic Label Segment): This is a scrolling message giving real-time information - song titles, news headlines, etc.

PROGRAMME TYPE: This describes the style of the programme being broadcast.

MULTIPLEX NAME: DAB Digital radio stations are broadcast in multiplexes. Each multiplex is a bundle of radio stations transmitted in a single frequency. There are national and local multiplexes; local ones contain stations specific to your area. This option displays the name of the multiplex name that contains the station you are listening to.

MULTIPLEX NUMBER/FREQ: This option will display the multiplex number and frequency that contains the station you are listening to.

BIT RATE: DAB allows broadcasters to vary the BIT RATE (or the amount by which an audio signal can be compressed) depending on the type of broadcast. This enables the amount of stations on a multiplex to be maximised. Speech and News are often broadcast at a lower Bit Rate; music needs a higher Bit Rate for good fidelity.

SIGNAL STRENGTH: This setting will display a signal strength bargraph. The longer the bargraph, the stronger the signal. Setting the display to show signal strength is useful when setting up the aerial for the strongest signal.

TIME AND DATE: Time and date are updated by broadcasted information.

SELECTING A SOURCE

SOUND SOURCES

You can choose to listen to the following sources -

- DAB radio
- FM radio
- iPod (when docked)

Selecting a source:

- Press the **FUNCTION** button repeatedly to scroll through the available sources.

LISTENING TO FM RADIO

Your radio can also receive FM band radio stations and display RDS data (where broadcast).

To change to the FM band

- Press the **FUNCTION** button repeatedly to select FM mode.

To auto-tune up the band to the next FM station

- Press the **►II/SCAN** button **briefly** to search up the band for the next station.
- Press and **hold** the **►II/SCAN** button to search down the band for the previous station.

The radio will search the band and the tuning frequency will be displayed whilst searching.

When a usable station is detected the radio will stop tuning and play the station. If RDS data is present, the station name and scrolling radio text will be displayed. If RDS data is not present, <Radio Text> will be displayed.

To manually tune to FM stations

- Press the **►►** or **◄◄** button to tune up or down the band in 50kHz steps.

STEREO/MONO RECEPTION

Your radio will switch automatically between stereo and mono FM reception.

STATION PRESETS

DAB and FM presets

Your radio can store up to 10 of your favourite stations as presets on both the DAB and FM bands for quick recall.

To store any preset 1-10

Tune to the station you want to store as a preset.

- Press the **PRESET** button.
- Press the **PRESET/ARROW ►** or **◄** button repeatedly to find the preset number you want to store.
- Press and **hold** the **PRESET** button to confirm and store the preset.

To recall any preset 1-10

- Press the **PRESET** button.
- Press the **PRESET/ARROW ►** or **◄** button repeatedly to find the preset number you want to play.
- Press the **PRESET** button **briefly** to play the preset.

iPod ADAPTORS

Before docking your iPod you must first check if your iPod has a docking connector. Early iPod models (and iPod shuffle do not have one and cannot be docked to your unit. The docking connector is located on the base of the iPod as shown below.

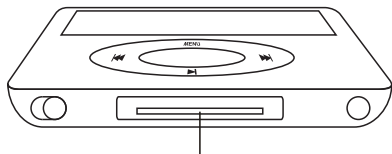

Docking Connector

Before docking your iPod, you must first fit the correct iPod adaptor to the docking bay. Each iPod adaptor matches the shape of a particular iPod and is necessary to ensure that your iPod is securely held when docked.

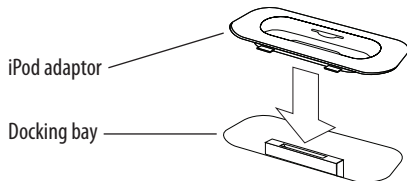

FITTING THE iPod ADAPTOR

When your iPod was new it may have been supplied with a standard dock adaptor in the packaging. If so, fit the adaptor by pressing it gently into the Docking Bay as shown above.

NOTE: Do not dock an iPod without fitting the correct adaptor, you may damage the iPod and your unit.

FINDING AN ADAPTOR

If you don't have a dock adaptor

If your iPod was not supplied with a standard dock adaptor, or if you have lost the adaptor, you can buy one from Apple on-line. To determine the exact model of your iPod, refer to this web-link - <http://support.apple.com/kb/HT1353>. You can then browse the iPod accessories page on the Apple website to find an adaptor for your iPod model that can be purchased on-line.

DOCKING AN iPod

DOCKING YOUR iPod

To dock your iPod:

- Switch off the power.
- Check that the correct iPod adaptor is fitted to the docking bay.
- Locate the iPod on the Docking Connector and press it gently home.

To remove your iPod from the dock:

- Grip the iPod at the sides.
- Lift the iPod gently from the dock.

CHARGING AN iPod

When an iPod is docked, the iPod will begin to charge automatically.

NOTE:- The iPod will charge at all times that the radio is connected to mains power.

PLAYING FROM AN iPod

Once an iPod is docked, you can operate your iPod functions from the controls on the top panel or the remote control.

Selecting iPod playback mode:

- Press the **FUNCTION** button repeatedly to select iPod mode.

Playback functions:

- Press the **▶||/SCAN** button to toggle between Play and Pause mode at any time.
- Press the **▶▶** or **◀◀** button to select the next or previous track on your iPod.

iPod menu functions:

When an iPod is docked and playing you can navigate the menus from the control buttons on your radio.

- To move up through the iPod menu, press the **MENU/INFO** button.
- To scroll up and down options displayed on the iPod menu, press the **PRESET/ARROW ▶** or **◀** button.
- To select menu items, press the **SELECT** button.

USING THE ALARMS

SETTING THE ALARMS

You can set two completely separate alarm times (ALARM 1 and ALARM 2) and activate either or both of them to wake you with a buzzer, radio, or music from a docked iPod.

Changing Alarm 1 settings:

- Press the **AL. SET/OFF** ① button to display the current settings for Alarm 1.

Alarm 1 wake up mode

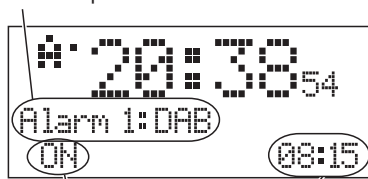

Alarm 1 ON/OFF

Alarm 1 time

In this example, Alarm 1 is set to play DAB radio at 08:15.

- If Alarm 1 is switched off, press the **PRESET/ARROW** ► or ◀ button to switch Alarm 1 On.

NOTE: You can only change alarm settings when the alarm is switched on.

- Press the **SELECT** button.

The current wake-up mode setting will flash on the display.

- Press the **PRESET/ARROW** ► or ◀ button to select the alarm wake-up mode for Alarm 1.
- Press the **SELECT** button to save this setting.

The current wake-up time will be shown with the hours digits flashing.

- Press the **PRESET/ARROW** ► or ◀ button to set the hours for the alarm wake-up time.
- Press the **SELECT** button to save this setting.

The minutes digits will now flash.

- Press the **PRESET/ARROW** ► or ◀ button to set the minutes for the alarm wake-up time.
- Press the **SELECT** button to save this setting.

The alarm setting sequence will close.

Changing Alarm 2 settings:

Follow the above steps, but pressing the **AL. SET/OFF** ② button in place of the **AL. SET/OFF** ① button.

Checking Alarm 1 or 2 settings:

- Press the **AL. SET/OFF** ① (or ②) button.
- Press the **AL. SET/OFF** ① (or ②) button again to return to normal operation.

Switching Alarm 1 or 2 On or Off:

- Press the **AL. SET/OFF** ① (or ②) button.
- Press the **PRESET/ARROW** ► or ◀ button to switch Alarm 1 (or 2) On or Off.

When set, the status of the Alarm(s) selected will be shown on the display.

Alarm 1 set

Alarm 2 set

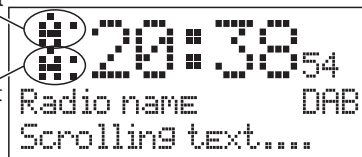

SETTING THE ALARM TO WAKE YOU

To set the alarm to wake you:

- Check that the Alarm 1 or Alarm 2 symbols are displayed as required. If not, set the Alarm(s) On as described in the previous section.
- If you have set either wake up mode to DAB or FM, check that you have tuned the radio to a station.
- If you have set either wake up mode to 'iPod', make sure that your iPod is docked.
- Set the radio to Standby (or set the SLEEP function).

The radio will switch off and the time and date will be displayed with the Alarm Symbol(s) when set.

WHEN THE ALARM WAKES YOU

The alarm will wake you at the set times with your choice of wake-up mode. The volume will gradually increase in level until turned off.

To turn off the alarm you can choose to set snooze, which will reset the alarm for a further 9 minutes, or to switch it off.

To set snooze:

- To set snooze, press the **SNOOZE** button.
- The alarm will stop and the snooze time will count down on the display. After 9 minutes the alarm will sound again.

To switch off the alarm:

- To switch off the alarm, press the **STANDBY/ON** button.
- The unit will set to Standby.

ALARM REPEAT

Once set, the alarm(s) will sound at the same time(s) each day until turned off.

ADVANCED OPERATION

DAB MANUAL TUNING

For most users, tuning to DAB stations via the DAB station list is recommended. For advanced users it is also possible to manually tune to a station.

To tune manually:

- Press and hold the **SELECT** button until the display shows 'Manual tune'.

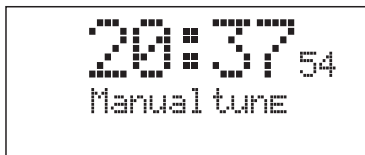

- Press the **▶▶** or **◀◀** button to step through the DAB channels.

The display will show the number and frequency of the channel you are tuning to. If the channel contains a station multiplex, the name of the multiplex will also be displayed.

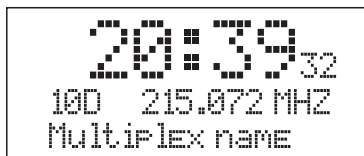

- To tune to stations within this multiplex, press the **SELECT** button.
- Press the **▶▶** or **◀◀** button to browse the station names available within this multiplex.

- To tune to a station, press the **SELECT** button when the station name is displayed.

After a short delay the station will tune.

SLEEP FUNCTION

SLEEP TIMER

You can set the Sleep timer to play music for a set period while you are falling asleep.

To set the sleep timer:

- Play your choice of music.
- Press the **SLEEP/CLOCK** button repeatedly to set the sleep time you want in 10 minute intervals from a maximum of 90 minutes down to 10 minutes. Pressing the **SLEEP/CLOCK** button once more will switch sleep mode off.

The sleep time you set will be shown on the display (90 minutes in the example below) until the sleep time ends.

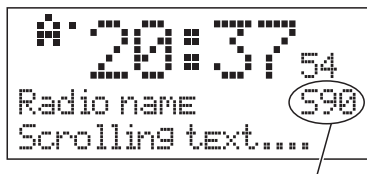

Sleep time indication

Music will continue to play during the sleep time. When the sleep time expires, the unit will set to Standby.

TROUBLESHOOTING

Poor quality radio reception

The aerial signal may not be adequate. Try repositioning the aerial while watching the signal strength. Signal strength can be displayed by tuning to a DAB station and pressing the **MENU/INFO** button repeatedly until the signal strength bargraph is displayed.

Alarm not sounding

Check that you have set Alarm 1 or Alarm 2 on in the alarm setting sequence. When the alarms are on, the Alarm 1 or Alarm 2 symbol will be displayed.

Poor quality radio reception when an iPhone is docked:

You may need to set the iPhone to 'airplane' mode when docked.

CARE AND MAINTENANCE

CARE AND CLEANING

All care and cleaning operations should be carried out with the unit unplugged from the mains power.

The surface of the unit can be cleaned with a barely damp cloth and then dried carefully. Never use abrasives, abrasive cloths or chemical solvents.

WARRANTY & SPECIFICATIONS

SPECIFICATIONS

Supply Voltage: 230-240 V ~, 50 Hz

Power consumption: 7 W

Frequency range: 174-240 MHz (DAB)
87.5-108 MHz (FM)

Net Weight: 0.75 kg



Class II construction double insulated.

This product must not be connected to earth.

WARRANTY

Your Tesco appliance is covered by a warranty for 12 months from the date of purchase. If a fault develops during this period, please contact the TESCO electrical help line on 0845 456 6767. Please have your original purchase receipt with you when you call. This warranty in no way affects your consumer rights.



UK: Waste electrical products/batteries should not be disposed of with household waste. Separate disposal facilities exist, for your nearest facilities see www.recycle-more.co.uk or in-store for details.

ROI: Produced after 13th August 2005. Waste electrical products/batteries should not be disposed of with household waste. Please recycle where facilities exist. Check with your Local Authority or retailer for recycling advice.



Technika

Tesco Stores Ltd,
Delamare Road, Cheshunt, Herts, EN8 9SL

▶ **Technika Helpline: 0845 456 6767** (Calls cost up to 4p per minute from a BT landline, other providers may vary)

CR-121DAB V0.1

Free Manuals Download Website

<http://myh66.com>

<http://usermanuals.us>

<http://www.somanuals.com>

<http://www.4manuals.cc>

<http://www.manual-lib.com>

<http://www.404manual.com>

<http://www.luxmanual.com>

<http://aubethermostatmanual.com>

Golf course search by state

<http://golfingnear.com>

Email search by domain

<http://emailbydomain.com>

Auto manuals search

<http://auto.somanuals.com>

TV manuals search

<http://tv.somanuals.com>