

Technika

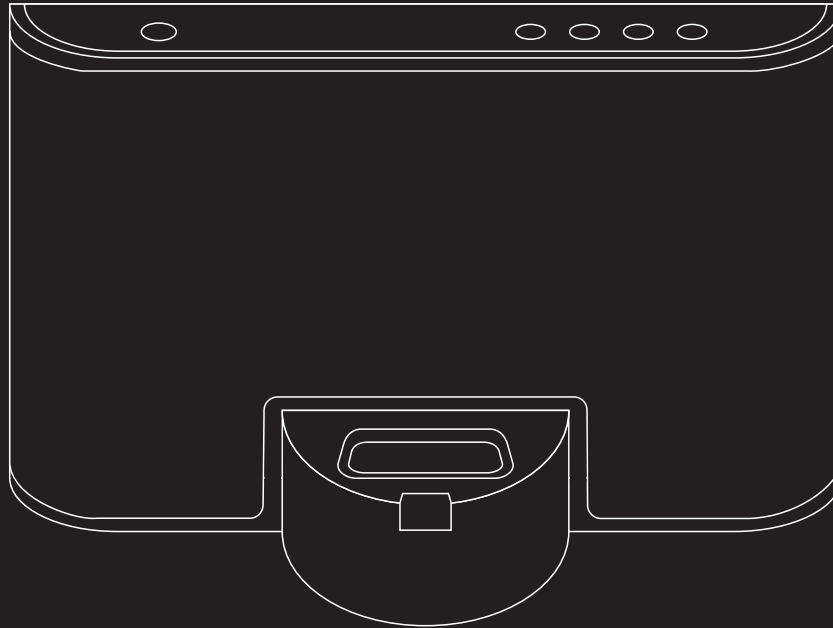

User Guide

SP330
Speaker dock for iPhone/iPod





IMPORTANT SAFETY INFORMATION



This symbol indicates that there are important operating and maintenance instructions in the literature accompanying this unit.



This symbol indicates that dangerous voltage constituting a risk of electric shock is present within this unit.

Read these instructions.

Keep these instructions.

Heed all warnings.

Follow all instructions.

Do not use this apparatus near water.

Clean only with a slightly damp cloth.

Do not block any ventilation openings.

Install in accordance with the manufacturer's instructions.

Do not install or operate near any heat sources such as radiators, stoves, or other apparatus that produce heat.

Unplug this apparatus during lightning storms or when unused for long periods of time.

Refer all servicing to qualified service personnel. Servicing is required when the apparatus has been damaged in any way, such as the power-supply cord or plug is damaged, liquid has been spilled or objects have fallen into the apparatus, the apparatus has been exposed to rain or moisture, does not operate normally, or has been dropped.

Warning: To reduce the risk of fire or electrical shock, do not expose this product to rain or moisture. The product must not be exposed to dripping and splashing and no object filled with liquids such as a vase of flowers should be placed on the product.

No naked flame sources such as candles should be placed on the product.

Caution: Changes or modifications not expressly approved by the manufacturer could void the user's authority to operate this device.

Caution: Usage of controls or adjustments or performance of procedures other than those specified herein may result in hazardous exposure.

IMPORTANT

This equipment generates, uses and can radiate radio frequency energy and, if not installed and used in accordance with the instructions, may cause harmful interference to radio communication. However, this is no guarantee that interference will not occur in a particular installation. If this equipment does cause harmful interference to radio or television reception, which can be determined by turning the equipment off and on, the user is encouraged to try to correct the interference by one of the following measures:

- Reorient or relocate the receiving antenna.
- Increase the separation between the equipment and receiver.
- Connect the equipment into an outlet on a circuit different from that to which the receiver is connected.
- Consult the dealer or an experienced radio/TV technician for help.

ELECTRICAL INFORMATION

Use this appliance only with the supplied AC Adaptor. Using non-approved power supplies will void the warranty.

Mains Supply: The mains operating voltage of the AC Adaptor is marked on a rating plate on the AC Adaptor.

The means of disconnecting this appliance from the mains supply is the AC adaptor. This should be unobstructed and readily operable at all times.



INDEX

INDEX

Important safety information.....	1
Introduction	2
Unpacking	2
Controls and connections.....	3
Remote control	5
Adaptors.....	6
Getting started	7
Power control	7
Docking and playing an iPod	7
Volume control, selecting a source.....	8
Video connection and playback	9
Tone controls	10
Troubleshooting	10
Care & Maintenance.....	10
Specifications	10
Warranty	10

INTRODUCTION

The SP330 is a stylish, remote controlled iPhone/iPod docking station with dual reflex speakers and with a video output to feed video programs from video equipped iPhone/iPod models to a TV.

PRELIMINARIES

UNPACKING

Carefully unpack the unit. If it is damaged, please return it to your nearest Tesco store for replacement. Remember to take your purchase receipt with you.

Retain the User Handbook. If you pass the unit on to a third party make sure you pass on the handbook.

We suggest you retain the packaging. If you dispose of it, do so having regard to any recycling regulations in your area.

CONTENTS

The carton should contain:

- The SP330 docking station
- AC adaptor
- Remote control including battery
- Set of 3 x iPhone/iPod adaptors
- Video out cable (yellow plugs)
- Audio in cable (grey plugs)
- Operating Manual

If any items are missing or damaged, contact your nearest TESCO store for a replacement. Have your receipt ready when you call. Retain the packaging. If you dispose of it, do so having regard to any recycling regulations in your area.

LOCATION

Place the unit on dry stable surface away from heat and damp and where it is unlikely to fall or be knocked over.



CONTROLS AND CONNECTIONS

FRONT VIEW

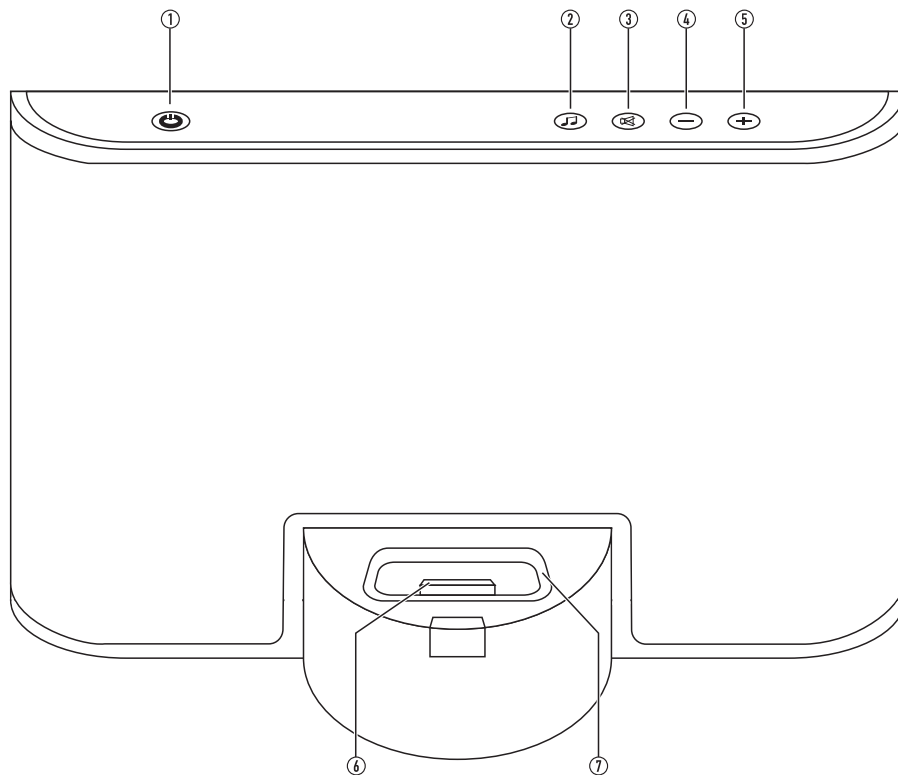

- ① Standby button
- ② Source select button
- ③ Mute button
- ④ Volume down button
- ⑤ Volume up button
- ⑥ iPhone/iPod docking connector
- ⑦ iPhone/iPod dock adaptor

CONTROLS AND CONNECTIONS

BACK VIEW

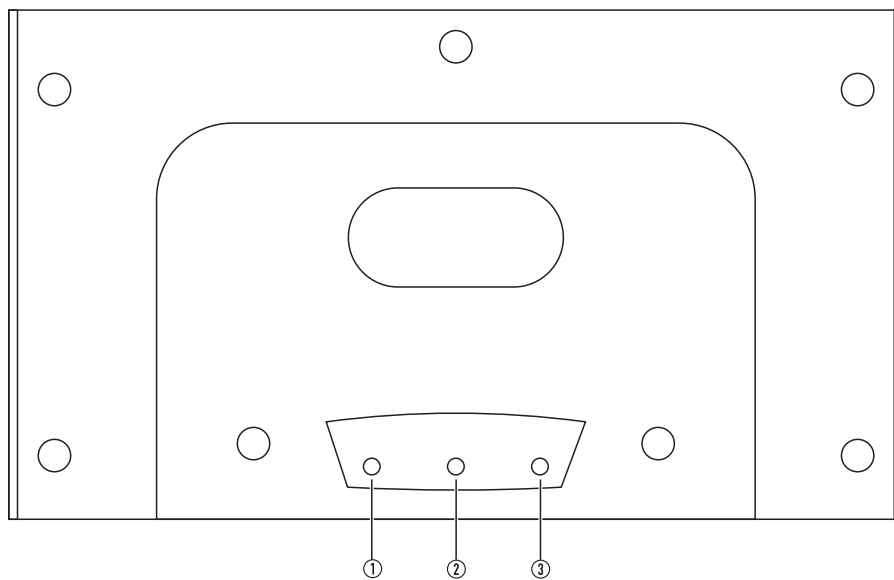

- ① Audio In jack
- ② Video Out jack
- ③ DC In jack

REMOTE CONTROL

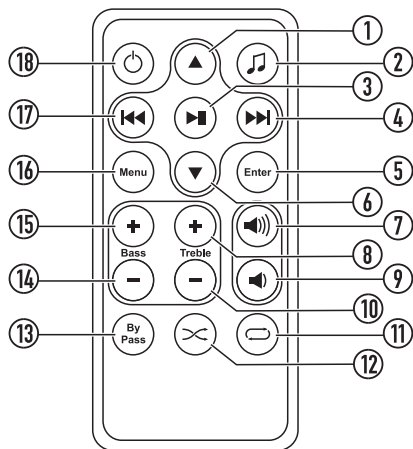

- | | |
|--------------------------|--------------------------|
| ① Up button | ⑩ Decrease treble button |
| ② Source button | ⑪ Repeat button |
| ③ Play/pause button | ⑫ Shuffle button |
| ④ Next button | ⑬ Reset tone button |
| ⑤ Enter button | ⑭ Decrease bass button |
| ⑥ Down button | ⑮ Increase bass button |
| ⑦ Volume up button | ⑯ Menu button |
| ⑧ Increase treble button | ⑰ Previous button |
| ⑨ Volume down button | ⑱ Standby button |

REMOTE CONTROL BATTERIES

BEFORE FIRST USE

To prepare the remote control for first use, pull out the safety strip to activate the battery.

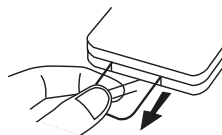

REPLACING THE BATTERY

When replacing the battery in the remote control, refer to the diagram below.

1. Press the catch across.
2. While holding the catch, open the battery door.

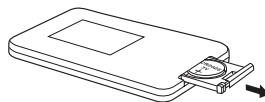

3. Fit the battery observing polarity as shown. When replacing the battery, use only the same CR2025 type specified.

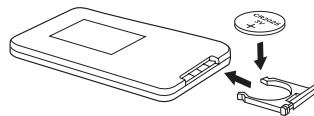

BATTERY DISPOSAL

Dispose of used batteries with regard to the recycling regulations in your area. Do NOT short circuit batteries or throw them into water, the general rubbish or in a fire.

Weak batteries can leak and damage the remote control. Replace them in good time!

iPhone/iPod ADAPTORS

Before docking your iPod you must first check if your iPod has a docking connector. Early iPod models do not have one and cannot be docked to your unit. The docking connector is located on the base of the iPod as shown below.

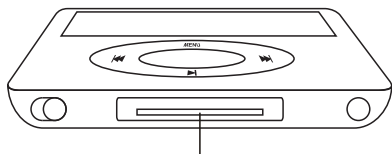

Docking Connector

Before docking your iPhone/iPod, you must first fit the correct iPhone/iPod adaptor to the docking bay. Each iPhone/iPod adaptor matches the shape of a particular iPhone/iPod and is necessary to ensure that your iPhone/iPod is securely held when docked.

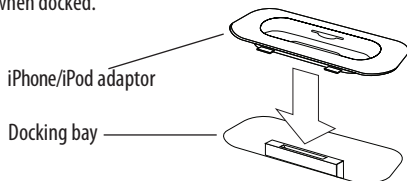

FINDING THE CORRECT iPhone/iPod ADAPTOR

Your iPhone/iPod docking system is supplied with a selection of docking adaptors that are compatible with several models in the iPhone/iPod range. Refer to the table of iPhone/iPod models in the next column which lists the adaptor numbers (marked underneath the adaptor), compatibility and instructions for obtaining an adaptor for unlisted models.

NOTE: Do not dock an iPhone/iPod without fitting the correct adaptor, you may damage the iPhone/iPod and your unit.

SELECTING AN ADAPTOR

LIST OF SUPPLIED ADAPTORS

- (15) iPhone 3G.
- (16) iPod touch(2nd generation).
- (17) iPod nano(4nd generation).

Other iPhone/iPod models with dock connectors

Your iPhone/iPod may have been supplied, packed with a standard dock adaptor. If so, this can be used as the docking bay on your unit is compatible with adaptors supplied by Apple.

If you don't have a dock adaptor

If your iPhone/iPod was not supplied with a standard dock adaptor, you can buy one from Apple on-line. To determine the exact model of your iPhone/iPod, refer to this web-link - <http://support.apple.com/kb/Ht1353>. You can then browse the iPhone/iPod accessories page on the Apple website to find an adaptor for your iPhone/iPod model that can be purchased on-line.

Once you have located the correct adaptor for your iPhone/iPod, press it gently into the iPhone/iPod Docking Bay before attempting to dock your iPhone/iPod.

CONNECTING OTHER iPod MODELS (INC SHUFFLE)

If you own an iPod Shuffle, a model without dock connector or prefer to connect your iPhone/iPod by cable, you can connect the sound output to the Audio Input jack on the rear panel.

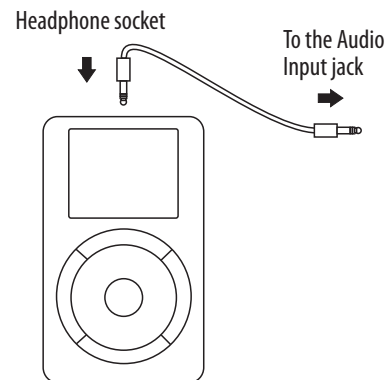

- Using the 3.5mm stereo jack to jack cable (supplied, with grey plugs), connect one end of the cable to the headphone socket of the iPhone/iPod, and the other end to the Audio Input jack on the back panel.
- To listen to your iPhone/iPod, follow the instructions under 'External Sources' on page 8 for playing equipment connected to the Audio Input jack.

NOTE:- The volume control of the iPhone/iPod must be turned up when playing through the Audio Input jack.

NOTE:- An iPhone/iPod connected to the Audio Input jack cannot be operated from the remote control.

GETTING STARTED

CONNECTING POWER

Before connecting the power, check that the mains voltage on the rating plate of the AC adaptor is the same as the voltage in your area.

- Plug the DC cord from the AC adaptor into the DC jack on the back of the unit.
- Plug the AC adaptor into the wall socket and switch the mains power on.

The unit is now ready for use.

NOTE:- The AC adaptor may become warm during operation - this is normal.

POWER CONTROL

STANDBY CONTROL

To turn the docking station on:

- Press the  button.

The unit will switch on and the buttons on the top panel will light.

To turn the docking station off:

- Press the  button.

The unit will switch off. When set to Standby the lights in the top panel buttons will switch off.

Auto Standby:

The unit will also set to standby automatically, approximately two minutes after music has finished playing from a docked iPhone/iPod or a source connected to the Audio Input jack.

DOCKING AN iPhone/iPod

DOCKING YOUR iPhone/iPod

To dock your iPhone/iPod:

- Set the unit to Standby.
- Check that the correct iPhone/iPod adaptor is fitted to the docking bay (see previous page).
- Locate the iPhone/iPod on the Docking Connector and press it gently home.

The iPhone/iPod is now ready to play.

To remove your iPhone/iPod from the dock:

- Set the unit to Standby.
- Grip the iPhone/iPod at the sides.
- Lift the iPhone/iPod gently from the dock.

CHARGING AN iPhone/iPod

When an iPhone/iPod is docked, the iPhone/iPod will begin to charge automatically.

NOTE:- The iPhone/iPod will charge at all times that the unit is connected to mains power.





PLAYING FROM AN iPhone/iPod

Playing from a docked iPhone/iPod:

- Set the iPhone/iPod to play.

You can also operate your iPhone/iPod functions from the control panel or the remote control.

iPhone/iPod playback functions:

- Press the  button to toggle between Play and Pause mode at any time.
- Press the  or  button on the remote control to select the next or previous track on your iPhone/iPod.
- Press the  button to scroll through the repeat modes available on the iPhone/iPod.



The display on the iPhone/iPod will show the repeat mode set.

- Press the  button to switch shuffle mode on or off.

The display on the iPhone/iPod will show if shuffle mode is set.

iPhone/iPod menu functions:

When an iPhone/iPod is docked and playing you can navigate the menus from the keys on the control panel or remote control.

- To move up through the iPhone/iPod menu, press **Menu**.
- To scroll up and down options displayed on the iPhone/iPod menu, press the  or  button.
- To select menu items, press the **Enter** button on the remote control.

ADJUSTING THE VOLUME

To increase the volume:

- Press the + button on the top panel or the  button on the remote control.

To decrease the volume:

- Press the - button on the top panel or the  button on the remote control.

EXTERNAL SOURCES

The Audio Input jacks on the back panel may be used to connect sound sources with a Line or Headphone analogue output to play through your unit. These may include -

- iPod models that cannot be docked to the unit
- MP3 players
- CD walkman players
- Tape walkman players
- Personal computers or laptops

Connecting to the Audio Input jack

- Connect the Audio Input cable (supplied, with grey plugs) between the headphone or LINE/AUX output of the personal audio player and the Audio Input jack on the back panel.

Playing the external source

- Press the  button to select the external source.
- Set your personal audio player/computer to PLAY.
- Set the listening volume to the level you want.

If there is no sound or if the volume level is not loud enough, you may need to increase the volume setting on your personal audio player/computer.

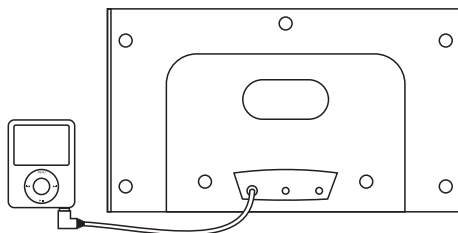

VIDEO CONNECTION

Your docking station includes a video output jack to feed video signals to a TV from an iPhone/iPod which has video capability. NOTE:- The TV must have a composite video (CVBS) video input.

To connect the docking station to a TV:

- Connect the video cable (supplied, with yellow plugs) to the Video Out jack on the back panel.
- Connect the other end of the cable to a Composite video (CVBS) input of the TV. A suitable input will often be located under a flap on the front or side of the TV. The video input jack will be coloured yellow.

VIDEO PLAYBACK

Switching on the iPod video output:

Before viewing photo or video programs on your TV you will need to switch on the iPhone/iPod video output. The iPhone/iPod video output selector is generally found as follows -

- Navigate to the 'Videos' or 'Photos' menu of the iPhone/iPod.
- Select 'Settings'.
- Select 'TV out'.
- Set 'TV out' to On.

The video signal from the iPhone/iPod dock connector will now be enabled.

Selecting the correct input on your TV:

- Set the TV input selector to the AV input that you used when connecting the Video cable.

Playing the video:

- Using the remote control, navigate to select the video you want to watch on the iPhone/iPod display and set it to play.

The picture will play on the TV and the sound will play from your docking station.

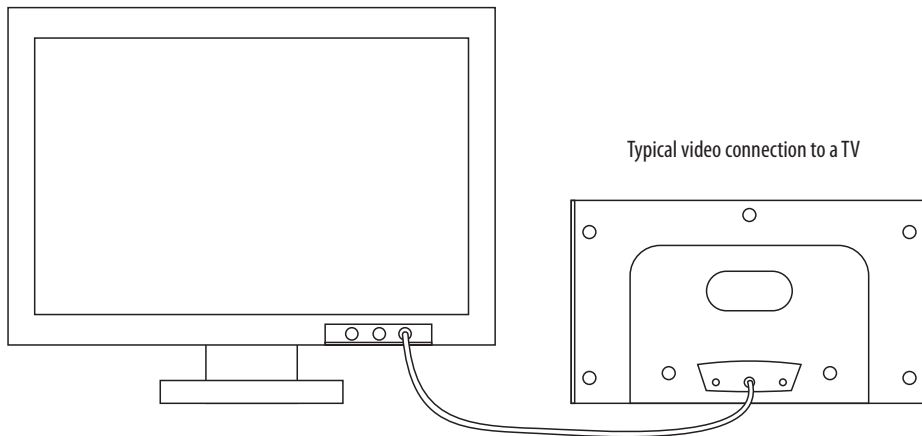



BASS AND TREBLE

You can change the equalisation of the sound to suit your taste by adjusting the bass and treble settings.

To adjust the bass sound:

- Press the **Bass +** button repeatedly to boost the bass sound. You can boost by up to three steps.
- Press the **Bass -** button repeatedly to cut the bass sound. You can cut by up to three steps.

You will hear the change in bass sound as you change the setting.

To adjust the treble sound:

- Press the **Treble +** button repeatedly to boost the treble sound. You can boost by up to three steps.
- Press the **Treble -** button repeatedly to cut the treble sound. You can cut by up to three steps.

You will hear the change in treble sound as you change the setting.

To return the bass and treble settings to 'flat' (no bass or treble boost or cut):

- Press the **By Pass** button to restore a 'flat' response.

TROUBLESHOOTING

No response from the remote control

The remote control battery may be exhausted. Check by replacing the battery.

No sound/low volume from an external source:

Check that the volume control is turned up on the external source.

No picture on the TV when playing videos or photos:

Check that the video connections are correctly made.

Check that the correct AV input is selected on the TV.

Check that the iPhone/iPod video output is enabled.

CARE AND MAINTENANCE

CARE AND CLEANING

All care and cleaning operations should be carried out with the unit unplugged from the mains power.

The surface of the unit can be cleaned with a barely damp cloth and then dried carefully. Never use abrasives, abrasive cloths or chemical solvents .

WARRANTY & SPECIFICATIONS

SPECIFICATIONS

Supply Voltage, Current : 12V ---, 2A

AC Adaptor input:..... 100-240V ~,47-63Hz, 1A

AC Adaptor output: 12 V ---, 2A

Net Weight:..... 1.06 kg



Class II construction double insulated.

This product must not be connected to earth.



UK: Waste electrical products/batteries should not be disposed of with household waste. Separate disposal facilities exist, for your nearest facilities see www.recycle-more.co.uk or in-store for details.

ROI: Produced after 13th August 2005. Waste electrical products/batteries should not be disposed of with household waste. Please recycle where facilities exist. Check with your Local Authority or retailer for recycling advice.

WARRANTY

Your Tesco appliance is covered by a warranty for 12 months from the date of purchase. If a fault develops during this period, please contact the TESCO electrical help line on 0845 456 6767. Please have your original purchase receipt with you when you call. This warranty in no way affects your consumer rights.







Technika

Tesco Stores Ltd, Delamare Road, Cheshunt, Herts, EN8 9SL

SP330 V0.1

UMA0439B

Free Manuals Download Website

<http://myh66.com>

<http://usermanuals.us>

<http://www.somanuals.com>

<http://www.4manuals.cc>

<http://www.manual-lib.com>

<http://www.404manual.com>

<http://www.luxmanual.com>

<http://aubethermostatmanual.com>

Golf course search by state

<http://golfingnear.com>

Email search by domain

<http://emailbydomain.com>

Auto manuals search

<http://auto.somanuals.com>

TV manuals search

<http://tv.somanuals.com>