

Technika

EXCLUSIVELY FROM **TESCO**

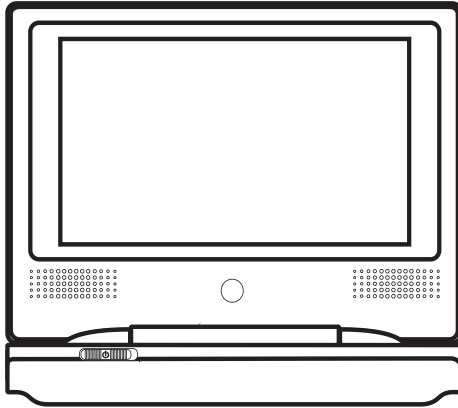

DPDVD7

Owner's  
Handbook

7" Portable DVD Player

## IMPORTANT SAFETY INFORMATION



This symbol indicates that dangerous voltage constituting a risk of electric shock is present within this unit.



This symbol indicates that there are important operating and maintenance instructions in the literature accompanying this unit.

Read these instructions.

Keep these instructions.

Heed all warnings.

Follow all instructions.

Do not use this apparatus near water.

Clean only with a slightly damp cloth.

Do not block any ventilation openings.

Install in accordance with the manufacturer's instructions.

Do not install or operate near any heat sources such as radiators, stoves, or other apparatus that produce heat.

Unplug this apparatus during lightning storms or when unused for long periods of time.

Refer all servicing to qualified service personnel. Servicing is required when the apparatus has been damaged in any way, such as the power-supply cord or plug is damaged, liquid has been spilled or objects have fallen into the apparatus, the apparatus has been exposed to rain or moisture, does not operate normally, or has been dropped.

**Warning:** To reduce the risk of fire or electrical shock, do not expose this product to rain or moisture. The product must not be exposed to dripping and splashing and no object filled with liquids such as a vase of flowers should be placed on the product.

No naked flame sources such as candles should be placed on the product.

**Caution:** Changes or modifications not expressly approved by the manufacturer could void the user's authority to operate this device.

Caution: Usage of controls or adjustments or performance of procedures other than those specified herein may result in hazardous exposure.

These labels tell you that the unit contains a Laser component. Do not stare at the laser lens.



When the disc tray is open a safety interlock disconnects power to the laser. Do not defeat this safety interlock

## IMPORTANT

This equipment generates, uses and can radiate radio frequency energy and, if not installed and used in accordance with the instructions, may cause harmful interference to radio communication. However, this is no guarantee that interference will not occur in a particular installation. If this equipment does cause harmful interference to radio or television reception, which can be determined by turning the equipment off and on, the user is encouraged to try to correct the interference by one of the following measures:

- Reorient or relocate the receiving antenna.
- Increase the separation between the equipment and receiver.
- Connect the equipment into an outlet on a circuit different from that to which the receiver is connected.
- Consult the dealer or an experienced radio/TV technician for help.

**BATTERY WARNINGS:** The DVD player and the handset use batteries. There is a risk of fire and burns if batteries are handled improperly. Do not disassemble, crush, puncture, short external contacts, or dispose of in fire or water.

Do not service the internal player battery. Have it examined (and replaced if needed) by a competent service centre.

Replace the handset battery only with a battery of the same voltage and type.

Discard used batteries in accordance with recycling regulations in force in your area.

## CONTENTS

SAFETY INFORMATION .....	Inside Front Cover
INTRODUCTION.....	1
PLAYER FEATURES .....	2
CONTROLS AND FUNCTIONS.....	3
EXTERNAL AUDIO AND VIDEO CONNECTIONS.....	4
REMOTE HANDSET .....	5
POSITIONING THE PLAYER.....	6
HANDSET TOPICS .....	6
CONNECTING THE DC POWER ADAPTER.....	6
PORTABLE OPERATION .....	6
GETTING STARTED.....	7
PLAYING A DVD .....	7
PLAYING AN AUDIO CD.....	10
PLAYING A JPG DISC.....	11
PLAYING AN XviD DISC.....	13
CUSTOMISING PLAYER SETTINGS .....	14
THE RATINGS PAGE (PARENTAL SETTINGS) .....	16
CHANGING THE PASSWORD .....	17
TROUBLESHOOTING .....	19
CARE AND CLEANING .....	19
SPECIFICATIONS & WARRANTY .....	20

## INTRODUCTION

### Read this manual before using your player.

The Player is set to play Region 2 discs.

The player will accept the following formats (among others): DVD, DVD+R, DVD+RW, CD-DA, CD, CD-R, CD-RW, Picture CD,

The following formats are not acceptable:

DVD discs with other region codes.

Improperly formatted CD-Rs or CD-RWs. This may include discs which are not finalised.

The player has built in copyright protection technology. If a video recorder is connected to the player, the video output image may be distorted during recording.

## UNPACKING

### The carton should contain:

- Portable DVD Player
- Remote Control
- External Power Adapter
- Operating Manual

If any items are missing or damaged, contact your nearest TESCO store for a replacement. Have your receipt ready when you call. Retain the packaging. If you dispose of it, do so having regard to any recycling regulations in your area.

**Before using the player open it and carefully remove any protective film covering the screen. Take care not to press on the screen while doing this.**

## PLAYER FEATURES

DVD, CD, CD-R, CD-RW DVD+R, DVD+RW capable

**TV format:** NTSC (Player): PAL (Video Out)

**Screen format:** Selectable Normal/Widescreen

**Video output:** Composite Video output

**Audio output:** Stereo analogue output

**DVD features:**

Multi Subtitle select

Multi Language select

Multi Angle select

**Other features:**

On screen display menu

Multi-level zooming

Parental control

JPG picture view



## DVD REGION CODES

DVD discs and players are covered by a worldwide agreement which limits playback of DVD discs to specific regions as determined by the software manufacturer. Most DVDs come marked with a region coding. A disc specified as playable in one region may not play on a player designed for a different region. A disc specified as universal or with no region coding (Code 0) may be played in any region.

The regions are:

Region 1: Canada, USA

Region 2: Europe, Japan, Mid. East, South Africa

Region 3: South-East Asia

Region 4: Australia, Caribbean, Central & South America, New Zealand

Region 5: Africa, Former Soviet Union, India, North Korea, Pakistan

Region 6: China

**THIS PLAYER PLAYS REGION 2 AND REGION FREE, UNIVERSAL (0) DISCS.**

### IMPORTANT NOTE

DVD discs contain various features. Many features are determined by the program or software content on the DVD disc itself. Some procedures in this manual cannot be performed if the disc does not support the feature. Also, some discs may need special settings which are unsupported by the player.

### GENERAL CAUTIONS

**CAUTION:** during playback, the disc spins at high speed, do not lift or move the player, doing so may damage the disc.

**CAUTION:** when the player is stopped the disc is still rotating at a very high speed. Leave the disc to come

to a rest before removing it. Stopping a disc manually could damage both the disc and the player.

**Never press down on the disc compartment lid especially when a disc is playing.**

The player has built in copyright protection technology that prevents copying from a DVD disc to any media.

If a video recorder is connected to the player, the video output image will be distorted.

### NOTICES

This product incorporates copyright protection technology that is protected by U.S. patents and other intellectual property rights. Use of this copyright protection technology must be authorized by Rovi Corporation, and is intended for home and other limited viewing uses only unless otherwise authorized by Rovi Corporation. Reverse engineering or disassembly is prohibited.

Manufactured under license from Dolby Laboratories. Dolby and the double-D symbol are trade marks of Dolby Laboratories.



## CONTROLS AND FUNCTIONS

- 1) LCD On/Off switch: Press to blank out the screen.
- 2) MENU Button: Press to access the menu of a DVD
- 3) SETUP button: Press to enter the player's Setup menu
- 4) ■ (Stop) button: Press to stop a disc (See Page 8)
- 5) ►|| (Play/Pause) button: Press to Play/Pause a Disc.
- 6) Navigation Keys\*: (See below)
- 7) OPEN button: Press to open the Disc Compartment
- 8) 9 V DC jack: Insert the Mains Adaptor jack here.
- 9) Battery charge indicator:

The indicator glows red when the battery is charging.  
When the battery is fully charged the indicator goes out.

- 10) Power On/Off switch (with integral power indicator):  
Switch the Player ON/OFF. When the player is on the indicator is lit.
- 11) Infrared sensor: Point the Handset here to operate the player.
- 12) AV OUT jack: Connect to external AV equipment
- 13) Headphone Jack: Connect to headphones (disables the internal speakers)
- 14) Volume Control: Alters the volume of the player.

### NAVIGATION KEYS

- ▲ Move Up a Menu/Menu Choice
- ▼ Move Down a Menu/Menu Choice
- Move along a Menu/Menu Choice
- ◄ Move Back in a Menu/Menu Choice
- OK** Confirm an Action

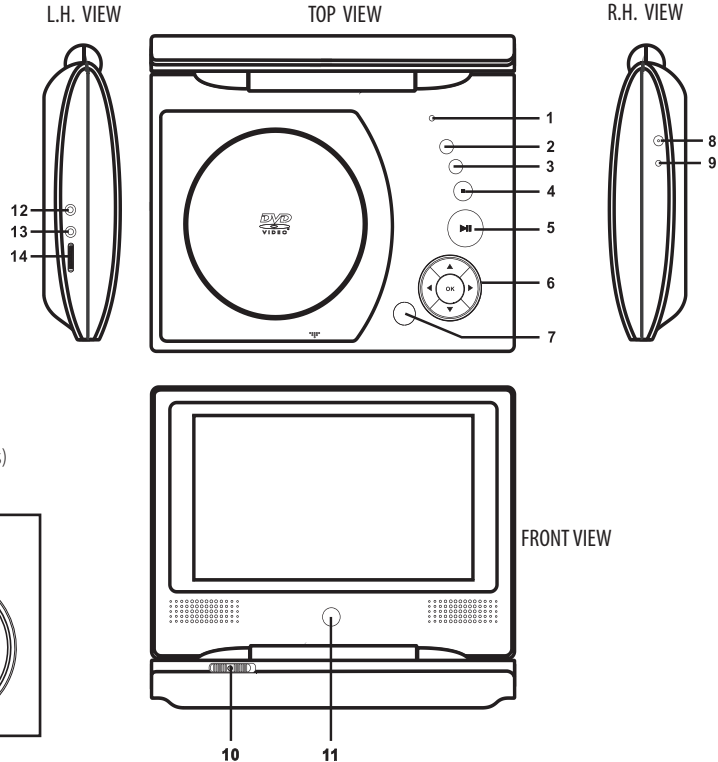
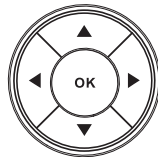

## EXTERNAL AUDIO/VIDEO CONNECTIONS



WHEN CONNECTING EQUIPMENT, ENSURE THE PLAYER AND ALL ANCILLARY EQUIPMENT IS SWITCHED OFF AND UNPLUGGED AT THE MAINS.

### TV (AUDIO/VISUAL) CONNECTION

You will need to purchase an interconnect with a three pole jack on one end and three RCA phono plugs on the other. This interconnect is often used for connecting Camcorders and games consoles.

Connect the jack plug to the Player AV OUT socket. Connect the YELLOW plug to the Composite Video input of the TV. Connect the WHITE and RED plugs to the Audio inputs of the TV.

You can now view and listen to the DVD player on the TV.

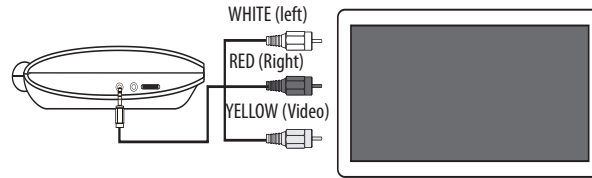

When the player is connected to an external screen, the internal player screen is blanked out. This normal and NOT a fault.

### AUDIO CONNECTION

You will need the interconnect as described above. Connect the jack plug to the Player AV OUT socket. Connect the WHITE and RED plugs to a LINE input of your hi-fi system. Do NOT connect the YELLOW plug.

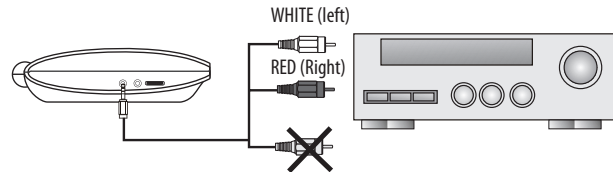

### HEADPHONE CONNECTION

Connect a pair of headphones as shown. This connection disconnects the internal speakers of the DVD player.

**WARNING:** Listening at loud volumes can damage your hearing!

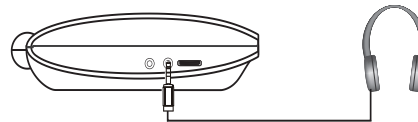

## REMOTE HANDSET KEY OPERATIONS

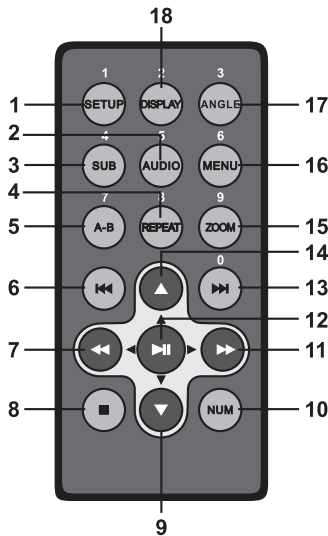

- 1 **SETUP:** Enter/Exit the player Setup menu
- 2 **AUDIO:** Select audio language during DVD/CD play
- 3 **SUB:** Select a subtitle during play
- 4 **REPEAT:** Repeat a track/title/chapter/disc
- 5 **A-B:** Select and repeat a chosen passage
- 6 <<< Go to the Previous chapter/track
- 7 << Fast Reverse Search & Navigation Key\*
- 8 ■ Press Once to stop playback temporarily  
Press Twice to stop playback completely
- 9 ▼ Navigation Key\*
- 10 **NUM:** Press to toggle Number Mode ON/OFF (See Below)
- 11 >>> Fast Forward Search & Navigation Key\*
- 12 >>> Play/Pause a Disc : Confirm a Menu Choice\*
- 13 >>> Go to the Next chapter/track
- 14 ▲ Navigation Key\*
- 15 **ZOOM:** Enlarge Image on Screen
- 16 **MENU:** Enter/Leave a DVD root menu
- 17 **ANGLE:** Change the viewing angle/ Select a transition effect
- 18 **DISPLAY:** Display/Hide On Screen Display

### NUMBER AND FUNCTION MODES

Some function buttons are used to **input numbers**. Press the **NUM** button to activate the number functions.

In "**Number mode**" these function buttons are locked and the "NUM" icon appears and stays on the screen as a reminder.

To use the function buttons, press the **NUM** button again – the "NUM" icon disappears and normal functions are restored.

**To enter a number from 1 to 9 (say 7):** Enter 07. If you enter the number as 7 the player will wait for a second digit. If none is entered, after a period the player will play the chosen number. To enter numbers above 9: Enter **the number**.

### \*NAVIGATION KEYS

#### MENU MODE

- ▲ Move Up a Menu/Menu Choice
  - ▼ Move Down a Menu/Menu Choice
  - ▶ Move along a Menu/Menu Choice
  - ◀ Move Back in a Menu/Menu Choice
- ENTER** Confirm an Action

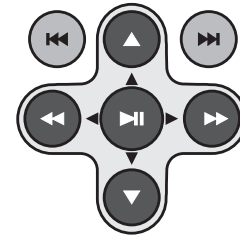

#### PLAY MODE

- <<< Previous Track/Chapter
- >>> Next Track/Chapter
- >>> Fast Forward Search
- <<< Fast Reverse Search

## POSITIONING THE PLAYER

Place the player on a firm level surface where it is unlikely to be knocked over or fall.

Do NOT operate the player on your knee or on the rear seat of a travelling vehicle as erratic movement will cause the player to skip tracks and may damage the disc and the player.

## HANDSET PREPARATION

Remove the safety strip from the battery compartment. The handset is now ready for use.

## BATTERY REPLACEMENT

If the handset behaves erratically or fails to operate the battery should be replaced.

- 1: Press the catch at the side of the battery compartment. Slide out the battery cage
- 2: Remove the old battery. Place the new battery in the cage with the polarity as shown. Close the cage.

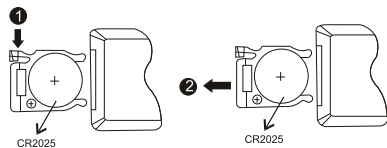

Observe all battery cautions on the Inside Front Cover.

## USING THE HANDSET

Point the handset directly at the infrared receiving window of the player. The handset must be no more than 3 metres from the player and at an angle of no more than 30° for reliable operation.

**Note:** If handset operation is erratic in bright sunlight, relocate the player to a shady location.

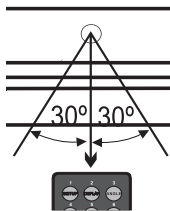

## CONNECTING THE DC ADAPTOR

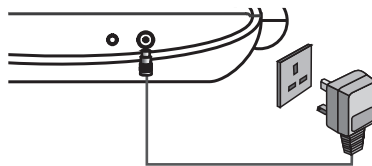

Connect the DC plug of the supplied adaptor into the Player. Plug the Adaptor into the mains point and switch on at the mains. The player is now ready for use.

If the player is not going to be used for a while, disconnect the adaptor from the player and the mains supply.

**CAUTION:** The means of disconnection from the mains supply is the adaptor. This must at all times be accessible and capable of being unplugged from the mains.

## PORTABLE OPERATION

If you want to use the player without mains power you will need to charge the battery. The battery should be recharged only when the player is switched off.

The amount of time taken to charge the battery depends on the amount of residual charge remaining but it could take up to eight hours.

When the battery is charging the light at the side of the player will glow RED. When the battery is fully charged the light will go out. You may now disconnect the mains adaptor.

### DURING BATTERY OPERATION:

If there is no display when the player is turned on:

*This is not a fault condition - but due to a flat battery.*

- Switch the player off, connect the charger as described above and charge the battery for six hours.

### When the battery is running out:

- After a short period the player will shut down.
- You must charge the battery as soon as possible.

### To conserve power:

- Always switch the player off when it is not connected to the adaptor or you will drain the battery.
- Follow all the care advice to keep your battery in good condition.



## GETTING STARTED

- Connect the supplied power adapter to the player. Plug the mains plug into the mains outlet and switch on the power.
- Hold the player with one hand. Hold the tab at the front of the player lid with the other hand and open the lid. The maximum angle you can open the player is 120°. Do not try to open it any further.
- Push the catch at the front of the player to open the disc lid.

- Switch the Player ON



- Load a disc into the tray, label side up. Align the centre of the disc with the centre of the disc guide. Press gently on the disc to snap it into place.
- Close the disc cover. The disc will now load. Some formats take more time to load than others as the player has to download the Table of Contents (TOC).

DVD discs will display the ROOT or TITLE menu. In exceptional cases where there is one title and nothing else the disc may play.

The ROOT menu is the basic menu of a DVD disc and contains all the information relating to the DVD disc. This menu loads when you first insert a disc. To access this menu at other times, press the MENU key. The TITLE shows the titles available on the DVD disc. On many DVDs the ROOT and TITLE menus are the same. Each TITLE is divided into CHAPTERS. So you can play all, or any part of the disc as you choose.



If you give the player an invalid command it will be ignored and a sign will flash on screen.

## PLAYING A DVD - BASIC OPERATION

**NOTE:** These operation instructions refer to handset operation. Basic functions are also available on the main player and can be executed by pressing the appropriate buttons. Refer to Page 4 for details.

### 1) To play a DVD disc from the beginning

Press **PLAY ►II** on the handset.

### 2) To change tracks when a DVD disc is playing

Press **NEXT ►►** to go forward one track at a time

Press **PREV ◀◀** to go back one track at a time

When you reach the final track you cannot go to the first track using NEXT .  
(Some DVDs will return you to the Title screen).

Press **PREV ◀◀** to go back through the tracks.

### 3) Fast Forward Playback

Press **►►** repeatedly

The speed cycles 2X → 4X → 8X → 16X → Normal

Press **PLAY ►II** (or OK) or cycle to Normal Speed to resume normal play



### 4) Fast Reverse Playback

Press **◀◀** repeatedly

The speed cycles 2X → 4X → 8X → 16X → Normal

Press **PLAY ►II** (or OK) or cycle to Normal Speed to resume normal play



### 5) To Pause a disc during Play:

Press **PLAY ►II** (or OK)

To resume: Press OK or **PLAY ►II**



## 6) Zoom:

Press ZOOM repeatedly

The picture size changes Q1 → Q2 → Q3 → OFF

*When Zoom is greater than 1:* use the ▲ ▼ ◀ ▶ keys to move the image around.

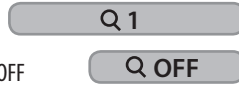

## 7) To alter the volume

Use the volume control on the player or remote monitor to alter the volume.

## 8) Stopping the Disc

The STOP ■ button has two modes.

When a disc is paused the disc may be stopped but the laser is active. If the disc is paused for too long the surface may burn. A special stop mode is available which stops the laser and the disc but memorises the position. When PLAY is next pressed the disc picks up where it left off.

Press STOP ■ on the handset or the player.



Press PLAY ▶ (or OK) to play from the point at which STOP was pressed.

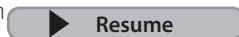

Press STOP ■ twice. The disc is now stopped.



Press PLAY ▶ (or OK) to play the disc.

**NOTE:** If there is no activity i.e the disc is stopped or no disc is loaded, after a few minutes the screen saver will appear.

**When you have finished:** remove the disc from the player before switching off.

If you are using the mains adaptor, unplug the adaptor from the player and then disconnect the adaptor from the mains or the vehicle power supply as appropriate.

## PLAYING A DVD - ADVANCED OPERATION

### ROOT AND TITLE MENUS:

- 1: Load a DVD disc.
- 2: To display the ROOT menu: Press MENU on the handset or the player.

The Root Menu displays the hierarchical structure of the DVD disc. If a disc is playing it will stop.

### CHECKING THE OPERATIONAL STATUS

An On Screen Display (OSD) status indicator will be displayed at the top of the TV screen when certain functions are executed, or when the DISPLAY button on the handset is pressed. When different discs are loaded the indicators may change. The On Screen Display can be configured to show the current title playing, the chapter being played and various time modes.

Press the DISPLAY key continuously to cycle the Display Modes:

Total Time Remaining on Disc	Time	00:14:34/01:39:45
Time Played On Disc	Time	00:14:34/01:39:45
Current Title/Total Titles	Title	3/3
Current Chapter /Total Chapters	Chapter	4/20
Languages and Channel Formats	Audio	1/3 <input checked="" type="checkbox"/> D 6 Ch Eng
	Subtitle	Off
	Angle	1/3
	Bitrate	3.92Mbps
		(OSD Off)

## Using the Number Keys

- To enter a number from 1 to 9, (say 7): Press NUM; Press 07
- To enter 10 to 99, (say 77): Press 77 and so on.
- Press NUM to leave Number Mode when you are finished.

## THE SEARCH FUNCTION

**During Play:** You can select a title, chapter, or time on the disc with a combination of the number and navigation keys.

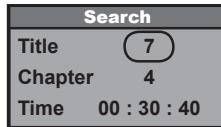

- Press the NUM key
- Enter a number at random (say 7):

The Search screen deploys

- **To select Title/Chapter/Time:** Use the the ▲ ▼ keys. The highlight moves to indicate the current selection.
- **To enter the wanted Title or Chapter number:** Use the ►►◀◀ keys
- **To directly enter the disc time:** Use the the ▲ ▼ keys to select **Time** Use the ►►◀◀ keys to highlight **Hr: Min: Sec.** Use the number keys to enter the tiime values.
- Press **PLAY ►||** (or **OK**) to confirm. The player will jump to the selection.
- Press the NUM key to leave number mode when you have finished

## Direct Selection From the ROOT Menu:

- Press **MENU**. The disc stops and displays the DVD menu. Enter a number. The player will usually go to the start of the chapter indicated by the number you enter. If there is more than one title on the disc, entering a number may take you to the title. Play begins immediately from the start of the selection.

## 'ON THE FLY' ADJUSTMENTS

The player's Setup menu contains system setups for Angle, Subtitle and Audio soundtrack but you may change them when a DVD disc is playing if the disc supports these features. The player returns to the system settings when you switch off the player or replace a disc.

## CHANGING THE AUDIO SETTINGS OF A DVD

You can select a language and audio format from those included on the DVD disc.

- Press **AUDIO** repeatedly. The choices will cycle:

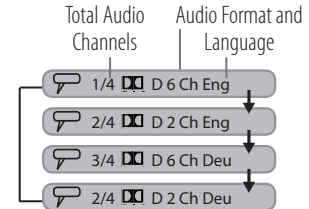

First the Audio Formats  
Then the Languages

After you have entered the selection, the program will play with the new settings.

## SELECTING SUBTITLES

Repeatedly press **SUB** to choose a supported language

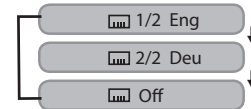

## CHANGING THE CAMERA ANGLE

**During playback of a DVD disc:**

Press **ANGLE** repeatedly to select the camera angle. A disc may contain 9 angles.



## REPEAT PLAY

Pressing REPEAT will:

- A: Repeat a Chapter continuously
- B: Repeat a Title continuously
- C: Repeat thr Disc continuously
- D: Cancel REPEAT

Repeat Chapter

Repeat Title

Repeat Disc

Repeat Off

## REPEATING A CHOSEN PASSAGE (A-B Repeat)

- Press **A-B** at the start of the selection (point A)
- Press **A-B** at the end of the selection (point B)

The disc will repeat the passage continuously

- Press **A-B** to return to normal play

Rep A-

Rep A- B

Rep AB Off

## LAST MEMORY

To enable Last Memory:

- At the desired place, press **STOP** ■

Stop

Do not press **STOP** a second time, or switch the player off or load a different disc otherwise the player will lose its settings!

- Open the player disc compartment. Remove the disc.
- Re-load the disc.

Last Memory

The disc will load and play from the point where you stopped. The words “**Last Memory**” will briefly appear on the screen.

To use this facility “**Last Memory**” must be enabled in the System Settings Menu - see Page17

## PLAYING AN AUDIO CD

Load an Audio CD into the player. The player reads the disc. Most CDs will start automatically - a very few won't.

### CD Display

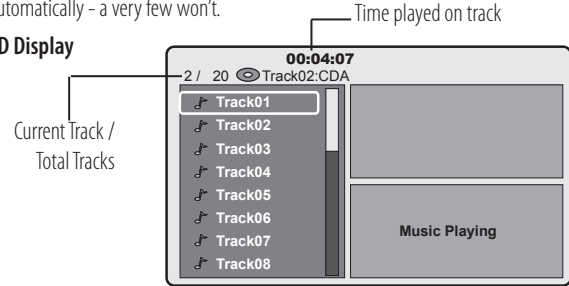

1) To play an entire disc from the beginning when it is stopped:

- Press **PLAY** ►|| (or OK)

2) To change tracks when a disc is playing

- Press ►►| ◀◀ to go forward/back one track at a time

When you reach the final track you cannot go to the first track using ►►|.

- Press ◀◀ to go back through the tracks.

3) Forward and Reverse Search

- Press ◀◀ ►► repeatedly: The speed cycles 2X → 4X → 8X → 16X → Normal
- Press **PLAY** ►|| (or OK) or cycle to Normal Speed to resume normal play.

4) Pausing a disc

- Press || or ►|| on the player.
- Press **PLAY** ►|| (or OK) to resume normal play.

### 5) Stopping and re-starting a disc

- Press ■.
- Press **PLAY ►II** (or **OK**) to resume play from where the disc was stopped.
- **To completely stop a disc:** Press ■ twice.

### 6) Selecting and playing a track

- Press ▲▼ to move up/down the track list and select a track. The highlight will move to a new track with each press. The currently playing track will be 'greyed out'
- Press **PLAY ►II** (or **OK**) to play from the track.
- Inputting the wanted track via the number keys will also start play from the selected track.

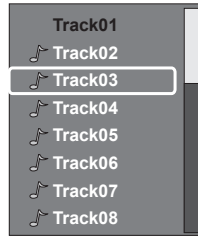

*(Remember to enable the number keypad before entering a number and return to normal handset mode after you have finished)*

### 7) Repeat

- Press **REPEAT** once to repeat the track.
- Press **REPEAT** again to repeat all tracks.
- Press **REPEAT** again to cancel repeat.

Repeat Single

Repeat Folder

Repeat Off

### 8) A-B Repeat

- Press **A-B** at the start of the selection (point A)
- Press **A-B** at the end of the selection (point B)
- Press **A-B** to return to normal play

Rep A-

Rep A- B

Rep AB Off

## PLAYING A JPG DISC

Load a JPG disc

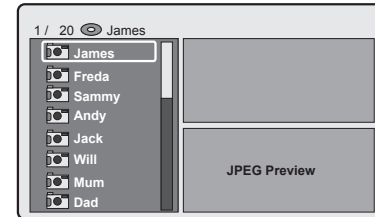

A JPG disc may contain pictures only or may have one or more folders with pictures within the folders.

### VIEWING JPGS

- Press ▲ or ▼ to highlight a **picture**.
- Press **PLAY ►II** (or **OK**) **or** enter a number via the number keypad. All the pictures not in folders will play as a slide show from that point forward.
- Press **PLAY ►II** (or **OK**) to pause and re-start the slide show.
- Press ◀◀/▶▶ to move to the previous/next image.

**Rotating A Picture:** (When a picture is rotated the slide show is paused).

- Press ▼ to continuously rotate a picture 90° to the right.
- To resume normal play, press **PLAY ►II** twice **or** cycle to normal orientation

**Zoom:** (When a picture is zoomed the slide show is paused).

Press **ZOOM** repeatedly: The picture size changes **Q1→Q2→Q3→OFF**

**When Zoom is greater than 1:** use the ▲▼◀▶ keys to move the picture around.

- To resume normal play, press **PLAY ►II** twice **or** cycle to Zoom off.

## THUMBNAIL VIEW

Press **MENU** at any time. The images display in THUMBNAILS of 9 images per screen.

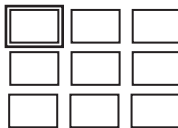

- Press **▲** or **▼** to up or down a row
- Press **◀▶** to move along a row
- Press **PLAY ▶II** (or **OK**) to start the slideshow from the selected picture.

## ALTERING SLIDE SHOW TRANSITION EFFECTS

During a Slide Show (in play or pause mode): Press **ANGLE** repeatedly to choose one of 20 available transition effects (or no effect). This setting alters the way one picture flows into the next during a slide show.

## REPEAT MODE

You can select **Repeat Single**, **Folder Repeat** or **Repeat OFF**

*Repeat Single*- Repeat one file continuously

*Repeat Folder*- Repeat the contents of a folder continuously.

If you have a combination of files, some in folders and some on the main disc drive (Root) you can repeat files in individual folders or files on the disc drive proper but **NOT** the entire disc.

To return to the main screen:

- Press **■** in slide show, or thumbnail mode:

The current folder displays. *If there are no folders the pictures on the disc will display.*

- Select a picture. Press **PLAY ▶II** (or **OK**) to start a new slide show

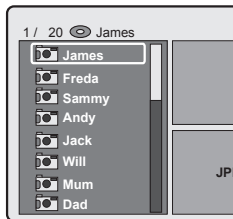

## PLAYING FOLDERS

Load a JPG disc into the player. The main screen will appear

- Press **▲▼** to select a folder

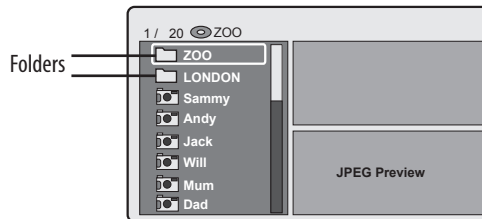

- Press **PLAY ▶II** (or **OK**). The pictures in the folder will display

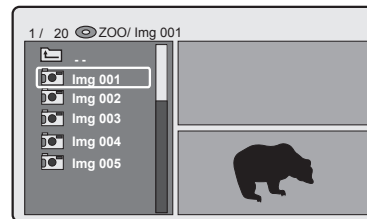

- Select a picture and press **PLAY ▶II** (or **OK**) to start the slide show
- Proceed as before to view and manipulate your pictures

When the last picture has displayed the slide show will stop and the Folder Menu will display

- At any time, pressing the **■** key also returns you to the Folder Menu



To select another folder

- Press **▲** to highlight the top line
- Press **PLAY ►II** (or **OK**)

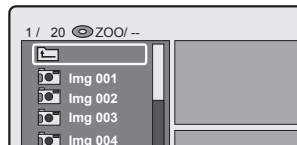

The main menu will display



To exit:

- Press the Open button to open the disc compartment.
- Allow the disc to stop spinning before removing it.

## PLAYING XviD VIDEO DISCS

XviD is an open source compressed video format. Most XviD files will play; other video files may be recognised by the player but will not play.

Load a disc: The main menu will display,

- Press the **▲▼** keys to highlight an XviD track, or select a track with the number keys.
- Press **PLAY ►II** (or **OK**).



The disc will play from the selected track. If an unplayable track is in the list the player will move to the next playable track. When all the tracks have played the disc stops. (This depends on the repeat mode - modes are the same as JPEG play).

During play:

Zoom, next/previous track, direct track select and forward/reverse search operate. Subtitles are selectable if the file supports them.

Press the **DISPLAY** key continuously to cycle the Display Modes:



**Note:** Although XviD files use the MP3 format for audio, regular MP3 files cannot be played on this player.

**To stop play:** Press **■** once. The menu screen will deploy.

- Press **PLAY ►II** (or **OK**) to resume play (see Last Memory)
- Press **■** twice to fully stop play.

**To exit:** Press the Open button. Allow the disc to stop before removing it.

## CUSTOMISING PLAYER SETTINGS

Always access the SETUP menu when the player is FULLY stopped or when there is no disc in the drawer.

- Press **SETUP** to enter the Setup menu. The setup menu has 4 categories: **Language: Video: Rating: and Misc.**

- Press **▲** or **▼** to move up and down a menu list
- Press **▶▶** or **◀◀** to take you to the next/previous menu list
- Press **▶||** to confirm your selection.

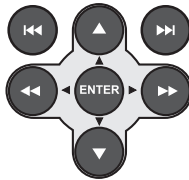

- Press **SETUP** at any time to leave the Setup menu. **If you are in the middle of a procedure any change will be discarded.**

**LANGUAGE SETUP:** This is the language used in on screen displays.

- Press **SETUP** to enter Setup. The Setup Menu deploys.

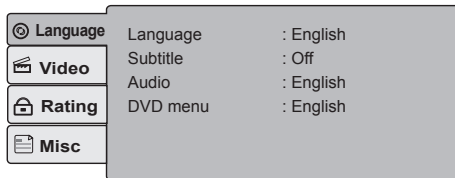

- Press **▶▶** to highlight "Language".

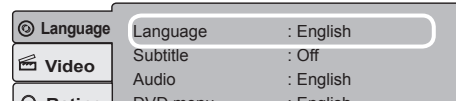

Press **▶||** to confirm. The current selection is highlighted.

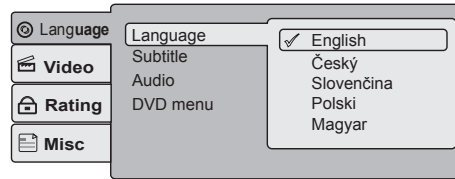

- Press **▲** or **▼** to move up and down the list. The highlight will move but the tick mark indicating the current selected value will stay in place.
- Press **▶||** to confirm. The screen will change to the new language.

**Use the same procedure to change the other parameters.**

**SUBTITLE:** Default is OFF (no subtitles). You can select English or if there is a non English speaker in your house you may want to select another language.

**AUDIO:** The language you want the film to be in. Default is English.

**DVD MENU:** The language in which film menus display. Default is English.

**When you have made the changes:**

- Press **◀◀** to return to the Setup Menu
- Press **▲** or **▼** to select **Rating** or **Misc.** OR
- Press **SETUP** to leave the Setup menu.



## VIDEO SETUP

- Press **SETUP** to enter Setup. Press **or ▼** to move to the VIDEO page
- Press **▶▶** to highlight "Aspect Ratio"

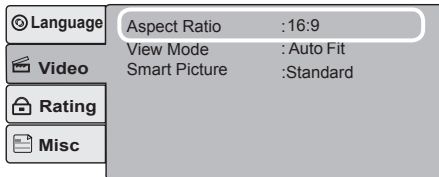

- Press **▶▶** to confirm your selection.

**ASPECT RATIO:** This is the relationship between the player and the TV.

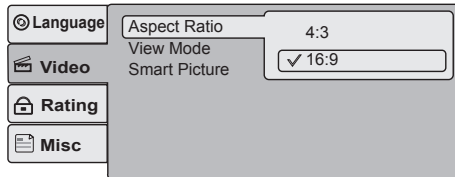

The default is 16:9 (Widescreen). The alternative is 4:3 S(andard).

**Note:** A picture recorded in standard 4:3 format always displays in 4:3 aspect ratio.

A DVD recorded in 16:9 wide format will be compressed if the (external) TV is a standard 4:3 screen A DVD recorded in a special format will apply that format.

Press **▲ or ▼** to select the parameter

- Press **▶▶** to confirm and return to the Video Menu..

**VIEW MODE:** This determines to what extent the DVD picture fits the Screen

- Press **▲ or ▼** to select View Mode; Press **▶▶**.

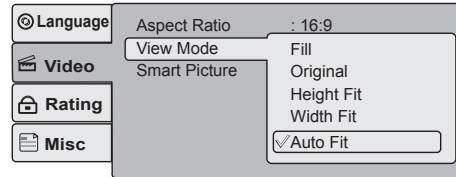

**Fill:** The picture fills the screen. This may result in "picture cropping" on 4:3 screens

**Original:** Choose this mode and the picture will appear in its original size.

**Height fit :** Fit the picture height to the screen. The sides of the picture may be cropped

**Width fit :** Fit the picture width to the screen. The top and bottom of the picture may be cropped

**Auto Fit:** (Default Option) In this mode the picture displayed on screen will fit the screen. This may result in "picture cropping" on 4:3 screens.

- Press **▲ or ▼** to select the parameter
- Press **▶▶** to confirm and return to the Video Menu.

## SMART PICTURE

- Press ▲ or ▼ to select TV System: Press ►||

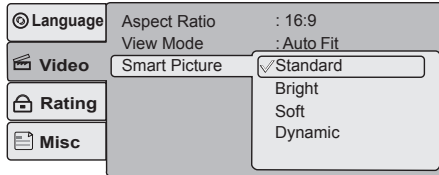

Smart Picture enables you to provide personalised image settings.

**Standard:** This is the default setting.

Other settings can be chosen to enhance the program experience, e.g Dynamic for sport and action movies and so on.

- Press ▲ or ▼ to select the parameter
- Press ►|| to confirm and return to the Video Menu.
- Press ◀ to return to the main menu or SETUP to exit completely.

## THE RATINGS PAGE

This menu enables you to set age restrictions on certain DVD discs (see Page 2).

- Press SETUP to enter Setup. Press ▼ to move to the RATING page.

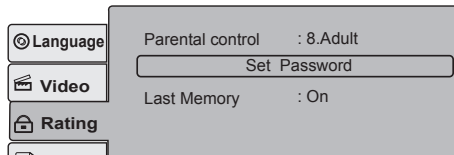

- Press ► to highlight "Parental Control" Press ►||

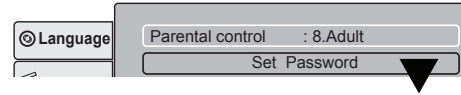

You will be prompted to enter the password. The default password is 9653. *ONLY If the password is accepted will the rating will be changed.*

- Enter 9653
- Press ►||

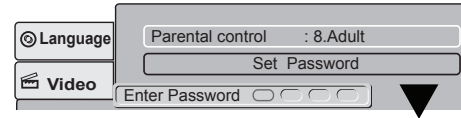

The message "Correct Password" appears briefly and the screen reverts to:

- Press ►||

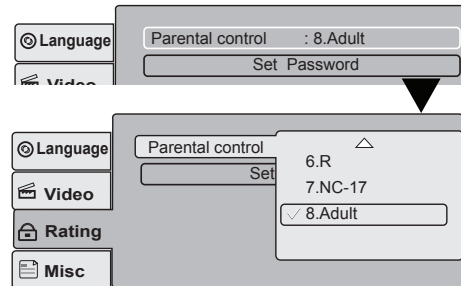

- Press ▲ or ▼ to select a rating following the guide on Page XX
- Press ►|| to confirm.

## CHANGING THE PASSWORD

- Press ▲ or ▼ to highlight 'SET PASSWORD': Press ► to confirm.

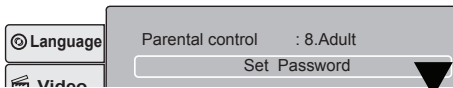

You will be prompted to enter the password. The default password is 9653

- Enter 9653
- Press ENTER

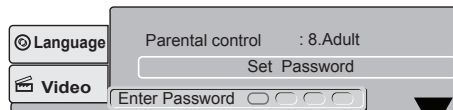

The message "Correct Password" appears briefly and the screen changes to

- Press ►

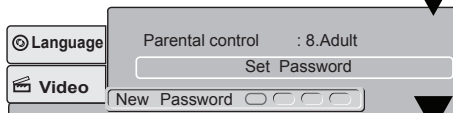
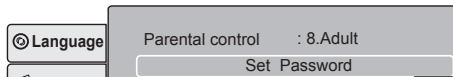

- Enter the new 4 digit password. Press ►
- Confirm the new password : Press ►

The message "Set Password Successful" appears briefly and the screen reverts to:

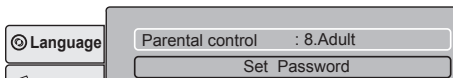

- Press ◀ to return to the main menu or SETUP to exit completely.

**Note:** The default password 9653 is operative even after you change the password.

## LAST MEMORY

- Press ▲ or ▼ to highlight 'LAST MEMORY':
- Press ► to confirm.

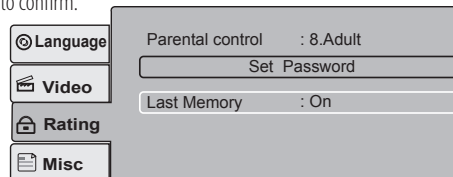

- Press ▲ or ▼ to highlight 'Off or On': Press ► to confirm.

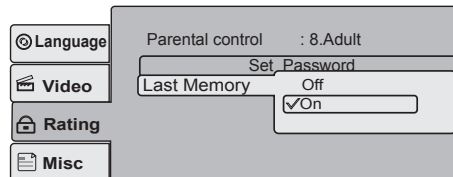

Setting ON enables the LAST MEMORY functionality. Refer to Page 10.

### When you have made the changes:

- Press ◀ to return to the Setup Menu
- Press ▲ or ▼ to select Language: Video: Rating: or Misc. OR
- Press SETUP to leave the Setup menu.

## MISCELLANEOUS SETUP ITEMS

- Press **SETUP** to enter Setup. Press **▼** to move to the Misc page
- Press **▶** to highlight "Use Default Settings"

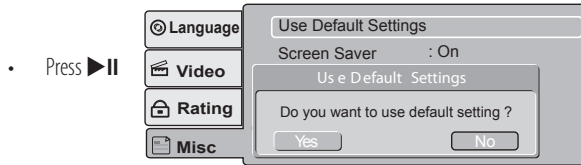

- Press **◀** or **▶** to select Yes/No.
- Press **▶** to confirm

**If you select "YES":** The screen will go blank and reset to system defaults. The system will then re-boot.

A user-set password and any ratings settings will NOT be changed.

**If you select "NO":**

The screen will revert to the Misc page.

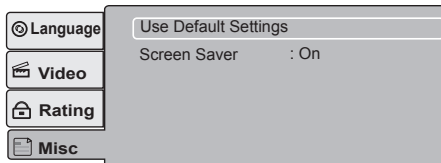

## SCREEN SAVER

Even if you are using a TFT screen we advise you to use the screen saver.

- Press **▲** or **▼** to highlight "Screen Saver"
- Press **▶** to confirm

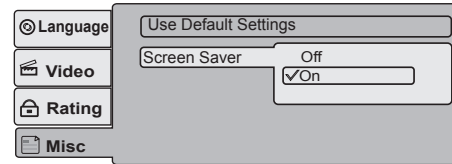

- Press **▲** or **▼** to highlight 'Off or On:
- Press **▶** to confirm
- Press **▲** or **▼** to select Language: Video: Rating: or Misc. OR
- Press **SETUP** to leave the Setup menu.

## TROUBLESHOOTING

If your DVD player is not working properly use this guide before contacting Tesco. Before investigating a problem, always switch off the player and any connected units.

SYMPTOM	CORRECTIVE ACTION
No power	Check if the power adapter is connected securely.
No Sound/ Distorted sound	Is the volume control turned up? In battery operation, battery running down.
No sound or picture	(In battery operation) - flat battery. Connect AC adapter
Interference or scrolling	Due to the effect of copy protection on the disc Avoid connecting to a recorder or TV/VCR combination.
Disc will not play Disc skips Disc Distorts	The DVD+RW you played should be finalized. Ensure the disc is correctly inserted. Make sure the disc is free from scratches & marks. Insert a playable disc. (Check disc type and system). Is the disc Region 2? Clean the disc. Cancel or change the parental lock level
No forward or reverse scan	Some discs prohibit rapid scanning or title and chapter skip. You can't advance through the opening credits and warning information at the beginning of movies.
Handset erratic/ inoperative	Point the handset at the player not the screen! Flat battery, distance too far from player or Handset too far from player or obstructed.

## AFTER USING YOUR PLAYER

- Remove the disc from the tray
- Close the player lid securely
- Unplug the adapter and coil the cables
- Store the player and accessories securely, away from sources of heat and damp and out of the reach of children and pets.

**NEVER store the player with the lid open!**

## CARE AND CLEANING

Occasionally wipe the player with a lint free duster. Never clean the player with liquids or solvents.

Do NOT clean the inside of the player tray with a cloth. Lightly blow out any dust. If your discs skip or don't play properly, this is more likely to be caused by damage or dirt on the disc rather than any fault of the unit.

Clean the screen from time to time with a approved anti-static cleaner. NEVER wipe the screen with a tissue. Use a Calotherm cloth available from opticians.

## CARE OF DISCS

DVD discs are fragile. Treat them with care. Always store them upright in their packing; away from direct sunlight, heat and damp.

When handling discs, hold the disc's outer edge and/or the centre spindle hole. Do not touch the disc surface. Never bend or flex a disc.

Clean the disc surface with a soft, dry cloth. Wipe the disc surface gently, radially, from centre toward the outer edge. Never apply solvents to the surface of a disc.

## SPECIFICATIONS

Compatible discs:	DVD/CD
Signal system:	Player NTSC; Video Out PAL
Panel size:	7 inch
Frequency response:	20 Hz to 20 kHz
Video output:	1 Vp-p/75 Ohm, unbalanced
Audio output:	1.4Vrms/10kOhm
Audio S/N:	Better than 50 dB
Dynamic range:	Better than 80 dB
Laser:	Semiconductor, Wavelength: 650 nm/795 nm
Power source:	DC 9 V (via AC/DC adapter)
Power consumption:	<10 W
Operating temp:	5~40°C
Weight:	0.698 kg
Dimensions	203 x 157 x 43 mm (W x D x H)
Battery Type:	Li Polymer

CE

## WARRANTY

Your Technika appliance is covered by a warranty for 12 months from the date of purchase. If a fault develops during this period, please contact the TESCO electrical help line on 0845 456 6767. Please have your original purchase receipt with you when you call. This warranty in no way affects your consumer rights,



**UK:** Waste electrical products should not be disposed of with household waste. Separate disposal facilities exist, for your nearest facilities. See [www.recycle-more.co.uk](http://www.recycle-more.co.uk) or in-store for details.

**ROI:** Produced after 13th August 2005. Waste electrical products should not be disposed of with household waste. Please recycle where facilities exist. Check with your Local Authority or retailer for recycling advice.

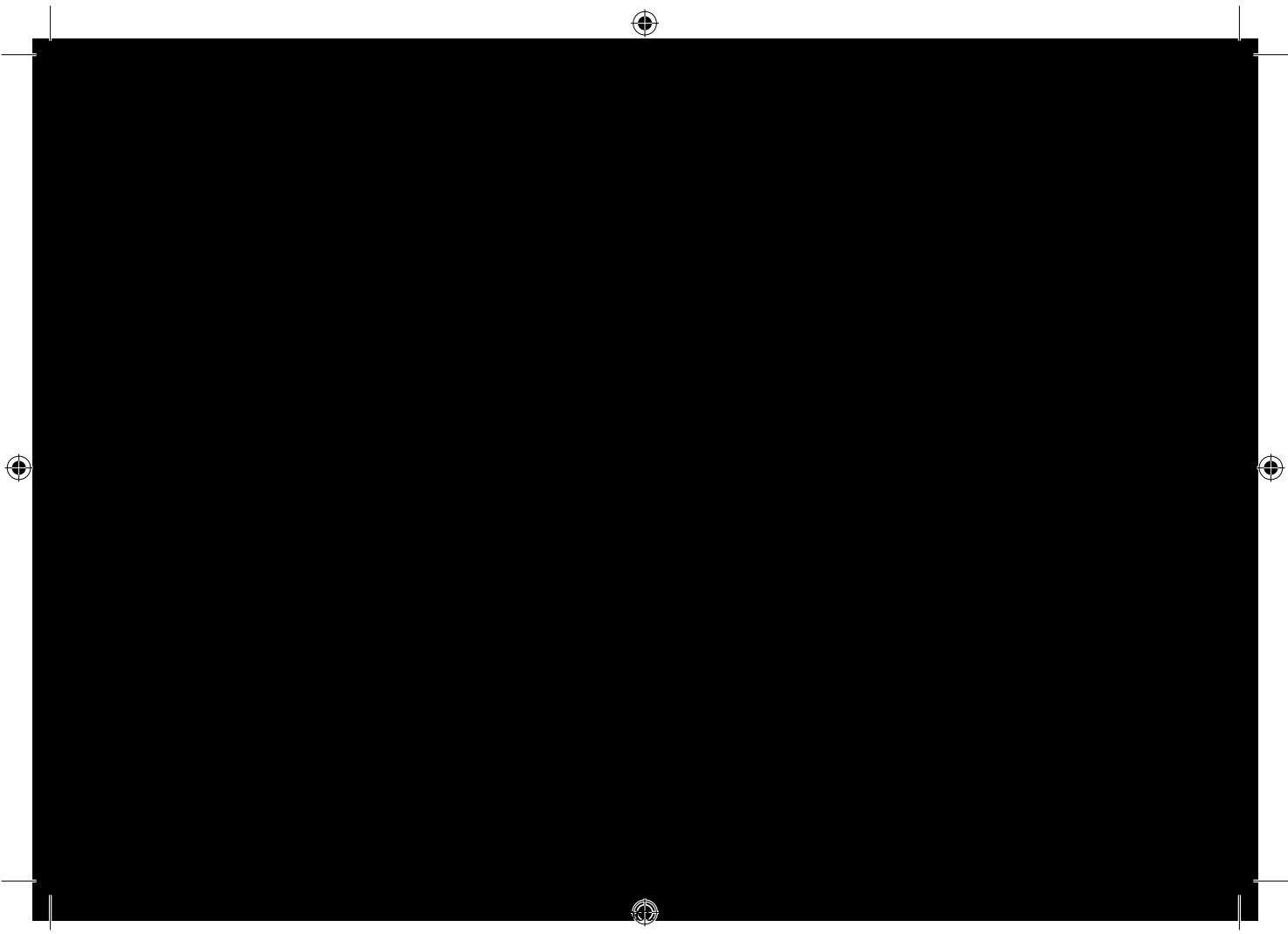





# Technika

Tesco Stores Ltd,  
Delamare Road, Cheshunt, Herts, EN8 9SL

▶ **Technika Helpline: 0845 456 6767** (Calls cost up to 4p per minute from a BT landline, other providers may vary)





## Free Manuals Download Website

<http://myh66.com>

<http://usermanuals.us>

<http://www.somanuals.com>

<http://www.4manuals.cc>

<http://www.manual-lib.com>

<http://www.404manual.com>

<http://www.luxmanual.com>

<http://aubethermostatmanual.com>

Golf course search by state

<http://golfingnear.com>

Email search by domain

<http://emailbydomain.com>

Auto manuals search

<http://auto.somanuals.com>

TV manuals search

<http://tv.somanuals.com>