

# User Manual

**Tektronix**

**VM700T Video Measurement Set  
Option 01 NTSC Measurements**

**070-9648-00**

Copyright © Tektronix, Inc. All rights reserved. Licensed software products are owned by Tektronix or its suppliers and are protected by United States copyright laws and international treaty provisions.

Use, duplication, or disclosure by the Government is subject to restrictions as set forth in subparagraph (c)(1)(ii) of the Rights in Technical Data and Computer Software clause at DFARS 252.227-7013, or subparagraphs (c)(1) and (2) of the Commercial Computer Software – Restricted Rights clause at FAR 52.227-19, as applicable.

Tektronix products are covered by U.S. and foreign patents, issued and pending. Information in this publication supercedes that in all previously published material. Specifications and price change privileges reserved.

Printed in the U.S.A.

Tektronix, Inc., P.O. Box 1000, Wilsonville, OR 97070-1000

TEKTRONIX and TEK are registered trademarks of Tektronix, Inc.

Portions of the software in this instrument are copyrighted by Stanford University.

# Table of Contents

## Getting Started Measure Mode

Preface .....	ix
Bar LineTime .....	2-3
Bar LineTime Menu .....	2-4
Bounce .....	2-9
Bounce Menu .....	2-11
Typical Measurement Results .....	2-15
Burst Frequency .....	2-16
Burst Frequency Menu .....	2-17
Setting the Reference Burst Frequency .....	2-18
ChromLum GainDelay .....	2-19
ChromLum GainDelay Menu .....	2-20
Chrominance AMPM .....	2-24
Chrominance AMPM Menu .....	2-25
Chrominance FreqResp .....	2-29
Chrominance FreqResp Menu .....	2-30
Chrominance NonLinearity .....	2-35
Chrominance NonLinearity Menu .....	2-36
ColorBar .....	2-40
Predefined ColorBar References .....	2-41
ColorBar Menu .....	2-41
DGDP (Differential Gain Differential Phase) .....	2-46
DGDP Display .....	2-46
DGDP Menu .....	2-47
GroupDelay SinX_X .....	2-51
GroupDelay SinX_X Menu .....	2-53
H_Blank .....	2-59
H_Blank Display .....	2-59
H_Blank Menu .....	2-60
H_Timing .....	2-61
H_Timing Menu .....	2-61
ICPM (Incidental Carrier Phase Modulation) .....	2-63
ICPM Display .....	2-63
ICPM Menu .....	2-65
Jitter .....	2-69
Jitter Menu .....	2-70
Jitter Long_Time .....	2-71
Jitter Long_Time Menu .....	2-72
K_Factor .....	2-74

K_Factor Menu .....	2-75
Defining Your Own Graticule .....	2-81
Level Meter .....	2-83
Level Meter Display .....	2-83
Level Meter Main Menu .....	2-84
Setting Up a New Measurement Window .....	2-93
Line Frequency .....	2-94
Line Frequency Menu .....	2-94
Luminance NonLinearity .....	2-96
Luminance NonLinearity Menu .....	2-97
MultiBurst .....	2-101
MultiBurst Menu .....	2-102
Noise Spectrum .....	2-107
Noise Spectrum Menu .....	2-107
SCH_Phase .....	2-113
SCH Phase Measurement .....	2-114
Dual SCH Phase Measurements .....	2-114
SCH_Phase Menu .....	2-115
ShortTime Distortion .....	2-119
ShortTime Distortion Main Menu .....	2-120
Defining Your Own Graticule .....	2-124
TwoField .....	2-126
TwoField Menu .....	2-127
VITS_ID .....	2-131
VITS ID Menu .....	2-132
V_Blank .....	2-133
V_Blank Menu .....	2-135
Video Standard .....	2-136

## Auto Mode

Input Signals .....	3-1
Test Signal Locations .....	3-1
Measurement Methods .....	3-2
APL .....	3-2
Peak Carrier and Zero Carrier Pulse .....	3-2
Bar Amplitude, Blanking Level, Bar Top, and Sync Amplitude .....	3-2
Blanking Variation and Sync Variation .....	3-3
Burst Amplitude .....	3-4
FCC Horizontal Blanking Interval Timing Measurements .....	3-4
RS-170A Horizontal Blanking Interval Timing Measurements .....	3-5
V Blank 4 IRE F1 and V Blank 4 IRE F2 .....	3-6
V Blank 20 IRE F1 and V Blank 20 IRE F2 .....	3-7
FCC Equalizer and FCC Serration .....	3-7
RS-170A Equalizer and RS-170A Serration .....	3-8

VIRS Measurements .....	3-8
Line Time Distortion and Pulse-to-Bar Ratio .....	3-9
2T Pulse K-factor and IEEE-511 ST Dist .....	3-10
S/N Measurements .....	3-10
Chroma-Lum Delay and Chroma-Lum Gain .....	3-12
Differential Gain, Differential Phase, Luminance Nonlinearity, Relative Burst Gain, and Relative Burst Phase .....	3-13
Multiburst Measurements .....	3-14
NTC-7 20 IRE Chroma, NTC-7 80 IRE Chroma, NTC-7 Chr NL Phase, NTC-7 Chr-Lum Intmd .....	3-15
ICPM .....	3-16
SCH Phase .....	3-17
Field Time Distortion .....	3-18
FCC Color Bars .....	3-18

## Appendices

<b>Appendix A: NTSC Measurement Specifications .....</b>	<b>A-1</b>
Measure Mode .....	A-1
Auto Mode .....	A-7

## Index

## List of Figures

Figure 2-1: Bar LineTime display .....	2-3
Figure 2-2: Bar LineTime menu tree .....	2-5
Figure 2-3: Bar LineTime Special Position display .....	2-7
Figure 2-4: Bounce Measurement display .....	2-9
Figure 2-5: Bounce menu tree .....	2-11
Figure 2-6: Burst Frequency display .....	2-16
Figure 2-7: Burst Frequency menu tree .....	2-17
Figure 2-8: ChromLum GainDelay display .....	2-19
Figure 2-9: ChromLum GainDelay menu tree .....	2-20
Figure 2-10: ChromLum GainDelay Special Position display .....	2-22
Figure 2-11: Chrominance AMPM display .....	2-24
Figure 2-12: Chrominance AMPM menu tree .....	2-26
Figure 2-13: Chrominance FreqResp display .....	2-29
Figure 2-14: Chrominance FreqResp menu tree .....	2-30
Figure 2-15: Chrominance FreqResp Special Position display .....	2-34
Figure 2-16: Chrominance NonLinearity display .....	2-35
Figure 2-17: Chrominance NonLinearity menu tree .....	2-36
Figure 2-18: Chrominance NonLinearity Special Position display .....	2-38
Figure 2-19: ColorBar display .....	2-40
Figure 2-20: ColorBar menu tree .....	2-42
Figure 2-21: ColorBar Special Position display .....	2-45
Figure 2-22: DGDP display .....	2-46
Figure 2-23: DGDP menu tree .....	2-47
Figure 2-24: DGDP Special Position display .....	2-49
Figure 2-25: GroupDelay SinX_X Combined Pulse response display ...	2-51
Figure 2-26: GroupDelay SinX_X BothPulse response display .....	2-52
Figure 2-27: GroupDelay SinX_X menu tree .....	2-53
Figure 2-28: GroupDelay SinX_X Special Position display .....	2-57
Figure 2-29: H_Blank display .....	2-59
Figure 2-30: H_Blank menu tree .....	2-60
Figure 2-31: H_Timing display .....	2-61
Figure 2-32: H_Timing menu tree .....	2-61
Figure 2-33: ICPM display; no ICPM errors present .....	2-64
Figure 2-34: ICPM display; large ICPM error present .....	2-65
Figure 2-35: ICPM menu tree .....	2-66
Figure 2-36: Jitter display .....	2-69
Figure 2-37: Jitter menu tree .....	2-70
Figure 2-38: Jitter Long_Time spectrum display .....	2-71
Figure 2-39: Jitter Long_Time waveform display .....	2-72
Figure 2-40: Jitter Long_Time menu tree .....	2-72

Figure 2-41: K-Factor display with top level menu .....	2-74
Figure 2-42: K_Factor menu tree .....	2-75
Figure 2-43: K_Factor measurement right reference clamped .....	2-77
Figure 2-44: K-Factor Special Position display .....	2-80
Figure 2-45: Make Graticule display with lower graticule selected .....	2-81
Figure 2-46: Level Meter display .....	2-83
Figure 2-47: Level Meter menu tree .....	2-85
Figure 2-48: Display Limits menu showing undefined measurement points .....	2-86
Figure 2-49: Measure Position display to locate the measurement points on a signal .....	2-87
Figure 2-50: Display Position with measurement referenced to 100 IRE as 100% .....	2-91
Figure 2-51: Level Meter display as a result of the setup shown in Figure 2-50. ....	2-92
Figure 2-52: Line Frequency display .....	2-94
Figure 2-53: Line Frequency menu tree .....	2-94
Figure 2-54: Luminance NonLinearity display .....	2-96
Figure 2-55: Luminance NonLinearity menu tree .....	2-97
Figure 2-56: Luminance NonLinearity Special Position display .....	2-99
Figure 2-57: MultiBurst display .....	2-101
Figure 2-58: MultiBurst menu tree .....	2-102
Figure 2-59: MultiBurst Special Position display .....	2-105
Figure 2-60: Noise Spectrum display .....	2-107
Figure 2-61: Noise Spectrum menu tree .....	2-108
Figure 2-62: Noise Spectrum Input Gate display .....	2-111
Figure 2-63: Timing relationships for SCH_Phase measurements and Sync Relative Timing and Burst Relative Phase measurements .....	2-113
Figure 2-64: SCH_Phase display .....	2-114
Figure 2-65: Dual SCH display with Burst Relative Phase and Sync Relative Timing bar graphs .....	2-115
Figure 2-66: SCH_Phase menu tree .....	2-116
Figure 2-67: SCH_Phase full-field display .....	2-117
Figure 2-68: Rescaled SCH_Phase full-field display .....	2-118
Figure 2-69: ShortTime Distortion display .....	2-119
Figure 2-70: ShortTime Distortion menu tree .....	2-121
Figure 2-71: ShortTime Distortion Special Position display .....	2-123
Figure 2-72: Make Graticule display with inner graticule selected .....	2-125
Figure 2-73: TwoField display .....	2-126
Figure 2-74: TwoField menu tree .....	2-127
Figure 2-75: TwoField Special Position display .....	2-129
Figure 2-76: VITS_ID signal ID display .....	2-131
Figure 2-77: VITS ID full VITS waveform display .....	2-132

Figure 2-78: VITS ID menu tree .....	2-132
Figure 2-79: V_Blank full display .....	2-133
Figure 2-80: V_Blank equalizer pulse display .....	2-134
Figure 2-81: V_Blank serration pulse display .....	2-134
Figure 2-82: V_Blank V-sync display .....	2-135
Figure 2-83: V_Blank menu tree .....	2-135



## List of Tables

Table 2-1: Measure Mode Measurements .....	2-1
Table 2-2: Predefined ColorBar Reference Values .....	2-41
Table 3-1: Measurement Locations file defaults .....	3-1
Table A-1: Bar Line Time .....	A-1
Table A-2: Bounce .....	A-2
Table A-3: Burst Frequency .....	A-2
Table A-4: Chrominance-to-Luminance Gain and Delay .....	A-2
Table A-5: Chrominance Frequency Response .....	A-2
Table A-6: Chrominance Noise .....	A-2
Table A-7: Chrominance Non-Linearity .....	A-3
Table A-8: ColorBar .....	A-3
Table A-9: SMPTE Color Bar Nominal Values .....	A-3
Table A-10: Differential Gain and Phase .....	A-3
Table A-11: Frequency Response and Group Delay .....	A-3
Table A-12: Horizontal Blanking .....	A-4
Table A-13: Horizontal Timing .....	A-4
Table A-14: Incidental Carrier Phase Modulation .....	A-4
Table A-15: Jitter .....	A-4
Table A-16: K-Factor .....	A-5
Table A-17: Level Meter .....	A-5
Table A-18: Line Frequency .....	A-5
Table A-19: Luminance Non-Linearity .....	A-5
Table A-20: Multiburst .....	A-5
Table A-21: Noise Spectrum .....	A-5
Table A-22: SCH Phase .....	A-6
Table A-23: Short Time Distortion .....	A-6
Table A-24: TwoField .....	A-6
Table A-25: VITS ID .....	A-6
Table A-26: Vertical Blanking .....	A-6
Table A-27: RS-170A Horizontal Blanking Interval Timing .....	A-7
Table A-28: RS-170A Vertical Blanking Interval .....	A-7
Table A-29: FCC Horizontal Blanking Interval Timing .....	A-7
Table A-30: FCC Vertical Blanking Interval Timing .....	A-8
Table A-31: Amplitude and Phase Measurements .....	A-8
Table A-32: Frequency Response Measurements .....	A-9
Table A-33: Incidental Carrier Phase Modulation .....	A-9
Table A-34: Color Bar Measurements .....	A-9
Table A-35: Out-of-Service Measurements .....	A-9
Table A-36: Waveform Distortion Measurements .....	A-9
Table A-37: VIRS Measurements .....	A-10
Table A-38: Signal-to-Noise Ratio Measurements .....	A-10



# Preface

The VM700T Video Measurement Set Option 01 (NTSC Measurements) gives you access to the complete set of measurements available for NTSC standard video signals.

The manual contents are arranged in the following order:

*Getting Started* provides a brief overview of Measure mode and Auto mode measurement operation. Refer to the *VM700T Option 01 & Option 11 User Manual* for more complete operating instructions for the VM700T Video Measurement Set.

*Measure Mode* provides the detailed operation of each of the Measure mode measurements in alphabetical order of the measurement's name.

*Auto Mode* provides a description of the Auto mode measurements and details the analysis methods for each Auto mode measurement that the VM700T Video Measurement Set is capable of making.

*Appendix A: NTSC Measurement Specifications* provides tables giving the measurement accuracy and range of the Measure mode and Auto mode measurements.





# Getting Started



# Getting Started

The VM700T Option 01 (NTSC) gives you access to a large variety of interactive (Measure mode) and automatic (Auto mode) measurements.

Measure mode measurements are user-selectable, interactive, graphical applications that make measurements on video signals. The *Measure Mode* section of this manual, describes each Measure mode measurement.

Pressing the Measure button on the VM700T front panel displays the names of available measurement groups: VM700 Diagnostics, Video Measurements, Video Options, and Audio Options (if options are available). When one of the measurement groups has been selected, the available measurements in that group are displayed.

Rotating the control knob scrolls the Measure mode display to show more measurements.

Touching the name of a measurement in the Measure mode display begins execution of that measurement.

Pressing any major mode button (for example, Waveform, Vector, Picture, Measure, or Auto) when a measurement runs ends that measurement and returns to the appropriate major mode display.

Auto mode measurements are measurements taken when the VM700T is in Auto mode, wherein it continuously repeats a set of user-selectable measurements and reports when a measurement falls outside user-defined limits. Auto mode is usually used to monitor video signals and alert someone when one or more parameters drifts out of predefined limits. The *Auto Mode* section describes each Auto mode measurement.

Pressing the Auto button on the VM700T front panel displays Auto mode, shows the Auto mode measurements that will be performed continuously until the VM700T is taken out of Auto mode.

Pressing any major mode button (for example, Waveform, Vector, Picture, Measure, or Auto) while a measurement is running ends that measurement and returns to the appropriate major mode display.

The VM700T may be programmed for remote operation. See the *VM700T RS-232 Interface Programmer Manual* for information on programming and operating the VM700T remotely.







# Measure Mode



# Measure Mode

Measure mode of the VM700T Video Measurement Set Option 01 gives you a large selection of interactive, graphical measurements for NTSC video signals. Available Measure mode measurements and the signal qualities they measure include those shown in Table 2-1.

**Table 2-1: Measure Mode Measurements**

Measurements	Measured Parameters
<b>Timing Measurements</b>	
Burst Frequency	Color Burst subcarrier frequency error
H_Blank	Horizontal blanking over field
H_Timing	All horizontal timing parameters
Jitter	H Sync jitter within a frame
Jitter Long_Time	Frame jitter
Line Frequency	Line frequency error
SCH_Phase	SubCarrier-to-Horizontal (SCH) Phase
V_Blank	Vertical interval timing and pulse positions
<b>NonLinear Distortion Measurements</b>	
Chrominance NonLinearity	Chrominance nonlinear phase & gain
DGDP	Differential gain & phase
Luminance NonLinearity	Differential luminance
<b>Linear Distortion Measurements</b>	
Bar LineTime	Bar and sync amplitudes and line time distortion
Bounce	Long time (low frequency) distortion
ChromLum GainDelay	Chrominance-to-luminance gain ratio and delay time
GroupDelay SinX_X	Frequency response, group delay (both with SinX/X signal)
K_Factor	Short Time Distortion ( $K_{2T}$ pulse/bar ratio)
MultiBurst	Frequency response (with MultiBurst signal)
ShortTime Distortion	Distortion in reference-to-bar level and bar-to-reference transitions of a bar signal
TwoField	Field time distortion

Table 2-1: Measure Mode Measurements (Cont.)

Measurements	Measured Parameters
<b>Noise Measurements</b>	
Chrominance AMPM	Chrominance noise (amplitude-modulated and phase-modulated components)
Noise Spectrum	Signal-to-noise ratio (various weighting filters available)
<b>Miscellaneous</b>	
ColorBar	From the color bar signal: luminance level, chrominance level, chrominance phase
ICPM	Incidental Carrier Phase Modulation
VITS ID	Identify signals in vertical interval

## Bar LineTime

The Bar LineTime measurement measures bar and sync amplitudes, as well as line time distortion.

Figure 2-1 shows the Bar LineTime display. The display plots the bar signal level on the y-axis, and time on the x-axis. The default y-axis level labeled "100%" is determined from the difference between the bar top, or level of the bar signal at the center of the bar (than is the time halfway between the 50% rising edge and 50% falling edge times of the bar) and the black-level reference position of the signal. Both the bar top position and the black-level reference position can be adjusted using soft keys on the Special Position submenu of the Acquire soft key.

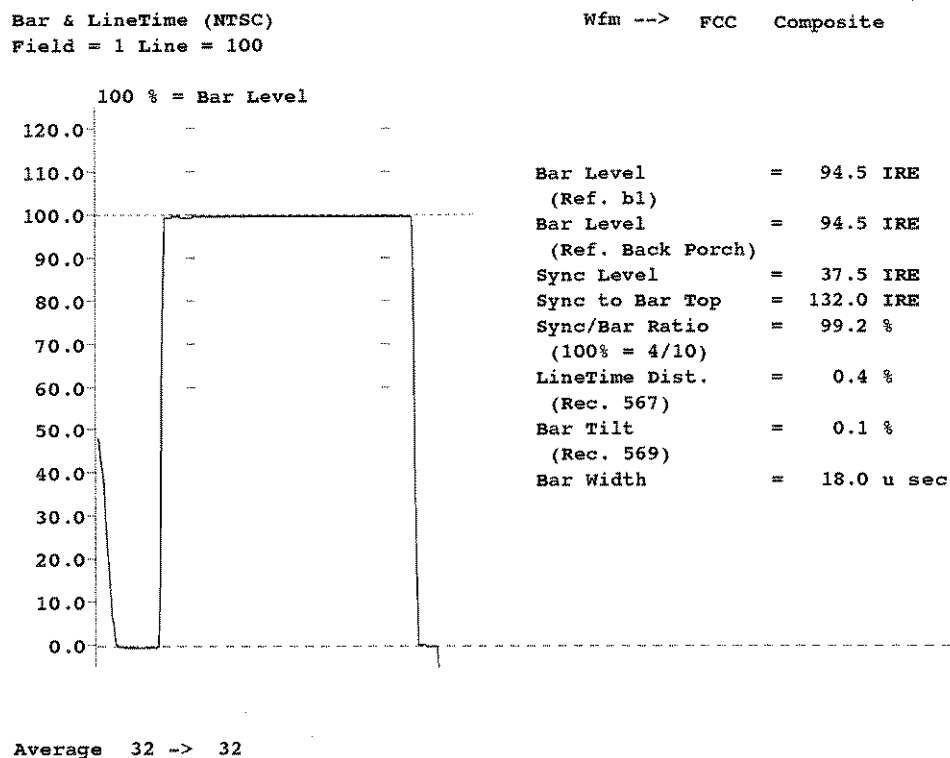

Figure 2-1: Bar LineTime display

Numerical readouts provide measurement results in mV, %, and  $\mu$ sec, as appropriate. The readouts provided are as follows:

- Bar Level (ref. b1) gives the bar top amplitude relative to the Black Level Reference (b1) level.

- Bar Level (ref. Back Porch) gives the bar top amplitude relative to the back porch.
- Sync Level gives the sync tip amplitude relative to the back porch.
- Sync to Bar Top is the Bar Level (ref. Back Porch) plus Sync Level value.
- LineTime Dist. gives the percentage of maximum deviation from the bar level.
- Bar Tilt (Rec. 569) gives the percentage of difference at the end points, which are measured 1  $\mu$ s after the 50% level of the rising edge and 1  $\mu$ s before the 50% level of the falling edge. A positive number means that the point near the falling edge is higher than the point near the rising edge.
- Bar Width is the width in  $\mu$ sec of the bar from the 50% levels of the rising and falling edges.

The Bar LineTime measurement identifies FCC Composite, NTC-7 Composite, or 1410 TSG-5 type Pulse & Bar signals. The essential signal element for the Bar LineTime measurement is a bar signal.

The Bar LineTime measurement is made on the current system line. The System Default measurement location for the Bar LineTime measurement is field 1 of line 18.

The black-level reference and bar top positions can be changed by using the Reference and Bar Pos soft keys, respectively, in the Special Position submenu of the Acquire soft key.

### Bar LineTime Menu

Pressing the Menu button when the Bar LineTime measurement runs displays the Bar LineTime menu (Figure 2-2).

#### Main Menu

**Average Num.** Average Num. specifies the weighting factor to use for averaging. The Average Num range is 1 to 256. The default value is 32. To change the Average Num value, touch the Average Num soft key to highlight it, rotate the knob until the desired weighting factor appears, then touch the Average Num soft key again

**Reference** Reference displays a submenu that (1) stores the currently displayed values for use as a reference; or (2) displays previously stored reference values.

**Relative to Ref** Relative to Ref displays a submenu of soft keys that selects the reference to use for comparison in the measurement. When a stored reference is selected, the currently measured value is compared to the stored reference value.

**Main Menu**

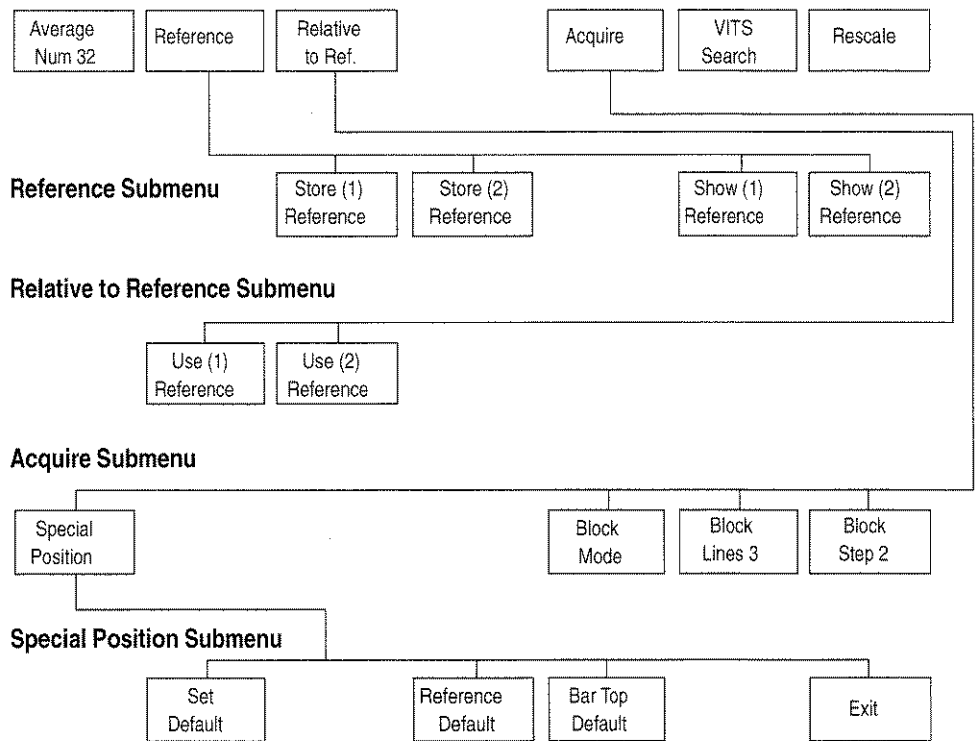

**Figure 2-2: Bar LineTime menu tree**

- Acquire** Acquire displays the Acquire submenu that controls how the signal is acquired for the specific measurement.
- VITS Search** VITS Search searches the insertion test signals for a signal appropriate for the measurement. If an appropriate signal is not located, the message Not found displays briefly on the display.
- Rescale** Rescale sets the expansion factor of the display to an appropriate scaling factor for the Bar LineTime measurement display graticule. The x- and y-axes adjust to accommodate the rescaled display.

**Reference Submenu**

- Store (n) Reference** Store (1) Reference/Store (2) Reference saves the current measurement values as (1) Reference and (2) Reference, respectively. Selecting Store (1) Reference or Store (2) Reference overwrites previous (1) Reference or (2) Reference values. References are stored in nonvolatile memory and are retained when the VM700T is powered down.
- Show (n) Reference** Show (1) Reference/Show (2) Reference displays the current values of (1) Reference and (2) Reference, respectively, plus the date and time the reference was stored and the channel the reference signal was on. If no reference value has been stored, touching either soft key displays a message that the reference is not defined.

**Relative to Reference Submenu**

- Use (n) Reference** Use (1) Reference/Use (2) Reference selects the stored reference to which measured values are compared. If no reference value has been stored, touching either soft key displays a message that the reference is not defined.

**Acquire SubMenu**

- Special Position** Special Position displays the Special Position submenu and a waveform display (Figure 2-3) used to set the location on the waveform where the measurement is made.
- Block Mode** Block Mode turns on Block mode. The block starts at the system line.



- Block Lines 3**      Block Lines sets the number of lines to average for the measurement. The default number of Block Lines to average is 3.
- Block Step 2**      Block Step sets the number of lines to step in the block. The default number of lines to step is 2.

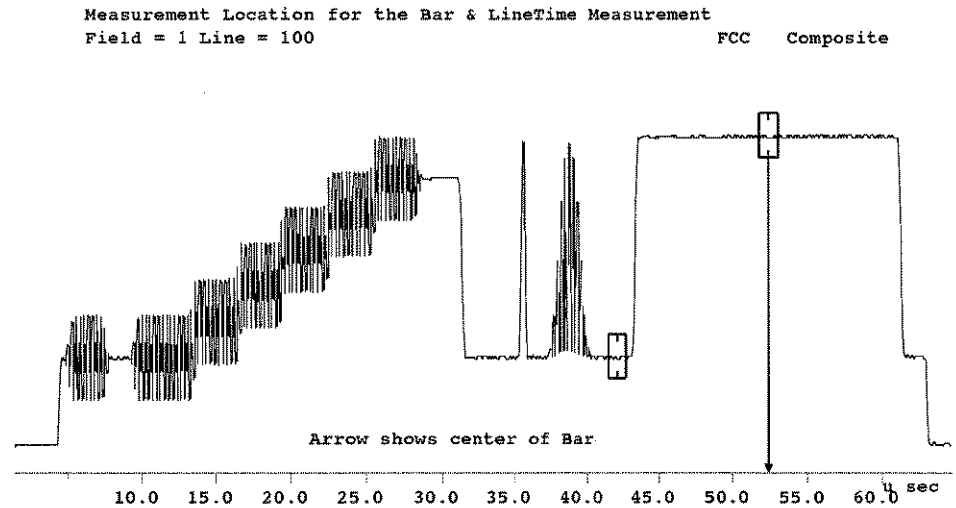

**Figure 2-3: Bar LineTime Special Position display**

**Special Position Submenu**

- Set Default**      Set Default reassigns the default values to the Reference and Bar Position soft keys. To reassign the default value to one of the position soft keys, select that soft key before touching Set Default.
- Ref. (b1)**      Ref. (b1) sets the black level, or zero, measurement location. The default measurement location varies with the signal type (for example FCC and NTC-7).

- Bar Top** Bar Top sets the measurement location of the bar level. The default measurement location is the halfway point between the 50% rising edge and the 50% falling edge times of the bar.
- Exit** Exit leaves the Special Position submenu and displays the Bar LineTime display.

## Bounce

Bounce measures settling time and peak deviation. In addition, bounce amplitude and deviation, sync amplitude and deviation, and difference in Blank level (measured at back porch) and sync amplitude between the high and low APL areas are measured separately. A trigger mode that permits averaging is provided in addition to the Continuous Roll mode display.

In the display (refer to Figure 2-4), there are three signal levels which are selectable (all three levels are selected in Default). From the top, the traces show the Bounce signal (measurement at center of the active area), the Blank level or the Back Porch level (measurement at the center of the Burst), and the Sync Tip level (the bottom trace).

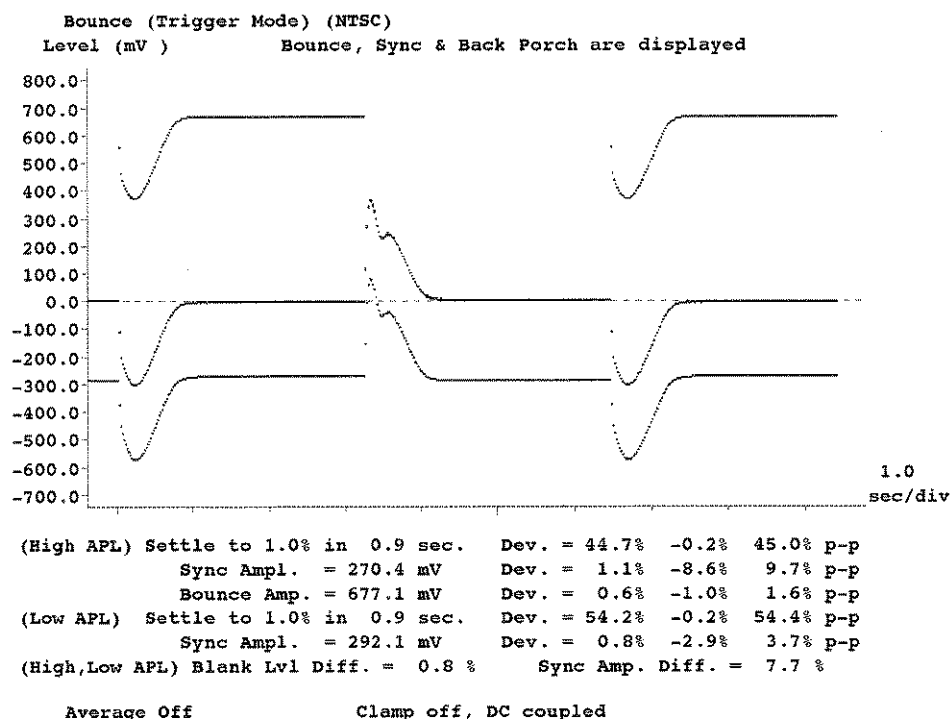

**Figure 2-4: Bounce Measurement display**

The numerical readouts in the Bounce Measurement display are defined as follows:

- (High APL) Settle to gives the time (in seconds) that the signal (Blank level) takes to settle to the reference percentage in the High APL region.
- Dev. gives the % of deviation on the Blank level (Back Porch level) relative to the amplitude of the bounce signal in the High APL region.

- Sync Amp. gives the average of 16 sync amplitude right before bounce transitions high to low.
- Dev. gives the % of deviation on the sync amplitude relative to the sync amplitude in the High APL region.
- Bounce Amp. gives the average of 16 bounce amplitude right before bounce transitions high to low.
- Dev. gives the % of deviation on the bounce amplitude relative to the bounce amplitude in the High APL region.
- (Low APL) Settle to gives the time (in seconds) that the signal (Blank level) takes to settle to the reference percentage in the Low APL region.
- Dev. gives the % of deviation on the Blank level (Back Porch level) relative to the amplitude of the bounce signal in the Low APL region.
- Sync Amp. gives the average of 16 sync amplitudes right before bounce transitions from low to high.
- Dev. gives the % of deviation on the sync amplitude relative to the sync amplitude in the Low APL region.
- (High, Low APL) Blank Lvl Diff. gives the % of difference of Blank level (Back Porch level) between High and Low APL region relative to bounce amplitude.
- Sync Amp. Diff. gives the % of difference of sync amplitude between High and Low APL region relative to the average of both sync amplitude.

---

**NOTE.** Each deviation result has a max., a min., and a P-P value, in order, and max. is always positive and min. is always negative.

---

**Bounce Menu** Pressing the Menu button when the Bounce measurement is running displays the Bounce menu (Figure 2-5).

**Main Menu**



**Display Submenu**

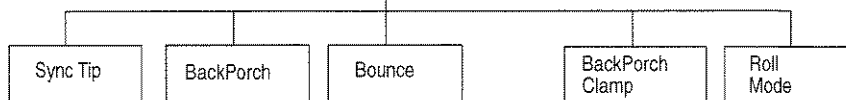

**Acquire Submenu**

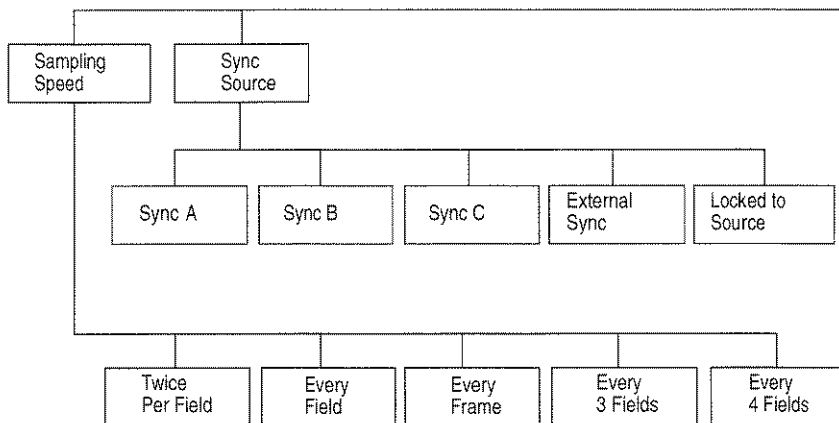

**Cursor Submenu**

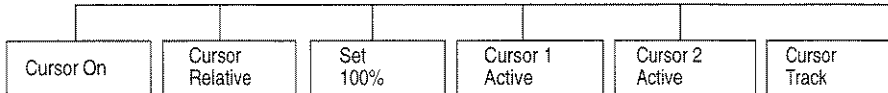

**Figure 2-5: Bounce menu tree**

**Main Menu**

- Average Num ###**      Average Num ### selects the number of averages to be taken for the measurement. The Average Num range is 1 to 256.
- Settle to #.#%**      Settle to #.# permits setting the measurement reference. While this soft key is selected, turning the knob adjusts the settle % value between 0.1 and 9.9%. This threshold is used to measure how long the signal takes to settle within the assigned percentage value after a bounce (APL) transition. For accurate results, measured settling times must be much less than the bounce period.
- Display**      Display provides soft keys for selection of waveforms, such as sync tip, back porch or bounce signal in the active area.
- Acquire**      Acquire provides soft keys for acquisition sync source and sampling speed.
- Cursors**      Cursors provides soft keys to display and activate the cursors.
- Rescale**      Rescale restores the vertical display to its default scale.

**Display SubMenu**

- Sync Tip**      Sync Tip selects and deselects sync tip for the display.
- BackPorch**      BackPorch selects and deselects back porch for the display.
- Bounce**      Bounce selects and deselects Bounce waveform for the display.
- BackPorch Clamp**      BackPorch Clamp sets the clamp position at back porch for the display. The waveform for the measurement is not affected.
- Roll Mode**      Roll Mode selects continuous roll display mode. In Roll mode display, the application continues using the triggered mode waveform, so measurements are not affected.

**Acquire SubMenu**

- Sampling Speed**      Sampling Speed provides soft keys to select sampling speed. Selecting a new sampling speed from the displayed menu choices restarts the measurement.
- Sync Source**      Sync Source provides soft keys to set the sync source. Selecting a new sync source from the displayed menu choices restarts the measurement.

### Sampling Speed Submenu

**Twice Per Field** Twice Per Field sets the sample rate for Sync, Back Porch level, and Bounce level to twice per field.

In this sampling rate, the display may have double traces due to field time distortion. Although the measurement minimizes the effect in the first cycle that is used, there could be slightly different measurement results because of the distortion.

---

**NOTE.** *The actual sampling line is line 40 and a half field later in NTSC and line 73 and a half field later in PAL. If the first line cannot detect a Bounce signal, the application will try to find it in the following line, up to 32 lines.*

---

**Every Field** Every Field sets the sampling rate for Sync, Back Porch level, and Bounce level to every field. This is the default sampling rate. Unless there is an application need to change the sample rate, it is suggested that this sampling rate be used. A lower sampling rate can produce aliasing, and a higher sampling rate can be affected by the field time distortion.

---

**NOTE.** *The actual sampling line is line 132 in NTSC and line 160 in PAL. If the firmware can not detect the Bounce signal, it will try to find it in the following line (up to 32 lines).*

---

**Every Frame** Every Frame sets the sampling rate for Sync, Back Porch level, and Bounce level to every frame.

**Every 3 Fields** Every 3 Fields sets the sampling rate for Sync, Back Porch level, and Bounce level to every 3 fields.

**Every 4 Fields** Every 4 Fields sets the sampling rate for Sync, Back Porch level, and Bounce level to every 4 fields.

### Sync Source SubMenu

**Sync A** Sync A selects the A input for the sync source.

**Sync B** Sync B selects the B input for the sync source.

**Sync C** Sync C selects the C input for the sync source.

**External Sync** External Sync selects the external input for the sync source.

**Locked to Source** Locked to Source selects the signal source for the sync source.

**Cursor Submenu**

**Cursor On** Cursors On displays cursors. Two horizontal cursors appear in the position they were in the last time the cursor was active.

**Cursor Relative** Cursors Relative displays the cursor delta as a percentage in relationship to the stored reference. When not selected, the cursor delta is displayed in IRE (NTSC) or mV (PAL) units.

**Set 100%** Set 100% stores the current cursor position difference as the 100% reference with Cursor Relative active.

**Cursor 1 Active** Cursor 1 Active displays cursors and permits the knob to position cursor 1.

**Cursor 2 Active** Cursor 2 Active displays cursors and permits the knob to position cursor 2.

**Cursor Track** Cursor Track displays cursors and permits the knob to position both cursors together (track).



## Typical Measurement Results

See Figure 2-4 for the waveform display for Example 1.

### Example

```

Measurement Results          Channel A          Thu Jul 23 13:10:30
Bounce
Average Off
-----
      (High APL)
Settling Time                0.4 sec
Blanking Dev. (+)            0.3 %
Blanking Dev. (-)           -0.2 %
Blanking Dev. (P-P)          0.5 %
Sync Amplitude               270.5 mV
Sync Amp. Dev. (+)           1.1 %
Sync Amp. Dev. (-)          -9.1 %
Sync Amp. Dev. (P-P)        10.1 %
Bounce Amplitude             679.1 mV
Bounce Amp. Dev. (+)         0.5 %
Bounce Amp. Dev. (-)        -1.3 %
Bounce Amp. Dev. (P-P)      1.8 %
      (Low APL)
Settling Time                0.5 sec
Blanking Dev. (+)            0.2 %
Blanking Dev. (-)           -0.2 %
Blanking Dev. (P-P)          0.4 %
Sync Amplitude               291.8 mV
Sync Amp. Dev. (+)           0.7 %
Sync Amp. Dev. (-)          -2.4 %
Sync Amp. Dev. (P-P)        3.1 %
      (High,Low APL)
Blank Level Diff.            75.8 %
Sync Amp. Diff.              7.6 %
-----

```

## Burst Frequency

Burst Frequency measures the Color Burst (subcarrier) frequency. Figure 2-6 shows the Burst Frequency display. The display shows the difference between the currently measured Burst Frequency and a reference frequency. (In Figure 2-6, the Color Burst frequency of an incoming signal on Channel C was used as the reference.)

### Burst Frequency (NTSC)

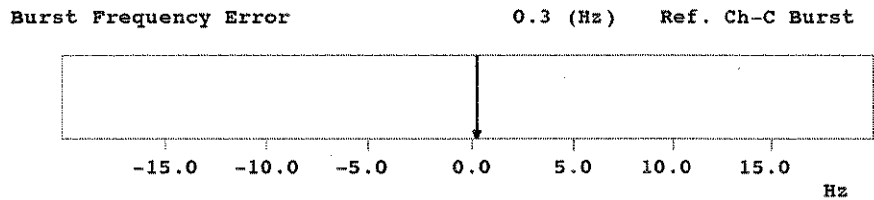

Average 32 -> 32



Figure 2-6: Burst Frequency display

You can use the Color Burst frequency of the signal currently on another channel as a reference frequency, or you can store a reference frequency by using the Reference Internal and Zero Set soft keys that appear as a submenu under the Reference soft key. (Refer to *Setting the Reference Burst Frequency* on page 2-18.)

If you use the color burst from another channel (or the internal frequency reference) as a reference frequency on a Dual-Standard VM700T, both signals should use the same standard (NTSC or PAL).

**Burst Frequency Menu**

Pressing the Menu button when the Burst Frequency measurement runs displays the Burst Frequency menu (Figure 2-7).

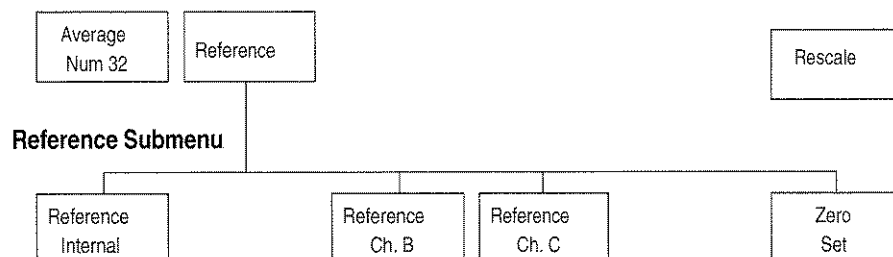
**Main Menu**

**Figure 2-7: Burst Frequency menu tree**

**Main Menu****Average Num**

Average Num specifies the weighting factor to use for averaging. The Average Num range is 1 to 256. The default value is 32. To change the Average Num value, touch the Average Num soft key to highlight it, rotate the knob until the desired weighting factor appears, then touch the Average Num soft key again.

**Reference**

Reference displays the Reference submenu which selects the reference source for the burst frequency.

**Rescale**

Rescale sets the expansion factor of the display to an appropriate scaling factor for the Burst Frequency measurement display graticule. The x- and y-axes adjust to accommodate the rescaled display.

**Reference Submenu****Reference Internal**

Reference Internal sets the reference burst frequency to that of the internal crystal. A reference frequency stored with the Zero Set soft key is required for calibration.

**Reference Ch. B**

Reference Ch. B sets the burst frequency reference to Channel B.

<b>Reference Ch. C</b>	Reference Ch. C sets the burst frequency reference to Channel C.
<b>Zero Set</b>	Zero Set stores the burst frequency of the current source as the reference.

### Setting the Reference Burst Frequency

You can set the VM700T reference burst frequency when the Reference submenu displays.

- To use the burst frequency of a signal on another channel as a reference, touch the soft key corresponding to that channel.
- To store the Color Burst frequency of a signal on another channel for later use as a reference, press that channel's button on the front panel, then touch the Zero Set soft key. The Color Burst frequency of the designated signal becomes the internal reference, and remains so until the VM700T is powered down or until another reference signal is stored.
- To use the frequency of the VM700T internal crystal as a reference frequency without calibration, disconnect any signals from the current sync source, then touch the Zero Set soft key.

The VM700T displays "Zero Set," followed by the date and time, followed by the message "No CAL." The stored value becomes the internal reference, and remains so until the VM700T is powered down or until another reference signal is stored. (This method of measurement is not recommended, but may be accurate enough for some purposes.)

## ChromLum GainDelay

ChromLum GainDelay measures the Chrominance-to-Luminance gain ratio and delay time.

The ChromLum GainDelay measurement screen provides a graphic display of chrominance-to-luminance gain and delay values. This measurement is normally made on a modulated 12.5T pulse. Figure 2-8 shows a VITS signal measured by ChromLum GainDelay.

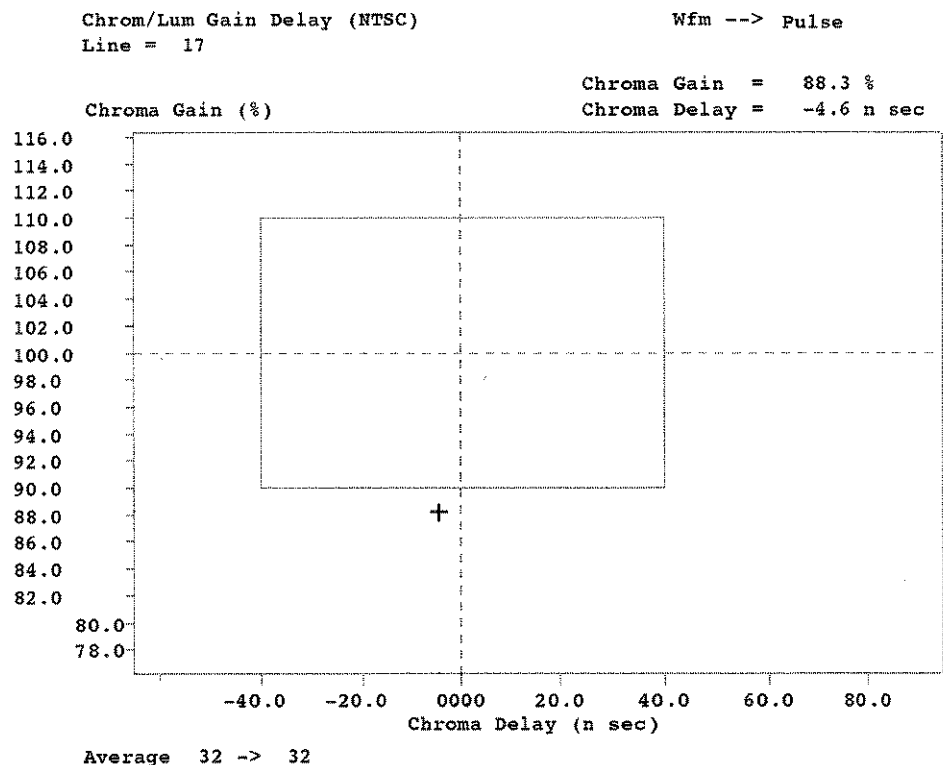

Figure 2-8: ChromLum GainDelay display

The rectangle in the center of the display represents the upper and lower limits of the Chroma Gain (%) and Chroma Delay (ns) measurements. The left and right sides of the box correspond to the lower and upper limits of the chrominance-to-luminance delay measurement (Chroma-Lum Delay (ns) in the active Measure\_Limits file). The top and bottom of the box represent the upper and lower limits of the chrominance-to-luminance gain error measurement (Chroma-Lum Gain (%) in the active Measure\_Limits file). The position of the + within the box indicates delay (in nanoseconds) along the horizontal scale and gain (in %, relative to luminance) on the vertical scale.

The ChromLum GainDelay measurement is made on the current system line. The System Default measurement locations file specifies that the ChromLum GainDelay measurement is made on field 1, line 18.

**ChromLum GainDelay Menu**

Pressing the Menu button when the ChromLum GainDelay measurement runs displays the ChromLum GainDelay menu (Figure 2-9).

**Main Menu**

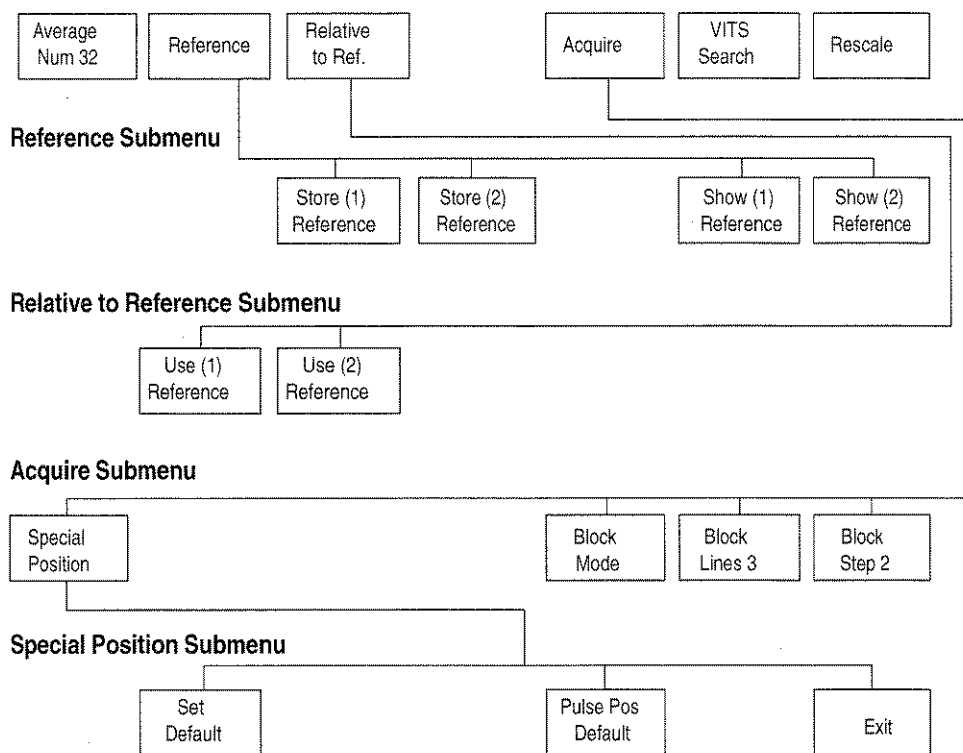

**Figure 2-9: ChromLum GainDelay menu tree**

## Main Menu

<b>Average Num</b>	Average Num specifies the weighting factor to use for averaging. The Average Num range is 1 to 256. The default value is 32. To change the Average Num value, touch the Average Num soft key to highlight it, rotate the knob until the desired weighting factor appears, then touch the Average Num soft key again.
<b>Reference</b>	Reference displays the Reference submenu which stores the currently displayed values for use as a reference or displays previously stored reference values.
<b>Relative to Reference</b>	Relative to Reference displays the Relative to Reference submenu where you can select the reference to use for comparison in the measurement. When a stored reference is selected, the currently measured value is compared to the stored reference value.
<b>Acquire</b>	Acquire displays the Acquire submenu that controls how the signal is acquired for the specific measurement.
<b>VITS Search</b>	VITS Search causes the VM700T to search the insertion test signals for a signal appropriate for the measurement. If an appropriate signal is not located, the message Not found displays briefly on the display.
<b>Rescale</b>	Rescale sets the expansion factor of the display to an appropriate scaling factor for the ChromLum GainDelay measurement display graticule. The x- and y-axes adjust to accommodate the rescaled display.

## Reference Submenu

<b>Store (n) Reference</b>	Store (1) Reference/Store (2) Reference saves the current measurement values as (1) Reference and (2) Reference, respectively. Selecting Store (1) Reference or Store (2) Reference overwrites previous (1) Reference or (2) Reference values. References are stored in nonvolatile memory and are retained when the VM700T is powered down.
<b>Show (n) Reference</b>	Show (1) Reference/Show (2) Reference displays the current values of (1) Reference and (2) Reference, respectively, plus the date and time the reference was stored and the channel the reference signal was on. If no reference value has been stored, touching either soft key displays a message that the reference is not defined.

**Relative to Reference Submenu**

**Use (n) Reference** Use (1) Reference/Use (2) Reference selects the stored reference to which measured values are compared. If no reference value has been stored, touching either soft key displays a message that the reference is not defined.

**Acquire Submenu**

**Special Position** Special Position displays the Special Position submenu and a special waveform display used to set the location on the waveform where the measurement is made. Figure 2-10 shows the ChromLum GainDelay Special Position display and submenu.

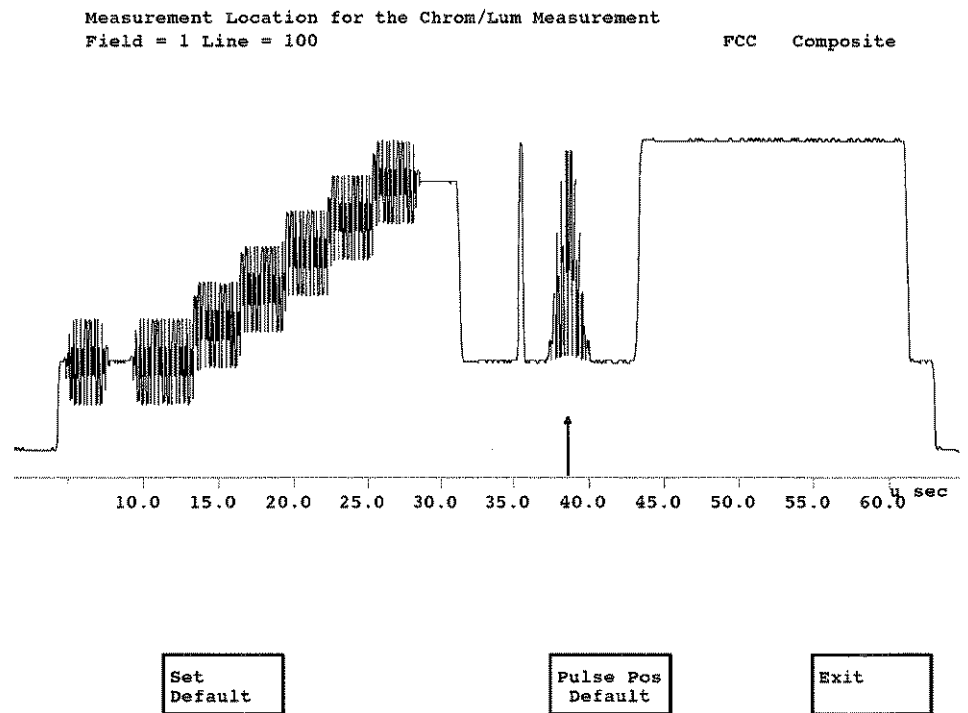

**Figure 2-10: ChromLum GainDelay Special Position display**



<b>Block Mode</b>	Block Mode turns on Block mode. The block starts at the system line.
<b>Block Lines</b>	Block Lines sets the number of lines to average for the measurement. The default number of Block Lines to average is 3.
<b>Block Step</b>	Block Step sets the number of lines to step in the block. The default number of lines to step is 2.

#### **Special Position Submenu**

<b>Set Default</b>	Set Default reassigns the default value to the Pulse Position soft key.
<b>Pulse Pos</b>	Pulse Pos sets the measurement location of the pulse. The default pulse position is determined automatically by the type of signal being measured.
<b>Exit</b>	Exit leaves the Special Position submenu and displays the ChromLum GainDelay display.

## Chrominance AMPM

Chrominance AMPM measures two types of chrominance noise: the amplitude-modulated (AM) noise component and the phase-modulated (PM) noise component of the chrominance channel as shown in Figure 2-11.

Video tape recorders (VTR) have separate chrominance and luminance channels. Most signal-to-noise measurements look only at noise in the luminance channel. Chrominance AMPM measures two types of chrominance noise: the amplitude-modulated (AM) noise component and the phase-modulated (PM) noise component of the chrominance channel. A software filter with a very sharp cut-off reduces intermodulation from the frequency-modulated fundamental of a VCR/VTR. This measurement can be made on a full field or single line of the Red Field test signal.

The default measurement bandwidth is 100 Hz to 500 kHz. High-pass 100 Hz, 10 kHz, and 100 kHz filters, as well as low-pass 100 kHz, 500 kHz, and 1.0 MHz filters are available by touching the Menu button and the Filters Selection soft key.

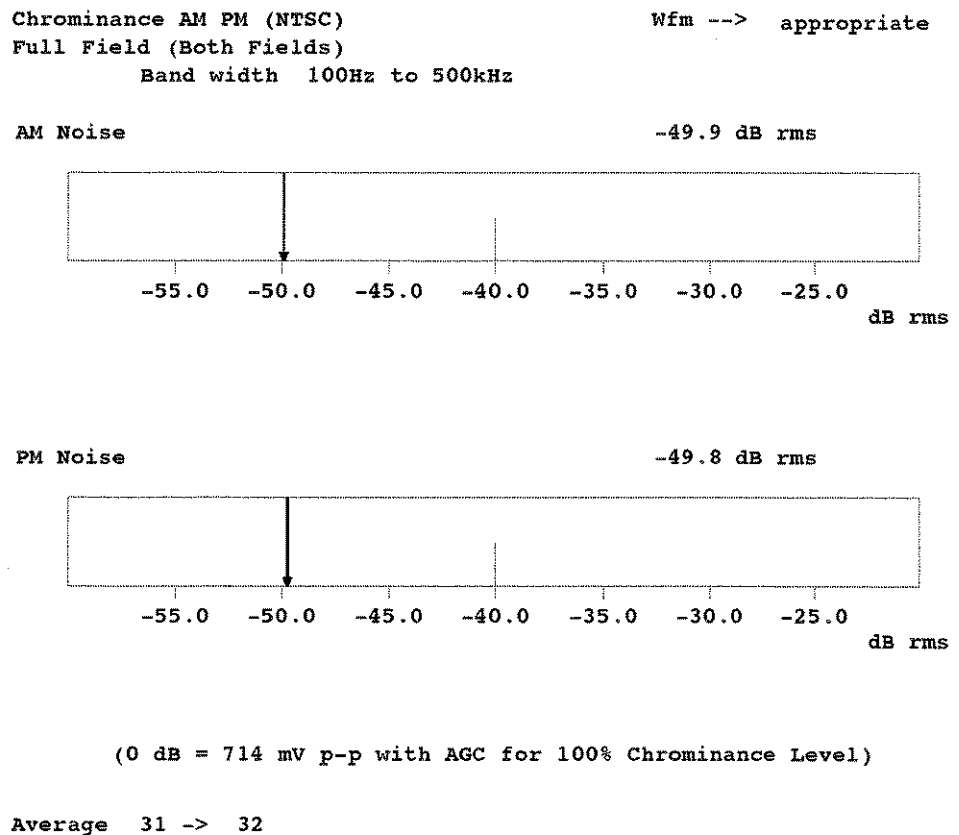

Figure 2-11: Chrominance AMPM display

When using a single line for the measurement, the 100 Hz high-pass filter becomes unavailable due to the lack of low-frequency components in a line.

When using Color Bursts for the measurement, 100 Hz high-pass and 1.0 MHz low-pass filters are automatically selected.

The values for Chrominance AM and PM are defined as follows:

$$\text{Chrominance AM} = 20 \log \frac{\text{AM noise}_{\text{rms}}}{V_{\text{refp-p}}}$$

$$\text{Chrominance PM} = 20 \log \frac{\text{PM noise}_{\text{rms}}}{V_{\text{refp-p}}}$$

where  $V_{\text{refp-p}}$  denotes the chrominance voltage corresponding to 100% amplitude of the non-composite video signal.

Touching the Chrominance AMPM soft key from the Measure mode directory window displays the Chrominance AMPM screen (Figure 2-11). The display has the following features:

- two graphic meter displays that show the measured values of AM and PM noise
- digital readouts of the measurements
- graphical indicators for the upper limit values for Chrominance AM and PM noise as specified in the current Measure\_Limits file. The lines controlling these values in the Measure\_Limit file are labeled Chrominance AM Noise (dB rms) and Chrominance PM Noise (dB rms), respectively, in the current Measure\_Limits file.

### Chrominance AMPM Menu

Pressing the Menu button when the Chrominance AMPM measurement runs displays the Chrominance AMPM menu (Figure 2-12).

#### Main Menu

##### Average Num

Average Num specifies the weighting factor to use for averaging. The Average Num range is 1 to 256. The default value is 32. To change the Average Num value, touch the Average Num soft key to highlight it, rotate the knob until the desired weighting factor appears, then touch the Average Num soft key again.

**Main Menu**

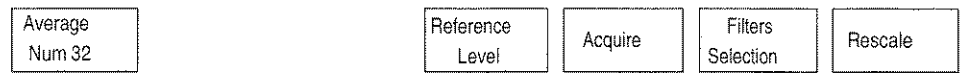

**Reference Level Submenu**

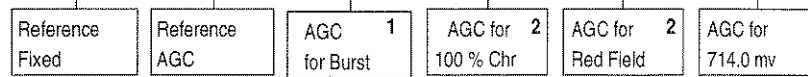

**Acquire Submenu**



**Filter Selection Submenu**

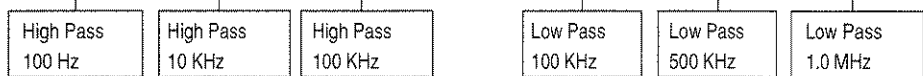

- <sup>1</sup> Displayed when Color Burst in Acquire submenu is selected.
- <sup>2</sup> Not visible when Color Burst in Acquire submenu is selected.

**Figure 2-12: Chrominance AMPM menu tree**

- Reference Level** Reference Level displays the Reference Level submenu which selects whether the measurement uses the chrominance signal amplitude as-measured, or compensates for degradation of chrominance signal amplitude (for example, by a VCR).
- Acquire** Acquire displays the Acquire submenu used to select full field, burst, or single line acquisition, and to select field 1, field 2, or both fields.
- Filters Selection** Filters Selection provides soft keys to select high-pass or low-pass filtering for the input signal.
- Rescale** Rescale restores the display to its default scale, with meters reading from -60 dB to -20 dB.

### Reference Level Submenu

- Reference Fixed** Reference Fixed measures chrominance noise using the chrominance signal amplitude as-measured.
- Reference AGC** Reference AGC measures chrominance noise while compensating for degradation of chrominance signal amplitude according to the AGC option selected.
- AGC for Burst** AGC for Burst is displayed when Reference AGC is selected and a color burst is being acquired. Touching this soft key compensates for chrominance signal amplitude degradation by an amount relative to the level of the Color Burst signal (286 mV peak-to-peak); the effective chrominance signal amplitude becomes 286 mV/measured chrominance signal amplitude.
- AGC for 100% Chr** AGC for 100% Chr. is displayed when Reference AGC is selected and a single line is being acquired. Touching this soft key compensates for chrominance signal amplitude degradation by an amount relative to the level of the average measured chrominance level; the effective chrominance signal amplitude becomes 714 mV/measured chrominance signal amplitude.
- AGC for Red Field** AGC for Red Field is displayed when Reference AGC is selected and a single line is being acquired. Touching this soft key compensates for chrominance signal amplitude degradation by an amount relative to the level of the IEC 883 Red Field level (626 mV); the effective chrominance signal amplitude becomes 626 mV measured chrominance amplitude.
- AGC for nnn mv** AGC for nnn mV compensates for chrominance signal amplitude degradation by an amount relative to a user-specified value (which can be set with the knob); the effective chrominance signal amplitude becomes a user-specified value measured chrominance amplitude.

### Acquire Submenu

- Single Line** Single Line specifies that the measurement is to be made on a single line. The 100 Hz high-pass filter is not available for this measurement.
- Color Burst** Color Burst specifies that the measurement is to be made on the Color Burst signal. The 100 Hz high-pass and 1 MHz low-pass filters are automatically selected.
- Field 1** Field 1 specifies that the measurement is to be made only on field 1.

- Field 2** Field 2 specifies that the measurement is to be made only on field 2.
- Both Fields** Both Fields are displayed unless single line is being acquired. Specifies that the measurement is to be made on both field 1 and field 2.

**Filters Submenu**

- High Pass** High Pass 100 Hz/10 kHz/100 kHz selects the specified high-pass filter. Signal information lower than the specified frequency is filtered out.
- 100 Hz/10 kHz/  
100 kHz/**
- Low Pass** Low Pass 100 kHz/500 kHz/1.0 MHz selects the specified low-pass filter. Signal information higher than the specified frequency is filtered out.
- 100 kHz/  
500 kHz/  
1.0 MHz**

Text in the Chrominance AMPM display shows the name of the measurement, the line number or color burst field number on which the measurement is being made, the bandwidth specified for the measurement, whether or not the signal is correct for the measurement, the definition of the 0 dB level for the measurement, and whether Averaging is off or on. If Averaging is on, the text also indicates the current weighting factor used for averaging, as well as the number of sampling points acquired.

## Chrominance FreqResp

The Chrominance FreqResp measurement determines frequency response near the subcarrier frequency.

This measurement is essentially the same as the MultiBurst measurement, except that five packets are used instead of six, and the 3.85 MHz packet is used as the reference.

Figure 2-13 shows the Chrominance FreqResp display, which plots signal amplitude as a function of difference from the reference frequency.

The Chrominance FreqResp measurements require a special multiple-burst signal (see Figure 2-15). The Chrominance Frequency Response signal from either a Tektronix TSG130A Multiformat Signal Generator or a Tektronix 1910 Digital Generator with the special signal added is recommended.

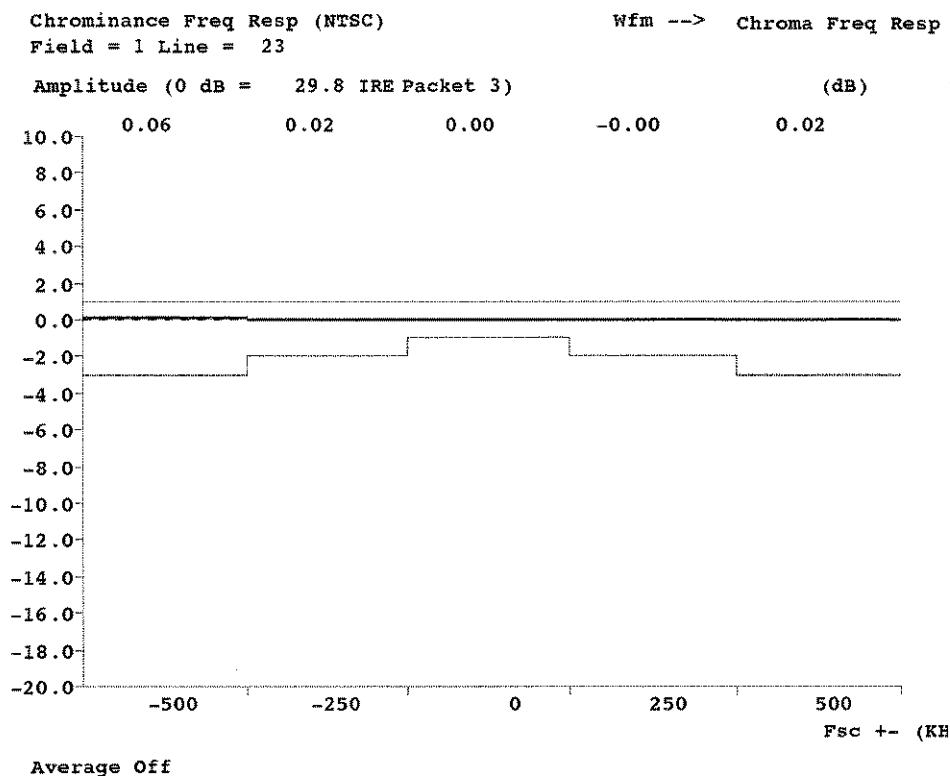
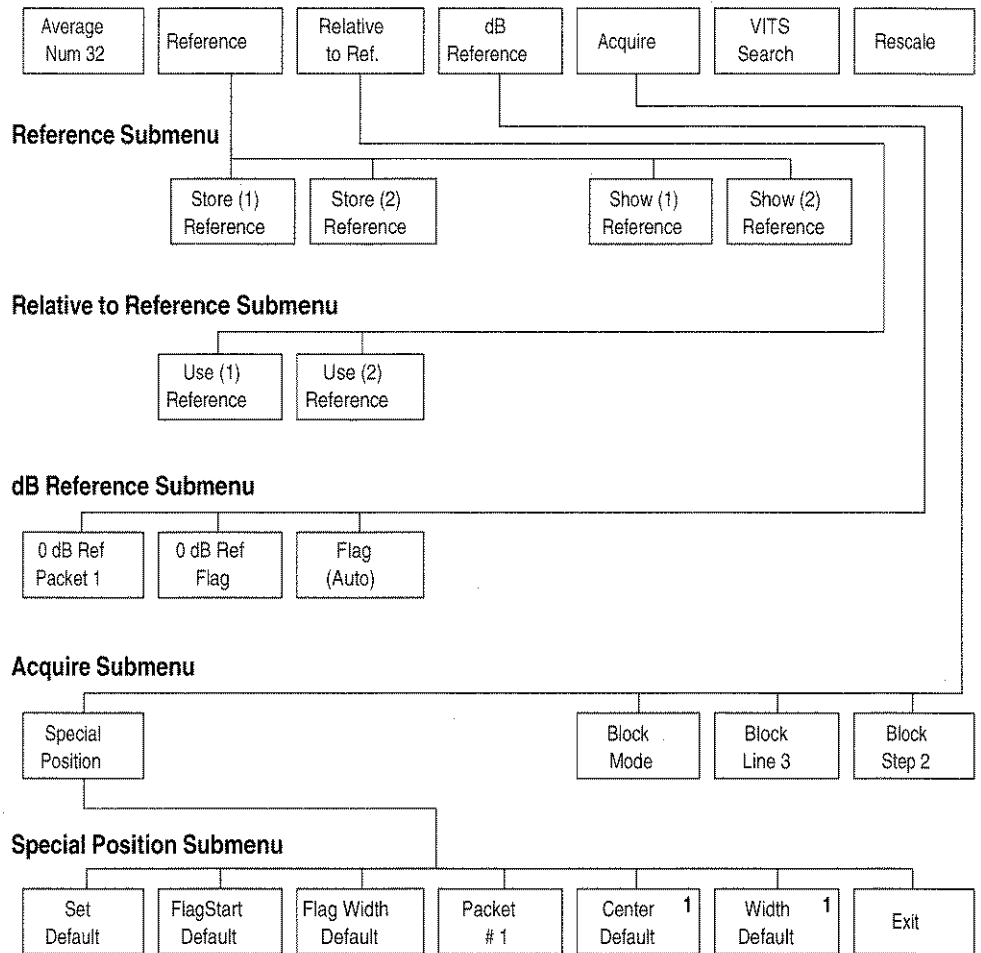

Figure 2-13: Chrominance FreqResp display

**Chrominance FreqResp Menu**

Pressing the Menu button when the Chrominance FreqResp measurement runs brings up the Chrominance FreqResp menu (Figure 2-14).

**Main Menu**



<sup>1</sup> Displayed only when Packet # is selected.

**Figure 2-14: Chrominance FreqResp menu tree**



**Main Menu**

<b>Average Num</b>	Average Num specifies the weighting factor to use for averaging. The Average Num range is 1 to 256. The default value is 32. To change the Average Num value, touch the Average Num soft key to highlight it, rotate the knob until the desired weighting factor appears, then touch the Average Num soft key again.
<b>Reference</b>	Reference Level displays the Reference submenu which stores the currently displayed values for use as a reference or displays previously stored reference values.
<b>Relative to Ref.</b>	Relative to Ref. displays the Relative to Reference submenu which selects the reference to use for comparison in the measurement. When a stored reference is selected, the currently measured value is compared to the stored reference value.
<b>dB Reference</b>	dB Reference sets the reference position.
<b>Acquire</b>	Acquire displays the Acquire submenu that controls how the signal is acquired for the specific measurement.
<b>VITS Search</b>	VITS Search causes the VM700T to search the insertion test signals for a signal appropriate for the measurement. If an appropriate signal is not located, "Not found" displays briefly on the screen.
<b>Rescale</b>	Rescale sets the expansion factor of the display to an appropriate scaling factor for the Chroma FreqResp measurement display graticule. The x- and y-axes adjust to accommodate the rescaled display.

**Reference Level Submenu**

- Store (n) Reference**      Store (1) Reference/Store (2) Reference saves the current measurement values as (1) Reference and (2) Reference, respectively. Selecting Store (1) Reference or Store (2) Reference overwrites previous (1) Reference or (2) Reference values. References are stored in nonvolatile memory and are retained when the VM700T is powered down.
  
- Show (n) Reference**      Show (1) Reference/Show (2) Reference displays the current values of (1) Reference and (2) Reference, respectively, plus the date and time the reference was stored and the channel the reference signal was on. If no reference value has been stored, touching either soft key displays a message that the reference is not defined.

**Relative to Reference Submenu**

- Use (n) Reference**      Use (1) Reference/Use (2) Reference selects the stored reference to which measured values are compared. If no reference value has been stored, touching either soft key displays a message that the reference is not defined.

**dB Reference Submenu**

- 0dB Ref Packet n**      dB Ref Packet n when highlighted, allows you to set the amplitude reference level by rotating the knob. The reference position can be set to the measured amplitude of Packets 1 through 5 or to FLAG.
  
- 0dB Ref Flag**      Flag displays when the 0 dB Ref soft key is set to FLAG. When FLAG is highlighted, the amplitude reference level is set as a percentage of flag amplitude. By default, the amplitude reference level is set automatically. The default reference level percentage varies with the type of signal being measured. You can also set the percentage by rotating the knob; rotating it counterclockwise will (eventually) set the reference level back to AUTO.

### Acquire Submenu

<b>Special Position</b>	Special Position displays the Special Position submenu and a special waveform display used to set the location on the waveform where the measurement is made. Figure 2-15 shows the Chrominance FreqResp Special Position display and submenu.
<b>Block Mode</b>	Block Mode turns on Block mode. The block starts at the system line.
<b>Block Lines</b>	Block Lines sets the number of lines to average for the measurement. The default number of Block Lines to average is 3.
<b>Block Step</b>	Block Step sets the number of lines to step in the block. The default number of lines to step is 2.

### Special Position Submenu

<b>Set Default</b>	Set Default returns each measurement location to its default position as given in the Measurement Locations file. If any other soft key is highlighted, only that measurement location is changed.
--------------------	--

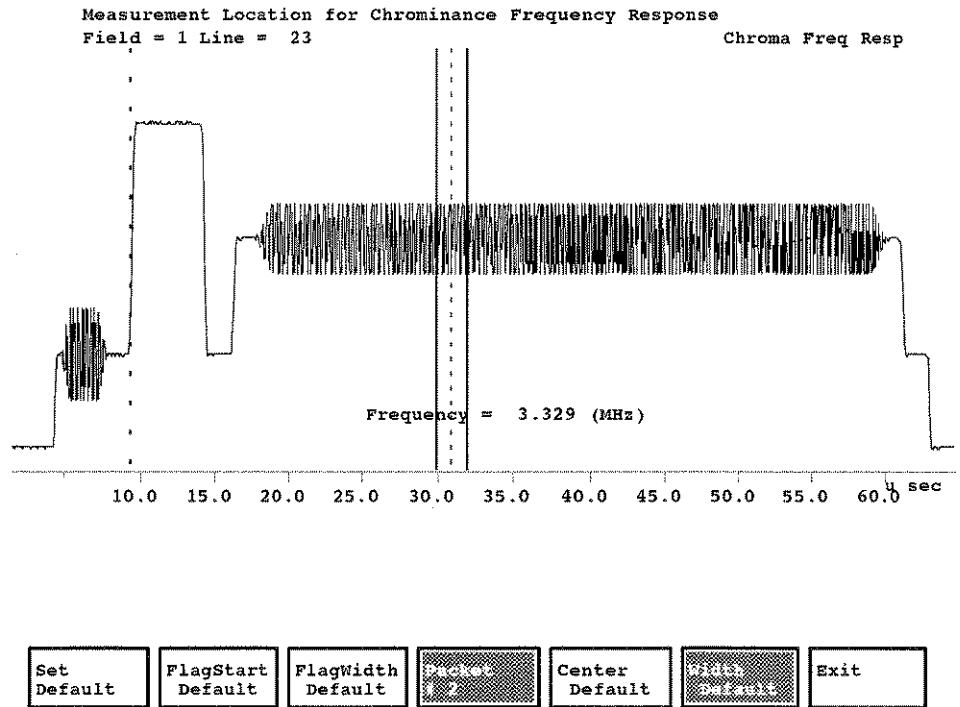

Figure 2-15: Chrominance FreqResp Special Position display

- Flag Start** Flag Start allows you to set the location of the leading edge of the amplitude reference flag by rotating the knob.
- Flag Width** Flag Width allows you to set the width of the amplitude reference flag by rotating the knob.
- Packet #** Packet # allows you to select one of the six packets to set its measurement location and area. Cursors indicating the location and width and a readout of the frequency of the packet are displayed.
- Center Default** Center Default allows you to set the center location of the packet by rotating the knob.
- Width Default** Width Default allows you to set the measurement area of the packet by rotating the knob.
- Exit** Exit leaves the Special Position submenu and displays the Chrominance FreqResp screen.

## Chrominance NonLinearity

The Chrominance NonLinearity measurement requires a Three-Level Modulated Pedestal or NTC-7 Combination test signal. Figure 2-16 shows the Chrominance NonLinearity display.

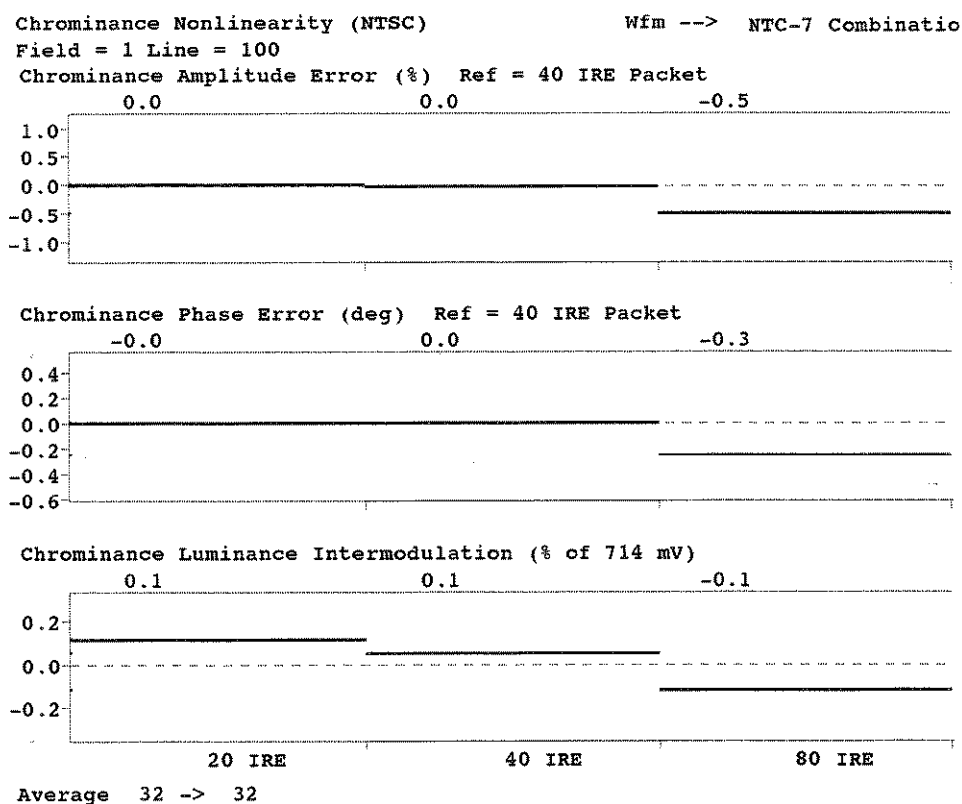

Figure 2-16: Chrominance NonLinearity display

Chrominance NonLinearity measures nonlinear distortions of both gain and phase of the chrominance channel caused by differences in chrominance amplitudes. Intermodulation between chrominance and luminance is also displayed. Separate graphs are provided for each of the three measurements.

The Chrominance Amplitude Error (%) measurement is referenced to the center (40 IRE) packet. The Chrominance Phase Error (deg) measurement is also referenced to the center packet, and with a normal 3-Level Modulated Pedestal signal, the results should be near 0°. The Chrominance Luminance Intermodulation measurement notes the luminance level changes that are due to changes in chrominance amplitudes. The measurement is referenced to the 714 mV level, and is expressed as a percentage of 714 mV.

The Chrominance NonLinearity measurement is made on the current system line. The System Default Measurement Locations file specifies that the Chrominance NonLinearity measurement is made on field 1, line 17.

**Chrominance NonLinearity Menu**

Pressing the Menu button when the Chrominance NonLinearity measurement runs displays the Chrominance NonLinearity menu (Figure 2-17).

**Main Menu**

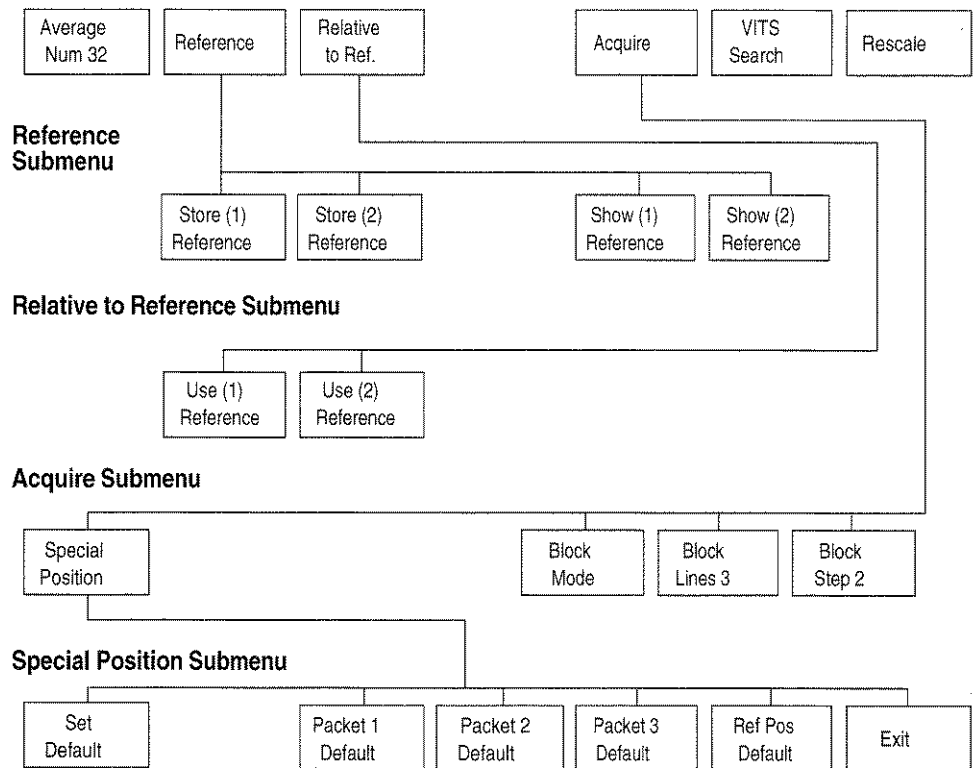

**Figure 2-17: Chrominance NonLinearity menu tree**

**Main Menu**

<b>Average Num</b>	Average Num specifies the weighting factor to use for averaging. The Average Num range is 1 to 256. The default value is 32. To change the Average Num value, touch the Average Num soft key to highlight it, rotate the knob until the desired weighting factor appears, then touch the Average Num soft key again.
<b>Reference</b>	Reference displays the Reference submenu which (1) stores the currently displayed values for use as a reference; or (2) displays previously stored reference values.
<b>Relative to Reference</b>	Relative to Reference displays the Relative to Reference submenu that selects the reference to use for comparison in the measurement. When a stored reference is selected, the currently measured value is compared to the stored reference value.
<b>Acquire</b>	Acquire displays the Acquire submenu that controls how the signal is acquired for the specific measurement.
<b>VITS Search</b>	VITS Search causes the VM700T to search the insertion test signals for a signal appropriate for the measurement. If an appropriate signal is not located, the message "Not found" displays briefly on the display.
<b>Rescale</b>	Rescale sets the expansion factor of the display to an appropriate scaling factor for the Chrominance NonLinearity measurement display graticule. The x- and y-axes adjust to accommodate the rescaled display.

**Reference Submenu**

<b>Store (n) Reference</b>	Store (1) Reference/Store (2) Reference saves the current measurement values as (1) Reference and (2) Reference, respectively. Selecting Store (1) Reference or Store (2) Reference overwrites previous (1) Reference or (2) Reference values. References are stored in nonvolatile memory and are retained while the VM700T is not on.
<b>Show (n) Reference</b>	Show (1) Reference/Show (2) Reference displays the current values of (1) Reference and (2) Reference, respectively, plus the date and time the reference was stored and the channel the reference signal was on. If no reference value has been stored, touching either soft key displays a message that the reference is not defined.

**Relative to Reference Submenu**

**Use (n) Reference** Use (1) Reference/Use (2) Reference selects the stored reference to which measured values are compared. If no reference value has been stored, touching either soft key displays a message that the reference is not defined.

**Acquire Submenu**

**Special Position** Special Position displays the Special Position submenu and a special waveform display used to set the location on the waveform where the measurement is made. Figure 2-18 shows the Chrominance NonLinearity Special Position display and submenu.

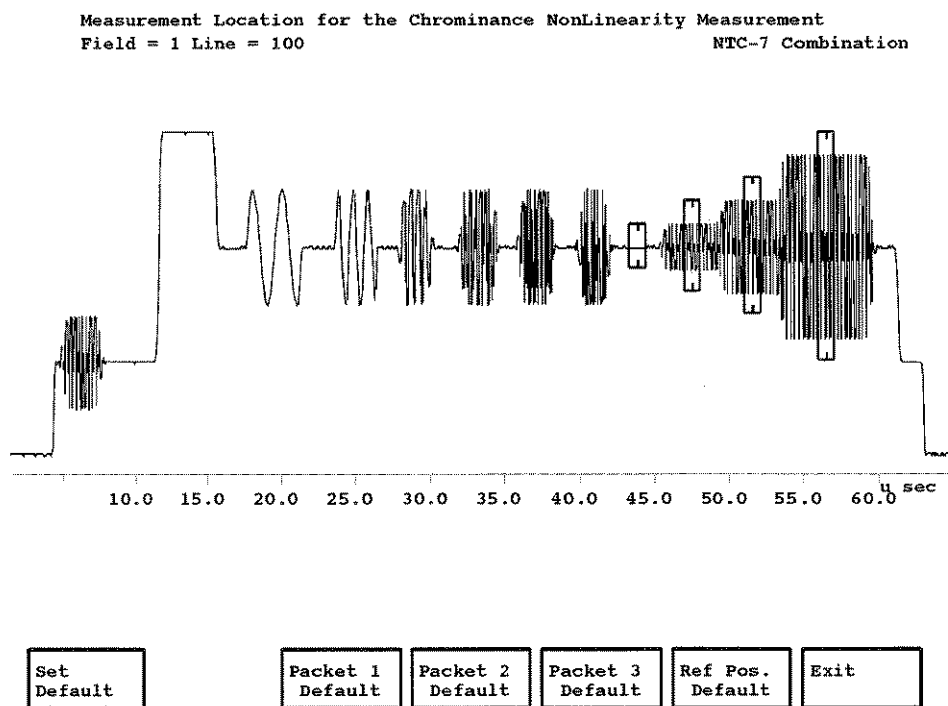

**Figure 2-18: Chrominance NonLinearity Special Position display**



<b>Block Mode</b>	Block Mode turns on Block mode. The block starts at the system line.
<b>Block Lines</b>	Block Lines sets the number of lines to average for the measurement. The default number of Block Lines to average is 3.
<b>Block Step</b>	Block Step sets the number of lines to step in the block. The default number of lines to step is 2.

### Special Position Submenu

<b>Set Default</b>	Set Default reassigns the default values to the Packet 1, Packet 2, Packet 3, and Ref Pos. soft keys. To reassign the default value to one of the soft keys, select that soft key before touching Set Default.
<b>Packet 1/2/3</b>	Packet 1/2/3 defines the measurement locations of the chrominance packets. The default measurement locations are automatically defined, depending on the type of signal being measured.
<b>Ref Pos</b>	Ref Pos defines the measurement location of the reference level. The default reference measurement location is automatically defined for the type of signal being measured.
<b>Exit</b>	Exit leaves the Special Position submenu and displays the Chrominance NonLinearity screen.

## ColorBar

ColorBar measures the luminance level, chrominance level, and chrominance phase of each chroma packet, and displays them on three separate graticules. The top graticule shows the luminance level of each chroma packet. The middle graticule shows the chrominance level of each chroma packet. The bottom graticule shows the chrominance phase (in degrees) of each chroma packet. Each graticule includes the measurement limits (as set in the active Measurement Limits file) for each color; the limits are shown as horizontal lines that extend the width of each color. The ColorBar measurement display is shown in Figure 2-19.

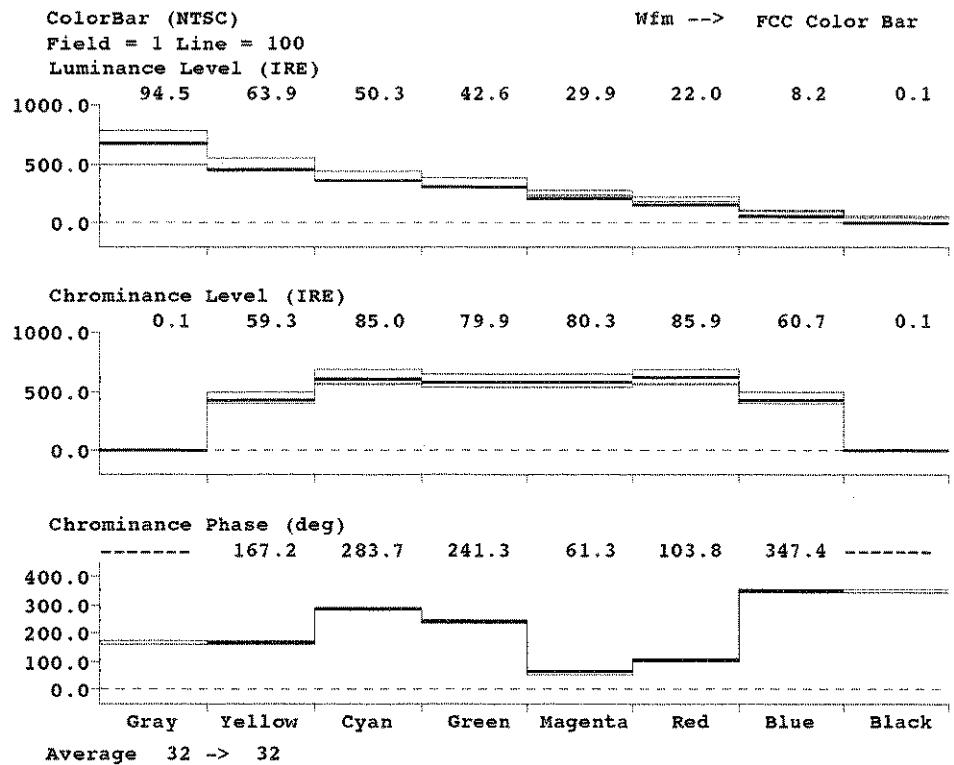

Figure 2-19: ColorBar display

The Chrominance Phase measurement is not made unless the chrominance amplitude is at least 35 mV (5 IRE). The message LOW CHROMA displays when chrominance amplitudes are less than this value.

The ColorBar measurement is made on the current system line. The System Default Measurement Locations file specifies that the ColorBar measurement is made on field 2, line 17.

## Predefined Color Bar References

In addition to the usual user-defined measurement references, the ColorBar measurement includes three predefined reference values. The predefined references are Ref. 100/0/75/0 (0 set-up color bars), Ref. 75/7.5/75/7.5 (EIA or SMPTE color bars), and Ref. 100/7.5/75/7.5 (FCC color bars). Table 2-2 lists these color bar reference values.

**Table 2-2: Predefined ColorBar Reference Values**

Reference Values for 100/0/75/0 (0% Setup) Color Bars								
Parameters	White	Yellow	Cyan	Green	Magenta	Red	Blue	Black
Luma Level	714.3	476.8	375.0	316.1	219.6	160.7	58.9	0.0
Chroma Level	0.0	480.2	681.2	636.2	636.2	681.2	480.2	0.0
Chroma Phase	0.0	167.1	283.4	240.8	60.8	103.4	347.1	0.0
Reference Values for 75/7.5/75/7.5 (EIA or SMPTE) Color Bars								
Parameters	White	Yellow	Cyan	Green	Magenta	Red	Blue	Black
Luma Level	549.1	494.6	400.4	345.9	256.7	202.2	108.1	53.6
Chroma Level	0.0	444.2	630.1	588.5	588.5	630.1	444.2	0.0
Chroma Phase	0.0	167.1	283.4	240.8	60.8	103.4	347.1	0.0
Reference Values for 100/7.5/75/7.5 (FCC) Color Bars								
Parameters	White	Yellow	Cyan	Green	Magenta	Red	Blue	Black
Luma Level	714.3	494.6	400.4	345.9	256.7	202.2	108.1	53.6
Chroma Level	0.0	444.2	630.1	588.5	588.5	630.1	444.2	0.0
Chroma Phase	0.0	167.1	283.4	240.8	60.8	103.4	347.1	0.0

## ColorBar Menu

Pressing the Menu button when the ColorBar measurement runs displays the ColorBar menu (Figure 2-20).

### Main Menu

#### Average Num

Average Num specifies the weighting factor to use for averaging. The Average Num range is 1 to 256. The default value is 32. To change the Average Num value, touch the Average Num soft key to highlight it, rotate the knob until the desired weighting factor appears, then touch the Average Num soft key again.

#### Reference

Reference displays the Reference submenu which (1) stores the currently displayed values for use as a reference; or (2) displays previously stored reference values.

**Main Menu**

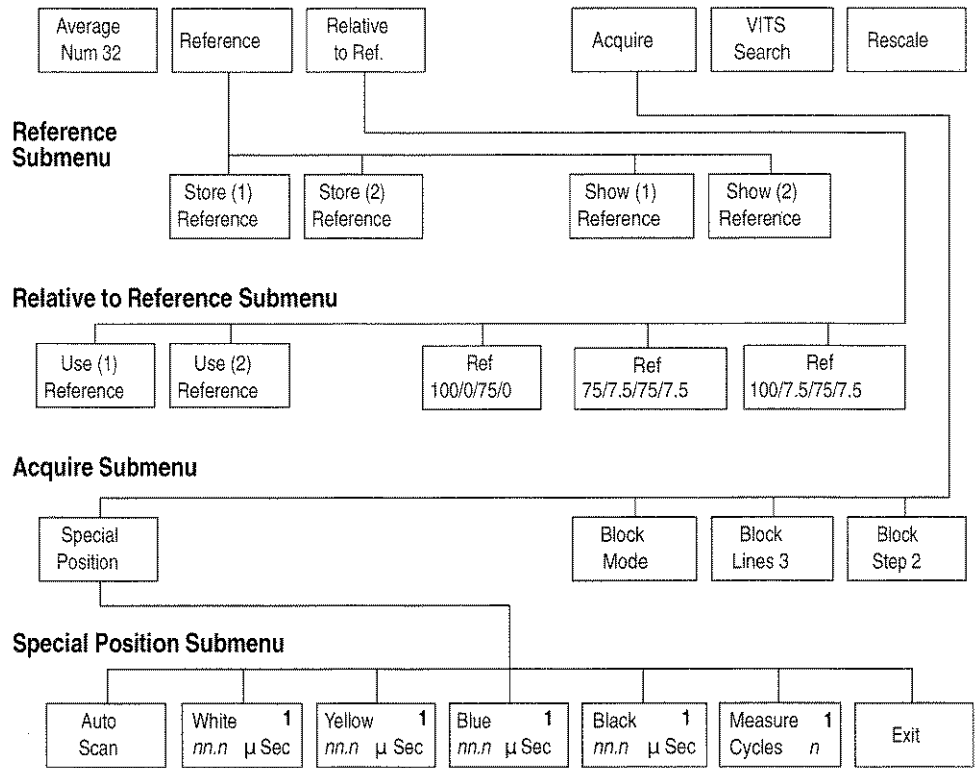

<sup>1</sup> Appears when Auto Scan is not selected.

**Figure 2–20: ColorBar menu tree**

**Relative to Ref.** Relative to Ref. displays the Relative to Reference submenu which selects the reference to use for comparison in the measurement. When a stored reference is selected, the currently measured value is compared to the stored reference value.

**Acquire** Acquire displays the Acquire submenu that controls how the signal is acquired for the specific measurement.

**VITS Search** VITS Search searches the insertion test signals for a signal appropriate for the measurement. If an appropriate signal is not located, the message Not found displays briefly.

**Rescale** Rescale sets the expansion factor of the display to an appropriate scaling factor for the ColorBar measurement display graticule. The x- and y-axes adjust to accommodate the rescaled display.

### Reference Submenu

- Store (n)  
Reference** Store (1) Reference/Store (2) Reference saves the current measurement values as (1) Reference and (2) Reference, respectively. Selecting Store (1) Reference or Store (2) Reference overwrites previous (1) Reference or (2) Reference values. References are stored in nonvolatile memory and are retained when the VM700T is powered down.
- Show (n)  
Reference** Show (1) Reference/Show (2) Reference displays the current values of (1) Reference and (2) Reference, respectively, plus the date and time the reference was stored and the channel the reference signal was on. If no reference value has been stored, touching either soft key displays a message that the reference is not defined.

### Relative to Reference Submenu

- Use (n)  
Reference** Use (1) Reference/Use (2) Reference selects the stored reference to which measured values are compared. If no reference value has been stored, touching either soft key displays a message that the reference is not defined.
- Ref.  
100/0/75/0** Ref. 100/0/75/0 selects the nominal 75% saturation, 0% setup colorbar reference for measurement comparison.
- Ref.  
75/7.5/75/7.5** Ref. 75/7.5/75/7.5 selects the nominal 75% saturation, 7.5% setup colorbar reference for measurement comparison.
- Ref.  
100/7.5/75/7.5** Ref. 100/7.5/75/7.5 selects the nominal 75% saturation, 7.5% setup colorbar with 100 IRE white flag for measurement comparison.

### Acquire Submenu

- Field  
Toggle** Field Toggle behaves the same as the Field Toggle soft key in Select Line mode: the system line changes to the other field, an offset of  $\pm 313$  lines. Field Toggle is provided in the Acquire submenu because at the submenu level, the Select Line button only activates line selection through the control knob. (The Select Line menu does not appear when a submenu is in effect.)
- Special  
Position** Special Position provides a group of soft keys and a waveform display used to set the locations on the waveform where the measurement is made. Figure 2-21 shows the ColorBar Special Position display.

<b>Block Mode</b>	Block Mode turns on Block mode. The block starts at the system line.
<b>Block Lines</b>	Block Lines sets the number of lines to average for the measurement. The default number of Block Lines to average is 3.
<b>Block Step</b>	Block Step sets the number of lines to step in the block. The default number of lines to step is 2.

### Special Position Submenu

<b>Auto Scan</b>	Auto Scan, when selected, scans the waveform and automatically determines measurement locations. Deselecting this soft key displays the White, Yellow, Blue, Black, and Measure soft keys.
------------------	--

---

**NOTE.** *If severe luminance nonlinear distortion is present, the VM700T may not be able to find all the color packets expected. In such cases, you must use manual positioning to set the location of each packet.*

---

<b>White</b>	White, when selected, allows you to adjust the center position of the white color packet with the knob.
<b>Yellow</b>	Yellow, when selected, allows you to adjust the center position of the yellow color packet with the knob.
<b>Blue</b>	Blue, when selected, allows you to adjust the center position of the blue color packet with the knob.
<b>Black</b>	Black, when selected, allows you to adjust the center position of the black color packet with the knob.
<b>Measure Cycles</b>	Measure Cycles allows you to specify the number of chrominance subcarrier cycles measured in each chrominance packet. The width of the displayed boxes shows the entire measurement area determined by the selected number of cycles.
<b>Exit</b>	Exit leaves the Special Position display and returns to the ColorBar main measurement display.

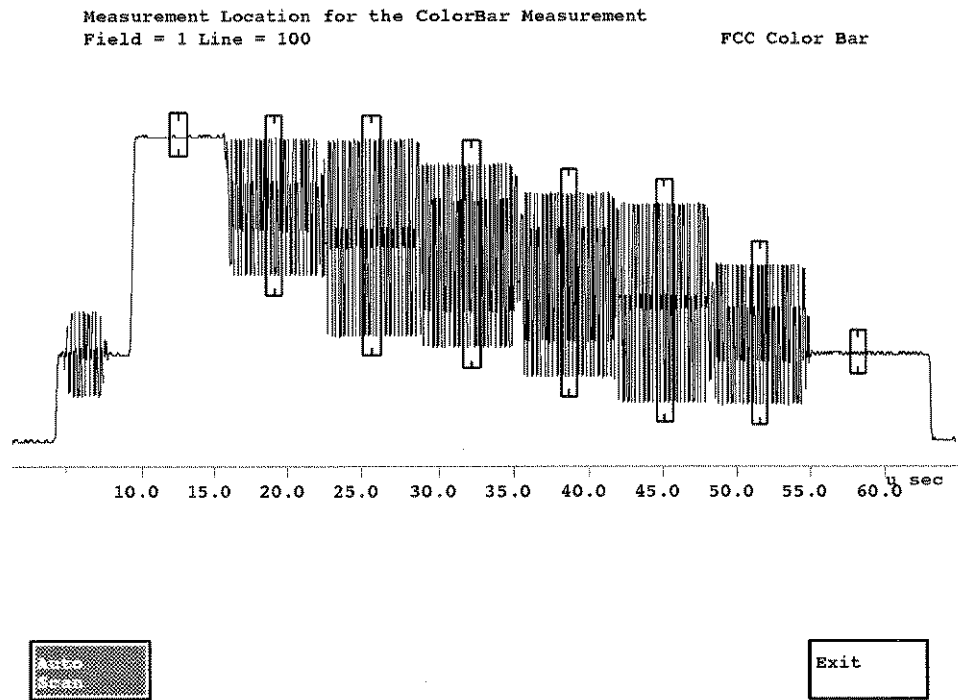

Figure 2-21: ColorBar Special Position display

## DGDP (Differential Gain Differential Phase)

The DGDP Measurement measures differential gain and phase.

### DGDP Display

Figure 2-22 shows the DGDP display. The top half plots the differential gain for each packet. A digital readout for each packet shows the differential gain value, expressed as a percentage of the reference amplitude. Additional digital readouts show the minimum and maximum differential gain values, as well as the value of the peak-to-peak amplitude divided by the maximum packet value.

The lower half plots the differential phase for each packet, expressed in degrees of phase difference from the reference packet. Additional digital readouts show the minimum, maximum, and peak-to-peak values for differential phase.

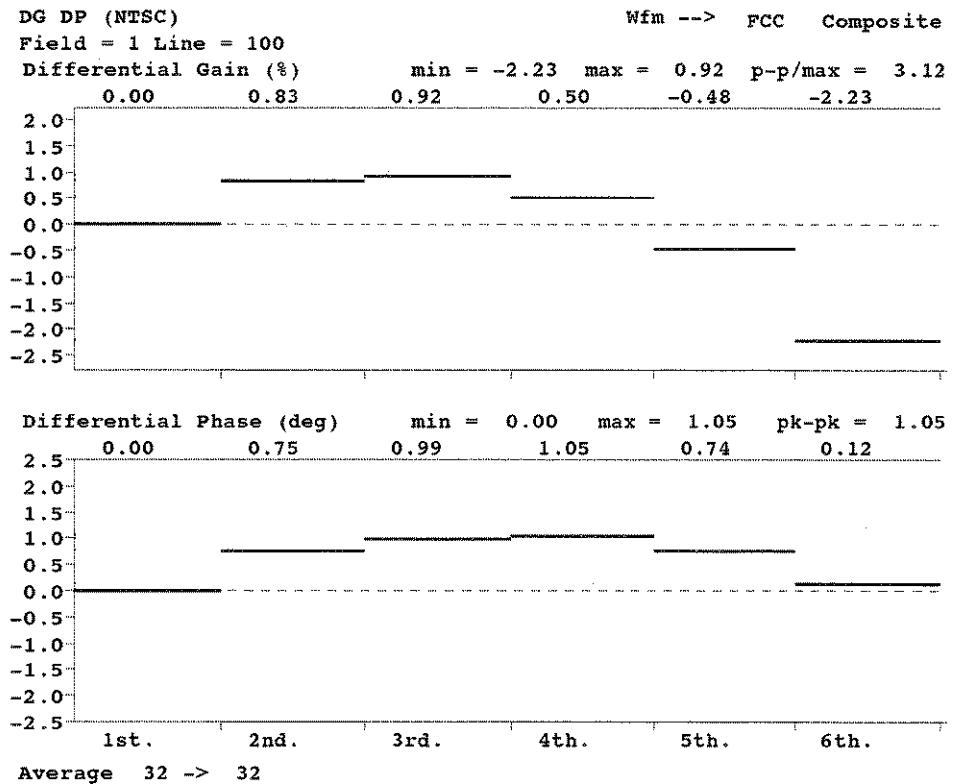

Figure 2-22: DGDP display

The DGDP measurement can use an FCC Composite, NTC-7 Composite, or 5- or 10-step modulated staircase signal. The essential signal element is a modulated staircase (up to 10 steps).



**DGDP Menu** Pressing the Menu button when the DGDP measurement runs displays the DGDP menu (Figure 2–23).

**Main Menu**

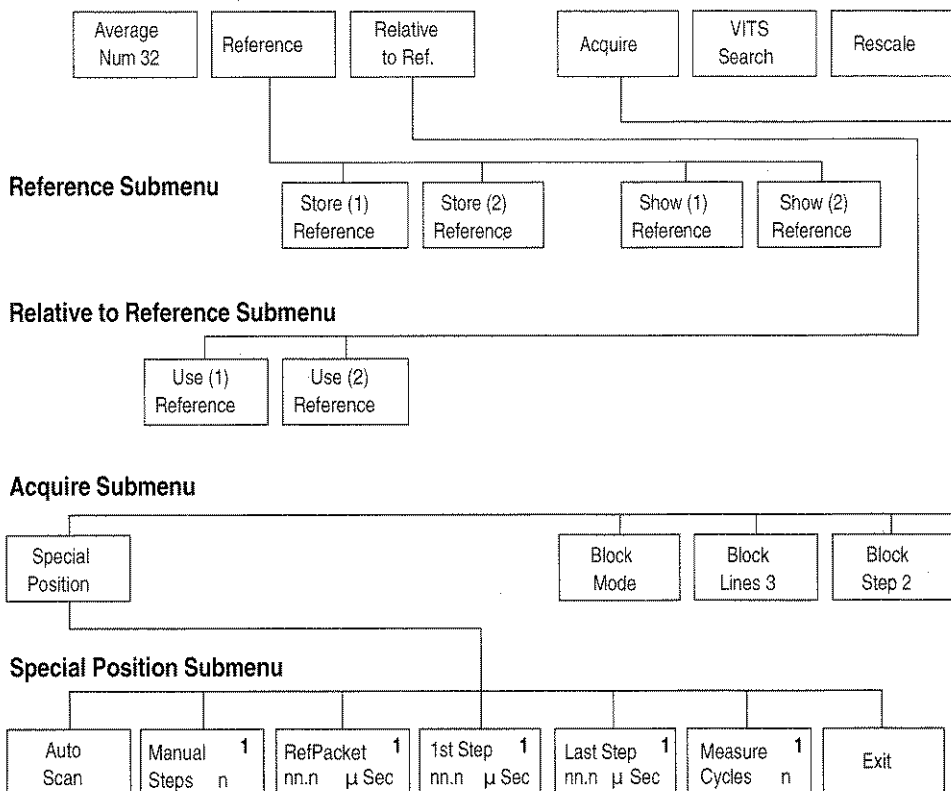

<sup>1</sup>Appears when Auto Scan is not selected.

**Figure 2–23: DGDP menu tree**

**Main Menu**

**Average Num**

Average Num specifies the weighting factor to use for averaging. The Average Num range is 1 to 256. The default value is 32. To change the Average Num value, touch the Average Num soft key to highlight it, rotate the knob until the desired weighting factor appears, then touch the Average Num soft key again.

- Reference** Reference displays the Reference submenu with which you can store the currently displayed values for use as a reference or display previously stored reference values.
- Relative to Reference** Relative to Reference displays the Reference submenu with which you can select the reference to use for comparison in the measurement. When a stored reference is selected, the currently measured value is compared to the stored reference value.
- Acquire** Acquire displays the Acquire submenu that controls how the signal is acquired for the specific measurement.
- VITS Search** VITS Search searches the insertion test signals for a signal appropriate for the measurement. If an appropriate signal is not located, the message "Not found" displays briefly on the display.
- Rescale** Rescale sets the expansion factor of the display to an appropriate scaling factor for the DGDP measurement display graticule. The x- and y-axes adjust to accommodate the rescaled display.

#### Reference Submenu

- Store (n) Reference** Store (1) Reference/Store (2) Reference saves the current measurement values as (1) Reference and (2) Reference, respectively. Selecting Store (1) Reference or Store (2) Reference overwrites previous (1) Reference or (2) Reference values. References are stored in nonvolatile memory and are retained when the VM700T is powered down.
- Show (n) Reference** Show (1) Reference/Show (2) Reference displays the current values of (1) Reference and (2) Reference, respectively, plus the date and time the reference was stored and the channel the reference signal was on. If no reference value has been stored, touching either soft key displays a message that the reference is not defined.

#### Relative to Reference Submenu

- Use (1) Reference** Use (1) Reference/Use (2) Reference selects the stored reference to which measured values are compared. If no reference value has been stored, touching either soft key displays a message that the reference is not defined.

### Acquire Submenu

<b>Special Position</b>	Special Position displays the Special Position submenu that sets the locations on the waveform where the measurement is made. Figure 2-24 shows the DGDP Special Position display.
<b>Block Mode</b>	Block Mode turns on Block mode. The block starts at the system line.
<b>Block Lines</b>	Block Lines sets the number of lines to average for the measurement. The default number of Block Lines to average is 3.
<b>Block Step</b>	Block Step sets the number of lines to step in the block. The default number of lines to step is 2.

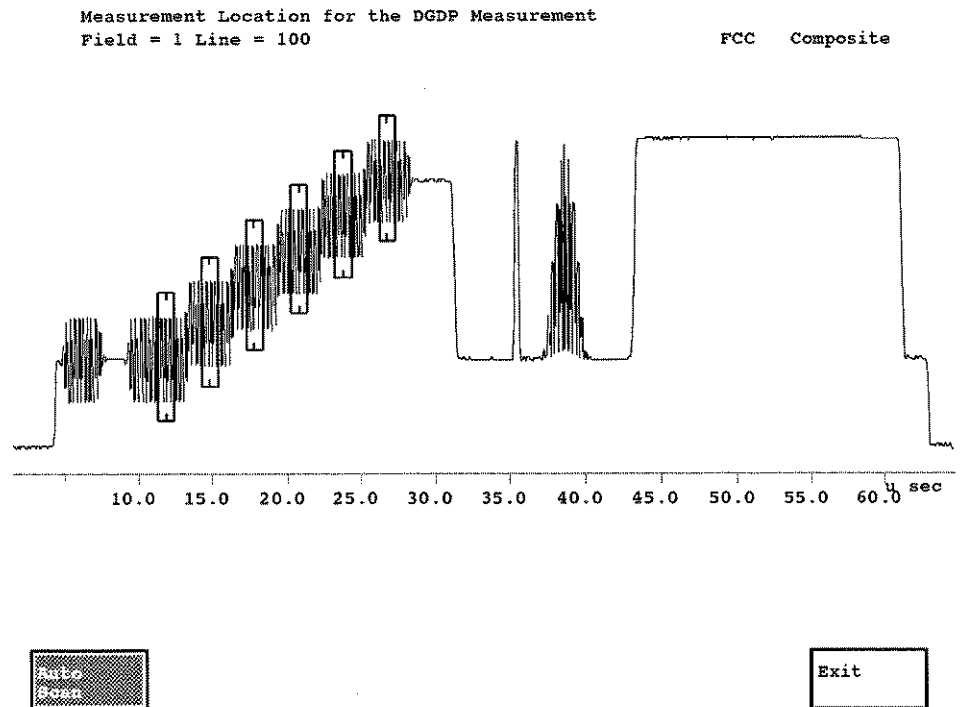

Figure 2-24: DGDP Special Position display

**Special Position Submenu**

**Auto Scan** Auto Scan, when highlighted, automatically scans and determines measurement locations. When deselected, the VM700T displays soft keys to set measurement locations manually.

---

**NOTE.** *If severe luminance nonlinear distortion is present, the VM700T may not be able to resolve all the steps that were present in the original signal. In such cases, you must use manual positioning to set the location of each staircase step.*

---

**Manual Steps** Manual Steps allows you to select the number of luminance steps in the signal by rotating the knob.

**Ref Packet** Ref Packet allows you to select the position of the reference packet by rotating the knob. Normally, the reference packet should be the center of the first packet of the modulated staircase.

**1st Step** 1st Step allows you to select the position of the first luminance step edge of the staircase by rotating the knob.

**Last Step** Last Step allows you to select the position of the last luminance step edge of the staircase by rotating the knob.

**Measure Cycles** Measure Cycles allows you to select the number of chrominance subcarrier cycles measured in each chrominance packet. The width of the displayed box shows the entire measurement area determined by the selected number of cycles.

**Exit** Exit leaves the Special Position submenu and displays the DGDP screen.

## GroupDelay SinX\_X

GroupDelay SinX\_X measures group delay and amplitude response versus frequency. This measurement requires a  $\sin(x)/x$  signal. The VM700T is set up to use a  $\sin(x)/x$  signal from a 1910 signal generator by default; if the signal is generated by a different source, you may need to use the Special Position submenu of the Acquire soft key to specify the first and second pulse positions in the test signal. The time between the two pulses should always be a multiple of  $1/(4f_{sc})$ .

Figure 2-25 shows the GroupDelay SinX\_X Combined Pulse display. The top half of the display plots overall amplitude (in dB) versus frequency (in MHz). The bottom half of the display plots overall group delay (in nanoseconds) versus frequency (in MHz).

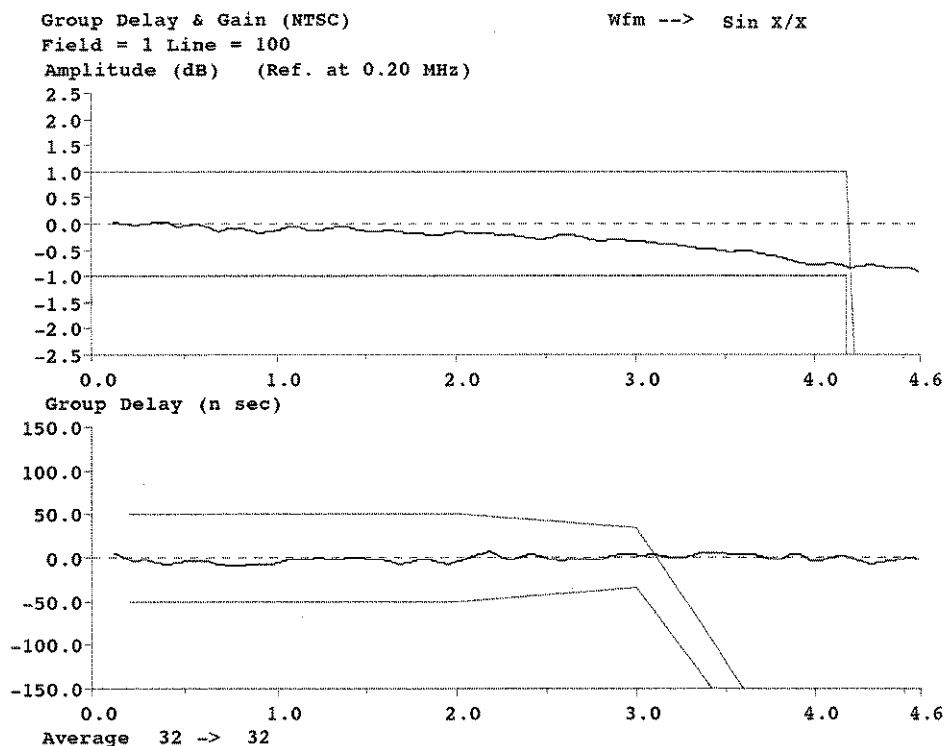
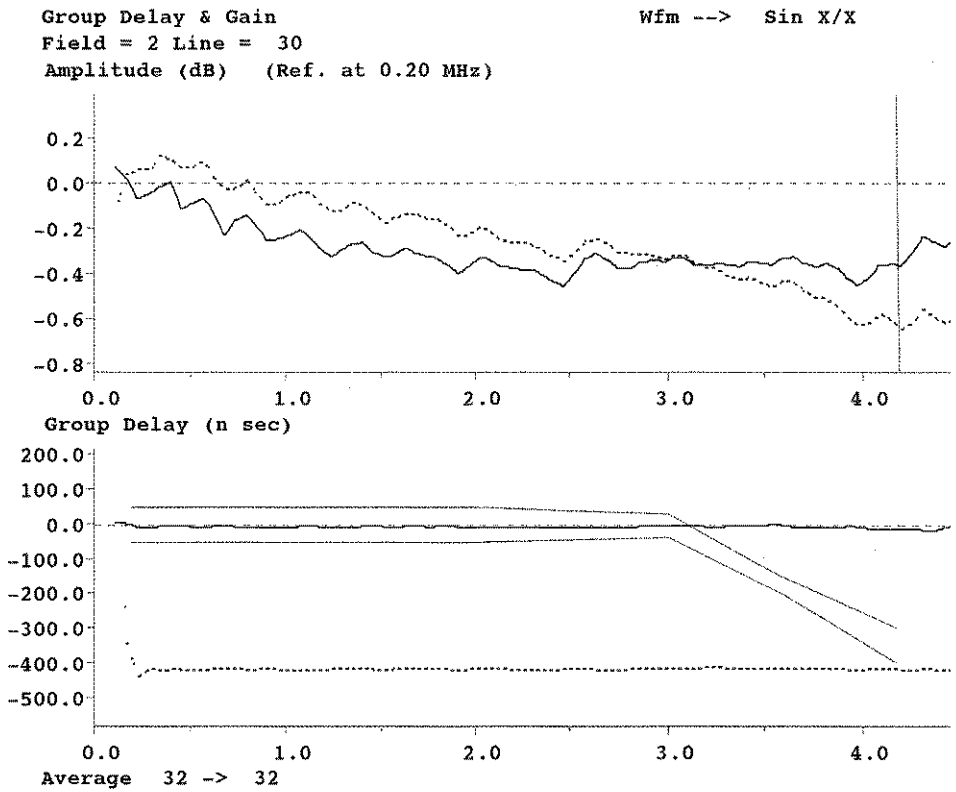

Figure 2-25: GroupDelay SinX\_X Combined Pulse response display



**Figure 2-26: GroupDelay SinX\_X BothPulse response display**

Figure 2-26 shows the Group Delay SinX\_X BothPulse display. This display is used to compare the frequency response of the upward and downward  $\sin x/x$  pulses. Nonlinearities cause a different response gain for different input signal levels, and the two pulses show different frequency responses curves. This is demonstrated in the BothPulse Response display of Figure 2-26. The solid line is the curve for the upward pulse, and the dotted line is the curve for the downward pulse. The scale of the amplitude display has been expanded to easily show the gain difference in the two responses.

**GroupDelay SinX\_X Menu**

Pressing the Menu button when the GroupDelay SinX\_X measurement runs displays the GroupDelay SinX\_X menu (Figure 2-27).

**Main Menu**

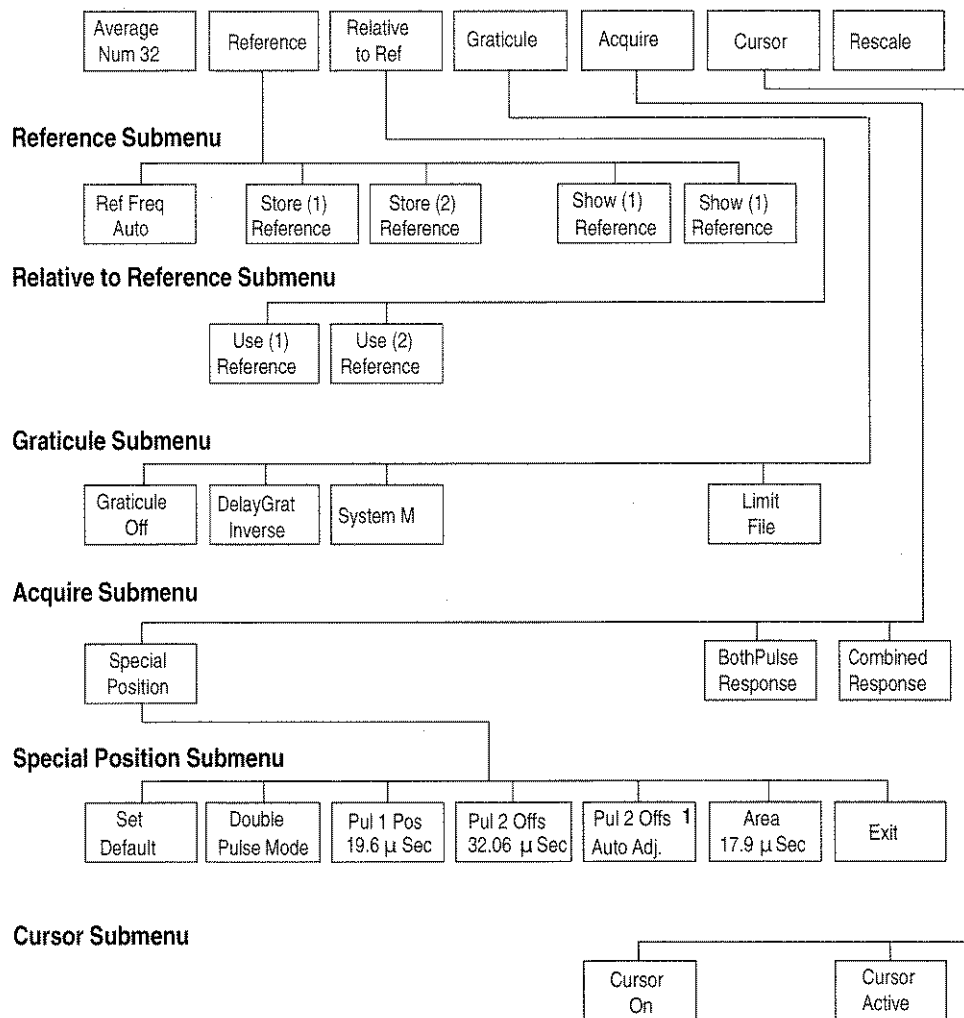

<sup>1</sup> Displayed when Pul2 Offs is selected.

**Figure 2-27: GroupDelay SinX\_X menu tree**

**Main Menu**

- Average Num** Average Num specifies the weighting factor to use for averaging. The Average Num range is 1 to 256. The default value is 32. To change the Average Num value, touch the Average Num soft key to highlight it, rotate the knob until the desired weighting factor appears, then touch the Average Num soft key again.
- Reference** Reference displays the Reference submenu which (1) stores the currently displayed values for use as a reference; or (2) displays previously stored reference values.
- Relative to Reference** Relative to Reference displays the Reference submenu which selects the reference to use for comparison in the measurement. When a stored reference is selected, the currently measured value is compared to the stored reference value.
- Graticule** Graticule displays the Graticule submenu which selects the graticule.
- Acquire** Acquire displays the Acquire submenu that controls how the signal is acquired for the specific measurement.
- Cursor** Cursor displays the Cursor submenu that displays and activates the cursors. Readouts give the measurement values at the frequency location of the cursor.
- Rescale** Rescale sets the expansion factor of the display to an appropriate scaling factor for the GroupDelay SinX\_X measurement display graticule. The x- and y-axes adjust to accommodate the rescaled display.



### Reference Submenu

- Ref Freq.** Ref. Freq. sets the reference value for delay and amplitude by turning the knob. Possible values are from 0.14 to 4.45 MHz. Below the 0.14 MHz level is AUTO, which sets the reference position automatically.
- Store (n) Reference** Store (1) Reference/Store (2) Reference saves the current measurement values as (1) Reference and (2) Reference, respectively. Selecting Store (1) Reference or Store (2) Reference overwrites previous (1) Reference or (2) Reference values. References are stored in nonvolatile memory and are retained when the VM700T is turned off.
- Show (n) Reference** Show (1) Reference/Show (2) Reference displays the current values of (1) Reference and (2) Reference, respectively, plus the date and time the reference was stored and the channel the reference signal was on. If no reference value has been stored, touching either soft key displays a message that the reference is not defined.

### Relative to Reference Submenu

- Use (n) Reference** Use (1) Reference/Use (2) Reference selects the stored reference to which measured values are compared. If no reference value has been stored, touching either soft key displays a message that the reference is not defined.

### Graticule Submenu

- Graticule Off** Graticule Off turns the graticule off.
- DelayGrat Inverse** DelayGrat Inverse inverts the graticule so that it matches both the pre-correction in the transmitter and the group delay curve of the receiver.
- System M** System M selects the System M graticule.
- Limit File** Limit File uses the values in the Measurement Limits file to create the graticule.

### Acquire Submenu

<b>Special Position</b>	Special Position displays the Special Position submenu that sets the locations on the waveform where the measurement is made. Figure 2–28 shows the GroupDelay SinX_X Special Position display.
<b>BothPulse Response</b>	BothPulse Response displays responses for both the upward sinx/x and the downward sinx/x pulses. This display is very useful to check for nonlinearities in gain and group delay between two different levels in the signal.
<b>Combined Response</b>	Combined Response displays a single overall system response curve for gain and group delay. The responses of the upward and downward sinx/x pulses are combined before the overall frequency response is computed.

### Special Position Submenu

<b>Set Default</b>	Set Default returns each measurement location to its default position as determined by the sinx/x signal generated by the Tektronix 1910 Digital Generator. If any other soft key is highlighted, only that measurement location is changed.
<b>Double Pulse Mode</b>	Double Pulse Mode, when highlighted, causes the VM700T to average both upward and downward pulses, and then compute the measurement. When deselected, the VM700T uses a single upward pulse to enable this measurement with a sine-squared pulse. This soft key should normally be highlighted to avoid errors caused by nonlinear distortion.

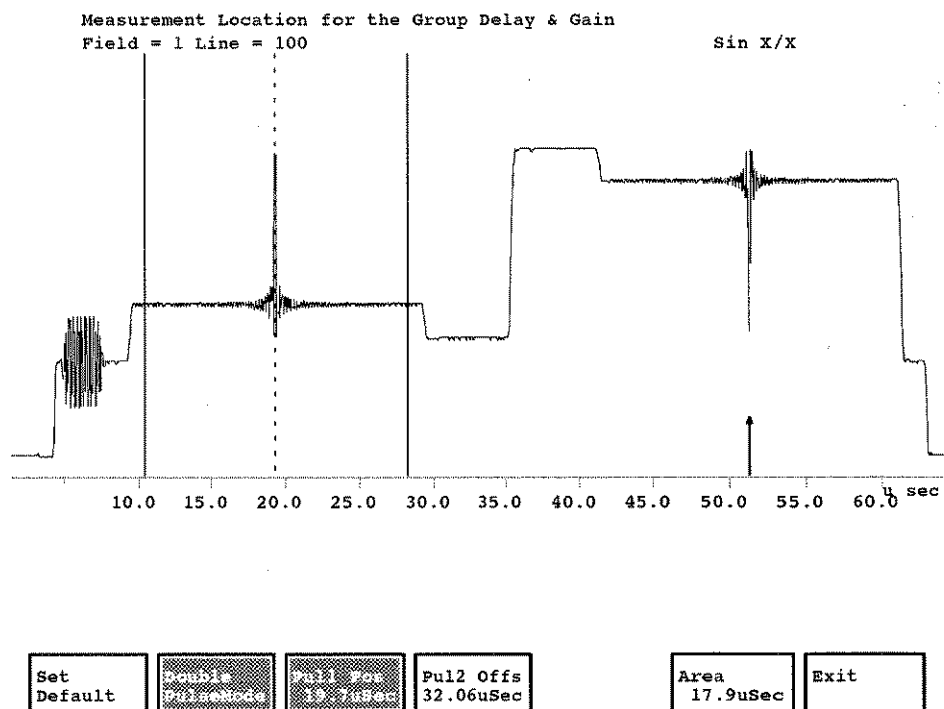

Figure 2-28: GroupDelay SinX\_X Special Position display

- Pul 1 Pos** Pul 1 Pos sets the location of the left-hand upward pulse. A dotted line on the display indicates the approximate position.
- Pul 2 Offs** Pul 2 Offs sets the location of the right-hand downward pulse, expressed as an offset from the left-hand upward pulse location. Use the default value, or touch the Auto Adjust soft key to precisely set this offset. This offset is critical for correct measurement of the signal.
- Pul 2 Offs Auto Adj** Pul 2 Offs Auto Adj precisely adjusts the location of the right-hand downward pulse, expressed as an offset from the left-hand upward pulse location.
- Area** Area changes the measurement area to allow the measurement to use on Composite Test Signals, etc. For best results, use the largest value possible. Smaller areas may result in lost low-frequency accuracy and reduced frequency resolution.
- Exit** Exit leaves the Special Position submenu and displays the GroupDelay SinX\_X screen.

**Cursor Submenu**

- Cursor On**      Cursor On, when highlighted, displays the cursor. It appears in the same position it was in the last time it was active.
  
- Cursor Active**      Cursor Active, when highlighted, allows you to move the cursor by rotating the knob.

## H\_Blank

The H\_Blank measurement finds where horizontal blanking starts and ends within a field. The H\_Blank measurement can use any NTSC video signal for input.

### H\_Blank Display

Figure 2-29 shows the H\_Blank display. The zero point of the x-axis is the leading edge of sync. The y-axis consists of all the lines in the measured area of the field (lines 11 to 263 for field 1, lines 11 to 262 for field 2). The display plots the times at which each line crosses the H\_Blank measurement slice level (threshold).

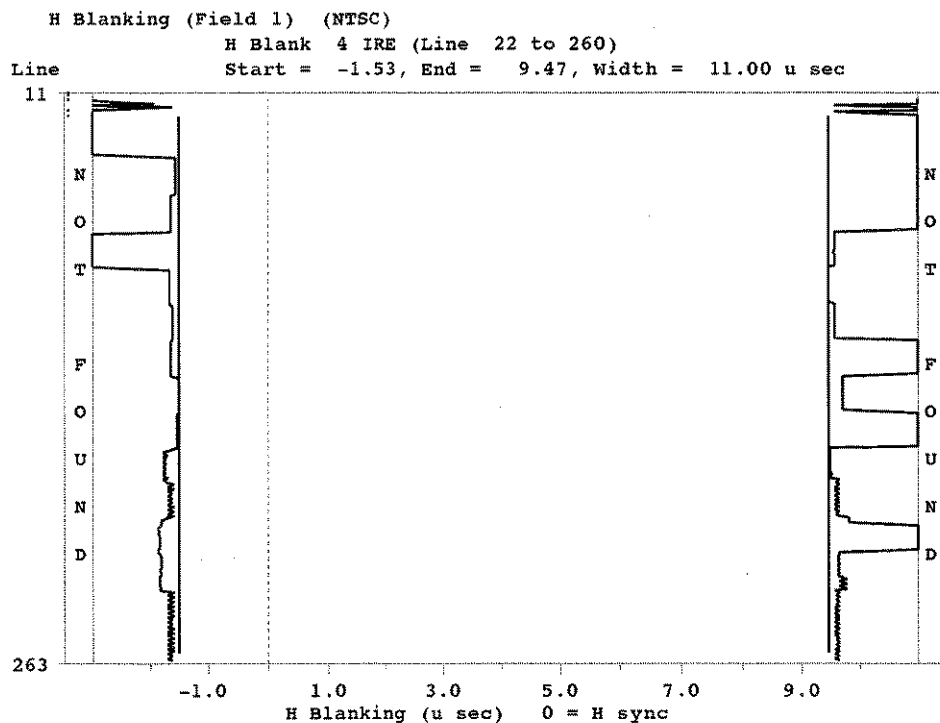
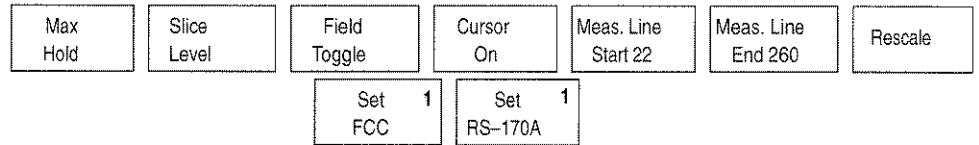

Figure 2-29: H\_Blank display

The slice level, or threshold, is the voltage that defines the start or end of the horizontal blanking interval. The left side of the display shows the time at which each line crosses the slice level voltage at the beginning of its horizontal blanking interval. The right side of the display shows the time at which each line crosses the slice level voltage to end its horizontal blanking interval. Digital readouts above the display show the minimum values for horizontal blanking (that is, the rightmost start time and the leftmost end time) over the range of lines selected.

**H\_Blank Menu** Pressing the Menu button when the H\_Blank measurement runs displays the H\_Blank menu (Figure 2–30).

**Main Menu**



<sup>1</sup> Displayed in place of the Field Toggle and Cursor On softkeys when Slice Level is selected.

**Figure 2–30: H\_Blank menu tree**

**Main Menu**

<b>Max Hold</b>	Max Hold, when highlighted, causes the measurement cursors to hold at the maximum unblanking positions. When deselected, the measurement cursors move to reflect the current unblanking positions.
<b>Slice Level</b>	Slice Level sets the blanking search level in IRE by rotating the knob. Possible values range from 4 to 99 IRE. The 100 IRE level is computed as 250% of sync level.
<b>Field Toggle</b>	Field Toggle displays the system line in the other field from that currently displayed.
<b>Set FCC</b>	Set FCC displays when the Slice Level soft key is highlighted; sets the slice level to 4 IRE.
<b>Cursor On</b>	Cursor On, when highlighted, the cursors show the minimum blanking interval over the range of lines being measured. On is the default.
<b>Set RS-170A</b>	Set RS-170A displays when the Slice Level soft key is highlighted; sets the slice level to 20 IRE.
<b>Meas. Line Start</b>	Meas. Line Start sets the measurement start line.
<b>Meas. Line End</b>	Meas. Line End sets the measurement end line.
<b>Rescale</b>	Rescale formats the display graticule to an appropriate resolution.

## H\_Timing

H\_Timing makes various measurements around H\_Sync. The H\_Timing measurement can use any video signal for input.

Figure 2-31 shows the horizontal sync pulse for the H\_Timing measurement. The timing measurements made and displayed are: sync to blanking start, sync to blanking end, sync to burst start (RS-170A), sync to burst end (FCC), burst width, sync width, burst level, sync rise time, sync fall time, sync level, and breezeway (FCC).

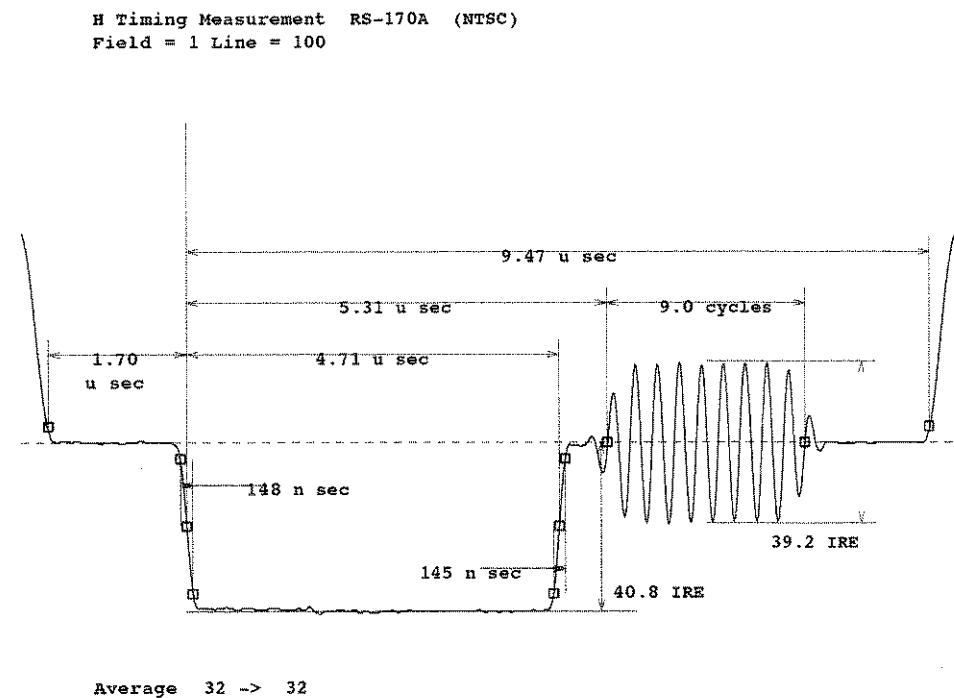

Figure 2-31: H\_Timing display

### H\_Timing Menu

Pressing the Menu button when the H\_Timing measurement runs displays the H\_Timing menu (Figure 2-32).

#### Main Menu

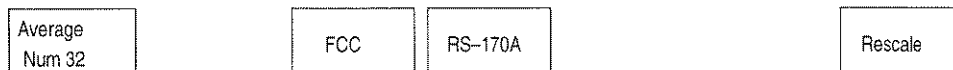

Figure 2-32: H\_Timing menu tree

**Main Menu**

- Average Num** Average Num specifies the weighting factor to use for averaging. The Average Num range is 1 to 256. The default value is 32. To change the Average Num value, touch the Average Num soft key to highlight it, rotate the knob until the desired weighting factor appears; then touch the Average Num soft key again.
- FCC** FCC, when highlighted, causes measurements to be based on the FCC standard.
- RS-170A** RS-170A, when highlighted, causes measurements to be based on the RS-170A standard.
- Rescale** Rescale sets the expansion factor of the display to an appropriate scaling factor for the H\_Timing measurement display graticule. The x- and y-axes adjust to accommodate the rescaled display.



## ICPM (Incidental Carrier Phase Modulation)

The ICPM measurement measures Incidental Carrier Phase Modulation of an RF carrier, using the quadrature output of a demodulator such as the Tektronix 1450 Series Demodulator Mainframe with a TDC-10 Tunable Down Converter or a TDC Fixed-Channel Down Converter for your channel. The Incidental Carrier Phase Modulation measurement is made on the staircase portion of either the FCC or NTC-7 Composite VITS signals. The Zero Carrier Pulse is required as an amplitude reference. This measurement requires that both the video output and the quadrature output of a demodulator be connected to the VM700T.

Video may be connected to either channel A or B, but the quadrature output must always be connected to the channel C input. The Zero Carrier Pulse must be enabled at the demodulator, and must be selected for use as a reference in the appropriate Measurement Locations file. The location of both the Zero Carrier Pulse and the Composite VITS, either FCC or NTC-7, are also specified in the appropriate Measurement Locations file.

Incidental Carrier Phase Modulation (ICPM) is a distortion that occurs in the transmitter when the phase of the modulated carrier is affected by the level of the modulating video signal. The amount by which the carrier phase is shifted is the ICPM error.

ICPM error is expressed in degrees and is defined as:

$$ICPM = \arctan(\text{quadrature amplitude}/\text{video amplitude})$$

ICPM errors produce different effects, depending on the type of demodulation used to recover the baseband signal from the transmitted signal. ICPM errors appear in synchronously demodulated signals as differential phase and many other types of distortions, but the baseband signal is generally not as seriously affected when envelope detection is used. The effects of ICPM errors are therefore rarely seen in the picture in home receivers, which typically use envelope detection.

However, ICPM errors may manifest themselves as audio buzz at the home receiver. In the intercarrier sound system, the picture carrier is mixed with the FM sound carrier to form a 4.5 MHz sound IF. Audio rate phase modulation in the picture carrier can therefore be transferred into the audio system and heard as a buzzing noise.

### ICPM Display

ICPM errors are measured by examining an XY plot of the VIDEO OUT versus QUADRATURE OUT outputs from a synchronous demodulator, using as input either a staircase signal of 5 or 10 steps, or a ramp. VIDEO OUT is plotted along the y axis with negative polarity (black is at the bottom, and indicates maximum transmitter output), while QUADRATURE OUT is plotted along the x axis. The origin of the system is in the horizontal center of the top of the display.

In the resulting plot, phase errors appear as a non-zero value from the QUADRATURE OUT output of the demodulator. If no ICPM errors are present, the plot appears as a succession of bright dots down the video-axis of the ICPM display output (Figure 2-33). When using a staircase test signal for the ICPM measurement, the curved lines that appear on the display are due either to transitions between successive levels of the test signal, or to the transition between the top of the staircase and the back porch. These curved lines can be ignored for purposes of this measurement.

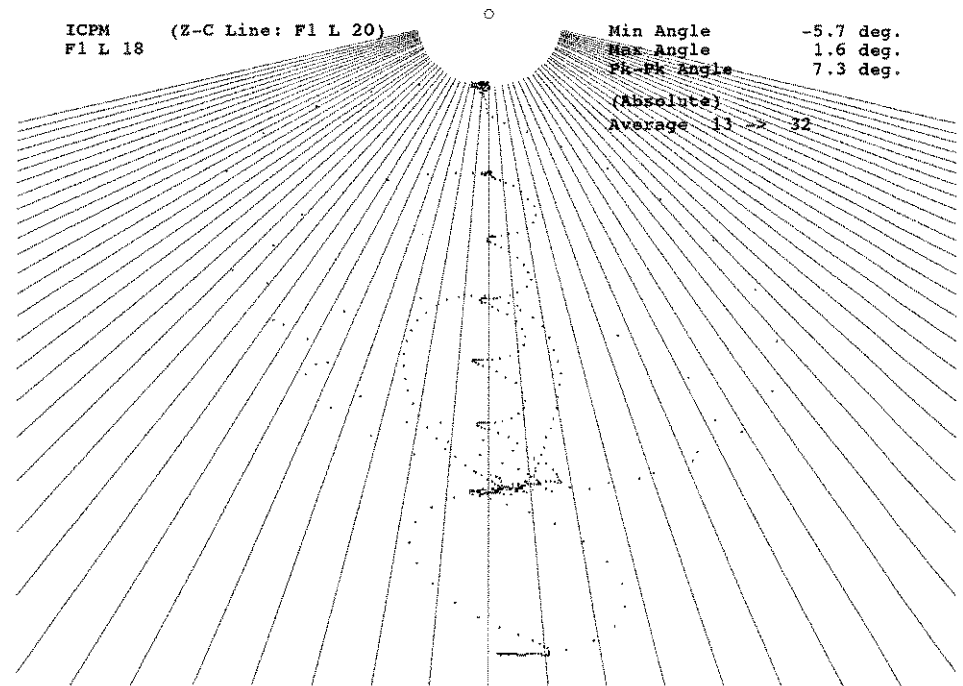

**Figure 2-33: ICPM display; no ICPM errors present**

If ICPM errors are present, phase errors will usually vary with amplitude, producing a tilted line of bright dots on the ICPM display (see Figure 2-34).

ICPM errors usually indicate a problem with the transmitter, or with modulator imbalance. (It is also remotely possible that a malfunctioning demodulator can give you a problem that looks like ICPM, but is not). Given that the demodulator is functioning correctly, however, ICPM errors generally indicate a linearity problem in the high-power stages of the transmitter.

Text on the left-hand side of the ICPM display shows the name of the measurement (ICPM), the line on which the measurement is being made, and the percentage of the nominal carrier amplitude being used as a data exclusion threshold for the measurement. Signal levels below the minimum or above the maximum percentage of the nominal carrier amplitude (the data exclusion threshold) are excluded from the measurement.

Text on the right-hand side of the ICPM display shows the minimum measured ICPM angle, the maximum measured ICPM angle, and the peak-to-peak measured ICPM angle (the difference between current maximum and minimum measured ICPM angles).

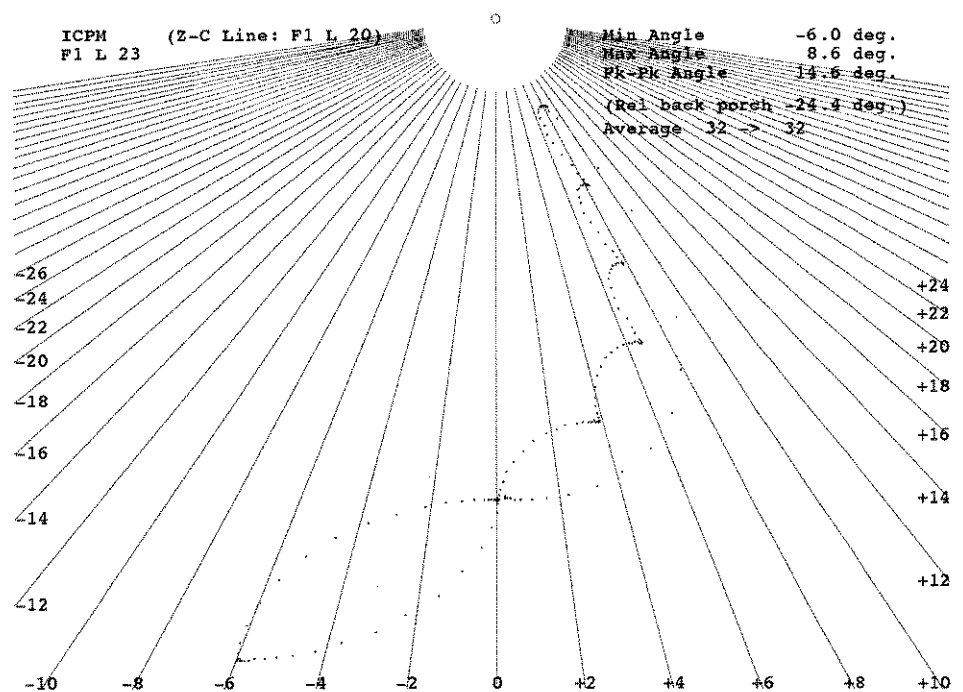

Figure 2-34: ICPM display; large ICPM error present

**ICPM Menu** Pressing the Menu button when the ICPM measurement runs displays the ICPM menu (Figure 2-35).

**Main Menu**

**Average Num** Average Num specifies the weighting factor to use for averaging. The Average Num range is 1 to 256. The default value is 32. To change the Average Num value, touch the Average Num soft key to highlight it, rotate the knob until the desired weighting factor appears; then touch the Average Num soft key again.

**Relative Backporch** Relative Backporch, when highlighted, causes the result angles to be measured relative to the angle at burst center. In addition, displayed points are adjusted in the left-right direction (the quadrature axis) to maintain relevance with the cursor, tracking lines, and polar graticule.

**Main Menu**

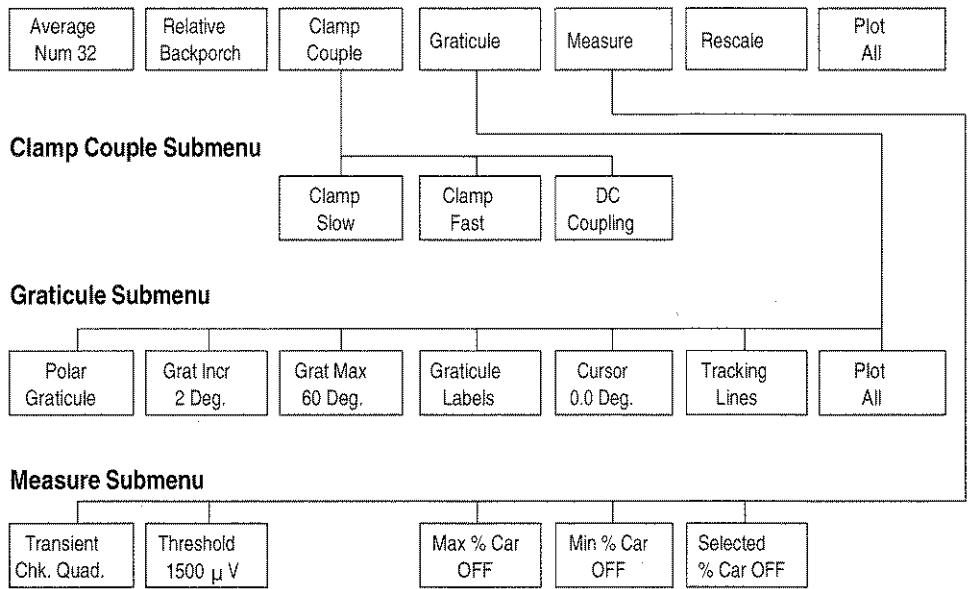

**Figure 2-35: ICPM menu tree**

**Clamp Couple** Clamp Couple displays the Clamp Couple submenu that sets the Clamping mode used by the ICPM measurement.

**Graticule** Graticule displays the Graticule submenu that controls the displayed graticule and the maximum-angle tracking lines.

**Measure** Measure displays the Measure submenu that determines which data points are used in the ICPM measurement.

<b>Rescale</b>	Rescale returns the reference point to the center of the screen, sets the left-right expansion for the quadrature axis to a comfortable value, and re-adjusts the top-bottom expansion for the video axis so that the sync level is at a predetermined point.
<b>Plot All</b>	Plot All, when highlighted, displays all sampled data points. When deselected, only points used in computing the ICPM measurement result display.

### Clamp Couple Submenu

<b>Clamp Slow</b>	Clamp Slow selects slow clamp speed. This speed allows hum effects to be visible, but is useful in coping with large DC offsets on an input signal.
<b>Clamp Fast</b>	Clamp Fast selects fast clamp speed. This speed removes DC offset, hum, and bounce effects from the signal. This is the default clamp setting for the ICPM measurement.
<b>DC Coupling</b>	DC Coupling selects DC coupling (no clamping).

### Graticule Submenu

<b>Polar Graticule</b>	Polar Graticule, when highlighted, displays a polar graticule on the screen and displays the Grat Incr, Grat Max, and Graticule Labels soft keys.
<b>Grat Incr 2 Deg.</b>	Grat Incr adjusts the increment between individual lines of the polar graticule with the knob. Possible values range from 1 degree to 30 degrees. Below the 1-degree setting is AUTO, which causes the graticule increment to be maintained at an optimum value based on the current expansion and position.
<b>Grat Max 60 Deg.</b>	Grat Max adjusts the maximum angle of displayed polar graticule lines. The maximum angle allowed is 89 degrees. Below the 1-degree setting is AUTO, which causes the maximum graticule angle to be maintained at an optimum value based on the current expansion and position.
<b>Graticule Labels</b>	Graticule Labels when highlighted, the polar graticule applies labeling numbers to the ends of its lines as they fit.
<b>Cursor 0.0 Deg.</b>	Cursor 0.0 Deg., when highlighted, lets the knob move the displayed value by tenths of a degree; a cursor that reflects this value displays on the screen.

- Tracking Lines** Tracking Lines, when highlighted, displays lines that follow the maximum and minimum ICPM angles.
- Plot All** Plot All, when highlighted, displays all sampled data points. When deselected, only points used in computing the ICPM measurement display. The soft keys under the Measure submenu determine which points are used in the measurement.

**Measure Submenu**

- Transient Chk. Quad.1** Transient Chk Quad chooses which data input to check when discarding values around too-large point-to-point transients before measuring the maximum and minimum ICPM. Choices are the quadrature or the video input.
- Threshold 1500  $\mu$ V** Threshold nnnn  $\mu$ V sets the threshold (in microvolts) for data point exclusion from the ICPM measurement. When two consecutive sample points are not within this voltage of each other, several points around them are discarded.
- Max % Car OFF** Max % Car sets the highest percent-of-carrier used in the ICPM measurement. When highlighted, any video input sample values above this percentage are discarded. When there is no maximum exclusion value, this soft key reads OFF.
- Min % Car OFF** Min % Car sets the lowest percent-of-carrier used in the ICPM measurement. When highlighted, any video input sample values below this percentage are discarded. When there is no minimum exclusion value, this soft key reads OFF.
- Selected % Car OFF** Selected % Car when highlighted, causes the currently highlighted Min % Car or Max % Car soft key to be set to OFF, and the appropriate edge-value exclusion is removed.

# Jitter

Jitter measures variation in horizontal sync timing over a single frame.

Figure 2-36 shows the Jitter display. Each line of the field is plotted along the y-axis, while time is plotted along the x-axis. The zero point of the x-axis is defined by the average position of the leading edge of sync over many frames for the range of lines being measured. The display plots the variation from this zero point for the leading edge of sync of each line in the measurement. A digital readout above the display shows the maximum value of jitter for the lines being measured.

The Jitter measurement can use any video signal as input.

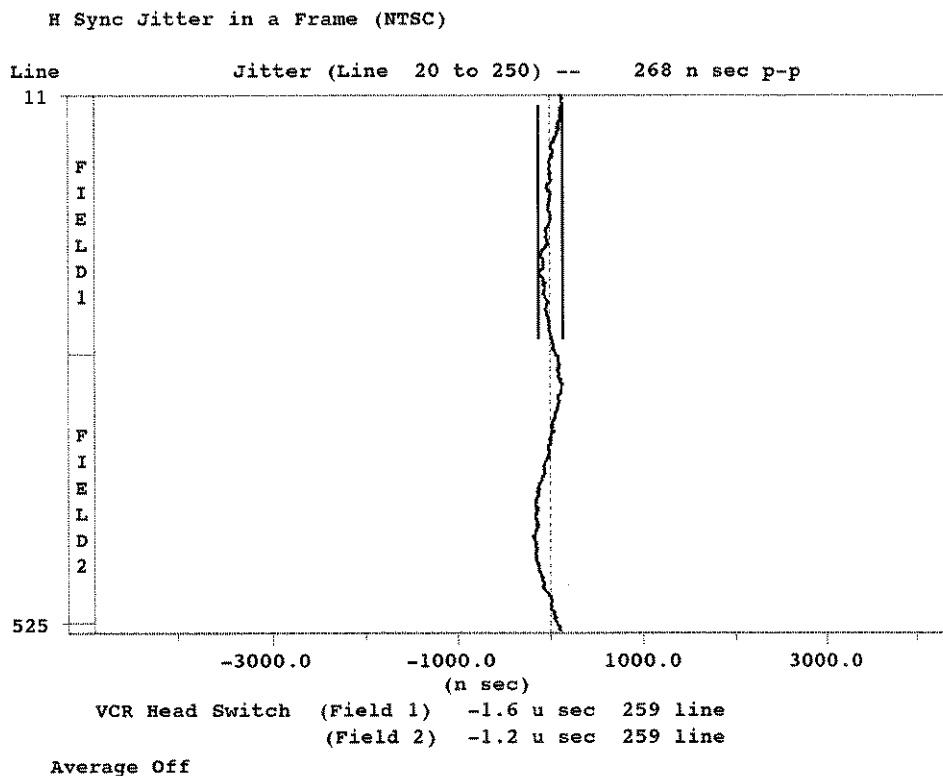

Figure 2-36: Jitter display

**Jitter Menu** Pressing the Menu button when the Jitter measurement runs displays the Jitter menu (Figure 2–37).

**Main Menu**



**Figure 2–37: Jitter menu tree**

**Main Menu**

**Average Num** Average Num specifies the weighting factor to use for averaging. The Average Num range is 1 to 256. The default value is 32. To change the Average Num value, touch the Average Num soft key to highlight it, rotate the knob until the desired weighting factor appears; then touch the Average Num soft key again.

**Max Hold** Max Hold, when highlighted, causes the measurement cursors to hold the positions of maximum jitter.

**Extract VCR.HD.SW** Extract VCR.HD.SW searches the bottom of the picture area for horizontal timing errors exceeding 100 ns. This position is assumed to be the head switching position for a VCR (video cassette recorder). The error thus found is extracted from the Jitter display, and the resulting values and locations display.

**Meas. Line Start** Meas. Line Start sets the measurement start line.

**Meas. Line End** Meas. Line End sets the measurement end line.

**Rescale** Rescale sets the expansion factor of the display to an appropriate scaling factor for the Jitter measurement display graticule. The x- and y-axes adjust to accommodate the rescaled display.



## Jitter Long\_Time

Jitter Long\_Time measures variations in frame period timing caused by tape transport servo wander in video tape recorders (VTR).

Figure 2-38 shows the Jitter Long\_Time spectrum display, plotting the variation in frame period timing (in dB, where 0 dB = 1 H) on the y-axis and frequency (in Hz) on the x-axis.

Figure 2-39 shows the Jitter Long\_Time waveform display, plotting frame period jitter (in  $\mu$ s or ns, depending on the scale of jitter) on the y-axis and time (in seconds) on the x-axis.

The Jitter Long\_Time measurement can use any video signal as input.

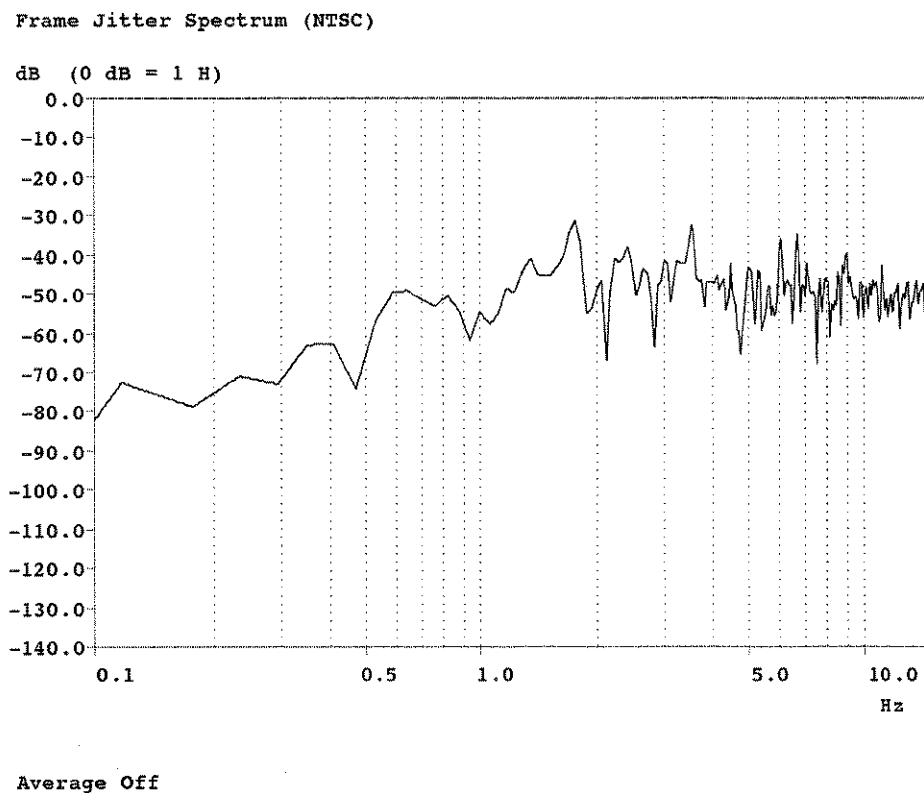

Figure 2-38: Jitter Long\_Time spectrum display

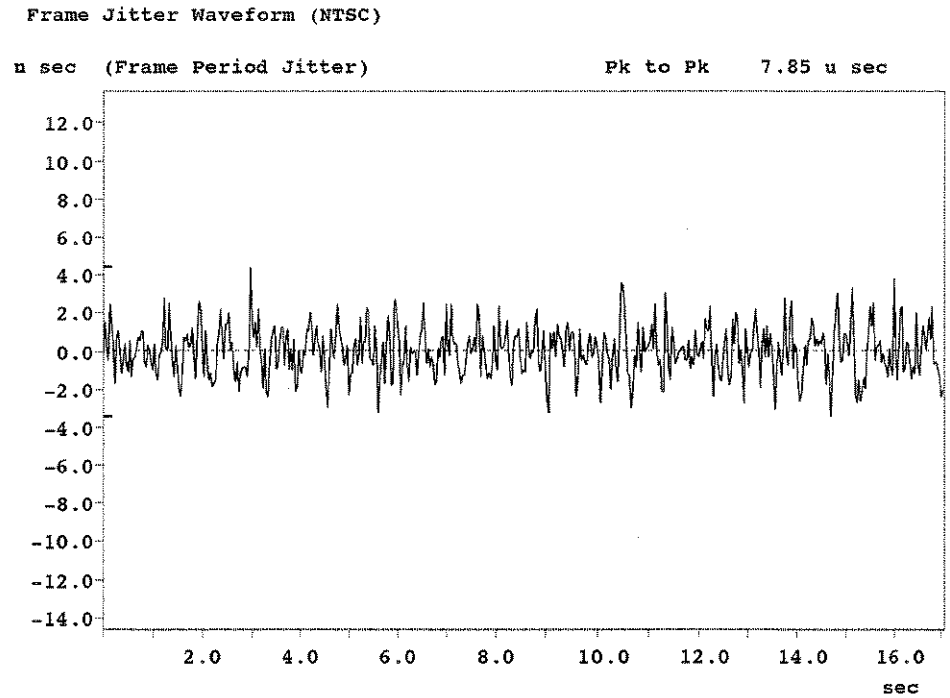

Figure 2-39: Jitter Long\_Time waveform display

**Jitter Long\_Time Menu**

Press the Menu button when the Jitter Long\_Time measurement is running to display the Jitter Long\_Time menu (Figure 2-40).

**Main Menu (1)**



**Main Menu (2)**

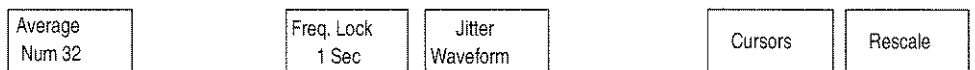

**Cursor Submenu**



Figure 2-40: Jitter Long\_Time menu tree

## Main Menu

<b>Average Num</b>	Average Num specifies the weighting factor to use for averaging when the Spectrum display is selected. The Average Num range is 1 to 256. The default value is 32. To change the Average Num value, touch the Average Num soft key to highlight it, rotate the knob until the desired weighting factor appears; then touch the Average Num soft key again.
<b>Freq. Lock</b>	Freq. Lock sets the time constant of the locking loop.
<b>Spectrum Display</b>	Spectrum Display shows the spectrum of the jitter waveform, using an FFT with a Hanning window. Main menu 2 becomes available with the Spectrum display.
<b>Jitter Waveform</b>	Jitter Waveform displays the “rolled” jitter waveform. Main menu 1 becomes available with the Jitter waveform display.
<b>Cursors</b>	Cursors provides soft keys to display and activate the two cursors in the Spectrum display. Readouts for the cursors give the value in decibels (peak-to-peak) at the frequency locations of the cursors.
<b>Rescale</b>	Rescale sets the expansion factor of the display to an appropriate scaling factor for the Jitter Long_Time measurement display graticule. The x- and y-axes adjust to accommodate the rescaled display.

## Cursors Submenu

<b>Cursor 1 On</b>	Cursor 1 On, when highlighted, turns on Cursor 1 (the solid line cursor) in the display. When not highlighted, Cursor 1 is not displayed.
<b>Cursor 2 On</b>	Cursor 2 On, when highlighted, turns on Cursor 2 (the dashed line cursor) in the display. When not highlighted, Cursor 2 is not displayed.
<b>Cursor 1 Active</b>	Cursor 1 Active, when highlighted, assigns the control knob to positioning of cursor 1. If cursor 1 is not on when Cursor 1 Active is selected, cursor 1 is turned on.
<b>Cursor 2 Active</b>	Cursor 2 Active, when highlighted, assigns the control knob to positioning of cursor 2. If cursor 2 is not on when Cursor 2 Active is selected, cursor 2 is turned on.

## K\_Factor

K\_Factor measures K-2T, K-PB, and Pulse-to-Bar Ratio. The K\_Factor measurement can use an FCC Composite, NTC-7 Composite, or a Tektronix generator 2T Pulse & Bar signal for input. The essential element of the input signal is a 2T pulse. A bar is also needed for measured K-PB and Pulse-to-Bar ratio.

Figure 2-41 shows a typical K\_Factor measurement display with the left and right references averaged. The display shows the signal superimposed on the K-Factor graticule. Digital readouts also show the measured values of K-2T, K-PB, Pulse-to-Bar ratio, and HAD.

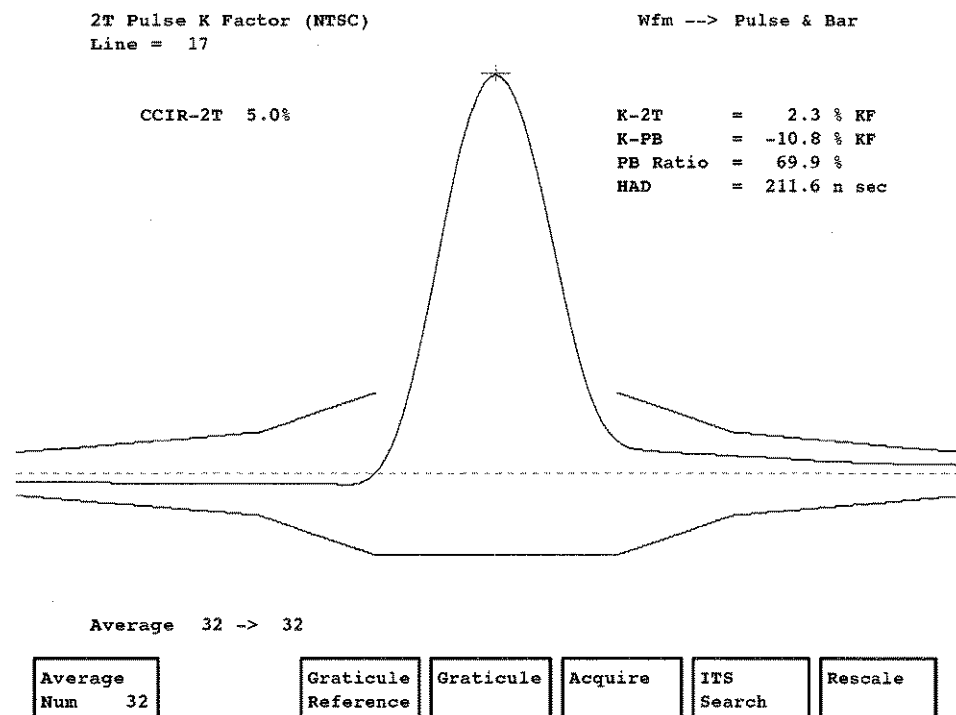

Figure 2-41: K-Factor display with top level menu

The K\_Factor measurement may produce different results if the test signal is severely distorted due to the way it aligns the 2T pulse to the measurement graticule. The firmware lets you select different references for the measurement.

The normal application uses an average level of both the left and the right graticule reference points (left end and right end of the graticule shown in the display) to align the waveform. However, if the waveform has line time distortion, both ends of the waveform may not be exactly on the center of the graticule.

A second example is if the waveform has ringing that hits the reference point with positive or negative ringing. In this case, the waveform may not look aligned to the application.

When this type of distortion occurs it may be necessary to use different references for either end of the K\_Factor waveform. The Graticule Reference menu soft keys and the functions they control assist in obtaining the correct measurement results.

## K\_Factor Menu

Pressing the Menu button when the K\_Factor measurement runs displays the K\_Factor menu (see Figure 2-41). Figure 2-42 shows the menu tree.

### Main Menu

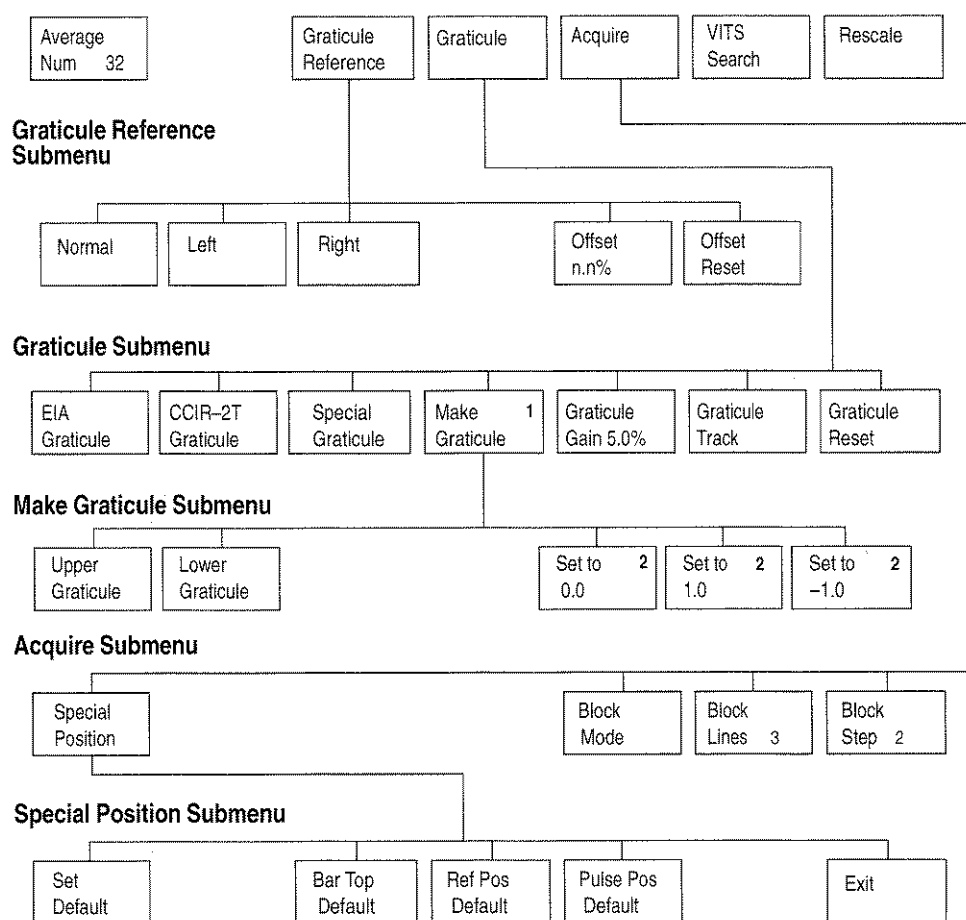

<sup>1</sup> Make Graticule appears only when Special Graticule is selected.

<sup>2</sup> The "Set to" choices appear only when a coefficient has been selected in one of the three editable graticule definition lines.

Figure 2-42: K\_Factor menu tree

**Main Menu**

- Average Num**      Average Num specifies the weighting factor to use for averaging. The Average Num range is 1 to 256. The default value is 32. To change the Average Num value, touch the Average Num soft key to highlight it, rotate the knob until the desired weighting factor appears; then touch the Average Num soft key again.
- Graticule Reference**      Graticule Reference provides soft keys for Graticule Reference, such as clamp waveform at the left, right, or both reference points of the graticule.
- Graticule**      Graticule provides soft keys to control the graticule gain and tracking of the current graticule, and to change from a standard graticule to a user-created graticule.
- Acquire**      Acquire displays a submenu of soft keys that control how the signal is acquired for the K\_Factor measurement.
- VITS Search**      VITS Search searches the insertion test signals for a signal appropriate for the measurement. If an appropriate signal is not located, the message "Not found" displays briefly on the screen.
- Rescale**      Rescale sets the expansion factor of the display to an appropriate scaling factor for the K\_Factor measurement display graticule. The x- and y-axes adjust to accommodate the rescaled display.

**Graticule Reference Submenu**

- Normal**      Normal clamps the waveform using the average of the left and right reference points of the graticule. Normal is the default reference.
- Left**      Left clamps the waveform using the left reference point of the graticule.
- Right**      Right clamps the waveform using the right reference point of the graticule (see Figure 2-43).
- Offset n.n%**      Offset n.n% adjust the graticule clamp offset (from -9.9% to 9.9% of pulse height) from the reference point selected with Normal, Left, or Right soft keys.
- Offset Reset**      Offset Reset returns the graticule clamp offset to 0.0%.

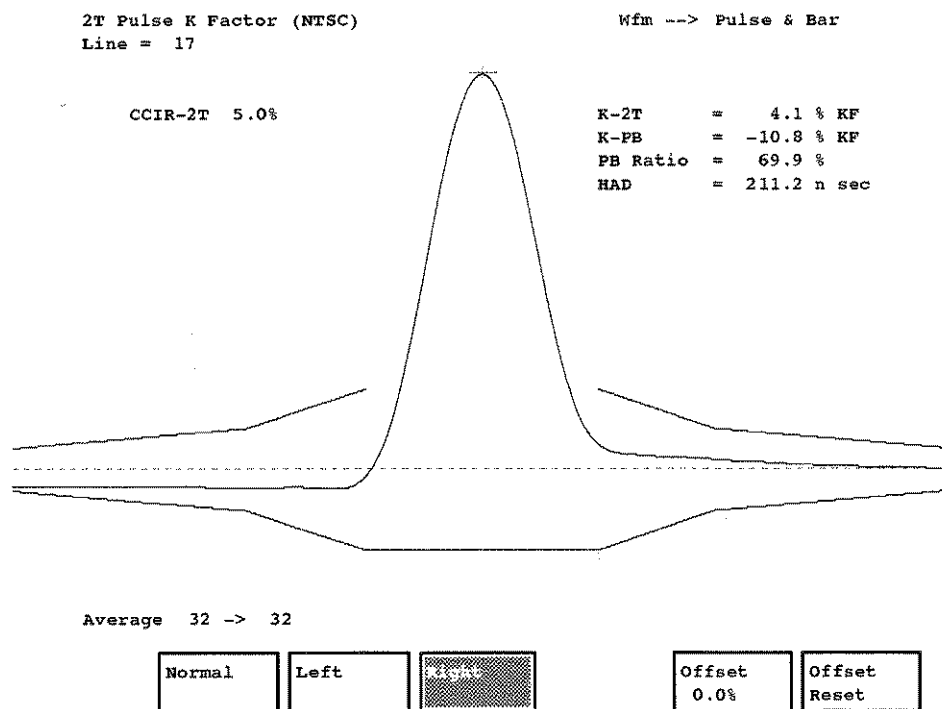

Figure 2-43: K\_Factor measurement right reference clamped

### Graticule Submenu

<b>EIA Graticule</b>	EIA Graticule selects the standard EIA Graticule using the current values of graticule gain and graticule tracking.
<b>CMTT-2T Graticule</b>	CMTT-2T Graticule selects the standard CCIR graticule, using the current values of graticule gain and graticule tracking.
<b>Special Graticule</b>	Special Graticule selects the special (user-defined) graticule for K_Factor measurements. The Make Graticule menu choice is displayed when Special Graticule is selected.
<b>Make Graticule</b>	Make Graticule displays the menu choices for making a user-definable graticule.
<b>Graticule Gain</b>	Graticule Gain turns on the graticule variable gain mode. The range is 0.1% to 20.0%, with a resolution of 0.1%. The gain can be set by rotating the knob. The default gain is 5.0%.
<b>Graticule Track</b>	Graticule Track turns on graticule tracking mode. When graticule tracking is on, the size of the graticule tracks the actual waveform.

- Graticule Reset**      Graticule Reset turns off graticule tracking and resets the graticule gain to 5.0%.
- Rescale**            Rescale sets the expansion factor of the display to an appropriate scaling factor for the K\_Factor measurement display graticule. The x- and y-axes adjust to accommodate the rescaled display.

**Make Graticule Submenu**

- Upper Graticule**      Upper Graticule selects the upper graticule of the special graticule to be defined by the following formula:

$$grat = A * exp(B * (T^C)) * (T^D) + E$$

The values for A, B, C, D, E, and T may be selected in the Area 1, Area 2, and Area 3 lines. Rotate the control knob to highlight an area line, touch the screen to select the variable in the line to adjust, and rotate the control knob to adjust the variable value (refer to *Defining Your Own Graticule* on page 2-81).

D is typically 1.0. E is a constant that moves the graticule vertically.

Area 1 is the center area of the graticule.

Area 2 is from the center area to the end area of the graticule.

Area 3 is the left and right end areas of the graticule.



**Lower Graticule**

Lower Graticule selects the lower graticule of the special graticule to be defined by the following formula:

$$grat = A * exp(B * (T^C)) * (T^D) + E$$

The values for A, B, C, D, E, and T may be selected in the Area 1, Area 2, and Area 3 lines. Rotate the control knob to highlight an area line, touch the screen to select the variable in the line to adjust, and rotate the control knob to adjust the variable value (refer to *Defining Your Own Graticule* on page 2-81).

D is typically 1.0. E is a constant that moves the graticule vertically.

Area 1 is the center area of the graticule.

Area 2 is from the center area to the end area of the graticule.

Area 3 is the left and right end areas of the graticule.

**Set to 0.0/1.0/-1.0**

Set to 0.0/1.0/-1.0 appear if one of the variable values in a graticule has been selected for editing. These soft keys provide you a way to rapidly return a value to the selected value as an aid in defining a new graticule.

**Acquire Submenu****Special Position**

Special Position sets the locations on the waveform where the measurement is made. Figure 2-44 shows the K-Factor Special Position display.

**Block Mode**

Block Mode turns on Block mode. The block starts at the system line.

**Block Lines 3**

Block Lines sets the number of lines to average for the measurement. The default number of Block Lines to average is 3.

**Block Step 2**

Block Step sets the number of lines to step in the block. The default number of lines to step is 2.

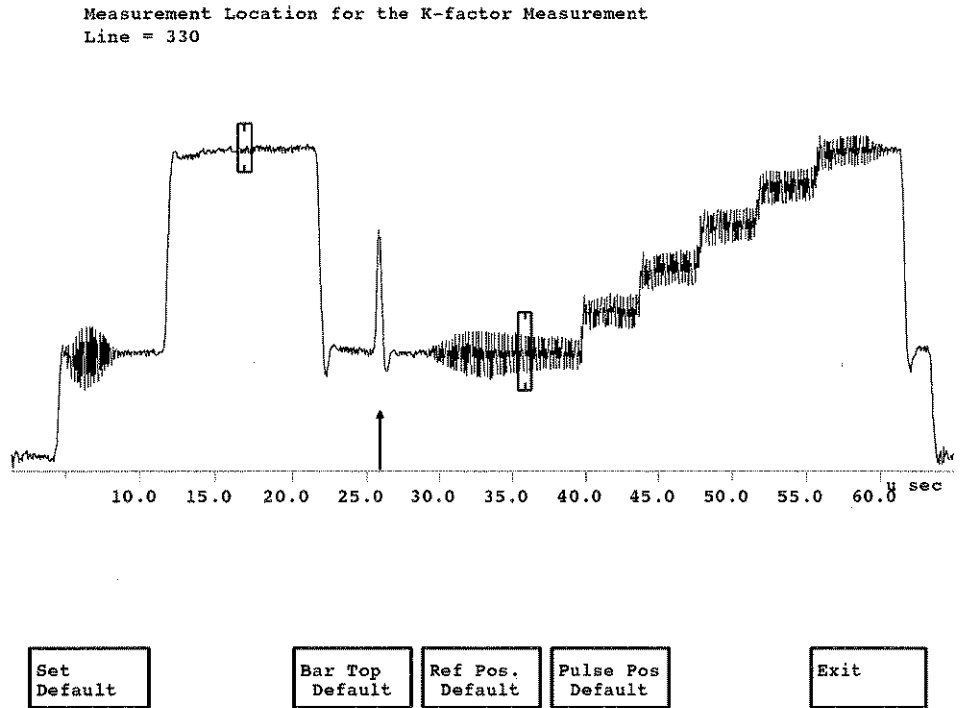

Figure 2-44: K-Factor Special Position display

**Special Position Submenu**

- Set Default**      Set Default resets each K\_Factor measurement location to the default value given in the Measurement Locations file. If any other soft key is highlighted, only that measurement location is reset.
- Bar Pos. Default**      Bar Pos. Default allows you to choose the bar location in the signal by rotating the knob. The VM700T finds the exact center, but this location can be reset if desired by rotating the knob.
- Ref. Pos. Default**      Ref. Pos. Default allows you to choose the reference location of the blanking level in the signal by rotating the knob.
- Pulse Pos. Default**      Pulse Pos. Default displays the pulse position cursor, which can be moved by rotating the knob. The VM700T finds the exact center of the pulse, but this location can be reset if desired by rotating the knob.
- Exit**      Exit leaves the Special Position display and returns to the main K\_Factor measurement display.

## Defining Your Own Graticule

The K\_Factor measurement's graticule defines the boundaries of the distortion envelope for a given graticule gain setting. The displayed graticule consists of an upper and a lower graticule.

You can define your own graticule for the K\_Factor measurement by means of the Make Graticule submenu. To access the Make Graticule submenu, do the following steps:

1. Press the Menu button to bring up the K\_Factor main menu.
2. Touch the Graticule soft key.
3. If it is not already highlighted, touch the Special Graticule soft key. When Special Graticule is highlighted, the Make Graticule soft key displays beside it.
4. Touch the Make Graticule soft key.

The Make Graticule submenu, consisting of the Upper Graticule and Lower Graticule soft keys, should be visible but not highlighted on the screen.

To change the shape of the upper or lower graticule, touch the corresponding soft key. This displays three editable lines of equations (Figure 2-45).

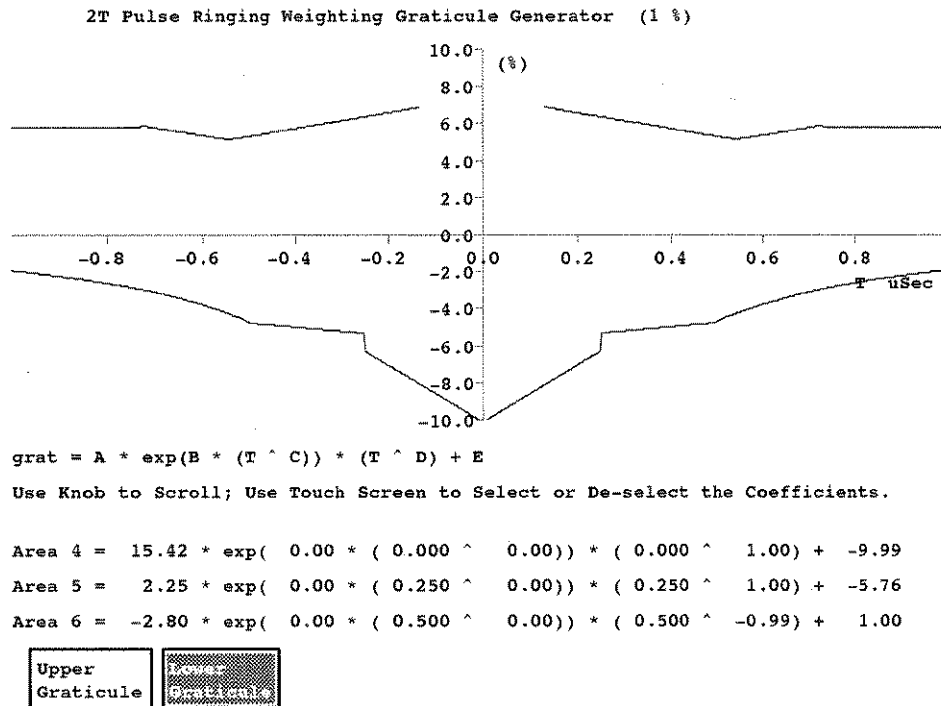

Figure 2-45: Make Graticule display with lower graticule selected

Each graticule is divided into three areas. Area 1 is innermost, nearest the y-axis. Area 2 is the middle area. Area 3 is outermost, furthest away from the y-axis. The three lines of equations correspond to the three areas of the line being edited.

Editing the equations consists of changing the values of the coefficients in the following equation:

$$grat = A * exp(B * (T^C)) * (T^D) + E$$

To select a line to edit, turn the knob when no coefficient of a line is selected (that is, when an edit box is not visible around any coefficient).

To edit a coefficient in the selected line, touch the coefficient you wish to edit. For coefficients A, B, C, D, or E, this brings up three more soft keys labeled Set to 0.0, Set to 1.0, and Set to -1.0. (When the T coefficient is selected, only the Set to 0.0 soft key is displayed.) To set the value of the coefficient, turn the knob or touch one of the soft keys. The effect of the change on the graticule is shown immediately.

To finish making changes to an equation, touch the selected coefficient. The edit box disappears, and you can then turn the knob to select a new line to edit, or press the Menu button to exit the Make Graticule submenu.

---

**NOTE.** *The Make Graticule submenu defines the boundaries of the distortion envelope for 1% gain. The default gain for the main K\_Factor display is 5%. You can adjust the gain value with the Graticule Gain soft key of the Graticule submenu.*

---

To adjust the gain, highlight the soft key, turn the knob until the desired gain value is displayed; then touch the soft key again.

## Level Meter

Level Meter measures the amplitude difference between two points on a television signal and displays the result in an easy-to-read bar graph. Two examples of levels that may be monitored are the sync amplitude and the peak-to-peak amplitude of a video signal.

### Level Meter Display

Figure 2-46 shows the typical Level Meter display monitoring the peak-to-peak amplitude of an NTC-7 Composite waveform. You can set the measurement for delta between two points in IRE units, delta between two points referenced to a value in percentage, or absolute between one point and zero (ground) in either IRE units or percentage.

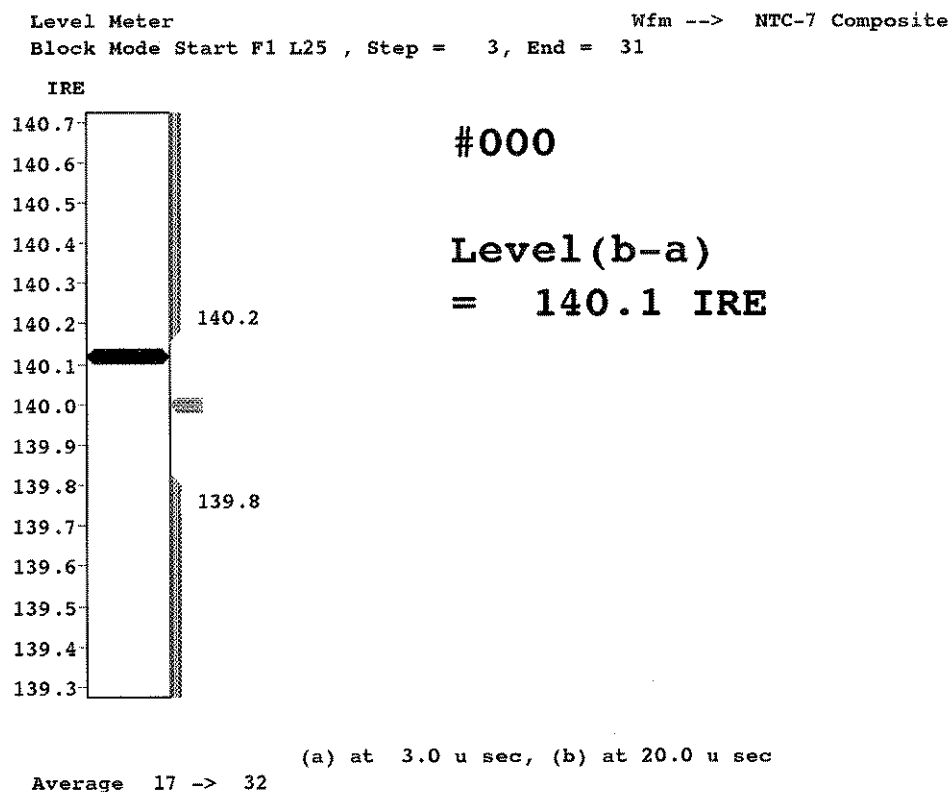

Figure 2-46: Level Meter display

---

**NOTE.** *Measurement units of IRE are the default when using the System Default Measurement Location file. If you want to see units in mV, you must create editable files for Measurement Locations and Video Source. In the editable Measurement Locations file, change the amplitude units to volts; in the editable Video Source file, change the source selection to the new Measurement Locations file name. See the VM700T Operator's Manual, Configuring the VM700T, for further information on creating, editing, and selecting user-created configuration files.*

---

The max. and min. points of the measurement window and the reference pointer for the display are easy to set up using the menu choices under the Display Limits soft key, and you can quickly select the measurement points on a waveform using the menu choices under the Measure Position soft key.

### Level Meter Main Menu

Pressing the Menu button with the Level Meter running displays the Level Meter main menu. The menu tree is shown in Figure 2-47.

#### Main Menu

##### Average Num

Average Num specifies the weighting factor to use for averaging. The Average Num range is 1 to 256. The default value is 32. To change the Average Num value, touch the Average Num soft key to highlight it, rotate the control knob until the desired weighting factor appears; then touch the Average Num soft key again. The effect of increasing the number used for averaging is that more time is required to arrive at a final value, but the readings become more stable as any noise variations of signal level are averaged out.

##### Display Limits

Display Limits calls up a menu for setting the Level Meter reference limits seen in the Level Meter display of Figure 2-48. Provision are available for setting the minimum and maximum amplitude values for the measurement window, and for setting a measurement reference pointer. The Expand and Move feature works on the vertical axis to permit a Level Meter display to be set up to monitor a level measurement of a video signal over a wide range of resolution and amplitudes.

**Main Menu**



**Display Limits Submenu**

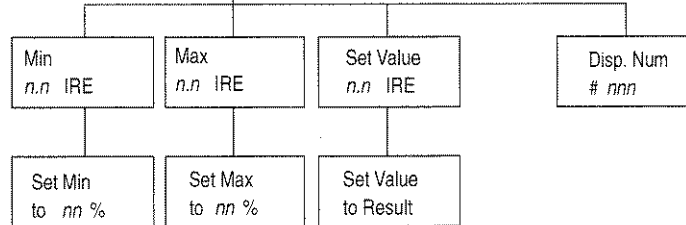

**Measure Position Submenu**

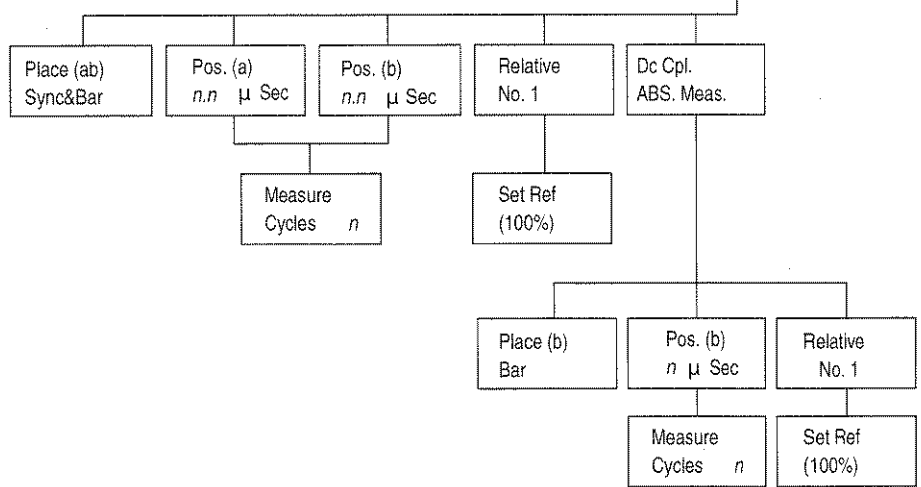

**Acquire Submenu**

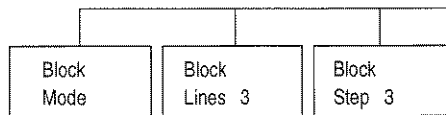

**Figure 2-47: Level Meter menu tree**

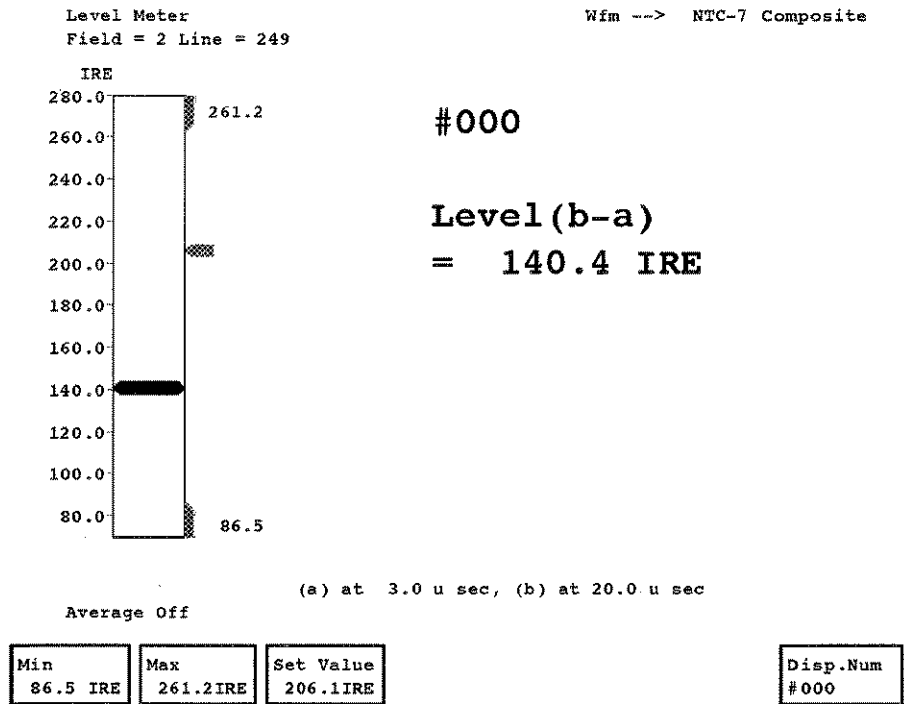

Figure 2-48: Display Limits menu showing undefined measurement points

**Measure Position** Measure Position displays a menu and waveform for positioning the measurement cursors. The amplitude measurement may be set for the cursor difference (b-a) in IRE units, cursor difference (b-a/reference) in percentage relative to a reference, or cursor position with respect to zero. The number of cycles over which the measurement is made is also selectable for each cursor. The Measure Cycles n display indicates the current selection for the active cursor. The measure position display is illustrated in Figure 2-49 showing the cursors positioned to measure the nominal peak-to-peak amplitude of the NTC-7 composite test signal. The active cursor has a vertical marker attached.

**Acquire** Acquire displays a menu used to select block acquisition mode and control the number of lines in the block acquired and the number of lines to step in a block.



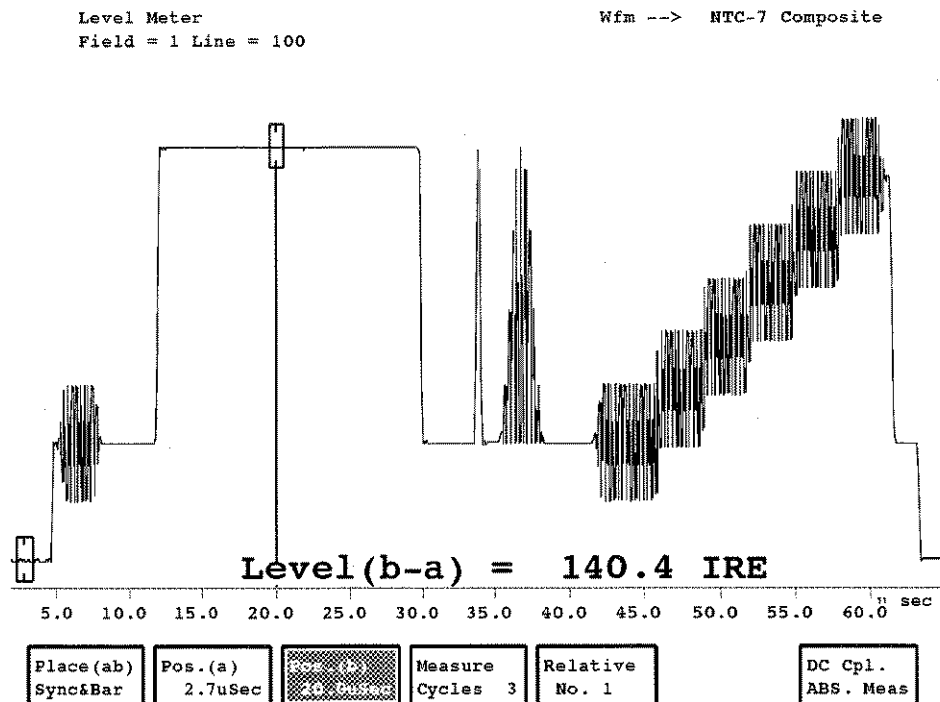

Figure 2-49: Measure Position display to locate the measurement points on a signal

**Rescale**

Rescale readjusts the vertical scale position to place the measured value within the Level Meter viewing area. After adjusting the Max and Min display limits to new values, using Rescale will adjust the display for the optimum resolution using those new limits.

### Display Limits Submenu

**Min**  
**n.n IRE**

Min selects the minimum display limit marker for adjustment. With the Min soft key selected, rotating the control knob sets the minimum display window marker to the number displayed in the soft key box. It cannot be set to a higher amplitude than the reference pointer level. The minimum limit is either  $-999$  mV or  $-200\%$ .

With the Min soft key selected another menu choice is added: Set Min to  $-nn\%$ . This soft key provides a means to quickly set up a minimum percentage to monitor after the measurement points have been selected. Refer to *Setting Up a New Measurement Window* on page 2-93 for an example of how this soft key may be used. Also, the percentage setting of the soft key may be set between 0 and  $-10\%$  by rotating the control knob while holding your finger on the Set Min to  $-nn\%$  menu choice. The default is  $-10\%$ .

**Max**  
**n.n IRE**

Max selects the maximum display limit marker for adjustment. With the Max soft key selected, rotating the control knob sets the maximum display window marker to the number displayed in the soft key box. It cannot be set to a lower amplitude than the reference pointer level. The maximum limit is either  $2000$  mV or  $200\%$ .

With the Max soft key selected another menu choice is added: Set Max to  $nn\%$ . This soft key provides a means to quickly set up a maximum percentage to monitor after the measurement points have been selected. Refer to *Setting Up a New Measurement Window* on page 2-93 for an example of how this soft key may be used. Also, the percentage setting of the soft key may be set between 0 and  $10\%$  by rotating the control knob while holding your finger on the Set Max to  $nn\%$  menu choice. The default is  $10\%$ .

**Set Value**  
**n.n IRE**

Set Value selects the reference pointer for adjustment. With the Set Value soft key selected, rotating the control knob sets the reference pointer to the value displayed in the soft key box. The reference pointer may be positioned at any location within the measurement range, and may be used to mark the nominal measurement point for a quick visual reference of value changes in the amplitude being monitored. The reference pointer pushes the maximum and minimum display limit markers if the reference pointer setting is moved past the set display limits.

With the Set Value soft key selected, another menu choice is added: Set Value to Result. After the measurement points have been selected using the choices under the Measure Position soft key, using the Set Value to Result soft key quickly aligns the reference pointer to the measured value. This is near or at the value that will be monitored if the cursors positions have to be adjusted to the correct points in the waveform. Refer to *Setting Up a New Measurement Window* on page 2-93 for an example of how this soft key can be used.

**Disp. Num #nnn** Disp. Num #nnn is a user-selectable number that provides an identification number for a screen copy of the display.

**Measure Position Submenu****Place (ab)**  
**Sync&Bar**

Place (ab) Sync&Bar automatically positions the a and b cursors on valid sync and bar portions of the input signal display. Once positioned, you may move either cursor by selecting the cursor and rotating the knob.

**Pos. (a) n.n**  
**μSec**

Pos. (a) nn μSec selects cursor "a" for time positioning in the waveform display over a range of 0.7 μsec to 64.2 μsec. This choice is not present when ASB. Meas. is active. The number displayed is the time position in the waveform from the leading edge of the horizontal sync.

Pressing this soft key displays the Measure Cycles n soft key. Measure Cycles selects the number, from 1 to 50, of subcarrier frequency cycles over which the measurement is made. The default is 3 cycles. This setting is associated with the selected cursor, and the horizontal size of the cursor box changes as the number in the soft key box is changed to indicate the measurement area on the displayed waveform.

**Pos. (b) *n.n*  
μSec**

Pos. (b) *nn* μSec selects cursor “b” for time positioning in the waveform display over a range of 0.7 μsec to 64.2 μsec. The number displayed is the time position in the waveform from the leading edge of the horizontal sync. If cursor “b” is positioned in time before cursor “a,” the sign of the measurement readout reverses.

Pressing this soft key displays the Measure Cycles *n* soft key. Measure Cycles selects the number, from 1 to 50, of subcarrier frequency cycles over which the measurement is made. The default is 3 cycles. This setting is associated with the selected cursor, and the horizontal size of the cursor box changes as the number in the soft key box is changed to indicate the measurement area on the displayed waveform.

**Measure  
Cycles *n***

Measure Cycles *n* selects the number, from 1 to 50, of subcarrier frequency cycles over which the measurement is made. The default is 3 cycles. This setting is associated with the selected cursor, and the horizontal size of the cursor box changes as the number in the soft key box is changed to indicate the measurement area on the displayed waveform.

**Relative No. 1**

Relative No. 1 turns on the relative measurement units of percentage and displays the Set Ref (100%) soft key that sets the 100% reference. Position the “a” and “b” cursors to the minimum and maximum points that define the 100% amplitude to use as the reference amplitude; then touch the Set Ref (100%) soft key. The amplitude readout will then reflect the percentage difference between the position of cursor “b” and the 100% reference value.

In Figure 2-50, the reference is set to 100 IRE as the 100% reference, and the measurement is based on the difference between the vertical position of the cursor and zero as a result of also selecting DC Cpl. ABS. Meas.

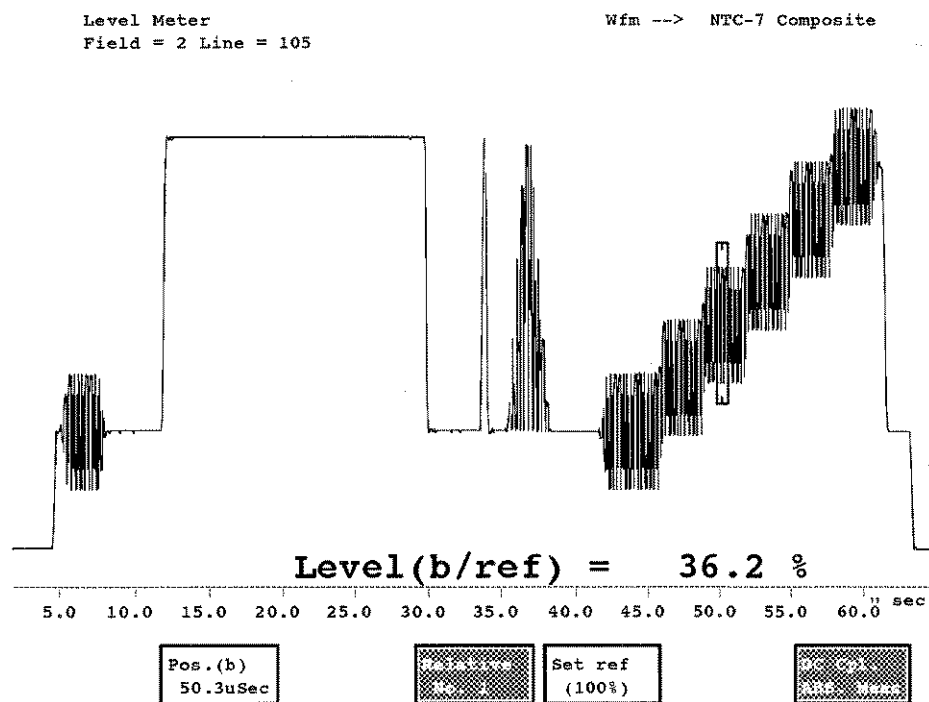

Figure 2-50: Display Position with measurement referenced to 100 IRE as 100%

**Set Ref (nn%)** Set Ref (nn%) sets the 100% reference.

**Dc Cpl.** DC Cpl. ABS. Meas. switches to dc coupling of the input signal and produces a measurement value based on the vertical position of cursor b with respect to zero volts (ground) as seen in Figure 2-50. The Level Meter display that results from setting up for a referenced and absolute amplitude is seen in Figure 2-51.

**ABS Meas.**

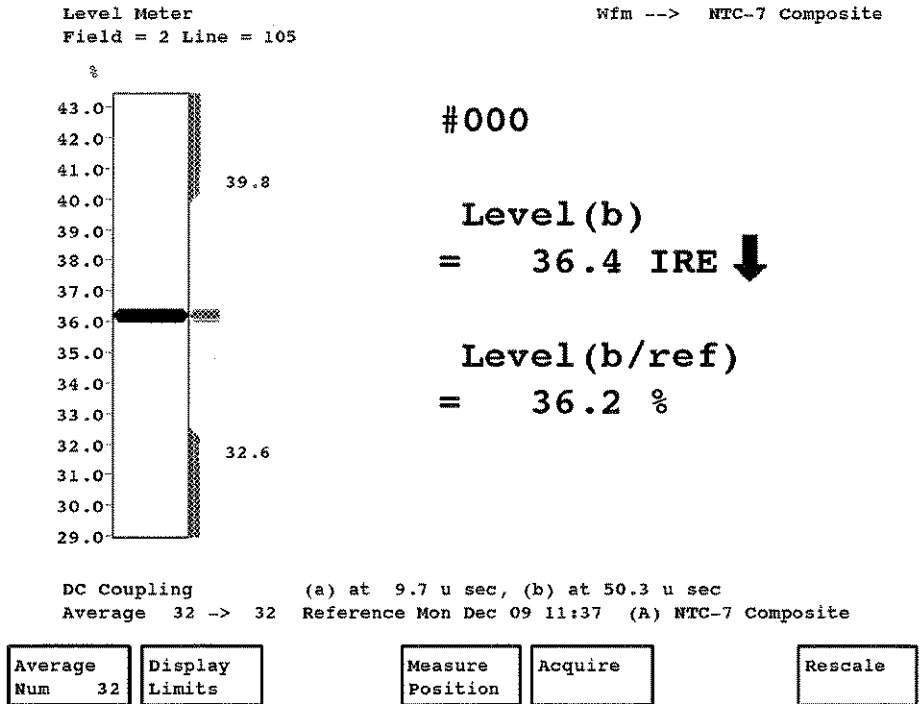

Figure 2-51: Level Meter display as a result of the setup shown in Figure 2-50

Acquire Submenu

- Block Mode** Block Mode turns Block mode acquisition on and off. When block acquisition is used, all the waveforms within a defined block are averaged to make the measurement. It is left to the user to ensure that all the waveforms within the selected block are the same. If only a single line is used for monitoring, Block mode should be turned off to avoid mixing waveform types in the measurement.
- Block Lines *n*** Block Lines determines the number of lines in a Block mode acquisition from 2 to 32 lines.
- Block Step *n*** Block Step determines the size of the step for a Block mode acquisition from 1 to 263 lines.

## Setting Up a New Measurement Window

When positioning the cursors to new measurement points on a waveform, you can quickly set up a new measurement window. Following the procedure described below produces a display limit window around the measured value. From that point you may quickly expand the display to increase the resolution of the measurement and adjust the max. and min. display limits to those needed. If you have specific percentage limits for the max. and min. display limits from 0 to 10, you may set those percentages in the Set Min to  $-nn\%$  and Set Max to  $nn\%$  soft keys in advance.

### To set up a new measurement window:

1. From the Level Meter without a menu, press the Menu button and select Measure Position.
2. Select the a and b cursors in turn and position them to the new measurement points.

---

**NOTE.** If a is positioned to a higher amplitude than b, the amplitude difference will be negative.

---

3. Press the Menu button to return to the first level menu; then touch the Display Limits soft key.
4. Touch the Set Value soft key; then touch the Set Value to Result soft key. This sets the reference pointer to the measured difference between the cursors.
5. Touch the Min soft key and touch the Set Min to  $-nn\%$  soft key that displays.
6. Select the Max soft key and touch the Set Max to  $nn\%$  soft key that displays.
7. Press the Menu button to return to the first level menu and touch Rescale.

This sets the measurement window and the reference pointer in the Level Meter display. The vertical scale is adjusted to provide optimum viewing of the Level Meter for the limits just set. From this point, you access the Display Limits menu again and set the max. and min. display limits narrower or wider as needed for the value you are monitoring. After setting the limits exactly where you need them, return to the first level menu and press the Rescale soft key again to optimize the Level Meter display for the new display limits.

## Line Frequency

The Line Frequency measurement measures horizontal line frequency and field frequency. The Line Frequency display can use any video signal as input.

Figure 2-52 shows the Line Frequency display. Digital readouts show the line and field frequencies, while a graphical display shows the error from the nominal frequency.

Line Frequency (NTSC)

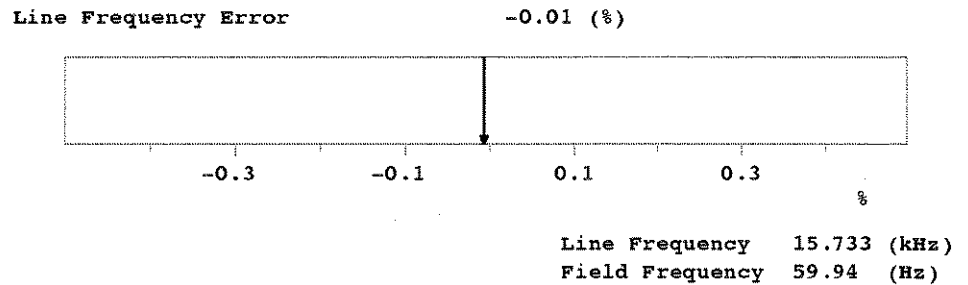

Average Off

Figure 2-52: Line Frequency display

### Line Frequency Menu

Pressing the Menu button when the Line Frequency measurement runs displays the Line Frequency menu (Figure 2-53).

#### Main Menu



Figure 2-53: Line Frequency menu tree



**Main Menu****Average  
Num**

Average Num specifies the weighting factor to use for averaging. The Average Num range is 1 to 256. The default value is 32. To change the Average Num value, touch the Average Num soft key to highlight it, rotate the knob until the desired weighting factor appears; then touch the Average Num soft key again.

**Rescale**

Rescale sets the expansion factor of the display to an appropriate scaling factor for the Line Frequency measurement display graticule. The x- and y-axes adjust to accommodate the rescaled display.

## Luminance NonLinearity

The Luminance NonLinearity measurement measures luminance nonlinear distortion.

Figure 2-54 shows the Luminance NonLinearity display. The display plots the step height of each packet, as a percentage of the largest step-size packet. A digital readout of each packet's step size is also provided, as well as a peak-to-peak value showing the difference between the maximum and minimum step sizes.

The Luminance NonLinearity measurement can use an FCC Composite, NTC-7 Composite, or stair-step signal for input. The essential elements in the input signal are up to ten stair steps.

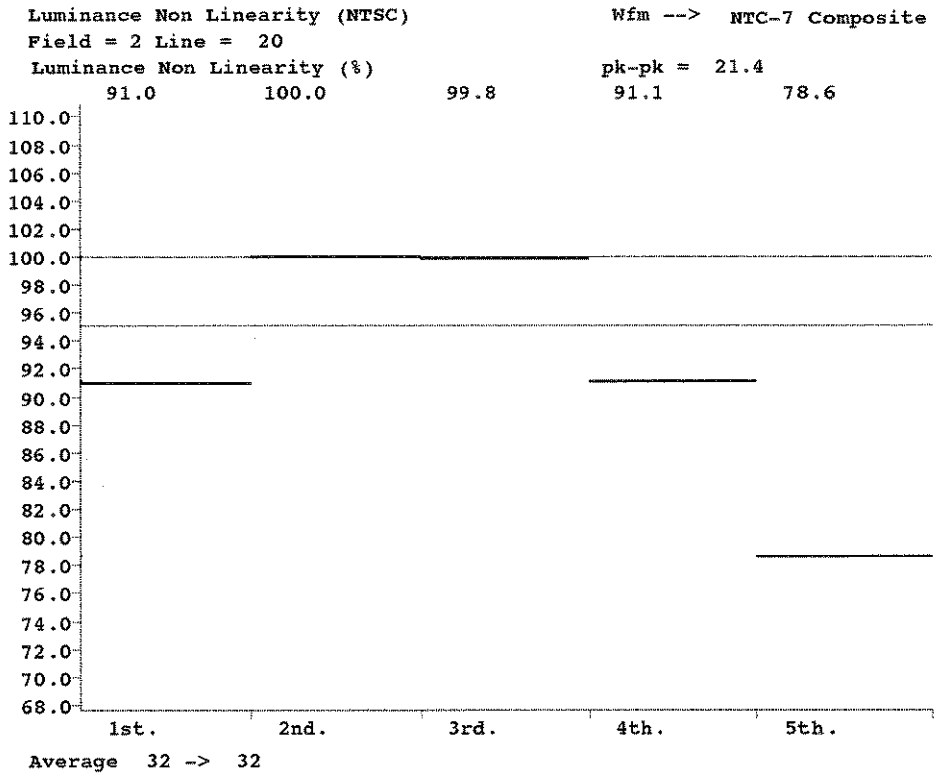
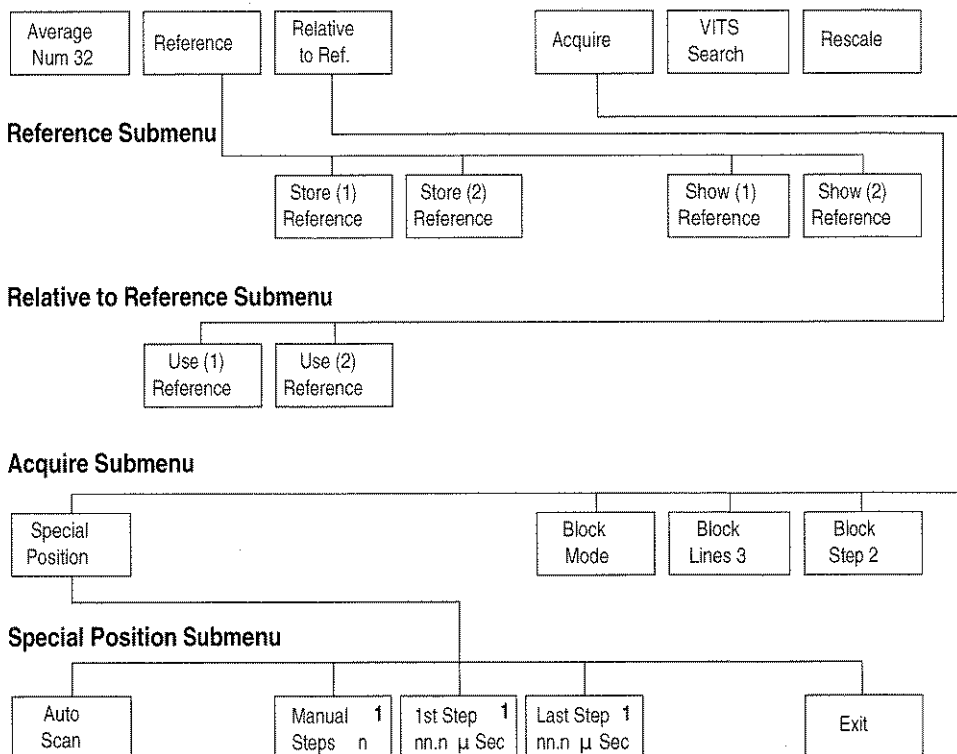

Figure 2-54: Luminance NonLinearity display

**Luminance NonLinearity Menu**

Pressing the Menu button when the Luminance NonLinearity measurement runs displays the Luminance NonLinearity menu (Figure 2–55).

**Main Menu**



<sup>1</sup>Visible when Auto Scan is not selected.

**Figure 2–55: Luminance NonLinearity menu tree**

**Main Menu**

**Average Num** Average Num specifies the weighting factor to use for averaging. The Average Num range is 1 to 256. The default value is 32. To change the Average Num value, touch the Average Num soft key to highlight it, rotate the knob until the desired weighting factor appears; then touch the Average Num soft key again.

**Reference** Reference displays the Reference submenu which (1) stores the currently displayed values for use as a reference; or (2) displays previously stored reference values.

- Relative to Reference**      Relative to Reference displays the Relative to Reference submenu that selects the reference to use for comparison in the measurement. When a stored reference is selected, the currently measured value is compared to the stored reference value.
  
- Acquire**                      Acquire displays the Acquire submenu that controls how the signal is acquired for the Luminance NonLinearity measurement.
  
- VITS Search**                VITS Search searches the insertion test signals for a signal appropriate for the measurement. If an appropriate signal is not located, the message Not found displays briefly on the screen.
  
- Rescale**                      Rescale sets the expansion factor of the display to an appropriate scaling factor for the Luminance NonLinearity measurement display graticule. The x- and y-axes adjust to accommodate the rescaled display.

**Reference Submenu**

- Store (n) Reference**      Store (1) Reference/Store (2) Reference saves the current measurement values as (1) Reference and (2) Reference, respectively. Selecting Store (1) Reference or Store (2) Reference overwrites previous (1) Reference or (2) Reference values. References are stored in nonvolatile memory and are retained when the VM700T is powered down.
  
- Show (n) Reference**      Show (1) Reference/Show (2) Reference displays the current values of (1) Reference and (2) Reference, respectively, plus the date and time the reference was stored and the channel the reference signal was on. If no reference value has been stored, touching either soft key displays a message that the reference is not defined.

**Relative to Reference Submenu**

- Use (n) Reference**      Use (1) Reference/Use (2) Reference selects the stored reference to which measured values are compared. If no reference value has been stored, touching either soft key displays a message that the reference is not defined.

### Acquire Submenu

<b>Special Position</b>	Special Position provides soft keys to set the locations on the waveform where the measurement is made. Figure 2-56 shows the Luminance NonLinearity Special Position display.
<b>Block Mode</b>	Block Mode turns on Block mode. The block starts at the system line.
<b>Block Lines</b>	Block Lines sets the number of lines to average for the measurement. The default number of Block Lines to average is 3.
<b>Block Step</b>	Block Step sets the number of lines to step in the block. The default number of lines to step is 2.

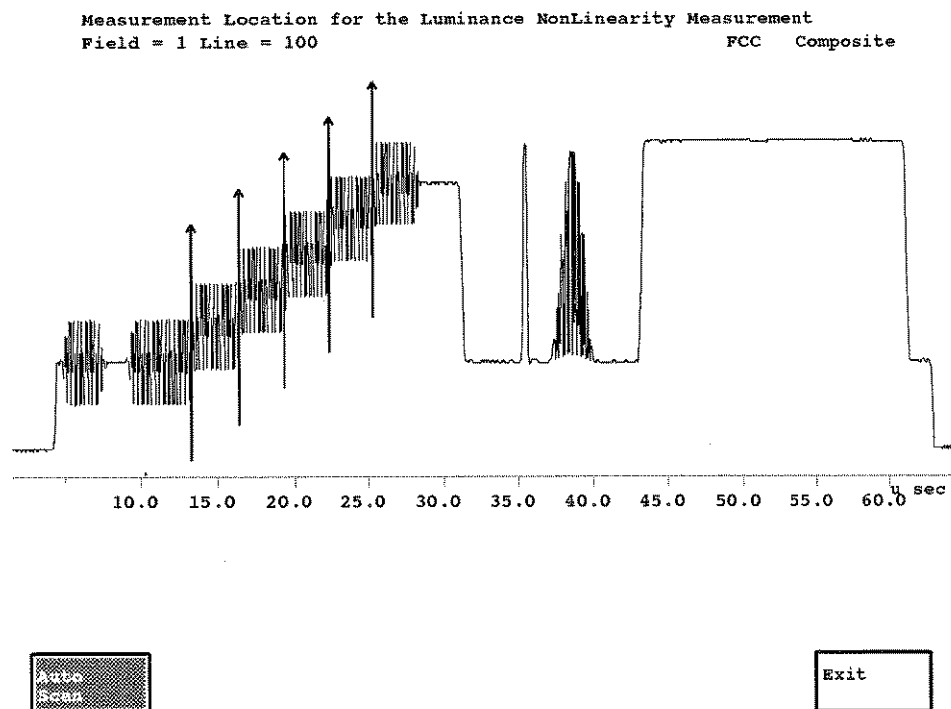

Figure 2-56: Luminance NonLinearity Special Position display

### Special Position Submenu

**Auto Scan** Auto Scan when highlighted, automatically scans and determines measurement locations. When deselected, other soft keys (described below) appear to allow you to set measurement locations manually.

---

**NOTE.** *If severe luminance nonlinear distortion is present, the VM700T may not be able to resolve all the steps that were present in the original signal. In such cases, you must use manual positioning to set the location of each staircase step.*

---

**Manual Steps** Manual Steps allows the number of luminance steps in the signal to be adjusted by rotating the knob.

**1st Step** 1st Step allows you to adjust the position of the first luminance step edge of the staircase by rotating the knob.

**Last Step** Last Step allows you to adjust the position of the last luminance step edge of the staircase by rotating the knob.

**Exit** Exit leaves the Special Position display and returns to the Luminance NonLinearity display.

## MultiBurst

The MultiBurst measurement measures frequency response.

Figure 2-57 shows the MultiBurst display, which plots signal amplitude as a function of difference from the reference frequency.

The MultiBurst measurement automatically identifies FCC MultiBurst, NTC-7 Combination, or the Tektronix signal generator MultiBurst signals. The essential element in any signal used for the MultiBurst measurement is multiple bursts.

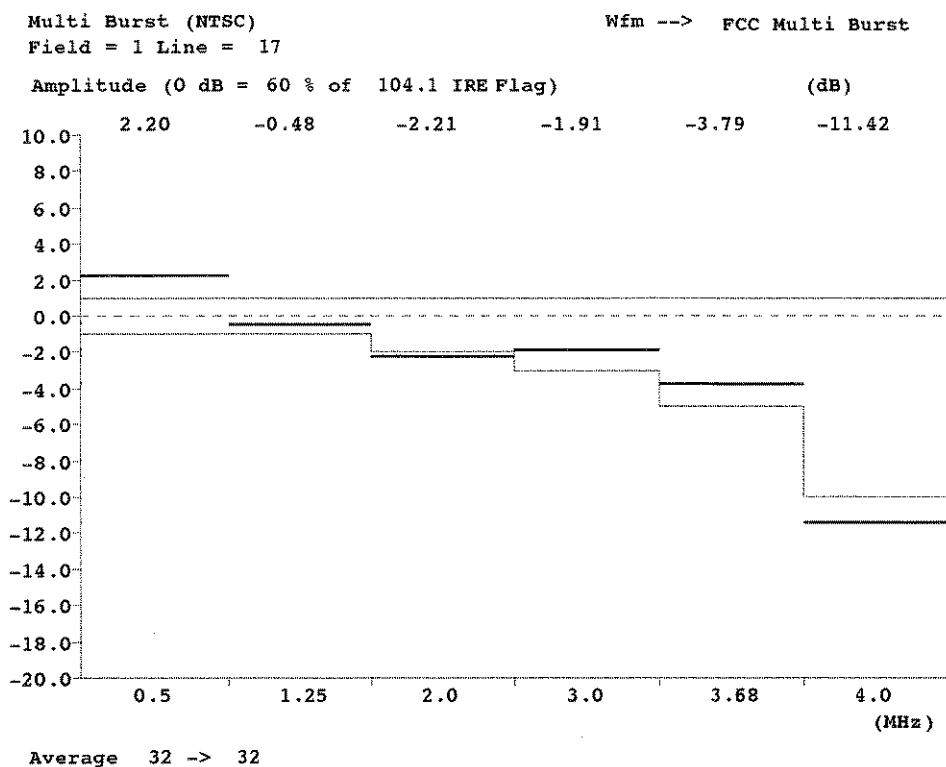
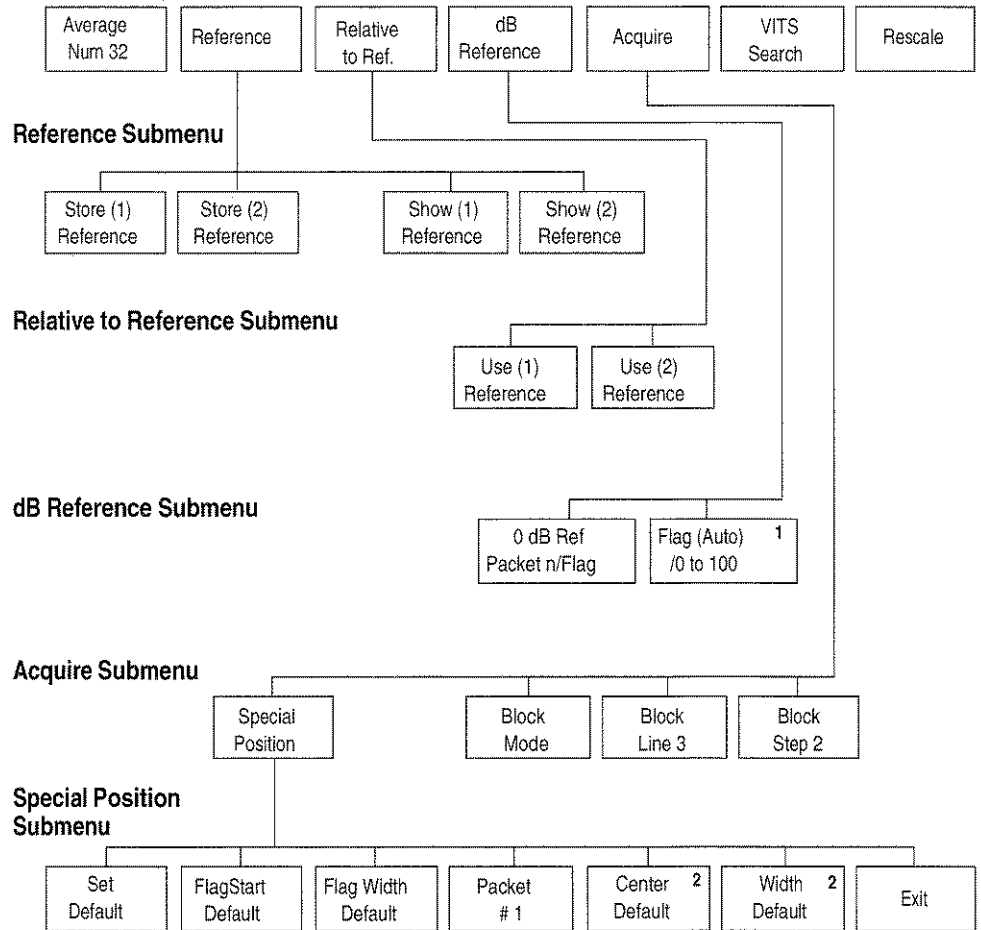

Figure 2-57: MultiBurst display

**MultiBurst Menu**

Pressing the Menu button when the MultiBurst measurement runs displays the MultiBurst menu (Figure 2–58).

**Main Menu**



<sup>1</sup> Flag (Auto) is displayed only when the 0 dB Ref softkey is set to Flag.

<sup>2</sup> Displayed only when Packet # is selected.

**Figure 2–58: MultiBurst menu tree**



**Main Menu**

<b>Average Num</b>	Average Num specifies the weighting factor to use for averaging. The Average Num range is 1 to 256. The default value is 32. To change the Average Num value, touch the Average Num soft key to highlight it, rotate the knob until the desired weighting factor appears; then touch the Average Num soft key again.
<b>Reference</b>	Reference displays the Reference submenu which (1) stores the currently displayed values for use as a reference; or (2) displays previously stored reference values.
<b>Relative to Reference</b>	Relative to Reference displays the Relative to Reference submenu which selects the reference to use for comparison in the measurement. When a stored reference is selected, the currently measured value is compared to the stored reference value.
<b>dB Reference</b>	dB Reference displays the dB Reference submenu that selects the 0dB reference position by rotating the knob and sets the 0dB reference scale for the percentage of the flag amplitude.
<b>Acquire</b>	Acquire displays the Acquire submenu that controls how the signal is acquired for the MultiBurst measurement.
<b>VITS Search</b>	VITS Search searches the insertion test signals for a signal appropriate for the measurement. If an appropriate signal is not located, the message Not found displays briefly on the screen.
<b>Rescale</b>	Rescale sets the expansion factor of the display to an appropriate scaling factor for the MultiBurst measurement display graticule. The x- and y-axes adjust to accommodate the rescaled display.

### Reference Submenu

- Store (n) Reference** Store (1) Reference/Store (2) Reference saves the current measurement values as (1) Reference and (2) Reference, respectively. Selecting Store (1) Reference or Store (2) Reference overwrites previous (1) Reference or (2) Reference values. References are stored in nonvolatile memory and are retained when the VM700T is powered down.
- Show (n) Reference** Show (1) Reference/Show (2) Reference displays the current values of (1) Reference and (2) Reference, respectively, plus the date and time the reference was stored and the channel the reference signal was on. If no reference value has been stored, touching either soft key displays a message that the reference is not defined.

### Relative to Reference Submenu

- Use (n) Reference** Use (1) Reference/Use (2) Reference selects the stored reference to which measured values are compared. If no reference value has been stored, touching either soft key displays a message that the reference is not defined.

### dB Reference Submenu

- Ref Packet/Flag** Ref Packet/Flag allows you to select the 0 dB reference position by rotating the knob. Displays either a packet number or "Flag" as selected by rotating the knob. The Flag (Auto) soft key appears only when the selection is Flag.
- Flag(Auto) /0 - 100** Flag (Auto) automatically sets the 0 dB reference scale for the percentage of the flag amplitude. You may make a manual percentage selection from 0 to 100 by rotating the knob while this soft key is highlighted.

### Acquire Submenu

- Special Position** Special Position displays the Special Position submenu that sets the locations on the waveform where the measurement is made. Figure 2-59 shows the MultiBurst Special Position display.
- Block Mode** Block Mode turns on Block mode. The block starts at the system line.

- Block Lines** Block Lines sets the number of lines to average for the measurement. The default number of Block Lines to average is 3.
- Block Step** Block Step sets the number of lines to step in the block. The default number of lines to step is 2.

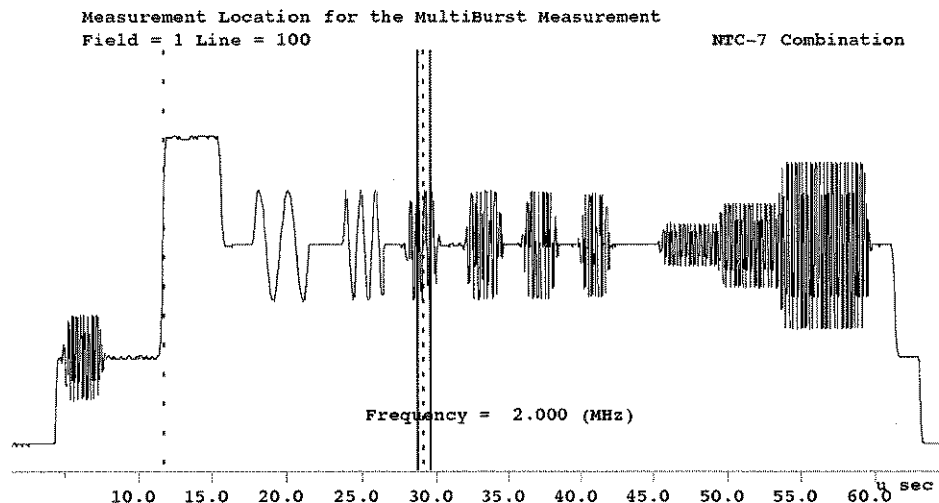

Figure 2-59: MultiBurst Special Position display

### Special Position Submenu

- Set Default** Set Default resets each measurement location to its default position from the Measurement Location file. If another soft key is highlighted, only the location given by the soft key is changed.
- Flag Start Default** Flag Start Default sets the location of the leading edge of the MultiBurst flag.
- Flag Width Default** Flag Width Default sets the width of the MultiBurst flag.

<b>Packet #</b>	Packet # selects one of the six packets and sets its location and measurement area with two additional soft keys, Center Default and Width Default.
<b>Center Default</b>	Center Default sets the center location of the packet.
<b>Width Default</b>	Width Default sets the measurement area of the packet.
<b>Exit</b>	Exit leaves the Special Position submenu and displays the MultiBurst screen.

## Noise Spectrum

Noise Spectrum measures noise level and performs spectrum analysis.

Figure 2-60 shows the Noise Spectrum display. The display plots noise level in decibels (where 0 dB = 714 mV) versus frequency (in MHz). A digital readout also displays the rms noise level of the entire bandwidth.

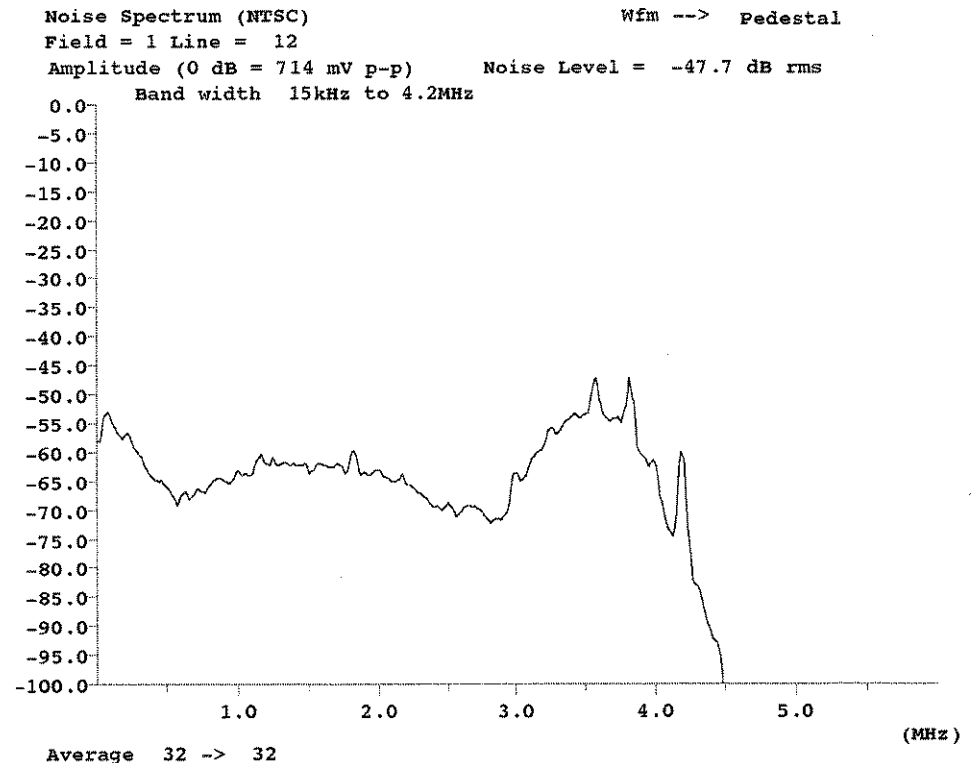

Figure 2-60: Noise Spectrum display

### Noise Spectrum Menu

Pressing the Menu button when the Noise Spectrum measurement runs displays the Noise Spectrum menu (Figure 2-61).

#### Main Menu

##### Average Num

Average Num specifies the weighting factor to use for averaging. The Average Num range is 1 to 256. The default value is 32. To change the Average Num value, touch the Average Num soft key to highlight it, rotate the knob until the desired weighting factor appears; then touch the Average Num soft key again.

**Main Menu**

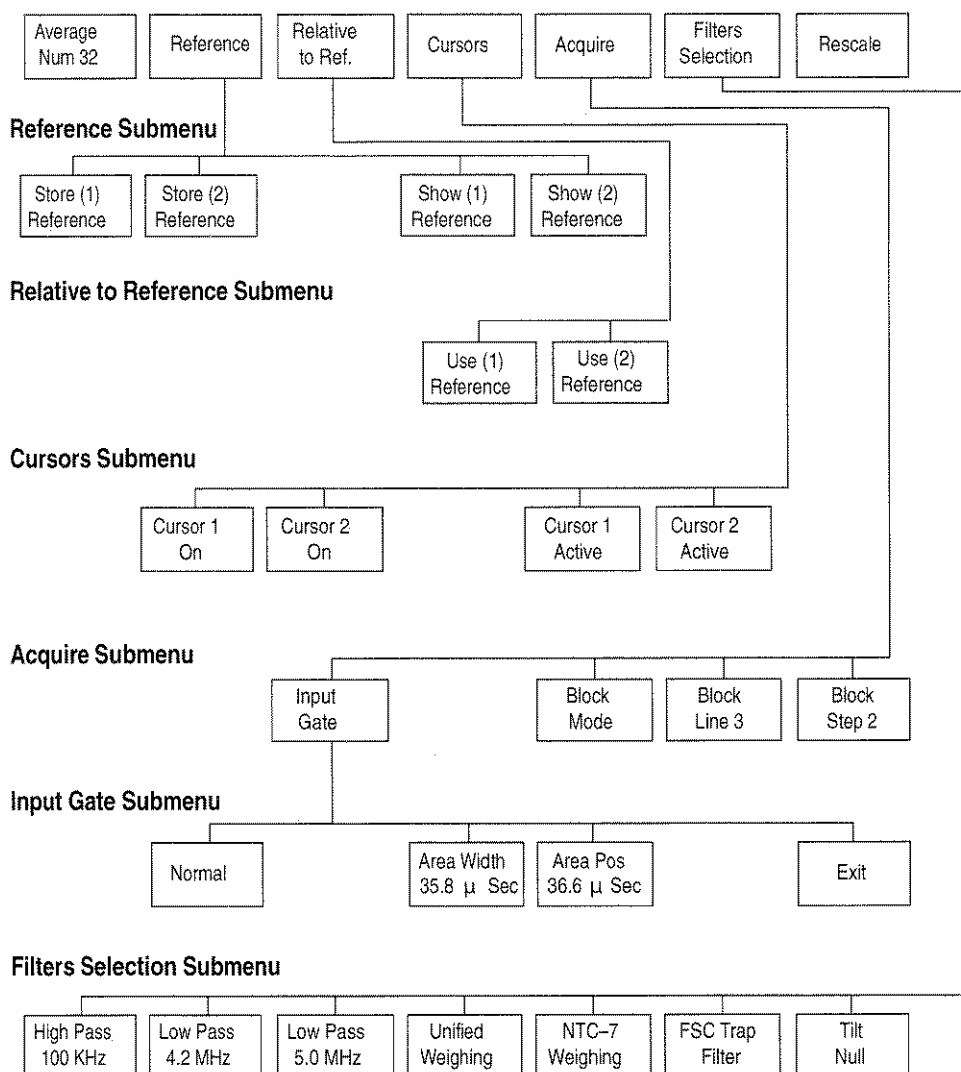

**Figure 2-61: Noise Spectrum menu tree**

**Reference**

Reference displays the Reference submenu which (1) stores the currently displayed values for use as a reference; or (2) displays previously stored reference values.

**Relative to Reference**

Relative to Reference displays the Relative to Reference submenu which selects the reference to use for compensation in the measurement. When a stored reference is selected, the currently measured value is compared to the stored reference value.

<b>Cursors</b>	Cursors provides soft keys to display and activate the two Noise Spectrum cursors. Readouts for the cursors give the peak-to-peak decibel value at the frequency location of the cursor(s) and the noise level in dB (rms) between the cursors.
<b>Acquire</b>	Acquire displays the Acquire submenu that controls how the signal is acquired for the Noise Spectrum measurement.
<b>Filters Selection</b>	Filters Selection provides soft keys to select one or more noise filters or the Tilt Null feature.
<b>Rescale</b>	Rescale sets the expansion factor of the display to an appropriate scaling factor for the Noise Spectrum measurement display graticule. The x- and y-axes adjust to accommodate the rescaled display.

#### Reference Submenu

<b>Store (n) Reference</b>	Store (1) Reference/Store (2) Reference saves the current measurement values as (1) Reference and (2) Reference, respectively. Selecting Store (1) Reference or Store (2) Reference overwrites previous (1) Reference or (2) Reference values. References are stored in nonvolatile memory and are retained when the VM700T is powered down.
<b>Show (n) Reference</b>	Show (1) Reference/Show (2) Reference displays the current values of (1) Reference and (2) Reference, respectively, plus the date and time the reference was stored and the channel the reference signal was on. If no reference value has been stored, touching either soft key displays a message that the reference is not defined.

#### Relative to Reference Submenu

<b>Use (n) Reference</b>	Use (1) Reference/Use (2) Reference selects the stored reference to which measured values are compared. If no reference value has been stored, touching either soft key displays a message that the reference is not defined.
--------------------------	---

### Cursors Submenu

<b>Cursor 1/2 On</b>	Cursor 1/2 On displays Noise Cursor 1 or 2. The cursor appears in the position it was in the last time the cursor was active.
<b>Cursor 1/2 Active</b>	Cursor 1/2 Active enables the knob to move Noise Cursor 1 or 2, and displays the Nearest Peak soft key.
<b>Nearest Peak</b>	Nearest Peak positions the active cursor on the nearest peak of the Noise Spectrum display.

### Acquire Submenu

<b>Input Gate</b>	Input Gate displays the Input Gate submenu and display used to set up the width and position of the signal area used for the Noise Spectrum measurement. Figure 2-62 shows the Noise Spectrum InputGate display.
<b>Block Mode</b>	Block Mode turns on Block mode. The block starts at the system line.
<b>Block Lines</b>	Block Lines sets the number of lines to average for the measurement. The default number of Block Lines to average is 3.
<b>Block Step</b>	Block Step sets the number of lines to step in the block. The default number of lines to step is 2.



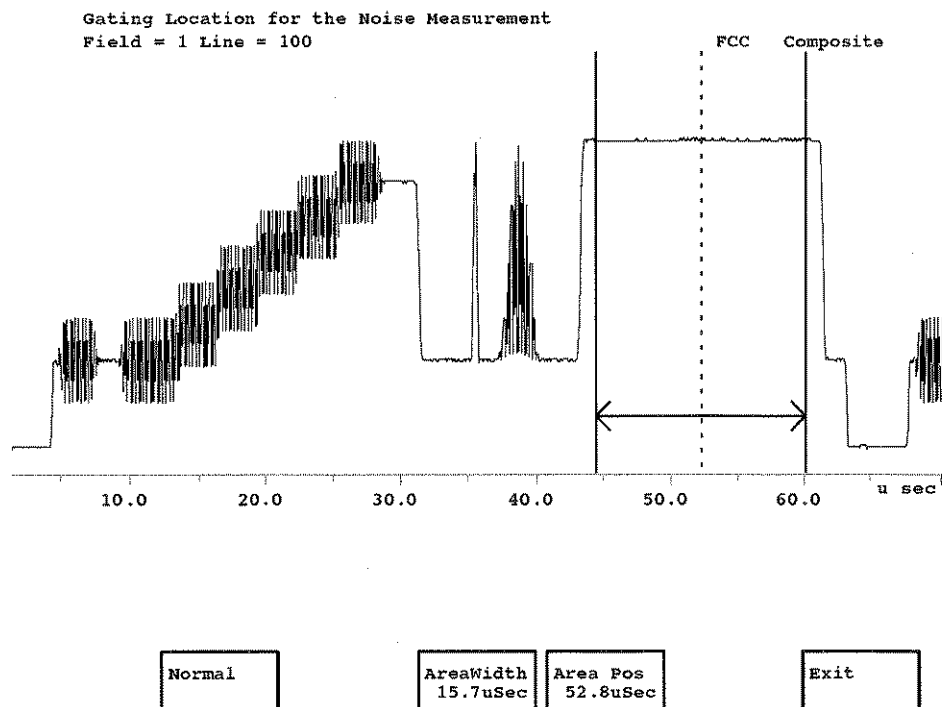

Figure 2-62: Noise Spectrum Input Gate display

## Input Gate Submenu

- Normal** Normal restores the Area Width and Area Pos. soft keys to their default values.
- Area Width** Area Width assigns the control knob to setting the width of the signal area (from 3.6  $\mu$ Sec to 35.8  $\mu$ Sec) used for the Noise Spectrum measurement.

---

**NOTE.** Low-frequency characteristics and frequency resolution may be changed, depending on the width selected.

---

- Area Pos** Area Pos assigns to control knob to positioning the signal area used for the Noise Spectrum measurement.
- Exit** Exit leaves the Input Gate menu and returns to the Noise Spectrum display.

### Filters Selection Submenu

<b>High Pass 100 kHz</b>	High Pass 100 kHz selects the 100 kHz high-pass filter. Signal information below 100 kHz is filtered out.
<b>Low Pass 4.2 MHz</b>	Low Pass 4.2 MHz selects the 4.2 MHz low-pass filter. Signal information above 4.2 MHz is filtered out.
<b>Low Pass 5.0/6.0 MHz</b>	Low Pass 5.0/6.0 MHz normally selects the 5.0 MHz low-pass filter. Signal information above 5.0 MHz is filtered out. Software version 2.05 and later also has a Low Pass 6.0 MHz filter selection. To select the Low Pass 6.0 MHz filter, touch the Low Pass 5.0 MHz soft key and turn the knob clockwise. The Low Pass 6.0 MHz filter remains selected until you touch the Low Pass 5.0 MHz soft key again and turn the knob counterclockwise, or until the VM700T is powered off.
<b>Unified Weighting</b>	Unified Weighting selects the standard CCIR unified weighting filter.
<b>NTC-7 Weighting</b>	NTC-7 Weighting selects the standard CCIR Rec. 421 weighting filter.
<b>Fsc. Trap Filter</b>	Fsc Trap Filter selects the subcarrier trap filter.
<b>Tilt Null</b>	Tilt Null automatically compensates for tilt (horizontal sag) to enable the Noise Spectrum measurement to be taken on a ramp signal. (Note: the noise floor might be slightly higher because the auto gain increase is limited by the larger peak-to-peak amplitude of the signal.)

## SCH\_Phase

SCH\_Phase measures subcarrier-to-horizontal phase shift. The SCH\_Phase measurement can be made on any composite video signal containing sync and color burst. Version 2.07 firmware added an additional display to the Dual SCH Phase Measurement: two bar graphs showing the Burst Relative Phase in degrees and the Sync Relative Timing in nanoseconds.

SCH\_Phase refers to the phase relationship between the 50% point of the leading edge of sync and the zero crossings of the reference subcarrier (see Figure 2–63). Errors are expressed in degrees of subcarrier phase. The phase relationship is important when combining video sources or sequentially switching. Unless the sync edges of the two signals are properly timed to each other and the phases of the color bursts are matched, color shifts or horizontal jumps can occur when a switch is made. It is possible to achieve both timing relationships only if the two signals have the same SCH phase.

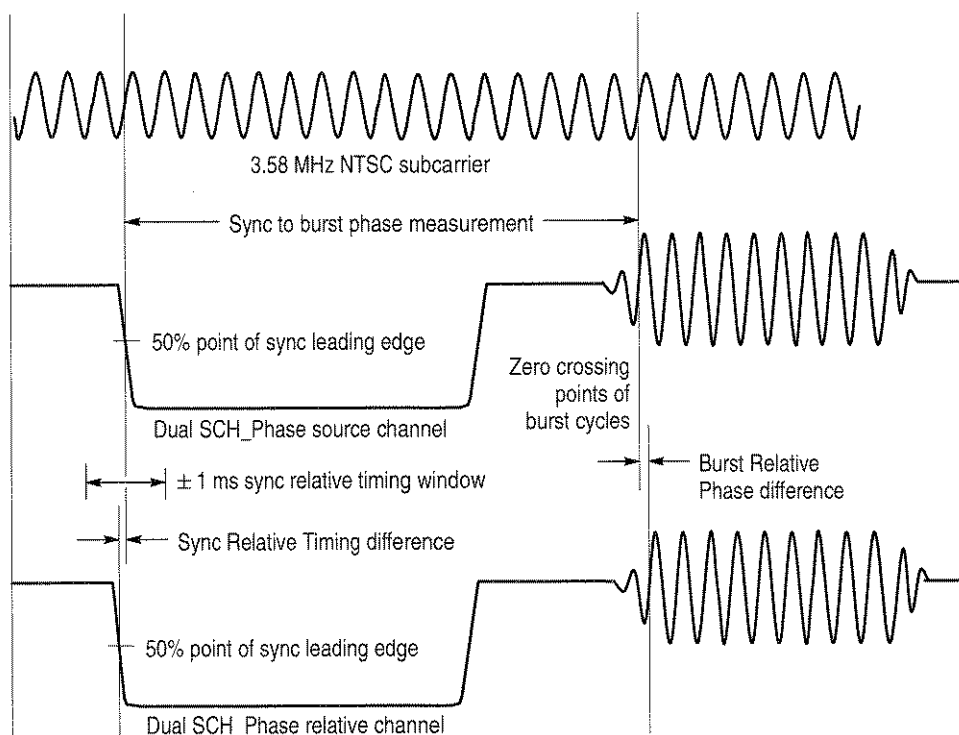

**Figure 2–63: Timing relationships for SCH\_Phase measurements and Sync Relative Timing and Burst Relative Phase measurements**

**SCH Phase Measurement**

Figure 2-64 shows the main SCH Phase Measurement display that is presented when the measurement is first executed. The single solid arrow indicates the SCH Phase of the selected source channel as selected by the A/B/C SOURCE buttons. The numerical readout in the upper right corner of the display assists in determining the exact number being indicated by the arrow. Use the Menu button from this display to modify the measurement's operation.

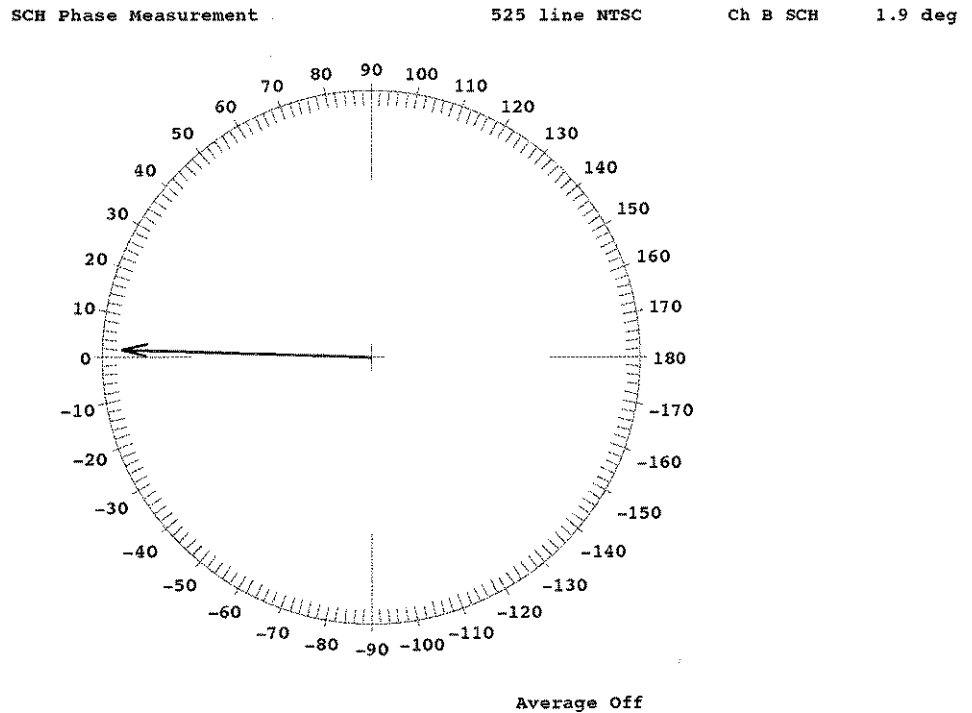

**Figure 2-64: SCH\_Phase display**

**Dual SCH Phase Measurements**

In a Dual SCH display, the SCH Phase measurements for the selected source channel and a reference channel are both shown. The solid arrow seen in Figure 2-65 shows the SCH phase measurement of the source channel selected by the A/B/C SOURCE buttons. A dashed arrow shows the SCH Phase measurement for the reference channel selection.

When the selected source and reference channel are different (for example, the source is Channel A and reference is Channel B) two additional measurements are displayed in both bar graph and numerical readout displays (see Figure 2-65). The bar graphs give a quick visual indication of closeness of channel match.

Numerical readouts give the numbers to assist in determining the exact channel-to-channel sync timing and color burst phase relationships. These two readouts show the phase difference between the source and reference channel burst and the sync timing difference between the source and reference channel sync.

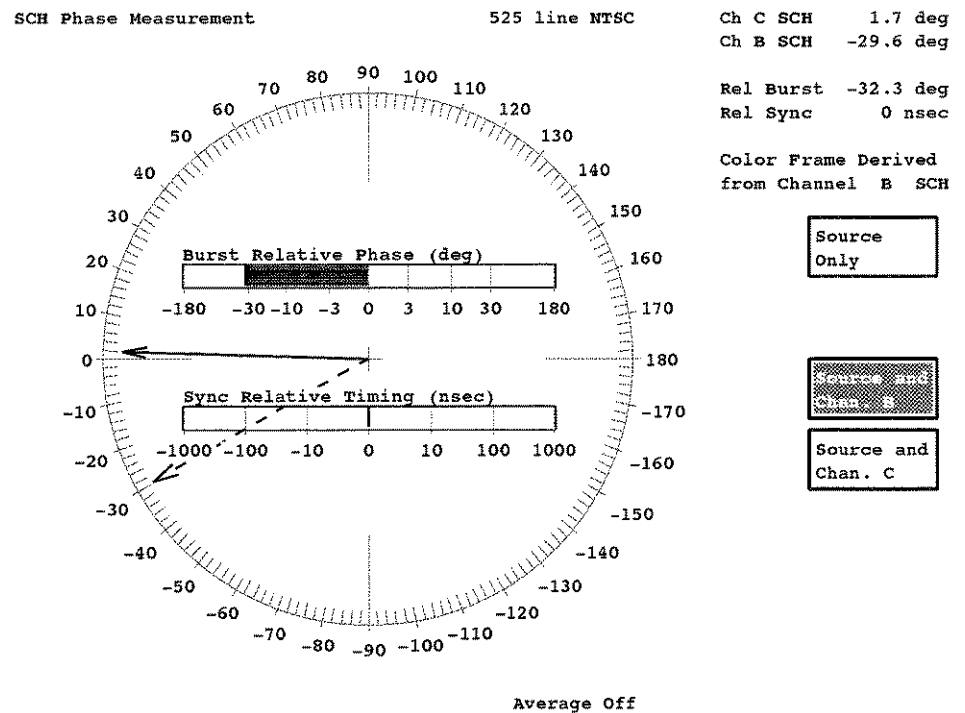

**Figure 2-65: Dual SCH display with Burst Relative Phase and Sync Relative Timing bar graphs**

The sync timing between the two channels must be within a  $\pm 1 \mu\text{s}$  window around the 50% point of the source channel sync leading edge before the measurement can be made. If the sync timing of the reference is skewed out of that window, the error message "Cannot find reference H Blanking" will be displayed.

### SCH\_Phase Menu

Pressing the Menu button displays the SCH\_Phase menu (Figure 2-66) used to make operational choices for the type of display and reference channel selections. In each case, the source channel remains the one that is selected by the A/B/C SOURCE buttons.

**Main Menu**

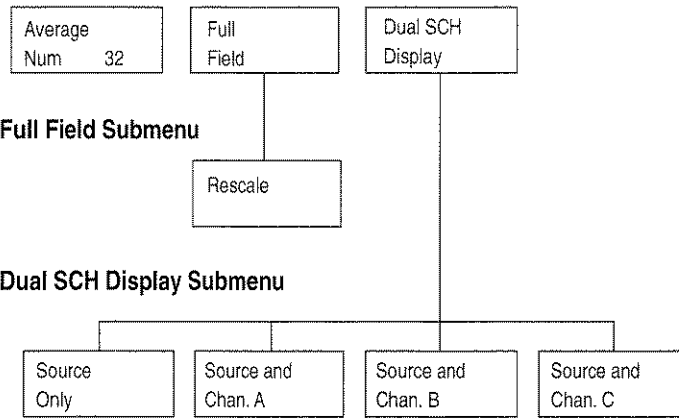

**Figure 2-66: SCH\_Phase menu tree**

**Main Menu**

- Average Num**      Average Num specifies the weighting factor to use for averaging. The Average Num range is 1 to 256. The default value is 32. To change the Average Num value, touch the Average Num soft key to highlight it, rotate the knob until the desired weighting factor appears; then touch the Average Num soft key again.
  
- Full Field**      Full Field puts up a display of the SCH values for each line in the frame.
  
- Dual SCH Display**      Dual SCH Display selects the reference channel for color framing. The dual SCH display shows two arrows: a solid one for the source, a dashed one for the reference channel used for color framing. If the two arrows appear on the same side of the vertical center line of the display, the source and reference channel have the same color frame timing. If they appear on different sides, the source and reference channel have different color frame timing.

**Dual SCH Display Submenu**

- Source Only**      Source Only sets the color framing reference to the current signal source as selected by the front-panel A/B/C buttons.

**Source and Channel**

Source and Channel A/B/C sets the color framing reference to Channel A, B, or C, as appropriate. In dual-standard instruments, only sources programmed for the same format that is being used to make measurements will be presented to the user for selection. For example, if Channel A and Channel C are set for PAL format and Channel B (set for NTSC) is selected as the measurement source, Channel A and Channel C will not be presented on the menu.

**Full Field Submenu****Rescale**

Rescale sets the expansion factor of the display to an appropriate scaling factor for the SCH\_Phase measurement display graticule. The x- and y-axes adjust to accommodate the rescaled display. The x-axis will scale to produce a signal display that will fill about 50% of the display area.

Figure 2-67 shows the SCH\_Phase full-field display and Figure 2-68 shows the expanded display obtained with the Rescale soft key.

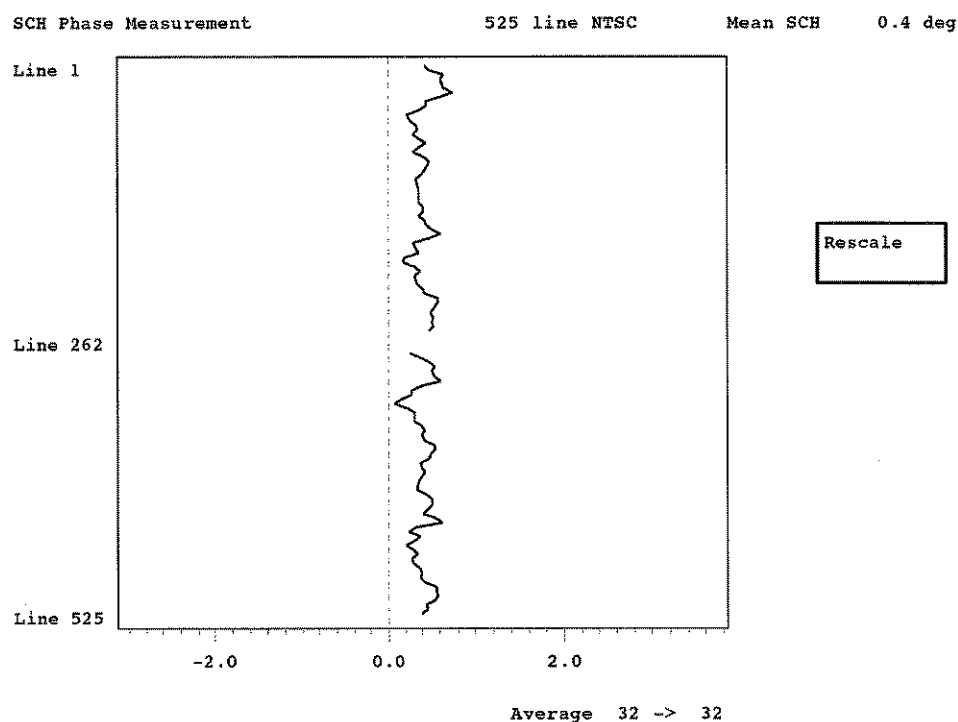

Figure 2-67: SCH\_Phase full-field display

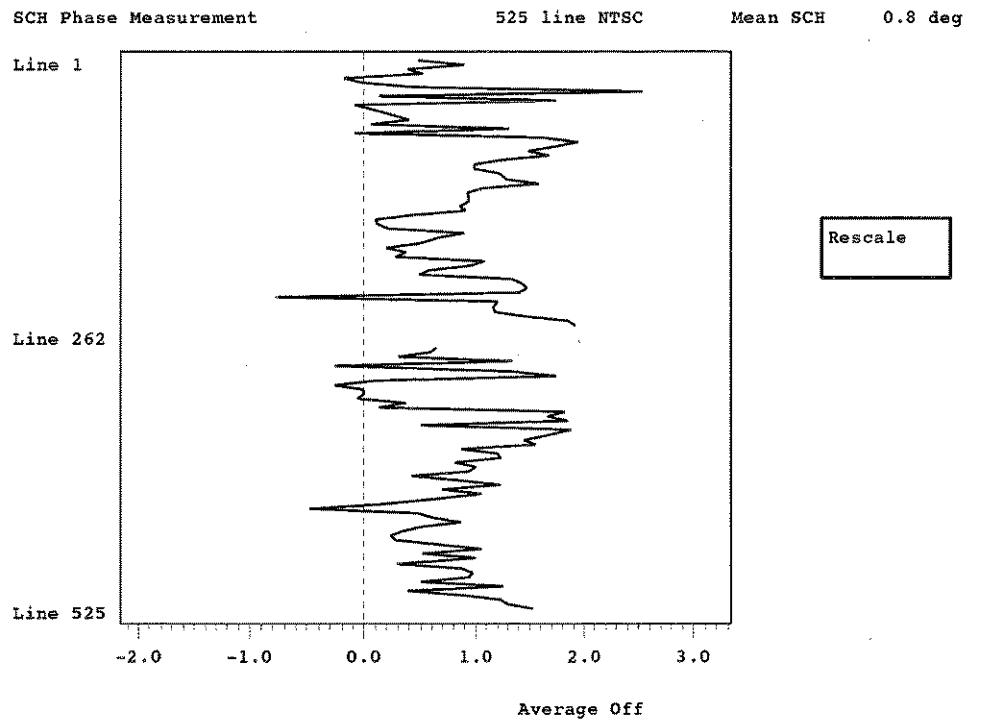

Figure 2-68: Rescaled SCH\_Phase full-field display



## ShortTime Distortion

ShortTime Distortion measures the amount of distortion in the reference-to-bar level and bar-to-reference level transitions of a bar signal.

The ShortTime Distortion display (Figure 2-69) plots signal level as a percentage of the voltage difference between the reference level (0%) and the bar level (100%). When the ShortTime Distortion measurement is first invoked, a set of graticules appears on the display, indicating the 5% ShortTime Distortion limits for the IEEE-511 standard. The gain on the graticule can be modified by using the Graticule Gain soft key in the Graticule submenu. You can also define your own graticule with the soft keys in the Make Graticule submenu of the Graticule submenu. (Refer to *Defining Your Own Graticule* later on page 2-124 for more information.)

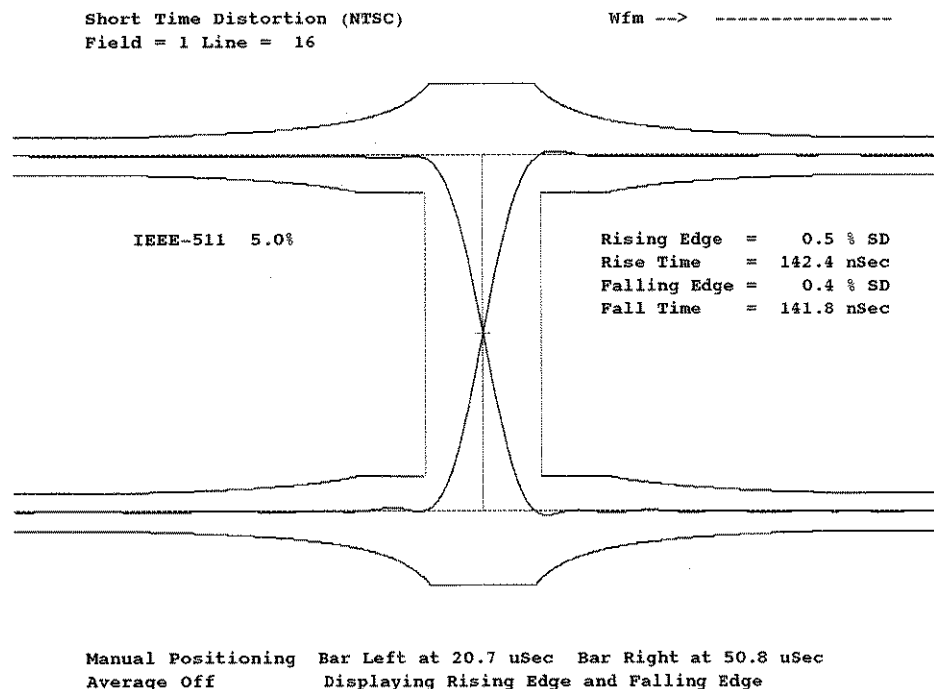

Figure 2-69: ShortTime Distortion display

Text readouts on the display show the following information:

- measurement name (ShortTime Distortion)
- signal standard being measured (NTSC)
- waveform type
- type (IEEE-511 or Special) and distortion percentage of graticule being used for the measurement
- amount of distortion in the rising or falling edge of the signal, referenced to the graticule being used
- rise and/or fall time of the signal in nanoseconds

The ShortTime Distortion measurement requires a T Bar signal to return a valid ShortTime Distortion measurement. The location of a T Bar signal can be specified in the “T Bar (SD)” line of the Measurement Locations file.

**ShortTime Distortion  
Main Menu**

Figure 2–70 shows the ShortTime Distortion menu tree structure. Pressing the Menu button when the ShortTime Distortion measurement runs displays the ShortTime Distortion main menu.

**Main Menu**

- |                       |  |
|-----------------------|--|
| <b>Average Num</b>    | Average Num specifies the weighting factor to use for averaging. The Average Num range is 1 to 256. The default value is 32. To change the Average Num value, touch the Average Num soft key to highlight it, rotate the knob until the desired weighting factor appears; then touch the Average Num soft key again. |
| <b>Change Display</b> | Change Display toggles the display between Rising Edge only, Falling Edge only, and both Rising Edge and Falling Edge. The text readout on the display follows the graph selected.   |
| <b>Acquire</b>        | Acquire displays the Acquire submenu, which controls signal acquisition for ShortTime Distortion.  |

- VITS Search**      VITS Search searches insertion test signals for a T Bar signal. If an appropriate signal is not located, the message Not found displays briefly on the screen.
- Rescale**          Rescale sets the expansion factor of the display to an appropriate scaling factor for the measurement display graticule. The x- and y-axes adjust to accommodate the rescaled display.

**Main Menu**

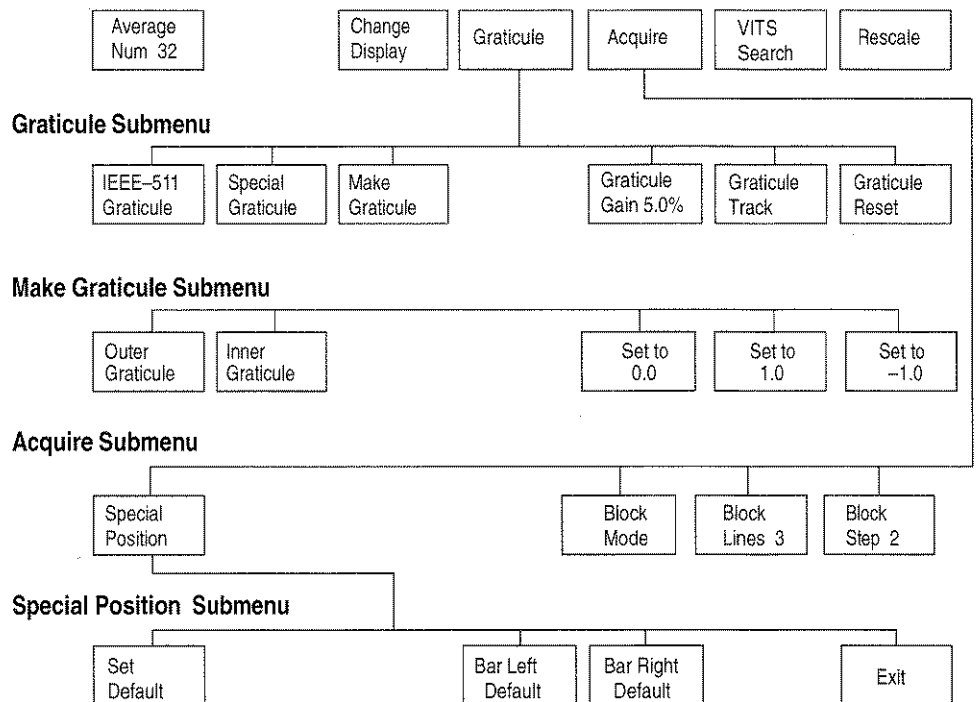

**Figure 2-70: ShortTime Distortion menu tree**

**Graticule Submenu**

- IEEE-511 Graticule**      IEEE-511 Graticule selects the IEEE-511 Standard Short-Time Distortion Graticule.
- Special Graticule**      Special Graticule selects the Special (user-defined) graticule for ShortTime Distortion measurements.

<b>Make Graticule</b>	Make Graticule displays the Make Graticule submenu, which provides soft keys to define the inner and outer graticules of the Special (user-defined) graticule. This soft key only appears when the Special Graticule soft key is highlighted.
<b>Graticule</b>	Graticule displays the Graticule submenu, controls the graticule gain and tracking of the current graticule, and to create a user-defined graticule.
<b>Graticule Gain</b>	Graticule Gain adjusts the graticule variable gain. The range is from 0.1% to 20.0%, with a resolution of 0.1%. To adjust the gain, highlight the soft key, turn the knob; then touch the soft key again.
<b>Graticule Track</b>	Graticule Track toggles to turn graticule tracking on or off. When the soft key is highlighted (graticule tracking on), the size of the graticule tracks the actual waveform.
<b>Graticule Reset</b>	Graticule Reset turns off graticule tracking and resets the graticule gain to 5.0%.

#### Make Graticule Submenu

<b>Outer Graticule</b>	Outer Graticule selects the outer pair of user-defined graticules for editing.
<b>Inner Graticule</b>	Inner Graticule selects the inner pair of user-defined graticules for editing.
<b>Set to 0.0</b>	Set to 0.0 sets the selected variable value to 0. This soft key is only displayed when a coefficient has been selected from one of the three editing lines.
<b>Set to 1.0</b>	Set to 1.0 sets the selected variable value to 1. This soft key is only displayed when a coefficient other than T has been selected from one of the three editing lines.
<b>Set to -1.0</b>	Set to -1.0 sets the selected variable value to -1. This soft key is only displayed when a coefficient other than T has been selected from one of the three editing lines.

#### Acquire Submenu

<b>Special Position</b>	Special Position displays the Special Position submenu and display (Figure 2-71) which sets the measurement locations for the ShortTime Distortion measurement.
<b>Block Mode</b>	Block Mode turns on Block mode. The block starts at the system line.

**Block Lines** Block Lines sets the number of lines to average for the measurement. The default number of Block Lines to average is 3.

**Block Step** Block Step sets the number of lines to step in the block. The default number of lines to step is 2.

**Special Position Submenu**

**Set Default** Set Default resets the selected soft key (Bar Left or Bar Right) to its default location. If none are selected, all are reset. Default locations are specified in the current Measurement Locations file.

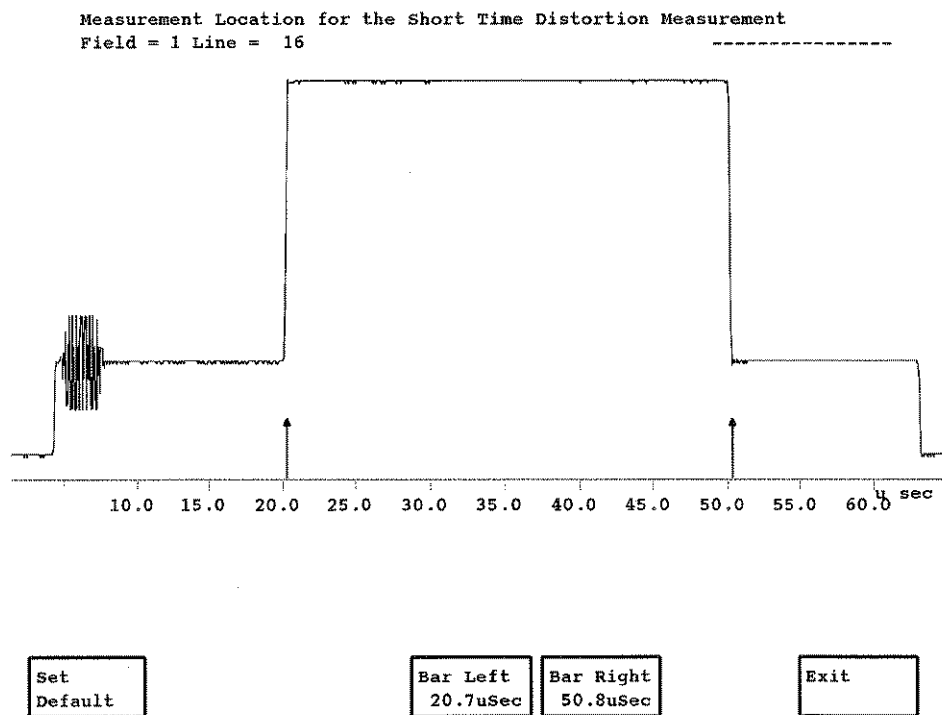

Figure 2-71: ShortTime Distortion Special Position display

<b>Bar Left</b>	Bar Left defines the location of the leading edge of Bar, represented by an arrow in the graph. When this soft key is highlighted, use the knob to move the Bar Left position.
<b>Bar Right</b>	Bar Right defines the location of the trailing edge of Bar, represented by an arrow in the graph. When this soft key is highlighted, use the knob to move the Bar Right position.
<b>Exit</b>	Exit leaves the Measurement Locations display and returns to the ShortTime Distortion display.

### Defining Your Own Graticule

The ShortTime Distortion measurement's graticule defines the boundaries of the distortion envelope for a given graticule gain setting. The displayed graticule consists of an outer graticule and an inner graticule, mirrored around the 50% level.

You can define your own graticule for the ShortTime Distortion measurement by means of the Make Graticule submenu. Do the following steps to access the Make Graticule submenu.

1. Press the Menu button to display the ShortTime Distortion main menu.
2. Touch the Graticule soft key.
3. Touch the Special Graticule soft key if it is not already highlighted. When Special Graticule is highlighted, the Make Graticule soft key displays beside it.
4. Touch the Make Graticule soft key. The Make Graticule submenu, consisting of the Outer Graticule and Inner Graticule soft keys, should be visible on the display and not highlighted. The top half of the inner and outer graticule pair (that is the graticule surrounding the bar-level region) should also display. Any changes made to the top half of the graticules are mirrored in the bottom half.

To change the shape of the outer or inner graticule, touch the corresponding soft key. This displays three editable lines of equations (see Figure 2-72).

Each graticule is divided into three areas. Area 1 is innermost, nearest the y-axis. Area 2 is the middle area. Area 3 is outermost, furthest away from the y-axis. The three lines of equations correspond to the three areas of the line being edited.

Editing the equations consist of changing the values of the coefficients in the following equation:

$$grat = A * exp(B * (T^C)) * (T^D) + E$$

To select a line to edit, turn the knob when no coefficient of a line is selected (that is when an edit box is visible around any coefficient in the selected line).

To edit a coefficient in the selected line, touch the coefficient you wish to edit. For coefficients A, B, C, D, or E, this brings up three more soft keys labeled “Set to 0.0”, “Set to 1.0”, and “Set to -1.0”. (When the T coefficient is selected, only the “Set to 0.0” soft key is displayed.) To set the value of the coefficient, turn the knob or touch one of the soft keys. The effect of the change on the graticule is shown immediately.

To finish making changes to an equation, touch the selected coefficient. The edit box disappears, and you can then turn the knob to select a new line to edit, or press the Menu button to exit the Make Graticule submenu.

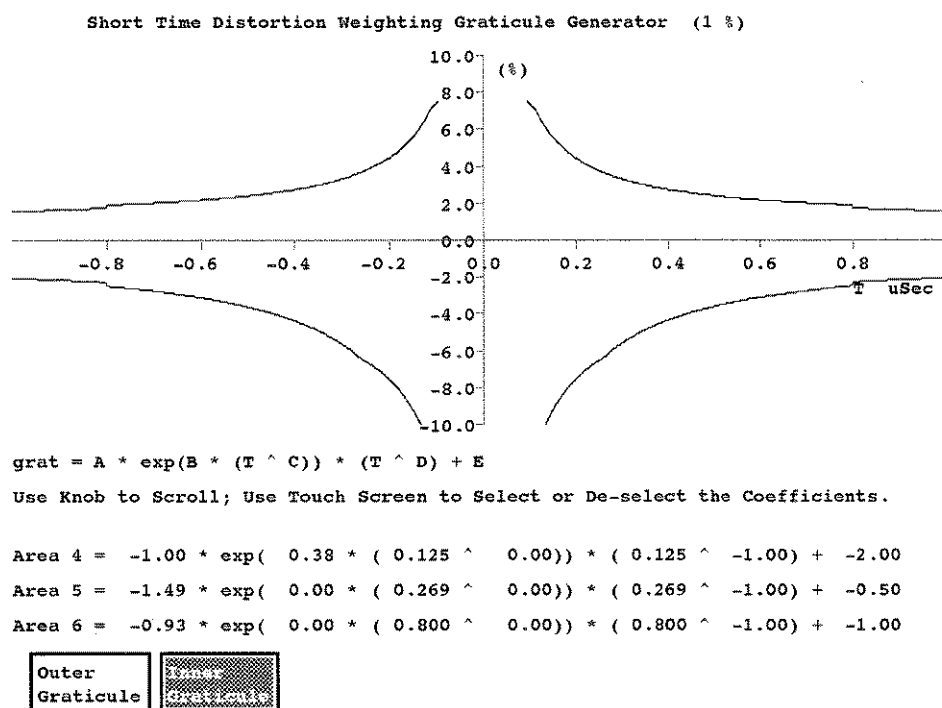

**Figure 2-72: Make Graticule display with inner graticule selected**

**NOTE.** The Make Graticule submenu defines the boundaries of the distortion envelope for 1% gain. The default gain for the main ShortTime Distortion display is 5%. You can adjust the gain value with the Graticule Gain soft key of the Graticule submenu.

To adjust the gain, highlight the soft key, turn the knob until the desired gain value is displayed; then touch the soft key again.

## TwoField

TwoField measures field time distortion. It is also useful for quick viewing of certain waveform characteristics.

Figure 2-73 shows the TwoField display. The display plots the amplitude of any combination of sync tip, back porch, luminance, or peak-to-peak chrominance, showing 525 points for each. The items displayed are selected by means of the TwoField Menu soft keys; the default is to display sync tip, back porch, and luminance.

The TwoField measurement requires a field square wave as input.

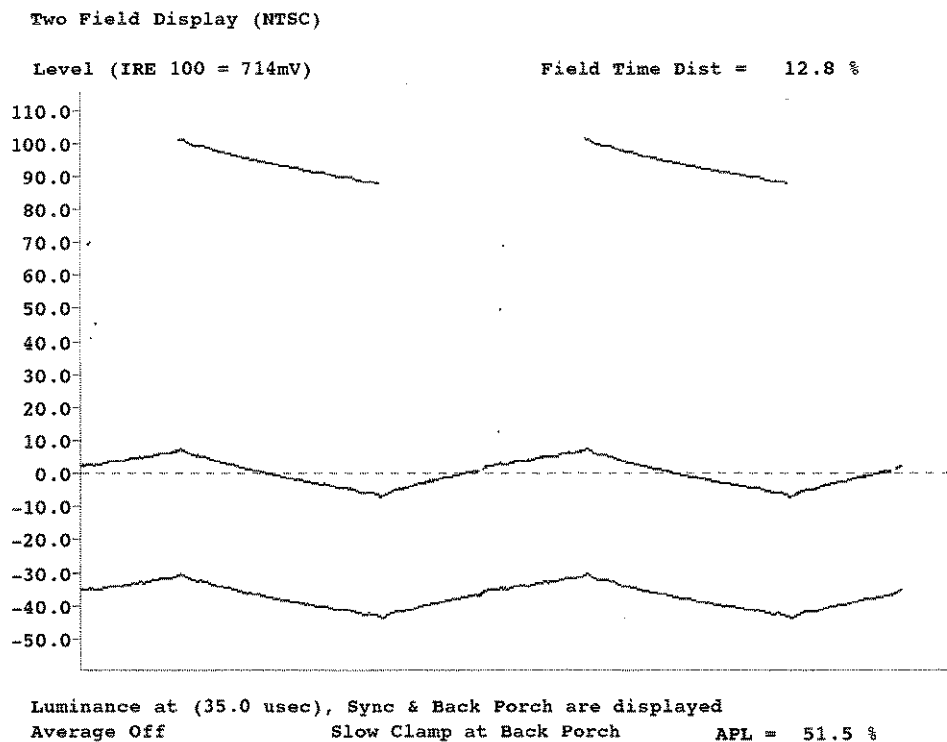
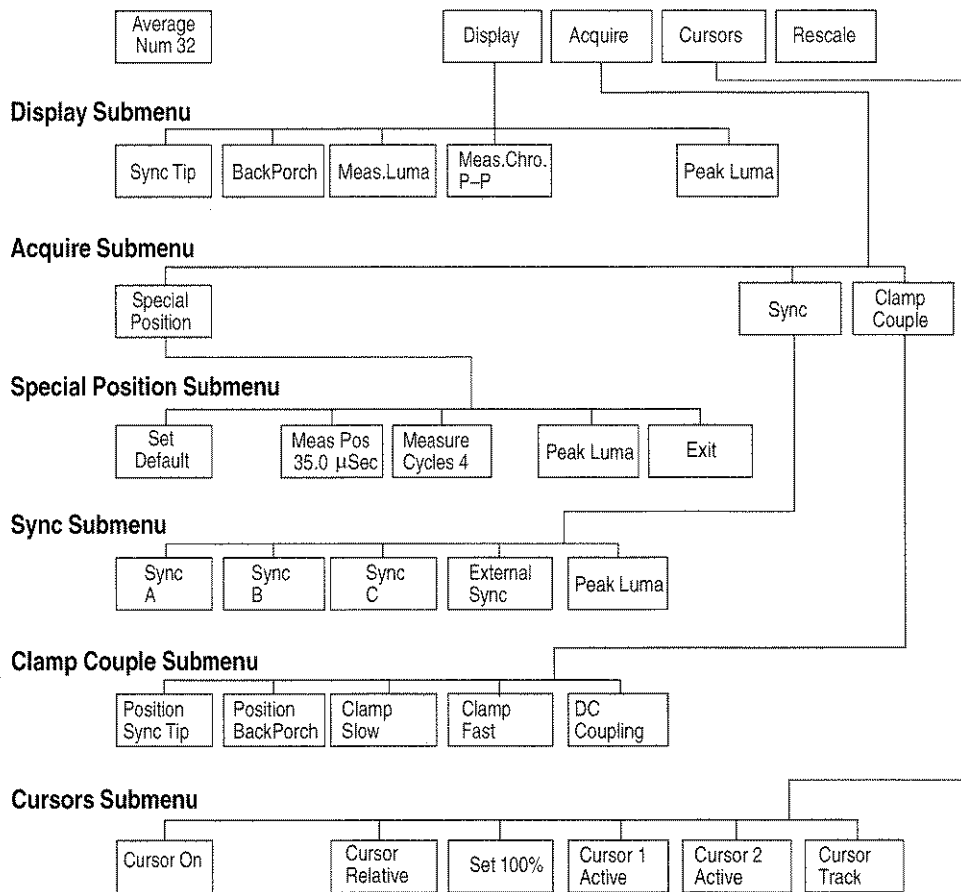

Figure 2-73: TwoField display



**TwoField Menu** Pressing the Menu button when the TwoField measurement runs displays the TwoField menu (Figure 2-74).

**Main Menu**



**Figure 2-74: TwoField menu tree**

**Main Menu**

**Average Num** Average Num specifies the weighting factor to use for averaging. The Average Num range is 1 to 256. The default value is 32. To change the Average Num value, touch the Average Num soft key to highlight it, rotate the knob until the desired weighting factor appears; then touch the Average Num soft key again.

**Display** Display calls up the Display submenu for selection of waveforms.

- Acquire** Acquire calls up the Acquire submenu that provides acquisition control.
- Cursors** Cursors provides soft keys to display and activate the cursors.
- Rescale** Rescale sets the expansion factor of the display to an appropriate scaling factor for the TwoField measurement display graticule. The x- and y-axes adjust to accommodate the rescaled display.

**Display Submenu**

- Sync Tip** Sync Tip selects sync tip for the display.
- BackPorch** BackPorch selects back porch for the display.
- Meas.Luma** Meas.Luma selects averaged luminance level at the measurement position for the display.
- Meas.Chro P-P** Meas.Chro P-P selects averaged chrominance level at the measurement position for the display.
- Peak Luma** Peak Luma selects peak luminance level in the active area for the display.

**Acquire Submenu**

- Special Position** Special Position displays the Special Position submenu (see Figure 2-75) that sets the locations on the waveform where the measurement is made.
- Sync** Sync provides soft keys to set the sync source.
- Clamp Couple** Clamp Couple displays a submenu that allows you to set the Clamping mode used by the TwoField measurement.

**Special Position Submenu**

- Set Default** Set Default resets the selected soft key to its default value, or resets all of the soft keys, if no soft key is currently selected at this level. Deselects peak luminance mode.
- Meas. Pos  
nn.n  $\mu$ sec** Meas. Pos chooses where the measurement is made. The center tick of the displayed box shows the measurement position. Select and turn the knob to change the location from the horizontal sync.

- Measure Cycles *n*** Measure Cycles chooses how many chrominance subcarrier cycles are averaged for the measurement. The width of the displayed box shows the measurement area determined by the selected number of cycles. Select and turn the knob to change the number of cycles.
- Peak Luma** Peak Luma selects peak luminance level in the active area for the display.
- Exit** Exit leaves the Special Position display and returns to the Two Field measurement display.

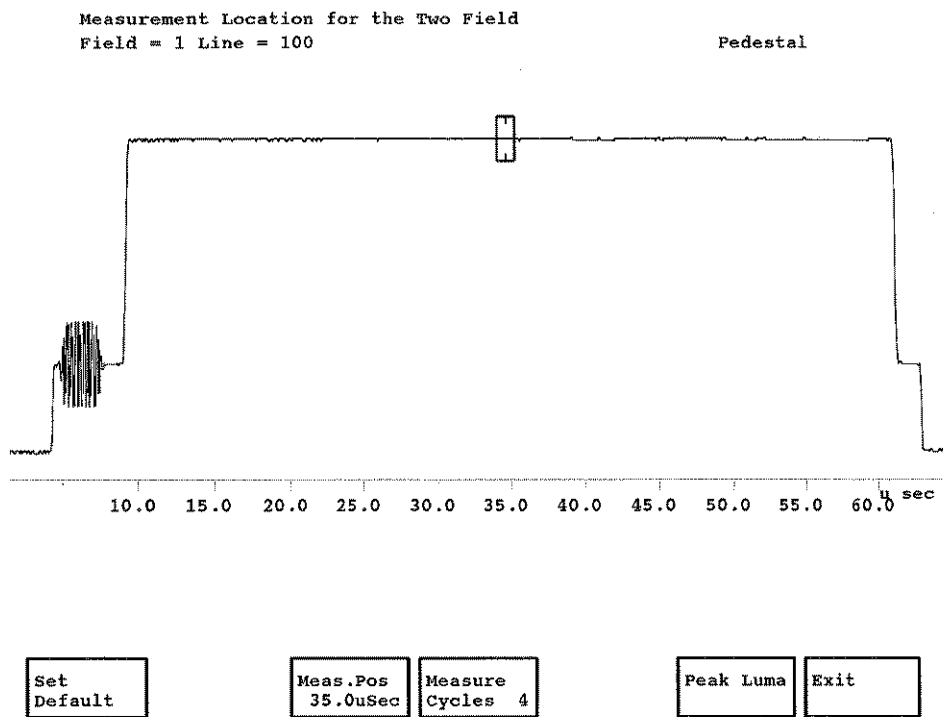

Figure 2-75: TwoField Special Position display

**Sync Submenu**

- Sync A/B/C** Sync A/B/C selects the A, B, or C input for the sync source.
- External Sync** External Sync selects the external sync input for the sync source.
- Peak Luma** Peak Luma selects peak luminance level in the active area for the display.

**Clamp Couple Submenu**

- Position Sync Tip**                      Sync Tip selects sync tip for the display.
- Position BackPorch**                Position BackPorch selects back porch for the display.
- Clamp Slow**                            Clamp Slow selects slow clamp speed. This speed allows hum effects to be visible, but is useful in coping with large DC offsets on an input signal.
- Clamp Fast**                             Clamp Fast selects fast clamp speed. This speed removes DC offset, hum, and bounce effects from the signal. This is the default clamp setting for the TwoField measurement.
- DC Coupling**                          DC Coupling selects DC coupling (no clamping).

**Cursors Submenu**

- Cursor On**                              Cursor On displays cursors. Two horizontal cursors appear in the position they were in the last time the cursor was active.
- Cursor Relative**                      Cursor Relative selects relative cursor mode. The cursor delta displays relative to the reference.
- Set 100%**                                Set 100% stores the current cursor delta as the reference.
- Cursor 1/2 Active**                    Cursor 1/2 Active displays cursors and causes the knob to move cursor 1 or 2.
- Cursor Track**                          Cursor Track displays cursors and causes the knob to move both cursors.

## VITS\_ID

VITS\_ID identifies and lists test signals in the vertical interval.

Figure 2-76 shows the VITS\_ID signal ID display. It shows the name of any recognized signal in the vertical interval, and displays the waveform of the current system line. To select a new system line, touch the name of any signal in the upper portion of the display.

Figure 2-77 shows the VITS\_ID VITS waveform display. It shows the waveform of all signals in the vertical interval for both fields. You can select a new system line by touching the position of any line shown on the display.

VITS Identification (NTSC)

Field 1	Field 2
Line 15 --> GCR 8 Fields Seq.	Line 15 --> GCR 8 Fields Seq.
Line 16 --> VIRS	Line 16 --> Sin X/X
> Line 17 --> FCC Multi Burst	Line 17 --> NTC-7 Combination
Line 18 --> Pedestal	Line 18 --> Pedestal
Line 19 --> Pedestal	Line 19 --> VIRS
Line 20 --> Luminance Bar	Line 20 --> Pedestal

Field = 1 Line = 17

FCC Multi Burst

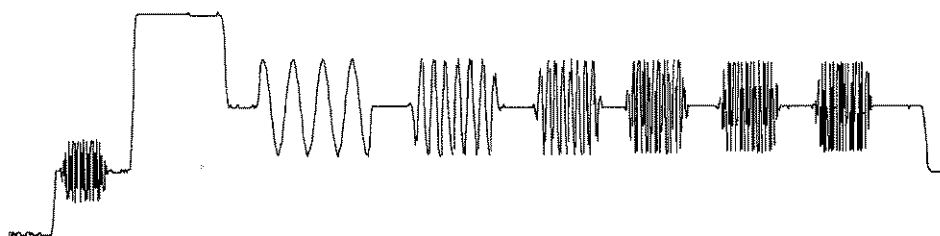

Figure 2-76: VITS\_ID signal ID display

VITS Identification (NTSC)  
 Field = 1 Line = 17

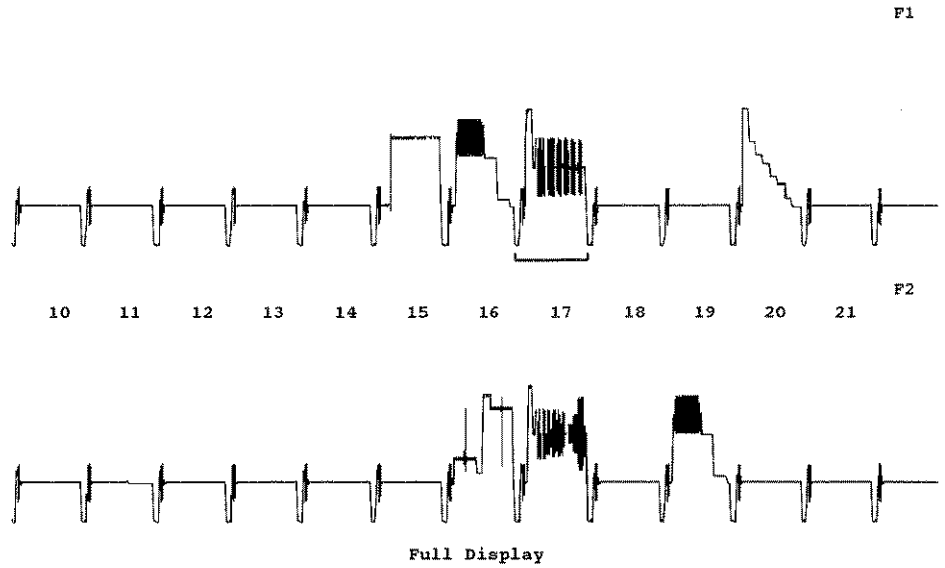

Figure 2-77: VITS ID full VITS waveform display

**VITS ID Menu**

Pressing the Menu button when the VITS ID measurement runs displays the VITS ID menu (see Figure 2-78).

**Main Menu**

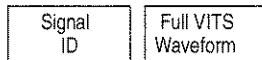

Figure 2-78: VITS ID menu tree

**Main Menu**

**Signal ID**

Signal ID shows VITS names. The waveform of the system line is also displayed when menus are deselected.

**Full VITS Waveform**

Full VITS Waveform shows waveform lines 10 to 22 for both fields.

## V\_Blank

V\_Blank shows vertical blanking waveforms and measures pulse widths and rise and fall times for the equalizer and serration pulses.

Figure 2-79 shows the full V\_Blank display, which diagrams the vertical blanking intervals of 32 lines from each of four color fields. The current system line is indicated by a bracket beneath it. You can select a new system line by touching any line on the display.

Figure 2-80 shows the V\_Blank equalizer pulse display, showing the width, rise time, and fall time of the equalizer pulse in field 2, line 2.

Figure 2-81 shows the V\_Blank serration pulse display, showing the width, rise time, and fall time of the serration pulse in field 2, line 5.

Figure 2-82 shows the V\_Blank V-sync display. This is essentially the same as the full V\_Blank display, except that the vertical sync area is shown.

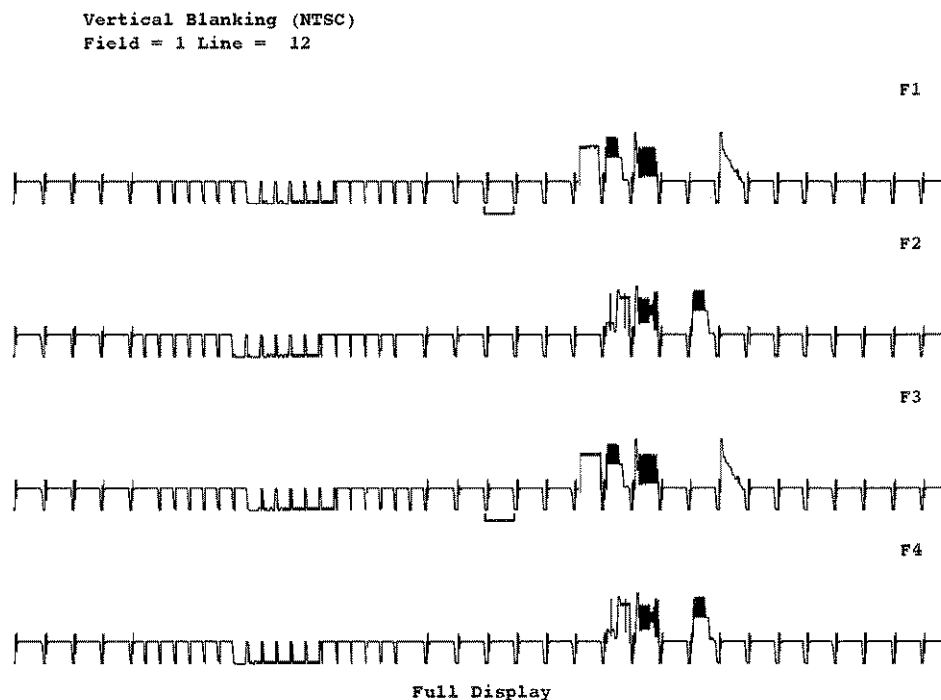

Figure 2-79: V\_Blank full display

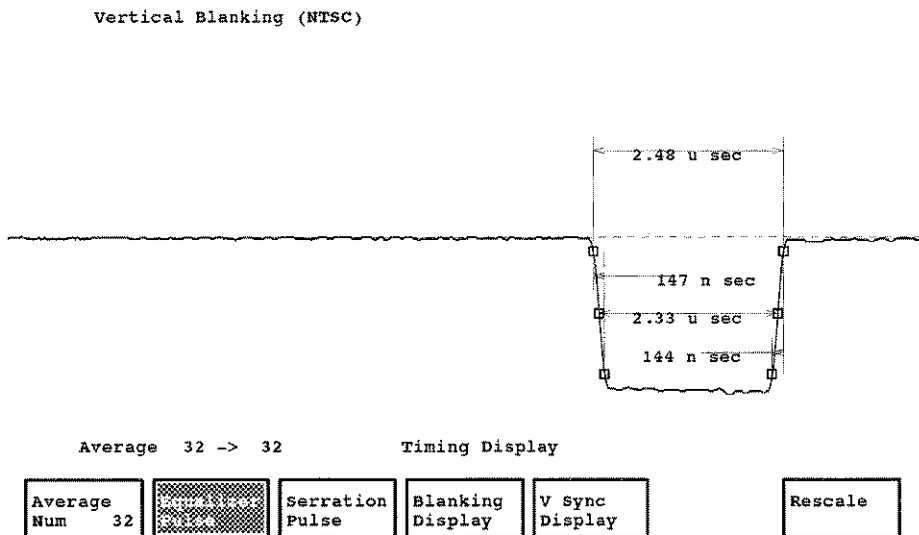

Figure 2-80: V\_Blank equalizer pulse display

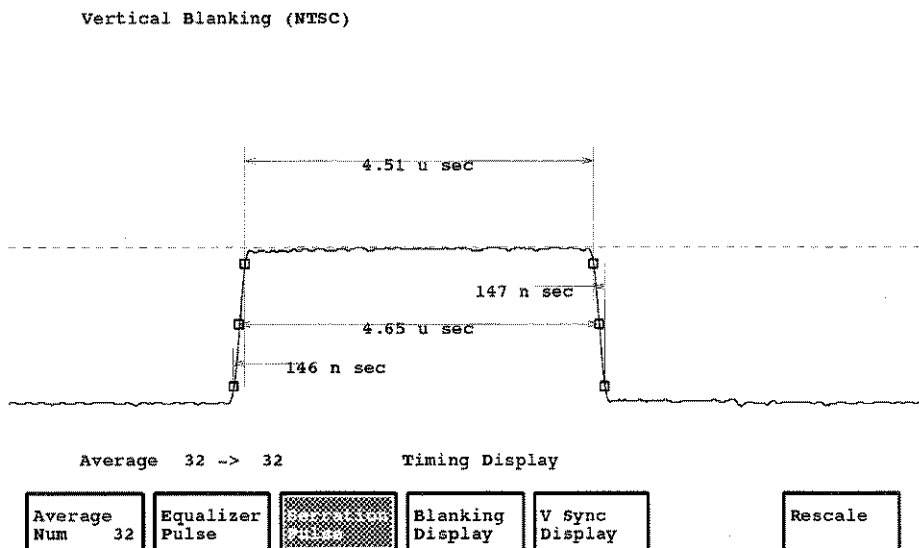

Figure 2-81: V\_Blank serration pulse display



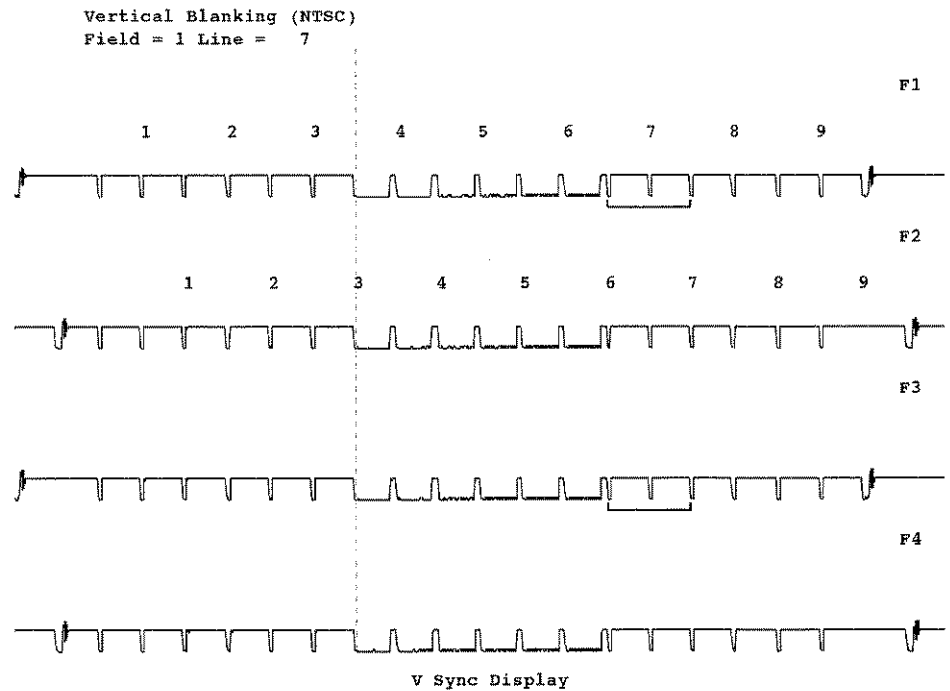

Figure 2-82: V\_Blank V-sync display

**V\_Blank Menu** Pressing the Menu button when the V\_Blank measurement runs displays the V\_Blank menu (Figure 2-83).

**Main Menu**

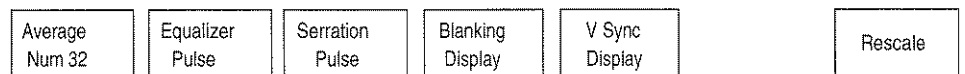

Figure 2-83: V\_Blank menu tree

**Main Menu**

**Average Num** Average Num specifies the weighting factor to use for averaging. The Average Num range is 1 to 256. The default value is 32. To change the Average Num value, touch the Average Num soft key to highlight it, rotate the knob until the desired weighting factor appears; then touch the Average Num soft key again.

**Equalizer Pulse** Equalizer Pulse displays an equalizer pulse and measures it.

<b>Serration Pulse</b>	Serration Pulse displays a serration pulse and measures it.
<b>Blanking Display</b>	Blanking Display shows the vertical blanking sections of four fields. Each field has 32 lines in the display area.
<b>V Sync Display</b>	V Sync Display displays the vertical sync sections of four fields. Each field has 11 lines in the display area.
<b>Rescale</b>	Rescale sets the expansion factor of the display to an appropriate scaling factor for the V_Blank measurement display graticule. The x- and y-axes adjust to accommodate the rescaled display.

## Video Standard

Video Standard recognizes the standard of the current input source (NTSC or PAL).

When running a dual-standard VM700T (that is, an instrument equipped with both Option 01, NTSC, and Option 11, PAL), it is possible to connect a signal of one standard to a channel that is expecting another. The Video Standard measurement guards against this error.

When you press the Measure button and touch the Video Standard soft key, the VM700T recognizes the standard of the incoming signal on the current channel, and uses the correct Video\_Source file for that standard.

---

**NOTE.** When Video Standard changes the standard for a source, the change is NOT reflected in the display shown when you touch the Video Source soft key. Also, executing a function that includes a RestoreConfig command may restore incorrect values into the Video Source file.

---

Video Standard stores its measurement results in the “Measurement Results” directory in /nvram0/ConfigFiles. To view Video Standard measurement results, press the Configure button, then touch Configure Files, Measurement Results, and Video Standard. The file shows the time that Video Standard was last executed and lists the standard recognized for each input channel. If no standard was recognized for a channel, “——” displays as the measurement result.



# Auto Mode



# Auto Mode

Auto mode of the VM700T performs many industry-standard measurements with great speed and accuracy. To do so, the VM700T selects portions of the video input signal, converts them from analog to digital representation, then analyzes the digitized values to produce numeric measurement results.

This section details the analysis methods for each Auto mode measurement that the VM700T is capable of making. In general, the analysis methods are similar to those currently used throughout the television industry.

## Input Signals

Auto mode makes most of its measurements on the Vertical Interval Test Signals (VITS). The VITS that Auto mode can use include NTC-7 Composite and Combination VITS, FCC Composite and Multiburst VITS, FCC Color Bars, VIRS (Vertical Interval Reference Signal), and the Zero Carrier pulse. Several measurements do not use any special test signals. For example, the Horizontal Blanking Width measurements use active video lines.

## Test Signal Locations

Test signal locations for Auto mode measurements are given by the Measurement Locations file. The system default Measurement Locations file uses the signal locations shown in Table 3-1.

**Table 3-1: Measurement Locations file defaults**

Signal Name	Location
Zero Carrier Pulse	Field 1, Line 16
FCC Composite VITS	Field 1, Line 18
FCC Multiburst VITS	Field 1, Line 17
VIRS	Field 1, Line 19
FCC Color Bars	Field 2, Line 17
Noise Line (Quiet)	Field 1, Line 12

Note that the default setting in the system default file in the Measurement Locations directory does not select Zero Carrier as the amplitude reference.

If the test signal is not located on the specified line when a measurement is performed that needs that test signal, then an error message is reported, such as No Multiburst or No Composite VITS.

## Measurement Methods

This section describes how each Auto mode measurement is made. Where applicable, a timing standard is also listed for each measurement.

**APL** The Average Picture Level is determined by measuring the active video area of the analog input signal with an internal digital voltmeter. APL is measured on a single field of video at the beginning of each measurement cycle (each pass through the list of selected measurements).

### Peak Carrier and Zero Carrier Pulse

The peak carrier and Zero Carrier Pulse amplitudes are not displayed by the VM700T, but are measured and used as a reference for the Bar Top, Blanking Level, Blanking Variation, Sync Variation, FCC Multiburst Flag, and NTC7 Multiburst Flag measurements. These measurements are reported as % Carr.

**Zero Carrier Pulse.** Zero Carrier pulse amplitude and Peak Carrier amplitude are measured on the vertical interval line that includes the Zero Carrier pulse.

Eight occurrences of the vertical interval line carrying the Zero Carrier pulse are acquired, one frame apart.

Zero Carrier pulse amplitude is measured from back porch blanking level to the top of the Zero Carrier pulse. The blanking level is the average of 28 consecutive samples (2  $\mu$ s), beginning at the sample that is 6.0  $\mu$ s after the sync pulse leading edge 50% point. The Zero Carrier pulse top level is the average of 32 consecutive samples (2.25  $\mu$ s), centered around the sample that is at the estimated center of the Zero Carrier pulse as defined in the appropriate Measurement Locations file in Configure (the default location is 25.5  $\mu$ s after the 50% point of the leading edge of sync).

**Peak Carrier Pulse.** Peak Carrier amplitude is measured from the sync tip level to the level at the top of the Zero Carrier pulse. The sync tip level is the average of 28 consecutive sample values (2  $\mu$ s), starting 1.5  $\mu$ s after the sync pulse leading edge 50% point. The Zero Carrier pulse top level is the same as in the Zero Carrier pulse amplitude measurement, described in the previous paragraph.

### Bar Amplitude, Blanking Level, Bar Top, and Sync Amplitude

(FCC Rules and Regulations Part 73.682 and NTC Report Number 7)

Thirty-two occurrences, one frame apart, are acquired of the vertical interval line carrying the FCC or NTC-7 Composite test signal. Acquiring samples from one line per frame over 32 frames, summing, and then averaging, reduces the effects of noise on the measurement. This also filters out the chrominance component of the signal, which is not needed to make these measurements.

**Bar Top.** The Bar Top level is the average of 12 consecutive sample values, centered midway between the approximate 50% points of the leading and trailing edges of the bar. This measurement is always expressed as % Carr and is not made unless Zero Carrier is selected as an amplitude reference in the appropriate Measurement Location file, and it is found on the designated line. Note that the default setting does not use Zero Carrier as a reference.

**Blanking Level.** Blanking level is calculated as a function of the Peak Carrier and Zero Carrier pulse amplitudes, which are determined with the method discussed previously under Peak Carrier and Zero Carrier Pulse topic. Then,

$$\% \text{ Blanking Level} = \frac{\text{Zero Carrier pulse amplitude}}{\text{Peak Carrier amplitude}} \times 100$$

This measurement is always expressed as % Carr and is not made unless Zero Carrier is selected as an amplitude reference in the appropriate Measurement Location file, and it is found on the designated line. Note that the default setting does not use Zero Carrier as a reference.

**Bar Amplitude.** Bar amplitude is measured from blanking level to the center of the Bar Top level (*NTC-7, Section 3.2*). The blanking level is the average of 12 consecutive samples. If FCC Composite VITS, then these samples are centered around the point that is 2.1  $\mu\text{s}$  before the measured 50% point of the bar leading edge. If NTC-7 Composite VITS, then these samples are centered around the point that is 10.9  $\mu\text{s}$  after the measured 50% point of the bar trailing edge. Bar amplitude is reported in IRE.

**Sync Amplitude.** Sync amplitude is measured from blanking level to the center of the horizontal sync tip pulse. The blanking level is the average of 16 consecutive sample values, centered around the sample that is 6.55  $\mu\text{s}$  after the 50% point of the leading edge of the sync pulse (nominal center of burst). The sync tip level is the average of eight consecutive sample values, centered midway between the 50% points of the leading and trailing edges of the sync pulse. Sync amplitude is reported in % Bar (when bar is present on this line) or as IRE (when bar is not present).

### Blanking Variation and Sync Variation

#### (FCC Rules and Regulations Part 73.682)

Blanking Variation and Sync Variation measurement results are expressed as both % Carr and IRE.

Parts of the sync tip and the back porch are acquired from 85 different active video lines in field 1. The samples are acquired from every third line, starting at field 1, line 10, and ending with field 1, line 262. The hardware low-pass filter is used.

**Blanking Variation.** Blanking variation is measured as the peak-to-peak variation of the blanking level within a field [FCC 73.682(a)(16)]. A blanking level is calculated for each of the acquired back porches as the arithmetic mean of 16 consecutive sample values, starting 6.7  $\mu$ s after the assumed position of the sync pulse leading edge 50% point. Within the resulting set of 85 blanking levels, the maximum blanking level and the minimum blanking level are found. The blanking variation measurement result is the difference between the two extreme levels, reported as % Bar (when bar is present on the composite VITS line) or as IRE (when bar is not present).

**Sync Variation.** Sync variation is measured as the peak-to-peak variation of the horizontal sync pulse amplitude within a field [FCC 73.682(a)(16)]. A sync tip level is calculated for each of the acquired sync tips as the arithmetic mean of 16 consecutive sample values, starting 1.8  $\mu$ s after the assumed position of the sync pulse leading edge 50% point. Within the resulting set of 85 sync tip levels, the maximum and the minimum sync tip levels are found. The difference between the two extreme levels, reported as % Bar (when bar is present) or as IRE (when bar is not present).

#### **Burst Amplitude (FCC Rules and Regulations Part 73.699)**

The Burst Amplitude measurement is made on the line where the Composite VITS is expected. Thirty-two occurrences of the line are acquired, one line per frame over 32 successive frames.

Burst amplitude is measured as the peak-to-peak amplitude of the color burst at burst center. For each of the acquired lines, the average peak-to-peak amplitude is determined over four subcarrier cycles at the center of burst. (The center of burst is located midway between the 50% points on the leading and trailing edges of the sampled burst chrominance envelope.)

The 32 results are summed and averaged, and the average is the measurement result. The measurement result is reported twice, first as % Sync and secondly as % Bar (when bar is present) or as IRE (when bar is not present).

#### **FCC Horizontal Blanking Interval Timing Measurements (FCC Rules and Regulations Part 73.699)**

Thirty-two occurrences of the horizontal blanking interval are acquired from the active picture area, starting at field 1, line 50, and acquiring 32 lines separated by one frame and six lines. Therefore, the second acquisition is in field 2 at line 56).

**FCC H Blanking.** FCC Horizontal Blanking is measured between the points on the leading and trailing edges of horizontal blanking that are equivalent to 10% of sync (nominally +4 IRE).



**FCC Sync Width.** FCC Sync Width is measured between the 10% points on the leading and trailing edges of horizontal sync (nominally  $-4$  IRE).

**FCC Sync-Setup.** FCC Sync-Setup is measured from the 10% point on the leading edge of sync (nominally  $-4$  IRE) to the point on the trailing edge of blanking that is equivalent to 10% of sync (nominally  $+4$  IRE).

**FCC Front Porch.** FCC Front Porch is measured from the 10% point on the trailing edge of setup ( $+4$  IRE nominally) to the 10% point on the leading edge of sync (nominally  $-4$  IRE).

**Sync to Burst End.** Sync to Burst End is measured from the 10% point on the leading edge of horizontal sync (nominally  $-4$  IRE) to the half-amplitude point on the trailing edge of the burst envelope.

**Breezeway Width.** Breezeway Width is measured from the 10% point on the trailing edge of horizontal sync (nominally  $-4$  IRE) to the leading half-amplitude point of the burst envelope.

**FCC Burst Width.** FCC Burst Width is measured from the leading half-amplitude point on the chrominance envelope of burst to the trailing half-amplitude point on the chrominance envelope.

**Sync Rise Time and Sync Fall time.** The Sync Rise time and Sync Fall times are measured between the 10% and 90% points on the leading and trailing edges of horizontal sync (nominally  $-4$  IRE and  $-36$  IRE).

Note that the RS170-A and FCC specifications for these two measurements are identical, so the measurements are displayed only once by Auto mode.

### RS-170A Horizontal Blanking Interval Timing Measurements

#### (RS-170A)

Thirty-two occurrences of the horizontal blanking interval are acquired from the active picture area, starting at field 1, line 50 and acquiring 32 lines separated by one frame and six lines. Therefore, the second acquisition is in field 2 at line 56).

**RS-170A H Blanking.** RS-170A H Blanking is measured between the points on the leading and trailing edges of horizontal blanking that are equivalent to 50% of sync (nominally 20 IRE).

**RS-170A Sync Width.** RS-170A Sync Width is measured between the 50% points on the leading and trailing edges of horizontal sync (nominally  $-20$  IRE).

**RS-170A Sync-Setup.** RS-170A Sync-Setup is measured from the 50% point on the leading edge of sync (nominally  $-20$  IRE) to the point on the trailing edge of blanking that is equivalent to 10% of sync (nominally  $+4$  IRE).

**RS-170A Front Porch.** RS-170A Front Porch is measured from the 10% point on the trailing edge of setup ( $+4$  IRE nominally) to the 50% point on the leading edge of sync (nominally  $-20$  IRE).

**Sync to Burst Start.** The time from Sync to Burst Start is measured from the 50% point on the leading edge of horizontal sync (nominally  $-20$  IRE) to the leading zero crossing of the first half-cycle of burst that exceeds 50% of burst amplitude to the trailing zero crossing of the last half-cycle of burst that exceeds 50% of burst amplitude.

**RS-170A Burst Width.** RS-170A Burst Width is measured from the leading zero crossing of the first half-cycle of burst that exceeds 50% of burst amplitude to the trailing zero crossing of the last half-cycle of burst that exceeds 50% of burst amplitude. (RS-170A Notes 11, 12.) If burst is not locked to sync, then the envelope width is measured instead, and results are displayed in cycles along with the message, "Envelope Measured."

#### V Blank 4 IRE F1 and V Blank 4 IRE F2

#### (FCC Rules and Regulations Part 73.699)

Vertical blanking width is measured between the points on setup at a level equal to 10% of sync amplitude above blanking level (nominally  $+4$  IRE), where setup immediately precedes and follows the vertical blanking interval. Two measurements are made, one for field 1 blanking (F1) and the other for field 2 blanking (F2).

Four successive occurrences of all the lines in the frame that may contain the beginning or end of field blanking, plus one "extra" line, are acquired. The acquisitions are as follows:

- field 2, line 258 through and including field 2, line 263 (start of field 1 blanking)
- field 1, line 20 through and including field 1, line 25 (end of field 1 blanking)
- field 1, line 259 through and including field 1, line 264 (start of field 2 blanking)
- field 2, line 20 through and including field 2, line 25 (end of field 2 blanking)

Tilt on a blanked line could be erroneously identified as the beginning of video (end of blanking). If sync is present, each line has any tilt removed using the back porch of one line (line A for this example) and the front porch of the next

line (line B). The tilt is removed from Line A by pivoting line A around its back porch level to bring the front porch of Line B to the same level. The “extra” line is acquired in this measurement only so its front porch can be used for tilt correction.

The lines in the vertical blanking interval which never contain active video are not acquired and are always counted in the measurement result.

Only the active video area of the lines possibly containing the beginning or end of blanking is examined (from 10.4  $\mu$ s to 52.66  $\mu$ s after the start of sampling). The search level (amplitude considered to be blanking) is set as 10% of sync amplitude. If sync is not present, a default value is used.

On the line where blanking start or stop is found, the portion of the active video area of that line that is blanked is reported (in tenths of the possible active video area).

The measurement result is a summation of the following areas:

- the lines in the vertical blanking interval which never contain active video and are not acquired
- the lines acquired where a blanking transition is not found
- the portion (in tenths) of the active video area found to be blanked on lines containing a blanking transition

#### **V Blank 20 IRE F1 and V Blank 20 IRE F2**

**(RS-170A)**

The measurement method is identical to V Blank 4 IRE F1 and V Blank 4 IRE F2, except the vertical blanking width is measured between the points on setup at a level equal to 50% (versus 10%) of sync amplitude above blanking level, nominally +20 IRE (versus +4 IRE), where setup immediately precedes and follows the vertical blanking interval.

#### **FCC Equalizer and FCC Serration**

**(FCC Rules and Regulations Part 73.699)**

Timing measurements made within the vertical interval are Equalizing Pulse Width and Serration Width. The middle half of two different lines within field 2 of the vertical interval are acquired from 32 successive frames: field 2, line 2 (which contains an equalizing pulse) and field 2, line 5 (which contains a serration).

**FCC Equalizer.** FCC Equalizer is measured between the 10% points on the equalizing pulse (nominally  $-4$  IRE). The sample values acquired from the middle pulse of field 2, line 2 are used. The result is expressed as a % of sync width, which is determined from 32 occurrences of sync taken one frame, six lines apart (the same sampling pattern as the Horizontal Timing measurements).

**FCC Serration.** FCC Serration is measured between the 90% points of serration (nominally -36 IRE). The sample values acquired from the serration on field 2, line 5 are used. The result is expressed in microseconds.

**RS-170A Equalizer and  
RS-170A Serration**

**(RS-170A)**

The timing measurements made within the vertical interval are Equalizing Pulse Width and Serration Width. The middle half of two different lines within field 2 of the vertical interval are acquired from 32 successive frames: field 2, line 2 (which contains an equalizing pulse) and field 2, line 5 (which contains a serration).

**RS-170A Equalizer.** The RS-170A Equalizer measurement is done at the 50% points on the equalizing pulse (nominally -20 IRE). The sample values acquired from the middle pulse of field 2, line 2 are used. The result is expressed in microseconds.

**RS-170A Serration.** RS-170A Serration is measured between the 50% points of serration (nominally -20 IRE). The sample values acquired from the serration on field 2, line 5 are used. The result is expressed in microseconds.

**VIRS Measurements**

**(FCC 73.699)**

Four measurements are made on VIRS: VIRS Setup, VIRS Luminance Ref, VIRS Chroma Ampl, and VIRS Chroma Phase. VIRS Chroma Ampl is reported as % Burst and % Bar (when Bar is present on the composite VITS line), or in IRE. Samples are acquired from 32 consecutive occurrences of the VIRS, each separated by a frame.

**VIRS Setup.** Reference Black is measured from blanking level to setup level. Blanking level is the average of 16 consecutive sample values, centered around the sample located 2  $\mu$ s before the 50% point of the pedestal leading edge. Setup level is the average of 16 consecutive sample values, centered around the sample 42  $\mu$ s after the 50% point of the pedestal leading edge.

**VIRS Luminance Reference.** Luminance Reference is measured from blanking level to the VIRS luminance reference level. Blanking level is the same as in the Setup measurement description above. The VIRS luminance reference level is the average of 16 sample values, centered around the sample located 30  $\mu$ s after the 50% point on the pedestal leading edge.

**VIRS Chroma Ampl (Chrominance Amplitude).** VIRS Chroma Amplitude is measured as the peak-to-peak amplitude of the VIRS chrominance packet. Peak-to-peak amplitude is the peak-to-peak amplitude of the four subcarrier cycles which are centered around the sample 12  $\mu$ s after the 50% point on the pedestal leading edge. The measurement result is reported as % Burst and % Bar (when Bar is present on the composite VITS line), or in IRE.

**VIRS Chroma Phase (Chrominance Phase).** Chrominance phase is measured as the difference between the VIRS chrominance packet phase and color burst phase. VIRS chrominance packet is measured over four subcarrier cycles centered around the sample 12  $\mu$ s after the 50% point of the pedestal leading edge. Burst phase is measured over four subcarrier cycles centered around the sample at the center of burst (which is midway between the 50% points on the leading- and trailing edges of the sampled burst envelope).

### Line Time Distortion and Pulse-to-Bar Ratio

(NTC Report Number 7 and CCIR Recommendation Number 569)

Line time distortion and pulse-to-bar ratio are measurements of linear waveform distortion. Samples are acquired from 32 occurrences of the NTC-7 or FCC Composite VITS, one frame apart.

**Line Time Distortion.** Line time distortion is measured as the peak-to-peak amplitude change along the bar top, excluding the first microsecond and the last microsecond (*NTC-7, Section 3.4*). Noise is reduced and any chrominance component eliminated from the signal by averaging 32 lines of video.

The line time distortion measurement is made along the average luminance signal bar top. A set of arithmetic means is calculated across the bar top, excluding one microsecond following the bar leading edge 50% point and one microsecond before the bar trailing edge 50% point. Each mean value summarizes the values of 12 consecutive samples (0.84  $\mu$ s). The 12 samples used for each mean are overlapping, in that the last six samples of the first mean are also used as the first six samples of the second mean. For a typical bar top width, there will be 35 to 40 mean values calculated.

From the entire set of calculated means, the minimum and the maximum mean values are found. The peak-to-peak amplitude change along the bar top is the absolute difference between these two extreme mean values. Then,

$$\% \text{ Line time distortion} = \frac{\text{peak-peak amplitude difference}}{\text{bar amplitude}} \times 100$$

where bar amplitude is measured using the method previously explained.

**Pulse-to-Bar Ratio.** Pulse-to-bar ratio is measured as the peak amplitude of the 2T pulse, expressed as a % of the bar amplitude.

The peak amplitude of each of the 32 acquired 2T pulses is determined relative to blanking level. Blanking level is measured using the method previously explained. For FCC Composite VITS, the blanking level measurement is centered 2.1  $\mu\text{s}$  before the bar leading edge 50% point. For NTC-7 Composite VITS, the blanking level measurement is centered 10.9  $\mu\text{s}$  after the bar trailing edge 50% point.

Given the narrowness of the 2T pulse and the sampling frequency of the VM700 (four times subcarrier), only six to eight samples will be acquired from a 2T pulse. Also, in general, there will be no sample acquired exactly at the peak of the 2T pulse. An interpolation of the peak area is performed for each pulse, and the result is used as the peak pulse amplitude. The 32 peak amplitude results are summed and averaged. Then,

$$\text{Pulse-to-bar ratio} = \frac{\text{average 2T pulse peak amplitude}}{\text{bar amplitude}} \times 100$$

where bar amplitude is measured using the method previously explained.

## 2T Pulse K-factor and IEEE-511 ST Dist

### (1T Leading-edge Short-time Distortion)

Thirty-two occurrences of the NTC-7 Composite VITS are acquired, each one frame apart.

**2T Pulse K-factor.** Measured as the greatest weighted amplitude of a positive-going or negative-going ringing half-wave, which either precedes or follows the 2T pulse and is within one microsecond of the center of the pulse.

The weighting graticule used is the CMTT International 2T Pulse Ringing graticule. The central vertical axis of the graticule is placed on the center line of the 2T pulse and extends one microsecond on either side of the 2T pulse. The central horizontal axis of the graticule (which separates positive ringing from negative ringing) is placed along a blanking level calculated as the arithmetic mean of four consecutive sample values centered at each point 1 ms to the left and to the right of the 2T pulse center.

**IEEE-511 Short-Time Distortion.** Measured as a weighted function of time, the results are the weighted peak deviation from flatness within 1 microsecond of the center of a 1T bar transition (*ANSI/IEEE Std 511-1979, Section 4.4, Appendix B*). The measurements are made on the leading edge of the NTC-7 Composite VITS bar. Measurement results are reported in units of %SD.

## S/N Measurements

### (NTC Report Number 7 or CCIR Recommendation Number 567)

Five different signal-to-noise measurements are made by the VM700T using the CCIR Recommendations 567 Unified Filter Set: S/N NTC7 Unweighted, S/N NTC7 Lum-Weighted, S/N Unif Unweighted, S/N Unif Lum-Weighted, and S/N Periodic.

**Acquisition and Analysis.** The measurement routine acquires 32 full quiet lines from the vertical interval, the same line from each successive frame. The quiet line location is specified in the Measurement Locations file (the default location is field 1, line 12).

The data is analyzed for noise over all the data points in a 512 sample segment on each of the acquired lines. Each segment starts 20  $\mu$ s past the 50% point on the leading edge of line sync, which excludes sync from the analysis and uses only the data in the center of the quiet lines.

This provides 32 x 512, or 16,384 sample values for the noise analysis. This time-domain data is prepared and transformed by a Fast Fourier Transform (FFT) algorithm into the frequency domain. Values represented in the 1025 point frequency-domain array output by the FFT algorithm range from DC to 7.16 MHz.

Data “preparation” on the 16,384 samples prior to FFT transformation is performed differently on the S/N Periodic measurement than on the (random) S/N Unweighted and S/N Lum-Weighted measurements.

**S/N Unweighted and S/N Lum-Weighted (Random Noise) Data Preparation.** To significantly reduce periodic components from the S/N Unweighted and S/N Lum-Weighted measurements, the following processing technique is employed.

The 512 sample arrays from the first four lines acquired are summed, which results in a 512 sample array with chrominance removed. The samples from the second four lines (acquired lines 5 through 8) are summed, the result is inverted, and then subtracted from the first four-line sum. This removes the luminance component and yields a resultant 512 sample array with virtually no chrominance or luminance components.

This sequence is repeated for the remaining three sets of eight lines. These four resultant 512 sample arrays are then set end to end to form the 2048 sample array on which an FFT is performed.

**S/N Periodic Data Preparation.** To enhance the periodic noise components of the signal for the S/N Periodic measurement, the following processing technique is employed.

The 512 sample arrays from the first eight lines acquired are summed, which results in an intermediate 512 sample array with luminance component increased, but with the chrominance component removed.

The 512 sample arrays from the first eight lines acquired are summed again in the pattern “array#1 - array#2 + array#3 - array#4 ....” Because chrominance phase alternates 180° each frame, this increases the chrominance component to form a second intermediate 512 sample array.

The two intermediate arrays are summed to form a resultant 512 sample array with periodic noise components increased significantly more than the random noise component. This sequence is repeated for the remaining three sets of eight lines. The four resultant 512 sample arrays are then set end to end to form the 2048 sample array on which an FFT is performed.

**Frequency Domain Array Filtering – Unweighted SNR.** The frequency domain amplitude array for the Unweighted SNR measurement is multiplied by an unweighted noise filter, which is a software implementation of an industry-accepted hardware filter.

**Frequency Domain Array Filtering – Luminance Weighted SNR.** The frequency domain amplitude array for the Luminance Weighted SNR measurement is multiplied by a luminance weighted filter, which is also a software implementation of an industry-accepted hardware filter.

**Frequency Domain Array Filtering – Periodic SNR.** The frequency domain amplitude array for the Periodic SNR measurement is multiplied by an unweighted noise filter.

**Frequency Domain Array Filtering – Unified Filter Set.** The unweighted noise and luminance filters in this set comply with *CCIR Recommendation 567*.

The unweighted noise filter has a cutoff frequency of 5.0 MHz and is of the lumped-constant design. The filter is described in *CCIR Rec. 567*.

The Luminance Weighting filter has a much lower cutoff frequency than the Unweighted filter, and is derived directly from *CCIR Rec. 567*.

**Measurement Results.** Unweighted SNR and Periodic SNR are measured as the ratio, in dB, of bar amplitude to the unweighted rms amplitude of the noise on a quiet line. Luminance-Weighted SNR is measured as the ratio, in dB, of bar amplitude to the luminance-weighted rms amplitude of the noise on a quiet line. The results of the noise measurements are reported in dB, relative to bar amplitude, which is nominally 100 IRE. If the bar is not present on the composite VITS line, the results are scaled to 100 IRE, (100 IRE = 714 mV).

### Chroma-Lum Delay and Chroma-Lum Gain

(NTC-7)

Samples are acquired from 32 occurrences of the Composite VITS, one frame apart. The location of Composite VITS, either FCC or NTC-7, is specified in the appropriate Measurement Locations file.

**Chroma-Lum Delay.** Measured as the time difference between the luminance component and chrominance component of the modulated 12.5T pulse. (NTC-7, Section 3.7).



The VM700T measures the time delay as the difference between the locations of the centers of the modulated 12.5T pulse luminance and chrominance components. The measurement result is positive if the chrominance pulse center location follows (lags) the luminance pulse center location.

To locate the center of the 12.5T pulse luminance component, the 32 acquired lines are averaged to eliminate the chrominance component and to reduce noise. The average luminance pulse is corrected for baseline tilt and is (software) low-pass filtered to ensure the chrominance component is eliminated before the center of the luminance component is determined.

To locate the center of the 12.5T pulse chrominance component, the chrominance is summed over all 32 lines, band-pass filtered, and low-pass filtered (both software filters) to reduce noise and produce a chrominance envelope from which the center of the pulse chrominance component is determined.

Then, the chrominance/luminance delay inequality is computed as the difference between the chrominance envelope center location and the luminance pulse center location.

**Chroma-Lum Gain.** Measured as the peak-to-peak amplitude of the chrominance component of the modulated 12.5T pulse (*NTC-7, Section 3.6*).

The peak-to-peak chrominance amplitude is measured on one subcarrier cycle at the center of the modulated 12.5T pulse after the luminance component has been removed. Then,

$$C/L \text{ gain inequality} = \frac{\text{peak-peak chrominance amplitude}}{\text{luminance amplitude}} \times 100$$

**Differential Gain,  
Differential Phase,  
Luminance Nonlinearity,  
Relative Burst Gain, and  
Relative Burst Phase**

**(NTC Report Number 7)**

Video is routed through the hardware high-pass filter and then samples are acquired from 32 occurrences of the Composite VITS, one frame apart. The location of Composite VITS, either FCC or NTC-7, is specified in the appropriate Measurement Locations file.

The measurements are made at different locations on the linearity staircase part of the VITS. The measurement locations are determined by averaging eight of the 32 lines and locating the approximate centers of the six chrominance packets.

The actual measurements are made on 32 acquired lines, with each measurement window consisting of 16 consecutive samples (which represent four subcarrier cycles) centered in the chrominance packet.

**Differential Gain.** Differential Gain is measured as the difference between two peak-to-peak chrominance amplitudes: the amplitude of the modulated staircase chrominance packet with the largest such amplitude and the amplitude of the modulated staircase packet with the smallest such amplitude (*NTC-7, Section 3.13*). The measurement result is expressed as a % of the largest packet amplitude.

**Differential Phase.** Differential phase is measured as the largest difference in phase between any two staircase chrominance packets (*NTC-7, Section 3.14*).

(*NTC-7, Section 3.9*)

**Lum NonLinearity.** Video is routed through the hardware differential step filter, then samples are acquired from 32 occurrences of the Composite VITS one frame apart. The location of Composite VITS, either FCC or NTC-7, is specified in the appropriate Measurement Locations file.

Luminance nonlinearity is measured as the difference between the largest and smallest peaks. The peaks are created from the risers on the staircase by the differential step filter. The result is expressed as a % of the largest peak amplitude.

**Relative Burst Gain** Relative burst gain is measured as the difference between the peak-to-peak chrominance amplitude of burst and the peak-to-peak chrominance amplitude of the chrominance packet that precedes the first riser of the staircase. (*NTC-7, Section 5.2*.) The result is expressed as a % of the packet amplitude.

The burst amplitude on a line is the peak-to-peak amplitude averaged over four subcarrier cycles in the center of burst. Then,

$$\% \text{ Relative burst gain} = \frac{(\text{burst amplitude} - \text{packet amplitude})}{\text{packet amplitude}} \times 100$$

**Relative Burst Phase.** Relative burst phase is measured as the difference in phase between the color burst and the packet that precedes the first riser of the staircase (*NTC-7, Section 5.3*).

Burst phase is measured over four subcarrier cycles in the center of burst, and is simply the difference in the phase angle of burst and the packet that precedes the first riser of the staircase.

## Multiburst Measurements

Eight Multiburst measurement results are reported on either the FCC Multiburst or NTC-7 Combination test signals: multiburst flag amplitude (as % Carr and % Bar) and the peak-to-peak amplitude of each of the six multiburst packets.

Samples are acquired from 32 occurrences of either the FCC Multiburst VITS or the NTC-7 Combination VITS, one frame apart.

The location of the multiburst test signal, either FCC or NTC-7, is specified by the multiburst entry in the appropriate Measurement Locations file. Note that while the Auto mode display lists both groups of measurements (FCC and NTC-7), multiburst measurements can be made on only one of the two test signals at a time.

**Multiburst Flag.** The Multiburst flag measurements measure amplitude from back porch blanking level to the center point of the flag top (*NTC-7, Section 3-8*).

The back porch blanking level is the average of 16 consecutive sample values starting 1.5  $\mu$ s before the 50% point of the flag leading edge. The flag top level is the average of 16 consecutive sample values starting with the sample midway between the 50% points of the flag leading and trailing edge. Flag amplitude is the difference between flag top level and blanking level.

**Multiburst Packet.** The multiburst packet amplitudes are measured as the peak-to-peak amplitude of each of the multiburst packets (*NTC-7, Section 3-8*). The packet amplitudes are measured at fixed time offsets from the 50% point on the flag leading edge.

**NTC-7 20 IRE Chroma,  
NTC-7 80 IRE Chroma,  
NTC-7 Chr NL Phase,  
NTC-7 Chr-Lum Intmd**

These four measurements are, respectively: chrominance nonlinear gain distortion (20 IRE chroma and 80 IRE chroma with respect to the 40 IRE chroma), chrominance nonlinear phase distortion, and chrominance-luminance intermodulation.

Samples are acquired from 32 occurrences of the NTC-7 Combination VITS, one frame apart. These measurements can only be made on the NTC-7 Combination VITS.

The measurements are made on the 20 IRE, 40 IRE, and 80 IRE chrominance packets. The location of the NTC-7 Combination VITS signal is specified by the NTC-7 Combination entry in the appropriate Measurement Locations file.

**NTC-7 20 IRE Chroma, NTC-7 80 IRE Chroma.** Measured as the peak-to-peak amplitude of the first (nominally 20 IRE) and third (nominally 80 IRE) chrominance packets in the 3-level chrominance test signal, referenced to the peak-to-peak amplitude of the middle packet (nominally 40 IRE) (*NTC-7, Section 3-10*).

The peak-to-peak amplitudes of each of the three packets is determined over eight subcarrier cycles on 32 lines.

**NTC-7 Chr NL Phase.** Measured as the difference between the largest and the smallest phase values (measured relative to the phase of the 20 IRE packet) among the 3-level chrominance test signal subcarrier packets (*NTC-7, Section 3-11*).

The phase of each of the three packets is determined over eight subcarrier cycles on 32 lines.

**NTC-7 Chr Lum Intmd.** NTC-7 Chrominance-Luminance Intermodulation is measured as the maximum amplitude deviation of the 3-level chrominance test signal luminance pedestal from the part of the pedestal immediately preceding the 3-step chrominance packet (*NTC-7, Section 3-15*).

The luminance amplitudes of the filtered part of the pedestal is the average of 32 sample values centered around the sample at the center of each chrominance packet, after the chrominance component is removed. The luminance amplitude immediately preceding the 3-step chrominance packet is the average of 32 consecutive samples centered around the sample 1.5  $\mu$ s before the 50% point of the 20-IRE chrominance packet leading edge.

**ICPM** The Incidental Carrier Phase Modulation measurement is made on the staircase portion of either the FCC or NTC-7 Composite VITS signals. The Zero Carrier Pulse is required as an amplitude reference. This measurement requires that both the video output and the quadrature output of a demodulator be connected to the VM700T. Video may be connected to either channel A or B, but the quadrature output must always be connected to the channel C input. The Zero Carrier Pulse must be enabled at the demodulator, and must be selected for use as a reference in the appropriate Measurement Locations file. The location of both the Zero Carrier Pulse and the Composite VITS, either FCC or NTC-7, are also specified in the appropriate Measurement Locations file.

Traditionally, ICPM has been an out-of-service measurement, made on a full field luminance staircase signal with no aural carrier present. The Auto mode ICPM measurement is an in-service measurement. To allow the ICPM measurement to be made in service, it is performed on an inserted Composite VITS signal with the demodulator's sound notch (sound trap) in, which eliminates the 4.5 MHz aural carrier.

Both the video and quadrature signals are routed through the hardware low-pass filter. The lines containing the Zero Carrier Pulse and the Composite VITS are acquired from 64 consecutive frames, for both the video input and the quadrature input. The pattern with which the lines are acquired is as follows.

The Zero Carrier Pulse and Composite VITS lines of the video input are acquired from the first frame. Next, the Zero Carrier Pulse and Composite VITS lines of the quadrature input are acquired from the second frame. This pattern repeats for 64 frames, resulting in the acquisition of four arrays, each containing 32 lines of data. Each set of 32 lines is then averaged.

Amplitudes of the sync tip, blanking at back porch, and each of the staircase steps are then determined by averaging 16 samples at the center of each of these areas. Amplitudes for the video signal's sync tip, blanking, and staircase steps are measured using video Zero Carrier level as the zero volts reference.

Amplitudes for the quadrature signal's sync tip, blanking, and staircase steps are measured using quadrature Zero Carrier level as the zero volts reference.

The amount of ICPM (in degrees) for sync tip is the angle resulting from the vector sum of the quadrature sync tip amplitude and the video sync tip amplitude. Then,

$$ICPM = \arctan \frac{\text{quadrature amplitude}}{\text{video amplitude}}$$

ICPM for blanking and each of the staircase steps is determined using the same method. Because the quadrature amplitude may be either positive or negative, the resultant angle may be either positive or negative.

Once the ICPM is determined for each point, the back porch ICPM value is subtracted from the ICPM value for each point, referencing the measurement to blanking. The ICPM value with the largest absolute value is then reported, in degrees, by Auto mode.

### SCH Phase

Subcarrier to horizontal sync phase is measured as the phase at the middle of burst relative to the 50% point on the leading edge of sync.

Thirty-two full lines of active video are acquired, one line each from 32 successive frames. The first line acquired is field 1, line 50, and each successive acquisition occurs one frame plus 6 lines later. Sampling starts 160 samples earlier than normal (normal being 14 samples before the leading edge of sync).

To locate the 50% point on the leading edge of sync, noise is reduced and any chrominance component eliminated by averaging the 32 acquired lines. The 50% point is located midway between blanking and sync tip levels on the average luminance signal. Blanking level is the arithmetic mean of eight consecutive sample values (0.56  $\mu$ s), starting 3.6  $\mu$ s after the approximate 50% point on the trailing edge of sync. Sync tip level is the mean of 12 consecutive samples (0.84  $\mu$ s) centered around the sample located midway between the approximate 50% points on the leading and trailing edges of sync.

To locate the subcarrier zero-crossing closest to the center of burst, the luminance component is filtered from one cycle of subcarrier (four sample values) at the center of burst. These four sample values are averaged over all 32 acquired lines, and are used to calculate the location of an average zero-crossing. Note that the reported result will always be between  $\pm 90^\circ$ , and does not provide NTSC color field identification.

**Field Time Distortion**

Field Time Distortion is the only out-of-service measurement performed in Auto mode. Either the Field Square Wave or Window full field test signal is required.

Field Time Distortion is measured as the peak-to-peak deviation of the Field Square Wave or Window test signal pulse tops, excluding the first and last four lines of pulses, expressed as a per cent of the amplitude of the square wave located in the center of the field.

First, eight samples (at the approximate line center) of 128 lines per frame (every other line starting with field 1, line 25) are acquired over 32 frames. The 32 frames are summed and then the eight samples are averaged. This data is used to determine the start and stop lines of the square wave and the peak-to-peak deviation of the square-wave amplitudes. The center line containing a square wave is determined from the start and stop lines.

Next, the center line containing a square wave is acquired over 32 frames. The 32 lines are summed and software low-pass filtered. Then the four samples at back porch are averaged to determine the back porch location. The four samples at the approximate square wave center are then averaged to determine the center square wave amplitude relative to back porch. This value is used as the 100% square-wave amplitude reference. Then,

$$\text{Field Time Distortion} = \frac{\text{square-wave } p\text{-}p \text{ deviation}}{\text{center square-wave Amplitude}} \times 100$$

**FCC Color Bars****(FCC Rules and Regulations Part 73.682)**

Eighteen measurements are made on the FCC Color Bar VITS. All six color bars are measured for chrominance Amplitude Error, chrominance Phase Error, and Chr/Lum Ratio Error. Default limits for the FCC Color Bar measurement are contained in the End to End Auto limit file.

Thirty-two occurrences of the FCC Color Bar VITS are acquired, each one frame apart. Eight of these are used to determine the approximate locations of waveform features such as the center of burst, the center of the white bar, and the centers of the six color bars.

The approximate center locations of the color bars and the white bar are determined using one-sixth of the width of the color bar chrominance area as the width of each bar.

The white bar amplitude is measured as the difference between the arithmetic mean of sixteen consecutive sample values centered around the approximate center of the white bar and the arithmetic mean of sixteen consecutive sample values centered around the approximate center of the black step (7.5 IRE setup level).

**Color Bar Amplitude Error.** Each color bar amplitude error is measured as the deviation from nominal of the peak-to-peak chrominance amplitude of the color bar (expressed as a % of white bar amplitude). Each reported result is expressed as a % of the nominal value.

The peak-to-peak chrominance amplitude of each color bar is the average amplitude over the four cycles centered around the sample located at the approximate center of the color bar.

**Color Bar Phase Error.** Each color bar phase error is measured as the deviation from nominal of the sampled phase of the color bar (measured relative to burst phase). The reported result is expressed as degrees of deviation from the nominal phase. Burst phase and the phase of each color bar are measured over four cycles, centered around the approximate centers of burst and the color bar.

**Chr/Lum Ratio Error.** Each gain ratio error is measured as the deviation from nominal of the ratio of the peak-to-peak chrominance amplitude to the luminance level of each color bar relative to the black step. The reported result is expressed as a % of the nominal value.

The peak-to-peak chrominance amplitude of each color bar is determined as described in the color bar amplitude error measurement.

The luminance level of each color bar is the arithmetic mean of 16 consecutive sample values centered around the approximate center of the color bar luminance level relative to the black step.







# Appendices



# Appendix A: NTSC Measurement Specifications

This section lists the specifications for each NTSC measurement. The accuracies shown for measurements with averaging capabilities assume the default averaging factor of 32. Test signals of known parameters are provided by characterized and traceable television signal generators to test the accuracy of these derived measurements. Due to the statistical nature of digitizing measurement methods, reported results will meet these specifications 97% of the time. Range specifies the extremes between which a measurement can be made.

All measurement accuracies specified are valid only with nominal inputs signals with an unweighted signal-to-noise ratio of at least 60 dB on the incoming signal and a termination accuracy of  $\pm 0.025\%$ . Accuracies shown for measurements with "relative mode accuracy" assume that an averaging factor of 256 was used to create the reference.

The performance limits in this specification are valid with the following conditions:

- This instrument must have been calibrated/adjusted at an ambient temperature between  $+20^{\circ}\text{C}$  and  $+30^{\circ}\text{C}$ .
- The instrument must be in an environment with temperature, altitude, humidity, and vibration within the operating limits described in *Appendix A: Specification of the VM700T Video Measurement Set Option 01 (NTSC) and Option 11 (PAL) User Manual*.
- The instrument must have had a warm-up period of at least 20 minutes.
- The instrument must have had its signal-path-compensation routine last executed after at least a 20 minute warm-up period at an ambient temperature within  $\pm 5^{\circ}\text{C}$  of the current ambient temperature.

Any conditions that are unique to a particular characteristic are expressly stated as part of that characteristic.

## Measure Mode

Table A-1: Bar Line Time

Measurement	Range	Absolute Mode Accuracy	Relative Mode Accuracy
Bar Level	50 IRE to 200 IRE	$\pm 0.5\%$	$\pm 0.2\%$
Sync Level	20 IRE to 80 IRE	$\pm 0.5\%$	$\pm 0.2\%$
Sync to Bar Top	70 IRE to 280 IRE	$\pm 0.5\%$	$\pm 0.2\%$

Table A-1: Bar Line Time (Cont.)

Measurement	Range	Absolute Mode Accuracy	Relative Mode Accuracy
Sync/Bar Ratio	10% to 125% (100% nominal)	±0.5%	±0.2%
Bar Tilt (Rec 569)	0 to 20%	±0.2%	±0.1%
Line Time Distortion (Rec 567)	0 to 20%	±0.2%	±0.1%
Bar Width	10 $\mu$ s to 30 $\mu$ s	±100 ns	NA

Table A-2: Bounce

Measurement	Range	Accuracy
Peak Deviation	0 to 50%	±1%
Settling Time	0 to 10 sec	±100 msec

Table A-3: Burst Frequency

Measurement	Range	Relative Mode Accuracy
Burst Frequency Error	±100 Hz	±0.5 Hz

Table A-4: Chrominance-to-Luminance Gain and Delay

Measurement	Range	Absolute Mode Accuracy	Relative Mode Accuracy
Chrominance to Luminance Delay	±300 ns	±5 ns	±1.0 ns
Chrominance to Luminance Gain Ratio	0 to 160%	±1.0%	±0.1%

Table A-5: Chrominance Frequency Response

Measurement	Range	Absolute Mode Accuracy	Relative Mode Accuracy
Reference Amplitude	0 to 100 IRE	±1%	±0.5%
Frequency Response	0 to 100 IRE	±1%	±0.5%

Table A-6: Chrominance Noise

Measurement	Range	Absolute Mode Accuracy
AM Noise	-20 dB to -80 dB	±1 dB (-20 dB to -60 dB)
PM Noise	-20 dB to -70 dB	±1 dB (-20 dB to -60 dB)

**Table A-7: Chrominance Non-Linearity**

Measurement	Range	Absolute Mode Accuracy	Relative Mode Accuracy
Chrominance Amplitude	0 to 100%	1.0%	0.5%
Chrominance Phase	0 to 360°	1°	0.2°
Chrominance to Luminance Intermodulation	-50% to +50%	0.2%	0.2%

**Table A-8: ColorBar**

Measurement	Range	Absolute Mode Accuracy	Relative Mode Accuracy
Luminance Level	0 to 100 IRE (0 to 714.3 mV)	±0.5 IRE	±0.2%
Chrominance Level (excluding gray and black)	0 to 100 IRE (0 to 714.3 mV)	±1.0% of nominal (see Table A-9)	±0.2%
Chrominance Phase	±180° of nominal	±0.5° of nominal	±0.1°

**Table A-9: SMPTE Color Bar Nominal Values**

Color	LUM (mV)	Chroma P-P (mV)	Phase (degrees)
Yellow	494.6	444.2	167.1
Cyan	400.4	630.1	283.4
Green	345.9	588.5	240.8
Magenta	256.7	588.5	60.8
Red	202.2	630.1	103.4
Blue	108.1	444.2	347.1

**Table A-10: Differential Gain and Phase**

Measurement	Range	Absolute Mode Accuracy	Relative Mode Accuracy
Differential Gain	0 to 100%	±0.3%	±0.03%
Differential Phase	0 to 360°	±0.3°	±0.03°

**Table A-11: Frequency Response and Group Delay**

Measurement	Range	Absolute Mode Accuracy	Relative Mode Accuracy
Frequency Response	±40 dB	±1.0 dB	±0.3 dB
Group Delay	±1.0 μs	±20 ns	±5 ns

**Table A-12: Horizontal Blanking**

Measurement	Range	Absolute Mode Accuracy
Blanking Start	0.1 $\mu$ s to 4.2 $\mu$ s	$\pm$ 50 ns
Blanking End	6.8 $\mu$ s to 12.2 $\mu$ s	$\pm$ 50 ns
Blanking Width	6.9 $\mu$ s to 16.4 $\mu$ s	$\pm$ 50 ns

**Table A-13: Horizontal Timing**

Measurement	Range	Absolute Mode Accuracy
Burst Level	10 to 80 IRE	$\pm$ 0.5%
Horizontal Sync Rise and Fall Time	80 ns to 1 $\mu$ s	$\pm$ 10 ns
Horizontal Sync Width	3 $\mu$ s to 7 $\mu$ s	$\pm$ 10 ns
Burst Width	6 cycles to 13 cycles	$\pm$ 0.1 cycle (FCC) $\pm$ 0.5 cycle (RS-170A)
Sync to Burst Start (RS-170A)	4 $\mu$ s to 10 $\mu$ s	$\pm$ 150 ns
Sync to Burst End (FCC)	4 $\mu$ s to 10 $\mu$ s	$\pm$ 25 ns
Front Porch	0.1 $\mu$ s to 3.5 $\mu$ s	$\pm$ 10 ns (FCC) $\pm$ 10 ns (RS-170A)
Sync to Setup	8.8 $\mu$ s to 13.0 $\mu$ s	$\pm$ 10 ns
Breezeway (FCC)	0.1 $\mu$ s to 5 $\mu$ s	$\pm$ 25 ns
Sync Level	20 IRE to 80 IRE	$\pm$ 0.5%

**Table A-14: Incidental Carrier Phase Modulation**

Measurement	Range	Absolute Mode Accuracy
ICPM (requires zero Carrier Pulse and the quadrature output of the demodulator on Channel C)	0 to 90°	$\pm$ 1.0°

**Table A-15: Jitter**

Measurement	Range	Absolute Mode Accuracy
Jitter (2 Field)	$\pm$ 20 $\mu$ s	$\pm$ 10 ns
Jitter Long Time	$\pm$ 20 $\mu$ s	$\pm$ 10 ns

**Table A-16: K-Factor**

Measurement	Range	Absolute Mode Accuracy
2T Pulse K-Factor	0 to 10% Kf	±0.3%
K <sub>PB</sub>	-10% to +5% K <sub>PB</sub>	±0.3%
Pulse to Bar Ratio	10% to 125%	±0.7%
Pulse Half Amplitude Duration (HAD)	100 ns to 500 ns	±5 ns

**Table A-17: Level Meter**

Measurement	Range	Absolute Mode Accuracy
Level Meter	0 to 1.4 V	±3.5 mV

**Table A-18: Line Frequency**

Measurement	Range	Absolute Mode Accuracy
Line Frequency	±3%	±0.1%
Field Frequency	±3%	±0.1%

**Table A-19: Luminance Non-Linearity**

Measurement	Range	Absolute Mode Accuracy	Relative Mode Accuracy
Luminance Non-Linearity	0 to 100%	±0.4%	±0.2%

**Table A-20: Multiburst**

Measurement	Range	Absolute Mode Accuracy	Relative Mode Accuracy
Reference Flag or Packet Amplitude	30 IRE to 130 IRE	±1%	NA
Other Packets (0.5, 1.25, 2.0, 3.0, 3.58, 4.1 MHz)	-40 dB to +6 dB	±0.1 dB	±0.03 dB

**Table A-21: Noise Spectrum**

Measurement	Range	Absolute Mode Accuracy
Unweighted Signal-to-Noise Ratio (5 MHz Low Pass)	-20 dB to -80 dB	±0.4 dB (-20 dB to -60 dB) ±1.0 dB (-6 dB to -70 dB)
Weighted Signal-to-Noise Ratio (5 MHz Low Pass and Unified Weighting)	-20 dB to -80 dB	±1.0 dB (-20 dB to -60 dB) ±2.0 dB (-60 dB to -70 dB)

**Table A-22: SCH Phase**

Measurement	Range	Absolute Mode Accuracy
SCH Phase	$\pm 90^\circ$	$\pm 5^\circ$
Sync Relative Timing	$\pm 1 \mu s$	$\pm 10 ns$
Burst Relative Phase	$180^\circ$	$\pm 5^\circ$

**Table A-23: Short Time Distortion**

Measurement	Range	Absolute Mode Accuracy
Short-Time Distortion	0 to 25% SD	$\pm 5\%$ SD

**Table A-24: TwoField**

Measurement	Range	Absolute Mode Accuracy
Field Time Distortion	0 to 40%	$\pm 0.5\%$

**Table A-25: VITS ID**

Measurement	Performance Requirement	Supplemental Information
VITS Recognition		Recognizes and displays the name of recognized signals in the vertical interval of both Field 1 and Field 2, lines 15 through 20. VITS test signals recognized are:  GCR 8 Fields Seq. VIRS FCC Multi Burst Pedestal Luminance Bar NTC-7 Combination Sin X/X

**Table A-26: Vertical Blanking**

Measurement	Range	Absolute Mode Accuracy
Equalizing Pulse Width	80 ns to 1 $\mu s$	$\pm 10 ns$
Serration Pulse Width	80 ns to 1 $\mu s$	$\pm 10 ns$



## Auto Mode

**Table A-27: RS-170A Horizontal Blanking Interval Timing**

Measurement	Range	Accuracy	Test Signal
Color Burst Width	6 cycles to 13 cycles	±0.1 cycles	Horizontal Blanking
Front Porch Duration	0.5 μs to 2 μs	±20 ns	Horizontal Blanking
Horizontal Blanking Width	6 μs to 30 μs	±50 ns	Horizontal Blanking
Horizontal Sync Rise and Fall Time	80 ns to 120 ns 120 ns to 300 ns 300 ns to 1.0 μs	-10 to +30 ns ±20 ns ±30 ns	Horizontal Blanking
Horizontal Sync Width	1 μs to 8 μs	±10 ns	Horizontal Blanking
SCH Phase	±90°	±5°	Horizontal Blanking
Sync to Setup	5 μs to 18 μs	±20 ns	Horizontal Blanking
Sync to Start of Burst	4 μs to 8 μs	±140 ns (0.5 cycles) ±20 ns	Horizontal Blanking

**Table A-28: RS-170A Vertical Blanking Interval**

Measurement	Range	Accuracy	Test Signal
Equalizing Pulse Width	1 μs to 20 μs	±10 ns	Vertical Blanking
Serration Width	1 μs to 20 μs	±10 ns	Vertical Blanking
Vertical Blanking Width	19 lines to 29 lines	-0.1 to +0.2 lines	Vertical Blanking

**Table A-29: FCC Horizontal Blanking Interval Timing**

Measurement	Range	Accuracy	Test Signal
Breezeway Width	0.2 μs to 3.5 μs	±25 ns	Horizontal Blanking
Color Burst Width	6 cycles to 13 cycles	±0.1 cycles	Horizontal Blanking
Front Porch Duration	0.5 μs to 2 μs	±10 ns	Horizontal Blanking
Horizontal Blanking Width	6 μs to 30 μs	±10 ns	Horizontal Blanking
Horizontal Sync Rise and Fall Time	80 ns to 120 ns 120 ns to 300 ns 300 ns to 1.0 μs	-10 ns to +30 ns ±20 ns ±30 ns	Horizontal Blanking
Horizontal Sync Width	1 μs to 8 μs	±10 ns	Horizontal Blanking
Sync to Setup	5 μs to 18 μs	±20 ns	Horizontal Blanking
Sync to End of Burst	6 μs to 15 μs	±20 ns	Horizontal Blanking

**Table A-30: FCC Vertical Blanking Interval Timing**

Measurement	Range	Accuracy	Test Signal
Equalizing Pulse Width	25% to 100% of nominal horizontal sync pulse width	±0.3%	Vertical Blanking
Serration Width	1 $\mu$ s to 20 $\mu$ s	±10 ns	Vertical Blanking
Vertical Blanking Width	19 lines to 29 lines	-0.1 lines to +0.2 lines	Vertical Blanking

**Table A-31: Amplitude and Phase Measurements**

Measurement	Range	Accuracy	Test Signal
Average Picture Level (APL)	0 to 200%	±3.0%	Full Field
Bar Top	0 to 90% of Maximum Carrier	±0.1%	FCC/NTC-7 Composite
Bar Amplitude	0 to 200 IRE	±0.3 IRE	FCC/NTC-7 Composite
Chrominance to Luminance Delay (Relative Chroma Time)	±300 ns	±5 ns	FCC/NTC-7 Composite
Chrominance to Luminance Gain (Relative Chroma Level)	0 to 160%	±1%	FCC/NTC-7 Composite
Differential Gain	0 to 100%	±0.3%	FCC/NTC-7 Composite
Differential Phase	0 to 360°	±0.3°	FCC/NTC-7 Composite
Luminance Non-linear Distortion	0 to 50%	±0.4%	FCC/NTC-7 Composite
Relative Burst Gain	±100%	±0.3%	FCC/NTC-7 Composite
Relative Burst Phase	±180°	±0.3°	FCC/NTC-7 Composite
Burst Amplitude (% of sync)	25% to 200% of sync	±1.0%	Horizontal Blanking
Burst Amplitude (% of Bar)	10% to 80% of Bar (10 IRE to 80 IRE when Bar is not used)	±0.4% (±0.4 IRE)	Horizontal Blanking
Sync Amplitude (% of Bar)	20% to 80% of Bar (20 IRE to 80 IRE when Bar is not used)	±0.3% (±0.3 IRE)	Horizontal Blanking
Blanking Level	0 to 90% of Maximum Carrier	±0.2%	Horizontal Blanking
Sync Variation	0 to 50% of Maximum Carrier (0 to 50% of Bar when Zero Carrier is not used and 0 to 50 IRE when Zero Carrier and Bar are not used)	±0.3% for Zero Carrier (±0.3% for Bar and ±0.3 IRE for no Zero Carrier and no Bar)	Horizontal Blanking
Blanking Variation	0 to 50% of Maximum Carrier (0 to 50% of Bar when Zero Carrier is not used and 0 to 50 IRE when Zero Carrier and Bar are not used)	±0.3% for Zero Carrier (±0.3% for Bar and ±0.3 IRE for no Zero Carrier and no Bar)	Horizontal Blanking

**Table A-32: Frequency Response Measurements**

Measurement	Range	Accuracy	Test Signal
Multiburst Flag Amplitude	0 to 90% of Maximum Carrier (20 to 130% of Bar when Zero Carrier is not used and 20 to 130 IRE when Zero Carrier and Bar are not used)	$\pm 0.5\%$ for Zero Carrier ( $\pm 0.5\%$ for Bar and $\pm 0.5$ IRE for no Zero Carrier and no Bar)	FCC Multiburst or NTC-7 Combination
Multiburst Packet Amplitudes	0 to 100% of Flag	$\pm 1\%$ of Flag	FCC Multiburst or NTC-7 Combination

**Table A-33: Incidental Carrier Phase Modulation**

Measurement	Range	Accuracy	Test Signal
ICPM (requires Zero Carrier Pulse and the quadrature output of the demodulator on channel C)	0 to 30°	$\pm 1.0^\circ$	FCC or NTC-7 Composite

**Table A-34: Color Bar Measurements**

Measurement	Range	Accuracy	Test Signal
Color Bar Amplitude Errors	$\pm 100\%$ of nominal	$\pm 1.0\%$	FCC Color Bars
Color Bar Phase Errors	$\pm 180^\circ$ from nominal	$\pm 0.5^\circ$	FCC Color Bars
Color Bar Chrominance to Luminance Gain Ratio	0 to 200% of nominal	$\pm 2\%$	FCC Color Bars

**Table A-35: Out-of-Service Measurements**

Measurement	Range	Accuracy	Test Signal
Field Time Distortion	0 to 40%	$\pm 0.5\%$	Field Square Wave

**Table A-36: Waveform Distortion Measurements**

Measurement	Range	Accuracy	Test Signal
Line Time Distortion	0 to 40% of Bar	$\pm 0.2\%$	FCC or NTC-7 Composite
Pulse to Bar Ratio	10% to 125%	$\pm 0.7\%$	FCC or NTC-7 Composite
Short Time Waveform Distortion (IEEE 511)	0 to 25% SD	$\pm 0.5\%$ SD	NTC-7 Composite
Chrominance Nonlinear Gain Distortion	5 IRE to 35 IRE (20 IRE chroma) 45 IRE to 160 IRE (80 IRE chroma)	$\pm 0.4$ IRE	NTC-7 Combination

**Table A-36: Waveform Distortion Measurements (Cont.)**

Measurement	Range	Accuracy	Test Signal
Chrominance Nonlinear Phase Distortion	0 to 360°	±1.0°	NTC-7 Combination
Chrominance to Luminance Intermodulation	±50 IRE	±0.2 IRE	NTC-7 Combination
2T K-Factor	0 to 10% Kf	±0.3% Kf	FCC or NTC-7 Composite

**Table A-37: VIRS Measurements**

Measurement	Range	Accuracy	Test Signal
VIRS Setup (Reference Black)	-20% to +130% of Bar (-20 IRE to +130 IRE when Bar is not used)	±0.2% (±0.5 IRE when Bar is not used)	VIRS
VIRS Chrominance Reference Amplitude	0 to 200% of burst amplitude (0 to 80% of Bar when burst is not used and 0 IRE to 80 IRE when burst and bar are not used)	±1% (±0.1% when burst is not used and ±1 IRE when burst and bar are not used)	VIRS
VIRS Chrominance Phase Relative to Burst	±180°	±0.5°	VIRS
VIRS Luminance Reference	30% to 100% of Bar (30 IRE to 100 IRE when bar is not used)	±0.2% (±0.2 IRE)	VIRS

**Table A-38: Signal-to-Noise Ratio Measurements**

Measurement	Range	Accuracy	Test Signal
Unified Unweighted SNR	26 dB to 60 dB 61 dB to 70 dB	±1.0 dB ±2.0 dB	Quiet Line
Unified Luminance Weighted SNR	26 dB to 60 dB 61 dB to 70 dB	±1.0 dB ±2.0 dB	Quiet Line
NTC 7 Unweighted SNR	26 dB to 60 dB 61 dB to 70 dB	±1.0 dB ±2.0 dB	Quiet Line
NTC 7 Luminance Weighted SNR	26 dB to 60 dB 61 dB to 70 dB	±1.0 dB ±2.0 dB	Quiet Line
Periodic SNR	26 dB to 60 dB 61 dB to 70 dB	±1.0 dB ±2.0 dB	Quiet Line



# Index



# Index

## Numbers

1st Step softkey, 2-50  
2T Pulse K-factor, 3-10

## A

### Acquire

Clamp Couple, 2-128  
Special Position, 2-122, 2-128  
Sync, 2-128

### Acquire soft key, 2-6

Acquire softkey, 2-21, 2-26, 2-37, 2-42, 2-48, 2-54,  
2-76, 2-86, 2-98, 2-103, 2-109, 2-128

### Acquire Submenu

Block Lines, 2-7, 2-23, 2-33, 2-39, 2-44, 2-49,  
2-79, 2-92, 2-99, 2-105, 2-110, 2-123  
Block Mode, 2-6, 2-23, 2-33, 2-39, 2-44, 2-79,  
2-92, 2-99, 2-104, 2-110, 2-122  
Block Step, 2-7, 2-23, 2-33, 2-39, 2-44, 2-49,  
2-79, 2-92, 2-99, 2-105, 2-110, 2-123  
Field Toggle, 2-43  
Input Gate, 2-110  
Special Position, 2-6, 2-22, 2-33, 2-38, 2-43, 2-49,  
2-56, 2-79, 2-99, 2-104

### Area Pos softkey, 2-111

### Area softkey, 2-57

### Area Widthsoftkey, 2-111

### Auto Scan softkey, 2-44, 2-50, 2-100

### Average Num soft key, 2-4

Average Num softkey, 2-17, 2-21, 2-25, 2-31, 2-37,  
2-41, 2-47, 2-54, 2-62, 2-66, 2-70, 2-73, 2-76,  
2-84, 2-95, 2-97, 2-103, 2-116, 2-120, 2-127,  
2-135

### Average Picture Level (APL), 3-2

## B

### Back Porch softkey, 2-128, 2-130

### Bar Amplitude, 3-3

### Bar Left softkey, 2-124

### Bar LineTime

#### Acquire submenu

Block Lines, 2-7  
Block Mode, 2-6  
Block Step, 2-7  
Special Position, 2-6

### Main menu

Acquire, 2-6  
Average Num, 2-4  
ITS Search, 2-6  
Reference, 2-5  
Relative to Reference, 2-5  
Rescale, 2-6

### Reference submenu

Show (1) Reference/Show (2) Reference, 2-6  
Store (1) Reference/Store (2) Reference, 2-6  
Relative to Reference submenu, Use (1) Refer-  
ence/Use (2) Reference, 2-6

### Special Position submenu

Exit, 2-8  
Ref. (b1), 2-7  
Set Default, 2-7

### Bar Right softkey, 2-124

### Bar Top, 3-3

### Black softkey, 2-44

### Blanking Display softkey, 2-136

### Blanking level, 3-3

### Blanking variation, 3-4

Block Lines softkey, 2-7, 2-23, 2-33, 2-39, 2-44,  
2-49, 2-79, 2-92, 2-99, 2-105, 2-110, 2-123

Block Mode softkey, 2-6, 2-23, 2-33, 2-39, 2-44,  
2-79, 2-92, 2-99, 2-104, 2-110, 2-122

Block Step softkey, 2-7, 2-23, 2-33, 2-39, 2-44, 2-49,  
2-79, 2-92, 2-99, 2-105, 2-110, 2-123

### Blue softkey, 2-44

### Bounce

back porch level, 2-9

Blank level, 2-9

measurement results, 2-15

menu, 2-11

numerical readouts, 2-9

settling time, 2-9

### Breezeway Width, 3-5

### Burst Amplitude, 3-4

### Burst Frequency

#### Main menu

Average Num, 2-17  
Reference, 2-17  
Rescale, 2-17

#### Reference submenu

Reference Ch. B, 2-17  
Reference Ch. C, 2-18  
Reference Internal, 2-17  
Zero Set, 2-18

**C**

- CCIR-2T Graticule, 2-77
- Center Default softkey, 2-34, 2-106
- Change Display softkey, 2-120, 2-122
- Chr/Lum ratio error, 3-19
- Chroma-Luminance Delay, 3-12
- Chroma-Luminance Gain, 3-13
- Chrominance AMPM, Main menu, Average Num, 2-25
- Chrominance FreqResp, Main menu
  - Average Num, 2-31
  - Rescale, 2-31
- Chrominance FreqResp menu, Special Position submenu
  - Center Default, 2-34
  - Exit, 2-34
  - Flag Start, 2-34
  - Flag Width, 2-34
  - Packet, 2-34
  - Set Default, 2-33
  - Width Default, 2-34
- chrominance nonlinear gain distortion, 3-15
- chrominance nonlinear phase distortion, 3-15
- Chrominance NonLinearity
  - Acquire submenu
    - Block Lines, 2-39
    - Block Mode, 2-39
    - Block Step, 2-39
    - Special Position, 2-38
  - Main menu
    - Acquire, 2-37
    - Average Num, 2-37
    - ITS Search, 2-37
    - Reference, 2-37
    - Relative to Reference, 2-37
    - Rescale, 2-37
  - Reference submenu
    - Show (1) Reference/Show (2) Reference, 2-37
    - Store (1) Reference/Store (2) Reference, 2-37
  - Relative to Reference submenu, Use (1) Reference/Use (2) Reference, 2-38
  - Special Position submenu
    - Exit, 2-39
    - Packet 1/2/3, 2-39
    - Ref Pos, 2-39
    - Set Default, 2-39
- chrominance-luminance intermodulation, 3-16
- ChromLum GainDelay
  - Acquire submenu
    - Block Lines, 2-23, 2-33
    - Block Mode, 2-23, 2-33
    - Block Step, 2-23, 2-33
    - Special Position, 2-22, 2-33
  - Main menu
    - Acquire, 2-21, 2-26
    - Average Num, 2-21
    - ITS Search, 2-21
    - Relative to Reference, 2-21, 2-26, 2-31
    - Rescale, 2-21, 2-26, 2-28
  - Reference submenu
    - Show (1) Reference/Show (2) Reference, 2-21
    - Store (1) Reference/Store (2) Reference, 2-21, 2-28
  - Relative to Reference submenu, Use (1) Reference/Use (2) Reference, 2-22
  - Special Position submenu
    - Exit, 2-23
    - Pulse Pos, 2-23
    - Set Default, 2-23
- Clamp Couple
  - Clamp Fast, 2-130
  - Clamp Slow, 2-130
  - DC Coupling, 2-130
- Clamp Couple softkey, 2-66, 2-128
- Clamp Couple Submenu
  - Clamp Fast, 2-67
  - Clamp Slow, 2-67
  - DC Coupling, 2-67
- Clamp Fast softkey, 2-67, 2-130
- Clamp Slow softkey, 2-67, 2-130
- Color Bar
  - Acquire submenu
    - Block Lines, 2-44
    - Block Mode, 2-44
    - Block Step, 2-44
    - Field Toggle, 2-43
    - Special Position, 2-43
  - Main menu
    - Acquire, 2-42
    - Average Num, 2-41
    - ITS Search, 2-42
    - Reference, 2-41
    - Relative to Reference, 2-42
    - Rescale, 2-42
  - Reference submenu
    - Show (1) Reference/Show (2) Reference, 2-43
    - Store (1) Reference/Store (2) Reference, 2-43
  - Relative to Reference submenu
    - Ref. 100/0/75/0 I Ref. 100/0/100/0 I Ref. 100/0/100/25, 2-43
    - Ref. 100/7.5/75/7.5 I Ref. 100/7.5/75/7.5 I Ref. 100/7.5/75/7.5, 2-43
    - Ref. 75/7.5/75/7.5 I Ref. 75/7.5/75/7.5 I Ref. 75/7.5/75/7.5, 2-43
    - Use (1) Reference/Use (2) Reference, 2-43



- Special Position submenu
  - Auto Scan, 2-44
  - Black, 2-44
  - Blue, 2-44
  - Exit, 2-44
  - White, 2-44
  - Yellow, 2-44
- Color bar
  - amplitude error, 3-19
  - phase error, 3-19
- Cursor, 2-67
- Cursor 1/2 Active, 2-130
- Cursor 1/2 Active softkey, 2-110, 2-130
- Cursor 1/2 On softkey, 2-110
- Cursor On, 2-130
- Cursor On softkey, 2-58, 2-60, 2-130
- Cursor Relative, 2-130
- Cursor Relative softkey, 2-130
- Cursor softkey, 2-54
- Cursor Track, 2-130
- Cursor Track softkey, 2-130
- Cursors softkey, 2-73, 2-109, 2-128
- Cursors Submenu, Cursor Active, 2-58

## D

- dB Reference softkey, 2-103
- dB Reference Submenu
  - Flag (Auto), 2-104
  - Ref Packet/Flag, 2-104
- DC Coupling softkey, 2-67, 2-130
- DelayGrat Inverse, 2-55
- DGDP
  - Acquire submenu
    - Block Lines, 2-49
    - Block Step, 2-49
    - Special Position, 2-49
  - Main menu
    - Acquire, 2-48
    - Average Num, 2-47
    - ITS Search, 2-48
    - Reference, 2-48
    - Relative to Reference, 2-48
    - Rescale, 2-48
  - Reference submenu
    - Show (1) Reference/Show (2) Reference, 2-48
    - Store (1) Reference/Store (2) Reference, 2-48
  - Relative to Reference submenu, Use (1) Reference/Use (2) Reference, 2-48
  - Special Position submenu
    - 1st Step, 2-50
    - Auto Scan, 2-50

- Exit, 2-50
- Last Step, 2-50
- Manual Steps, 2-50
- Measure Cycles, 2-50
- Ref Packet, 2-50
- Differential Gain, 3-14
- Differential Phase, 3-14
- Display
  - Back Porch, 2-128, 2-130
  - Meas. Luma, 2-128
  - Meas.Chro P-P, 2-128
  - Peak Luma, 2-128, 2-129
  - Sync Tip, 2-128, 2-130
- Display Limits softkey, 2-84
- Display softkey, 2-127
- Double Pulse Mode softkey, 2-56, 2-80
- Dual SCH Display softkey, 2-116
- Dual SCH Phase display, 2-114

## E

- Equalizer Pulse softkey, 2-135
- Exit softkey, 2-8, 2-23, 2-34, 2-39, 2-44, 2-50, 2-57, 2-58, 2-80, 2-100, 2-106, 2-111, 2-124, 2-129
- External Sync softkey, 2-129

## F

- FCC
  - Equalizer, 3-7
  - Serration, 3-8
- FCC Burst Width, 3-5
- FCC Color Bar, 3-18
- FCC Front Porch, 3-5
- FCC H Blanking, 3-4
- FCC softkey, 2-62
- FCC Sync Setup, 3-5
- FCC Sync Width, 3-5
- Field Time Distortion, 3-18
- Field Toggle softkey, 2-43, 2-60
- Filters Selection softkey, 2-109
- Flag (Auto) softkey, 2-104
- Flag Start Default softkey, 2-105
- Flag Start softkey, 2-34
- Flag Width Default softkey, 2-105
- Flag Width softkey, 2-34
- Freq. Lock softkey, 2-73
- FS-170A, Sync Setup, 3-6
- Fsc. Trap Filter softkey, 2-112
- Full Field softkey, 2-116
- Full Field Submenu, Rescale, 2-117

Full VITS Waveform softkey, 2-132

## G

Grat Incr, 2-67

Grat Max, 2-67

Graticule

Graticule Gain, 2-122

Graticule Reset, 2-122

Graticule Track, 2-122

IEEE-511 Graticule, 2-121

Inner Graticule, 2-122

Make Graticule, 2-122

Outer Graticule, 2-122

Set to 0.0, 2-122

Set to 1.0, 2-122

Special Graticule, 2-121

Graticule Change Submenu

CCIR-2T Graticule, 2-77

Make Graticule, 2-77

Graticule Gain, 2-77

Graticule Gain softkey, 2-122

Graticule Labels, 2-67

Graticule Off, 2-55

Graticule Reference menu, K\_Factor, 2-75

Graticule Reference softkey, 2-76

Graticule Reset, 2-78

Graticule Reset softkey, 2-122

Graticule softkey, 2-54, 2-66, 2-76

Graticule Submenu

Cursor, 2-67

DelayGrat Inverse, 2-55

Grat Incr, 2-67

Grat Max, 2-67

Graticule Gain, 2-77

Graticule Labels, 2-67

Graticule Off, 2-55

Graticule Reset, 2-78

Graticule Track, 2-77

Limit File, 2-55

Plot All, 2-68

Polar Graticule, 2-67

Rescale, 2-78

System I, 2-55

Tracking Lines, 2-68

Graticule Track, 2-77

Graticule Track softkey, 2-122

GroupDelay SinX\_X

Acquire submenu, Special Position, 2-56

Cursor submenu

Cursor Active, 2-58

Cursor On, 2-58

Graticule submenu

DelayGrat Inverse, 2-55

Graticule Off, 2-55

Limit File, 2-55

System I, 2-55

Main menu

Acquire, 2-54

Average Num, 2-54

Cursor, 2-54

Graticule, 2-54

Reference, 2-54

Relative to Reference, 2-54

Rescale, 2-54

Reference submenu

Ref Freq., 2-55

Show (1) Reference/Show (2) Reference, 2-55

Store (1) Reference/Store (2) Reference, 2-55

Relative to Reference submenu, Use (1) Reference/Use (2) Reference, 2-55

Special Position submenu

Area, 2-57

Double Pulse Mode, 2-56

Exit, 2-57

Pul 2 Offs, 2-57

Pul 2 Offs Auto Adj, 2-57

Pulse 1 Pos, 2-57

Set Default, 2-56

## H

H\_Blank, Main menu

Cursor On, 2-60

Field Toggle, 2-60

Max Hold, 2-60

Meas. Line End, 2-60

Meas. Line Start, 2-60

Rescale, 2-60

Set FCC, 2-60

Set RS-170-A, 2-60

Threshold, 2-60

H\_Timing, Main menu

Average Num, 2-62

FCC, 2-62

Rescale, 2-62

RS-170A, 2-62

High Pass 100 kHz softkey, 2-112

**I****ICPM**

- Clamp Couple submenu
  - Clamp Fast, 2-67
  - Clamp Slow, 2-67
  - DC Coupling, 2-67

## Graticule submenu

- Cursor, 2-67
- Grat Incr, 2-67
- Grat Max, 2-67
- Graticule Labels, 2-67
- Plot All, 2-68
- Polar Graticule, 2-67
- Tracking Lines, 2-68

## Main menu

- Average Num, 2-66
- Clamp Couple, 2-66
- Graticule, 2-66
- Measure, 2-66
- Plot All, 2-67
- Relative Backporch, 2-66
- Rescale, 2-67

## Measure submenu

- Max % Car, 2-68
- Min % Car, 2-68
- Selected % Car, 2-68
- Threshold, 2-68
- Transient Chk Quad, 2-68

ICPM errors, 2-63

IEEE-511 Graticule softkey, 2-121

IEEE-511 Short-Time Distortion, 3-10

Incidental Carrier Phase Modulation (ICPM), 3-16

Incidental Carrier Phase Modulation (ICPM), 3-, 2-63

Inner Graticule softkey, 2-122

Input Gate softkey, 2-110

ITS Search softkey, 2-6, 2-21, 2-37, 2-42, 2-48, 2-76, 2-98, 2-103, 2-121

**J**

## Jitter, Main menu

- Average Num, 2-70
- Max Hold, 2-70
- Meas. Line End, 2-70
- Meas. Line Start, 2-70
- Rescale, 2-70
- Threshold, 2-70

## Jitter Long\_Time, Main menu

- Cursors, 2-73
- Freq. Lock, 2-73
- Jitter Waveform, 2-73

Rescale, 2-73

Spectrum Display, 2-73

Jitter Long\_Time Long\_Time, Main menu, Average Num, 2-73

Jitter measurement, 2-69

Jitter Waveform softkey, 2-73

**K****K\_Factor**

## Acquire submenu

- Block Lines, 2-79
- Block Mode, 2-79
- Block Step, 2-79
- Special Position, 2-79

## Graticule Change submenu

- CCIR-2T Graticule, 2-77
- Make Graticule, 2-77

## Graticule submenu

- Graticule Gain, 2-77
- Graticule Reset, 2-78
- Graticule Track, 2-77
- Rescale, 2-78

## Main menu

- Acquire, 2-76
- Average Num, 2-76
- Graticule, 2-76
- Graticule Reference, 2-76
- ITS Search, 2-76
- Rescale, 2-76, 2-89

## Make Graticule submenu

- Lower Region 1, 2-79
- Upper Region 1, 2-78

## Special Position submenu

- Double Pulse Mode, 2-80
- Exit, 2-80
- Pul 2 Offs, 2-80
- Pulse 1 Pos, 2-80
- Set Default, 2-80

Upper Region/Lower Region submenu, Variable AE, 2-78, 2-79

**L**

Last Step softkey, 2-50

Left, 2-76

## Level Meter

## Acquire submenu

- Block Lines, 2-92
- Block Mode, 2-92
- Block Step, 2-92

- Main menu
  - Acquire, 2-86
  - Average Num, 2-84
  - Display Limits, 2-84
  - Max, 2-88
  - Measure Position, 2-86
  - Min, 2-88
  - Rescale, 2-87
- Limit File, 2-55
- Line Frequency, Main menu
  - Average Num, 2-95
  - Rescale, 2-95
- Line time distortion, 3-9
- Low Pass 5.0 MHz softkey, 2-112
- Lower Region 1, 2-79
- Luminance Non-Linearity, 3-14
- Luminance NonLinearity
  - Acquire submenu
    - Block Lines, 2-99
    - Block Mode, 2-99
    - Block Step, 2-99
    - Special Position, 2-99
  - Main menu
    - Acquire, 2-98
    - Average Num, 2-97
    - ITS Search, 2-98
    - Reference, 2-97
    - Relative to Reference, 2-98
    - Rescale, 2-98, 2-109
  - Reference submenu
    - Show (1) Reference/Show (2) Reference, 2-98
    - Store (1) Reference/Store (2) Reference, 2-98
  - Relative to Reference submenu, Use (1) Reference/Use (2) Reference, 2-98
  - Special Position submenu
    - Auto Scan, 2-100
    - Exit, 2-100
- M**
  - Make Graticule, 2-77
  - Make Graticule softkey, 2-122
  - Make Graticule Submenu
    - Lower Region 1, 2-79
    - Upper Region 1, 2-78
  - Manual Steps softkey, 2-50
  - Max % Car softkey, 2-68
  - Max Hold softkey, 2-60, 2-70
  - Max softkey, 2-88
  - Meas. Line End softkey, 2-60, 2-70
  - Meas. Line Start softkey, 2-60, 2-70
  - Meas. Luma softkey, 2-128
  - Meas. Pos softkey, 2-128
  - Meas.Chro P-P softkey, 2-128
  - Measure Cycles softkey, 2-50, 2-106, 2-129
  - Measure Position softkey, 2-86
  - Measure softkey, 2-66
  - Measure Submenu
    - Max % Car, 2-68
    - Min % Car, 2-68
    - Selected % Car, 2-68
    - Threshold, 2-68
    - Transient Chk Quad, 2-68
  - measurements
    - Breezeway Width, 3-5
    - FCC Burst Width, 3-5
    - FCC Equalizer and Serration, 3-7
    - FCC Front Porch, 3-5
    - FCC H Blanking, 3-4
    - FCC H Blanking Interval Timing, 3-4
    - FCC Sync Width, 3-5
    - FCC Sync-Setup, 3-5
    - RS-170 H Blanking Interval Timing, 3-5
    - RS-170A Equalizer and Serration, 3-8
    - Sync Rise and Fall Time, 3-5
    - Sync to Burst End, 3-5
    - V Blank 20 IRE F1 and F2, 3-7
    - V Blank 4 IRE F1 and F2, 3-6
    - VIRS, 3-8
  - menus
    - Bar LineTime
      - Main, 2-4
      - Reference, 2-6
      - Relative to Reference, 2-6
      - Special Position, 2-7
    - Burst Frequency
      - Main, 2-17
      - Reference, 2-17
    - Chrominance AMPM
      - Filters, 2-28
      - Main, 2-25
      - Reference Level, 2-27
    - Chrominance FreqResp
      - dB Reference Level, 2-32
      - Main, 2-31
      - Reference Level, 2-32
      - Relative to Reference Level, 2-32
      - Special Position, 2-33
    - Chrominance NonLinearity
      - Acquire, 2-38
      - Main, 2-37
      - Reference, 2-37
      - Relative to Reference, 2-38
      - Special Position, 2-39

- ChromLum GainDelay
  - Acquire, 2-27, 2-33
  - Main, 2-21
  - Reference, 2-21
  - Relative to Reference, 2-22
  - Special Position, 2-23, 2-44, 2-100
- ChromLum GainDelayAcquire, 2-22
- Color Bar
  - Main, 2-41
  - Reference, 2-43
  - Relative to Reference, 2-43
- Color Bar Acquire, 2-43
- DGDP
  - Main, 2-47
  - Reference, 2-48
  - Relative to Reference, 2-48
  - Special Position, 2-50
- DGDPAcquire, 2-49
- GroupDelay SinX\_X
  - Cursor, 2-58
  - Graticule, 2-55
  - Main, 2-54
  - Reference, 2-55
  - Relative to Reference, 2-55
  - Special Position, 2-56
- GroupDelay SinX\_XAcquire, 2-56
- H\_Blank, Main, 2-60
- H\_Timing, Main, 2-62
- ICPM
  - Graticule, 2-67
  - Main, 2-66
  - Measure, 2-68
  - Relative to Reference, 2-67
- Jitter, Main, 2-70
- Jitter Long\_Time Long\_Time, Main, 2-73
- K Factor, Graticule Reference, 2-76
- K\_Factor
  - Graticule, 2-77, 2-78
  - Main, 2-76
  - Special Position, 2-80
- K\_FactorAcquire, 2-79
- Level Meter
  - Acquire, 2-92
  - Display Limits, 2-88
  - Main, 2-84
  - Measure Position, 2-89
- Line Frequency, Main, 2-95
- Luminance NonLinearity
  - Main, 2-97
  - Reference, 2-98
- Luminance NonLinearityAcquire, 2-99
- MultiBurst
  - Main, 2-103
  - Reference, 2-104
  - Relative to Reference, 2-104
  - Special Position, 2-105
- MultiBurstAcquire, 2-104
- Noise Spectrum
  - Cursors, 2-110
  - Filters, 2-112
  - Input Gate, 2-111
  - Main, 2-107
  - Reference, 2-109
  - Relative to Reference, 2-109
- Noise SpectrumAcquire, 2-110
- SCH\_Phase
  - Dual SCH Display, 2-116
  - Full Field, 2-117
  - Main, 2-116
- ShortTime
  - Acquire, 2-122
  - Graticule, 2-121
  - Main, 2-120
  - Make Graticule, 2-122
  - Special Position, 2-123
- Two Field, Special Position, 2-128
- TwoField
  - Acquire, 2-128
  - Clamp Couple, 2-130
  - Cursors, 2-130
  - Display, 2-128
  - Main, 2-127
  - Sync, 2-129
- V\_Blank, Main, 2-135
- VITS ID, Main, 2-132
- Min % Car softkey, 2-68
- Min softkey, 2-88
- MultiBurst
  - Acquire submenu
    - Block Lines, 2-105
    - Block Mode, 2-104
    - Block Step, 2-105
    - Special Position, 2-104
  - dB Reference submenu
    - Flag (Auto), 2-104
    - Ref Packet/Flag, 2-104
  - Main menu
    - Acquire, 2-103
    - Average Num, 2-103
    - dB Reference, 2-103
    - ITS Search, 2-103
    - Reference, 2-103
    - Relative to Reference, 2-103
    - Rescale, 2-103
  - Reference submenu
    - Show (1) Reference/Show (2) Reference, 2-104

- Store (1) Reference/Store (2) Reference, 2-104
- Relative to Reference submenu, Use (1) Reference/Use (2) Reference, 2-104
- Special Position submenu
  - Center Default, 2-106
  - Exit, 2-106
  - Flag Start Default, 2-105
  - Flag Width Default, 2-105
  - Measure Cycles, 2-106
  - Packet, 2-106
  - Set Default, 2-105
- Multiburst
  - Flag, 3-15
  - Packet, 3-15

## N

- Noise Spectrum
  - Acquire submenu
    - Block Lines, 2-110, 2-123
    - Block Mode, 2-110, 2-122
    - Block Step, 2-110, 2-123
    - Input Gate, 2-110
  - Main menu
    - Acquire, 2-109
    - Area Pos, 2-111
    - Area Width, 2-111
    - Cursor 1/2 Active, 2-110
    - Cursor 1/2 On, 2-110
    - Cursors, 2-109
    - Exit, 2-111
    - Filters Selection, 2-109
    - Nearest Peak, 2-110
    - Normal, 2-111
    - Reference, 2-108
    - Relative to Reference, 2-108
  - Reference submenu
    - Show (1) Reference/Show (2) Reference, 2-109
    - Store (1) Reference/Store (2) Reference, 2-109
  - Relative to Reference submenu, Use (1) Reference/Use (2) Reference, 2-109
  - Special Position submenu
    - Fsc. Trap Filter, 2-112
    - High Pass 100 kHz, 2-112
    - Low Pass 5.0 MHz, 2-112
    - NTC-7 Weighting, 2-112
    - Tilt Null, 2-112
    - Unified Weighting, 2-112
- Normal, 2-76
- Normal softkey, 2-111
- NTC-7 Weighting softkey, 2-112
- NTSC Measurement Specifications, A-1

## O

- Offset n.n%, 2-76
- Offset Reset, 2-76
- Outer Graticule softkey, 2-122

## P

- Packet. *See* softkey
- Packet 1/2/3 softkey, 2-39
- Peak Carrier amplitude, 3-2
- Peak Luma softkey, 2-128, 2-129
- Plot All, 2-68
- Plot All softkey, 2-67
- Polar Graticule, 2-67
- Pul 2 Offs Auto Adj softkey, 2-57
- Pul 2 Offs softkey, 2-57, 2-80
- Pulse 1 Pos softkey, 2-57, 2-80
- Pulse Pos softkey, 2-23
- Pulse-to-Bar Ratip, 3-9

## R

- Ref Freq. softkey, 2-55
- Ref Packet softkey, 2-50
- Ref Packet/Flag softkey, 2-104
- Ref Pos softkey, 2-39
- Ref. (b1) softkey, 2-7
- Ref. 100/0/75/0 I Ref. 100/0/100/0 I Ref. 100/0/100/25 softkey, 2-43
- Ref. 100/7.5/75/7.5 I Ref. 100/7.5/75/7.5 I Ref. 100/7.5/75/7.5 softkey, 2-43
- Ref. 75/7.5/75/7.5 I Ref. 100/0/100/0 I Ref. 75/7.5/75/7.5 softkey, 2-43
- Reference Ch. B softkey, 2-17
- Reference Ch. C softkey, 2-18
- Reference Internal softkey, 2-17
- Reference soft key, 2-5
- Reference softkey, 2-17, 2-37, 2-41, 2-48, 2-54, 2-97, 2-103, 2-108
- Reference Submenu
  - Ref Freq., 2-55
  - Reference Ch. B, 2-17
  - Reference Ch. C, 2-18
  - Reference Internal, 2-17
  - Show (1) Reference/Show (2) Reference, 2-6, 2-21, 2-37, 2-43, 2-48, 2-55, 2-98, 2-104, 2-109
  - Store (1) Reference/Store (2) Reference, 2-6, 2-21, 2-28, 2-37, 2-43, 2-48, 2-55, 2-98, 2-104, 2-109
  - Zero Set, 2-18

Relative Backporch softkey, 2-66  
 Relative Burst Gain, 3-14  
 Relative Burst Phase, 3-14  
 Relative to Reference soft key, 2-5  
 Relative to Reference softkey, 2-21, 2-26, 2-31, 2-37,  
 2-42, 2-48, 2-54, 2-98, 2-103, 2-108  
 Relative to Reference Submenu  
 Ref. 100/0/75/0 I Ref. 100/0/100/0 I Ref.  
 100/0/100/25, 2-43  
 Ref. 100/7.5/75/7.5 I Ref. 100/7.5/75/7.5 I Ref.  
 100/7.5/75/7.5, 2-43  
 Ref. 75/7.5/75/7.5 I Ref. 75/7.5/75/7.5 I Ref.  
 75/7.5/75/7.5, 2-43  
 Use (1) Reference/Use (2) Reference, 2-6, 2-22,  
 2-38, 2-43, 2-48, 2-55, 2-98, 2-104, 2-109  
 Rescale, 2-37, 2-78, 2-95, 2-98, 2-109  
 Rescale softkey, 2-6, 2-17, 2-21, 2-26, 2-28, 2-31,  
 2-42, 2-48, 2-54, 2-60, 2-62, 2-67, 2-70, 2-73,  
 2-76, 2-87, 2-89, 2-103, 2-117, 2-121, 2-128,  
 2-136  
 Right, 2-76  
 RS-170A  
 Burst Width, 3-6  
 Front Porch, 3-6  
 H Blanking, 3-5  
 Sync Width, 3-5  
 RS-170A softkey, 2-62  
 RS-170A  
 Equalizer, 3-8  
 Serration, 3-8

## S

SCH Phase Measurement, 2-114  
 SCH\_Phase, 2-113  
 Full Field submenu, Rescale, 2-117  
 Main menu  
 Average Num, 2-116  
 Dual SCH Display, 2-116  
 Full Field, 2-116  
 SCH\_Phase Menu, 2-115  
 Selected % Car softkey, 2-68  
 serration  
 FCC, 3-8  
 RS-170A, 3-8  
 Serration Pulse softkey, 2-136  
 Set 100%, 2-130  
 Set 100% softkey, 2-130  
 Set Default softkey, 2-7, 2-23, 2-33, 2-39, 2-56, 2-80,  
 2-105, 2-123, 2-128  
 Set FCC softkey, 2-60  
 Set RS-170-A softkey, 2-60

Set to 0.0 softkey, 2-122  
 Set to 1.0 softkey, 2-122  
 ShortTime  
 Acquire submenu, Special Position, 2-122  
 Graticule Gain submenu, Graticule Gain, 2-122  
 Graticule Reset submenu, Graticule Reset, 2-122  
 Graticule submenu  
 IEEE-511 Graticule, 2-121  
 Make Graticule, 2-122  
 Special Graticule, 2-121  
 Graticule Track submenu, Graticule Track, 2-122  
 Main menu  
 Average Num, 2-120  
 Change Display, 2-120, 2-122  
 ITS Search, 2-121  
 Rescale, 2-121  
 Make Graticule submenu  
 Inner Graticule, 2-122  
 Outer Graticule, 2-122  
 Set to 0.0, 2-122  
 Set to 1.0, 2-122  
 Special Position submenu  
 Bar Left, 2-124  
 Bar Right, 2-124  
 Exit, 2-124  
 Set Default, 2-123  
 Show (1) Reference/Show (2) Reference softkey, 2-6,  
 2-21, 2-37, 2-43, 2-48, 2-55, 2-98, 2-104, 2-109  
 Signal ID softkey, 2-132  
 soft keys  
 Acquire, 2-6  
 Average Num, 2-4  
 Reference, 2-5  
 Relative to Reference, 2-5  
 softkeys  
 .i.Noise Spectrum, Main menu, Cursor 1/2 Active,  
 2-110  
 1st Step, 2-50  
 Acquire, 2-21, 2-26, 2-37, 2-42, 2-48, 2-54, 2-76,  
 2-86, 2-98, 2-103, 2-109, 2-128  
 Area, 2-57  
 Area Pos, 2-111  
 Area Width, 2-111  
 Auto Scan, 2-44, 2-50, 2-100  
 Average Num, 2-17, 2-21, 2-25, 2-31, 2-37, 2-41,  
 2-47, 2-54, 2-62, 2-66, 2-70, 2-73, 2-76,  
 2-84, 2-95, 2-97, 2-103, 2-107, 2-116, 2-120,  
 2-127, 2-135  
 Back Porch, 2-128, 2-130  
 Bar Left, 2-124  
 Bar Right, 2-124  
 Black, 2-44

- Blanking Display, 2-136
- Block Lines, 2-7, 2-23, 2-33, 2-39, 2-44, 2-49, 2-79, 2-92, 2-99, 2-105, 2-110, 2-123
- Block Mode, 2-6, 2-23, 2-33, 2-39, 2-44, 2-79, 2-92, 2-99, 2-104, 2-110, 2-122
- Block Step, 2-7, 2-23, 2-33, 2-39, 2-44, 2-49, 2-79, 2-92, 2-99, 2-105, 2-110, 2-123
- Blue, 2-44
- CCIR-2T Graticule, 2-77
- Center Default, 2-34, 2-106
- Change Display, 2-120, 2-122
- Clamp Couple, 2-66, 2-128
- Clamp Fast, 2-67, 2-130
- Clamp Slow, 2-67, 2-130
- Cursor, 2-54, 2-67
- Cursor 1/2 Active, 2-110, 2-130
- Cursor 1/2 On, 2-110
- Cursor Active, 2-58
- Cursor On, 2-58, 2-60, 2-130
- Cursor Relative, 2-130
- Cursor Track, 2-130
- Cursors, 2-73, 2-109, 2-128
- dB Reference, 2-103
- DC Coupling, 2-67, 2-130
- DelayGrat Inverse, 2-55
- Display, 2-127
- Display Limits, 2-84
- Double Pulse Mode, 2-56, 2-80
- Dual SCH Display, 2-116
- Equalizer Pulse, 2-135
- Exit, 2-8, 2-23, 2-34, 2-39, 2-44, 2-50, 2-57, 2-80, 2-100, 2-106, 2-111, 2-124, 2-129
- External Sync, 2-129
- FCC, 2-62
- Field Toggle, 2-43, 2-60
- Filters Selection, 2-109
- Flag (Auto), 2-104
- Flag Start, 2-34
- Flag Start Default, 2-105
- Flag Width, 2-34
- Flag Width Default, 2-105
- Freq. Lock, 2-73
- Fsc. Trap Filter, 2-112
- Full Field, 2-116
- Full VITS Waveform, 2-132
- Grat Incr, 2-67
- Grat Max, 2-67
- Graticule, 2-54, 2-66, 2-76
- Graticule Gain, 2-77, 2-122
- Graticule Labels, 2-67
- Graticule Off, 2-55
- Graticule Reference, 2-76
- Graticule Reset, 2-78, 2-122
- Graticule Track, 2-77, 2-122
- High Pass 100 kHz, 2-112
- IEEE-511 Graticule, 2-121
- Inner Graticule, 2-122
- Input Gate, 2-110
- ITS Search, 2-6, 2-21, 2-37, 2-42, 2-48, 2-76, 2-98, 2-103, 2-121
- Jitter Waveform, 2-73
- Last Step, 2-50
- Limit File, 2-55
- Low Pass 5.0 MHz, 2-112
- Lower Region 1, 2-79
- Make Graticule, 2-77, 2-122
- Manual Steps, 2-50
- Max, 2-88
- Max % Car, 2-68
- Max Hold, 2-60, 2-70
- Meas. Line End, 2-60, 2-70
- Meas. Line Start, 2-60, 2-70
- Meas. Luma, 2-128
- Meas. Pos, 2-128
- Meas.Chro P-P, 2-128
- Measure, 2-66
- Measure Cycles, 2-50, 2-106, 2-129
- Measure Position, 2-86
- Min, 2-88
- Min % Car, 2-68
- Normal, 2-111
- NTC-7 Weighting, 2-112
- Outer Graticule, 2-122
- Packet, 2-34, 2-106
- Packet 1/2/3, 2-39
- Peak Luma, 2-128, 2-129
- Plot All, 2-67, 2-68
- Polar Graticule, 2-67
- Pul 2 Offs, 2-57, 2-80
- Pul 2 Offs Auto Adj, 2-57
- Pulse 1 Pos, 2-57, 2-80
- Pulse Pos, 2-23
- Ref Freq., 2-55
- Ref Packet, 2-50
- Ref Packet/Flag, 2-104
- Ref Pos., 2-39
- Ref. (b1), 2-7
- Ref. 100/0/75/0 I Ref. 100/0/100/0 I Ref. 100/0/100/25, 2-43
- Ref. 100/7.5/75/7.5 I Ref. 100/7.5/75/7.50 I Ref. 100/7.5/75/7.5, 2-43
- Ref. 75/7.5/75/7.5 I Ref. 100/0/100/0 I Ref. 75/7.5/75/7.5, 2-43
- Reference, 2-17, 2-37, 2-41, 2-48, 2-54, 2-97, 2-103, 2-108
- Reference Ch. B, 2-17



- Reference Ch. C, 2-18
- Reference Internal, 2-17
- Relative Backporch, 2-66
- Relative to Reference, 2-21, 2-26, 2-31, 2-37, 2-42, 2-48, 2-54, 2-98, 2-103, 2-108
- Rescale, 2-6, 2-17, 2-21, 2-26, 2-28, 2-31, 2-37, 2-42, 2-48, 2-54, 2-60, 2-62, 2-67, 2-70, 2-73, 2-76, 2-78, 2-87, 2-89, 2-95, 2-98, 2-103, 2-109, 2-117, 2-121, 2-128, 2-136
- RS-170A, 2-62
- Selected % Car, 2-68
- Serration Pulse, 2-136
- Set 100%, 2-130
- Set Default, 2-7, 2-23, 2-33, 2-39, 2-56, 2-80, 2-105, 2-123, 2-128
- Set FCC, 2-60
- Set RS-170-A, 2-60
- Set to 0.0, 2-122
- Set to 1.0, 2-122
- Show (1) Reference/Show (2) Reference, 2-6, 2-21, 2-37, 2-43, 2-48, 2-55, 2-98, 2-104, 2-109
- Signal ID, 2-132
- Special Graticule, 2-121
- Special Position, 2-6, 2-22, 2-33, 2-38, 2-43, 2-49, 2-56, 2-79, 2-99, 2-104, 2-122, 2-128
- Spectrum Display, 2-73
- Store (1) Reference/Store (2) Reference, 2-6, 2-21, 2-28, 2-37, 2-43, 2-48, 2-55, 2-98, 2-104, 2-109
- Sync, 2-128
- Sync A/B/C, 2-129
- Sync Tip, 2-128, 2-130
- System I, 2-55
- Threshold, 2-60, 2-68, 2-70
- Tilt Null, 2-112
- Tracking Lines, 2-68
- Transient Chk Quad, 2-68
- Unified Weighting, 2-112
- Upper Region 1, 2-78
- Use (1) Reference/Use (2) Reference, 2-6, 2-22, 2-38, 2-43, 2-48, 2-55, 2-98, 2-104, 2-109
- V Sync Display, 2-136
- Variable AE, 2-78, 2-79
- White, 2-44
- Width Default, 2-34
- Yellow, 2-44
- Zero Set, 2-18
- Special Graticule softkey, 2-121
- Special Position
  - Bar Left, 2-124
  - Bar Right, 2-124
  - Exit, 2-124, 2-129
  - Meas. Pos, 2-128
  - Measure Cycles, 2-129
  - Peak Luma, 2-129
  - Set Default, 2-123, 2-128
- Special Position softkey, 2-6, 2-22, 2-33, 2-38, 2-43, 2-49, 2-56, 2-79, 2-99, 2-104, 2-122, 2-128
- Special Position Submenu
  - 1st Step, 2-50
  - Area, 2-57
  - Auto Scan, 2-44, 2-50, 2-100
  - Black, 2-44
  - Blue, 2-44
  - Center Default, 2-34, 2-106
  - Cursor On, 2-58
  - Double Pulse Mode, 2-56, 2-80
  - Exit, 2-8, 2-23, 2-34, 2-39, 2-44, 2-50, 2-57, 2-80, 2-100, 2-106
  - Flag Start, 2-34
  - Flag Start Default, 2-105
  - Flag Width, 2-34
  - Flag Width Default, 2-105
  - Fsc. Trap Filter, 2-112
  - High Pass 100 kHz, 2-112
  - Last Step, 2-50
  - Low Pass 5.0 MHz, 2-112
  - Manual Steps, 2-50
  - Measure Cycles, 2-50, 2-106
  - NTC-7 Weighting, 2-112
  - Packet, 2-34, 2-106
  - Packet 1/2/3, 2-39
  - Pul 2 Offs, 2-57, 2-80
  - Pul 2 Offs Auto Adj, 2-57
  - Pulse 1 Pos, 2-57, 2-80
  - Pulse Pos, 2-23
  - Ref Packet, 2-50
  - Ref Pos, 2-39
  - Ref. (b1), 2-7
  - Set Default, 2-7, 2-23, 2-33, 2-39, 2-56, 2-80, 2-105
  - Tilt Null, 2-112
  - Unified Weighting, 2-112
  - White, 2-44
  - Width Default, 2-34
  - Yellow, 2-44
- specifications, A-1
  - Auto Mode, A-7
  - Measure Mode, A-1
- Spectrum Display softkey, 2-73
- Store (1) Reference/Store (2) Reference softkey, 2-6, 2-21, 2-28, 2-37, 2-43, 2-48, 2-55, 2-98, 2-104, 2-109
- Subcarrier to horizontal sync phase, 3-17

Sync  
 External Sync, 2-129  
 Falltime, 3-5  
 Risetime, 3-5  
 Sync A/B/C, 2-129  
 Sync A/B/C softkey, 2-129  
 Sync Amplitude, 3-3  
 Sync softkey, 2-128  
 Sync Tip softkey, 2-128, 2-130  
 Sync to Burst End, 3-5  
 Sync to Burst Start, 3-6  
 Sync variation, 3-4  
 System I, 2-55

## T

Threshold softkey, 2-60, 2-68, 2-70  
 Tilt Nullsoftkey, 2-112  
 Tracking Lines, 2-68  
 Transient Chk Quad softkey, 2-68  
 Two Field  
   Acquire submenu  
     Clamp Couple, 2-128  
     Special Position, 2-128  
     Sync, 2-128  
   Clamp Couple submenu  
     Clamp Fast, 2-130  
     Clamp Slow, 2-130  
     DC Coupling, 2-130  
   Cursor submenu  
     Cursor 1/2 Active, 2-130  
     Cursor On, 2-130  
     Cursor Relative, 2-130  
     Cursor Track, 2-130  
     Set 100%, 2-130  
   Display submenu  
     Back Porch, 2-128, 2-130  
     Meas. Luma, 2-128  
     Meas.Chro P-P, 2-128  
     Peak Luma, 2-128, 2-129  
     Sync Tip, 2-128, 2-130  
   Special Position submenu  
     Exit, 2-129  
     Meas. Pos, 2-128  
     Measure Cycles, 2-129  
     Peak Luma, 2-129  
     Set Default, 2-128  
   Sync submenu  
     External Sync, 2-129  
     Sync A/B/C, 2-129  
 TwoField, Main menu  
   Acquire, 2-128

Average Num, 2-127  
 Cursors, 2-128  
 Display, 2-127  
 Rescale, 2-128

## U

Unified Weighting softkey, 2-112  
 Upper Region 1, 2-78  
 Upper Region/Lower Region Submenu, Variable AE,  
   2-78, 2-79  
 Use (1) Reference/Use (2) Reference softkey, 2-6,  
   2-22, 2-38, 2-43, 2-48, 2-55, 2-98, 2-104, 2-109

## V

V Sync Display softkey, 2-136  
 V\_Blank, Main menu  
   Average Num, 2-135  
   Blanking Display, 2-136  
   Equalizer Pulse, 2-135  
   Rescale, 2-136  
   Serration Pulse, 2-136  
   V Sync Display, 2-136  
 Variable AE, 2-78, 2-79  
 Vertical Interval Test Signals (VITS), 3-1  
 VIRS  
   Chrominance Amplitude, 3-9  
   Chrominance Phase, 3-9  
   Luminance Ref., 3-8  
   measurements, 3-8  
   Setup, 3-8  
 VITS ID, Main menu  
   Full VITS Waveform, 2-132  
   Signal ID, 2-132

## W

White softkey, 2-44  
 Width Default softkey, 2-34

## Y

Yellow softkey, 2-44

## Z

Zero Carrier Pulse, 2-63  
 Zero Carrier pulse, 3-2  
 Zero Set softkey, 2-18





## Free Manuals Download Website

<http://myh66.com>

<http://usermanuals.us>

<http://www.somanuals.com>

<http://www.4manuals.cc>

<http://www.manual-lib.com>

<http://www.404manual.com>

<http://www.luxmanual.com>

<http://aubethermostatmanual.com>

Golf course search by state

<http://golfingnear.com>

Email search by domain

<http://emailbydomain.com>

Auto manuals search

<http://auto.somanuals.com>

TV manuals search

<http://tv.somanuals.com>