

3φ11884 = Serial Number 118190

TEK OPERATORS
MANUAL

070-7066-00
Product Group 41

2232 PORTABLE OSCILLOSCOPE OPERATORS

*Please Check for
CHANGE INFORMATION
at the Rear of This Manual*

First Printing DEC 1988
Revised NOV 1989

Tektronix[®]
COMMITTED TO EXCELLENCE

Copyright © 1988 Tektronix, Inc. All rights reserved. Contents of this publication may not be reproduced in any form without the written permission of Tektronix, Inc.

Products of Tektronix, Inc. and its subsidiaries are covered by U.S. and foreign patents issued and pending.

TEKTRONIX, TEK, SCOPE-MOBILE, and  are registered trademarks of Tektronix, Inc.

Printed in U.S.A. Specification and price change privileges are reserved.

INSTRUMENT SERIAL NUMBERS

Each instrument has a serial number on a panel insert, tag, or stamped on the chassis. The first two digits designate the country of manufacture. The last five digits of the serial number are unique to each instrument. The country of manufacture is identified as follows:

B000000 Tektronix, Inc., Beaverton, Oregon, U.S.A.

E200000 Tektronix United Kingdom, Ltd., Marlow

G100000 Tektronix Guernsey, Ltd., Channel Islands

HK00000 Hong Kong

H700000 Tektronix Holland, NV, Heerenveen,
The Netherlands

J300000 Sony/Tektronix, Japan

Certificate of the Manufacturer/Importer

We hereby certify that the 2232 OSCILLOSCOPE

AND ALL INSTALLED OPTIONS

complies with the RF Interference Suppression requirements of
Amtsbl.-Vfg 1046/1984.

The German Postal Service was notified that the equipment is being marketed.

The German Postal Service has the right to re-test the series and to verify that
it complies.

TEKTRONIX

Bescheinigung des Herstellers/Importeurs

Hiermit wird bescheinigt, daß der/die/das 2232 OSCILLOSCOPE

AND ALL INSTALLED OPTIONS

in Übereinstimmung mit den Bestimmungen der Amtsblatt-Verfügung 1046/1984
funkentstört ist.

Der Deutschen Bundespost wurde das Inverkehrbringen dieses Gerätes
angezeigt und die Berechtigung zur Überprüfung der Serie auf Einhalten
der Bestimmungen eingeräumt.

TEKTRONIX

NOTICE to the user/operator:

The German Postal Service requires that Systems assembled by the operator/user of this instrument must also comply with Postal Regulation, Vfg. 1046/1984, Par. 2, Sect. 1.

HINWEIS für den Benutzer/Betreiber:

Die vom Betreiber zusammengestellte Anlage, innerhalb derer dies Gerät eingesetzt wird, muß ebenfalls den Voraussetzungen nach Par. 2, Ziff. 1 der Vfg. 1046/1984 genügen.

TABLE OF CONTENTS

	Page
LIST OF ILLUSTRATIONS	vi
LIST OF TABLES	ix
OPERATORS SAFETY SUMMARY	xi
 SECTION 1 – GENERAL INFORMATION	
INTRODUCTION	1-1
ACCURACY AND RESOLUTION	1-3
STANDARD ACCESSORIES	1-5
 SECTION 2 – PREPARATION FOR USE	
SAFETY	2-1
LINE VOLTAGE	2-1
POWER CORD	2-1
LINE FUSE	2-4
INSTRUMENT COOLING	2-4
START-UP	2-4
REPACKAGING	2-5
 SECTION 3 – CONTROLS, CONNECTORS, AND INDICATORS	
INTRODUCTION	3-1
POWER AND DISPLAY	3-1
VERTICAL	3-3
HORIZONTAL	3-9
TRIGGER	3-17
STORAGE CONTROLS	3-23
SAVE REFERENCE/MENU ITEM SELECT	3-27
REAR PANEL	3-28

SIDE PANEL	3-30
MENU SYSTEM OPERATION	3-33
SETUP ACQ MENU	3-33
SETUP DISPLAY MENU	3-37
SETUP REF MENU	3-39
SETUP PLOT MENU	3-43
SETUP ADV FUNCT MENU	3-45
CRT READOUT	3-46

SECTION 4—OPERATING CONSIDERATIONS

BASIC OPERATION	4-1
GRATICULE	4-1
GROUNDING	4-1
SIGNAL CONNECTIONS	4-2
INPUT-COUPLING CAPACITOR PRECHARGING	4-4

SECTION 5—OPERATOR'S CHECKS AND ADJUSTMENTS

INTRODUCTION	5-1
INITIAL SETUP	5-1
TRACE ROTATION ADJUSTMENT	5-2
PROBE COMPENSATION	5-3
HORIZONTAL ACCURACY CHECK	5-5

SECTION 6—BASIC APPLICATIONS

INTRODUCTION	6-1
OSCILLOSCOPE DISPLAYS	6-1
NON-STORE DISPLAYS	6-1
DIGITAL STORAGE DISPLAYS	6-6
NONSTORAGE MEASUREMENTS	6-9
VOLTAGE	6-10
TIMING	6-19
TELEVISION SIGNALS	6-30
DELAYED-SWEEP MAGNIFICATION	6-32

DELAYED-SWEEP TIME	6-35
DIGITAL STORAGE MEASUREMENTS	6-42
VOLTAGE	6-42
TIMING	6-46
LOW-LEVEL SIGNALS	6-61
OBSERVING AND REMOVING ALIASES IN STORE MODE	6-63
GLITCHES AND PULSES	6-66

SECTION 7 – PERFORMANCE CHARACTERISTICS

INTRODUCTION	7-1
--------------------	-----

SECTION 8 – OPTIONS AND ACCESSORIES

INTRODUCTION	8-1
ACCESSORIES AND OPTIONS DESCRIPTION	8-1
STANDARD ACCESSORIES	8-1
OPTIONAL ACCESSORIES	8-2
POWER CORD OPTIONS	8-2
OPTION 10	8-3
OPTION 12	8-3
OPTION 33	8-3
COMMUNICATIONS OPTION OPERATION	8-4
OPTION 10 GPIB OPERATORS INFORMATION	8-4
OPTION 12 RS-232-C OPERATORS INFORMATION	8-19
RS-232-C PROGRAMMING	8-33
COMMUNICATION AND WAVEFORM TRANSFER	8-35
READOUT/MESSAGE COMMAND CHARACTER SET	8-35
MESSAGES AND COMMUNICATION PROTOCOL	8-38
WAVEFORM TRANSFERS	8-42
COMMUNICATION COMMANDS	8-51
STATUS BYTES AND EVENT CODES	8-84

APPENDIX A - PERFORMANCE CHECK PROCEDURE

INTRODUCTION	A-1
PURPOSE	A-1
PERFORMANCE CHECK INTERVAL	A-1
STRUCTURE	A-1
TEST EQUIPMENT REQUIRED	A-1
LIMITS AND TOLERANCES	A-4
PREPARATION FOR CHECKS	A-5
INDEX TO PERFORMANCE CHECK STEPS	A-5
VERTICAL	A-7
INITIAL CONTROL SETTINGS	A-7
PROCEDURE STEPS	A-8
HORIZONTAL	A-22
INITIAL CONTROL SETTINGS	A-22
PROCEDURE STEPS	A-23
TRIGGER	A-33
INITIAL CONTROL SETTINGS	A-33
PROCEDURE STEPS	A-34
EXTERNAL Z-AXIS, PROBE ADJUST, EXTERNAL CLOCK, AND X-Y PLOTTER	A-42
INITIAL CONTROL SETTINGS	A-42
PROCEDURE STEPS	A-43

APPENDIX B - COMMUNICATION OPTIONS SUPPLEMENTAL INFORMATION

INTRODUCTION	B-1
RS-232-C DEVICE INTERCONNECTION	B-1
RS-232-C STANDARD	B-1
DETERMINING DEVICE TYPE	B-1
INTERCONNECTION RULES	B-2
INTERCONNECTION CABLE-TYPE IDENTIFICATION	B-4
RS-232-C INTERCONNECTION CABLE ILLUSTRATIONS	B-4

INTERCONNECTION CABLE PART NUMBERS B-14
PRINTER/PLOTTER OPERATION B-14
PLOTTER TYPES B-14
QUESTIONS AND ANSWERS B-26

CHANGE INFORMATION

LIST OF ILLUSTRATIONS

Figure	Page
1-1 The 2232 Digital Storage Oscilloscope	1-1
2-1 Securing the detachable power cord to the instrument	2-2
2-2 Optional power cord data	2-3
3-1 Power and display controls and power-on indicator	3-1
3-2 Vertical controls and connectors	3-3
3-3 Horizontal controls	3-9
3-4 Trigger controls, connector, and indicator	3-17
3-5 Storage Controls	3-23
3-6 Save reference/menu items select buttons	3-27
3-7 Rear panel	3-29
3-8 Side panel	3-30
3-9 X-Y Plotter interfacing	3-32
3-10 ACQUISITION menu	3-34
3-11 DISPLAY menu	3-38
3-12 REFERENCE menu (NVmem selected)	3-40
3-13 REFERENCE menu (Format selected)	3-42
3-14 PLOT menu	3-44
3-15 ADVANCED FUNCTIONS menu	3-46
3-16 Crt readout display	3-47
4-1 Graticule measurement markings	4-2
5-1 Probe compensation	5-4
6-1 Peak-to-peak waveform voltage	6-11
6-2 Ground-referenced voltage measurement	6-13
6-3 Algebraic addition	6-15
6-4 Common-mode rejection	6-17
6-5 Time Duration	6-20
6-6 Rise time	6-22
6-7 Time difference between two time related pulses	6-25
6-8 Phase difference	6-27
6-9 High-resolution phase difference	6-28

6-10	Delayed-sweep magnification	6-34
6-11	Time difference between repetitive pulses	6-37
6-12	Rise time, differential time method	6-39
6-13	Time difference between two time-related pulses, differential time method	6-41
6-14	Ac peak-to-peak voltage, cursor method	6-43
6-15	Ground-referenced dc voltage, cursor method	6-46
6-16	Time duration, cursor method	6-47
6-17	Rise-time setup, five-division display	6-49
6-18	Rise time, cursor method	6-50
6-19	Waveform comparison	6-52
6-20	Time difference between repetitive pulses	6-54
6-21	Time difference between two-related pulses	6-56
6-22	Phase difference between sinusoidal signals	6-58
6-23	Slope using cursors	6-60
6-24	Low-level signal, STORE mode	6-62
6-25	Low-level signal, AVERAGE mode	6-63
6-26	Anti-aliasing	6-65
6-27	Glitch display, ACCPEAK Store mode	6-67
6-28	Glitch display, STORE mode using B HORIZONTAL MODE	6-69
6-29	Missing pulse, ACCPEAK STORE mode	6-71
7-1	Maximum input voltage versus frequency derating curve for the CH 1 OR X, CH 2 OR Y, and EXT INPUT connectors	7-27
7-2	Physical Dimensions of the 2232 Oscilloscope	7-28
8-1	Option 10 side panel	8-8
8-2	SRQ, ADDR, and PLOT indicators	8-14
8-3	Option 12 side panel	8-23
B-1	Null Modem cable wiring (non-handshaking)	B-3
B-2	Type A Connections—DTE male to DCE female	B-6
B-3	Type A Connections (cont)—DTE male to DCE female	B-7
B-4	Type A1 Connections—DTE female to DCE female	B-8
B-5	Type A2 Connections—DTE male to DCE male	B-9
B-6	Type B Connections—DTE male to DTE male and DCE male to DCE male	B-10

B-7	Type B1 Connections – DTE female to DTE male and DCE female to DCE male	B-11
B-8	Type B1 Connections (cont) – DTE female to DTE male and DCE female to DCE male	B-12
B-9	Type B2 Connections – DTE female to DTE female and DCE female to DCE female	B-13
B-10	Option 12 RS-232-C Printer/Plotter interconnects	B-15
B-11	Option 12 RS-232-C communication parameters	B-16
B-12	HP 7470A ad HP 745A plotter RS-232-C switch settings	B-17
B-13	Option 12 PARAMETERS switch settings for HP-GL compatible plotters	B-18
B-14	Epson FX-Series printer RS-232-C switch settings ...	B-19
B-15	Option 12 PARAMETERS switch settings for Epson printers	B-20
B-16	HP ThinkJet RS-232-C switch settings	B-21
B-17	Option 12 PARAMETERS switch settings for HP ThinkJet printer	B-22
B-18	Option 10 GPIB Interface PARAMETERS switch	B-23
B-19	Option 10 PARAMETERS switch settings for compatible GPIB printers/plotters	B-24
B-20	Switch settings for compatible GPIB plotters	B-25

LIST OF TABLES

Table	Page
3-1 Probe Coding	3-5
3-2 Digital Storage Modes	3-11
3-3 Repetitive Store Sampling Data Acquisition	3-12
3-4 Auxiliary Connector	3-31
7-1 Electrical Characteristics	7-2
7-2 Environmental Characteristics	7-23
7-3 Physical Characteristics	7-26
8-1 Function Subsets Implemented	8-5
8-2 Specific Format Choices	8-6
8-3 Implementation of Specific Features	8-7
8-4 GPIB Connector	8-9
8-5 GPIB PARAMETERS Switch	8-11
8-6 Specific Format Choices for Option 12	8-20
8-7 RS-232-C DTE Connector	8-24
8-8 RS-232-C DCE Connector	8-25
8-9 RS-232-C PARAMETERS Switch	8-26
8-10 Baud Rate	8-29
8-11 Parity Selection	8-30
8-12 Readout/MESage Command Character Set	8-36
8-13 ASCII Code Chart	8-37
8-14 Numeric Argument Format for Commands	8-42
8-15 Typical 8-Bit Binary-Encoded Waveform Data	8-45
8-16 Typical 16-Bit Binary-Encoded Waveform Data	8-46
8-17 Typical 8-Bit Hexadecimal-Encoded Waveform Data	8-48
8-18 Typical 16-Bit Hexadecimal-Encoded Waveform Data	8-49
8-19 Typical ASCII-Encoded Waveform Data	8-50
8-20 Vertical Commands	8-53
8-21 Horizontal Commands	8-54
8-22 Trigger Commands	8-55
8-23 Cursor Commands	8-56
8-24 Display Commands	8-59
8-25 Acquisition Commands	8-61
8-26 Save and Recall Reference Commands	8-65

8-27	Waveform Commands	8-70
8-28	Waveform Preamble Fields	8-73
8-29	Miscellaneous Commands	8-80
8-30	Service Request Group Commands	8-82
8-31	RS-232-C Specific Commands	8-83
8-32	Status Event Error Categories	8-86
8-33	Event Codes	8-87
A-1	Test Equipment Required	A-2
A-2	Deflection Accuracy Limits	A-8
A-3	Storage Deflection Accuracy	A-10
A-4	Settings for Bandwidth Checks	A-15
A-5	Settings for Timing Accuracy Checks	A-24
A-6	Settings for Delay Time Differential Checks	A-29
A-7	Switch Combinations for A Triggering Checks	A-34
B-1	Cable-Type Identification	B-5
B-2	RS-232-C Transfer Rates	B-27

OPERATORS SAFETY SUMMARY

The safety information in this summary is for operating personnel. Warnings and cautions will also be found throughout the manual where they apply.

Terms in this Manual

CAUTION statements identify conditions or practices that could result in damage to the equipment or other property.

WARNING statements identify conditions or practices that could result in personal injury or loss of life.

Terms as Marked on Equipment

CAUTION indicates a personal injury hazard not immediately accessible as one reads the markings, or a hazard to property, including the equipment itself.

DANGER indicates a personal injury hazard immediately accessible as one reads the marking.

Symbols in this Manual



This symbol indicates where applicable cautionary or other information is to be found. For maximum input voltage see Table 7-1.

Symbols as Marked on Equipment



DANGER—High voltage.



Protective ground (earth) terminal.



ATTENTION—Refer to manual.

Power Source

This product is intended to operate from a power source that does not apply more than 250 volts rms between the supply conductors or between either supply conductor and ground. A protective ground connection, by way of the grounding conductor in the power cord, is essential for safe operation.

Grounding the Product

This product is grounded through the grounding conductor of the power cord. To avoid electrical shock, plug the power cord into a properly wired receptacle before making any connections to the product input or output terminals. A protective ground connection, by way of the grounding conductor in the power cord, is essential for safe operation.

Danger Arising From Loss of Ground

Upon loss of the protective-ground connection, all accessible conductive parts, including knobs and controls that may appear to be insulating, can render an electric shock.

Use the Proper Power Cord

Use only the power cord and connector specified for your product.

The power cord must be in good condition.

For detailed information on power cords and connectors see Figure 2-2 .

Use the Proper Fuse

To avoid fire hazard, use only a fuse of the correct type, voltage rating and current rating as specified on the back of your product.

Do Not Operate in an Explosive Atmosphere

To avoid explosion, do not operate this product in an explosive atmosphere unless it has been specifically certified for such operation.

Do Not Remove Covers or Panels

To avoid personal injury, do not remove the product covers or panels. Do not operate the product without the covers and panels properly installed.

SECTION 1

**GENERAL
INFORMATION**

2232 Operators

INTRODUCTION

The TEKTRONIX 2232 is a combination nonstorage and digital storage portable, dual-channel oscilloscope with 100 MHz analog bandwidth and up to 100 MS/s digital sampling rate in both channels. The vertical channels have calibrated deflection factors from 2 mV to 5 V per division. The Variable VOLTS/DIV gain control increases the deflection factor at least 2.5 to 1 on any VOLTS/DIV setting. Vertical display modes are CH 1, CH 2, and BOTH, with a choice in BOTH of ADD, ALT, or CHOP. A BW LIMIT feature limits the vertical amplifier system and the A Trigger system to 20 MHz.

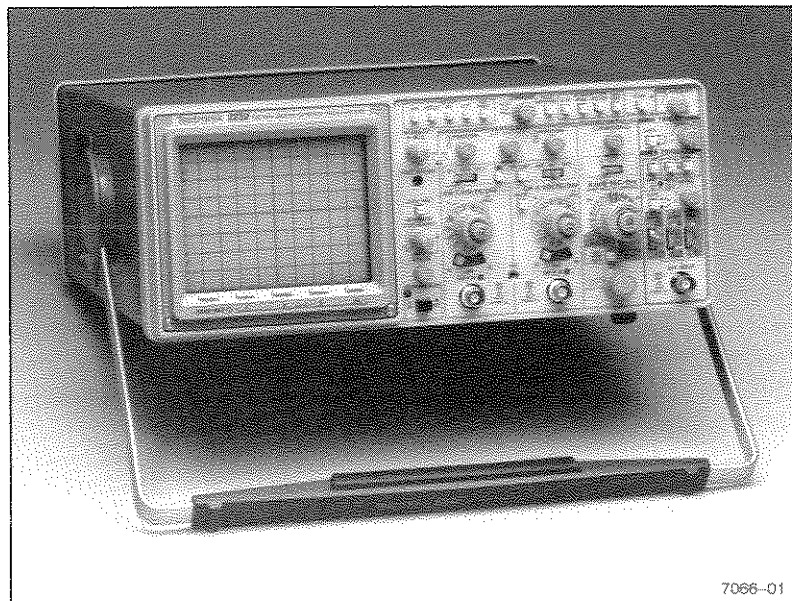

Figure 1-1. 2232 Digital Storage Oscilloscope.

The horizontal deflection system calibrated A Sweep speeds range from 0.5 s to 50 ns per division; calibrated B Sweep speeds range from 50 ms to 50 ns per division. A X10 MAG control decreases

sweep time per division of the A and B Sweeps by a factor of 10. The fastest sweep-speed time of 50 ns per division is extended to 5 ns per division in X10 MAG. The Variable SEC/DIV control may be used to increase the non-store sweep time per division by a factor of up to four times from the calibrated time per division determined by the SEC/DIV switch setting. In STORE Mode, rotating the Variable SEC/DIV control out of the CAL detent position compresses a 4K sample acquisition record into a record of 1K samples (called 4K compress mode). Also in STORE Mode, the A SEC/DIV X10 Multiplier adds calibrated storage time bases of 1, 2, and 5 s per division to the NON STORE A Sweep speed range for low-frequency signal acquisitions.

The digital storage and display portion of the 2232 is microprocessor controlled. Selecting the digital storage features is done with a combination of front-panel controls and menu choices. Selected front-panel controls are read by the microprocessor to determine their settings. Those settings are reported to the user in a crt readout display generated for the CH 1 and CH 2 VOLTS/DIV switch, the A and B SEC/DIV switch, the DELAY TIME Position control, the Voltage and Time cursor differences (on STORE Mode displays only), the position of AC-GND-DC switches, and the A Trigger LEVEL voltage level. All the parametric information for the waveform display is therefore visible when a hard copy is made to maintain a permanent record of the display. When in STORE (digital) mode, additional readout information is displayed showing storage acquisition mode, SAVE REF memories, if displayed, SAVE mode, and SWEEP LIMIT, if active.

Digital storage maximum sampling rate is 100 megasamples per second with a maximum stored record length per waveform of either 4096 bytes (4K) for single-channel acquisitions or 2048 bytes (2K) for dual-channel acquisitions (ALT or CHOP). In CHOP mode, both channels are sampled simultaneously. The digital storage acquisition system has glitch-catching capabilities for glitch widths as narrow as 10 ns.

Up to three waveform sets (CH 1 and/or CH 2) of 1K record length (512 data points each waveform for dual-channel acquisitions) or one waveform set of 4K record length (2K when dual-channel) may be

stored in the SAVE REF memories. In either case, previous data is over-written. A saved waveform may be recalled for display and comparison with the current acquisition waveform and any or all of the other saved waveforms. The X10 MAG control is also functional for STORE waveforms and provides for horizontal expansion of 10 times. The CURSOR Control may be used to reposition the display window on X10 expanded STORE waveforms to view the entire acquisition.

On stored waveforms (current acquisition and saved displays), voltage and time measurements may be made using CURSORS. The cursors are positioned to the waveform of interest and then to the points of interest in the waveform. The ΔV and Δt crt readouts indicate the voltage difference and timing difference between the positions of the cursors on the waveform selected. Horizontal positioning of the 1K display window within a 4K acquisition record is also provided by the CURSOR Positioning control. In this manner, the entire 4K record length may be scrolled through for display on the crt. The displayed 1K window of a 4K record length acquisition waveform is the data stored when using the SAVE REF memory to save 1K waveform data. A 4K record length acquisition may also be compressed to a 1K record length by rotating the variable SEC/DIV control away from the CAL detent position. The complete waveform is then only one display window in length. A 4K compress waveform may be saved in any of the three 1K SAVE REF memories.

ACCURACY AND RESOLUTION

Finite resolution affects any measurement using discrete numbers. All digital storage stores amplitude values as discrete numbers and associates those amplitude numbers with discretely numbered times. Many measurements must be rounded or truncated. The size of the truncation or rounding becomes a part of the measurement error. For example, the following line is 1.5 units long. If it must be drawn as a line connecting points one unit apart, then it may be drawn as a line one unit long or two units long, depending on how it occurs relative to the points.

General Information

Case 1: Line approaches three points:



Case 2: Line approaches two points:



There are several places where measurements are quantified, and a one-count error in the measurement cannot be detected. The input channels are digitized to an 8-bit resolution, where one division is (ignoring expansion and compression) 25 counts. This means there is an inherent error of 1/25 of a division in any voltage measurement at acquisition time. Averaging can increase the resolution of a voltage measurement above the sampler's eight-bit limit. To use the increased resolution, the display has a 10-bit dynamic range in the vertical axis, as well as the horizontal axis. An averaged signal has a resolution of 100 points per division (ignoring expansion and compression). In addition, the averaged number is stored with up to twelve bits of resolution. Expansion is required to view the eleventh and twelfth bits of increased resolution.

Time is quantified to determine when each sample occurred and which display interval gets each sample. Time is resolved by storing, for example, 4K points. If 4K points are stored, 4K time intervals are represented. However, in 4K mode, not all of the 4K-point resolution may be displayed on the 10-bit (1K-point) screen. Therefore, if 4K COMPRESS is selected to present the whole picture on-screen at once, only 1K resolution remains in the display. When peak-detected information is acquired, events with high-frequency content such as fast steps, or short pulses, can only be located within the time interval from which the peaks came. Even though two display points result from the interval, the event cannot be tied with certainty to the first or second point in the interval.

Time is also quantified to determine where to put points in REPETITIVE acquisitions, where the points acquired at 10 ns intervals fill only part of the screen. A counter produces a number to represent the portion of 10 ns between the samples acquired and the ones that would have included the trigger. This number allows accurate placement into the display record. The display record will have at most 20 slots to choose from on the basis of the counter number (this is where each slot represents 0.5 ns of acquisition time).

STANDARD ACCESSORIES

The following items are standard accessories shipped with the 2232 instrument:

- 1 Operators Manual
- 1 Users Reference Guide
- 2 Probe Packages
- 1 Front Panel Cover
- 1 Accessory Pouch
- 1 Power Cord
- 1 Fuse
- 1 DB-9 Male Connector and Connector Shell
- 1 Loop Clamp
- 1 Flat Washer
- 1 Self-Tapping Screw

For part numbers and further information about both standard and optional accessories, refer to "Options and Accessories" (Section 8) of this manual. Your Tektronix representative, local Tektronix Field Office, or Tektronix products catalog can also provide additional accessories information.

SECTION 2

**PREPARATION
FOR USE**

2232 Operators

SAFETY

This part of the manual tells how to prepare for and to proceed with the initial start-up of the instrument.

Refer to the Safety Summary at the front of this manual for power source, grounding, and other safety considerations pertaining to the use of the instrument. Before connecting the oscilloscope to a power source, read entirely both this section and the Safety Summary.

LINE VOLTAGE

This instrument is capable of continuous operation with input voltages that range from 90 V to 250 V with source voltage frequencies from 48 Hz to 440 Hz.

POWER CORD

A detachable three-wire power cord with a three-contact plug is provided with each instrument for connecting to both the power source and protective ground. The power cord may be secured to the rear panel by a cord-set-securing clamp (see Figure 2-1). The protective-ground contact in the plug connects (through the protective-ground conductor) to the accessible metal parts of the instrument. For electrical-shock protection, insert this plug only into a power-source outlet that has a properly grounded protective-ground contact.

Instruments are shipped with the power cord specified by the customer. Available power-cord information is presented in Figure 2-2, and part numbers are listed in Options and Accessories (Section 7). Contact your Tektronix representative or local Tektronix Field Office for additional power-cord information.

Preparation for Use

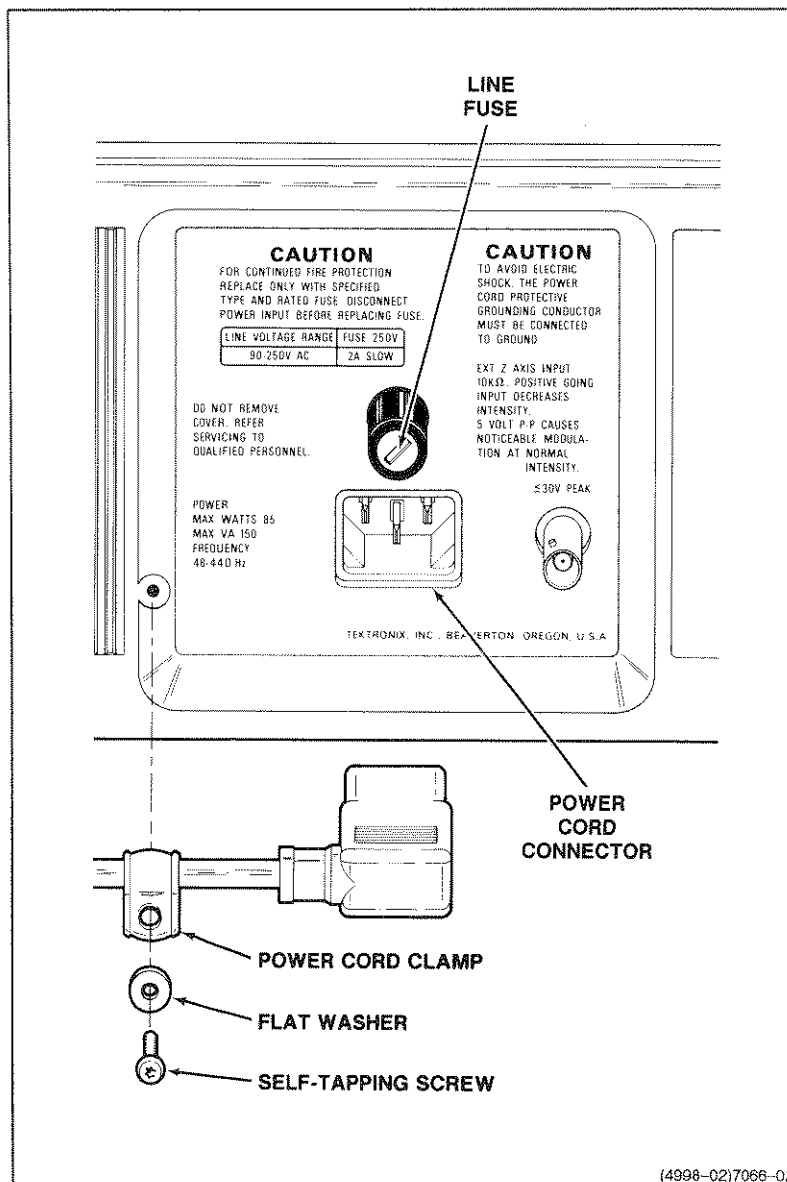
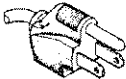
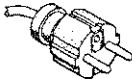



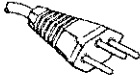

Figure 2-1. Securing the detachable power cord to the instrument.

Plug Configuration	Option	Power Cord/ Plug Type	Line Voltage	Reference Standards ^b
	U.S. Std.	U.S. 120V	120V	ANSI C73.11 NEMA 5-15-P IEC 83 UL 198.6
	A1	EURO 220V	220V	CEE(7), II, IV, VII IEC 83 IEC 127
	A2	UK ^a 240V	240V	BS 1363 IEC 83 IEC 127
	A3	Australian 240V	240V	AS C112 IEC 127
	A4	North American 240V	240V	ANSI C73.20 NEMA 6-15-P IEC 83 UL 198.6
	A5	Switzerland 220V	220V	SEV IEC 127
<p>^a A 6A, type C fuse is also installed inside the plug of the Option A2 power cord.</p> <p>^b Reference Standards Abbreviations:</p> <p>ANSI—American National Standards Institute AS—Standards Association of Australia BS—British Standards Institution CEE—International Commission on Rules for the Approval of Electrical Equipment IEC—International Electrotechnical Commission NEMA—National Electrical Manufacturer's Association SEV—Schweizerischer Elektrotechnischer Verein UL—Underwriters Laboratories Inc.</p>				

7066-03

Figure 2-2. Optional power cord data.

LINE FUSE

The instrument fuse holder is located on the rear panel (see Figure 2-1) and contains the line-protection fuse. The following procedure may be used either to verify that the proper fuse is installed or to install a replacement fuse.

1. Unplug the power cord from the power-input source (if plugged in).
2. Press in the fuse-holder cap and release it with a slight counter-clockwise rotation.
3. Pull the cap (with the attached fuse inside) out of the fuse holder.
4. Verify that the proper fuse is installed (see the rear-panel fuse nomenclature).
5. Reinstall the proper fuse in the fuse cap and replace the cap and fuse in the fuse holder by pressing in and giving a slight clockwise rotation of the cap.

INSTRUMENT COOLING

To prevent instrument damage from overheated components, adequate internal airflow must be maintained at all times. Before turning on the power, first verify that both the fan-exhaust holes on the rear panel and the air-intake holes on the side panel are free from any obstructions to airflow. After turning on the instrument, verify that the fan is exhausting air.

START-UP

The instrument automatically performs power-up tests of the digital portion of the circuitry each time the instrument is turned on. The purpose of these tests is to provide the user with the highest possible confidence level that the instrument is fully functional. If no faults are encountered during the power-up testing, the instrument will enter the

normal operating mode. If the instrument fails one of the power-up tests, the instrument attempts to indicate the cause of the failure.

If a failure of any power-up test occurs, the instrument may still be usable for some applications, depending on the nature of the failure. If the instrument functions for your immediate measurement requirement, it may be used, but refer it to a qualified service technician for repair of the problem at the earliest convenience. Consult your service department, your local Tektronix Service Center, or your nearest Tektronix representative if additional assistance is required.

REPACKAGING

If this instrument is shipped by commercial transportation, use the original packaging material. Unpack the instrument carefully from the shipping container to save the carton and packaging material for this purpose.

If the original packaging is unfit for use or is not available, repackage the instrument as follows:

1. Obtain a corrugated cardboard shipping carton having inside dimensions at least six inches greater than the instrument dimensions and having a carton test strength of at least 275 pounds.
2. If the instrument is being shipped to a Tektronix Service Center for repair or calibration, attach a tag to the instrument showing the following: owner of the instrument (with address), the name of a person at your firm who may be contacted if additional information is needed, complete instrument type and serial number, and a description of the service required.
3. Wrap the instrument with polyethylene sheeting or equivalent to protect the outside finish and prevent entry of packing materials into the instrument.
4. Cushion the instrument on all sides by tightly packing dunnage or urethane foam between the carton and the instrument, allowing

Preparation for Use

for three inches of padding on each side (including top and bottom).

5. Seal the carton with shipping tape or with an industrial stapler.
6. Mark the address of the Tektronix Service Center and your return address on the carton in one or more prominent locations.

SECTION 3

**CONTROLS,
CONNECTORS
AND
INDICATORS**

2232 Operators

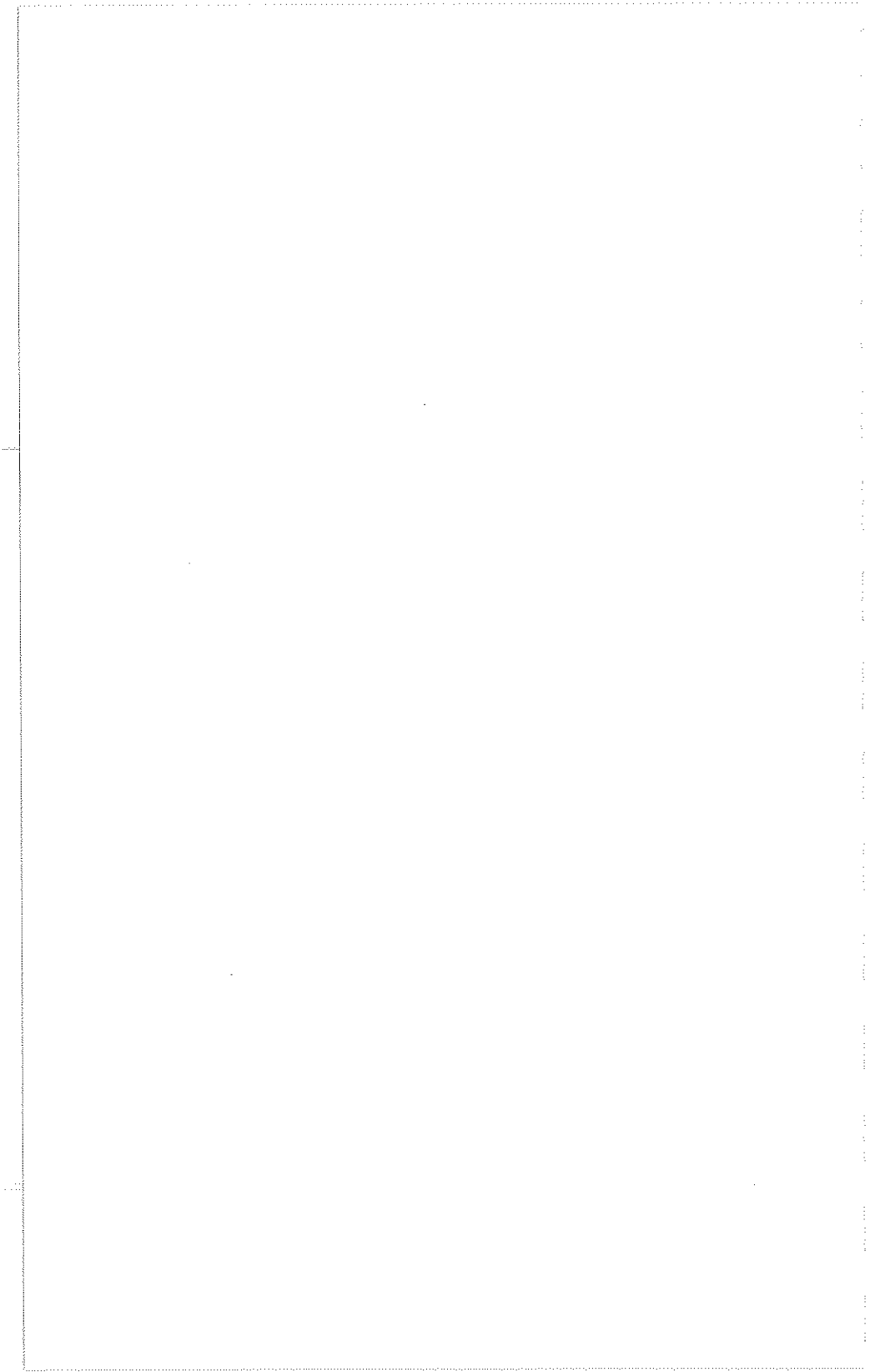

INTRODUCTION

The following descriptions are intended to familiarize the operator with the location and function of the instrument's controls, connectors, and indicators.

POWER AND DISPLAY

Refer to Figure 3-1 for location of items 1 through 10.

- 1 **Internal Graticule** – Eliminates parallax viewing error between the trace and the graticule lines. Rise-time amplitude and measurement points are indicated at the left edge of the graticule.

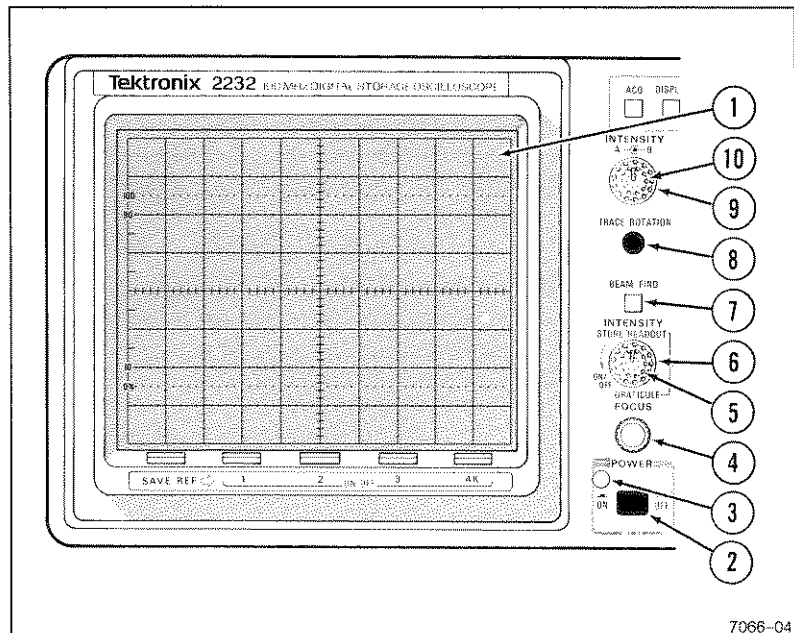

Figure 3-1. Power and display controls and power-on indicator.

Controls, Connectors, and Indicators

- ② **POWER Switch** – Turns instrument power on or off. Press in for ON; press again for OFF.
- ③ **Power On Indicator** – Lights up while instrument is operating.
- ④ **FOCUS Control** – Adjusts for optimum display definition. Once set, proper focusing is maintained over a wide range of display intensity.
- ⑤ **GRATICULE Intensity Control** – Adjusts the intensity of the graticule illumination lamps.
- ⑥ **STORAGE/READOUT INTENSITY Control** – Adjusts brightness of the STORE mode displayed waveforms and the readout intensity in both STORE and NON-STORE modes. The fully counterclockwise position of the control toggles the STORE/NON-STORE readout on and off.
- ⑦ **BEAM FIND Switch** – Compresses the vertical and horizontal deflection to within the graticule area and intensifies the display to aid in locating traces that are overscanned or deflected outside of the crt viewing area.
- ⑧ **TRACE ROTATION Control** – Permits alignment of the trace with the horizontal graticule line. This control is a screwdriver adjustment that, once set, should require little attention during normal operation.
- ⑨ **A INTENSITY Control** – Adjusts the brightness of all NON-STORE displayed waveforms. The control has no effect on the STORE mode displays or the crt readouts.
- ⑩ **B INTENSITY Control** – Adjusts the brightness of the NON-STORE B Delayed Sweep and the intensified zone on the A Sweep. The control has no effect on STORE mode displays or crt readouts.

VERTICAL

Refer to Figure 3-2 for location of items 11 through 20.

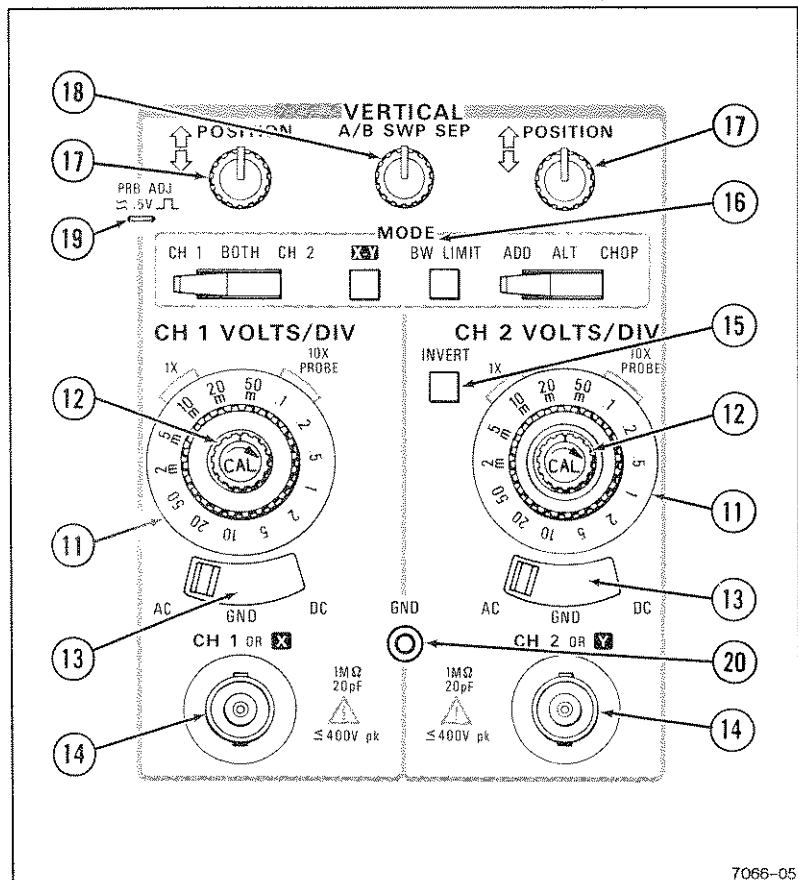

Figure 3-2. Vertical controls and connectors.

- ⑪ **VOLTS/DIV Switches**—Select the vertical channel deflection factors from 2 mV to 5 V per division in a 1-2-5 sequence. The VOLTS/DIV switch setting for both channels is displayed in the

crt readout. The VOLTS/DIV control settings for displayed waveforms containing cursor symbols are shown in the crt readout.

In STORE mode, SAVE waveforms and waveforms waiting to be updated between trigger events may be vertically expanded or compressed by up to a factor of 10 times (or as many VOLTS/DIV switch positions remaining whichever is less) by switching the corresponding VOLTS/DIV control (waveforms acquired at 2 mV/div cannot be expanded and waveforms acquired at 5 V/div cannot be compressed). The VOLTS/DIV readout reflects the vertical scale factor of the displayed waveform. If the VOLTS/DIV switch is switched beyond the available expansion or compression range, the readout is tilted to indicate that the VOLTS/DIV switch setting and the VOLTS/DIV readout no longer agree.

1X PROBE — Front-panel marking that indicates the deflection factor set by the VOLTS/DIV switch when a X1 probe or a coaxial cable is attached to the channel input connector.

10X PROBE — Front-panel marking that indicates the deflection factor set by the VOLTS/DIV switch when a properly coded 10X probe is attached to the channel input connector.

If properly coded probes (1X, 10X, or 100X, see Table 3-1) are connected to a channel input connector, the crt VOLTS/DIV readout will reflect the correct deflection factor of the display.

- ⑫ **Variable VOLTS/DIV Controls** — Provide continuously variable uncalibrated deflection factors between the calibrated positions of the VOLTS/DIV controls. The VOLTS/DIV sensitivity is reduced by up to at least 2.5 times the sensitivity at the fully counter-clockwise position of the variable knob. A detent at the fully clockwise position indicates the calibrated VOLTS/DIV position of the variable knob. The uncalibrated condition is indicated by a greater-than symbol (>) in front of the affected VOLTS/DIV readout.

Table 3-1
Probe Coding

Probe	Coding Resistance
1X	Infinite
10X	11 k Ω \pm 10%
100X	5.6 k -10% to 6.2 k + 10%
IDENTIFY	\approx 0 Ω
Unknown	None of the above

- ⑬ **AC-GND-DC (Input Coupling) Switches** – Select the method of coupling the input signal to the Channel 1 and Channel 2 vertical amplifiers and the storage acquisition system.

AC – Capacitively couples the input signal to the vertical deflection and signal acquisition systems. The DC component of the input signal is blocked. The lower 3 dB bandpass is 10 Hz or less. Selection of AC input coupling is indicated in the readout by a tilde symbol (\sim) over the V on the associated channel's VOLTS/DIV readout.

GND – Grounds the input of the vertical amplifier; provides a zero (ground) reference voltage display (does not ground the input signal). In STORE mode, the ground reference is acquired and displayed in the first sample location of the acquisition waveform display. When GND input coupling is selected, a ground (\hbar) symbol is displayed in the associated VOLTS/DIV readout.

DC – All frequency components of the input signal are coupled to the vertical deflection and signal acquisition systems. When DC input coupling is selected, no additional indicators are displayed with the associated VOLTS/DIV readout.

- ⑭ **CH 1 OR X and CH 2 OR Y Input Connectors**—Provide for application of signals to the inputs of the vertical deflection system and the storage acquisition system.

Coding-ring contacts on each of the input connectors are used to automatically switch the scale factor displayed by the crt readout when a properly coded probe is attached to the input connector. Displayed STORE mode waveforms are reformatted to maintain the correct deflection as indicated by the VOLTS/DIV readout on the affected channel(s). In X-Y mode, the signal connected to the CH 1 OR X input connector controls the horizontal deflection, and the signal connected to the CH 2 OR Y input connector controls the vertical deflection.

- ⑮ **INVERT Switch**—Inverts the Channel 2 display and STORE mode Channel 2 acquisition signal when pressed in. An invert symbol (\downarrow) is displayed with the CH 2 VOLTS/DIV readout when Channel 2 is inverted. With Channel 2 inverted, the oscilloscope may be operated as a differential amplifier when the BOTH-ADD Vertical MODE is selected.

- ⑯ **Vertical MODE Switches**—Select the mode of operation for the vertical amplifier. There are two three-position switches and two two-position push-button switches that determine display, acquisition modes and bandwidth in NON-STORE mode.

The CH1-BOTH-CH 2 switch selects Channel 1, Channel 2, or both channels for display.

CH 1—Selects only the Channel 1 input signal for acquisition or display.

BOTH—Selects a combination of Channel 1 and Channel 2 input signals for acquisition or display. The CH 1-BOTH-CH 2 switch must be in the BOTH position for ADD, ALT, and CHOP operation.

CH 2—Selects only the Channel 2 input signal for acquisition or display.

The ADD-ALT-CHOP switch selects method for switching input channels when the CH1-BOTH-CH2 switch is in BOTH position.

ADD—In NON-STORE, displays, or, in STORE, acquires then displays the sum of the Channel 1 and Channel 2 input signals when BOTH is also selected. If Channel 2 is inverted, the difference of the Channel 1 and Channel 2 input signals is displayed.

ALT—In NON-STORE mode, alternately displays the Channel 1 and Channel 2 input signals. Alternation occurs during retrace at the end of each sweep. ALT Vertical MODE is most useful for acquiring and viewing both channel input signals at sweep rates of 0.5 ms per division and faster. In STORE mode, Channel 1 and Channel 2 signals are acquired on alternate acquisition cycles and then displayed at one-half the resolution of a single-channel acquisition.

CHOP—In NON-STORE mode, switches the display between the sweep. The chopped switching rate (CHOP frequency) is about 500 kHz. In STORE mode, both channels are acquired simultaneously and then displayed at one-half the resolution of a single-channel acquisition.

The BW LIMIT and X-Y switches select vertical bandwidth limit and X-Y modes.

BW LIMIT—Limits the bandwidth of the vertical deflection system and the A Trigger system in NON-STORE and STORE mode to about 20 MHz when pressed in. This reduces interference from unwanted high-frequency signals when viewing low-frequency signals. Pressing the button a second time releases the switch and returns the vertical and A Trigger circuit to full bandwidth.

X-Y—Selects X-Y mode when pressed in. The Channel 1 input signal provides horizontal deflection for X-Y displays, and the Channel 2 input signal provides vertical deflection in both the NON-STORE and STORE mode. In STORE mode, Channel 1 and Channel 2 signals are acquired simultaneously. The sampling rate is controlled by the A or the B

SEC/DIV switch (depending on the Horizontal MODE selection). The X-Y waveform is acquired in sampling mode. The menu-selectable STORE display mode may be either dots (default) or vectors.

In NON-STORE X-Y mode, only the Channel 2 POSITION control vertically positions the display and Horizontal POSITION control horizontally positions the display. In STORE X-Y mode, both the Channel 1 POSITION control and the Horizontal POSITION control affect the horizontal position of the displayed waveform.

- ①7 **Vertical POSITION Controls**—Control the vertical display position of the Channel 1 and Channel 2 signals.

In STORE mode, the controls determine the vertical position of displayed waveforms during acquisition and in SAVE mode. Any portions of a signal being acquired that are outside the dynamic range of the A/D converter are blanked when positioned on screen. The Vertical POSITION controls can also reposition a vertically expanded SAVE waveform so that portions of the waveform outside the graticule area can be observed.

- ①8 **A/B SWP SEP Control (NON-STORE only)**—Vertically positions the B Sweep trace with respect to the A Sweep trace when the Horizontal MODE is BOTH.

- ①9 **PRB ADJ Connector**—Provides an about 0.5 V, negative-going, square-wave voltage (at about 1 kHz) for compensating voltage probes and checking the operation of the oscilloscope's vertical system. It is not intended to verify the accuracy of the vertical gain or the horizontal time-base circuitry.

- ①0 **GND**—Connector Provides an auxiliary ground connection directly to the instrument chassis via a banana-tip jack.

HORIZONTAL

Refer to Figure 3-3 for location of items 21 through 27.

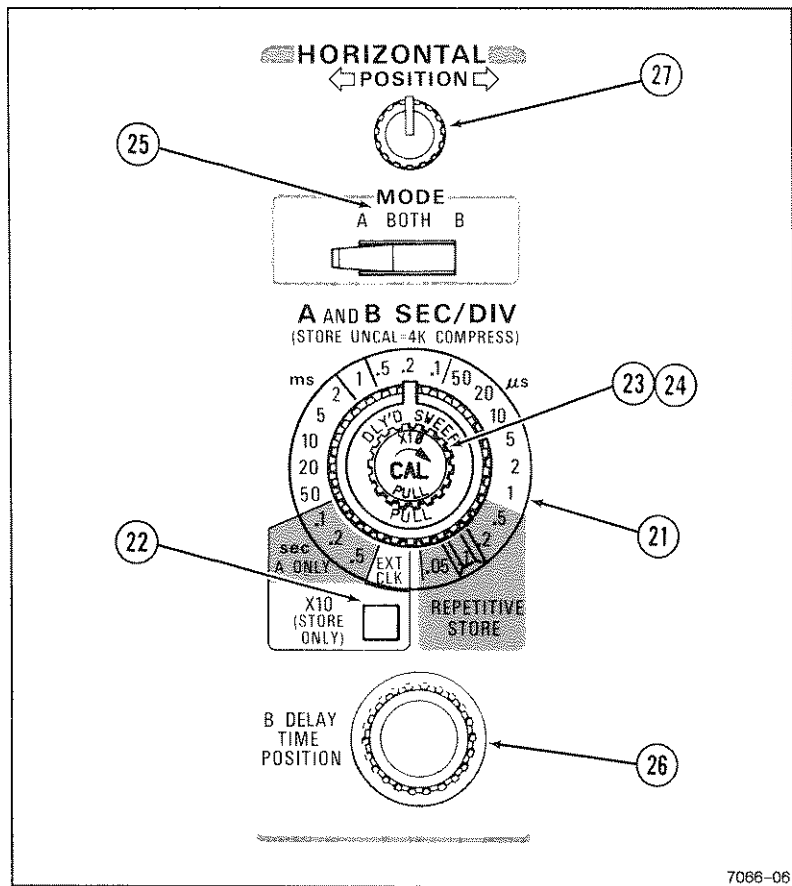

Figure 3-3. Horizontal controls.

- ②1 **SEC/DIV Switches**—Determine the SEC/DIV setting for both the NON-STORE sweeps and the STORE mode waveform acquisitions. To obtain calibrated A and B NON-STORE sweeps, the Variable SEC/DIV control must be in the CAL detent.

In STORE mode, the SEC/DIV switches determine the available acquisition and display modes, sets the sampling rate, and establish the seconds-per-division scale factor of the displayed waveforms. The SEC/DIV parameters displayed on the crt readout are for the waveforms identified by CURSORS.

Table 3-2 lists the Storage, Acquisition, and Auto Vectors with respect to the SEC/DIV switch setting and the selected Trigger mode. The Acquisition Mode and Auto Vectors shown in bold face and listed first in Table 3-2 for each SEC/DIV switch setting is the default mode. The other Acquisition Modes listed for that setting may be selected by pressing the ACQUISITION MODE button or from the ACQUISITION menu. If the selected acquisition mode is not applicable, the SEC/DIV switch setting selects the default mode. Acquisition settings are saved in a nonvolatile memory and recalled on power up.

For a description of the acquisition modes, refer to the SETUP ACQ MENU portion of the MENU SYSTEM OPERATION in this section.

To change the vectors, refer to the SETUP DISPLAY MENU portion of the MENU SYSTEM OPERATION in this section.

A SEC/DIV Switch—Selects the calibrated A Sweep rates for NON-STORE from 0.5 s to 0.05 μ s/div in a 1-2-5 sequence of 22 steps for the A Sweep generator and sets the delay time scale factor for delayed-sweep operation.

In STORE mode, the A SEC/DIV switch controls the available storage, acquisition, and vector modes when making acquisitions using the A Time Base. It also selects the external clock signal, from the EXT CLK input, for the storage acquisition circuitry.

Table 3-2
Digital Storage Modes

SEC/DIV Setting	Trigger Mode Selected	Storage Mode	Acquisition ^a Mode	Auto ^{a,b} Vectors
0.05 μ s/div to 0.5 μ s/div (CH1, CH2, ADD) or to 0.2 μ s/div (ALT, CHOP)	All	Repetitive	AVERAGE SAMPLE ACCPEAK	OFF/ON
1 μ s/div (CH1, CH2, ADD) or 0.5 μ s/div to 2 μ s/div in ALT, CHOP Vertical MODE	All	Fast Record	SAMPLE ACCPEAK AVERAGE	ON/OFF
5 μ s/div to 50 ms/div or EXT CLK dc to 100 kHz (Fast Mode) ^c	All	Slow Record	PEAKDET ACCPEAK SAMPLE AVERAGE	ON/OFF
0.1 s/div to 5 s/div or EXT CLK dc to 1 kHz (Slow Mode) ^c	NORM	Triggered Scan ^d	PEAKDET ACCPEAK SAMPLE AVERAGE	ON/OFF
	P-P AUTO	Untriggered Scan ^d	PEAKDET SAMPLE	ON/OFF
	SGL SWP	Scan-roll-Scan ^{d,f}		
	P-P AUTO and NORM	Roll ^e		
	SGL SWP	Triggered Roll ^e		

^aThe default mode for Acquisition and Vectors AUTO modes are in bold face.

^bIn X-Y mode, Auto Vectors are turned off.

^cExternal clock speed range is selected in the ACQUISITION menu.

^dScan is selected in the ACQUISITION menu.

^eRoll is selected in the ACQUISITION menu.

^fStorage mode is Triggered Scan if ACCPEAK or AVERAGE Acquisition mode is selected.

B SEC/DIV Switch—Selects the calibrated B Sweep rates for NON-STORE from 50 ms/div to 0.05 μ s/div in a 1-2-5 sequence of 19 steps.

In STORE mode, the B SEC/DIV switch controls the default storage, acquisition, and vector modes when making acquisitions using the B Horizontal MODE.

Storage Modes

Repetitive—Requires a repetitive trigger signal from 0.05 μ s/div to 0.5 μ s/div or to 0.2 μ s/div in ALT and CHOP Vertical MODE. Sampling of the input signal occurs at the maximum A/D conversion rate (100 Mega Samples per second). If a control affecting an acquisition parameter or function is changed, the acquisition is reset, and the waveform being acquired is cleared on the next sample acquired. On each valid trigger, 50 or more equally spaced samples are acquired and displayed on the waveform record, depending on the SEC/DIV setting (see Table 3-3).

Table 3-3
Repetitive Store Sampling Data Acquisition

SEC/DIV Switch Setting	Samples Per Acquisition		Expected Acquisitions Per Waveform ^a	
	1K Mode	4K Mode	1 Channel	2 Channels
0.05 μ s	50	200	72	30
0.1 μ s	100	400	30	12
0.2 μ s	200	800	12	3
0.5 μ s	500	2000	3	1

^aExpected acquisitions per waveform for a 50% probability of fill.

The random time delay from the trigger to the following sample is measured and used to place the acquired waveform samples in the correct display memory location. Any display location is equally likely to be filled. Table 3-3 gives the statistically expected number of trigger events required to completely fill the display, assuming a uniform distribution of trigger events relative to the sample interval. The default acquisition mode is AVERAGE. All acquisition modes except PEAKDET are allowed.

Fast Record—Updates a full record of the acquired waveform from 1 μ s/div or 0.5 μ s/div (ALT and CHOP Vertical MODE) to 2 μ s/div. The default acquisition mode is SAMPLE. All acquisition modes except PEAKDET are allowed.

Slow Record—Updates a full record of the acquired waveform from 5 μ s/div to 50 ms/div or Ext Clk Fast mode. The default acquisition mode is PEAKDET. All acquisition modes are allowed.

Triggered Scan—Updates pretrigger data when a trigger is received in NORM A TRIGGER mode and from 0.1 s/div to 5 s/div or Ext Clk Slow mode. The waveform display then scans to the right from the trigger point to finish the post-trigger acquisition and freezes. The default acquisition mode is PEAKDET. All acquisition modes are allowed.

Untriggered Scan—Continuously updates the display serially as each data point is acquired in P-P AUTO mode and from 0.1 s/div to 5 s/div or Ext Clk Slow mode. It writes over previous data from left to right. The default acquisition mode is PEAKDET. Only PEAKDET and SAMPLE acquisition modes are allowed.

Scan-Roll-Scan—Updates the display serially in SGL SWP A TRIGGER mode and from 0.1 s/div to 5 s/div or Ext Clk Slow mode. The waveform display scans left to right until the pre-trigger record is filled, and then rolls right to left until a trigger is received. It then scans left to right again to fill the post-trigger acquisition record and then freezes. The default acquisition mode is PEAKDET. Only PEAKDET and SAMPLE acquisition modes are allowed.

Roll—Continuously acquires and displays signals in P-P AUTO mode and from 0.1 s/div to 5 s/div or Ext Clock Slow mode. Triggers are disabled except in SGL SWP A TRIGGER mode. The waveform display scrolls from right to left across the crt with the latest samples appearing at the right edge of the crt. The default acquisition mode is PEAKDET. Only PEAKDET and Sample acquisition modes are allowed.

Triggered Roll—Rolls the display from right to left until a triggering event occurs in SGL SWP A TRIGGER mode and from 0.1 s/div to 5 s/div or Ext Clock Slow mode. The display continues to roll after the trigger event until the post-trigger acquisition record is filled, and freezes. The default acquisition mode is PEAKDET. Only PEAKDET and Sample acquisition modes are allowed.

- ②② **X10 (STORE ONLY) Button**—Functions only in the STORE mode at SEC/DIV switch settings of 0.1, 0.2, and 0.5 s/div. When pressed in, the A Sweep time base of these three settings is increased by a factor of 10 to 1 s/div, 2 s/div, and 5 s/div. Releasing the button returns the STORE mode time base to X1.

The X10 MAG control functions normally on waveforms acquired in the X10 (STORE ONLY) mode.

- ②③ **A and B SEC/DIV Variable and 4K COMPRESS Control**—Varies the sweep time per division in NON-STORE mode or compresses a 4K record (four screen lengths) to a 1K record (one screen length) in STORE mode.

A and B SEC/DIV Variable—Continuously varies the uncalibrated NON-STORE sweep time per division to at least four times the calibrated time per division set by the SEC/DIV switch (increases the slowest A Sweep time per division to at least 2 s/div).

4K COMPRESS—Compresses 4K record to a 1K record in STORE mode during waveform acquisitions or in SAVE mode when the SEC/DIV Variable control is rotated out of the CAL detent. Does not alter waveform acquisition when the SEC/DIV

Variable control is out of the CAL detent. In 4K COMPRESS mode, the SEC/DIV Variable control is effectively multiplied by four and its readout also has a "c" displayed before it. In PEAKDET and ACCPEAK acquisition modes, peaks are acquired but may not be displayed. Rotating the SEC/DIV Variable control does not affect 1K acquisitions.

- ②④ **X10 Magnifier Switch**—Magnifies the NON-STORE displays or expands the STORE acquisition and SAVE waveform displays by 10 times. Displays are expanded when the Variable SEC/DIV knob is pulled to the out position (X10 PULL). The SEC/DIV scale factor readouts are adjusted to correspond to the correct SEC/DIV of the displayed waveform. Magnification of the NON-STORE displays occurs around the center vertical graticule division; STORE mode displays are expanded around the active CURSOR. The display window for STORE mode X10 expanded waveforms may be positioned using the CURSORS control to view any portion (1/10 in 1K record 1/40 in 4K record) of the acquisitions. In NON-STORE mode, the Horizontal POSITION control horizontally position the display throughout the entire waveform.

- ②⑤ **Horizontal MODE Switch**—Determines the operating mode of the horizontal deflection system in both NON-STORE and STORE modes. For STORE mode, the switch selects the acquisition time base and resultant storage mode.

A—Only the A Sweep is displayed. NON-STORE time base and STORE acquisitions are controlled by the A SEC/DIV switch. The A SEC/DIV switch setting is displayed on the crt readout.

BOTH—In NON-STORE mode, alternates the display between the A Intensified and B Delayed Sweeps. The A Sweep is determined by the setting of the A SEC/DIV switch. The B Sweep speed and the length of the intensified zone are both determined by the B SEC/DIV switch setting. In STORE mode, only the A Intensified sweep is displayed. The A

SEC/DIV switch in STORE mode sets digitizing rate and acquisition mode.

B—Displays either the NON-STORE or the STORE B Sweep trace. The A SEC/DIV, B SEC/DIV, and B DELAY TIME POSITION settings are displayed on the crt readout, just as in BOTH. The STORE mode waveform acquisitions are controlled by the B SEC/DIV switch.

- ②6 **B DELAY TIME POSITION Control**—Adjusts the delay between the start time of the A Sweep and the time that the B Sweep either starts (RUNS AFTER DLY) or can be triggered (triggerable after delay). The A Sweep does not have to be displayed. The delay time is variable from 0.5 to 10 times the A SEC/DIV, plus 300 ns.

In triggerable after delay, the delay time readout indicates the time that must elapse after the A trigger before the delayed sweep or delayed acquisition can be triggered; not the actual position of the trigger point. However, the readout of the delay time on the crt follows the setting of the B DELAY TIME POSITION control in either B Sweep mode.

The setting of the 1K/4K button affects the delay time position setting for STORE mode displays by a factor of about four times. When switching between 1K and 4K record lengths, the delay time position setting must be readjusted to obtain the same delay time.

- ②7 **Horizontal POSITION Control**—Positions all the NON-STORE waveforms horizontally over a one-sweep-length range (either X1 or X10 Magnified). In STORE mode, waveforms may be positioned over a range of one display window (10 divisions). If an acquisition display is longer than one screen (as in 4K records and/or X10 MAG), the CURSORS control is used to position the display window to any position of the acquisition record.

TRIGGER

Refer to Figure 3-4 for location of items 28 through 38.

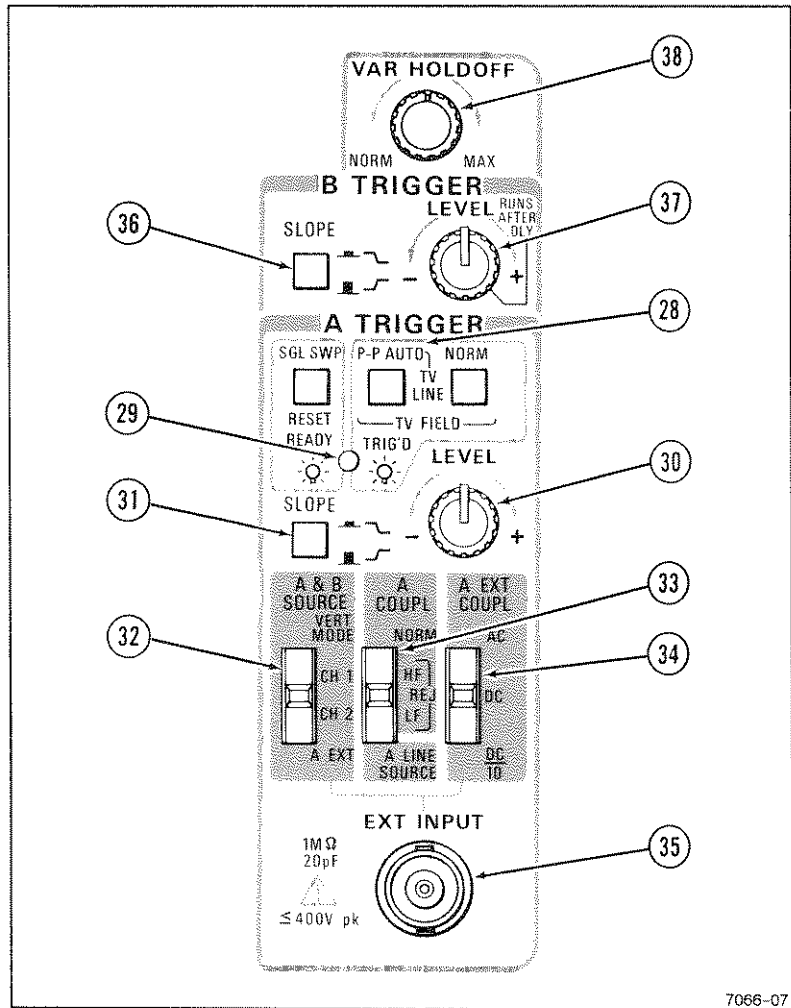

Figure 3-4. Trigger controls, connector, and indicator.

NOTE

The Trigger controls affect the acquisition of the next waveform. They are inactive in SAVE acquisition mode.

②8 **A TRIGGER Mode Switches**—Determine the NON-STORE A Sweep triggering mode. STORE mode triggering depends on the position of the A SEC/DIV and the A Trigger mode. The trigger position is marked by a T on acquired waveforms.

NORM—Permits triggering at all sweep rates (an autotrigger is not generated in the absence of an adequate trigger signal). NORM Trigger mode is especially useful for low-frequency and low-repetition-rate signals.

In STORE mode, the last acquired waveform is held on display between triggering events. The pretrigger portion of the acquisition memory is continually acquiring new pretrigger data, but the display is not updated until the trigger event occurs and the rest of the acquisition memory fills. The method used to display the posttrigger waveform data depends on the SEC/DIV switch setting.

For SEC/DIV switch settings sweep speeds of 5 s per division to 0.1 s per division, Scan storage mode is selected. The posttrigger data points are placed in the display as they are acquired.

For SEC/DIV switch settings above 0.1 s per division, record storage mode is used. The posttrigger data points are stored in the acquisition memory prior to completely updating the waveform display, using the newly acquired data.

P-P AUTO/TV LINE—In NON-STORE mode, triggering occurs on trigger signals having adequate amplitude and a repetition rate of about 20 Hz or faster. In the absence of a proper trigger signal, an autotrigger is generated, and the sweep free runs.

In STORE mode, for SEC/DIV settings of 5 s per division to 0.1 s per division, Roll or Scan storage mode is selected,

and the acquisition free runs. At faster SEC/DIV settings, triggered acquisitions occur under the same conditions as NON-STORE mode P-P AUTO triggering, and the acquisition free-runs if proper triggering conditions are not met. The display is filled and updated as described in Fast Record and Slow Record portion of the Storage Modes in this section.

For either NON-STORE or STORE mode, the range of the A TRIGGER LEVEL control is automatically restricted to the peak-to-peak limits of the trigger signal for ease in obtaining triggered displays and acquisitions. P-P AUTO is the usual trigger mode selection to obtain stable displays of TV Line information.

TV FIELD—Permits stable triggering on a television field (vertical sync) signal when the P-P AUTO and the NORM Trigger buttons are pressed in together. In the absence of an adequate trigger signal, the sweep (or acquisition) free-runs. The instrument otherwise behaves as in P-P AUTO.

SGL SWP—Arms the A Trigger circuit for a single sweep in NON-STORE or a single acquisition in STORE mode. Triggering requirements are the same as in NORM trigger mode. After the completion of a triggered NON-STORE sweep or a STORE SGL SWP acquisition, pressing in the SGL SWP button rearms the trigger circuitry to accept the next triggering event or start the next storage acquisition.

In STORE mode when the SGL SWP is armed, the acquisition cycle begins, but the READY LED does not come on until the pretrigger portion of the acquisition memory is filled. At the time the READY LED comes on, the acquisition system is ready to accept a trigger. When a trigger event occurs, the posttrigger waveform data is stored to complete the single-sweep acquisition. After the acquisition is completed, the READY LED goes out, and the single sweep can be rearmed. The SEC/DIV switch settings and the STORE mode determine how the display is updated.

For SEC/DIV switch settings of 5 s per division to 0.1 s per division, triggered roll, scan-roll-scan, or triggered scan is used depending on the selection of Roll or Scan and the acquisition mode (see Table 3-2).

For SEC/DIV switch settings of 50 ms per division to 5 μ s per division, record mode is used, and the display is updated as a full record. The previously displayed waveform remains on the crt until the posttrigger portion of the acquisition memory is filled. The waveform display is then updated with the newly acquired data in its entirety.

For SEC/DIV switch settings of 2 μ s per division to 0.05 μ s per division, repetitive mode is used. Each time the SGL SWP button is pushed in, a partial record is acquired, overlaying the samples, if any, accumulated from past acquisitions.

- ②⑨ **RESET/READY Indicator**—A dual-function LED indicator. In P-P AUTO and NORM Trigger modes, the LED is turned on when triggering occurs. In SGL SWP Trigger mode, the LED turns on when the A Trigger circuit is armed, awaiting a triggering event, and turns off again after the single sweep (or acquisition) completes.

In STORE mode, pressing the SGL SWP button to arm the trigger circuitry does not immediately turn on the READY LED. The pretrigger portion of the acquisition memory starts filling after the SGL SWP button is pressed in; the READY LED is turned on when the filling is completed. The storage acquisition system is then ready to accept a triggering event. The READY LED is turned off after an acquisition is completed.

- ③⑩ **A TRIGGER LEVEL Control**—Selects the voltage level on the A Trigger signal that produces triggering. The trigger point for STORE mode is identified by a T on the acquired waveform. The A Trigger level is displayed on the crt readout.

31 **A TRIGGER SLOPE Switch**—Selects either the positive or negative slope of the trigger signal to start the NON-STORE A Sweep or to reference the next STORE mode acquisition cycle.

32 **A & B SOURCE Switch**—Selects the source of the internal trigger signal for both the A and the B Trigger Generator circuits. Also selects internal trigger as the A Trigger source.

VERT MODE—Trigger signal is obtained alternately from the Channel 1 and Channel 2 input signals in ALT Vertical MODE. In the CHOP or ADD Vertical MODE the trigger signal is the sum of the Channel 1 and Channel 2 input signals.

CH 1—The signal applied to the CH 1 OR X input connector is the source of the trigger signal.

CH 2—The signal applied to the CH 2 OR Y input connector is the source of the trigger signal. The polarity of the CH 2 Trigger signal may be inverted by the Channel 2 INVERT switch so the displayed slope agrees with the Trigger SLOPE switch.

A EXT—Signals applied to the EXT INPUT connector are routed to the A Trigger circuit.

33 **A COUPL Switch**—Selects the method of coupling the input trigger signal to the A Trigger circuit.

NORM—All frequency components of the trigger signals are coupled to the A Trigger circuit.

HF REJ—Attenuates the high-frequency triggering signal components above 40 kHz of the trigger signal.

LF REJ—Attenuates low-frequency triggering signal components below 40 kHz of the trigger signal.

A LINE SOURCE—Routes a sample of the ac power source waveform to the A Trigger circuit.

③④ **A EXT COUPL Switch**—Selects the method of coupling the external signal applied to the EXT INPUT connector to the A Trigger circuit.

AC—Input signal is capacitively coupled, and blocks the dc component of the signal.

DC—Couples dc and all frequency components of the external trigger signal.

DC/10—Attenuates the external signal by a factor of 10. Couples dc and all frequency components of the external trigger signal.

③⑤ **EXT INPUT Connector**—Provides for connection of external signals to the A Trigger circuit.

③⑥ **B TRIGGER SLOPE Switch**—Selects either the positive or the negative slope of the B Trigger signal (internal source only) that starts the NON-STORE sweep or completes the STORE acquisition.

③⑦ **B TRIGGER LEVEL Control**—Selects the amplitude point on the B Trigger signal where triggering occurs in triggerable after delay mode. The B Trigger point is displayed as a T on the STORE mode waveform display when in B Horizontal mode. The fully clockwise position of the B TRIGGER LEVEL Control selects the runs after delay mode of operation for the B Trigger circuitry. Out of the cw position, B Sweep is triggerable after the delay time.

③⑧ **VAR HOLDOFF Control**—Varies the holdoff time over a 10 to 1 range. NON-STORE Variable Holdoff starts at the end of the A Sweep. STORE mode Holdoff starts at the end of the acquisition cycle, and ends after the waveform data has been transferred from the acquisition to the display memory and the pretrigger portion of the acquisition memory has been filled. After STORE mode Holdoff ends, the next acquisition can be triggered after the holdoff period ends. STORE mode Holdoff may be many

times the length of the A Sweep time so that several holdoff periods may occur during STORE Holdoff time. This ensures that STORE mode triggering is controllable by the VAR HOLDOFF control and will be stable if the NON-STORE display is stable.

STORAGE CONTROLS

Refer to Figure 3-5 for location of items 39 through 42.

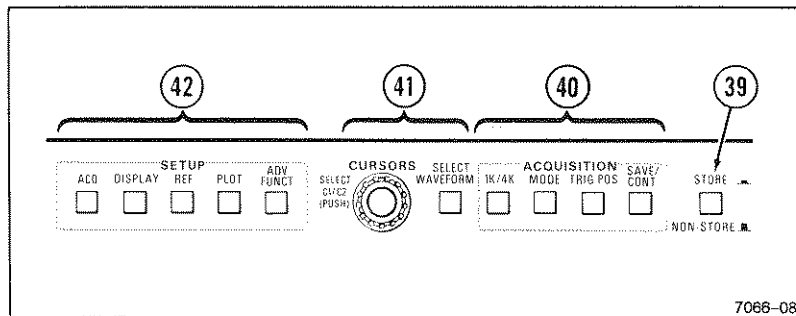

Figure 3-5. Storage Controls.

39 STORE/NON-STORE Button—Selects either the NON-STORE mode (button out) or the Store mode (button in) for display. When switching from Store mode to NON-STORE mode, the last-acquired waveform is stored in memory.

40 ACQUISITION Buttons—Determine the method of acquiring and displaying the acquired store waveform.

SAVE/CONT—Selects continue display update or stops the current acquisition. If the SEC/DIV switch setting is 0.1 s per division or slower, the display is entered immediately upon pressing the button to SAVE. At SEC/DIV settings of 50 ms per division and faster, if an acquisition has been triggered, the acquisition is allowed to complete before it is saved.

The pretrigger portion of an untriggered acquisition stops filling in SAVE mode. When leaving SAVE mode, a new acquisition is started, and a trigger is not accepted until the pretrigger portion again refills.

TRIG POS — Positions the trigger point for acquisitions either near the end (pretrigger), the middle (midtrigger), or the beginning (posttrigger) of the waveform. A "T" is displayed on the waveform and bar graph to indicate the trigger point. Pressing the TRIG POS button in causes a change in trigger position on the next acquisition. Successive presses of the TRIG POS button will rotate the trigger point through the posttrigger, midtrigger, and pretrigger, and back to posttrigger position again. The change in trigger point will only be seen on new acquisitions. The 4k bar graph trigger symbol changes immediately each time the TRIG POS button is pressed. The trigger symbol is italicized until the new acquisition is completed to indicate that it doesn't match the trigger position of the acquisition on screen.

MODE — Selects various acquisition modes available for any given sweep speed range (see Table 3-2). Pressing the MODE button will cause the acquisition to reset, and the new mode will apply to the next acquisition to reset. The present acquisitions mode is displayed in the crt readout. If the acquisition mode selected varies from that of the current displayed acquisition, the display is italicized to indicate the mismatch. If the selected mode is not available, it will not change from the previous, legal mode. If conditions change after acquisition mode is selected that make it illegal, the mode changes to the default for new conditions.

1K/4K — Selects an acquisition record length of either one screen (1K) or four screens (4K). In either selection, the displayed waveform has 100 data points per horizontal graticule division for a single channel or 50 data points when two channels are acquired.

When a waveform is acquired using the B time base, switching between record lengths also changes the delay time position setting by the same factor of four. The B DELAY

TIME POSITION control must be repositioned to obtain the same delay.

When the 4K record length is selected, a one-screen (1K) window of the acquisition is displayed, and a bar graph is used to indicate the position of the displayed window within the 4K record. Rotate the CURSORS control to move the display window to any position within the record.

The 4K record length can be compressed to a length of 1K by rotating the Variable SEC/DIV control out of the CAL detent position. The SEC/DIV readout is adjusted to reflect the correct time per division of the displayed waveform. The acquisition record may be magnified using the X10 Magnifier.

- ④1 **CURSORS Controls**—Set and position the cursor(s) to all displayed store mode waveforms. Measurements for Delta Volts, Delta Time, One Over Delta Time, and Delay Time are made with the CURSORS controls. Positioning of the display window within a 4K acquisition record length is performed with the CURSORS Position control. See the "Crt Readout" description for the cursor readout display.

SELECT WAVEFORM Button—Selects either the acquisition waveform or (waveform pairs) and any displayed reference waveform(s) for cursor measurements. If there is no reference waveform, this button is inactive. When an acquisition control is changed, the cursors return to the acquisition waveform set. The cursor defaults to the acquisition waveform in absence of a reference waveform. If one or more reference waveforms are displayed, the waveform with the cursors attached has its readout underlined.

CURSORS Position Control—Adjusts the active cursor (or cursor pairs when there is a two-channel waveform) horizontally. Cursor positioning is active during SAVE mode, and measurements can be made on any displayed waveform. Since the reference and acquisition display windows track, cursor positions do not change when they are moved back and forth from the acquisition to the reference waveform set.

Cursors are placed on only one waveform at a time if the waveform was acquired in a single-channel acquisition (CH 1, ADD, OR CH 2) or both waveforms from a two-channel acquisition (ALT or CHOP). Cursors move from the reference waveform to the acquisition waveform when the reference waveform is turned off. The acquisition parameters of the waveform set in which the cursors are located are displayed in the crt readout. The cursor(s) movable by the CURSORS Position control (active cursor) are enclosed in a box.

When the 4K record length is selected, the position of the display window (1K) is adjusted by the instrument to provide a display of the active cursor position. If the active cursor is positioned to either edge of the display window, further positioning starts the waveform display scrolling in the opposite direction as the display-window position moves. Display-window positioning can be continued to the ends of the record, allowing observations and measurements to be made over the entire acquisition record.

SELECT C1/C2 (PUSH) Switch—Selects the cursor(s) that can be positioned by the CURSORS Position control. Cursors are activated alternately with each press of the CURSORS Position Control. The active cursor is an X enclosed in a box, and the inactive cursor is an X without a box.

- ④ **SETUP Buttons**—Selects ACQUISITION menu, DISPLAY menu, REFERENCE menu, PLOT Menu, or ADVANCED FUNCTIONS menu. Pressing one of the SETUP buttons causes a list of items to be displayed above the Menu Select buttons (mounted in the bezel under the crt). Pressing the Menu Item Select button selects the item in the list above it. The selected item is boxed. Pressing another SETUP button will replace the displayed menu with a new selected menu. To return the instrument to a non-menu STORE mode, press the menu display SETUP button a second time. New selections made in the menu are immediately saved in nonvolatile memory and recalled on

power up. For a description of the SETUP menus, see MENU SYSTEM OPERATION in this section.

SAVE REFERENCE/MENU ITEM SELECT

Refer to Figure 3-6 for location of item 43.

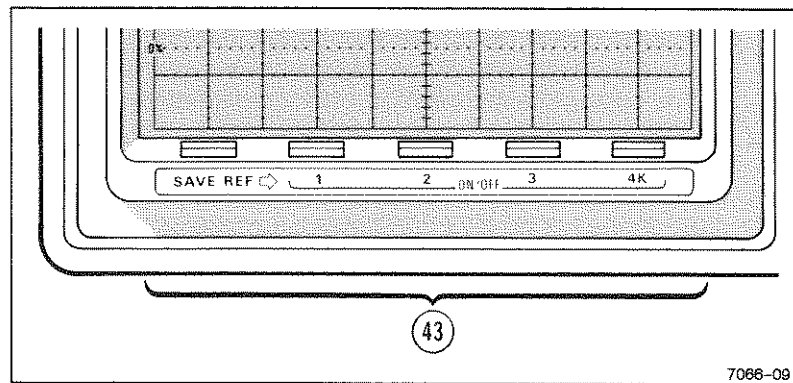

Figure 3-6. Save reference/menu items select buttons.

- ④3 **Save Reference/Menu Item Select Buttons** – When in STORE mode, the bezel buttons are used to save or recall acquired waveforms. When SETUP Menus are displayed, the bezel buttons select items from the menus.

Save Reference – Press the SAVE REF button just prior to pressing one of the Reference buttons (1, 2, 3, or 4K) to write the displayed acquisition waveform into the selected Save Reference memory. The written waveform is then displayed on the crt. Press the SAVE REF button a second time or a delay of five seconds between pressing the SAVE REF button and selecting a memory location cancels the Save Reference request.

In 4K Acquisition mode, a choice may be made to save the entire 4K acquisition or the 1K displayed window of the 4K acquisition. To save the 4K acquisition, press SAVE REF, then press 4K. The 4K record fills the Reference 1, 2, and 3 memories. To save only the 1K display window of the 4k record, press SAVE REF, then press 1, 2, or 3 to save the window in the corresponding reference memory.

Menu Item Select (SAVE REF, 1, 2, 3, and 4K)— Select items from a SETUP Menu displayed along the bottom of the screen. The selected SETUP Menu may consist of a list of items for each Menu Item Select button. An item in the Menu is selected by pressing the Menu Item Select button underneath the list. A box is used to indicate the selected item in the menu. A Menu Item Select button that has no corresponding menu list does nothing when pressed. Menu selection is accomplished by pressing one of the SETUP buttons. Menu is removed from the screen by pressing the selected SETUP Menu button second time.

REAR PANEL

Refer to Figure 3-7 for location of items 44 through 46.

- ④ **EXT Z-AXIS Input Connector**— Allows external signals to be applied to the Z-Axis circuit to control the intensity of NON-STORE waveform displays. Applied signals do not affect the display waveshape. External signals with fast rise and fall times provide the best defined intensity modulation. Noticeable intensity modulation is produced at normal viewing intensity levels by a 5 V p-p signal. The Z-Axis signals must be time-related to the trigger signal to obtain a stable intensity-modulation pattern on the displayed waveform.

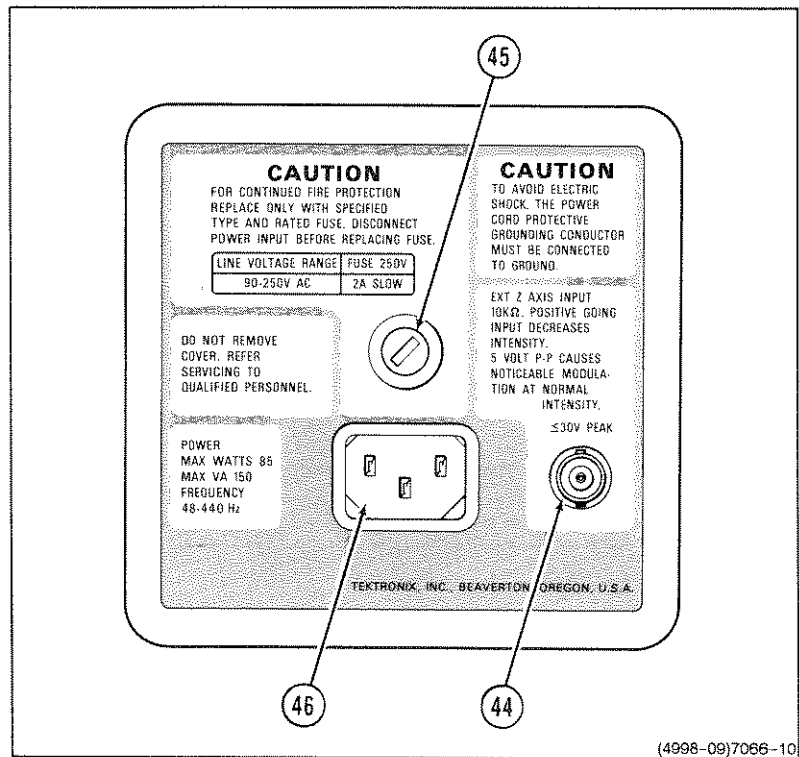

Figure 3-7. Rear panel.

- ④5 **Fuse Holder**—Contains the ac-power-source fuse. See the rear panel nomenclature for fuse rating and line voltage range.
- ④6 **Detachable Power Cord Receptacle**—Provides the connection point for the ac-power source to the instrument.

SIDE PANEL

The standard side panel includes one AUXILIARY CONNECTOR. Refer to Figure 3-8 for the location of item 47.

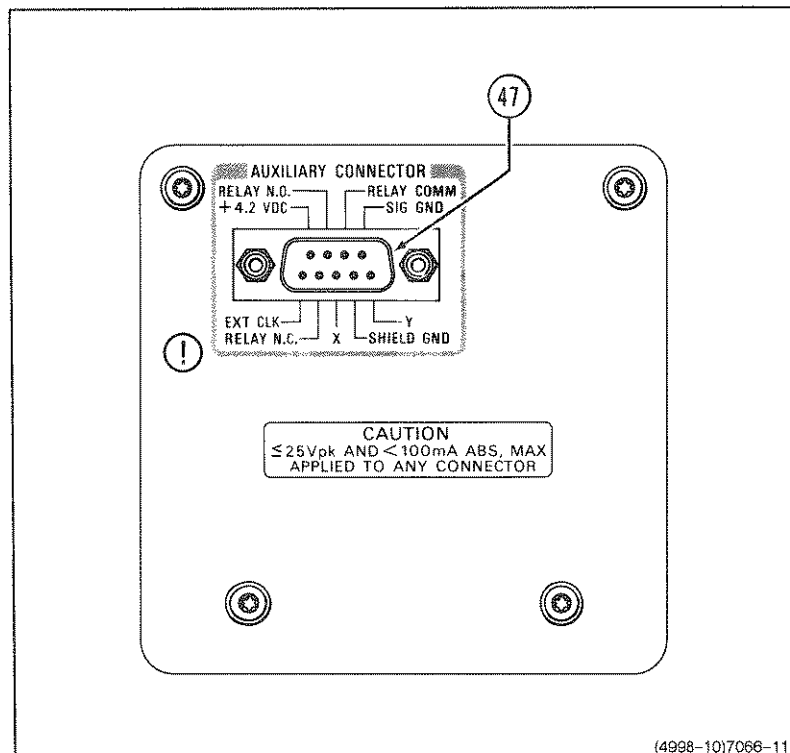

Figure 3-8. Side panel.

- ④7 **AUXILIARY CONNECTOR**—Provides connections for X-Y Plotter output and External Clock input (see Table 3-4). All connections are labeled on the side panel.

Table 3-4
Auxiliary Connector

Pin Number	Pin Name	Function
1	EXT CLK	External Clock Input
2	RELAY N.C.	Pen Lift, Normally Closed
3	X	X-Axis Output
4	SHIELD GND	Shield ground for cable
5	Y	Y-Axis Output
6	+ 4.2 Vdc	+ 4.2 Vdc output
7	RELAY N.O.	Pen Lift, Normally Open
8	RELAY COMM	Pen Lift, Relay Common
9	SIG GND	Signal Ground

NOTE

To meet EMI regulations and specifications, use the specified shielded cable and metal connector housing with the housing grounded to the cable shield for connections to the AUXILIARY CONNECTOR.

X-Y Plotter Connections — Provide connections for X-Axis output, Y-Axis output, and Pen Lift controls to drive an external X-Y Plotter (see Table 3-4). All displayed waveforms and the crt readout are transmitted over the Plotter Interface. The settling time allowed for each movement is about proportional to the distance of the movement. Connections for Signal Ground and Shield Ground are also provided for grounding between the instrument and the external X-Y Plotter. Waveforms and the Readout are plotted on the crt while a plot is in progress.

To be fully compatible, the X-Y Plotter used must have X and Y inputs with sensitivity control and penlift control.

Signals available at the AUXILIARY CONNECTOR allow the Pen Lift circuit to be wired for a plotter with either active HI or active LO drive requirements and several logic families. Examples for both an active HI and an active LO TTL drive are shown in Figure 3-9.

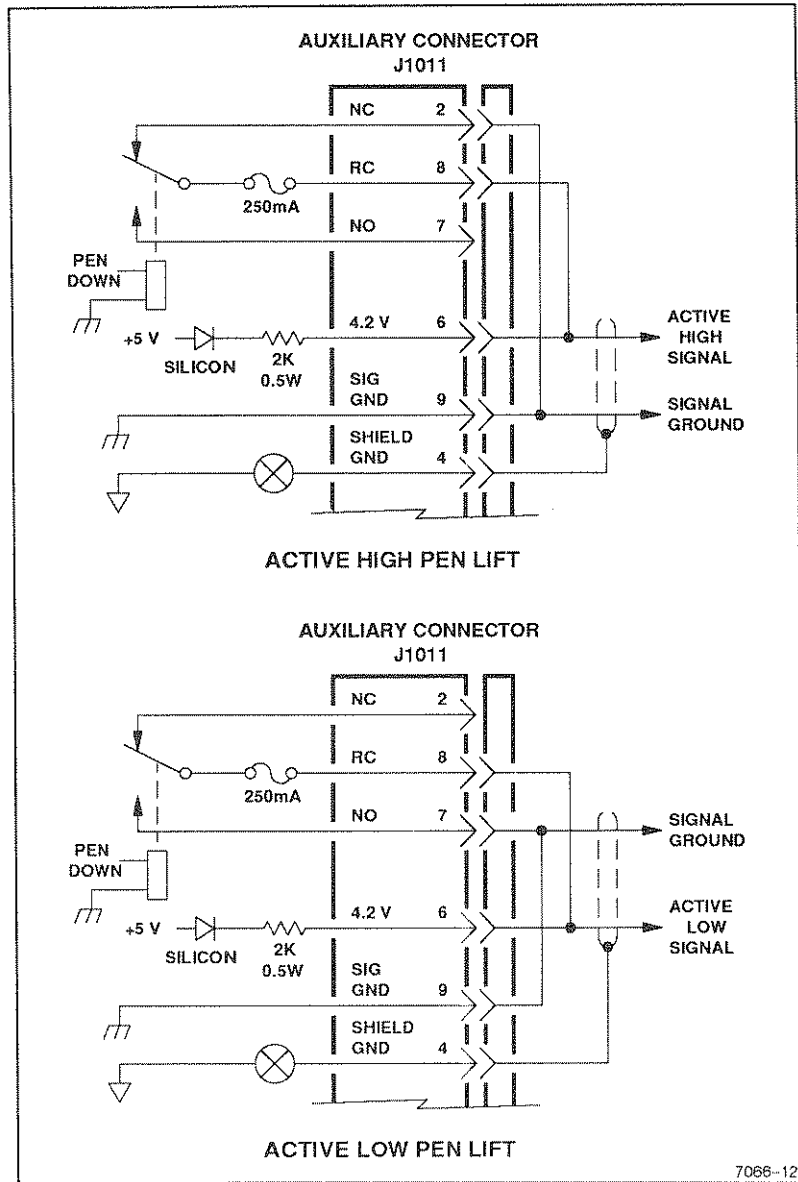

Figure 3-9. X-Y Plotter interfacing.

EXT CLK Input – Provides an input for external clock signals to the storage acquisition circuitry in conjunction with the EXT CLK position of the A SEC/DIV switch. Samples are referenced by falling edges. Input is TTL compatible. Samples become visible by pairs, as Scan or Roll. Several clocks are required before the point associated with the first clock is visible.

MENU SYSTEM OPERATION

Menus are used to control instrument setup, waveform storage, hardcopy, and diagnostic functions. Pressing one of the five SETUP buttons displays the corresponding menu on the crt. Pressing the button again returns the display to standard (non-menu) operation. Also, the display may be switched directly from one menu to another by pressing the desired SETUP button.

In a menu display, the currently selected menu item is surrounded by a box. A menu item is selected with the Menu Item Select buttons located on the crt bezel directly below each menu item (these buttons also function as the Save Reference buttons in normal operation). Successively pressing a Menu Item Select button will cycle the selection box through the choices for the item.

In some SETUP menus, one of the menu items is Cursor Knob Func. The Menu Item Select button is used to select a menu item whose value is then adjusted using the CURSORS control.

SETUP ACQ MENU

Refer to Figure 3-10 for the ACQUISITION menu display.

Acq Mode

The storage acquisition mode may be selected from the Acq Mode menu listing. However, the setting of the SEC/DIV switch, trigger

mode, and slow acquisition mode (Roll/Scan) determine which modes are applicable. If an invalid acquisition mode is selected, the default mode for the present SEC/DIV setting is used when the menu is switched off.

Also, if a valid selection is made and the SEC/DIV switch is later adjusted to a setting that does not allow that mode, the default mode is used. See Table 3-2 for the default modes determined by the SEC/DIV switch, trigger mode, and slow acquisition (Roll/Scan) settings and for the valid modes for the various SEC/DIV switch settings.

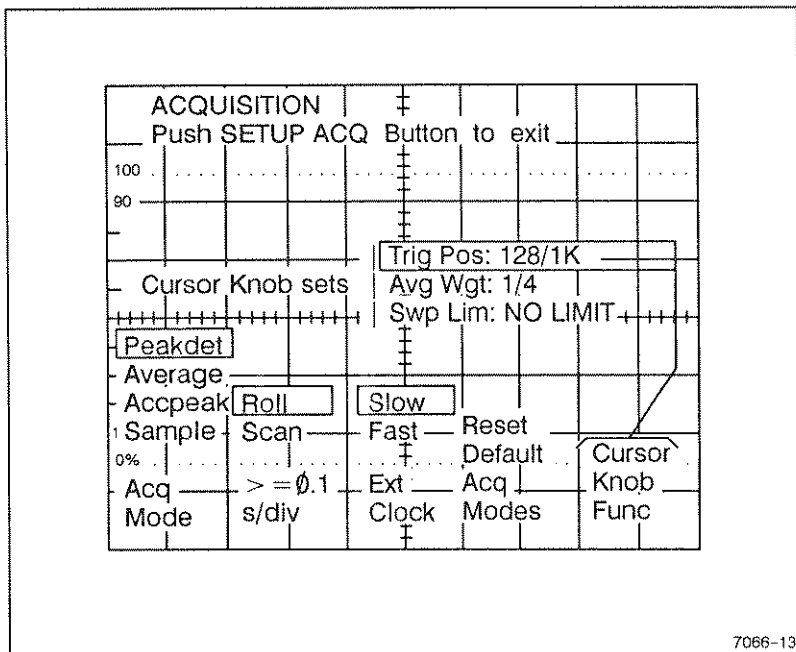

Figure 3-10. ACQUISITION menu.

Peakdet – In Peak Detect mode, the minimum and maximum levels of the input signal within the time represented by 1/50 of a division

unmagnified (1/25 of a division in CHOP or ALT) are digitized and stored in acquisition memory as a data pair. Peakdet is the default for all SEC/DIV settings slower than 2 μ s per division.

Average—Used for multiple record averaging. A normalized algorithm is used to continuously display the signal at full amplitude during the averaging process. Averaging is the default for repetitive storage mode. The amplitude resolution increases with the number of weighted acquisitions included in the display. The default weight of Average mode is 1/4. Other weights are menu-selectable (Avg Wgt) from 1/1 to 1/256 (maximum resolution is 12 bits). The number of sweeps allowed to occur before averaging stops is also menu-selectable (Swp Lim). The averaging process is reset by changing any control that causes an acquisition reset. Average mode is valid for triggered acquisitions only and is not operational in any mode that does not allow triggers (see Table 3-2).

Accpeak—Will cause displays to accumulate (accumulated Peak Detect). The largest maximum and smallest minimum sample acquisitions are retained for each trigger-referenced sample record over multiple acquisition cycles. When Accpeak is used at SEC/DIV settings between 20 μ s per division and 5 s per division, updating of maximum and minimum samples also occurs within each time-base clock period. Changing any switch that affects the acquisition parameters resets Accpeak displays. Accpeak mode is valid for triggered acquisitions only and is not operational in any mode that does not allow triggers (see Table 3-2).

Sample—In Sample mode, the signal is sampled at a rate that produces 100 samples per horizontal graticule division (50 samples per horizontal graticule division in Alternate or Chop mode).

> = 0.1 s/Div (Slow Acquisition)

Roll—Store mode that provides a continuous view of a slowly changing signal. When in the Roll mode with A TRIGGER in P-P AUTO or NORM, the scope displays data points in a continuous stream with each newly acquired data point appearing at the right

side of the graticule. As new data points are acquired, the previous data point rolls toward the left side of the graticule, creating a constant flow of data across the crt screen as new data points displace the old. The effect is similar to that of a chart recorder. Setting the A TRIGGER to SGL SWP will cause the scope to operate in the Triggered Roll mode. In Triggered Roll, the display rolls from right to left until the trigger is received. Then, the display continues rolling until the post trigger acquisition record is filled, at which time the display freezes. The default acquisition mode is Peakdet; Sample is the only other allowable acquisition mode. The Roll mode is only operational with the SEC/DIV setting at 0.1 s per division to 5 s per division or the Ext Clock in Slow.

Scan—The Scan storage mode with A TRIGGER in P-P AUTO continuously updates the display serially as each data point is acquired. Previous data is written over from left to right. With A TRIGGER set to NORM, pretrigger data is updated when a trigger is received. The waveform display then scans to the right from the trigger point to finish the post-trigger acquisition and then freezes. If the A TRIGGER is set to SGL SWP, the Scan-Roll-Scan storage mode is activated. The display scans left to right until the pretrigger record is filled, then rolls right to left until a trigger is received. It then scans left to right again to fill the post-trigger acquisition record and then freezes. The default acquisition mode for Scan is Peakdet. The Scan mode is only operational with the SEC/DIV setting at 0.1 s per division to 5 s per division or the Ext Clock in Slow.

Ext Clock

Slow—Sets the Ext Clock mode to Roll or Scan (Ext Clock rates from DC to 1 kHz). This mode displays the waveform as it is acquired.

Fast—Sets the Ext Clock mode to Slow RECORD (Ext Clock rates from DC to 100 kHz). This mode displays the waveform only when an entire waveform record has been acquired.

Reset Default Acq Modes

Resets the ACQUISITION settings to the following defaults:

Trig Pos: 128/1K (both the trigger position and record length are reset)
Avg Wgt: 1/4
Swp Lim: NO LIMIT
Acq Mode: Determined by SEC/DIV setting. Refer to Table 3-2 for default modes.

> = 0.1 s/div
(Slow Acq): Roll
Ext Clock: Slow

Cursor Knob Func

Selects a menu item whose value is then set with the CURSORS control. Trig Pos is the number of points acquired prior to the trigger; it may be set in increments of four from 4 to 1020 for a 1K record or from 16 to 4080 for a 4K record. Avg Wgt is the weight of the last sample in the Average acquisition mode; it is adjustable from 1/1 to 1/256. Swp Lim selects the number of acquisitions before the acquisition system halts; it is adjustable from 1 to 999,000 or NO LIMIT.

SETUP DISPLAY MENU

Refer to Figure 3-11 for the DISPLAY menu.

ΔT Display

Selects either ΔT (time measurement) or $1/\Delta T$ (frequency measurement) for the cursors display in the crt readout.

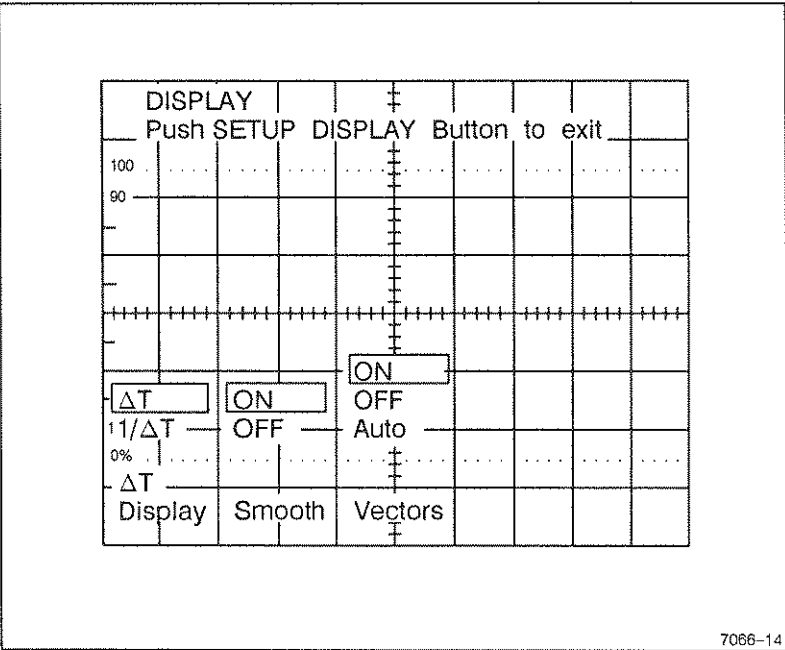

Figure 3-11. DISPLAY menu.

Smooth

Determines the process that is used to produce vector displays when in Peakdet or Accpeak acquisition modes. With Smooth OFF, no reordering of the data points is done, and vectors are given between all of the minimum and maximum data points. With Smooth ON, data points are reordered for correct slope and interpolated for drawing a smooth waveform. Smoothing looks at the change in value of reordered data points between adjacent sample intervals. If the change in value does not exceed certain limits, the values are interpreted as a continuous slope for drawing either vectors or dots. If the value change exceeds the interpreted "no-change" limit, the data point value is not modified, and the vectors drawn in the display show a discontinuity in the waveform. This method of display of the waveform data provides a smoothed display of the waveform, yet

retains the glitch-catching capabilities of Peakdet or Accpeak modes. Smoothing applies only to Peakdet and Accpeak modes.

Vectors

Selects Vectors ON, OFF, or Auto acquisition waveform display mode. The selection applies to the next acquisition. With Vectors ON, vectors are used for all acquisition modes. Vectors OFF displays dots in all modes. Vectors Auto mode selects vectors for all modes except repetitive sampling and X-Y storage modes.

SETUP REF MENU

The REFERENCE menu consists of two menu displays, NVmem and Format. The SAVE REF Menu Item Select button toggles between the displays.

REFERENCE MENU (NVMEM)

The non-volatile memory provides 26 Kbytes of waveform storage space. Waveforms stored in the non-volatile memory may be protected from overwriting or deleting. The memory is divided into locations REFA through REFZ, but the number of actual waveforms that may be stored depends on the saved waveform record length (1024 words or 4096 words) and acquisition mode. Averaged waveforms require 2 bytes for each point so that an averaged 1K waveform needs 2 Kbytes of non-volatile SAVE REF storage and an averaged 4K waveform needs 8 Kbytes. Specifications for the non-volatile memory are listed in Table 7-1. Refer to Figure 3-12 for the REFERENCE menu display with NVmem selected.

The status of the reference memories is displayed by the readout (1, 2, 3, 4K, and A through Z). The number below each memory location indicates the amount in Kbytes of the memory used (1, 2, 4, or 8). If the memory location is protected, this number is highlighted (intensified). A downward pointing arrow below the number indicates that the memory is selected as the Source; an upward-pointing arrow indicates that the memory is selected as the Destination (see Cursor Knob Func). The FREE readout indicates the amount of unused (free) non-volatile memory.

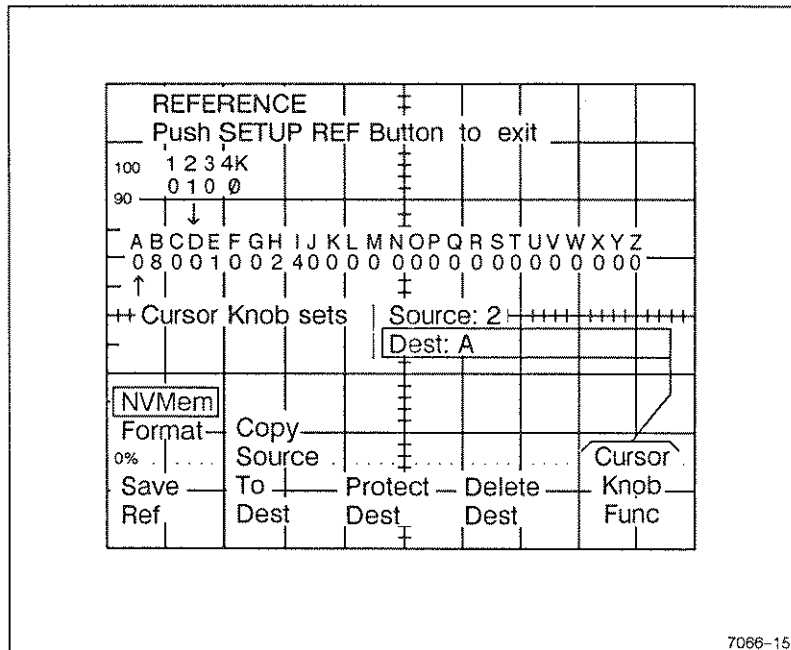

Figure 3-12. REFERENCE menu (NVmem selected).

Save Ref

Toggles between NVmem and Format menu displays.

Copy Source To Dest

Copies one SAVE REF memory to another memory location. Waveforms stored in the lettered non-volatile memory locations (REFA through REFZ) must be moved to one of the numbered SAVE REF memory locations to be displayed. Waveform data to be retrieved from or written to a non-volatile memory location must go through a SAVE REF memory.

Protect Dest

Protects or unprotects the selected memory destination (REFA through REFZ). Protected memory locations cannot be overwritten or deleted. Via an optional Communications interface, non-volatile memory locations may be permanently protected to prevent them from being overwritten by the Delete Dest menu function. A protected memory location has its size highlighted (intensified) in the readout display.

Delete Dest

Erases the stored data in the selected reference memory, if not protected.

Cursor Knob Func

Selects a menu item whose value is then set with the CURSORS control.

Source – Rotating the CURSOR control selects the memory location to be copied (REFA through REFZ, REF1 through REF3, and REF4K).

Dest – Rotating the CURSOR control selects the destination for the data. The destinations are REFA through REFZ, REF1 through REF3, and REF4K. Also, selects the memory location to be protected or deleted.

REFERENCE MENU (FORMAT)

The Format menu provides vertical positioning, vertical gain, and horizontal magnification adjustments for waveforms in the SAVE REF (1-3 and 4K) memories. Refer to Figure 3-13 for the REFERENCE menu display with Format selected.

Save Ref

Toggles between NVmem and Format menus.

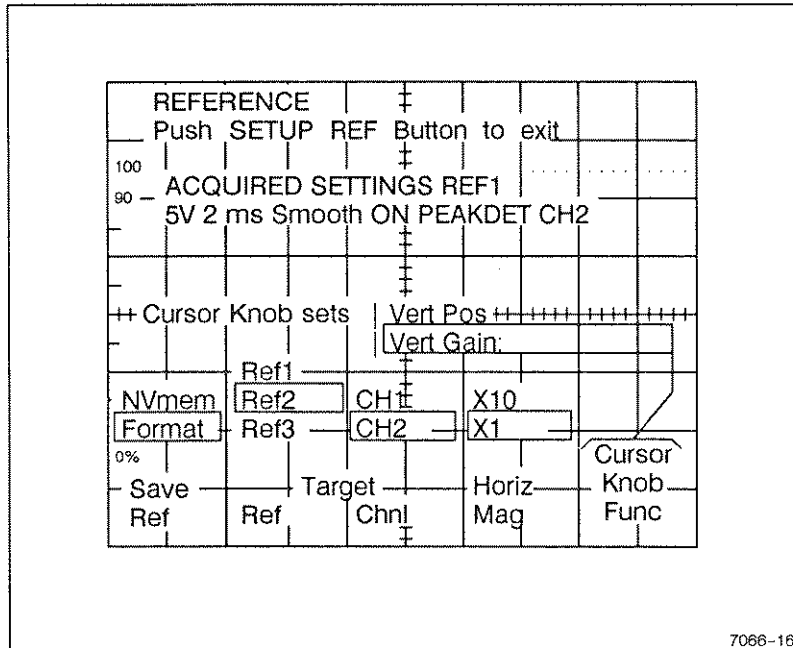

Figure 3-13. REFERENCE Menu (Format selected).

Target Ref

Selects one of the reference memories for formatting. If no waveform is saved in the selected reference memory, a "No signal acquired" message is displayed. If no signal is acquired, Horiz Mag, Vert Pos, and Vert Gain cannot be adjusted.

Target Chnl

Selects CH 1 or CH 2 for formatting. If no waveform has been saved for the selected channel, a "No signal acquired" message is displayed.

Horiz Mag

Toggles horizontal magnification of the selected save reference memory between X1 and X10.

Cursor Knob Func

Selects a menu item whose value is then set with the CURSORS control. Vert Pos allows adjustment of the vertical position of the selected save reference memory. Vert Gain allows adjustment of the vertical gain of the selected save reference memory.

SETUP PLOT MENU

Refer to Figure 3-14 for the PLOT menu display.

Plotter Type

Selects an analog X-Y or digital plotter output format. The possible formats are:

- XY** – Analog X-Y plotter
- HPGL** – Hewlett-Packard Graphics Language
- EPS7** – Epson low-speed double-density
- EPS8** – Epson high-speed double-density
- TJET** – Hewlett-Packard ThinkJet

Only the XY selection is valid unless a GPIB or RS-232 communications option is installed.

Grat

Enables or disables plotting of the graticule. With Grat ON selected, a graticule is plotted each time a manual plot is started. With ON selected for both Grat and Auto Plot, the graticule is plotted only once (on the first acquisition after the Auto Plot mode is entered). With Grat OFF selected, the graticule is not plotted.

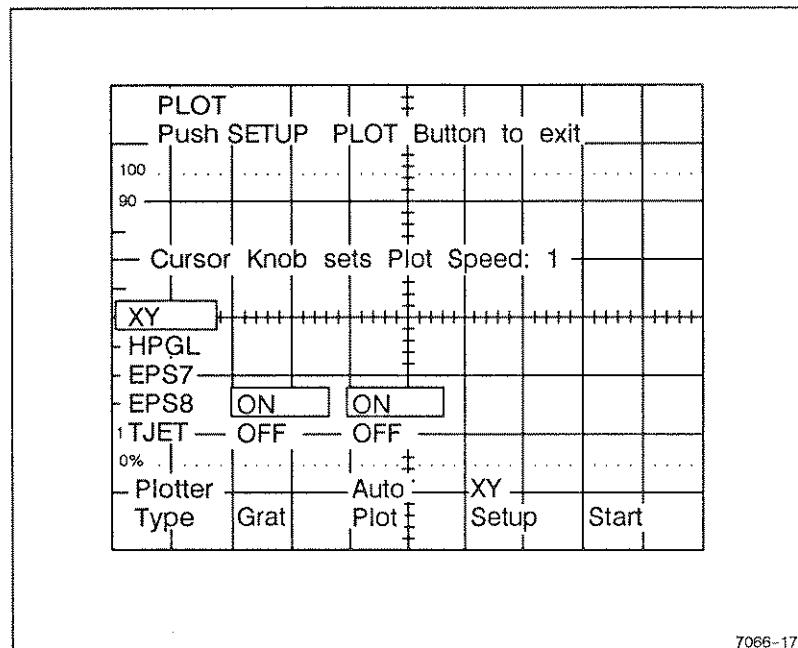

Figure 3-14. PLOT menu.

Auto Plot

Toggles Auto Plot ON or OFF. In Auto Plot, a plot is started each time an appropriate number of acquisitions is acquired. Upon selecting Auto Plot ON:

1. A waveform is acquired.
2. Plotting begins.
3. On the first plot, the graticule (if on) and waveform are drawn first, then the readout (if on).
4. The instrument then acquires another waveform and plots only the newly acquired data.
5. Acquisitions and waveform plots continue as long as valid triggers are available.

XY Setup

Generates a pattern to facilitate calibration of analog X-Y plotter gain and offset.

Start

Initiates the transmission of a waveform over the X-Y plotter output or communications option.

Plot Speed (analog X-Y plotter only)

The CURSORS knob adjusts the plotter pen speed from 1 through 10 (the units are approximately in divisions per second).

SETUP ADV FUNCT MENU

Refer to Figure 3-15 for the ADVANCED FUNCTIONS menu display.

Diag Menu

Controls the selection of diagnostic tests, calibration aids and exercisers used to service the instrument. Detailed menu information is contained in the 2232 service manual.

Comm Menu

This menu is active only if an RS-232 communications option is installed. For further information, refer to OPTION 12 RS-232-C OPERATORS INFORMATION in Section 8.

Save Pwr Up Setting

Saves the state of the software-controlled front panel settings and menu settings for recall at power up.

Factory Reset

Resets to the factory default acquisition, processing, and display modes for all sweep speeds.

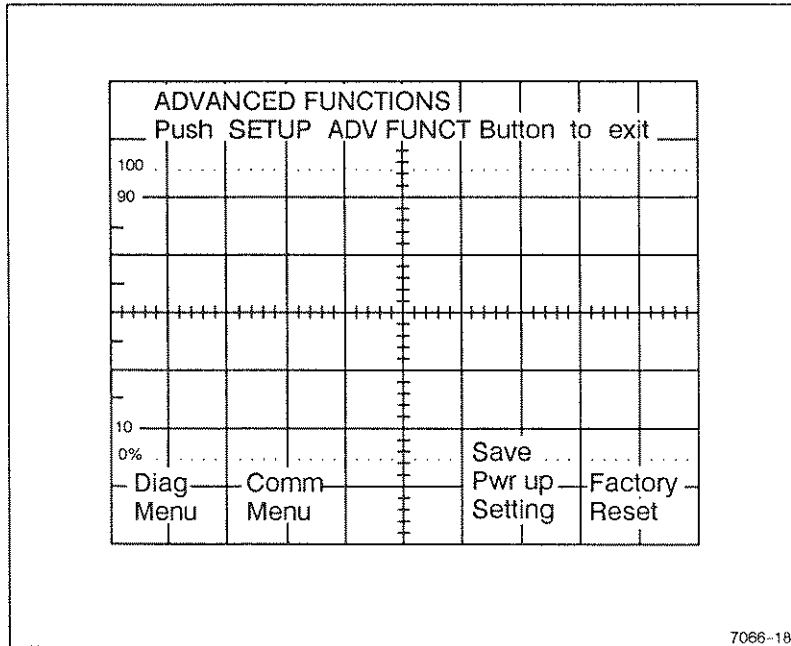

Figure 3-15. ADVANCED FUNCTIONS menu.

CRT READOUT

The readout system provides an alphanumeric display of information on the crt along with the waveform displays. The readout (non MENU) is displayed in four rows of characters. Two rows are within the top graticule division, and two rows are within the bottom graticule division. The locations and types of information displayed under normal operating modes are illustrated in Figure 3-16.

NON-STORE Mode

In NON-STORE mode the settings of the CH 1 and CH 2 VOLTS/DIV, A AND B SEC/DIV, and AC-GND-DC input coupling switches are

displayed. If either BOTH or B is selected for HORIZONTAL MODE, a readout of the B DELAY TIME POSITION is displayed.

Also, the A TRIGGER LEVEL voltage is displayed when the A & B SOURCE switch is in the VERT MODE, CH 1, or CH 2 position. If the VOLTS/DIV switches are in the uncalibrated position, the trigger level voltages are displayed as percentages.

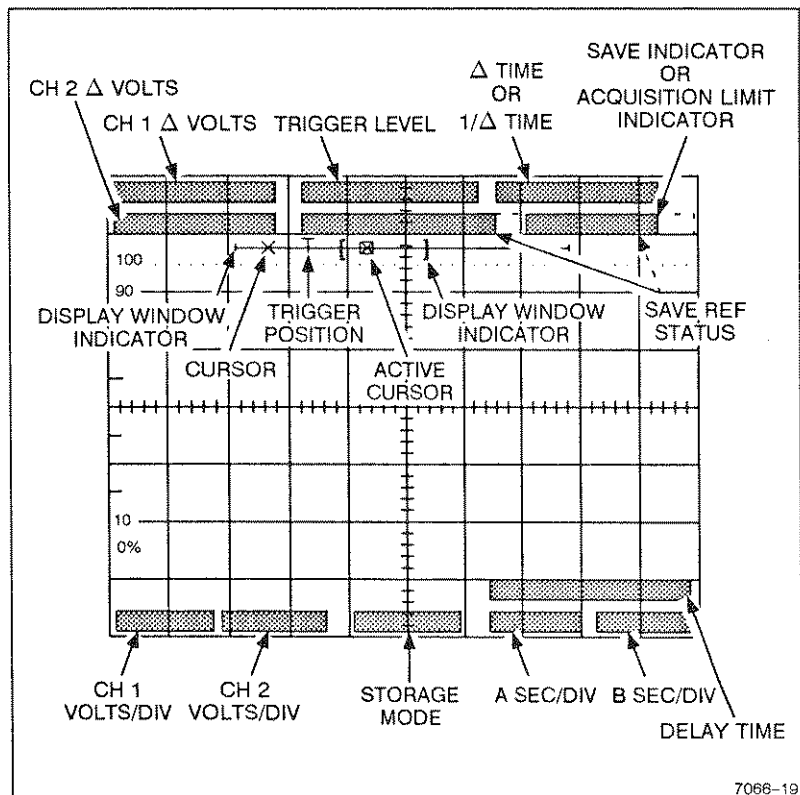

Figure 3-16. Crt readout display.

With the A & B SOURCE switch in VERT MODE, the CH 1-BOTH-CH 2 Vertical MODE switch determines which trigger level voltage is displayed. In the BOTH position, a trigger level readout is present only if both the VOLTS/DIV switches and both the input coupling switches are at the same settings. With BOTH and ADD or CHOP Vertical MODE selected, a trigger level readout (TRIG) with no channel specified is displayed. If BOTH and ALT Vertical MODE is selected, the trigger level voltage readout alternates between CH 1 and CH 2 trigger level voltages.

If the A & B SOURCE switch is in the CH 1 or CH 2 position, the corresponding trigger level readout is displayed. No trigger level readout is displayed if the switch is in the A EXT position or if A COUPL switch is set to A LINE SOURCE.

To provide complete parametric data for a waveform display, especially useful when a hard copy is made to maintain a permanent record, the following symbols may appear in the readout:

Greater-than symbols (>) are used to indicate uncalibrated VOLTS/DIV and A AND B SEC/DIV switch settings.

A down-arrow symbol (↓) is used in front of the CH 2 VOLTS/DIV readout to indicate the CH 2 INVERT switch is depressed.

BWL is displayed if the Vertical MODE BW LIMIT switch is depressed.

The AC-GND-DC input coupling selection is indicated in the associated VOLTS/DIV readout with a tilde symbol (~) above the volts symbol for AC, a ground symbol (⏏) for GND, and no symbol for DC input coupling.

The A TRIG LEVEL voltage readout displays a tilde symbol (~) above the volts symbol if the A COUPL switch is set to LF REJ or if the trigger source channel input coupling is AC.

STORE Mode

In the STORE mode, additional parameters associated with the stored waveforms are displayed in the crt readout.

If the acquisition record length is longer than one screen, a bar graph is displayed to indicate the position of the display window within the acquisition record. The displayed portion of the record is enclosed in brackets. On the bar graph, the cursor positions are indicated with X's and the trigger position is marked with a large T.

When one or more of the SAVE REF waveforms are displayed, a readout of the waveform reference number is displayed. If the SAVE REF button on the crt bezel is pressed, a SAVE REF readout is temporarily displayed indicating the status of the SAVE REF memories (FULL or EMPTY).

The cursor readout displays the voltage difference (either $\Delta V1$ or $\Delta V2$) and the time difference (either ΔT or $1/\Delta T$) between cursors.

The storage acquisition mode is displayed; it is underlined if smoothing is active.

If the VOLTS/DIV control is switched beyond the available expansion or compression range, the VOLTS/DIV readout is tilted, indicating that the VOLTS/DIV switch setting and the VOLTS/DIV readout no longer agree.

In 4K COMPRESS (SEC/DIV in uncalibrated mode), a **c** is displayed in front of the SEC/DIV readout.

When ACQUISITION SAVE is selected, the readout displays a save indicator (SAVE).

If a sweep limit value (other than NO LIMIT) is set, an incrementing count of the sweeps is displayed; when the sweep limit is reached, the readout displays LIMIT.

When making ground-referenced ΔV measurements (ground dot displayed and the cursor positioned on the ground dot), the Δ symbol is replaced by a ground symbol \perp .

SECTION 4

**OPERATING
CONSIDERATIONS**

2232 Operators

BASIC OPERATION

This subsection contains basic operating information and techniques that should be considered before attempting to make any measurements with the instrument. For locations and functions of instrument controls, connectors, and indicators refer to **CONTROLS, CONNECTORS, AND INDICATORS** (Section 3 of this manual).

GRATICULE

The graticule is internally marked on the faceplate of the crt to eliminate parallax-viewing errors, increasing measurement accuracy (see Figure 4-1). The graticule is marked with eight vertical and ten horizontal major divisions. In addition, each major division is divided into five subdivisions. The vertical deflection factors and horizontal timing are calibrated to the graticule so that accurate measurements can be made directly from the crt. Also, percentage marks for the measurement of rise and fall times are located on the left side of the graticule.

GROUNDING

The most reliable signal measurements are made when the oscilloscope and the unit under test are connected by a common reference (ground lead) in addition to the signal lead or probe. The probe's ground lead provides the best grounding method for signal interconnection and ensures the maximum amount of signal-lead shielding in the probe cable. A separate ground lead can also be connected from the unit under test to the oscilloscope GND receptacle located on the oscilloscope's front panel.

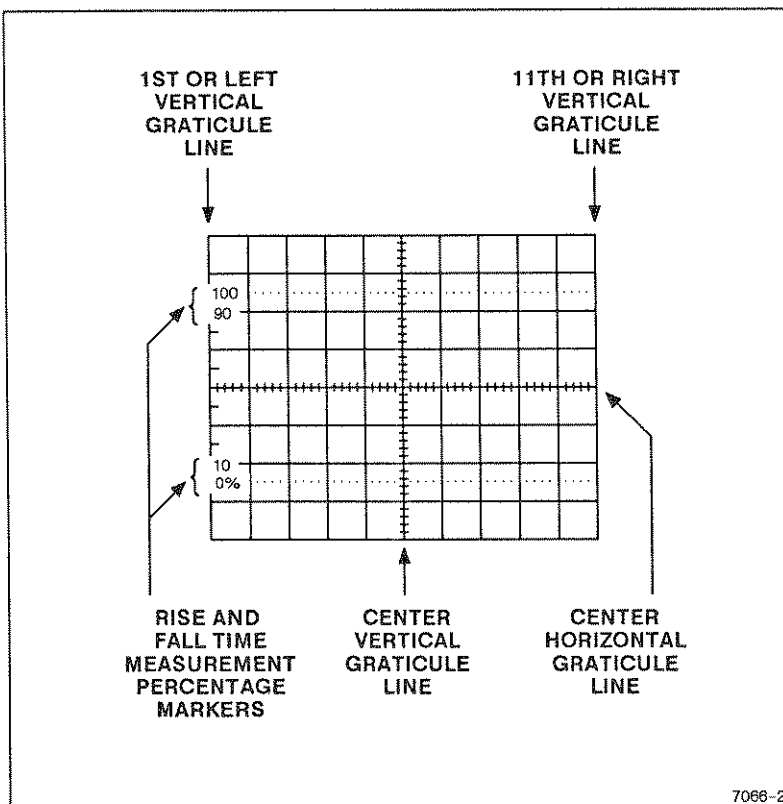

Figure 4-1. Graticule measurement markings.

SIGNAL CONNECTIONS

Probes

Generally, the accessory probes supplied with the instrument provide the most convenient means of connecting a signal to the vertical inputs of the instrument. The probe and probe lead are shielded to prevent pickup of electromagnetic interference, and the 10X attenuation factor of the probe offers a high input impedance that minimizes signal loading in the circuitry under test. The attenuation factor of the

standard accessory probe is coded so that the VOLTS/DIV readout seen on the crt is automatically switched to the correct scale factor when the probe is attached. Both the probe itself and the probe accessories should be handled carefully at all times to prevent damage to them. Avoid dropping the probe body. Striking a hard surface can cause damage to both the probe body and the probe tip. Exercise care to prevent the cable from being crushed or kinked. Do not place excessive strain on the cable by pulling. The standard-accessory probe is a compensated 10X voltage divider. It is a resistive voltage divider for low frequencies and a capacitive voltage divider for high-frequency signal components. Inductance introduced by either a long signal or ground lead forms a series-resonant circuit. This circuit will affect system bandwidth and will ring if driven by a signal containing significant frequency components at or near the circuit's resonant frequency. Oscillations (ringing) can then appear on the oscilloscope waveform display and distort the true signal waveshape. Always keep both the ground lead and the probe signal-input connections as short as possible to maintain the best waveform fidelity.

Misadjustment of probe compensation is a common source of measurement error. Due to variations in oscilloscope input characteristics, probe compensation should be checked and adjusted, if necessary, whenever the probe is moved from one oscilloscope to another or between channels. See the probe compensation procedure in Operator's Check and Adjustments, or consult the instructions supplied with the probe.

Coaxial Cables

Cables may also be used to connect signals to the vertical input connectors, but they may have considerable effect on the accuracy of a displayed waveform. To maintain the original frequency characteristics of an applied signal, only high-quality, low-loss coaxial cables should be used. Coaxial cables should be terminated at both ends in their characteristic impedance. If this is not possible, use suitable impedance-matching devices.

INPUT-COUPLING CAPACITOR PRECHARGING

When the Input Coupling switch is set to the GND position, the input signal is connected to ground through the input-coupling capacitor and a high resistance value. This series combination forms a precharging circuit that allows the input-coupling capacitor to charge to the average dc voltage level of the signal applied to the input connector. Thus, any large voltage transients that may accidentally be generated are not applied to the vertical amplifier's input when the input coupling is switched from GND to AC. The precharging network also provides a measure of protection to the external circuitry by reducing the current level that is drawn from the external circuitry while the input-coupling capacitor is charging.

If AC input coupling is in use, the following procedure should be followed whenever the probe tip is connected to a signal source having a different dc level than that previously applied. This procedure becomes especially useful if the dc-level difference is more than ten times the VOLTS/DIV switch setting.

1. Set the AC-GND-DC (input coupling) switch to GND before connecting the probe tip to a signal source.
2. Touch the probe tip to the oscilloscope GND connector.
3. Wait several seconds for the input-coupling capacitor to discharge.
4. Connect the probe tip to the signal source.
5. Wait several seconds for the input-coupling capacitor to charge to the dc level of the signal source.
6. Set the AC-GND-DC switch to AC. A signal with a large dc component can now be vertically positioned within the graticule area, and the ac component of the signal can be measured in the normal manner.

SECTION 5

**OPERATOR'S
CHECKS AND
ADJUSTMENTS**

2232 Operators

INTRODUCTION

To verify the operation and basic accuracy of your instrument before making measurements, perform the following checks and adjustment procedures. If adjustments are required beyond the scope of these operator's checks and adjustments, refer the instrument to qualified service personnel.

For new equipment checks, before proceeding with these instructions, refer to "Preparation for Use" in this manual to prepare the instrument for the initial start-up before applying power.

INITIAL SETUP

1. Verify that the POWER switch is OFF (switch is in the out position), then plug the power cord into the ac power outlet.
2. Press in the POWER switch (ON) and set the instrument controls to obtain a baseline trace:

Display

A and B INTENSITY	Midrange
STORAGE/READOUT	
INTENSITY	Midrange (with READOUT on)
FOCUS	Best defined display

Vertical (Both Channels)

POSITION	Midrange
MODE	CH 1
X-Y	Off (button out)
BW LIMIT	On (button in)
VOLTS/DIV	2 mV
VOLTS/DIV Variable	CAL detent
INVERT	Off (button out)
AC-GND-DC	DC

Operator's Checks and Adjustments

Horizontal

POSITION	Midrange
MODE	A
A SEC/DIV	20 μ s
SEC/DIV Variable	CAL detent
X10 Magnifier	Off (knob in)

A Trigger

VAR HOLDOFF	NORM
Mode	P-P AUTO
SLOPE	Positive (button out)
LEVEL	Midrange
A&B SOURCE	VERT MODE
A COUPL	NORM

Storage

STORE/NON-STORE	NON-STORE (button out)
-----------------	------------------------

3. Adjust the INTENSITY and FOCUS controls for the desired display brightness and best focused trace.
4. Adjust the Vertical and Horizontal POSITION controls to position the trace within the graticule area.
5. Allow the instrument to warm up for 20 minutes before commencing the adjustment procedures. Reduce the INTENSITY levels during the waiting time.

TRACE ROTATION ADJUSTMENT

NOTE

Normally, the trace will be parallel to the center horizontal graticule line, and TRACE ROTATION adjustment is not required.

1. Preset the instrument controls and obtain a baseline trace as described in "Initial Setup."

2. Use the Channel 1 POSITION control to move the baseline trace to the center horizontal graticule line.
3. If the baseline trace is not parallel to the center horizontal graticule line, use a small-bladed screwdriver or alignment tool to adjust the TRACE ROTATION control to align the trace with the graticule line.

PROBE COMPENSATION

Misadjustment of probe compensation is a source of measurement error. The attenuator probes are equipped with a compensation adjustment. To ensure optimum measurement accuracy, always check probe compensation before making measurements. Probe compensation is accomplished by:

1. Preset the instrument controls and obtain a baseline trace as described in "Initial Setup."
2. Connect the two 10X probes (supplied with the instrument) to the CH 1 OR X and CH 2 OR Y input connectors. Observe that the CH 1 VOLTS/DIV readout changes from 5 mV to 50 mV when the 10X probe is attached to the CH 1 OR X input.
3. Connect the Channel 1 probe to the PRB ADJ connector.
4. Use the CH 1 POSITION control to vertically center the display. If necessary, adjust the A TRIGGER LEVEL control to obtain a stable display on the plus Positive Slope.
5. Check the waveform display for overshoot and rounding (see Figure 5-1); if necessary, use a small-bladed screwdriver to adjust the probe compensation for a square front corner on the waveform.

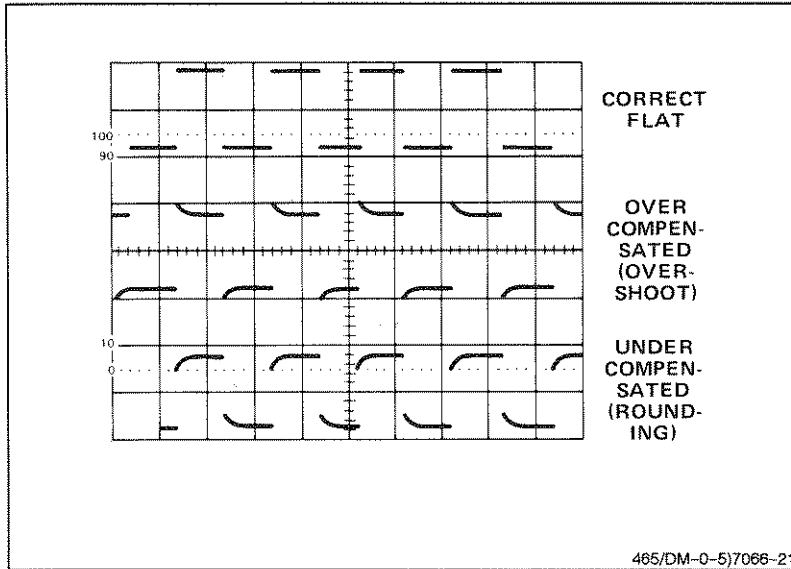

Figure 5-1. Probe compensation.

6. Remove the Channel 1 probe from the PRB ADJ connector.
7. Connect the Channel 2 probe to the PRB ADJ connector.
8. Set the VERTICAL MODE to CH 2.
9. Set the A TRIGGER A & B SOURCE switch to CH 2.
10. Use the CH 2 POSITION control to vertically center the display.
11. Check the waveform display for overshoot and rounding (see Figure 5-1); if necessary, use a small-bladed screwdriver to adjust the probe compensation for a square front corner on the waveform.

NOTE

Refer to the instruction manual supplied with the probe for more complete information on the probe and probe compensation.

HORIZONTAL ACCURACY CHECK

A check of the horizontal timing can be made using the time measurement capability of the CURSOR measurement mode:

1. Preset instrument controls and obtain a baseline trace as described in "Initial Setup".

2. Set:

CH 1 AC-GND-DC	GND
STORE/NON STORE	STORE (button in)
A SEC/DIV	1 ms
TRIG POS	POST TRIG

3. Turn the Horizontal POSITION control to align the start of the trace to the first vertical graticule line.

4. Turn the Vertical POSITION control to align the baseline trace with the center horizontal graticule line.

5. Position the active cursor to the second vertical graticule line using the CURSORS control.

6. Push in the CURSORS control knob to activate the other cursor.

7. Position the active cursor to the tenth vertical graticule line using the CURSORS control for a spacing of eight divisions between cursors.

8. Check that the Delta Time readout is 7.84 ms and 8.16 ms.

9. Verify that the CH 1 probe tip is in the PRB ADJ connector.

10. Set the CH 1 AC-GND-DC switch to DC.

11. Adjust the SEC/DIV switch setting for a display of at least one full period of the probe adjust signal (0.1 or 0.2 ms per division).

12. Use the Vertical and Horizontal POSITION controls to center the display.

Operator's Checks and Adjustments

13. Use the CURSORS control and the SELECT C1/C2 switch (push in the CURSORS control knob) to align the cursors with the rising edges of the PRB ADJ signal (measurement is of the probe adjust signal period). Note the cursor time difference readout and the graticule measurement (horizontal distance between rising edges as taken from the graticule markings) of the signal for later reference.
14. Check that the cursor readout of the probe adjust signal period and the graticule measurement of the calibrator period are within 2%.
15. Set the STORE/NON-STORE switch to the NON-STORE position (button out).
16. Determine the horizontal graticule measurement of the probe adjust signal period. Note the reading for later reference.
17. Check that the NON-STORE Mode probe adjust signal period measurement obtained from the graticule markings is within 3% of the STORE Mode probe adjust signal period obtained in step 8.
18. Set the X10 MAG switch to on (pull variable SEC/DIV knob out) and set the A SEC/DIV switch setting to obtain a display of at least one full period of the probe adjust signal (0.1 or 0.2 ms per division).
19. Check that the magnified NON-STORE Mode probe adjust signal period measurement obtained from the graticule markings is within 4% of the STORE Mode probe adjust signal period obtained in step 8.

SECTION 6

**BASIC
APPLICATIONS**

2232 Operators

INTRODUCTION

The procedures in this section enable the operator to make basic measurements using the capabilities of the oscilloscope. Many of these measurements can be obtained with either the non-storage mode or one of the storage modes. After becoming familiar with the capabilities of the instrument, the operator can choose the best method for making a particular measurement. Read the Operating Considerations part of this manual for information on signal connections, grounding, and other general operating information that may be useful in your application.

When the procedures call for obtaining a baseline display, refer to Initial Setup in the Operator's Checks and Adjustments part of this manual. The initial control settings listed in the Initial Setup procedure are considered as the initial control setup. Alternate control settings are usually required for making a specific measurement. The operator must determine the correct control settings applicable to VOLTS/DIV, SEC/DIV, TRIGGER, and other controls to obtain a stable display of the desired display. Only the readouts necessary for each specific example are shown in their associated illustrations.

OSCILLOSCOPE DISPLAYS

The following procedures will allow the operator to set up and operate the instrument to obtain the most commonly used oscilloscope displays. Verify that the POWER switch is OFF (push button out), then plug the power cord into the ac-power-input source outlet.

NON-STORE DISPLAYS

The following procedures are used to obtain the most commonly used conventional oscilloscope displays.

Normal Sweep Display

1. Preset the instrument controls and obtain a baseline display.
2. Using the supplied 10X probe or a properly terminated coaxial cable, apply a signal to the CH 1 OR X input connector. The signal source output impedance determines the termination required when using a coaxial cable to interconnect test equipment.

NOTE

Instrument warm up time required to meet all specification accuracies is 20 minutes.

3. Advance the A INTENSITY control until the display is visible. If the display is not visible with the INTENSITY control at midrange, press the BEAM FIND push button and hold it in while adjusting the Channel 1 VOLTS/DIV switch to reduce the vertical display size. Center the compressed display using the Vertical and Horizontal POSITION controls. Release the BEAM FIND push button.
4. Set the Channel 1 VOLTS/DIV switch and the Vertical and Horizontal POSITION controls to locate the display within the graticule area.
5. Adjust the A TRIGGER LEVEL control for a stable, triggered display.
6. Set the A SEC/DIV switch for the desired number of cycles of displayed signal. Then adjust the FOCUS control for the best defined display.

Magnified Sweep Display

1. Preset the instrument controls and obtain a baseline display.
2. Adjust the Horizontal POSITION control to move the area to be magnified to within the center crt graticule division (0.5 division on each side of the center vertical graticule line). Change the SEC/DIV switch setting as required.

3. Pull out the SEC/DIV Variable knob and adjust the Horizontal POSITION control for precise positioning of the magnified display.
4. To calculate the magnified sweep rate, divide the SEC/DIV switch setting by 10.

B Delayed Sweep Display

1. Preset the instrument controls and obtain a baseline display.
2. Set the HORIZONTAL MODE switch to BOTH and the B TRIGGER LEVEL control to B RUNS AFTER DLY.
3. Pull out the B SEC/DIV knob to unlock it from the A SEC/DIV knob and turn it clockwise from the counterclockwise stop until the intensified zone is the desired length. Adjust the A INTENSITY and B INTENSITY controls as required to make the intensified zone distinguishable from the remainder of the display.
4. Adjust the B DELAY TIME POSITION control to move the intensified zone to cover the portion of the A trace that is to be displayed on the B trace.
5. Set the HORIZONTAL MODE switch to B. The intensified zone adjusted in steps 3 and 4 is now displayed as the B trace at the sweep rate indicated by the B SEC/DIV switch.
6. A more stable display with less jitter may be obtained by adjusting the B TRIGGER LEVEL control for a triggered B Sweep.

NOTE

The B DELAY TIME POSITION control will not provide continuously variable delay when the B TRIGGER LEVEL control is set to a position other than B RUNS AFTER DLY. Also, differential time measurements are invalid when the B TRIGGER LEVEL control is not set to B RUNS AFTER DLY.

Alternate Horizontal Sweep Display

1. Preset the instrument controls and obtain a baseline display.
2. Set the HORIZONTAL MODE switch to BOTH and the B TRIGGER LEVEL control to B RUNS AFTER DLY.

NOTE

Two traces will be visible; the A trace with an intensified zone, and the B delayed trace without the intensified zone.

3. Adjust the Channel 1 POSITION control and the A/B SWP SEP control as required to display the A trace above the B trace.
4. Pull out the B SEC/DIV knob to unlock it from the A SEC/DIV knob and turn it clockwise to the desired B Sweep rate.
5. Adjust the A and the B INTENSITY controls as required to make the intensified zone distinguishable on the A trace and to set the B trace intensity to the desired brightness.
6. Adjust the B DELAY TIME POSITION control to move the intensified zone to cover the portion of the A trace that is to be displayed on the B trace.

X-Y Display

1. Preset the instrument controls and obtain a baseline display.
2. Rotate the A INTENSITY control fully counterclockwise and disconnect the CH 1 input signal.
3. Use two coaxial cables or probes of equal delay and apply the vertical signal (Y-axis) to the CH 2 OR Y input connector and horizontal signal (X-axis) to the CH 1 OR X input connector.
4. Set the VERTICAL MODE switch to X-Y (button in).

5. Advance the A INTENSITY control until the display is visible. If the display is not visible with the A INTENSITY control at midrange, press and hold in the BEAM FIND push button while adjusting the Channel 1 and Channel 2 VOLTS/DIV switches until the display is reduced in size, both vertically and horizontally. Center the compressed display with the POSITION controls (Channel 2 POSITION control for vertical movement; Horizontal POSITION control for horizontal movement). Release the BEAM FIND push button. Adjust the FOCUS control for a well-defined display.

NOTE

The display obtained when sinusoidal signals are applied to the X- and Y-axis is called a Lissajous Figure. This display is commonly used to compare the frequency and phase relationship of the two input signals. The frequency relationship of the two input signals determines the pattern seen. The pattern will be stable only if a common divisor exists between the two frequencies.

6. Set the X-Y switch to the out position and disconnect the input signals from the vertical input connectors.

Single Sweep Display

1. Preset the instrument controls and obtain a baseline display.
2. For random signals, set the A TRIGGER LEVEL control to trigger the sweep on a signal that is approximately the same amplitude as the random signal.
3. Press in the SGL SWP RESET button for a moment. The next trigger pulse will initiate the sweep, and a single trace will be displayed. If no trigger signal is present, the READY indicator LED should illuminate to indicate that the A SWEEP Generator circuit is set to initiate a sweep when a trigger signal is received.
4. When the single sweep has been triggered and the sweep is completed, the sweep logic circuitry is locked out. Another sweep cannot be generated until the SGL SWP RESET button is pressed in to set the A Sweep Generator to the READY condition.

DIGITAL STORAGE DISPLAYS

The following procedures explain how to set up and use the digital storage capabilities of the instrument. A combination of front-panel controls and Menu selections sets the conditions under which a waveform is acquired for display. Display amplitude is controlled by the VOLTS/DIV switches. The storage time base is controlled by the A or B SEC/DIV switch and the CURSORS controls. Certain conditions of the SEC/DIV switch and the TRIGGER Mode switch will acquire and display waveforms using default parameters. Using the Menu, many of the defaults may be changed. See Table 3-2 for a listing of the default selections and optional choices.

STORE Mode Display

1. Preset instrument controls and obtain a baseline trace.
2. Press the TRIG POS button for the desired trigger position (PRETRIG, MIDTRIG, or POST TRIG).
3. Set the STORE/NON-STORE switch to the STORE position (button in).

SAVE Mode Display

1. Acquire a waveform using one of the storage modes.
2. Select SAVE with the SAVE/CONT button (readout displays "SAVE").
3. The SAVE mode display may be expanded horizontally by the X10 Magnifier switch. The display is expanded horizontally in both directions from the active cursor and is correctly scaled for the switch settings.
4. The SAVE mode display may be expanded or compressed vertically by a factor of 10 times (or by as many VOLTS/DIV switch positions remaining whichever is less) by switching the corresponding VOLTS/DIV switch (a waveform acquired at 2 mV per

division cannot be expanded, and a waveform acquired at 5 V per division cannot be compressed).

5. Saved waveforms may be repositioned using the Menu even if they have been expanded or compressed.

SAVE REF Display

1. Acquire the waveform to be used as a reference using the previous SAVE Mode Display procedure.
2. Press in the SAVE REF push button.
3. Push in one of the Reference buttons. The waveform is stored in the Reference Memory selected by the Reference button pushed.
4. If the SAVE REF display contains the active cursor, use the Menu to horizontally expand or compress the SAVE REF display by a factor of up to 10 times, if desired. The display is expanded horizontally in both directions from the active cursor and is correctly scaled for the switch settings. A waveform acquired at 2 mV per division cannot be vertically expanded, and a waveform acquired at 5 V per division cannot be vertically compressed.
5. Push the appropriate Reference button (without first pushing the SAVE REF button) to retrieve and display a stored reference waveform. A new reference waveform is saved each time the SAVE REF button is pushed and then a Reference button is pushed.

ACCPEAK or PEAKDET Displays

1. Preset the instrument controls and obtain a baseline display.
2. Set the STORE/NON-STORE switch to the STORE position (button in).
3. Adjust the A TRIGGER LEVEL control to obtain a stable display of the waveform to be stored. This ensures that the trigger and the waveform to be stored are synchronized, especially on low-repetition-rate waveforms.

4. Press the TRIG POS button to select PRETRIG ACQUISITION mode to acquire 7/8 of the waveform before the trigger event, MIDTRIG ACQUISITION mode to acquire 1/2 of the waveform after the trigger event, or POST TRIG ACQUISITION mode to acquire 7/8 of the waveform that occurs after the trigger.

NOTE

Using the Acquisition Menu, the trigger point can be selected to be any point within the acquisition record.

5. Push the ACQ SETUP button once to display the ACQUISITION Menu.
6. Use the SAVE REF button to select ACCPEAK or PEAKDET.
7. Push the ACQ SETUP button again to return to standard (non-store) operating mode.

NOTE

The acquisition mode may also be selected from the front panel by successively pressing the ACQUISITION MODE button until the desired mode is displayed in the readout.

AVERAGE Mode Display

1. Preset the instrument controls and obtain a baseline display.
2. Set the STORE/NON-STORE switch to the STORE position (button in).
3. Adjust the A TRIGGER LEVEL control to obtain a stable display of the waveform to be stored. This ensures that the trigger and the waveform to be stored are synchronized, especially on low-repetition-rate waveforms.
4. Press the TRIG POS button to select PRETRIG ACQUISITION mode to acquire 7/8 of the waveform before the trigger event,

MIDTRIG ACQUISITION mode to acquire 1/2 of the waveform after the trigger event, or POST TRIG ACQUISITION mode to acquire 7/8 of the waveform that occurs after the trigger.

5. Push the ACQ SETUP button once to display the ACQUISITION Menu.
6. Use the SAVE REF button to select AVERAGE.
7. Use the 4K button to select Swp Lim on the menu. Then turn the CURSORS knob to change the number of sweeps accumulated in the display before the averaging (acquisitions) stop, if desired. The number is automatically set to infinity (NO LIMIT) at power-up.
8. Use the 4K button to select Avg Wgt on the menu. Adjust the CURSORS control to change the weight of the last (current) acquisition in the average, if desired. The weight is automatically set to 1/4 at power-up.

NOTE

The weight of the last (current) acquisition to be averaged into the display is selectable from 1/2 to 1/256 in powers of 2. A normalized algorithm is used to display the averaged signal. Averaging continues until a new mode is selected or Swp Lim is reached. Display of the average continues until a new mode is selected. Changing a front-panel control that affects the data being acquired restarts the averaging process; the algorithm displays the new average at full amplitude.

NONSTORAGE MEASUREMENTS

The following procedures will enable the operator to perform some basic measurements and familiarize the operator with the conventional oscilloscope capabilities of the instrument.

VOLTAGE

Ac Peak-to-peak Voltage

To make a peak-to-peak voltage measurement, use the following procedure:

NOTE

This procedure may also be used to make voltage measurements between any two points on the waveform.

1. Preset instrument controls and obtain a baseline trace.
2. Apply the ac signal to either vertical-channel input connector and set the VERTICAL MODE switches to display the channel used.
3. Set the appropriate VOLTS/DIV switch to display about five divisions of the waveform, ensuring that the VOLTS/DIV Variable control is in the CAL detent.
4. Adjust the A TRIGGER LEVEL control to obtain a stable display.
5. Adjust the A SEC/DIV switch to display several cycles of the waveform.
6. Vertically position the displayed waveform so that the negative peak of the waveform coincides with one of the horizontal graticule lines (see Figure 6-1, Point A).
7. Horizontally position the display so that one of the positive peaks coincides with the center vertical graticule line (see Figure 6-1, Point B).
8. Measure the vertical deflection from peak to peak (see Figure 6-1, Point A to Point B).

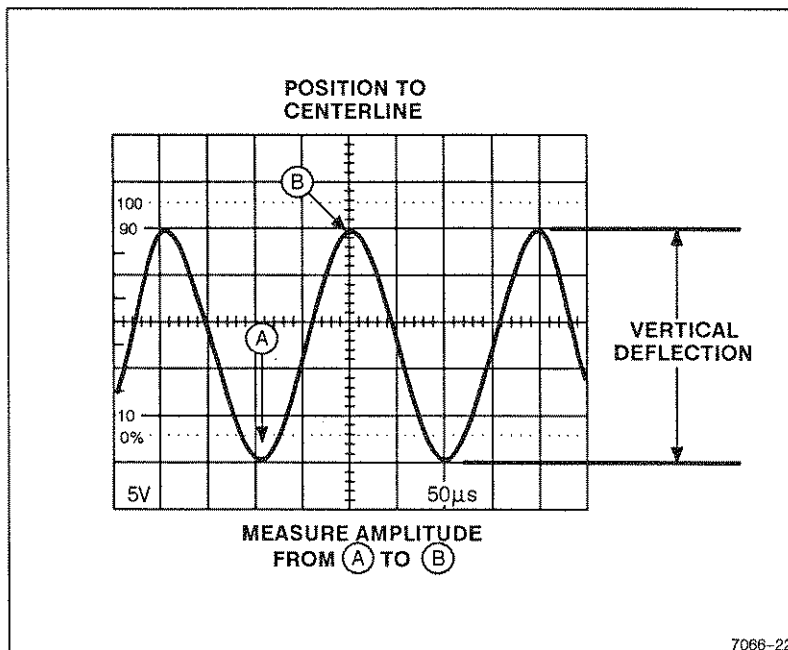

Figure 6-1. Peak-to-peak waveform voltage.

NOTE

A more accurate value can be obtained by measuring from the top of a peak to the top of a valley. This eliminates trace thickness from the measurement.

- Calculate the peak-to-peak voltage, using the following formula:

$$\text{Volts (p-p)} = \text{vertical deflection (divisions)} \times \text{VOLTS/DIV switch setting} \times \text{probe attenuation factor}$$

Basic Applications

EXAMPLE: The measured peak-to-peak vertical deflection is 5 divisions (see Figure 6-1) with a VOLTS/DIV switch setting of 0.5 V, using a 10X probe.

Substituting the given values:

$$\text{Volts (p-p)} = 5 \text{ div} \times 0.5 \text{ V/div} \times 10 = 25 \text{ V}$$

Ground-Referenced Dc Voltage

NOTE

Either channel input connector may be used for the signal input. Use the VERTICAL MODE switches to select the appropriate channel for display.

1. Apply the signal to be measured to the selected channel input and obtain a NON-STORE display.
2. Ensure that the VOLTS/DIV Variable control is in the calibrated detent and determine the polarity of the voltage to be measured as follows:
 - a. Set the AC-GND-DC switch to GND and vertically position the baseline trace to the center horizontal graticule line.
 - b. Set the AC-GND-DC switch to DC. If the waveform moves above the center line of the crt, the voltage is positive. If the waveform moves below the center line of the crt, the voltage is negative.
3. Set the AC-GND-DC switch to GND and position the baseline trace to a convenient reference line. For example, if the voltage to be measured is positive, position the baseline trace to the bottom graticule line. If a negative voltage is to be measured, position the baseline trace to the top graticule line.
4. Set the AC-GND-DC switch to DC. Measure the divisions of vertical deflection between the reference line and the desired point on the waveform (see Figure 6-2).

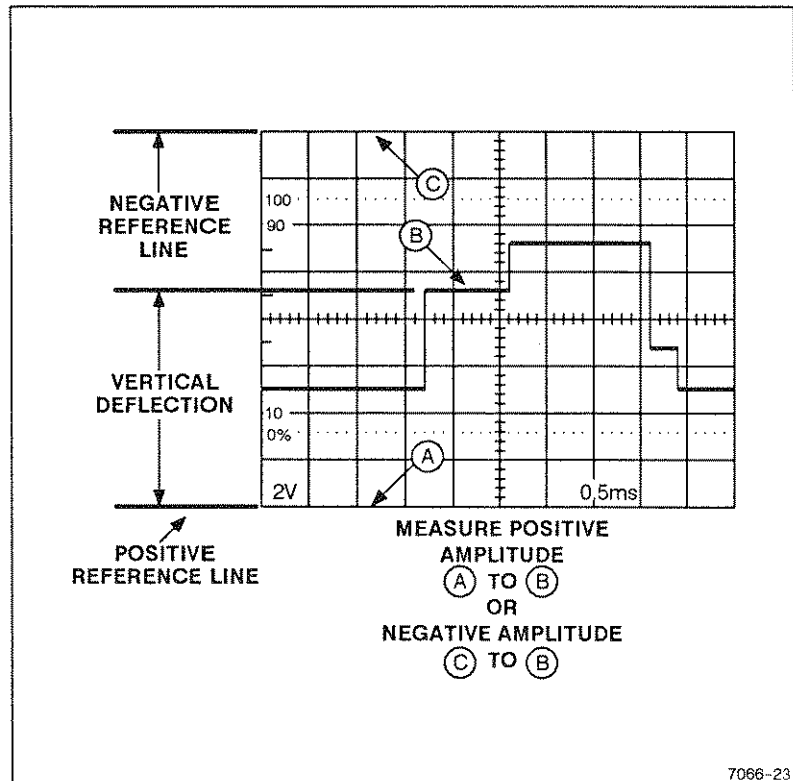

Figure 6-2. Ground-referenced voltage measurement.

5. Calculate the voltage, using the following formula:

$$\text{Voltage} = \frac{\text{vertical distance (divisions)}}{\text{Polarity (+ or -)}} \times \frac{\text{VOLTS/DIV switch setting}}{\text{probe attenuation factor}}$$

NOTE

The attenuation factor of the probe being used must be included if it is not a 10X scale-factor-switching probe.

Basic Applications

EXAMPLE: The vertical distance measured is 4.6 divisions (see Figure 6-2). The waveform is above the reference line, the VOLTS/DIV switch is set to 2V, and a 10X scale-factor-switching probe is used.

Substituting the given values into the formula:

$$\text{Voltage} = 4.6 \text{ div} \times (+1) \times 2 \text{ V/div} = +9.2 \text{ V}$$

Algebraic Addition

With the VERTICAL MODE switches in the ADD position, the waveform displayed represents the algebraic sum of the signals applied to the Channel 1 and Channel 2 input connectors (CH 1 + CH 2). If the Channel 2 INVERT switch is pressed in, the resulting waveform is the difference of the signals applied to the Channel 1 and Channel 2 input connectors (CH 1 - CH 2). The total deflection factor in the ADD mode is equal to the deflection factor indicated by either VOLTS/DIV switch (when both VOLTS/DIV switches are set to the same deflection factor). A common use for the ADD mode is to provide a dc offset for a signal riding on top of a dc level.

The following general precautions should be observed when using the ADD mode:

- a. Do not exceed the input voltage rating of the oscilloscope.
- b. Do not apply signals that exceed the equivalent of about eight times the VOLTS/DIV switch setting, since large voltages may distort the display. For example, with a VOLTS/DIV switch setting of 0.5 V, the voltage applied to that channel input should not exceed about 4 volts.

EXAMPLE: Using the graticule center line as 0V, the Channel 1 signal is at a 3-division, positive dc level (see Figure 6-3A).

1. Multiply 3 divisions by the VOLTS/DIV switch setting to determine the dc-level value.

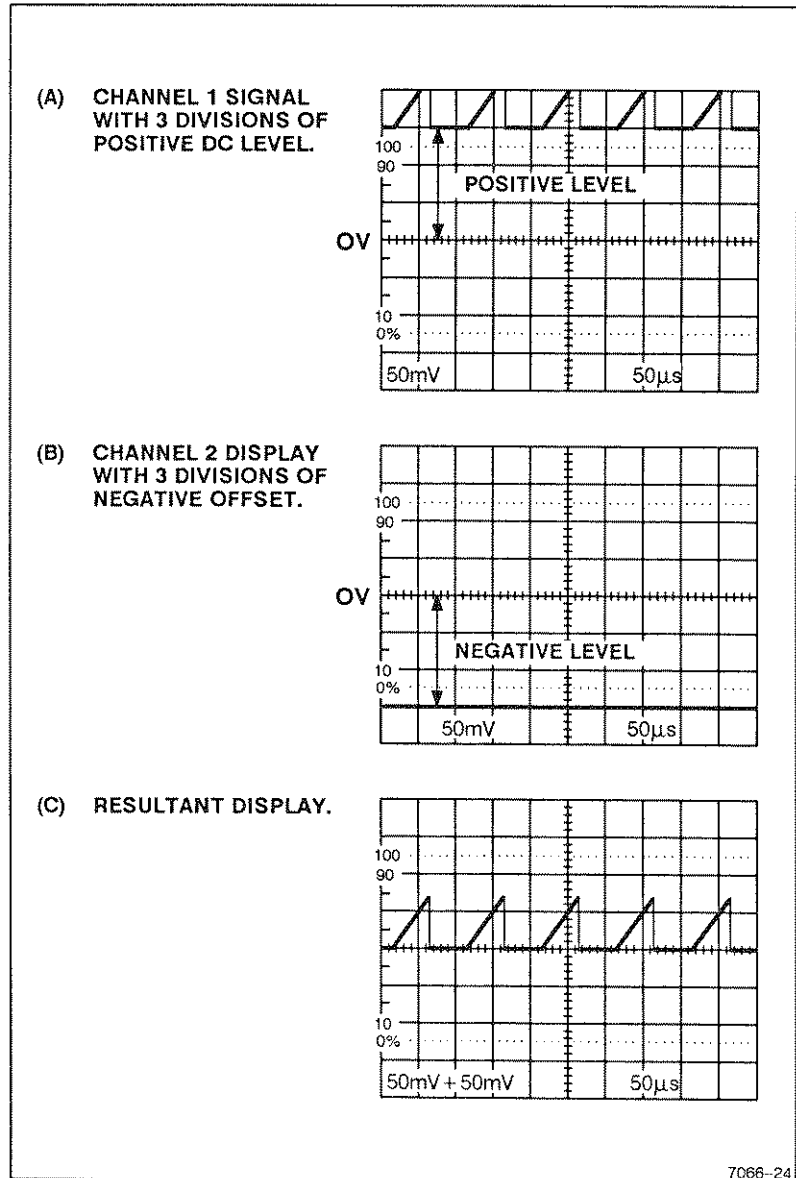

Figure 6-3. Algebraic addition.

2. To the Channel 2 input connector, apply a negative dc level (or positive level, using the Channel 2 INVERT switch) whose value was determined in step 1 (see Figure 6-3B).
3. Select ADD and BOTH VERTICAL MODE to place the resultant display within the operating range of the Vertical POSITION controls (see Figure 6-3C).

Common-mode Rejection

The ADD mode can also be used to display signals that contain undesirable frequency components. The undesirable components can be eliminated through common-mode rejection. The precautions given under the preceding Algebraic Addition procedure should be observed.

EXAMPLE: The signal applied to the Channel 1 input connector contains unwanted frequency components (see Figure 6-4A). To remove the undesired components, use the following procedure:

1. Preset instrument controls and obtain a baseline trace.
2. Apply the signal containing the unwanted components to the Channel 1 input.
3. Apply the unwanted signal to the Channel 2 input.
4. Select BOTH and ALT VERTICAL MODE and press in the Channel 2 INVERT button.
5. Adjust the Channel 2 VOLTS/DIV switch and Variable control so the Channel 2 display is approximately the same amplitude as the undesired portion of the Channel 1 display (see Figure 6-4A).
6. Select ADD VERTICAL MODE and slightly readjust the Channel 2 VOLTS/DIV Variable control for maximum cancellation of the undesired signal component (see Figure 6-4B).

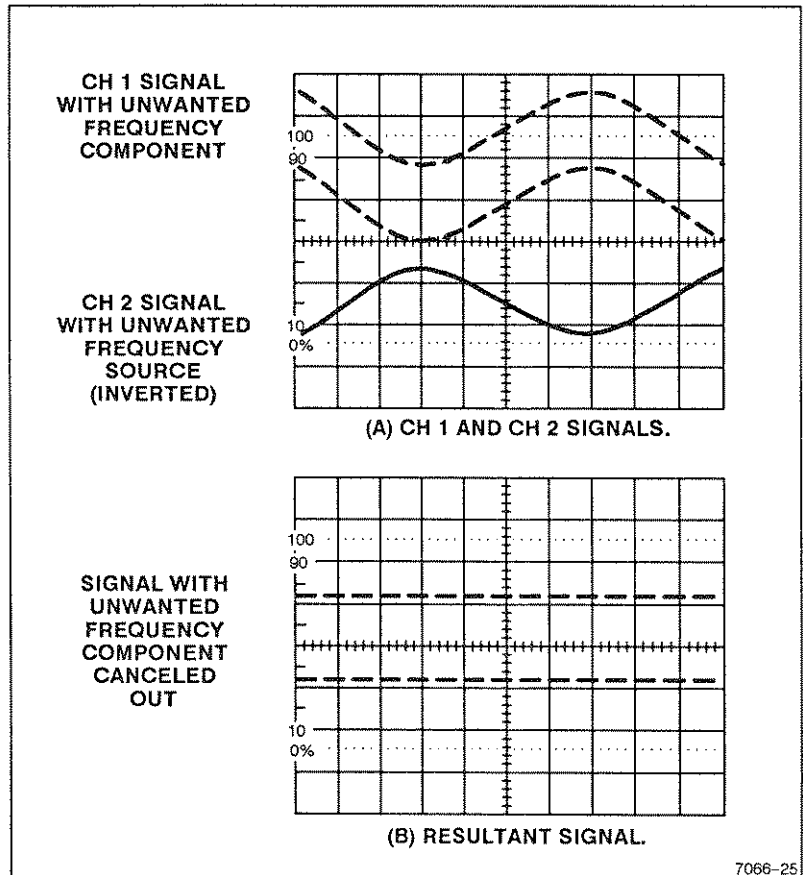

Figure 6-4. Common-mode rejection.

Amplitude Comparison

In some applications it may be necessary to establish a set of deflection factors other than those indicated by the VOLTS/DIV switch settings. This is useful for comparing unknown signals to a reference signal of known amplitude. To accomplish this, a reference signal of known amplitude is first set to an exact number of vertical divisions by

Basic Applications

adjusting the VOLTS/DIV switch and Variable control. Unknown signals can then be quickly and accurately compared with the reference signal without disturbing the setting of the VOLTS/DIV Variable control. The procedure is as follows.

1. Preset instrument controls and obtain a baseline trace.
2. Apply the reference signal to either vertical channel input and set the VERTICAL MODE switch to display the channel used.
3. Set the amplitude of the reference signal to an exact number of vertical divisions by adjusting the VOLTS/DIV switch and VOLTS/DIV Variable control.
4. Establish a vertical conversion factor, using the following formula (reference signal amplitude must be known):

$$\text{Vertical Conversion Factor} = \frac{\text{reference signal amplitude (volts)}}{\text{vertical deflection (divisions)} \times \text{VOLTS/DIV switch setting}}$$

5. Disconnect the reference signal and apply the unknown signal to be measured to the same channel input. Adjust the VOLTS/DIV switch to a setting that provides sufficient vertical deflection to make an accurate measurement. Do not readjust the VOLTS/DIV Variable control.
6. Establish an arbitrary deflection factor, using the following formula:

$$\text{Arbitrary Deflection Factor} = \text{vertical conversion factor} \times \text{VOLTS/DIV switch setting}$$

7. Measure the vertical deflection of the unknown signal in divisions and calculate its amplitude using the following formula:

$$\text{Unknown Signal Amplitude} = \text{arbitrary deflection factor} \times \text{vertical deflection (divisions)}$$

EXAMPLE: The reference signal amplitude is 30 V, with a VOLTS/DIV switch setting of 5 V and the VOLTS/DIV Variable control adjusted to provide a vertical deflection of exactly 4 divisions.

Substituting these values in the vertical conversion factor formula:

$$\text{Vertical Conversion Factor} = \frac{30 \text{ V}}{4 \text{ div} \times 5 \text{ V/div}} = 1.5$$

Continuing, for the unknown signal the VOLTS/DIV switch setting is 1 and the peak-to-peak amplitude spans five vertical divisions. The arbitrary deflection factor is then determined by substituting values in the formula:

$$\text{Arbitrary Deflection Factor} = 1.5 \times 1 \text{ V/div} = 1.5 \text{ V/div}$$

The amplitude of the unknown signal can then be determined by substituting values in the unknown signal amplitude formula:

$$\text{Amplitude} = 1.5 \text{ V/div} \times 5 \text{ div} = 7.5 \text{ V}$$

TIMING

Time Duration

To measure time between two points on a waveform, use the following procedure:

1. Preset instrument controls and obtain a baseline trace.
2. Apply the signal to either vertical-channel input connector and set the VERTICAL MODE switches to display the channel used.
3. Adjust the A TRIGGER LEVEL control to obtain a stable display.

Basic Applications

4. Set the A SEC/DIV control to display one complete period of the waveform. Ensure that the A and B SEC/DIV Variable control is in the CAL detent.
5. Position the display to place the time-measurement points on the center horizontal graticule line (see Figure 6-5).
6. Measure the horizontal distance between the time-measurement points.
7. Calculate time duration, using the following formula:

$$\text{Time Duration} = \frac{\text{horizontal distance (divisions)} \times \text{A SEC/DIV switch setting}}{\text{magnification factor}}$$

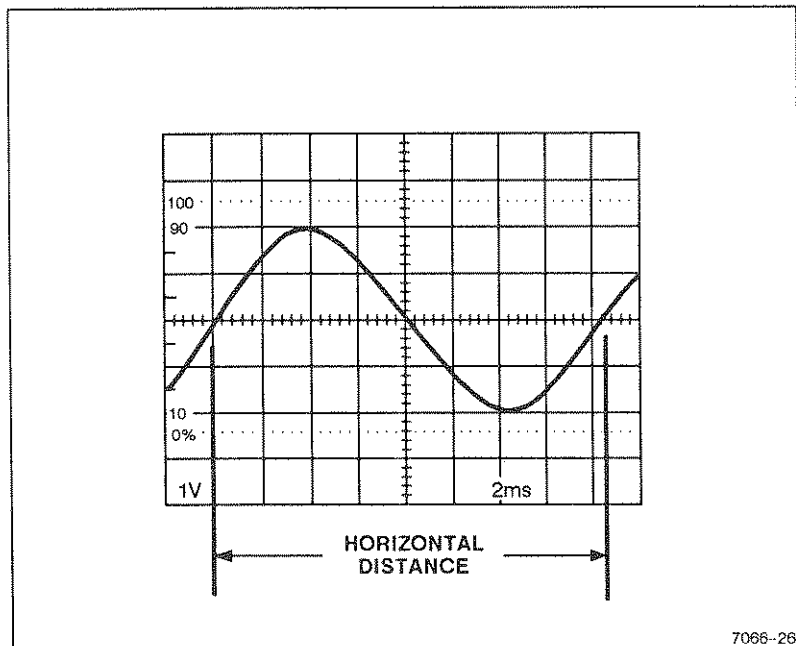

Figure 6-5. Time Duration.

EXAMPLE: The distance between the time-measurement points is 8.3 divisions (see Figure 6-5), and the A SEC/DIV switch is set to 2 ms. The X10 Magnifier switch is pushed in (1X magnification).

Substituting the given values:

$$\text{Time Duration} = 8.3 \text{ div} \times 2 \text{ ms/div} = 16.6 \text{ ms}$$

Frequency

The frequency of a recurrent signal can be determined from its time-duration measurement as follows:

1. Measure the time duration of one waveform cycle using the preceding Time Duration measurement procedure.
2. Calculate the reciprocal of the time-duration value to determine the frequency of the waveform.

EXAMPLE: The signal in Figure 6-5 has a time duration of 16.6 ms.

Calculating the reciprocal of time duration:

$$\text{Frequency} = \frac{1}{\text{time duration}} = \frac{1}{16.6 \text{ ms}} = 60 \text{ Hz}$$

Rise Time

Rise-time measurements use the same methods as time duration, except that the measurements are made between the 10% and 90% points on the leading edge of the waveform (see Figure 6-6). Fall time is measured between the 90% and 10% points on the trailing edge of the waveform.

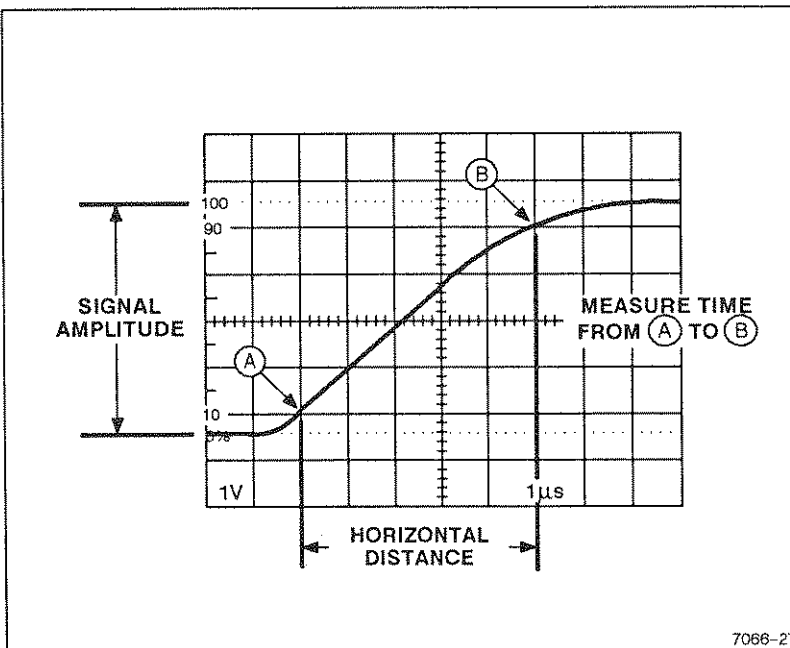

Figure 6-6. Rise time.

1. Preset instrument controls and obtain a baseline trace.
2. Apply an exact 5-division signal to either vertical-channel input connector and set the VERTICAL MODE switches to display the channel used. Ensure that the VOLTS/DIV Variable control is in the CAL detent.

NOTE

For rise time greater than 0.2 μ s, the VOLTS DIV Variable control may be used to obtain an exact 5-division display.

3. Set the A TRIGGER SLOPE switch to OUT (plus). Use a sweep-speed setting that displays several complete cycles or events (if possible).

4. Adjust vertical positioning so that the zero reference of the waveform touches the 0% graticule line and the top of the waveform touches the 100% graticule line (see Figure 6-6).
5. Set the A SEC/DIV switch for a single-waveform display, with the rise time spread horizontally as much as possible.
6. Horizontally position the display so the 10% point on the waveform intersects the second vertical graticule line (see Figure 6-6, Point A).
7. Measure the horizontal distance between the 10% and 90% points and calculate the time duration using the following formula:

$$\text{Rise Time} = \frac{\text{horizontal distance (divisions)} \times \text{A SEC/DIV switch setting}}{\text{magnification factor}}$$

EXAMPLE: The horizontal distance between the 10% and 90% points is 5 divisions (see Figure 6-6), and the A SEC/DIV switch is set to 1 μ s. The X10 magnifier knob is pushed in (1X magnification).

Substituting the given values in the formula:

$$\text{Rise Time} = \frac{5 \text{ div} \times 1 \mu\text{s/div}}{1} = 5 \mu\text{s}$$

Time Difference Between Two Time-related Pulses

The calibrated sweep speed and dual-trace features of the instrument allow measurement of the time difference between two separate events. To measure time difference, use the following procedure:

1. Preset instrument controls and obtain a baseline trace.
2. Set the A TRIGGER A&B SOURCE switch to CH 1.

Basic Applications

3. Set both AC-GND-DC switches to the same position, depending on the type of input coupling desired.
4. Using either probes or cables with equal time delays, connect a known reference signal to the Channel 1 input and the comparison signal to the Channel 2 input.
5. Set both VOLTS/DIV switches for 4- or 5-division displays.
6. Select BOTH VERTICAL MODE; then select either ALT or CHOP, depending on the frequency of the input signals.
7. Adjust the A TRIGGER LEVEL control for a stable display.
8. Set the A SEC/DIV switch to a sweep speed which provides three or more divisions of horizontal separation between the reference points on the two displays. Center each of the displays vertically (see Figure 6-7).
9. Measure the horizontal difference between the two signal-reference points and calculate the time difference using the following formula:

$$\text{Time Difference} = \frac{\text{A SEC/DIV switch setting} \times \text{horizontal difference (divisions)}}{\text{magnification factor}}$$

EXAMPLE: The A SEC/DIV switch is set to 50 μs , the X10 magnifier knob is pulled out, and the horizontal difference between waveform measurement points is 4.5 divisions.

Substituting the given values in the formula:

$$\text{Time Difference} = \frac{50 \mu\text{s/div} \times 4.5 \text{ div}}{10} = 22.5 \mu\text{s}$$

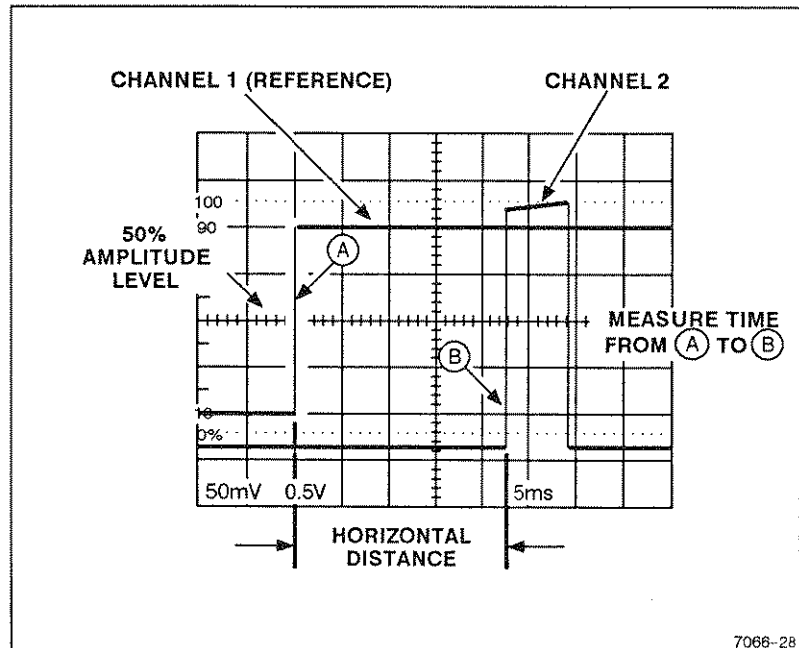

Figure 6-7. Time difference between two time-related pulses.

Phase Difference

In a similar manner to Time Difference, phase comparison between two signals of the same frequency can be made using the dual-trace feature of the instrument. This method of phase difference measurement can be used up to the frequency limit of the vertical system. To make a phase comparison, use the following procedure:

1. Preset instrument controls and obtain a baseline trace, then set the A TRIGGER A&B SOURCE switch to CH 1.
2. Set both AC-GND-DC switches to the same position, depending on the type of input coupling desired.
3. Using either probes or coaxial cables with equal time delays, connect a known reference signal to the Channel 1 input and the unknown signal to the Channel 2 input.

Basic Applications

4. Select BOTH VERTICAL MODE; then select either ALT or CHOP, depending on the frequency of the input signals. The reference signal should precede the comparison signal in time.
5. If the two signals are of opposite polarity, press in the Channel 2 INVERT button to invert the Channel 2 display.
6. Set both VOLTS/DIV switches and both Variable controls so the displays are equal in amplitude.
7. Adjust the A TRIGGER LEVEL control for a stable display.
8. Set the A SEC/DIV switch to a sweep speed which displays about one full cycle of the waveforms.
9. Position the displays and adjust the SEC/DIV Variable control so that one reference-signal cycle occupies exactly eight horizontal graticule divisions at the 50% rise-time points (see Figure 6-8). Each division of the graticule now represents 45° of the cycle ($360^\circ \div 8$ divisions), and the horizontal graticule calibration can be stated as 45° per division.
10. Measure the horizontal difference between corresponding points on the waveforms at a common horizontal graticule line (50% of rise time) and calculate the phase difference using the following formula:

$$\text{Phase Difference} = \text{horizontal difference (divisions)} \times \text{horizontal graticule calibration } (^\circ/\text{div})$$

EXAMPLE: The horizontal difference is 0.6 division with a graticule calibration of 45° per division as shown in Figure 6-8.

Substituting the given values into the phase difference formula:

$$\text{Phase Difference} = 0.6 \text{ div} \times 45^\circ/\text{div} = 27^\circ$$

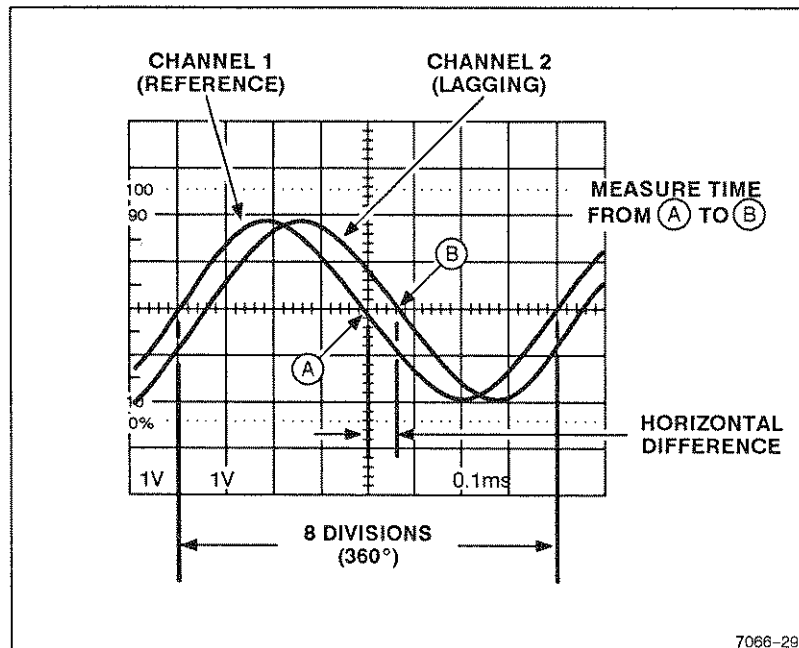

Figure 6-8. Phase difference.

More accurate phase measurements can be made by using the X10 Magnifier function to increase the sweep speed without changing the SEC/DIV Variable control setting.

EXAMPLE: If the sweep speed were increased 10 times with the magnifier (X10 Magnifier out), the magnified horizontal graticule calibration would be $45^\circ/\text{division}$ divided by 10 (or $4.5/\text{division}$). Figure 6-9 shows the same signals illustrated in Figure 6-8, but magnifying the displays results in a horizontal difference of 6 divisions between the two signals.

Substituting the given values in the phase difference formula:

$$\text{Phase Difference} = 6 \text{ div} \times 4.5^\circ/\text{div} = 27^\circ$$

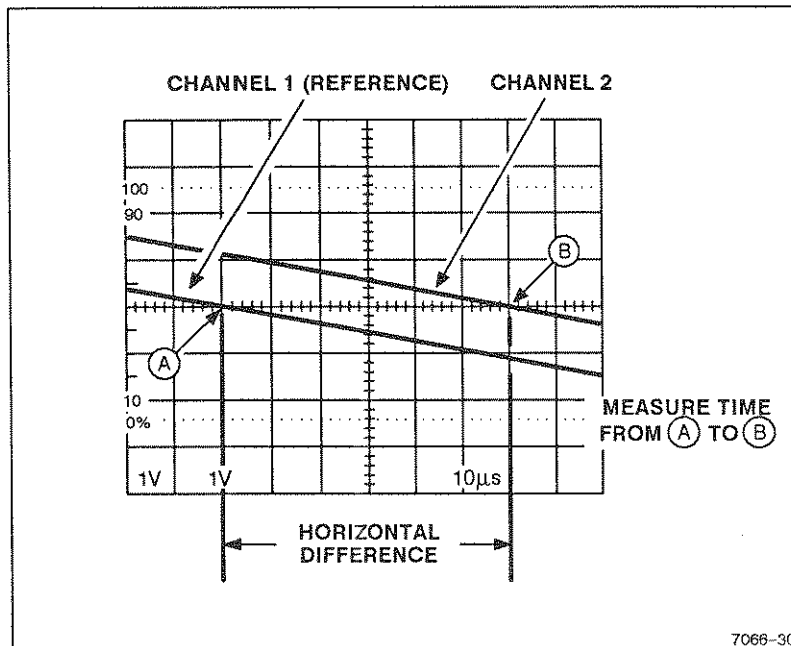

Figure 6-9. High-resolution phase difference.

Time Comparison

In a similar manner to Amplitude Comparison, repeated time comparisons between unknown signals and a reference signal (e.g., on assembly-line test) may be easily and accurately measured with the instrument. To accomplish this, a reference signal of known time duration is first set to an exact number of horizontal divisions by adjusting the A SEC/DIV switch and the SEC/DIV Variable control. Unknown signals can then be compared with the reference signal without disturbing the setting of the SEC/DIV Variable control. The procedure is as follows:

1. Set the time duration of the reference signal to an exact number of horizontal divisions by adjusting the A SEC/DIV switch and the SEC/DIV Variable control.

2. Establish a horizontal conversion factor, using the following formula (reference-signal time duration must be known):

$$\text{Horizontal Conversion Factor} = \frac{\text{reference signal time duration (seconds)}}{\text{horizontal distance (divisions)} \times \text{A SEC/DIV (switch setting)}}$$

3. For the unknown signal, adjust the A SEC/DIV switch to a setting that provides sufficient horizontal deflection to make an accurate measurement. Do not readjust the SEC/DIV Variable control.
4. Establish an arbitrary deflection factor, using the following formula:

$$\text{Arbitrary Deflection Factor} = \text{horizontal conversion factor} \times \text{A SEC/DIV switch setting}$$

5. Measure the horizontal distance of the unknown signal in divisions and calculate its time duration using the following formula:

$$\text{Time Duration} = \text{arbitrary deflection factor} \times \text{horizontal distance (divisions)}$$

EXAMPLE: The reference signal time duration is 2.19 ms, the A SEC/DIV switch setting is 0.2 ms, and the SEC/DIV Variable control is adjusted to provide a horizontal distance of exactly 8 divisions.

Substituting the given values in the horizontal conversion factor formula:

$$\text{Horizontal Conversion Factor} = \frac{2.19 \text{ ms}}{8 \text{ div} \times 0.2 \text{ ms/div}} = 1.37$$

Basic Applications

For the unknown signal the A SEC/DIV switch setting is $50 \mu\text{s}$, and one complete cycle spans seven horizontal divisions. The arbitrary deflection factor is then determined by substituting values in the formula:

$$\begin{array}{l} \text{Arbitrary} \\ \text{Deflection} \\ \text{Factor} \end{array} = 1.37 \times 50 \mu\text{s/div} = 68.5 \mu\text{s/div}$$

The time duration of the unknown signal can then be computed by substituting values in the formula:

$$\begin{array}{l} \text{Time} \\ \text{Duration} \end{array} = 68.5 \mu\text{s/div} \times 7 \text{ div} = 480 \mu\text{s}$$

The frequency of the unknown signal is then calculated:

$$\text{Frequency} = \frac{1}{480 \mu\text{s}} = 2.083 \text{ kHz}$$

TELEVISION SIGNALS

TV Line Signal

The following procedure is used to display a TV Line signal:

1. Preset instrument controls and select the A TRIGGER mode of P-P AUTO/TV LINE by pushing in the P-P AUTO button.
2. Apply the TV signal to either vertical-channel input connector and set the VERTICAL MODE switches to display the channel used.
3. Set the appropriate VOLTS/DIV switch to display 0.3 division or more of composite video signal.

4. Set the A SEC/DIV switch to 10 μ s.
5. Set the A TRIGGER SLOPE switch to either OUT (for positive-going TV signal sync pulses) or IN (for negative-going TV signal sync pulses).

NOTE

To examine a TV Line signal in more detail, either the X10 Magnifier or the Delayed-Sweep Magnification feature may be used.

TV Field Signal

The television feature of the instrument can also be used to display TV Field signals.

1. Preset instrument controls and obtain a baseline trace.
2. Set the A TRIGGER Mode switch to TV FIELD (P-P AUTO and NORM buttons both pushed in) and set the A SEC/DIV switch to 2 ms.
3. To display a single field, connect the TV signal to either vertical-channel input connector and set the VERTICAL MODE switch to display the channel used.
4. Set the appropriate VOLTS/DIV switch to display 2.5 divisions or more of composite video signal.
5. Set the A TRIGGER SLOPE switch to either OUT (for positive-going TV signal sync pulses) or IN (for negative-going TV signal sync pulses).
6. To change the field that is displayed, momentarily interrupt the trigger signal by setting the AC-GND-DC switch to GND and then back to AC until the desired field is displayed.

Basic Applications

NOTE

To examine a TV Field signal in more detail, either the X10 Magnifier or the Delayed-Sweep Magnification feature may be used.

7. To display a selected horizontal line, first trigger the sweep on a vertical (field) sync pulse, then use the Magnified Sweep Runs After Delay procedure in this part (steps 5 through 7) to magnify the selected horizontal line for a closer examination. This procedure is useful for examining Vertical Interval Test Signals (VITS).
8. To display either Field 1 or Field 2 individually, connect the TV signal to both CH 1 and CH 2 input connectors and select BOTH and ALT VERTICAL MODE.
9. Set the A SEC/DIV switch to a faster sweep speed (displays of less than one full field). This will synchronize the Channel 1 display to one field and the Channel 2 display to the other field.

DELAYED-SWEEP MAGNIFICATION

The delayed-sweep feature of the instrument can be used to provide higher apparent magnification than is provided by the X10 Magnifier switch. Apparent magnification occurs as a result of displaying a selected portion of the A trace at a faster sweep speed (B Sweep speed). The A SEC/DIV switch setting determines how often the B trace will be displayed. Since the B Sweep can occur only once for each A Sweep, the A Sweep time duration sets the amount of elapsed time between succeeding B Sweeps.

The intensified zone is an indication of both the location and length of the B Sweep interval within the A Sweep interval. Positioning of the intensified zone (i. e., setting the amount of time between start of the A Sweep and the start of the B Sweep) is accomplished with the B DELAY TIME POSITION control. With either BOTH or B HORIZONTAL MODE selected, the B DELAY TIME POSITION control provides continuously variable positioning of the B Sweep. The range of this

control is sufficient to place the B Sweep interval at any location within the A Sweep interval. When BOTH HORIZONTAL MODE is selected, the B SEC/DIV switch setting determines the B Sweep speed and concurrently sets the length of the intensified zone on the A trace.

Using delayed-sweep magnification may produce a display with some slight horizontal movement (pulse jitter). Pulse jitter includes not only the inherent uncertainty of triggering the delayed sweep at exactly the same trigger point each time, but also jitter that may be present in the input signal. If pulse jitter needs to be measured, use the Pulse Jitter Time Measurement procedure.

Magnified Sweep Runs After Delay

The following procedure explains how to operate the B Sweep in a nontriggered mode and to determine the resulting apparent magnification factor.

1. Preset instrument controls and obtain a baseline trace.
2. Apply the signal to either vertical channel input connector and set the VERTICAL MODE switch to display the channel used.
3. Set the appropriate VOLTS/DIV switch to produce a display of approximately 2 or 3 divisions in amplitude and center the display.
4. Set the A SEC/DIV switch to a sweep speed which displays at least one complete waveform cycle.
5. Select BOTH HORIZONTAL MODE. Adjust both the appropriate channel POSITION control and the A/B SWP SEP control to display the A trace above the B trace.
6. Adjust the B DELAY TIME POSITION control to position the start of the intensified zone to the portion of the display to be magnified (see Figure 6-10).

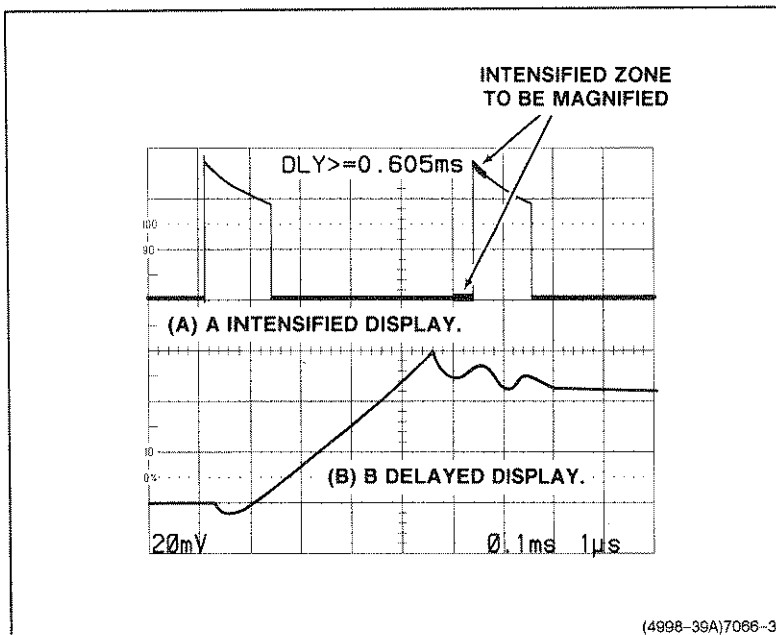

Figure 6-10. Delayed-sweep magnification.

7. Set the B SEC/DIV switch to a setting which intensifies the full portion of the A trace to be magnified. The intensified zone will be displayed as the B trace (see Figure 6-10). The B HORIZONTAL MODE may also be used to magnify the intensified portion of the A Sweep.
8. The apparent sweep magnification can be calculated from the following formula:

$$\text{Apparent Delayed Sweep Magnification} = \frac{\text{A SEC/DIV switch setting}}{\text{B SEC/DIV switch setting}}$$

EXAMPLE: Determine the apparent magnification of a display with an A SEC/DIV switch setting of 0.1 ms and a B SEC/DIV switch setting of 1 μ s.

Substituting the given values:

$$\text{Apparent Magnification} = \frac{1 \times 10^{-4} \text{ s}}{1 \times 10^{-6} \text{ s}} = 10^2 = 100$$

Triggered Magnified Sweep

The following procedure explains how to operate the B Sweep in a triggered mode and to determine the resulting apparent magnification factor. Operating the B Sweep in a triggered mode provides a more stable display, since the delayed display is triggered at the same point each time.

1. Perform steps 1 through 7 of the preceding Magnified Sweep Runs After Delay procedure.

NOTE

The intensified zone seen in the ALT HORIZONTAL MODE display will move from trigger point to trigger point as the B DELAY TIME POSITION control is rotated.

2. Adjust the B TRIGGER LEVEL control so the intensified zone on the A trace is stable.
3. The apparent magnification factor can be calculated from the formula shown in step 8 of the Magnified Sweep Runs After Delay procedure.

DELAYED-SWEEP TIME

Operating the instrument with HORIZONTAL MODE set to either BOTH or B permits time measurements to be made with a greater degree of accuracy than attained with HORIZONTAL MODE set to A. The following procedures describe how these measurements are accomplished.

Time Difference Between Repetitive Pulses

1. Preset instrument controls and obtain a baseline trace.
2. Turn the Readout ON if it's not on already.
3. Apply the signal to either vertical-channel input connector and set the VERTICAL MODE switch to display the channel used.
4. Set the appropriate VOLTS/DIV switch to produce a display of approximately 2 or 3 divisions in amplitude.
5. Set the A SEC/DIV switch to display the measurement points of interest within the graticule area.
6. Select BOTH HORIZONTAL MODE and adjust both the appropriate channel POSITION control and A/B SWP SEP control to display the A trace above the B trace.
7. For the most accurate measurement, set the B SEC/DIV switch to the fastest sweep speed that provides a usable (visible) intensified zone.
8. Adjust the B DELAY TIME POSITION control to move the intensified zone to the leading edge of the first pulse (on the A trace); then fine-adjust until the rising portion (on the B trace) is centered at any convenient vertical graticule line (see Figure 6-11).
9. Record the DELAY TIME POSITION readout.
10. Adjust the B DELAY TIME POSITION control clockwise to move the intensified zone to the leading edge of the second pulse (on the A trace); then fine-adjust until the rising portion (on the B trace) is centered at the same vertical graticule used in step 7.
11. Record the DELAY TIME POSITION readout.

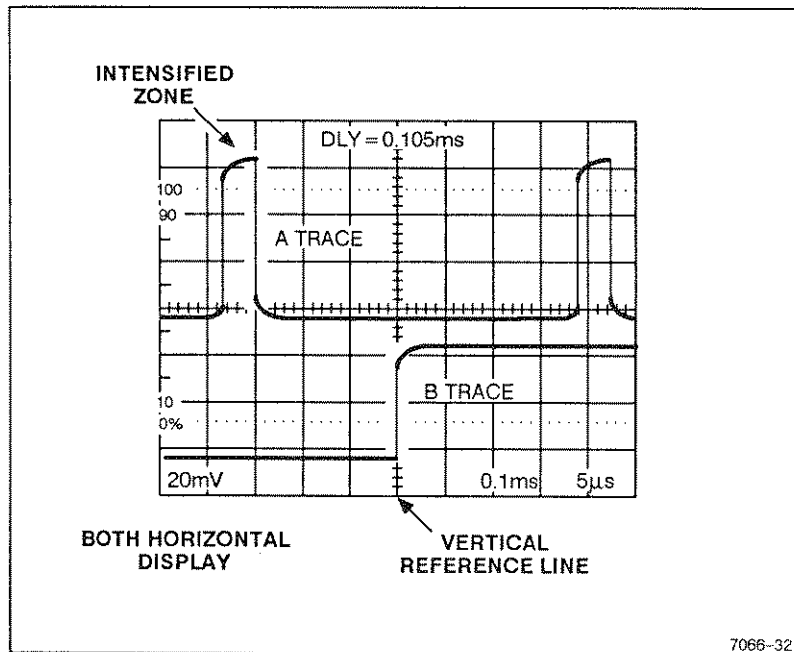

Figure 6-11. Time difference between repetitive pulses.

12. Calculate the time difference between repetitive pulses using the following formula:

$$\begin{array}{rcl} \text{Time} & & \text{Second} \\ \text{Difference} & = & \text{Delay Time} \\ \text{(Duration)} & & \text{Readout} \quad - \quad \text{First} \\ & & & \text{Delay Time} \\ & & & \text{Readout} \end{array}$$

Rise Time

The measurement method for rise time is the same as for time difference between repetitive pulses, except that the measurements are made between the 10% and 90% points on the leading edge of the waveform. Fall time is measured between the 90% and 10% points on the trailing edge of the waveform.

Basic Applications

1. Preset instrument controls and obtain a baseline trace.
2. Apply a 5-division signal to either vertical-channel input connector and set the VERTICAL MODE switch to display the channel used. Ensure that the VOLTS/DIV Variable control is in the CAL detent.

NOTE

For rise times less than 0.2 μ s per division, the VOLTS/DIV Variable control may be used to obtain an exact 5-division display.

3. Vertically position the trace so that the zero reference of the waveform touches the 0% graticule line and the top of the waveform touches the 100% graticule line (see Figure 6-12).
4. Set the A SEC/DIV switch for a single-waveform display. Ensure that the A and B SEC/DIV Variable control is in the CAL detent.
5. Select BOTH HORIZONTAL MODE and set the B SEC/DIV switch to spread the rise-time-measurement portion of the display as much as possible.
6. Select the B HORIZONTAL MODE. Adjust the B DELAY TIME POSITION control until the display intersects the 10% point at the center vertical graticule line (see Figure 6-12, Point A).
7. Record the DELAY TIME POSITION readout.
8. Adjust the B DELAY TIME POSITION control until the display intersects the 90% point at the center vertical graticule line (see Figure 6-12, Point B).
9. Record the DELAY TIME POSITION readout.
10. Calculate rise time using the same formula listed in the Time Difference Between Repetitive Pulses measurement procedure.

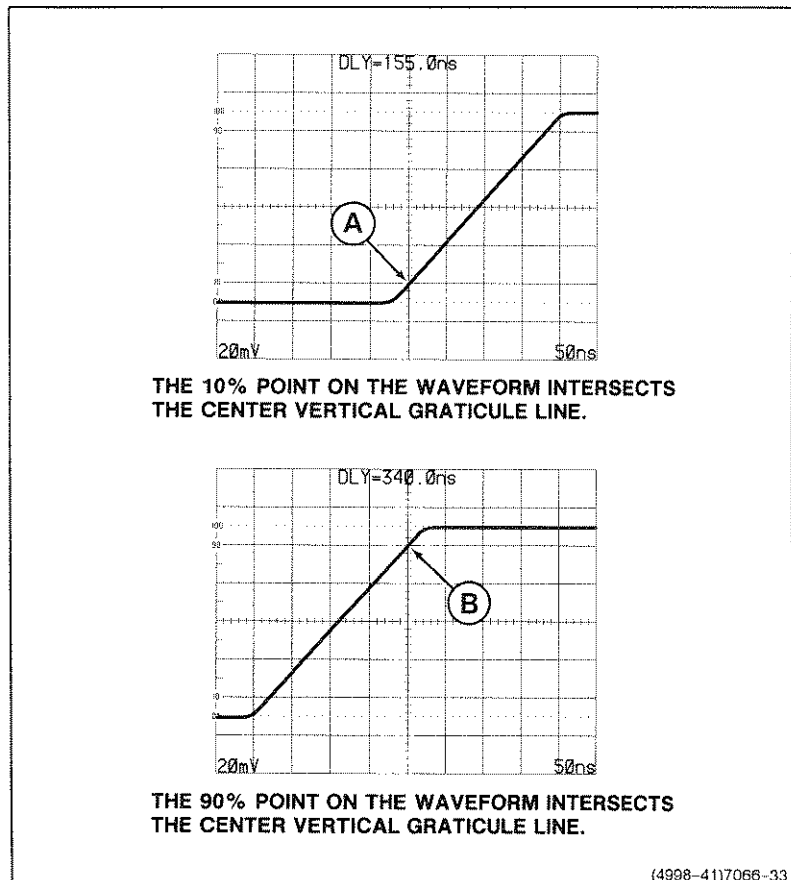

Figure 6-12. Rise time, differential time method.

Time Difference Between Two Time-Related Pulses

1. Preset instrument controls and obtain a baseline trace.
2. Using probes or cables having equal time delays, apply the reference signal to the Channel 1 input and apply the comparison signal to the Channel 2 input.

Basic Applications

3. Set both VOLTS/DIV switches to produce a display of 2 to 3 divisions in amplitude.
4. Select BOTH VERTICAL MODE and either ALT or CHOP, depending on the frequency of the input signals.
5. Set the A SEC/DIV switch to display the measurement points of interest within the graticule area.
6. Select BOTH HORIZONTAL MODE and CH 1 VERTICAL MODE. Adjust both the Channel 1 POSITION control and the A/B SWP SEP control so that the A trace is displayed above the B trace.
7. Rotate the B DELAY TIME POSITION control to move the intensified zone to the rising edge of the reference pulse (on the A trace); then fine adjust until the rising portion (on the B trace) is centered at any convenient vertical graticule line (see Figure 6-13, Point A).
8. Record the DELAY TIME POSITION readout.
9. Select CH 2 VERTICAL MODE and adjust both the Channel 2 POSITION control and the A/B SWP SEP control as necessary to display the A trace above the B trace.
10. Rotate the B DELAY TIME POSITION control to set the rising portion of the Channel 2 pulse (on the B trace) to the same vertical reference point as used in step 7 (see Figure 6-13, Point B). Observe the A trace to position the intensified zone to the correct pulse (if more than one pulse is displayed). Do not change the setting of the Horizontal POSITION control.
11. Record the DELAY TIME POSITION readout.
12. Calculate the time difference between the Channel 1 and Channel 2 pulses as in the preceding Time Difference Between Repetitive Pulses measurement procedure.

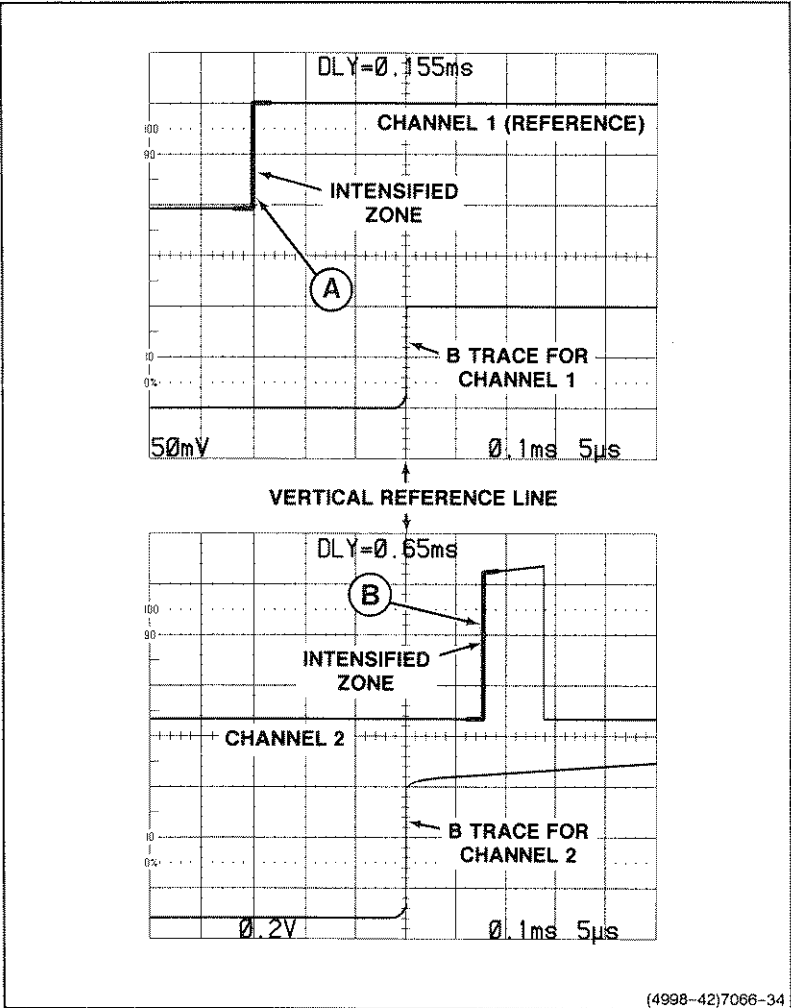

(4998-42)7066-34

Figure 6-13. Time difference between two time-related pulses, differential time method.

DIGITAL STORAGE MEASUREMENTS

The following procedures will enable the operator to perform some basic measurements and familiarize the operator with digital storage measurement techniques.

VOLTAGE

Ac Peak-to-peak Voltage Using Cursors

NOTE

Either channel input connector may be used for the signal input. Use the VERTICAL MODE switches to select the appropriate channel for display.

1. Preset instrument controls and obtain a baseline trace.
2. Set the STORE/NON-STORE switch to the STORE position (button in).
3. Select a VOLTS/DIV switch setting that gives the desired vertical deflection.
4. Set the A SEC/DIV switch to display several cycles of the waveform.
5. Two cursors are displayed on the waveform to be measured. The boxed cursor is the active (selected) cursor.
6. Use the CURSORS control to move the active cursor to either peak of the waveform.
7. Push in the CURSORS knob (SELECT C1/C2) to select the other cursor, and use the CURSORS control to move the cursor to the opposite peak of the waveform (see Figure 6-14).

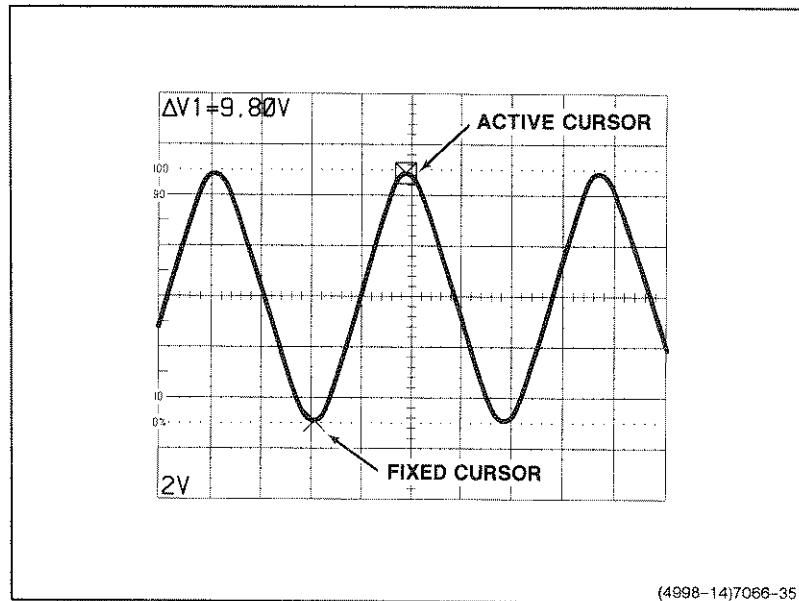

Figure 6-14. Ac peak-to-peak voltage, cursor method.

NOTE

After the waveform is acquired, the SAVE Storage mode may be selected. This mode holds the waveform frozen and reduces the amount of cursor jitter seen in the display. The SAVE display may be expanded horizontally and vertically for a more detailed examination of the waveform (see SAVE Mode Display).

8. Read the peak-to-peak amplitude from the ΔV readout. If the VOLTS/DIV Variable control is out of the calibrated detent, the ΔV readout switches to a ratio.

Ground-Referenced Dc Voltage

NOTE

Either channel input connector may be used for the signal input. Use the VERTICAL MODE switches to select the appropriate channel for display.

1. Preset instrument controls and obtain a baseline trace.
2. Determine the polarity of the voltage to be measured as follows:
 - a. Set the AC-GND-DC switch to GND and vertically position the baseline trace to the center horizontal graticule line.
 - b. Set the AC-GND-DC switch to DC.

If the waveform moves above the center line of the crt, the voltage is positive.

If the waveform moves below the center line of the crt, the voltage is negative.

3. Set the AC-GND-DC switch to GND and the STORE/NON-STORE switch to STORE mode (button in). If the channel signal is being used as the internal trigger source, ensure that the TRIGGER Mode switch is set to P-P AUTO.
4. Use the appropriate channel Vertical POSITION control to move the baseline trace to a convenient reference line. For example, if the voltage to be measured is positive, position the baseline trace to the bottom graticule line; if the voltage is negative, position the baseline trace to the top graticule line; and if the voltage is an alternating signal, position the baseline trace to the center graticule line.

NOTE

If the ground reference is set more than ± 5 divisions from the center horizontal graticule line, the ground reference will not be stored. When using ADD VERTICAL MODE, both channel input coupling switches must be in GND to store a ground reference.

5. Set the selected channel AC-GND-DC switch to DC. An intensified ground reference dot is visible at the left edge (the first sample location of the waveform display) of the crt graticule.

NOTE

If the vertical position of the display is moved after the ground reference is stored, the displayed ground reference is no longer a valid reference. Also, the accuracy of the ground reference is affected by dc offsets due to thermal drift and balance (DC and INVERT) adjustments. Additionally, if the AC-GND-DC switch is set to AC, the location of the ground reference indicates the average value of the ac component of a waveform.

6. Use the CURSORS control to move the active cursor to the ground reference point.
7. Push in the CURSORS knob (SELECT C1/C2) to select the other cursor. The nonmoving cursor is now the 0-volt reference for making measurements on the waveform.
8. Use the CURSORS control to move the active cursor to the point of interest on the waveform (see Figure 6-15).
9. Read the unsigned dc voltage from the readout.

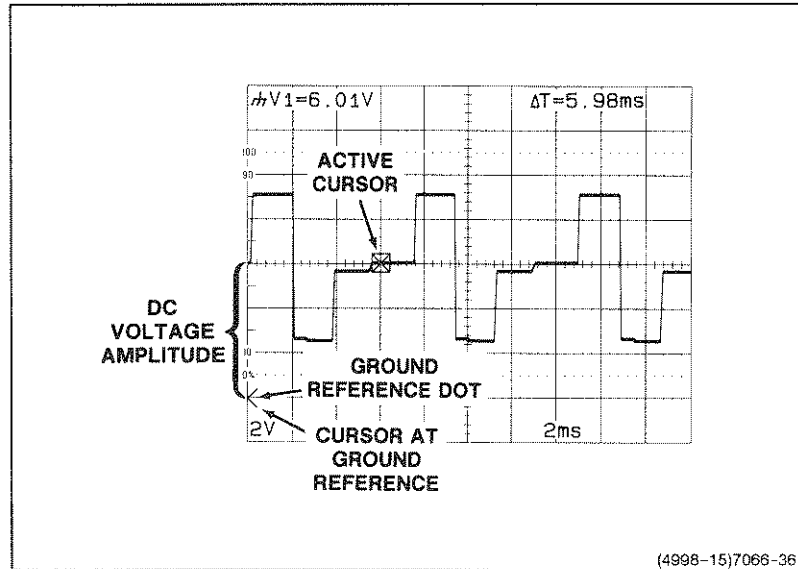

Figure 6-15. Ground-referenced dc voltage, cursor method.

TIMING

Time Duration

1. Preset instrument controls and obtain a baseline trace.
2. Set the STORE/NON-STORE switch to the STORE position (button in).
3. Select a VOLTS/DIV switch setting that gives the desired vertical deflection.
4. Set the A SEC/DIV switch to display one complete period of the waveform to be measured (see Figure 6-16).

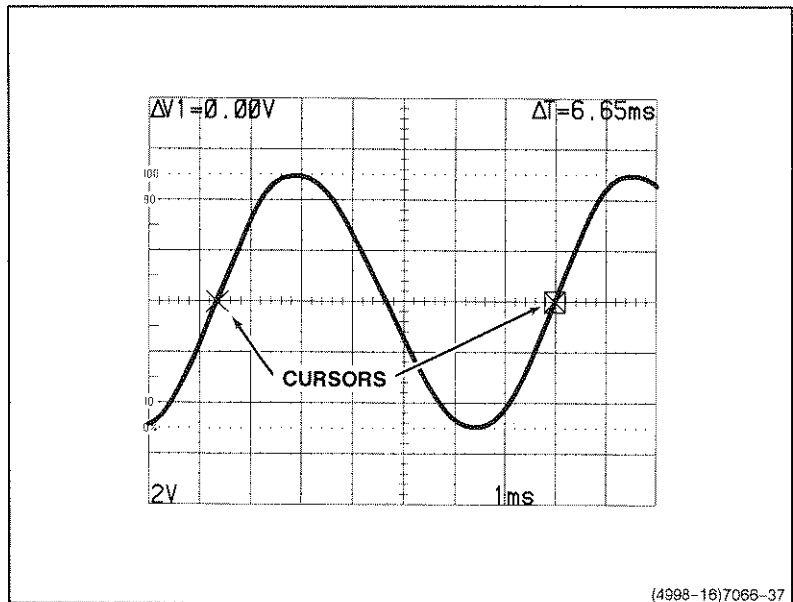

Figure 6-16. Time duration, cursor method.

5. Check that the time measurement mode is set to ΔT . (At power-up, the default is ΔT .) If not, push the DISPLAY SETUP button, then use the SAVE REF button to select ΔT on the Display Menu. Push the DISPLAY SETUP button again to return to standard (non-menu) operating mode.
6. Use the CURSORS control to move the active cursor to the start of the time to be measured.
7. Push in the CURSORS knob (SELECT C1/C2) to select the other cursor, and use the CURSORS control to move the cursor to the end of the time to be measured.
8. Read the time duration (between the cursors) from the crt readout.

Frequency

1. Preset instrument controls and obtain a baseline trace.
2. Set the STORE/NON-STORE switch to the STORE position (button in).
3. Select a VOLTS/DIV switch setting that gives the desired vertical deflection.
4. Set the A SEC/DIV switch to display one complete period of the waveform to be measured.
5. Push the DISPLAY SETUP button, then use the SAVE REF button to select 1/ Δ T on the Display Menu. Push the DISPLAY SETUP button again to return to standard (non-menu) operating mode.
6. Use the CURSORS control to move the active cursor to the start of the frequency to be measured.
7. Push in the CURSORS knob (SELECT C1/C2) to select the other cursor, and use the CURSORS control to move the cursor to the end of the frequency to be measured.
8. Read the frequency (between the cursors) from the crt readout.

Rise Time

Rise-time measurements use the same methods as time duration, except that the measurements are made between the 10% and 90% points on the leading edge of the waveform. Fall time is measured between the 90% and 10% points on the waveform trailing edge.

1. Preset instrument controls and obtain a baseline trace.
2. Set the STORE/NON-STORE switch to the STORE position (button in).
3. Select the appropriate display window and Trigger SLOPE settings that will display the leading edge of the waveform at the start of the trace.

- Set the SEC/DIV switch for a single-event display, with the rise time spread horizontally as much as possible within the viewing area. The waveform's maximum and minimum levels must still be visible (see Figure 6-17).

NOTE

Pulses with fast rise times have only a few sample points on the leading edge, and it may not be possible to place the cursor at exactly the 10%, 80%, 90%, or 100% points.

- Use the CURSORS control to move the active cursor to the minimum level of the waveform.
- Push in the CURSORS knob (SELECT C1/C2) to select the other cursor, and use the CURSORS control to move the active cursor to the maximum level of the waveform.

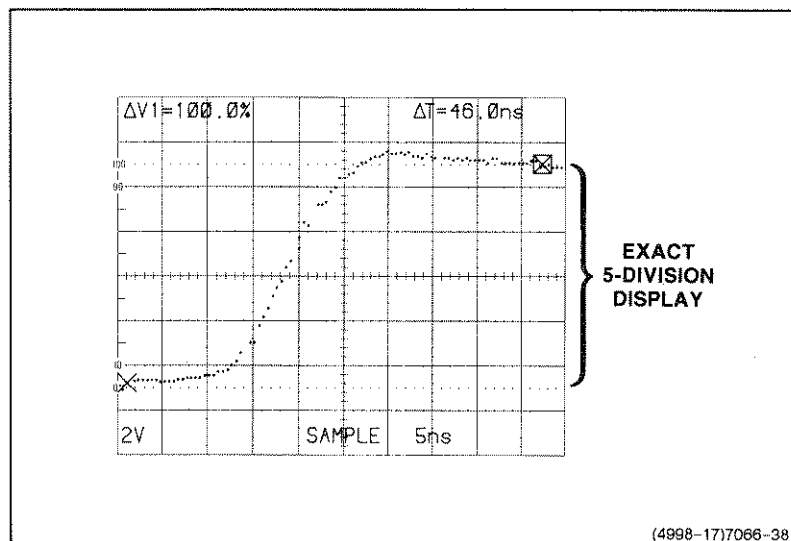

Figure 6-17. Rise-time setup, five-division display.

Basic Applications

7. Set the VOLTS/DIV switch and the VOLTS/DIV Variable control (or signal amplitude) for a ΔV readout of 100%.

NOTE

SAVE may be selected with the SAVE/CONT button (readout displays "SAVE") to save the selected waveform for as long as desired. Voltage and time measurements may be made on the SAVE waveform with less trigger jitter.

8. Use the CURSORS control to move the active cursor down the waveform's leading edge until the ΔV readout is 90%.
9. Push in the CURSORS knob (SELECT C1/C2) to select the other cursor, and use the CURSORS control to move the active cursor up the waveform's leading edge until the ΔV readout is 80% (see Figure 6-18).

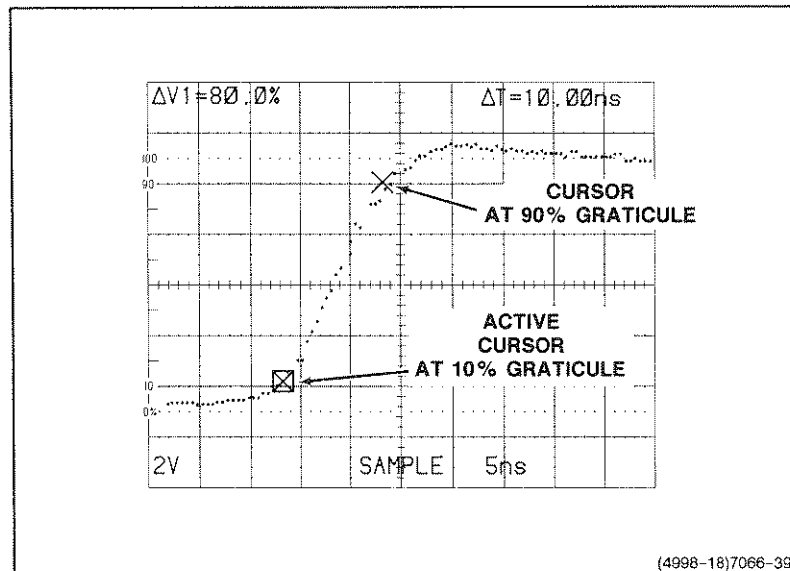

Figure 6-18. Rise time, cursor method.

10. Read the pulse rise time from the crt delta time readout.

Waveform Comparison

Repeated comparisons of newly acquired signals with a reference signal for amplitude, timing, or pulse-shaped analysis may be easily and accurately made using the SAVE REF function of the instrument.

1. Preset instrument controls and obtain a baseline trace.
2. Set the STORE/NON-STORE switch to the STORE position (button in).
3. Select a VOLTS/DIV switch setting that gives the desired vertical deflection.
4. Set the A SEC/DIV switch to display the reference signal with the desired sweep rate.
5. Push in the SAVE REF button.
6. Push in the Number 1 Reference button to store the reference waveform into reference memory 1.
7. Acquire the waveform that is to be compared with the reference waveform.

NOTE

A stored reference will remain displayed until the Reference button for the stored reference is again pushed. Switching the instrument to NON-STORE removes stored waveforms from the display, but the saved reference waveforms remain in the digital storage memory for use upon return to a storage mode. A new reference waveform is saved when the SAVE REF button and then a Reference button are pushed.

8. Use the selected channel's Vertical POSITION control to overlay the newly acquired waveform on the reference waveform for

Basic Applications

making the comparison (see Figure 6-19). The vertical deflection and sweep rate remain calibrated to allow direct measurement from the graticule, or cursors may be used to determine voltage or time differences.

9. The acquisition waveform display may be positioned horizontally for comparison with the reference signal by using the following procedure:
 - a. Use the B TRIGGER LEVEL control to set the B TRIGGER Source to Starts After Delay.
 - b. Set the HORIZONTAL MODE switch to B.
 - c. Leave the A and the B SEC/DIV knobs locked together and use the B DELAY TIME POSITION control to move the acquisition waveform display horizontally.

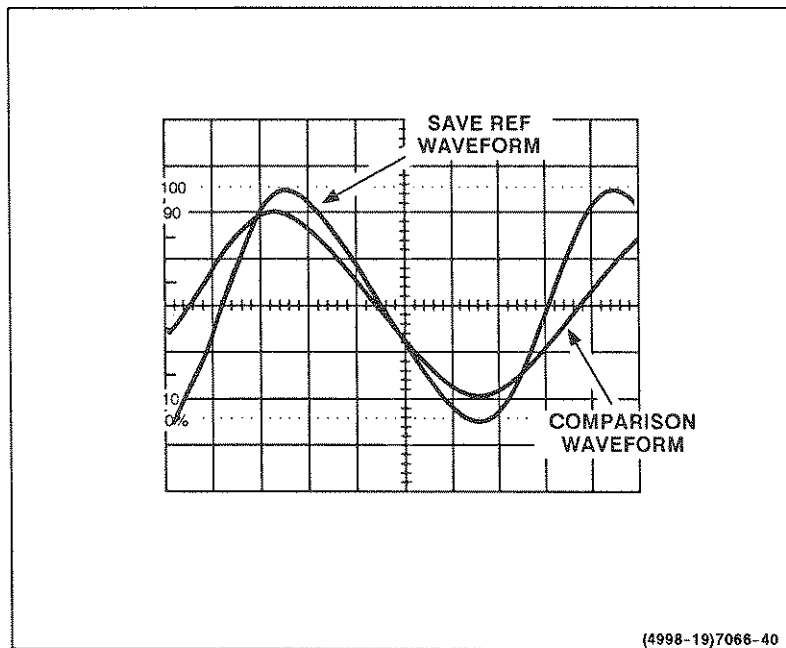

Figure 6-19. Waveform comparison.

Time Difference Between Repetitive Pulses

1. Preset instrument controls and obtain a baseline trace.
2. Set the STORE/NON-STORE switch to the STORE position (button in).
3. Select a VOLTS/DIV switch setting that gives about 5 divisions of display amplitude.
4. Use the selected channel Vertical POSITION control to center the display.
5. Set the A SEC/DIV switch to display the points of interest between which the measurement is to be made.
6. Select SAVE with the SAVE/CONT button (readout displays "SAVE") to hold the acquired waveform and to provide a more stable display for measurement.
7. Use the CURSORS control to move the active cursor to the 50% level on the leading edge of the first pulse.
8. Push in the CURSORS knob (SELECT C1/C2) to select the other cursor and use the CURSORS control to move the active cursor to the 50% level on the leading edge of the second pulse (see Figure 6-20).

NOTE

Pulses with fast rise times have only a few sample points on the leading edge, and it may not be possible to place the cursor dot at exactly the 50% level.

9. Read the time difference between pulses from the crt readout.

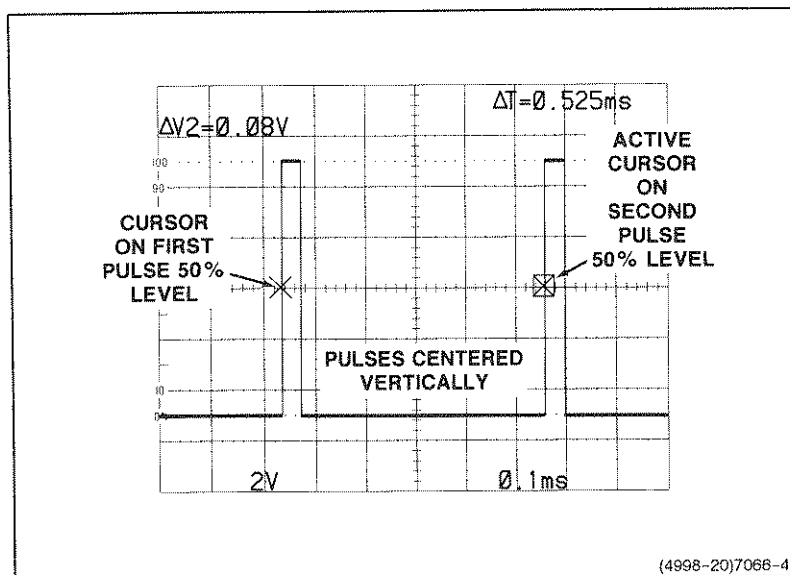

Figure 6-20. Time difference between repetitive pulses.

Time Difference Between Two Time-Related Pulses

1. Set the VERTICAL MODE switches to BOTH and ALT.
2. Use probes or coaxial cables with equal time delay to apply the pulse signals to be measured to the input connectors; one to Channel 1 and the second to Channel 2.
3. Set the VOLTS/DIV switches to obtain about three divisions of display amplitude for each signal.
4. Set the STORE/NON-STORE switch to STORE (button in), set the A TRIGGER Mode switch to NORM, set the A&B SOURCE switch to CH 1, and set the A COUPL switch to NORM.
5. Adjust the A TRIGGER LEVEL and SLOPE control for a continuous, triggered acquisition of the signals.

6. Set the A SEC/DIV switch to obtain a display of the measurement points on the two pulses between which the measurement is to be made.
7. Press the TRIG POS button to select PRETRIG, MIDTRIG, or POST TRIG as required to obtain the entire pulse display.
8. Select SAVE with the SAVE/CONT button (readout displays "SAVE") to save the waveform and to present a more stable display for measurement. Cursors will appear on both the Channel 1 and Channel 2 traces in SAVE mode.
9. Use the CURSORS control to move the active cursor to the 50% point of the Channel 1 pulse leading edge.

NOTE

Pulses with a fast rise time have only a few sample points on the leading edge, and it may not be possible to place the dot at exactly the 50% level on the leading edge.

10. Push in the CURSORS knob (the SELECT C1/C2) to select the other cursor, and use the CURSORS control to position the active cursor at the 50% level of leading edge of the Channel 2 pulse (see Figure 6-21).
11. Read the time difference between the pulses from the crt readout.

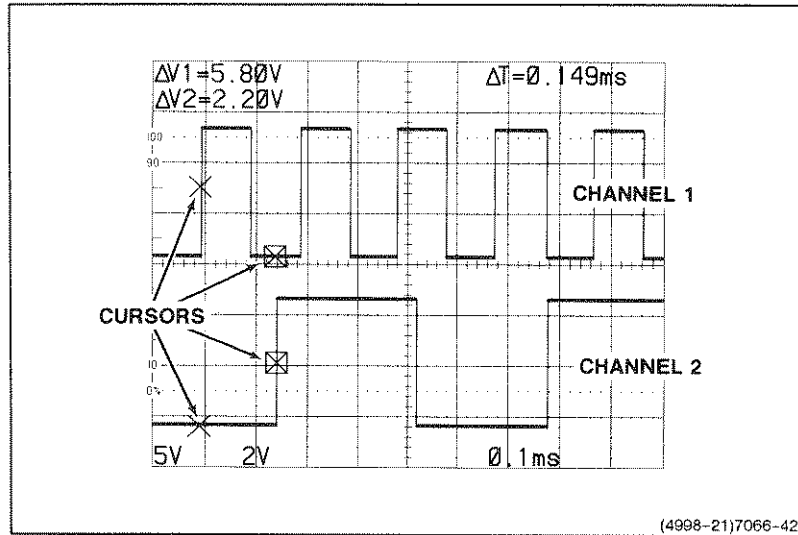

Figure 6-21. Time difference between two time-related pulses.

Phase Difference Between Sinusoidal Signals

1. Preset instrument controls and obtain a baseline trace.
2. Using probes or coaxial cables with equal time delay, connect the reference signal to the CH 1 OR X input connector and the other (phase-shifted) signal to the CH 2 OR Y input connector.
3. Select a VERTICAL MODE of BOTH and ALT or CHOP, depending on the input signal frequencies.
4. Set the A&B SOURCE switch to the CH 1 position and adjust the A TRIGGER LEVEL control and the A TRIGGER SLOPE control for a stable, triggered display.
5. Use a SEC/DIV switch setting that displays about two cycles of each input signal.
6. Set the STORE/NON-STORE switch to the STORE position (button in).

7. Check that the A TRIGGER LEVEL control is adjusted for a stable, triggered acquisition.

NOTE

Use the NORM Trigger Mode for low-repetition-rate signals (below approximately 20 Hz). This ensures that the storage window and trigger signal are synchronized when the trace is triggered.

8. Set both VOLTS/DIV switches and adjust the VOLTS/DIV Variable controls to obtain a 5-division vertical display of each input signal.

NOTE

Use the Vertical POSITION controls in conjunction with the VOLTS/DIV Variable controls to vertically center the 5-division display between the 0% and 100% dotted reference graticule lines.

9. Set the TRIG POS switch (PRETRIG, MIDTRIG, POST TRIG) and A TRIGGER SLOPE switch as necessary to place the measurement points within the graticule area (see Figure 6-22A).
10. Select SAVE with the SAVE/CONT button (readout displays "SAVE").
11. Use the CURSORS control to move the active cursor to the sine wave's first zero-crossover point (center horizontal graticule line).
12. Push in the CURSORS knob (SELECT C1/C2) to select the other cursor, and use the CURSORS control to position the active cursor to the sine wave's third zero-crossover point (360°).
13. Note the time of the sine-wave period (T_1) from the crt readout.

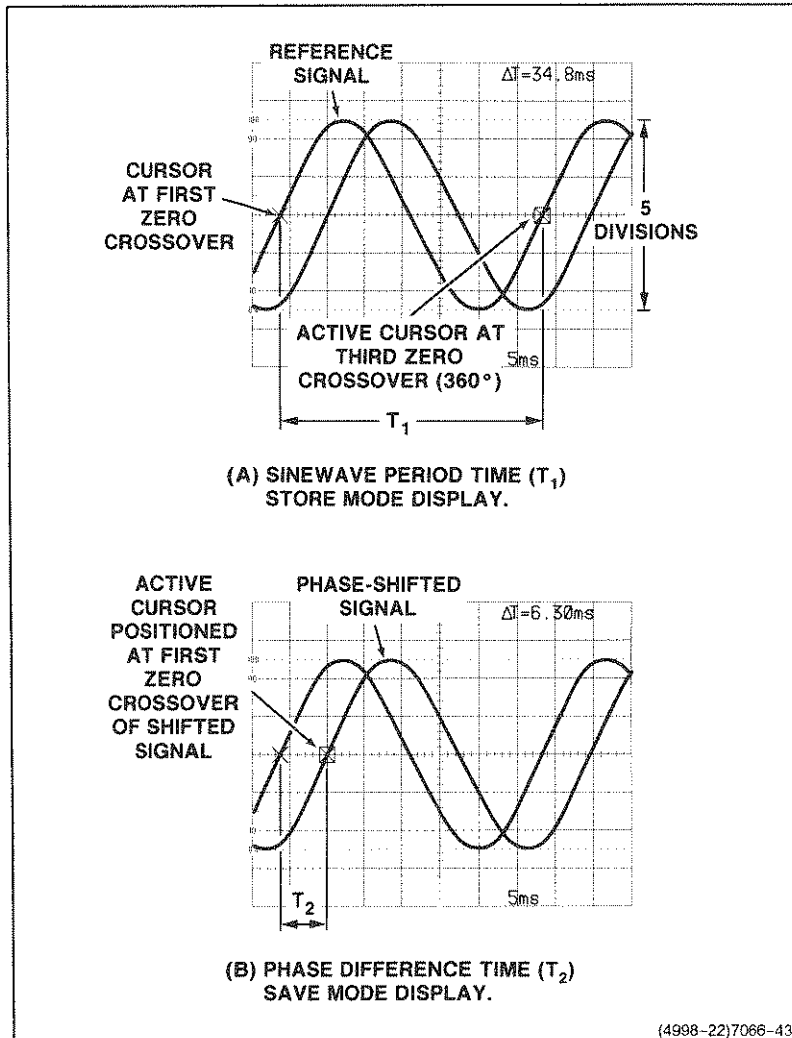

Figure 6-22. Phase difference between sinusoidal signals.

14. Use the CURSORS control to position the active cursor to the first zero-crossover point of the phase-shifted signal (see Figure 6-22B).
15. Note the phase-difference time (T_2) from the crt readout.
16. The amount of phase shift in degrees is calculated from the following formula:

$$\text{Phase shift (degrees)} = \frac{T_2}{T_1} \times 360^\circ$$

EXAMPLE: The period (T_1) of the reference signal shown in Figure 6-22 is 34.8 ms, and the phase-difference time (T_2) is 6.3 ms.

Substituting these values into the equation:

$$\begin{array}{l} \text{Phase} \\ \text{Shift} \\ \text{(degrees)} \end{array} = \frac{6.3 \times 10^{-3} \text{ s}}{34.8 \times 10^{-3} \text{ s}} \times 360^\circ = 65.17^\circ$$

Slope

The slope of a particular portion of a waveform is the rate of change of voltage with respect to time. The following procedure is useful for making the measurements required for determining the slope of a portion of a waveform.

1. Preset instrument controls and obtain a baseline trace.
2. Set the STORE/NON-STORE switch to the STORE position (button in).
3. Set the VOLTS/DIV switch to obtain about 5 divisions of vertical amplitude.
4. Set the A SEC/DIV switch to horizontally spread the portion of the waveform to be measured across the width of the graticule area (see Figure 6-23).

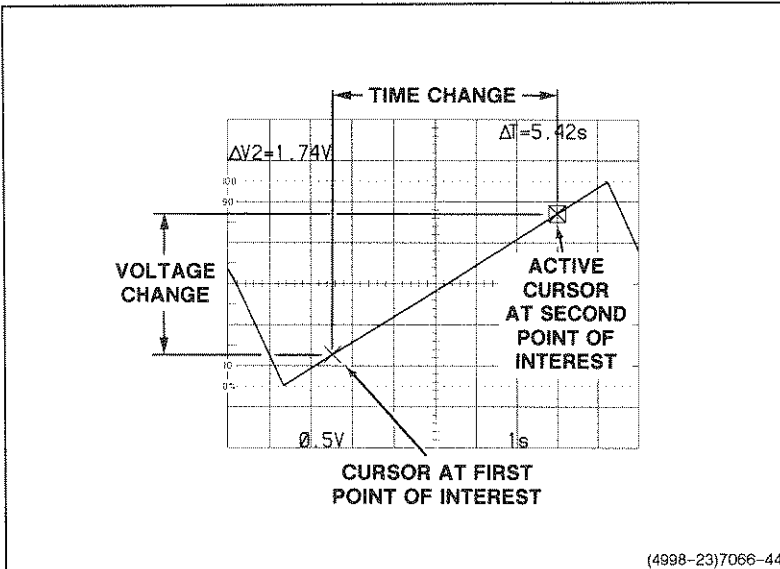

Figure 6-23. Slope using cursors.

5. Select SAVE with the SAVE/CONT button (readout displays "SAVE") to save the acquired waveform and to provide a more stable display for measurement.
6. Use the CURSORS control to move the active cursor to the first point of interest.
7. Push in the CURSORS knob (SELECT C1/C2) to select the other cursor, and use the CURSORS control to position the cursor to the second point of interest.
8. Read the voltage difference between cursors from the crt readout.
9. Read the time difference between the two measurement points from the crt readout.

10. Slope is determined by using the measured voltage and time to calculate the rate of change using the following formula:

$$\text{Slope (rate of change)} = \frac{\text{Change in voltage}}{\text{Change in time}}$$

As an example, in Figure 6-23, the voltage difference between the measurement points is 1.74 V, and the time difference is 5.42 s.

Substituting these values into the formula:

$$\text{Slope} = \frac{1.74 \text{ V}}{5.42 \text{ s}} = 0.32 \text{ V/s}$$

LOW-LEVEL SIGNALS

A displayed signal acquired in STORE mode at 5 mV per division may be vertically expanded up to 10 times by using the Menu. Figure 6-24 is an illustration of a 4 mV peak-to-peak signal being displayed at 2 mV per division. The stair-step pattern is due to the small changes of signal applied to the digitizing circuitry when STORE mode is used to acquire the waveform. The numerous spikes in the waveform are due to the noise accompanying the signal.

The AVERAGE Processing mode may be used to reduce, or even eliminate, the noise displayed with the signal. Even though the signal-level changes applied to the digitizing circuitry are small, processing of the average waveform data results in a smooth display of the signal.

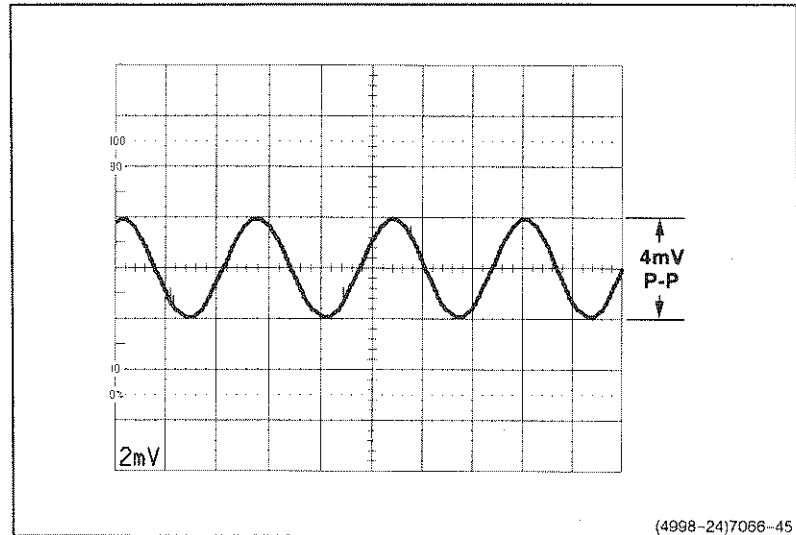

Figure 6-24. Low-level signal, STORE mode.

Figure 6-25 is an illustration of the same signal level as displayed in Figure 6-24, but the waveform was averaged before being displayed. Low-level signals can be acquired in the same manner as explained in previous acquisition procedures. External triggering may be helpful for producing a stable display if the amplitude of the signal being acquired is very low. All measurement procedures described in the preceding part of this manual are also valid for low-level signals.

The AVERAGE processing mode is front panel (MODE) or menu-selectable (refer to the preceding AVERAGE Mode Display procedure). Also, it is the default processing mode with the SEC/DIV control set at $0.05 \mu\text{s}/\text{div}$ to $0.5 \mu\text{s}/\text{div}$ with CH 1 or CH 2 selected (or to $0.2 \mu\text{s}$ with ALT or CHOP VERTICAL MODE selected).

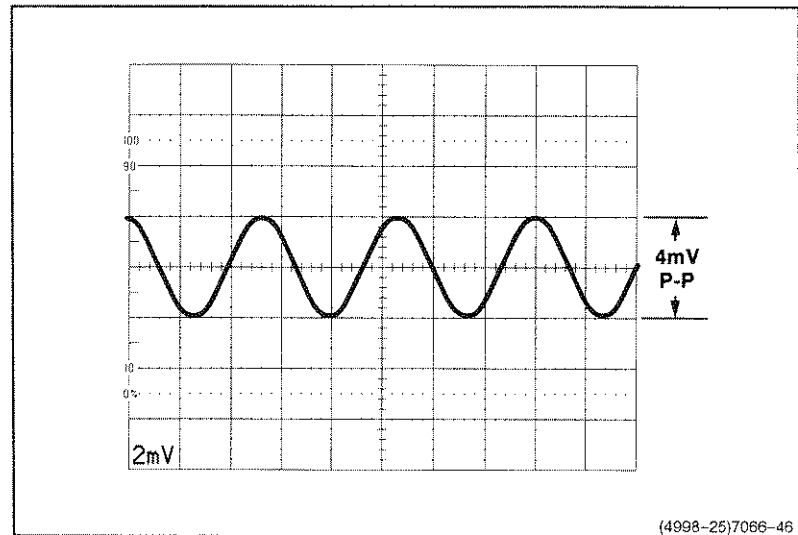

Figure 6-25. Low-level signal, AVERAGE mode.

OBSERVING AND REMOVING ALIASES IN STORE MODE

Aliasing

This discussion assumes the acquisition mode is set to *SAMPLE*, either via the Menu or by default. In digital sampling, the accuracy of the reproduced waveform, when displayed, increases with the number of samples obtained during one full cycle of the signal. That is, a more accurate reproduction of a signal is possible when more samples of the signal are obtained. The instrument displays 1000 samples across the full 10 horizontal divisions of the graticule when in the *STORE* mode. This means that a sine wave spread across the full screen is sampled 1000 times, but if the sine wave is only one graticule division in width, it will be sampled one-tenth as many times (100 samples). This number is still adequate for accurate reproduction of the stored waveform.

Basic Applications

If the SEC/DIV switch is set so that the entire sine-wave period fills one-tenth of a graticule division, it is sampled only 10 times during its acquisition. This means that only ten samples of the waveform will be available to reproduce the waveform for display. In theory, if a sine wave is sampled at least two times during its period, it may be accurately reproduced. In practice, the sine wave can be reconstructed, using special filters, from slightly more than two samples.

At 1 μ s per division, the instrument's SAMPLE mode has a useful storage bandwidth of 10 MHz and a maximum sampling rate of 100 MS/s. Consequently, a signal at the upper frequency limit is sampled a minimum of 10 times during the complete sine-wave period (20 times for 2 periods), and the waveform will be accurately reproduced.

If the input frequency is increased beyond 40 MHz, the samples will soon become less than two times per period. This occurs at 50 MHz for a 100 MS/s sample rate. Past this point, information sampled from two different sine-wave periods would be used to reconstruct the displayed waveform. Obviously, this waveform could not be a correct reproduction of the input signal. At certain input frequencies the data sampled would reproduce what appears to be a correct display, when in fact it was only related to the input signal by some multiple or part of a multiple of the input signal. This type of display is one type of alias (see Figure 6-26A).

The example given is for the maximum sampling rate of 100 MS/s. However, the sampling rate is controlled by the SEC/DIV switch, and whenever it is set so that the input signal is sampled less than 10 times per period of the fastest frequency component, observable aliases occur.

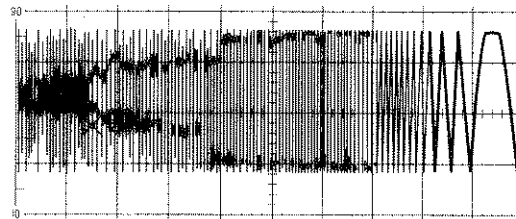

(A) POSSIBLE ALIAS SIGNAL IN STORE MODE.

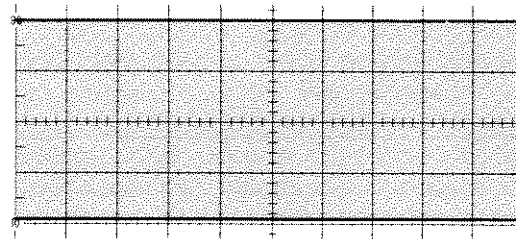

(B) NON STORE DISPLAY.

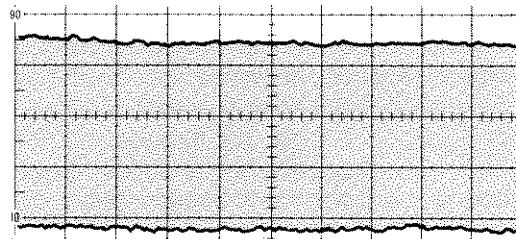

(C) ALIAS SIGNAL DISPLAY IN ACCPEAK STORE MODE.

(4998-26)7066-47

Figure 6-26. Anti-aliasing.

Anti-aliasing

In the event that an alias is suspected, three things may be done to determine whether the display is of an alias. The first is to switch back to NON-STORE mode to determine if the input signal is higher in frequency than the apparent signal being displayed (see Figure 6-26B). Ensure that this display is being triggered as indicated by the TRIG'D LED being illuminated. The second is to use either the ACCPEAK or the PEAKDET storage modes (PEAKDET is the default mode for SEC/DIV settings from 5 s per division to 5 μ s per division), which hold the maximum, and minimum points being acquired. PEAKDET storage mode holds the maximum and minimum points acquired in a single trigger cycle, and ACCPEAK accumulates the maximum and minimum points acquired over many trigger cycles. Since the maximum and minimum points of the alias waveform do not occur at exactly the same point in relation to the trigger each time, the display soon acquires maximum and minimum amplitude levels in every storage address and the top and bottom of the alias display become flat lines (see Figure 6-26C).

Third, if an alias is detected, the SEC/DIV switch may be set for a faster sweep rate so that the number of samples per cycle of the input signal is increased. However, at sweep speeds of 1 μ s per division and faster, the sampling rate is not increased; and if an alias signal is still present at 5 μ s per division, the frequency limit of the digital circuitry has been exceeded for nonrepetitive signals. When the SEC/DIV switch is set for sweep speeds faster than 1 μ s/div, Repetitive Storage mode and AVERAGE are selected. On repetitive signals, the random phase between successive triggers and the time-base clock suppress aliased waveform displays as a result of the increased effective sample rate.

GLITCHES AND PULSES

Glitch Catching

Pulses that are present for a very short time duration during the viewing of longer pulse duration signals, such as a logic pulse train,

may not be visible at the sweep speed in use (see Figure 6-27A). In digital logic circuitry, a small switching transient (glitch) may cross the logic threshold level and cause an error. Setting up the instrument to trigger on the error event should position the storage window to acquire the pulse train that contains the glitch.

To catch a glitch, first select PRETRIG ACQUISITION mode. This will acquire 7/8 of a waveform occurring before the trigger. Select ACCPEAK mode using the Menu. This will acquire the waveform maximum and minimum points over a selected number of sweeps. The location of the glitch will be displayed in the accumulative envelope display (see Figure 6-27B).

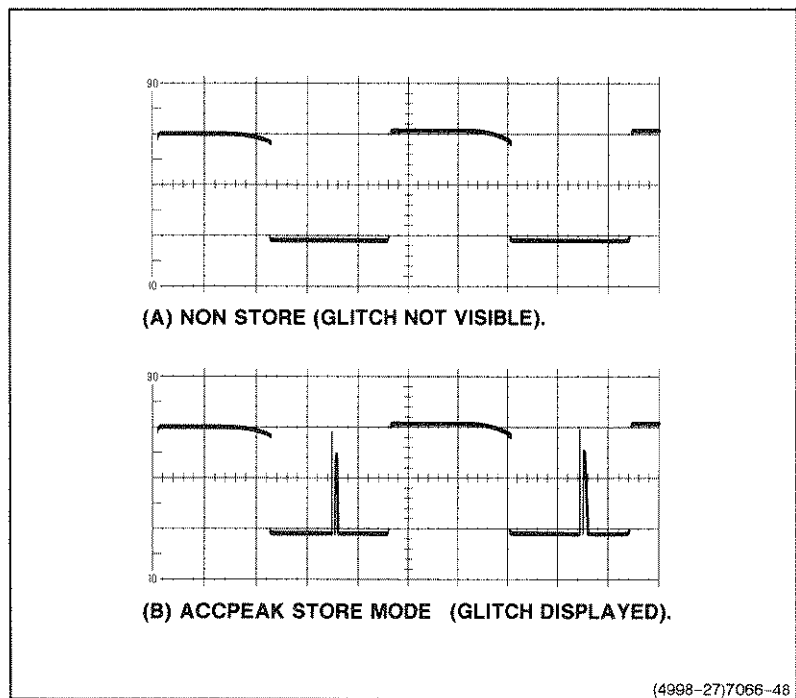

Figure 6-27. Glitch display, ACCPEAK Store mode.

Glitch Measurement

Once a glitch has been observed, you may wish to obtain measurements of amplitude and pulse width. The following procedure may be used to acquire the glitch in STORE mode using delayed sweep. By selecting appropriate trigger sources, the procedure may be used for any similar waveform situation (i.e., selecting triggers that set up a storage window containing the pulse, or glitch, to be acquired).

To view the glitch in the pulse train for measurement purposes:

1. Preset instrument controls and obtain a baseline trace, with the following exceptions:

STORE/NON-STORE	STORE (button in
TRIG MODE	NORM
A&B SOURCE	A EXT (error event)
HORIZONTAL MODE	BOTH

2. Adjust the A TRIGGER SLOPE and LEVEL controls for a stable display of the A trace. Set the B TRIGGER LEVEL control fully cw.
3. Set the A SEC/DIV switch to display the portion of the pulse train containing the glitch. Pull the B SEC/DIV knob to unlock it from the A SEC/DIV switch, and set the B SEC/DIV switch to reduce the intensified zone to the size of the area of interest (see Figure 6-28A).
4. Use the B DELAY TIME POSITION control to move the intensified zone to the area of the signal containing the glitch.
5. Set the HORIZONTAL MODE switch to B.
6. Using the Menu or MODE button, select either PEAKDET or ACCPEAK Acquisition mode.
7. Adjust the INTENSITY control as necessary for desired display brightness. The glitch should be seen in the display (see Figure 6-28B). It may be expanded further by setting the B SEC/DIV switch to faster sweep speeds (see Figure 6-28C).

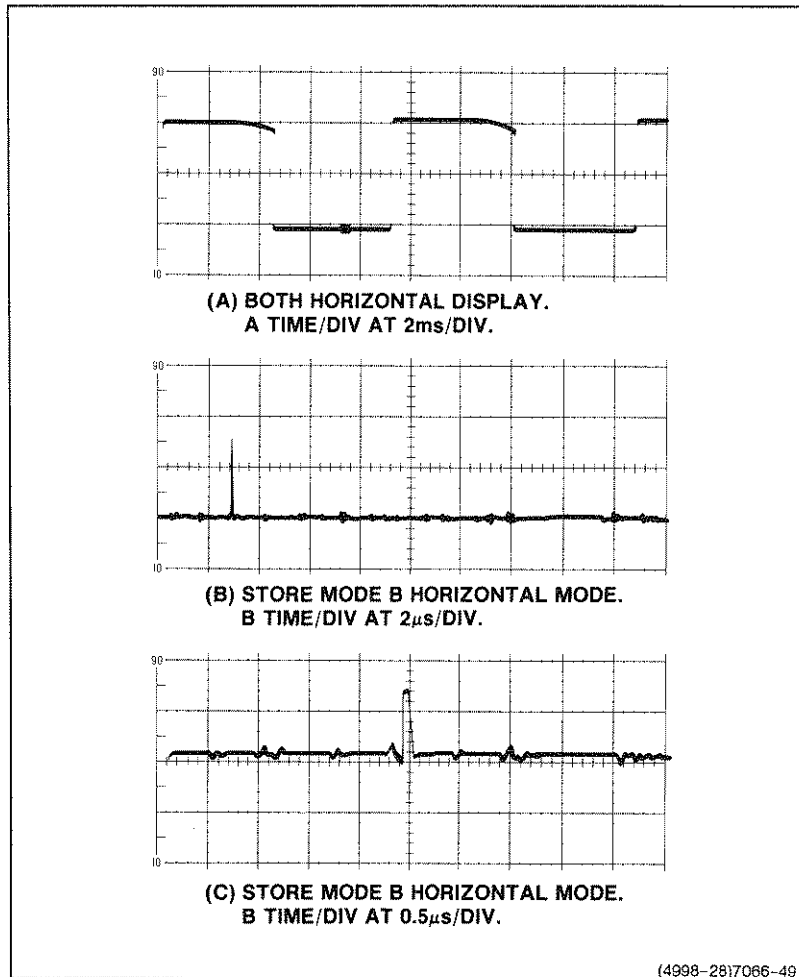

Figure 6-28. Glitch display, STORE mode using B HORIZONTAL MODE.

Basic Applications

8. Select SAVE with the SAVE/CONT button (readout displays "SAVE") to hold the acquired waveform and provide a more stable display for measurement. The SAVE ACQUISITION mode display may be horizontally expanded up to 10 times using the SEC/DIV switch (if enough SEC/DIV switch positions remain) and vertically expanded up to 10 times, using the VOLTS/DIV switch associated with the channel from which the signal was acquired.

NOTE

PEAKDET Acquisition mode will catch at least 50% of the amplitude of a pulse as narrow as 20 ns. If the glitch is repetitive, its shape may be observed at sweep speeds faster than 1 μ s per division (REPETITIVE Store sampling).

Missing Pulse

ACCPEAK mode is useful for finding an intermittent pulse in a pulse train. The pulse may either be missing or present erratically. In either case, the change in amplitude levels is displayed as a completely filled in pulse (see Figure 6-29).

1. Preset instrument controls and obtain a baseline trace.
2. Set the STORE/NON-STORE switch to the STORE position (button in).
3. Select the triggers, SEC/DIV setting, and storage window (PRETRIG, MIDTRIG, or POST TRIG) to display the pulse train of interest.
4. Select ACCPEAK acquisition mode using the Menu or MODE button.

If the waveform acquired is repetitive, each pulse in it will show only the pulse outline. A pulse missing or present part of the time will show a completely filled display at the pulse location. Pulse breakdown (erratic changes in amplitude or width) will also be displayed by this storage mode.

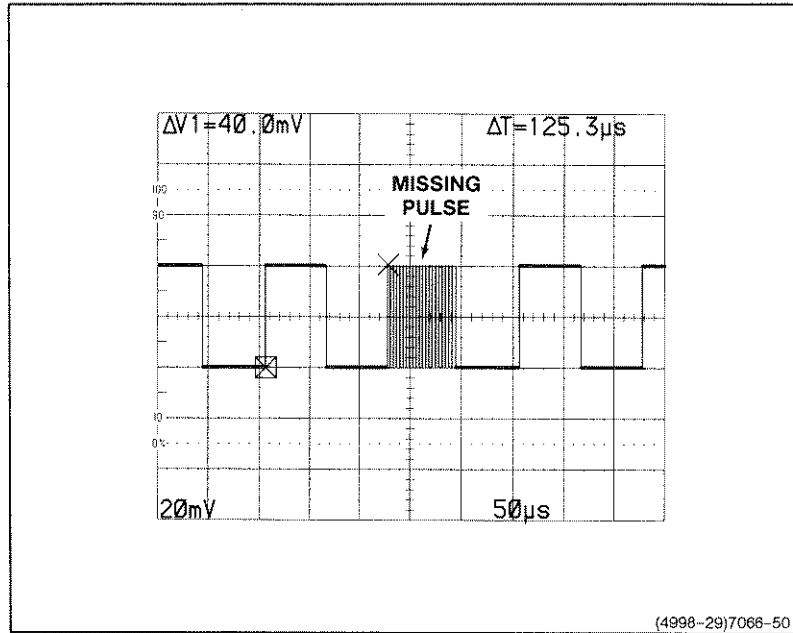

(4998-29)7068-50

Figure 6-29. Missing pulse, ACCPEAK STORE mode.

SECTION 7

**PERFORMANCE
CHARACTERISTICS**

2232 Operators

INTRODUCTION

The following electrical characteristics (Table 7-1) are valid when the instrument has been adjusted at an ambient temperature between +20°C and +30°C (+68°F and 86°F), has had a warm-up period of at least 20 minutes, and is operating at an ambient temperature between 0°C and +50°C (32°F and 122°F) (unless otherwise noted).

Items listed in the "Performance Requirements" column are verifiable qualitative or quantitative limits that define the measurement capabilities of the instrument.

Environmental characteristics are given in Table 7-2. This instrument meets the requirements of MIL-T-28800D for Type III, Class 5 equipment, except where noted otherwise.

Physical characteristics of the instrument are listed in Table 7-3.

Performance Characteristics

**Table 7-1
Electrical Characteristics**

Characteristics	Performance Requirements
VERTICAL DEFLECTION SYSTEM	
Deflection Factor Range	2 mV per division to 5 V per division in a 1-2-5 sequence.
DC Accuracy (NON-STORE)	
+ 15°C to + 35°C	± 2%.
0°C TO + 50°C	± 3%. ^a For 5 mV per division to 5 V per division VOLTS/DIV switch settings, the gain is set at a VOLTS/DIV switch setting of 10 mV per division. 2 mV per division gain is set with the VOLTS/DIV switch set to 2 mV per division.
On Screen DC Accuracy (STORE)	
+ 15°C to + 35°C	± 2%.
0°C TO + 50°C	± 3%. ^a Gain set with the VOLTS/DIV switch set to 5 mV per division.
Range of VOLTS/DIV Variable control	Continuously variable between settings. Increases deflection factor by at least 2.5 to 1.
Linearity (Relative to center screen)	Within ± 5%. Linearity is measured by positioning a two-division test signal anywhere on screen and noting the amplitude change.

^a Performance Requirement not checked in manual.

Table 7-1 (cont)

Characteristics	Performance Requirements	
Storage Acquisition Vertical Resolution	8-bits, 25 levels per division. 10.24 divisions dynamic range. ^a	
Step Response (NON-STORE Mode) Rise Time		
0°C TO +35°C		
5 mV per division to 5 V per division	3.5 ns or less. ^a	
2 mV per division	4.4 ns or less. ^a	
+35°C to +50°C		
5 mV per division to 5 V per division	3.9 ns or less. ^a	
2 mV per division	4.4 ns or less. ^a	
	Rise time is calculated from:	
	Rise Time = $\frac{0.35}{\text{Bandwidth (-3 dB)}}$	
Step Response (STORE Mode) Useful Storage Rise Time		
SAMPLE	Single Trace	CHOP/ALT
	$\frac{\text{SEC/DIV X } 1.6^{\text{a}}}{100} \text{ s}$	$\frac{\text{SEC/DIV X } 1.6^{\text{a}}}{50} \text{ s}$
PEAKDET or ACCPEAK with SMOOTH	$\frac{\text{SEC/DIV X } 1.6^{\text{a}}}{50} \text{ s}$	$\frac{\text{SEC/DIV X } 1.6^{\text{a}}}{25} \text{ s}$
	Rise time is limited to 3.5 ns minimum with derating over temperature (see NON-STORE Rise Time).	

^aPerformance Requirement not checked in manual.

Performance Characteristics

Table 7-1 (cont)

Characteristics	Performance Requirements
Aberrations (NON-STORE and STORE in Default Modes)	
2 mV per division to 50 mV per division	+ 4%, -4%, 4% p-p.
0.1 V per division to 0.2 V per division	+ 6%, -6%, 6% p-p.
0.5 V per division	+ 6%, -6%, 6% p-p. ^a
1 V per division to 5 V per division	+ 12%, -12%, 12% p-p. ^a Measured with a five-division reference signal from a 50-Ω coaxial cable terminated in 50-Ω at the input connector; with the VOLTS/DIV Variable control in the CAL detent. Vertically center the top of the reference signal, Trigger SLOPE set to Positive and positioned on a positive going waveform.
NON-STORE Bandwidth (-3 dB)	
0°C to +35°C	
5 mV per division to 5V per division	DC to at least 100 MHz.
2 mV per division	DC to at least 80 MHz.
+35°C to +50°C	
2 mV per division to 5V per division	DC to at least 80 MHz. ^a Measured with a vertically centered six-division reference signal, from a 50-Ω source driving a 50-Ω coaxial cable terminated in 50-Ω at the input connector; with the VOLTS/DIV Variable control in the CAL detent.

^aPerformance Requirement not checked in manual.

Table 7-1 (cont)

Characteristics	Performance Requirements	
BW LIMIT (-3dB)	20 MHz ±10%.	
AC Coupled Lower Cutoff Frequency	10 Hz or less at -3 dB. ^a	
Useful Storage Performance RECORD, SCAN and ROLL Store Modes SAMPLE Acquisition, no AVERAGE 1 μs per division to 5 s per division EXT CLOCK (up to 100 kHz)	Single Trace $\frac{10}{\text{SEC/DIV}}$ Hz ^a	CHOP/ALT $\frac{5}{\text{SEC/DIV}}$ Hz ^a $\frac{\text{EXT}}{20}$ Hz ^a
<p>Useful storage performance is limited to the frequency where there are 10 samples per sine wave signal period at the maximum sampling rate. (Maximum sampling rate is 100 MHz.) This yields a maximum amplitude uncertainty of 5%. Accuracy at the useful storage bandwidth limit is measured with respect to a six-division 50 kHz reference sine wave.</p>		

^aPerformance Requirement not checked in manual.

Performance Characteristics

Table 7-1 (cont)

Characteristics	Performance Requirements	
Useful Storage Performance (cont)		
PEAK DETECT		
Sine-Wave Amplitude Capture (5% p-p maximum amplitude uncertainty)	10 MHz. ^a	
Pulse Width Amplitude Capture (50% p-p maximum amplitude uncertainty)	10 ns.	
REPETITIVE Store Mode		
SAMPLE and AVERAGE	Single Trace	CHOP/ALT
0.05 μs per division	100 MHz (-3 dB) ^b	100 MHz (-3 dB) ^b
0.1 μs per division	100 MHz (-3 dB) ^{a,b}	50 MHz (-3 dB) ^a
0.2 μs per division to 2 μs per division (5% maximum amplitude uncertainty)	$\frac{10}{\text{SEC/DIV}}$ Hz ^a	$\frac{5}{\text{SEC/DIV}}$ Hz ^a
ACCPEAK		
0.05 μs per division to 5 s per division	Same as NON-STORE Bandwidth ^a	

^aPerformance Requirement not checked in manual.

^bOne hundred MHz bandwidth derated for temperatures outside 0°C to +35°C and at 2 mV per division VOLTS/DIV setting as for NON-STORE.

Table 7-1 (cont)

Characteristics	Performance Requirements
AVERAGE Mode Sweep Limit	Adjustable from 1 to 998,000 or NO LIMIT. Resolution is 1 from 1 to 200; 2 from 202 to 1000; 10 from 1010 to 2000; 20 from 2020 to 10,000; 100 from 10,100 to 20,000; 200 from 20,200 to 100,000; 1000 from 101,000 to 200,000; and 2000 from 202,000 to 998,000. ^a
Weight of Last Acquisition	1/1, 1/2, 1/4, 1/8, 1/16, 1/32, 1/64, 1/128, or 1/256 (MENU selections). AVERAGE mode default weight is 1/4.
Resolution	Assuming uncorrelated triggers and greater than 1 LSB of the 8-bit acquisition of vertical signal noise, the averaging weight for the first acquisition is 1, the averaging weight for the second acquisition is 1/2 and for n acquisitions is $1/2^{n-1}$. The MENU selects the least weight used. Maximum signal-to-noise improvement is achieved after (2 X weight factor) X (expected acquisitions to fill).
NON-STORE CHOP Mode Switching Rate	500 kHz $\pm 30\%$. ^a
A/D Converter Linearity	Monotonic with no missing codes. ^a
NON-STORE Common-Mode Rejection Ratio (CMRR)	At least 10 to 1 at 50 MHz. Checked at 10 mV per division for common-mode signals of six divisions or less with the VOLTS/DIV Variable control adjusted for the best CMRR at 50 kHz.

^a Performance Requirement not checked in manual.

Performance Characteristics

Table 7-1 (cont)

Characteristics	Performance Requirements
Analog CH1/CH2 Delay Match	± 1.0 ns. ^a
Input Current	1 nA or less (0.5 division or less trace shift when switching between DC and GND input coupling with the VOLTS/DIV switch set to 2 mV per division). ^a
Input Characteristics	
Resistance	1 M Ω $\pm 2\%$. ^a
Capacitance	20 pF ± 2 pF. ^a
Maximum Safe Input Voltage (CH 1 and CH 2)	See Figure 7-1 for maximum input voltage vs frequency derating curve.
DC and AC Coupled 	400 V (dc + peak ac) or 800 V ac p-p at 10 kHz or less. ^a
Channel Isolation STORE and NON-STORE	Greater than 100 to 1 at 50 MHz.
POSITION Control Range	At least ± 11 divisions from graticule center.
A/B SWP SEP Control Range (NON-STORE Mode Only)	± 3.5 divisions or greater.
Trace Shift with VOLTS/DIV Switch Rotation	0.75 division or less; VOLTS/DIV Variable control in the CAL detent. ^a
Trace Shift as the VOLTS/DIV Variable Control is Rotated	1 division or less. ^a
Trace Shift with INVERT	1.5 divisions or less. ^a

^aPerformance Requirement not checked in manual.

Table 7-1 (cont)

Characteristics	Performance Requirements		
TRIGGERING SYSTEM			
A Trigger Sensitivity			
P-P AUTO and NORM	10 MHz	60 MHz	100 MHz
Internal	0.35 div	1.0 div	1.5 div
External	40 mV	120 mV	150 mV
	External trigger signal from a 50- Ω source driving a 50- Ω coaxial cable terminated in 50 Ω at the input connector.		
HF REJ Coupling	Reduces trigger signal amplitude at high frequencies by about 20 dB with rolloff beginning at 40 kHz $\pm 25\%$. Should not trigger with a one-division peak-to-peak 250 kHz signal when HF REJ is ON.		
LF REJ Coupling	Attenuates signals below 40 kHz (-3 dB point at 40 kHz $\pm 25\%$). Should not trigger with a 0.35 peak-to-peak 25 kHz signal when LF REJ is on.		
P-P AUTO Lowest Usable Frequency	20 Hz with 1 division internal or 100 mV external. ^a		
TV LINE			
Internal	0.35 div. ^a		
External	35 mV p-p. ^a		
TV FIELD	≥ 1 division of composite sync. ^a		
B Trigger Sensitivity (Internal Only)	10 MHz	60 MHz	100 MHz
	0.35 div	1.0 div	1.5 div

^aPerformance Requirement not checked in manual.

Performance Characteristics

Table 7-1 (cont)

Characteristics	Performance Requirements
EXT INPUT	
Maximum Input Voltage 	400 V (dc + peak ac) or 800 V ac p-p at 10 kHz or less. ^a See Figure 7-1 for maximum input voltage vs frequency derating curve.
Input Resistance	1 M Ω \pm 2%. ^a
Input Capacitance	20 pF \pm 2.5 pF. ^a
AC Coupled Lower Cutoff Frequency	10 Hz or less at -3 dB. ^a
LEVEL Control Range	
A Trigger (NORM)	
INT	May be set at any voltage level of the trace that can be displayed. ^a
EXT, DC	At least \pm 1.6 V, 3.2 V p-p.
EXT, DC \div 10	At least \pm 1.6 V, 3.2 V p-p. ^a
B Trigger (Internal)	May be set at any point of the trace that can be displayed. ^a
VAR HOLDOFF Control (NON-STORE Holdoff)	Increases A Sweep holdoff time by at least a factor of 10. STORE holdoff is a function of microprocessor activity and the pre-trigger acquisition. The VAR HOLD-OFF control maintains some control over the STORE holdoff by preventing a new trigger from being accepted by the storage circuitry until the next (or current, if one is in progress) NON-STORE holdoff has completed.
Trigger Level Readout Accuracy	\pm (3% of 10 times the VOLTS/DIV switch setting). Applies to \pm 10 divisions from zero volts.

^a Performance Requirement not checked in manual.

Table 7-1 (cont)

Characteristics	Performance Requirements												
Acquisition Window Trigger Point Pretrigger	Seven-eighths of the waveform acquisition window is prior to the trigger (other trigger points are selectable via the MENU).												
Midtrigger	One-half of the waveform acquisition window is prior to the trigger (other trigger points are selectable via the MENU).												
Post Trigger	One-eighth of the waveform acquisition window is prior to the trigger (other trigger points are selectable via the MENU). Acquisition Window trigger points (Pre, Post, and Mid) are set at the following points: ^a												
	<table border="1"> <thead> <tr> <th></th> <th>Pre</th> <th>Mid</th> <th>Post</th> </tr> </thead> <tbody> <tr> <td>1K Record</td> <td>128</td> <td>512</td> <td>896</td> </tr> <tr> <td>4K Record</td> <td>512</td> <td>2048</td> <td>3584</td> </tr> </tbody> </table>		Pre	Mid	Post	1K Record	128	512	896	4K Record	512	2048	3584
	Pre	Mid	Post										
1K Record	128	512	896										
4K Record	512	2048	3584										

HORIZONTAL DEFLECTION SYSTEM

NON-STORE Sweep Rates	
Calibrated Range	
A Sweep	0.5 sec per division to 0.05 μ s per division in a 1-2-5 sequence of 22 steps. ^c
B Sweep	50 ms per division to 0.05 μ s per division in a 1-2-5 sequence of 19 steps. ^c

^aPerformance Requirement not checked in manual.

^cThe X10 MAG control extends the maximum sweep speed to 5 ns per division.

Performance Characteristics

Table 7-1 (cont)

Characteristics	Performance Requirements	
STORE Mode Ranges		
REPETITIVE	0.05 μ s per division to 0.5 s per division. ^{a,d}	
RECORD	1 μ s per division to 50 ms per division. ^{a,d}	
ROLL/SCAN	0.1 s per division to 5 s per division. (A Sweep only). ^{a,d}	
NON-STORE Accuracy	Unmagnified	Magnified
+15°C to +35°C		
0.5 s per division to 0.1 μ s per division	$\pm 2\%$	$\pm 3\%$
0.05 μ s per division	$\pm 2\%$	$\pm 4\%$
0°C to +50°C		
0.5 s per division to 0.1 μ s per division	$\pm 3\%$ ^a	$\pm 4\%$ ^a
0.05 μ s per division	$\pm 3\%$ ^a	$\pm 6\%$ ^a
	Sweep accuracy applies over the center eight divisions. Exclude the first 40 ns of the sweep for magnified sweeps and anything beyond the 100th magnified division.	
STORE Accuracy	See Horizontal Differential Accuracy and Cursor Time Difference Accuracy. ^a	

^aPerformance Requirement not checked in manual.

^dThe X10 MAG control extends the maximum sweep speed to 5 ns per division. The 4k COMPRESS control multiplies the SEC/DIV by 4.

Table 7-1 (cont)

Characteristics	Performance Requirements	
NON-STORE Sweep Linearity	± 0.1 division.	
0.5 s per division to 10 ns per division	± 0.15 division.	
5 ns per division	Linearity measured over any two of the center eight divisions. Exclude the first 40 ns and anything past the 100th division of the X10 magnified sweeps.	
Digital Sample Rate	Single Trace	CHOP/ALT
SAMPLE (1 μs per division to 5 s per division)	$\frac{100}{\text{SEC/DIV}}$ Hz ^a	$\frac{50}{\text{SEC/DIV}}$ Hz ^a
PEAKDET or ACCPEAK (1 μs per division to 5 s per division)	100 MHz ^a	100 MHz ^a
REPETITIVE Store (0.05 μs per division to 0.5 μs per division)	100 MHz ^a	100 MHz ^a
External Clock		
Input Frequency		
Slow	Dc to 1 kHz.	
Fast	Dc to 100 kHz.	
Digital Sample Rate	100 MHz in ACCPEAK and PEAKDET, otherwise it is equal to the input frequency. ^a	

^aPerformance Requirement not checked in manual.

Performance Characteristics

Table 7-1 (cont)

Characteristics	Performance Requirements
External Clock (cont)	
Screen Update Rate	
Slow	One data pair for every second falling clock edge. ^a
Fast	Varies with record length and sweep speed. ^a
Duty Cycle	10% or a minimum pulse width of 5 μ s; whichever is greater. ^a
Ext Clock Logic Thresholds	Logic Thresholds are TTL compatible. ^a
Maximum Safe Input Voltage 	25 V (dc + peak ac) or 25 V p-p ac at 100 kHz or less. ^a
Input Resistance	Greater than 20 k Ω (LSTTL compatible).
STORE Mode Resolution	
Acquisition Record Length	1024 or 4096 data points. ^a
Single Waveform Acquisition Display	1024 data points (100 data points per division across the graticule area). ^a
CHOP or ALT Acquisition Display	512 data points (50 data points per division across the graticule area). ^a
Horizontal POSITION Control Range	Start of the 10th division will position past the center vertical graticule line in X1; 100th division in X10 magnified and NON-STORE.

^aPerformance Requirement not checked in manual.

Table 7-1 (cont)

Characteristics	Performance Requirements
Horizontal Variable Sweep Control Range NON-STORE	Continuously variable between calibrated settings of the SEC/DIV switch. Extends the A and the B Sweep speeds by at least a factor of 2.5 times over the calibrated SEC/DIV settings.
STORE	Horizontal Variable Sweep has no affect on the STORE Mode time base. Rotating the Variable SEC/DIV control out of the CAL detent position horizontally compresses a 4K point acquisition record to 1K points in length, so that the whole record length can be viewed on screen. Screen readout is altered accordingly.
Displayed Trace Length NON-STORE	Greater than 10 divisions.
STORE	10.24 divisions. ^a
Delay Time 0.5 μ s per division to 0.5 s per division (A Sweep) Delay POSITION Range	Less than (0.5 div + 300 ns) to greater than 10 divisions. Delay Time is functional, but not calibrated, at A Sweep speeds faster than 0.5 μ s per division.

^a Performance Requirement not checked in manual.

Performance Characteristics

Table 7-1 (cont)

Characteristics	Performance Requirements
Delay Time (cont) 0.5 μ s per division to 0.5 s per division (A Sweep) (cont) NON-STORE Delay Jitter	One part or less in 5,000 (0.02%) of the maximum available delay time.
Delay Time Differential Measurement Accuracy (Runs After Delay only) + 15°C to + 35°C	$\pm 1\%$ of reading, $\pm 0.5\%$ of full scale (10 divisions).
0°C to + 50°C	$\pm 2\%$ of reading, $\pm 0.5\%$ of full scale (10 divisions). ^a Exclude delayed operation when the A and B SEC/DIV knobs are locked together at any sweep speed or when the A SEC/DIV switch is faster than 0.5 μ s per division. Accuracy applies over the B DELAY TIME POSITION control range.
DIGITAL STORAGE DISPLAY	
Vertical Resolution	10 bits (1 part in 1024). ^a Display waveforms are calibrated for 100 data points per division.
Linearity (Relative to center screen)	Within $\pm 5\%$. Linearity is measured by positioning a two-division test signal anywhere on screen and noting the amplitude change.

^aPerformance Requirement not checked in manual.

Table 7-1 (cont)

Characteristics	Performance Requirements
Vertical (cont)	
Position Registration NON-STORE to STORE	± 0.5 division at graticule center at VOLTS/DIV switch settings from 2 mV per division to 5 V per division.
CONTINUE to SAVE	± 0.5 division at VOLTS/DIV switch settings from 2 mV per division to 5 V per division.
SAVE Mode Expansion or Compression Range	Up to 10 times as determined by the remaining VOLTS/DIV switch positions up or down. 2 mV per division acquisitions can- not be expanded, and 5 V per division acquisitions cannot be compressed. Any portion of a stored waveform vertically magnified or compressed up to 10 times can be positioned to the top and to the bottom of the graticule area.
Storage Display Expansion Algorithm Error	$\pm 0.1\%$ of full scale. ^a
Storage Display Compression Algorithm Error	+ 0.16% of reading $\pm 0.4\%$ of full scale. ^a

^aPerformance Requirement not checked in manual.

Performance Characteristics

Table 7-1 (cont)

Characteristics	Performance Requirements
Horizontal Resolution	10 bits (1 part in 1024). ^a Calibrated for 100 data points per division.
Differential Accuracy	Graticule indication of time cursor difference is $\pm 2\%$ of the readout value, measured over the center eight divisions.
SAVE Mode Expansion Range	10 times as determined by the X10 MAG switch.
Expansion Accuracy	Same as the Vertical. ^a

DIGITAL READOUT DISPLAY

CURSOR Accuracy Voltage Difference	$\pm 3\%$ of the ΔV readout value, $\pm 0.4\%$ of full scale (10 divisions). Applies within center 6 divisions.
Time Difference RECORD or ROLL/SCAN	
SAMPLE or AVERAGE	± 1 display interval.
PEAKDET or ACCOPEAK	± 2 display interval. ^a
REPETITIVE SAMPLE or AVERAGE	$\pm(2$ display interval + 0.5 ns). ^a
ACCOPEAK	$\pm(4$ display interval + 0.5 ns). ^a A display interval is the time between two adjacent display points on a waveform.

^aPerformance Requirement not checked in manual.

Table 7-1 (cont)

Characteristics	Performance Requirements
X-Y OPERATION (X1 MAGNIFICATION ONLY)	
Deflection Factors	Same as vertical deflection system with the VOLTS/DIV Variable controls in the CAL detent position.
NON-STORE Accuracy	Measured with a dc-coupled, five-division reference signal.
X-Axis	
+ 15°C to + 35°C	±3%.
0°C to + 50°C	±4%. ^a
Y-Axis	Same as vertical deflection system. ^a
NON-STORE Bandwidth (-3 dB)	Measured with a five-division reference signal
X-Axis	DC to at least 2.5 MHz.
Y-Axis	Same as vertical deflection system. ^a
NON-STORE Phase Difference Between X-Axis and Y-Axis Amplifiers	±3 degrees from dc to 150 kHz. ^a Vertical Input Coupling set to DC.
STORE Accuracy	
X-Axis and Y-Axis	Same as digital storage vertical deflection system. ^a
Useful Storage Bandwidth	
RECORD and REPETITIVE Store Modes	$\frac{5}{\text{SEC/DIV}}$ Hz ^a

^aPerformance Requirement not checked in manual.

Performance Characteristics

Table 7-1 (cont)

Characteristics	Performance Requirements
STORE Mode Time Difference Between Y-Axis and X-Axis Signals RECORD, SCAN, and ROLL Modes	$\pm 1.0 \text{ ns.}^a$
REPETITIVE Store	$\frac{\text{SEC/DIV}}{100} \times 4^a$
PROBE ADJUST	
Output Voltage on PRB ADJ Jack	$0.5 \text{ V} \pm 5\%$.
Probe Adjust Signal Repetition Rate	$1 \text{ kHz} \pm 20\%.^a$
Z-AXIS	
Sensitivity (NON-STORE Only)	5 V causes noticeable modulation. Positive-going input decreases intensity. Usable frequency range is dc to 20 MHz.
Maximum Input Voltage 	30 V (dc + peak ac) or 30 V p-p at 1 kHz or less. ^a
Input Resistance	Greater than 10 k Ω . ^a

^a Performance Requirement not checked in manual.

Table 7-1 (cont)

Characteristics	Performance Requirements
POWER SUPPLY	
Line Voltage Range	90 Vac to 250 Vac. ^a
Line Frequency	48 Hz to 440 Hz. ^a
Maximum Power Consumption	85 watts (150 VA). ^a
Line Fuse	2 A, 250 V, slow blow. ^a
Primary Circuit Dielectric Requirement	Routine test to 1500 V rms, 60 Hz, for 10 seconds without breakdown. ^a
CRT DISPLAY	
Display Area	8 cm X 10 cm. ^a
Standard Phosphor	P31. ^a
Nominal Accelerating Voltage	14 kV. ^a
X-Y PLOTTER OUTPUT	
Maximum Safe Applied Voltage, Any Connector Pin 	25 V (dc + peak ac) or 25 V p-p ac at 1 kHz or less. ^a
X and Y Plotter Outputs	
Pen Lift/Down	Fused relay contacts, 100 mA maximum. ^a
Output Voltage Levels	500 mV per division $\pm 10\%$. Center screen is 0 V ± 1 division. Measured with a dc-coupled, five-division reference signal.
Series Resistance	2 k Ω $\pm 10\%$. ^a
4.2 V Output	$\pm 10\%$ through 2 k Ω . ^a

^aPerformance Requirement not checked in manual.

Performance Characteristics

Table 7-1 (cont)

Characteristics	Performance Requirements
MEMORY	
Non-Volatile Memory	26 Kbytes.
Power-Down Battery Voltage	Memory retained for battery voltages greater than 2.3 V. ^a
Data Retention	Memory maintained at least 6 months without instrument power. ^a
Battery Life	Power-down data retention specification shall be maintained for 3 years without battery change. ^a
Power-down Detection Threshold	Fail asserted for supply drop to less than 4.5 V. ^a Reset held until supply is greater than 4.75 V. ^a
Reset Delay	Power-down interrupt to reset delay ≥1 ms. ^a
GPIB OPTION	
GPIB Requirements	Complies with ANSI/IEEE Standard 488-1978. ^a
RS-232-C OPTION	
RS-232-C Requirements	Complies with EIA Standard RS-232-C. ^a
Baud Rates	
Available Rates	110, 300, 1800, and 2400 baud.
Accuracy	< 1% error. ^a

^aPerformance Requirement not checked in manual.

Performance Characteristics

Table 7-2 (cont)

Characteristics	Performance Requirements
Shock Operating and Nonoperating	30 g half-sine, 11 ms duration, three shocks per axis each direction, for a total of 18 shocks. ^a Meets requirements of MIL-T-28800D, para 4.5.5.4.1, except limited to 30 g.
Bench Handling Test	Each edge lifted four inches and allowed to free fall onto a solid wooden bench surface. ^a Meets requirements of MIL-T-28800D, para 4.5.5.4.3.

^aPerformance Requirement not checked in manual.

Performance Characteristics

Table 7-3
Physical Characteristics

Characteristics	Performance Requirements
Weight	See Figure 7-2 for dimensional drawing.
With Power Cord, Cover, Probes, and Pouch	9.4 kg (20.7 lb).
With Power Cord Only	8.2 kg (18 lb).
Domestic Shipping Weight	12.2 kg (26.9 lb).
Height	137 mm (5.4 in).
Width	
With Handle	360 mm (14.2 in).
Without Handle	328 mm (12.9 in).
Depth	
With Front Cover	445 mm (17.5 in).
Without Front Cover	440 mm (17.3 in).
With Handle Extended	511 mm (20.1 in).

Performance Characteristics

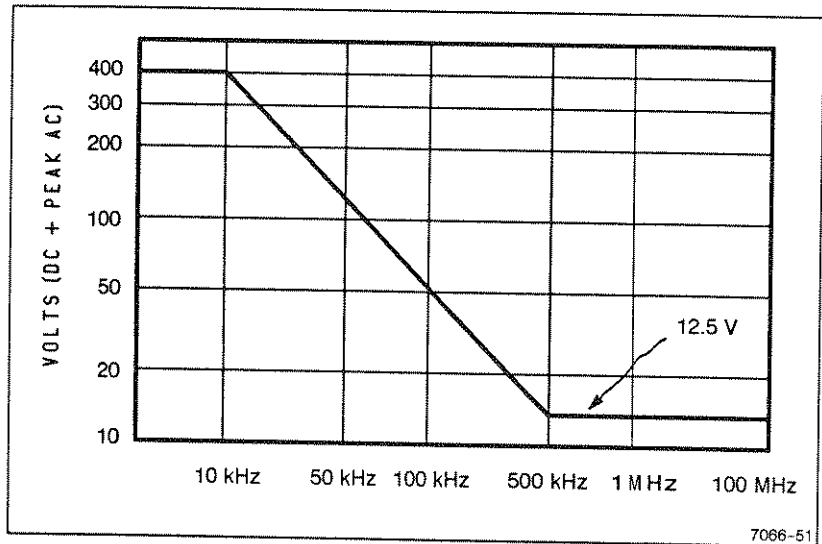

Figure 7-1. Maximum input voltage versus frequency derating curve for the CH 1 OR X, CH 2 OR Y, and EXT INPUT connectors.

SECTION 8

**OPTIONS AND
ACCESSORIES**

2232 Operators

INTRODUCTION

This section is divided into three subsections. The first contains a general description of available instrument options and the second is the operating instructions for the Option 10 and Option 12 Communications interfaces. The third subsection is the Command Lists, status-bytes and event codes, and waveform transmitting data common to both Communications Options. Also included in the first subsection is a complete list (with Tektronix part numbers) of standard accessories included with each instrument and a partial list of optional accessories. Additional information about instrument options, option availability, and other accessories can be obtained either by consulting the current Tektronix Product Catalog or by contacting your local Tektronix Field Office or representative.

ACCESSORIES AND OPTIONS DESCRIPTION

STANDARD ACCESSORIES

The following standard accessories are provided with each instrument:

Qty	Description	Part Number
2	10X Probe packages	P6109
1	Power Cord	As Ordered
1	Operators Manual	070-7066-00
1	Users Reference Guide	070-7068-00
1	Front Panel Cover	200-2520-00
1	Accessory Pouch	016-0677-02
1	Fuse, 3AG, 2A, 250 V Slo-Blo	159-0023-00
1	DB-9 Male Connector and Connector Shell	131-3579-00
1	Loop Clamp	343-0003-00
1	Flat Washer	210-0803-00
1	Self-Tapping Screw	213-0882-00

OPTIONAL ACCESSORIES

The following optional accessories are recommended for use with the instrument.

Description	Part Number
Service Manual	070-7067-00
Reference Guide (Options 10 and 12)	070-7221-01
Probe Tips, IC grabber, (2 each for P6109 probes)	013-0191-00
Rack Adapter	016-1003-00
Viewing Hood	016-0566-00
Carrying Strap	346-0199-00
Carrying Case	016-0792-01
Rain Cover	016-0848-00
C-5C Option 02 Camera	
K212 Portable Instrument Cart	
1107 Dc Inverter	

POWER CORD OPTIONS

Instruments are shipped with the detachable power-cord option ordered by the customer. Descriptive information about the international power-cord options is provided in Section 2, "Preparation for Use." The following list identifies the Tektronix option number for the available power cords.

Standard	120 V	North American
Option A1	220 V	Universal Euro
Option A2	240 V	United Kingdom
Option A3	240 V	Australian
Option A4	240 V	North American
Option A5	220 V	Switzerland

OPTION 10

Option 10 provides a GPIB (General Purpose Interface Bus) communications interface. The interface implemented conforms to the specifications contained in *IEEE Standard Digital Interface for Programmable Instrumentation (ANSI/IEEE Std 488-1978)*. It also complies with a Tektronix Standard relating to GPIB Codes, Formats, Conventions and Features. Operating information for the Option 10 GPIB interface is given in the COMMUNICATION OPTION OPERATION subsection of this section.

OPTION 12

Option 12 provides an RS-232-C serial communications interface. The interface implemented conforms to RS-232-C specifications. The option provides both DTE and DCE capability to aid in hooking up the various types of printers, plotters, personal computers, and modems that may be encountered. Operating information for the Option 12 RS-232-C interface is given in the COMMUNICATION OPTION OPERATION subsection of this section. Information regarding RS-232-C interconnection cables is given in Appendix B of this manual.

OPTION 33

Option 33, the Travel Line option, provides impact protection needed for rough industrial and service environments. When the instrument is ordered with Option 33, it comes equipped with the Accessory Pouch, the Front Panel cover, shock-absorbing rubber guards mounted on the front and rear of the cabinet, an easy-to-use power-cord wrap, and a carrying strap.

COMMUNICATIONS OPTION OPERATION

The communications options allow remote waveform acquisition and the transfer of waveform data both to and from the instrument. Waveform data may also be directly output to compatible digital printers or plotters for producing hard copies of the displayed signals.

The Option 10 interface conforms to GPIB IEEE-488 bus standard and the Option 12 interface conforms to the standard for RS-232-C serial communication. Both options also conform to Tektronix standards on Codes, Formats, Conventions, and Features. In general, messages to the oscilloscope sent via the communication options have one of the following purposes:

1. Query the state of the oscilloscope.
2. Query the result of a measurement made.
3. Set or change the instrument's operating mode.
4. Request waveform data transfer.

OPTION 10 GPIB OPERATORS INFORMATION

The GPIB Communications Option complies with ANSI/IEEE Standard 488-1978. All other specifications for the instrument (including the performance conditions) are identical to those specified in "Performance Characteristics" in Section 7 of this manual.

Standard Functions, Formats, and Features

The interface-function capabilities of a GPIB instrument, in terms of interface-function subsets, are identified in ANSI/IEEE Std 488-1978. The status of subsets applicable to this instrument with Option 10 are listed in Table 8-1.

Table 8-1
Function Subsets Implemented

Function Subset	Capability	States Omitted	Other Requirements	Other Subsets Required
SH1 (Source Handshake)	Complete Capability	None	None	T5
AH1 (Acceptor Handshake)	Complete Capability	None	None	None
T5 (Talker)	Basic Talker, Serial Poll, Unaddress if MLA	None	Include [MLA (ACDS)]	SH1 and L3
L3 (Listener)	Basic Listener, Listen Only, Unaddress if MTA	None	Include [MLA (ACDS)]	AH1 and T5
SR1 (Service Request)	Complete Capability	None	None	T5
RL2 (Remote/Local)	No Local Lockout	LWLS and RWLS	RTL always false	L3
PPO (Parallel Poll)	No Capability	All	None	None
DC1 (Device Clear)	Complete Capability (Selective Device Clear)	None	None	L3
DT0 (Device Trigger)	No Capability	All	None	None
CO (Controller)	No Capability	All	None	None
E2 (Drivers)	Three-state			

The GPIB interface conforms to the Tektronix standard on Codes, Formats, Conventions, and Features of messages sent over the bus to communicate with other GPIB instruments. Specific format choices implemented in this instrument are listed in Table 8-2; specific features implemented are shown in Table 8-3.

Table 8-2
Specific Format Choices

Format Parameter	Choice Made
Format Characters	Not transmitted; ignored on reception.
Message Terminator	Either EOI or LF can be selected for message termination.
Measurement Terminator	Follows program message-unit syntax.
Link Data (Arguments)	Used in Listen and Talk.
Multiple Event Reporting	Not implemented to report all events on a single query. Multiple events may be reported by using multiple queries.
Instrument Identification Query	Descriptors added for all options.
Set Query	Extended by using other commands.
Device Trigger (DT)	Not implemented.
INIT Command	Causes the instrument to return to a default set up condition.
Time/Date Commands	Not implemented.
Stored Setting Commands	Not implemented.
Waveform Transmission	Implemented.
Return to Local (rtl)	Not implemented.
IEEE 728	Compliance not intended.

Table 8-3
Implementation of Specific Features

Feature	Choice Made	Comments
Secondary Addressing	Not implemented.	
Indicators	ADDR (addressed), LSRQ (service request), and PLOT (acquisitions locked out) indicators are included.	
Parameter Selection	A ten-section switch sets the instrument's bus address, message terminator, listen-only or talk-only mode, and makes printer/plotter selections.	Switch settings are read only at power on.

Option 10 GPIB Side Panel

The Option 10 instrument is supplied with the side panels shown in Figure 8-1. The Option 10 side panel includes one AUXILIARY connector, one GPIB (IEEE 488-1978) interface port, and one PARAMETERS switch. The Controls, Connectors, and Indicators part of this manual contains information on the use of the AUXILIARY Connector. Refer to Figure 8-1 for location of the Option 10 side-panel controls and connectors.

AUXILIARY Connector—Provides connections for an X-Y Plotter and an External Clock input (see Controls, Connectors, and Indicators).

GPIB Connector—Provides the ANSI/IEEE Std 488-1978 compatible electrical and mechanical connection to the GPIB. The connector is only on instruments with Option 10. The function of each pin of the connector is shown in Table 8-4.

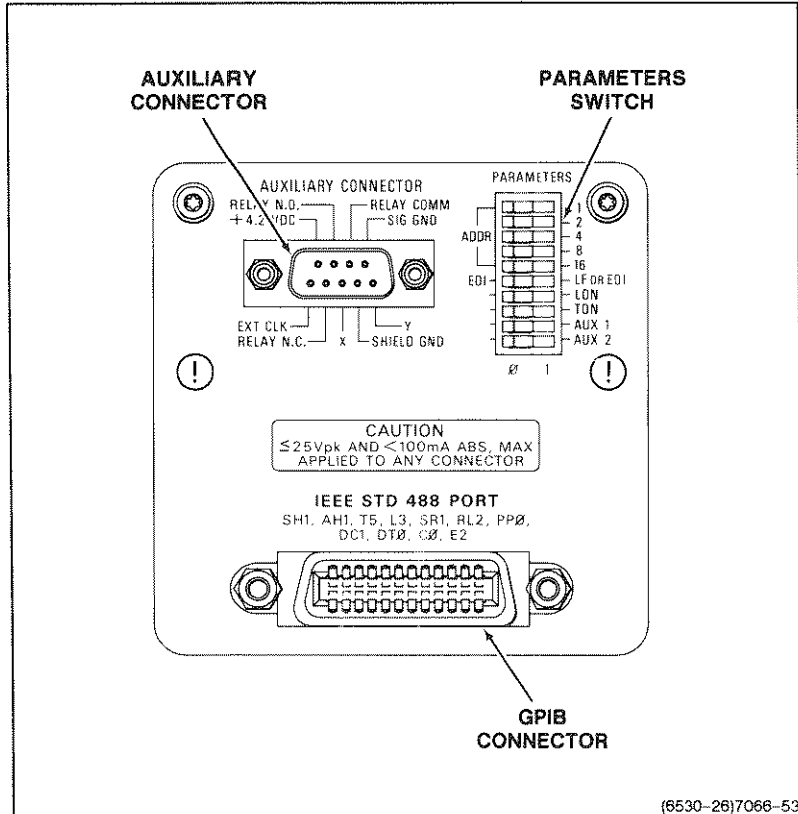

Figure 8-1. Option 10 side panel.

Table 8-4
GPIB Connector

Pin	Line Name	Description
1	DIO1	IEEE-488 Data I/O
2	DIO2	IEEE-488 Data I/O
3	DIO3	IEEE-488 Data I/O
4	DIO4	IEEE-488 Data I/O
5	EOI	IEEE-488 END or Identify
6	DAV	IEEE-488 Handshake
7	NRFD	IEEE-488 Handshake
8	NDAC	IEEE-488 Handshake
9	IFC	IEEE-488 Input
10	SRQ	IEEE-488 Output
11	ATN	IEEE-488 Input
12	SHIELD	System Ground (Chassis)
13	DIO5	IEEE-488 Data I/O
14	DIO6	IEEE-488 Data I/O
15	DIO7	IEEE-488 Data I/O
16	DIO8	IEEE-488 Data I/O
17	REN	IEEE-488 Input
18	GND	Digital Ground (DAV)
19	GND	Digital Ground (NRFD)
20	GND	Digital Ground (NDAC)
21	GND	Digital Ground (IFC)
22	GND	Digital Ground (SRQ)
23	GND	Digital Ground (ATN)
24	GND	Digital Ground (LOGIC)

Options and Accessories

GPIB PARAMETERS Switch— Allows the selection of setup options for the GPIB interface. The switch is read at power-up and when interface clear messages are received. Five sections of the switch select the GPIB address, one selects the terminator, two select talk/listen modes, and two are used for printer/plotter selection. The function of each switch section is shown in Table 8-5.

Switches 9 and 10 select printer/plotter devices at power-up. The devices may be changed after power-up using Option commands, or in the case of the 2232, the MENU controls. Two EPSONg formats are selectable. EPS7 uses seven print wires per head pass, and is usually slower. It is the chr(27) "L" mode. EPS8 uses eight print wires per head pass, and is usually the faster print-head speed. It is the chr(27) "Y" mode. In this mode, most Epson and Epson-compatible printers will not strike any print wire more often than every second pixel. EPS8 is selected when parity is disabled.

Printing/plotting devices are selected with the following switch positions:

Switch 9	Switch 10	Device Selected
0	0	HP-GL® plotter
1	0	Epson® EPS7 or EPS8
0	1	ThinkJet® printer
1	1	X-Y Plotter

HP-GL and ThinkJet are trademarks of Hewlett-Packard Company. Epson is a trademark of Epson Corporation.

Table 8-5
GPIB PARAMETERS Switch

Switch Section	Switch Position	Function
1	0	Address selection
	1	0 Binary weight = 1
2	0	Address selection
	1	0 Binary weight = 2
3	0	Address selection
	1	0 Binary weight = 4
4	0	Address selection
	1	0 Binary weight = 8
5	0	Address selection
	1	0 Binary weight = 16
6	0	Terminator selection
	1	EOI LF or EOI
7	0	No function
	1	LON (Listen only)
8	0	No function
	1	TON (Talk only)
9		Printer/plotter selection
10		Printer/plotter selection

GPIB Parameter Selection

The correct selection of GPIB parameters (primary address, message terminator, and talk/listen mode) must be made before power on. That is when the GPIB PARAMETERS switch is read to determine what the address and other settings of the switch are. See Table 8-5 (shown previously) to determine the specific parameters switch settings.

PRIMARY ADDRESS—The selected GPIB address establishes the talk and listen address for the oscilloscope. It can be set to any value between 0 and 31, inclusive. Address 31 is “OFF LINE”. With an address of 31, the instrument still presents an active load, but it neither responds to nor interferes with any bus traffic.

SECONDARY ADDRESS—Not implemented in the 2232 digital storage oscilloscope.

INPUT END-OF-MESSAGE TERMINATOR—The end-of-message terminator can be selected to be either the End-or-Identify (EOI) interface signal or the Line-Feed (LF) character.

When EOI (normal mode) is selected as the terminator, the instrument will:

- accept only EOI as the end-of-message terminator, and
- assert EOI concurrently with the last byte of a message.

When LF is selected as the terminator, the instrument will:

- accept either LF or EOI as the end-of-message terminator, and
- send Carriage Return (CR) followed by LF at the end of every message, with EOI asserted concurrently with the LF.

TALK/LISTEN MODE—Four talk/listen modes are selectable:

- **TALK ONLY** mode allows the instrument to send data over the GPIB but not to listen.
- **LISTEN ONLY** mode permits the instrument to receive data over the GPIB but not to talk.

- TALK/LISTEN mode (both TON and LON modes unselected) allows the instrument to both send and receive data over the GPIB.
- OFF BUS mode (both TON and LON modes selected) switches the instrument off the bus (same as setting address to 31).

To select a different Talk/Listen mode, see the GPIB PARAMETERS switch settings in Table 8-5. The new settings must be made before power on to be in effect.

Option 10 Interface Status Indicators

Three indicators appear in the CRT readout to indicate the status of the GPIB communication option. The indicators are labeled SRQ (service request pending), ADDR (addressed to talk), and PLOT (output data to the plotter) on the CRT bezel. The active indication is seen as an intensified line in the CRT display just below the associated label. Refer to Figure 8-2 for the location of the communications interface status indicators.

SRQ Indicator—Indicates the communications option requires service by the controller. Service requests are cleared when the instrument has been polled for its status and no further warning or error conditions are pending. The communication option asserts a power-up service request (SRQ) when turned on. Other service requests are asserted as enabled by the RQS and OPC commands.

ADDR Indicator—Indicates the instrument is addressed to talk or listen.

PLOT Indicator—Indicates the communication option is currently sending waveform data over its interface and acquisitions are inhibited.

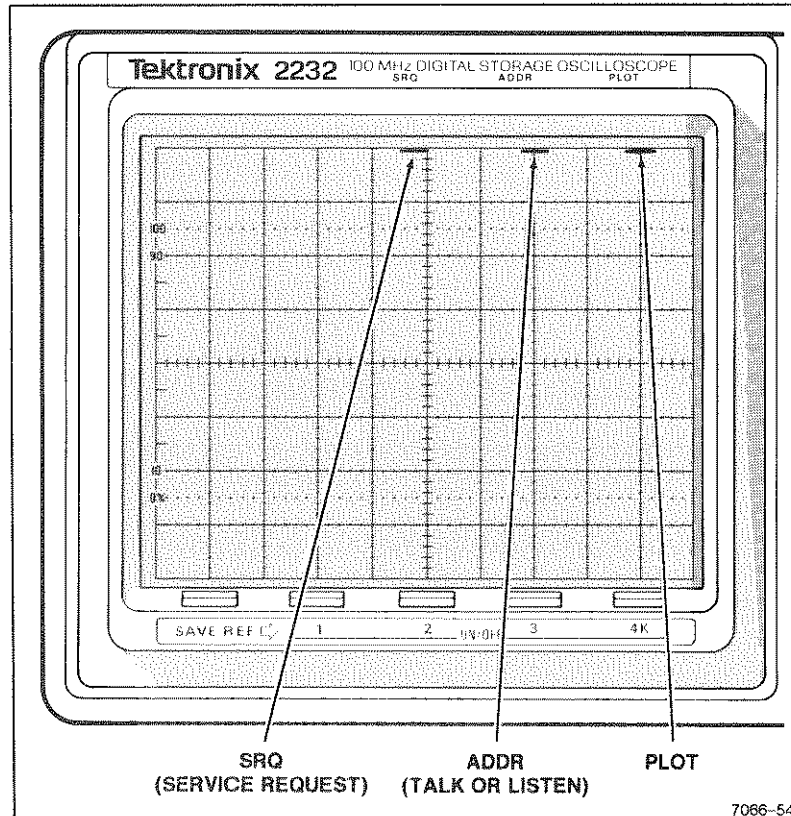

Figure 8-2. SRQ, ADDR, and PLOT indicators.

Instrument Response To Interface Messages

OPTION 10 GPIB. The following explain effects on the oscilloscope of standard interface messages received from a remote controller. Message abbreviations used are from ANSI/IEEE Std 488-1978.

LOCAL LOCKOUT (LLO)—Local Lockout is not supported by the instrument. In response to a LLO message via the GPIB interface, Option 10 generates an SRQ error.

REMOTE ENABLE (REN)—When Remote Enable is asserted and the instrument receives its listen address, the oscilloscope is placed in the Remote State (REMS). When in the Remote State, the oscilloscope's Addressed (ADDR) indicator is lit.

Unasserting REN causes a transition to LOCS; the instrument remains in LOCS as long as REN is false. The transition may occur after processing of a different message has begun. In this case, execution of the message being processed is not interrupted by the transition.

GO TO LOCAL (GTL)—Instruments that are already listen-addressed respond to GTL by assuming a local state. Remote-to-local transitions caused by GTL do not affect the execution of any message being processed when GTL was received.

MY LISTEN AND MY TALK ADDRESSES (MLA AND MTA)—The primary Talk/Listen address is established as previously explained in the GPIB Parameter Selection information.

UNLISTEN (UNL) AND UNTALK (UNT)—When the UNL message is received, the oscilloscope's listen function is placed in an idle (unaddressed) state. In the idle state, the instrument will not accept commands over the bus.

The talk function is placed in an idle state when the oscilloscope receives the UNT message. In this state, the instrument cannot transmit data via the interface bus.

INTERFACE CLEAR (IFC)—When IFC is asserted, both the Talk and Listen functions are placed in an idle state and the CRT ADDR indicator is turned off. This produces the same effect as receiving both the UNL and the UNT messages.

DEVICE CLEAR (DCL)—The DCL message reinitializes communication between the instrument and the controller. In response to DCL, the instrument clears any input and output messages as well as any unexecuted control settings. Also cleared are any errors and events waiting to be reported (except the power-on event). If the SRQ line is asserted for any reason

(other than power-on), it becomes unasserted when the DCL message is received.

SELECTED DEVICE CLEAR (SDC) – This message performs the same function as DCL; however, only instruments that have been listen-addressed respond to SDC.

SERIAL POLL ENABLE AND DISABLE (SPE AND SPD) – The Serial Poll Enable (SPE) message causes the instrument to transmit its serial-poll status byte when it is talk-addressed. The Serial Poll Disable (SPD) message switches the instrument back to its normal operation.

Reset Under Communication Option Control

Some oscilloscope modes may be set to their default or power-on states by sending the INIt command via the communication option. The major settings that are affected by INIt are:

```
ACQUISITION REP:AVE
ACQUISITION HSREC:SAMPLE
ACQUISITION LSREC:PEAKDET
ACQUISITION SCAN:PEAKDET
ACQUISITION ROLL:PEAKDET
ACQUISITION SMOOTH:ON
ACQUISITION WEIGHT:4
ACQUISITION NUMSWEEPS:0
ACQUISITION VECTORS:ON
DATA ENCDG:BINARy
DATA SOURCE:ACQ
DATA TARGET:REF1
PLOT GRAT:OFF
PLOT FORMAT: <power-on setting>
READOUT ON
Menu system reset.
```

Option 10 Status and Error Reporting

The status and error reporting system of Option 10 interrupts the GPIB bus controller by asserting an SRQ (service request). The service

request indicates that an event has occurred that requires attention. When the controller polls the bus, the status-byte returned by the oscilloscope indicates the type of event that occurred. A further **EVent?** query will return an event code that gives more specific information about the cause of the service request. The **SRQ** status byte and the event code provide a limited amount of information about the specific cause of the service request. Command errors, execution errors, and internal errors assert an immediate **SRQ** (if **RQS** is on). To retrieve other system event and warning status bytes, **OPC** must also be **ON**, and the oscilloscope must be queried by the **STatus?** command. See Tables 8-33 and 8-34 at the back of this section for status and event codes.

GPIB Programming

Programming considerations are provided in this part to assist in developing your own unique programs for interfacing to the oscilloscope via the GPIB.

Before a program can be used for controlling the oscilloscope, the GPIB parameters (primary address, message terminator, and talk/listen mode) must be set. Procedures describing how these parameters are selected and set at the oscilloscope were given previously in this section of the manual.

Programs are usually composed of two main parts (or routines), which can be generally categorized as a command handler and a service-request handler.

COMMAND HANDLER – Basically, a command handler should establish communication between the controller and oscilloscope, send commands and queries to the oscilloscope, receive responses from the oscilloscope, and display responses as required. The following outline indicates the general sequence of functions that the command-handling routine should perform to accommodate communications between the controller and oscilloscope over the GPIB.

1. Initialize the controller.
2. Disable the service-request handler until the program is ready to handle them.

3. Get the GPIB address of the oscilloscope.
4. Enable the service-request handler.
5. Get the command to send to the oscilloscope.
6. Send the command to the oscilloscope.
7. Check for a response from the oscilloscope.
8. If there is a response, perform the desired function.
9. You are ready for a new command. Repeat the functions in statements 5 through 9 as many times as desired.

SERVICE-REQUEST HANDLER—Typical service-request handler routine contains the necessary instructions to permit proper processing of interrupts. For example, whenever power-on occurs, the oscilloscope asserts an SRQ interrupt. If a GPIB program is operating on the controller when a power-on SRQ is received, the program should be able to determine that the oscilloscope's power was interrupted at some time during program operation. This event could cause improper program execution, unless the program was written to adequately handle the possibility of a power-on SRQ occurring.

Other interrupts (or events) for which the oscilloscope asserts SRQ are identified in Table 8-12.

While some controllers have the capability of ignoring service requests, others require that all SRQs be managed. The programmer should understand the controller being used. If service requests are to be handled in the program, the interrupts must first be enabled.

A service-request handler routine can be developed to service interrupts when they occur during program operation. It basically should consist of an interrupt-enabling statement (ON SRQ) near the beginning of the program and a serial-poll subroutine somewhere in the program. The ON SRQ statement directs program control to the serial-poll subroutine whenever an SRQ interrupt occurs. For each interrupt received by the controller, the program should perform a serial-poll subroutine.

The following general steps are required to handle service requests from the oscilloscope:

1. Perform a serial poll.
2. Send an EVENT? query to the oscilloscope requesting service.
3. If the EVENT? query response is not zero, then perform the response required to handle the event.
4. Return to the main program.

OPTION 12 RS-232-C OPERATORS INFORMATION

The RS-232-C Communications interface conforms to the Tektronix standard on Codes, Formats, Conventions, and Features for messages sent over to bus for communications to other RS-232-C devices. Secondary addressing is not implemented in Option 12. Specific formats implemented in the 2232 for the Option 12 Communications interface are listed in Table 8-6.

Comm Menu

The Comm Menu resides under the ADVANCED FUNCTIONS, and allows the selection of parameters for communications options.

Stop Bits – Selects the number of stop bits (One or Two) for RS-232-C data transmissions. The usual choice for stops is One, but some printers/plotters require Two stop bits for some baud rates.

Table 8-6
Specific Format Choices for Option 12

Format Parameter	Choice Made
Format Characters	Not transmitted; ignored on reception.
Message Terminator	Either CR or CR-LF may be selected as the message terminator.
Measurement Terminator	Follows program message-unit syntax.
Link Data (Arguments)	Used in sending and receiving messages.
Multiple Event	Not implemented to report multiple events on a single reporting query. Multiple events may be reported by multiple queries.
Instrument Identification Query	Descriptors added for all options.
Set Query	Extended by using other commands as queries.
Device Trigger (DT)	Not implemented.
INIT Command	Causes the instrument to return to a default initialization state.
Time/Date Commands	Not implemented.
Stored Setting Commands	Not implemented.
Waveform Transmission	Implemented. Waveforms may be encoded in ASCII, HEX, or BINARY. The oscilloscope powers on with the encoding set to BINARY.
Remote On/Off	REMOte must be set to ON to get the instrument to change a remote-controllable function. The instrument powers up with REMote OFF.
IEEE 728	Compliance not intended.

Once communication is established between the controller and the oscilloscope, commands may be sent to the oscilloscope. When dealing with the transfer of data via the RS-232-C interface, the bits used to make up a character consist of a start bit, seven or eight data bits, and, finally, one or two stop bits. Start and stop bits separate the data bytes and are called framing pulses. The start bit is always set to a mark, and the one or two stop bits are set to a space. One stop bit is used in most applications. Two stop bits may be needed for some printers at some baud rates. The command STOP 1 or STOP 2 sets the number of stop bits in the character frame.

The transition from one character's stop bit(s) to the next character's start bit is used to synchronize the receiver to the transmitter. This causes the coded data bits for each character to be read at the best time relative to the start of the character's start.

Errors that occur due to mismatched baud rates, data bits, or stop bits show up as framing errors. The start-bit and stop-bit frame surrounding the character bits have the wrong timing relationship with respect to each other. Since they are not recognized properly, the data stream cannot be interpreted by the receiving device.

Flow— Sets the data flow control over the interface ON or OFF. Binary waveform information cannot be sent with Flow On.

When transmitting data using modems to interconnect two devices via the telephone lines, the normal handshaking lines are not used. The two devices can still communicate using a data-transmission technique called flow control. Using this method, the data sent can be separated from non-data being received (such as noise). This is done by interpreting every correctly framed data pattern as a valid character and constantly checking for two specific characters that turn the transmission on and off.

These flow-control characters are called XON (transmission on) and XOFF (transmission off). The usual assignment for these is <control-Q> for XON and <control-S> for XOFF, though the specific characters chosen are a function of the communications

program used. When communicating over telephone lines, flow control greatly increases the chance that ASCII or HEX encoded data will be correctly transferred.

The Flow On command allows the oscilloscope some on/off control of the data transfer. At power-on, the default data encoding is BINARY. Flow control can not be used for the transmission of binary-encoded waveform data, so the power-on setting of Flow is set to off. Before sending binary-encoded data, Flow Off must be sent if flow control was previously set ON. The Advanced Functions menu of the 2232 also has a menu choice for setting flow control.

Option 12 Side Panel

The side panel for Option 12 instruments (Figure 8-3) includes one AUXILIARY connector, one RS-232-C interface port (providing both DTE and DCE capability), and one PARAMETERS switch. The Controls, Connectors, and Indicators part of this manual contains information on the use of the AUXILIARY Connector. Refer to Figure 8-3 for location of the Option 12 side-panel controls and connectors.

AUXILIARY Connector—Provides connections for an X-Y Plotter and an External Clock input (see Controls, Connectors, and Indicators).

NOTE

Do not hook up external devices to the DTE connector and the DCE connector at the same time.

RS-232-C DTE Connector—Provides connection meeting the EIA RS-232-C standard for data terminal equipment (see Figure 8-3). Table 8-7 lists the function of each pin of the connector. This connector is provided only on Option 12 instruments.

NOTE

Do not hook up external devices to both the DTE connector and the DCE connector at the same time.

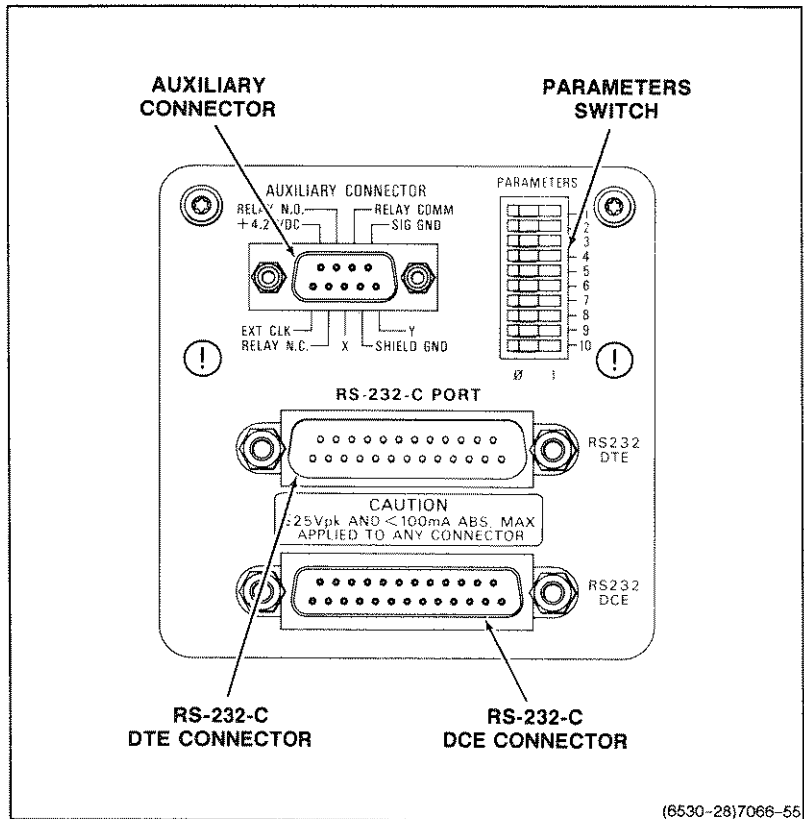

Figure 8-3. Option 12 side panel.

Table 8-7
RS-232-C DTE Connector

Pin	Signal Name		Function
	Internal	External	
1	CHAS GND	CHAS GND	Chassis ground
2 ^a	ITXD	TXD	Transmitted data
3 ^a	IRXD	RXD	Received data
4	IRTS	RTS	Request to send
5	ICTS	CTS	Clear to send
6	IDSR	DSR	Data set ready
7 ^a	SIG GND	SIG GND	Signal ground
8	IRLSD2	RLSD	Received line signal detect
20	IDTR	DTR	Data terminal ready

^aThese lines are all that are required for communication without hard control lines.

RS-232-C DCE Connector – Provides a connector that meets the EIA RS-232-2 standard for data communications equipment (see Figure 8-3). Table 8-8 lists the function of each pin of the connector. The connector is provided only on Option 12 instruments.

RS-232-C PARAMETER Switch – Allows the selection of setup options for the RS-232-C interface. The switches are read at power-up. Four sections of the switch select the baud rate, three select parity, one selects the terminator, and two are for printer/plotter selection. The function of each switch section is shown in Table 8-9.

Table 8-8
RS-232-C DCE Connector

Pin	Signal Name		Function
	Internal	External	
1	CHAS GND	CHAS GND	Chassis ground
2 ^a	IRXD	TXD	Transmitted data
3 ^a	ITXD	RXC	Received data
4	ICTS	RTS	Request to send
5	IRTS	CTS	Clear to send
6	IDTR	DSR	Data set ready
7 ^a	SIG GND	SIG GND	Signal ground
8	IRLSD1	RLSD	Received line signal detect
20	IDSR	DTR	Data terminal ready

^aThese lines are all that are required for communication without hard control lines.

Table 8-9
RS-232-C PARAMETERS Switch

Switch Section	Switch Position	Function
1	--	Baud rate ^a
2	--	Baud rate ^a
3	--	Baud rate ^a
4	--	Baud rate ^a
5	0	Parity enable/disable Parity is not checked. The data word is 8 bits long.
	1	Parity is checked according to the settings of switches 6 and 7. A parity error causes a status byte to be sent if RQS is on. The data word is 7 bits long with the 8th bit being the parity bit.
6		Parity select ^b
7		Parity select ^b
8	0	Line terminator selection Lines are terminated with carriage return (CR).
	1	Lines are terminated with carriage Return-line feed (CR-LF).
9		Printer/Plotter selection
10		Printer/Plotter selection

^aSee Table 8-10.

^bSee Table 8-11.

Option 12 Interface Status Indicators

The three indicator labels (SRQ, ADDR, and PLOT) above the CRT indicate the status of the Communications interface. Refer to Figure 8-3 (shown previously) for the location of the status indicators. Their operation is as follows:

SRQ indicator—Turns on only during the time an asynchronous status byte is being sent. A status byte or event code is not generated for power-on. Events must be queried to receive pending events codes. Status must also be queried to receive pending status bytes, except for command and execution error status which are returned immediately upon recognition of an error. If OPC is also on, additional system events (i.e., warnings and operation complete) will also generate an asynchronous service request. All status bytes are prevented from reporting if RQS is off, but the SRQ indicator does not indicate that a status byte is pending. In this case, the event code must be queried (EVENT?) to find out if an event has happened.

ADDR indicator—Turns on when a carrier is detected. With no devices connected to either the DTE port or the DCE port, the ADDR indicator will be on. If an RS-232-C DCE device is connected to the DCE port, the carrier will also be on all the time. The indicator will be off if a DTE device is connected to the DTE port and no carrier is detected.

PLOT indicator—Turns on when the communication option is currently sending waveform data. Acquisitions are inhibited during this time.

RS-232-C Parameter Selection

Selection of RS-232-C parameters (baud rate, parity, and line terminator) must be made prior to power on using the RS-232-C PARAMETER switch and Table 8-9 through Table 8-11. Changes to the PARAMETER switch after power on will not be read until the next power on occurs. PARAMETERS switch settings and setups for some common printers and plotters are given in Appendix B. There are two other communications parameters that are set using commands via

the interface itself. These are STOP bits and FLOW control. The most used setting for STOP is 1. The power-on default for FLOW is OFF.

The function of the RS-232-C PARAMETER switch sections are given in Table 8-9. Switches 9 and 10 select printer/plotter devices at power up. The devices may be changed after power-up using Option commands or, in the case of the 2232, the MENU controls. Two EPSON formats are selectable. EPS7 uses seven print wires per head pass, and is usually slower. It is the chr (27) L mode. EPS8 uses eight print wires per head pass, and is usually the faster print-head speed. It is the chr (27) Y mode. In this mode, most Epson and Epson-compatible printers will not strike any print wire more often than every second pixel. EPS8 is selected when parity is disabled. Printing/plotting devices are selected with the following switch positions:

Switch 9	Switch 10	Device Selected
0	0	HP-GL® plotter
1	0	Epson® (EPS7 or EPS8)
0	1	ThinkJet® printer
1	1	X-Y Plotter

HP-GL and ThinkJet are trademarks of Hewlett-Packard Company. Epson is a trademark of Epson Corporation.

Baud Rate. Baud rate switch settings determine the baud rate used by the instrument for both sending and receiving data. The available baud rates are listed in Table 8-10.

When OFF LINE (baud-rate switch settings 1111) is selected, the instrument still presents an active load to the other RS-232-C device, but it can't send or receive any interface traffic.

Use Table 8-9, Table 8-10, and the PARAMETERS switch to select the desired baud rate.

Parity. The selected parity settings determine the oscilloscope's response to received parity errors and the parity of data sent by the oscilloscope.

Section 5 of the PARAMETERS switch determines whether or not received parity errors will cause an error report (see Table 8-10). With parity enabled, seven bits represent the characters being sent. The eighth bit is the parity bit, and is interpreted as selected by the settings of switches 6 and 7. These sections of the PARAMETERS switch determine the parity used when transmitting and receiving data over the RS-232-C interface. ODD, EVEN, MARK, or SPACE parity is selectable (see Table 8-11).

**Table 8-10
Baud Rate**

Switch Position	Baud Rate
4321	
0000	50
0001	75
0010	110
0011	134.5
0100	150
0101	300
0110	600
0111	1200
1000	1800
1001	2000
1010	2400
1011	3600
1100	4800
1111	Off Line

Table 8-11
Parity Selection^a

Switch Position		Parity Type	Comments
6	7		
0	0	ODD	The parity bit of each byte is set or cleared as needed to make the number of logical ones per word byte odd.
1	0	EVEN	The parity bit of each byte is set or cleared as needed to make the number of logical ones per word byte even.
0	1	MARK	The parity bit is always set to a logical one.
1	1	SPACE	The parity bit is always cleared to a logical zero.

^a Characters are always accepted if possible. If parity is enabled and RQS is on, a status byte is sent if the received parity doesn't match the parity selected. Parity must be disabled (PARAMETERS switch position 5 set to 0 before power on) for binary data transfers.

By setting both the transmitting and receiving devices to use parity, some degree of checking may be done on 7-bit data. Setting parity to even causes the transmitter to send a parity bit that makes the number of mark bits in the data (plus the parity bit) come out to an even number. Upon receiving the data, the receiving device adds up the mark bits in the data byte. If an error is detected, a system event status byte is sent. When the event code byte is interpreted, the controller may make a hardware change or alter its routine to handle the error.

Odd parity works in the same way, except that the number of mark bits is expected to be odd. Parity may also be set to mark or space where the parity bit is always set to a mark or a space respectively.

Message Line Terminator. PARAMETERS switch section 8 selects the line terminator. The line terminator is either CR (carriage return), with switch section 8 open, or CR-LF (carriage return and line feed), with switch section 8 closed (see Table 8-9).

NOTE

Commands to the oscilloscope are interpreted and carried out as soon as they are recognized as such; the oscilloscope does not wait for a CR or CR-LF to end the command string. If a command needs to be correctly done before the next command is sent, the controller must wait for the correct return. If an error occurs (due to command syntax or incompatible instrument settings), the error status will be immediately reported. The controller can detect the error, query the event code, and take corrective action before going on with another command that may not be handled properly. This is especially true if the previous command puts the oscilloscope in a state that prevents it from responding. For this reason, the recommended practice is to send only one command in each message line to the oscilloscope.

When CR (normal mode) is selected as the terminator, the instrument will:

- Accept only CR as the line terminator.
- Send CR as the last byte of a message.

When CR-LF is selected as the terminator, the instrument will:

- Accept either CR-LF or LF only as the line terminator.
- Send CR-LF (carriage return followed by line feed) at the end of every message.

Remote-Local Operating States

The following paragraphs describe the two operating states of the instrument: Local and Remote.

REMOTE OFF (LOCAL)—With REMOTE OFF, instrument settings are controlled manually by the operator using the front-panel controls. Option interface messages such as REMOTE ON, RQS ON, and OPC ON are received and executed. Queries about instrument's states or measurement results will be answered. Device-dependent commands that require an instrument operating mode change to be made cause an execution error, and a service request will be generated if RQS is on.

REMOTE ON (REMOTE)—In this state, the oscilloscope executes all commands sent to it. Remote-controllable front-panel indicators and CRT readouts are updated as commands are carried out. There is no local lockout (LLO). Changing any option-controllable front-panel setting locally overrides the remote settings. If a waveform is being transmitted, the PLOT indicator will be lit, and new waveform data will not be acquired until the transmission is done.

Reset Under Communication Option Control

Certain default settings for acquisition and plot modes may be set up sending the INIt command. The INIt command does not invoke the power-up test. Upon completion of the INIt command, no status byte or event code is generated.

The default settings are as follows:

```
ACQUISITION REP:AVE
ACQUISITION HSREC:SAMPLE
ACQUISITION LSREC:PEAKDET
ACQUISITION SCAN:PEAKDET
ACQUISITION ROLL:PEAKDET
ACQUISITION SMOOTH:ON
ACQUISITION WEIGHT:4
ACQUISITION NUMSWEEPS:0
ACQUISITION VECTORS:ON
DATA ENCDG:BINARy
DATA SOURCE:ACQ
DATA TARGET:REF1
PLOT GRAT:OFF
PLOT FORMAT: <power-on setting>
READOUT ON
Menu system reset.
```

RS-232-C PROGRAMMING

Things to consider when writing programs for your RS-232-C controller are given here to help you when you must develop your own interfacing software. Before a program can be used to control the oscilloscope, the RS-232-C communication parameters for baud rate, line terminator, and parity must be set. Settings for these parameters are selected and set using the RS-232-C PARAMETERS switch found on the side panel of the oscilloscope.

Controller programs are usually composed of two main parts or routines. The two parts are generally called the command handler and the service-request handler.

COMMAND HANDLER—Basically, a command handler establishes communication between the controller and the oscilloscope, sends commands to the oscilloscope, receives responses from the oscilloscope, and displays the responses as required. The steps of the following procedure are the general functions that the command-handler software routine should be able to do for the most useful communications.

- Initialize the controller in the communications mode.
- Watch for a service request.

Check the event code (by sending an EVEnt? query) if a service request occurs.

- Determine the action needed to be taken from the event code byte that is returned and take it.
- Get a command to send to the oscilloscope.
- Send a command to the oscilloscope.
- Check for a response from the oscilloscope.
- If the response is an error status, check the event code (Step 3) and take the appropriate action (Step 4).
- Repeat Steps 5 through 8 as many times as needed.

SERVICE REQUEST HANDLER—The service-request handler routine should contain the necessary instructions to process the possible event codes generated by the 2232. The instrument requests service by sending asynchronous status bytes when certain errors occur (if RQS is ON). Other status bytes return as the result of a STATus? query, or when OPC is on. The immediate mode service request may cause the controller to halt unless the controller's program is written to properly handle them. A user may also want the controller routine to be able to recognize and handle the other events requiring service. These events are identified in Tables 8-32 and 8-33 at the back of this section.

The following general steps are required to handle service requests from the oscilloscope.

1. Watch for an asynchronous service-request status byte. This is the same concept as checking for an SRQ with the GPIB controller program.
2. Send an EVEnt? query to obtain the event-code byte that describes in more depth what caused the service request.
3. If the response to the EVEnt? query is not zero, perform the action required to handle the event.
4. Return to the main program.

Option 12 Status and Error Reporting

The status and error reporting system used by the Communication Option sends status bytes that may be viewed as a service request when monitored by the appropriate controller software. As soon as a change of status or an error occurs, the 2232 returns a service request status byte that indicates the type of event that occurred (if RSQ is on). The status byte returned and the event code returned as the reply to an EVEnt? query provide a limited amount of information about the specific cause of the service-request status-byte. Command errors, execution errors, and internal errors generate a service-request status byte immediately (if RQS is ON). To retrieve other system-event and warning status bytes, OPC must be ON, and the

oscilloscope must be queried by the STATUS? command. See Tables 8-32 and 8-33 at the back of this section for status-byte and event codes.

COMMUNICATION AND WAVEFORM TRANSFER

This subsection contains information common to both Option 10 and Option 12. The commands available, the command protocol, waveform transfer information, and the service request status bytes are included in this subsection.

READOUT/MESSAGE COMMAND CHARACTER SET

Character translations performed by the MESSAGE command and query, when sending data to or receiving data from the CRT readout, are indicated in Table 8-12. The standard ASCII character codes are given in Table 8-13.

NOTE

Values in Table 8-12 that have no CRT equivalent are translated into spaces when sent to the display.

Table 8-12
Readout/MESage Command Character Set

B7	B6	B5	B4	B3	B2	B1	CONTROL	SYMBOLS	UPPER CASE	LOWER CASE		
0	0	0	0	0	0	0	T	SP	@	P	'	p
0	0	0	0	0	0	0	0	0	A	Q	a	q
0	0	0	1	0	0	0	B _{WL}	"	B	R	b	r
0	0	1	0	0	0	0	☒	#	C	S	c	s
0	1	0	0	0	0	0	Δ	\$	D	T	d	t
0	1	0	1	0	0	0	-	μ	E	U	e	u
0	1	1	0	0	0	0	=	~	F	V	f	v
0	1	1	1	0	0	0	m	'	G	W	g	w
1	0	0	0	0	0	0		(H	X	h	x
1	0	0	1	0	0	0)	I	Y	i	y
1	0	1	0	0	0	0		*	J	Z	j	z
1	0	1	1	0	0	0		+	K	[k	{
1	1	0	0	0	0	0		,	L	\	l	*
1	1	0	1	0	0	0		-	M]	m	}
1	1	1	0	0	0	0	Hz	.	N	^	n	~
1	1	1	1	0	0	0	1/Δ	/	O	-	o	~

Table 8-13
ASCII Code Chart

B7	B6		B5		CONTROL	NUMBERS				UPPER CASE				LOWER CASE					
	B4	B3	B2	B1		0	1	2	3	4	5	6	7	8	9	0	1	2	3
0	0	0	0	0	NUL	20	40	60	80	100	120	140	160	180					
0	0	0	1	0	DLE	21	41	61	81	101	121	141	161	181					
0	0	1	0	0	SP	22	42	62	82	102	122	142	162	182					
0	0	1	1	0	@	23	43	63	83	103	123	143	163	183					
0	1	0	0	0	P	24	44	64	84	104	124	144	164	184					
0	1	0	1	0	Q	25	45	65	85	105	125	145	165	185					
0	1	1	0	0	a	26	46	66	86	106	126	146	166	186					
0	1	1	1	0	q	27	47	67	87	107	127	147	167	187					
1	0	0	0	0		28	48	68	88	108	128	148	168	188					
1	0	0	1	0		29	49	69	89	109	129	149	169	189					
1	0	1	0	0		30	50	70	90	110	130	150	170	190					
1	0	1	1	0		31	51	71	91	111	131	151	171	191					
1	1	0	0	0		32	52	72	92	112	132	152	172	192					
1	1	0	1	0		33	53	73	93	113	133	153	173	193					
1	1	1	0	0		34	54	74	94	114	134	154	174	194					
1	1	1	1	0		35	55	75	95	115	135	155	175	195					
1	1	1	1	1		36	56	76	96	116	136	156	176	196					
						37	57	77	97	117	137	157	177	197					
						38	58	78	98	118	138	158	178	198					
						39	59	79	99	119	139	159	179	199					
						40	60	80	100	120	140	160	180	200					

KEY octal 25 PPU GPIB code
 hex 15 21 decimal ASCII character

! * on some keyboards or systems

MESSAGES AND COMMUNICATION PROTOCOL

The commands available to the user via either the Option 10 GPIB or the Option 12 RS-232-C communications option can set some of the instrument's digital storage operating modes, query the results of measurements made, or query the state of the oscilloscope. The commands are specified in mnemonics that are related to the functions implemented. For example, the command INIt initializes instrument settings to states that would exist if the instrument's power was cycled. To further facilitate programming, command mnemonics are similar to front-panel control names.

All measurement results returned by the options have the same accuracy as the main instrument.

Commands

Commands for this instrument, like those for other Tektronix instruments, follow the conventions established in a Tektronix Codes and Formats Standard. The command words were chosen to be as understandable as possible, while still allowing a user familiar with the commands to reduce the number of key strokes needed and still have the command unambiguous. Syntax is also standardized to make the commands easier to learn.

In the Command tables found at the end of this section, headers and arguments are listed in a combination of upper-case and lower-case characters. The instrument accepts abbreviated headers and arguments that contain at least the upper-case characters shown in the tables (whether sent in upper case or lower case). The lower-case characters may be added to the abbreviated (upper case) version, but they can only be those shown in lower case. For a query, the question mark must immediately follow the header. For example, any of the following formats are acceptable to the oscilloscope:

VMO? or vmo?
VMOd? or vmod?
VMOde? or vmode?

HEADERS—A command consists of at least a header. Each command has a unique header, which may be all that is needed to invoke a command; for example:

```
INit  
OPC
```

ARGUMENTS—Some commands require the addition of arguments to their headers to describe exactly what is to be done. If there is more to the command than just the header (including the question mark if it is a query), then the header must be followed by at least one space.

In some cases, the argument is a single word; for example:

```
REFTo REF4  
PLOt STArt
```

In other cases, the argument itself requires another argument. When a second argument, or link argument, is required, a colon must separate the two arguments. Two examples of this are:

```
ACQquisition REPetitive:SAMple  
and  
WFMpre XINcr:1.0E-3
```

Where a header has multiple arguments, the arguments (or argument pairs, if the argument has its own argument) must be separated by commas. Two examples of this syntax are:

```
DATa ENCdg:BINary,CHAnnel:CH2  
and  
VMODE? CH1,CH2,ADD
```

NOTE

With Option 12, multiple commands (especially queries) should not be used in a single programmed message line. Commands (and arguments to commands) are interpreted and acted on by the oscilloscope as soon as a separator is recognized; the oscilloscope does not wait for the message terminator (CR or CR-LF) to signal the end of the command line. If one of the commands in a command line requires a response for any reason (i.e., command error, illegal command, or unable to do the command), the oscilloscope's service-request status-byte response will be asynchronously sent. If the service request is not handled correctly, the controller may not be able to continue with its program.

COMMAND SEPARATOR—Multiple commands may be put into one command line by separating the individual commands with a semicolon; for example:

DATA ENCDg:BINary,CHAnnel:CH2;WFMpre XINcr:1.0E-3

Multiple commands in a message are not recommended with RS-232-C controller routines for Option 12. See the previous NOTE. However, the command separator is valid, and multiple commands on the same message line may be used. A waveform preamble is one example of using multiple commands in a single message. With Option 10, GPIB controller programs often use multiple commands in a single line.

GPIB MESSAGE TERMINATOR—As previously explained, GPIB messages may be terminated with either EOI or LF. Some controllers assert EOI concurrently with the last data byte; others use only the LF character as a terminator. The GPIB interface can be set to accept either terminator. With EOI selected, the instrument interprets a data byte received with EOI asserted as the end of the input message; it also asserts EOI concurrently with the last byte of an output message. With the LF setting, the instrument interprets the LF character without EOI asserted (or any data byte received with EOI asserted) as the end of an input message; it transmits a Carriage Return character followed by Line Feed (LF with EOI asserted) to terminate messages.

RS-232-C MESSAGE TERMINATOR – RS-232-C messages from the oscilloscope may be terminated with either carriage return (CR) or the CR and line-feed (LF) characters. The RS-232-C Option can be set to send and receive either terminator as the last byte of a message. The instrument does not wait for the end-of-line terminator when it handles incoming messages. It recognizes a semicolon as the end of command terminator and immediately begins its response to the preceding command string. Because of the way the instrument handles commands, messages should be limited to one command per line. Incoming and outgoing messages are not stacked. If more than one command per line is sent, responses to the first commands in a line may be lost when the output buffer is reinitialized to output the response to the last command in a line. Even single command messages should not be terminated twice. The response to the command may be lost when the instrument sees the second terminator.

COMMAND FORMATTING – Commands sent to the oscilloscope must have the proper format (syntax) to be understood; however, this format is flexible in that many variations are acceptable. The following paragraphs describe this format and the acceptable variations.

The oscilloscope expects all commands to be encoded as either upper-case or lower-case ASCII characters. All data output is in upper case.

Spaces can be used as formatting characters to enhance the readability of command sequences. As a general rule, spaces can be placed either after commas and semicolons or after the space that follows a header.

NUMERIC ARGUMENTS – Table 8-14 shows the number formats for the <NR1>, <NR2>, and <NR3> arguments used in a command. Both signed and unsigned numbers are accepted, but unsigned numbers are taken as positive.

Table 8-14
Numeric Argument Format for Commands

Numeric Argument	Number Format	Examples
<NR1>	Integers	+1, 2, -1, -10
<NR2>	Explicit decimal point	-3.2, +5.1, 1.2
<NR3>	Floating point in scientific notation	+1.E-2, 1.0E+2, 1.E-2, 0.02E+3

WAVEFORM TRANSFERS

The instrument can transmit and receive waveforms. It can transfer these waveforms in binary, hexadecimal, or ASCII encoding. When sending waveforms to the instrument, the target must be one of the numbered reference memories. Waveforms transferred from the oscilloscope to the controller may be from either the current acquisition or one of the numbered reference memories. The data source (the memory location from which the waveform data comes) and the data target (the memory location where data sent to the oscilloscope ends up) are selected independently.

Waveform Preamble

The waveform preamble contains the attributes for the associated waveform data. These attributes include the number of points per waveform, scale factors, vertical offsets, horizontal increment, scaling units, and data encoding. The preamble information is sent as an ASCII-encoded string in all cases. The exact attributes sent depend on the waveform and the acquisition mode.

A typical response to the preamble query WFMpre? for a Y (time-implied) acquisition is:

```
WFM WFI: "ACQ, CH1,0.5V,DC,0.2mS,SAMPLE,  
CRV# 1",NR.P:4096,PT.O:122,PT.F:Y,  
XMU:0.0E0,XOF:0,XUN:S,XIN:2.0E-6,  
YMU:20.0E-3,YOF:-20,YUN:V,ENC:HEX,BN.F:RP,  
BYT:1,BIT:8,CRV:CHK;
```

A typical response to the preamble query for an X-Y acquisition is:

```
WFM WFI: "ACQ,XY,0.2V,DC,50.0mV,DC,  
1.0μS, SAMPLE, CRV# 4",  
NR.P:2048,PT.O:216,PT.F:XY,XMU:8.0E-3,  
XOF:0,XUN:S,XIN:20.0E-9,YMU:2.0E-3,YOF:0,  
YUN:V,ENC:BIN,BN.F:RP,BYT:1,BIT:8,CRV:CHK;
```

These replies are single line messages that end with the selected message terminator (CR or CR-LF). With the GPIB interface, EOI (end-or-identify) is also sent if that terminator mode is selected.

Transferring Waveforms

The oscilloscope can respond with the preamble only, the curve data only, or the preamble and curve data together. The queries to obtain these responses are, in order, WFMpre?, CURVe?, and WAVfrm?

For the combined response to WAVfrm?, the preamble is separated from the curve data by a semicolon (;).

The preamble information is always formatted as ASCII characters. Waveform (CURVE) data internal to the oscilloscope is stored as 8-bit, unsigned integers. Before that data is sent via the Communications option, it is changed into one of three formats: binary, hexadecimal, or ASCII. The resolution of the formatted data points may be either 8-bit or 16-bit. Waveform record length is 1024 data points for the shortest or 4096 data points for the longest. The number of bytes that are required to transfer data depends on several variables. See the NR.Pts description in the Waveform Preamble Fields command table for more information. The largest number of curve data bytes ever needed to send a waveform is 8192 bytes (for a 4K record that has two bytes per data point).

Binary Encoding

BINary data is transferred as unsigned binary integers. Each data point in the record is either 8 bits or, when averaged, 16 bits. BINary encoding format has the following waveform curve data form:

CURVE < space > % < Binary Count MSB > < Binary Count LSB > < Binary Data > < Checksum > < Terminator >

Where:

CURVE	is a literal string indicating that curve data follows.
%	is used as a header character to show the start of a binary block.
< Binary Count MSB >	is the most-significant byte of the two-byte Binary Count. Binary Count is the length of the waveform, in bytes, plus the one-byte checksum.
< Binary Count LSB >	is the least-significant byte of the Binary Count.
< Binary Data >	is made up of 256, 512, 1024, 2048, or 4096 data points. Each data point is either a 1-byte (8 bits) or 2-byte (16 bits) representation of each digitized value.
< Checksum >	is the two's-complement of the modulo 256 sum of the preceding data bytes and the binary count. The Checksum is used by the controller program to verify that all data values have been received correctly.

Table 8-15 illustrates the data transferred for a 4096-point, 8-bit, binary-encoded waveform. The waveform data-point values vary with the signal amplitude.

Table 8-15
Typical 8-Bit Binary-Encoded Waveform Data

Byte	Contents	Decimal	GPB EOI (1 = Asserted)
1	C	67	0
2	U	85	0
3	R	82	0
4	V	86	0
5	E	69	0
6	<SP>	32	0
7	%	37	0
8	<Bin Count MSB>	16 ^a	0
9	<Bin Count LSB>	01 ^a	0
10	1st Pt	d ₁	0
11	2nd Pt	d ₂	0
.	.	.	0
.	.	.	0
.	.	.	0
4105	4096th Pt	d ₄₀₉₆	0
4106	<Checksum>	chk	1 When TERM = EOI
4107 ^b	<CR>	13	0
4108 ^c	<LF>	10	1

^a(1001₁₆ or 4097₁₀)

^bAll RS-232-C or GPB with TERM = LF/EOI.

^cRS-232-C with TERM = CR-LF.

Table 8-16 illustrates the data transferred for a 4096-point, 16-bit (averaged), binary-encoded waveform.

Table 8-16
Typical 16-Bit Binary-Encoded Waveform Data

Byte	Contents	Decimal	GPIB EOI (1 = Asserted)
1	C	67	0
2	U	85	0
3	R	82	0
4	V	86	0
5	E	69	0
6	<SP>	32	0
7	%	37	0
8	<Bin Count MSB>	32 ^a	0
9	<Bin Count LSB>	01 ^a	0
10	1st Pt MSB	d _{1H}	0
11	1st Pt LSB	d _{1L}	0
12	2nd Pt MSB	d _{2H}	0
13	2nd Pt LSB	d _{2L}	0
.	.	.	0
.	.	.	0
.	.	.	0
8200	4096th Pt MSB	d _{4096H}	0
8201	4096th Pt LSB	d _{4096L}	0
8202	<Checksum>	chk	1 When TERM = EOI
8203 ^b	<CR>	13	0
8204 ^c	<LF>	10	1

^a(2001₁₆ or 8193₁₀)

^bAll RS-232-C or GPIB with TERM = LF/EOI.

^cRS-232-C with TERM = CR-LF.

Hexadecimal Encoding

With HEXadecimal waveform data encoding, characters representing an 8-bit or 16-bit data point are sent in a fixed ASCII hexadecimal format. There are no delimiters (commas) between data points. Data format is very similar to BINary format, with the following exceptions:

1. The curve header is CURVE #H instead of CURVE % .
2. Each data point is two ASCII hexadecimal characters for 8-bit transfers and four ASCII hexadecimal characters for 16-bit transfers.
3. The byte count is sent as four successive ASCII hexadecimal characters, but the value of the byte count is identical to a comparable BINary transfer.
4. The checksum is sent as two successive ASCII hexadecimal characters.

Tables 8-17 and 8-18 illustrate 8-bit and 16-bit HEXadecimal-encoded waveform data transfers.

ASCII Encoding

With ASCII waveform data encoding, ASCII characters representing the decimal value of each waveform data point are sent in variable length format, separated by commas. In ASCII format, the curve data transfer is represented as:

CURVE < space > data,data,data,.....,data < terminator >

Table 8-19 illustrates an 8-bit ASCII-encoded waveform transfer. Transmission length depends on specific waveform data values, record length, acquisition mode and smoothing, and whether the acquisition is one or two channels.

Table 8-17
Typical 8-Bit Hexadecimal-Encoded Waveform Data

Byte	Contents	Decimal	GPIB EOI (1 = Asserted)
1	C	67	0
2	U	85	0
3	R	82	0
4	V	86	0
5	E	69	0
6	<SP>	32	0
7	#	35	0
8	H	72	0
9	<Bin Count MS 4 bits>	49	0
10	.	48	0
11	.	48	0
12	<Bin Count LS 4 bits>	49	0
13	1st Pt MS 4 bits	d _{1H}	0
14	1st Pt LS 4 bits	d _{1L}	0
15	2nd Pt MS 4 bits	d _{2H}	0
16	2nd Pt LS 4 bits	d _{2L}	0
.	.	.	0
.	.	.	0
203	4096th Pt MS 4 bits	d _{4096H}	0
204	4096th Pt LS 4 bits	d _{4096L}	0
205	<Checksum MS 4 bits>	chk _H	0
206	<Checksum LS 4 bits>	chk _L	1 When TERM = EOI
207 ^a	<CR>	13 (if term = LF/EOI)	0
208 ^b	<LF>	10 (if term = CR-LF)	1

^aAll RS-232-C or GPIB with TERM = LF/EOI.

^bRS-232-C with TERM = CR-LF.

Table 8-18
Typical 16-Bit Hexadecimal-Encoded Waveform Data

Byte	Contents	Decimal	GPIB EOI (1 = Asserted)
1	C	67	0
2	U	85	0
3	R	82	0
4	V	86	0
5	E	69	0
6	<SP>	32	0
7	#	35	0
8	H	72	0
9	< Bin Count MS 4 bits >	50	0
10	.	48	0
11	.	48	0
12	< Bin Count LS 4 bits >	49	0
13	1st Pt MS 4 bits	d _{1H}	0
14	.	.	0
15	.	.	0
16	1st Pt LS 4 bits	d _{1L}	0
17	2nd Pt MS 4 bits	d _{2H}	0
18	.	.	0
19	.	.	0
20	2nd Pt LS 4 bits	d _{2L}	0
.	.	.	0
.	.	.	0
6393	4096th Pt MS 4 bits	d _{4096H}	0
6394	.	.	0
6395	.	.	0
6396	4096th Pt LS 4 bits	d _{4096L}	0
6397	< Checksum MS 4 bits >	chk _H	0
6398	< Checksum LS 4 bits >	chk _L	1 When TERM = EOI
6399 ^a	<CR>	13 (if term = LF/EOI)	0
6400 ^b	<LF>	10 (if term = LF/EOI)	1

^aAll RS-232-C or GPIB with TERM = LF/EOI.

^bRS-232-C with TERM = CR-LF.

Table 8-19
Typical ASCII-Encoded Waveform Data

Byte	Contents	Decimal	GPIB EOI (1 = Asserted)
1	C	67	0
2	U	85	0
3	R	82	0
4	V	86	0
5	E	69	0
6	<SP>	32	0
7	Pt ¹⁰⁰ ₁ ^a	d ¹⁰⁰ ₁	0
8	Pt ¹⁰ ₁ ^a	d ¹⁰ ₁	0
9	Pt ¹ ₁ ^a	d ¹ ₁	0
10	.	44 ^b	0
.	.	.	0
.	.	.	0
XXX	Pt ¹⁰⁰ ₄₀₉₆ ^a	d ¹⁰⁰ ₄₀₉₆	0
XXX	Pt ¹⁰ ₄₀₉₆	d ¹⁰ ₄₀₉₆	0
XXX	Pt ¹ ₄₀₉₆ ^a	d ¹ ₄₀₉₆	0
XXX ^c	<CR>	13	0
XXX ^d	<LF>	10	1

^aEach value sent may consist of from 1 to 3 characters normally, 1 to 5 for averaged data. The notation Pt¹⁰⁰ means "the hundreds digit", and Pt¹⁰ means "the tens digit", which may or may not be sent, depending on the magnitude of the value.

^bThe decimal value 44 equates to the comma sent between each successive value.

^cAll RS-232-C or GPIB with TERM = LF/EOI.

^dRS-232-C with TERM = CR-LF.

COMMUNICATION COMMANDS

Tables 8-20 through 8-31 describe all commands available for the 2232 Digital Storage Oscilloscope equipped with either Communications option. The Commands column lists the complete command with header and argument(s). Multiple link arguments are enclosed in angle brackets (< link1, link2, or link3 >). Numeric value arguments are also enclosed in angle brackets (< NR1 >). Default arguments are enclosed in square brackets ([default]). Default arguments may be omitted from the command if that is the mode you want.

The capital letters shown are the fewest number of characters that identify the command as unique. They are also the letters returned by the oscilloscope with LONG OFF. Those letters shown in lower case are optional in the command. With LONG ON, all the letters of query return will be returned. All responses to queries are returned in upper case. The second column of the command tables gives a complete description of the command operation.

With GPIB, one or more arguments, separated by commas, may be given in a query to request only the information wanted rather than sending separate commands for each query. An example of this type of command is as shown:

CH1? VOLts,COUpling;

With RS-232-C, program your controller routines to send only one command at a time with single arguments of the form:

header argument:link argument;

This allows the controller to handle any asynchronous service request that may be generated by a command before attempting a second command.

Instrument commands are presented in tables divided into the following functional groups:

Options and Accessories

Table	Command Group
8-20	Vertical Commands
8-21	Horizontal Commands
8-22	Trigger Commands
8-23	Cursors Commands
8-24	Display Commands
8-25	Acquisition Commands
8-26	Save and Recall References Commands
8-27	Waveforms Commands
8-28	Waveform Preamble Fields
8-29	Miscellaneous Commands
8-30	Service Request Group Commands
8-31	RS-232-C Specific Commands

Table 8-20
Vertical Commands

Commands	Description
CH1?	Query only. Returns the present CH1 settings: CH1 VOL: <NR3>, COU: <AC, DC, or GND>. <NR3> is the VOLTS/DIV setting.
CH1? VOLts	Query only. Returns the CH1 VOLTS/DIV setting (including the probe attenuation factor). The value returned is a <NR3> number. For example, if the VOLTS/DIV setting is 50 mV, the value returned is CH 1 VOL:5.OE-2. An execution warning is generated if the VOLTS/DIV CAL knob is not in the detent (calibrated) position.
CH1? COUpling	Query only. Returns the present CH1 input coupling: COU: <AC, GND, or DC>.
CH2? CH2? VOLts CH2? COUpling	Queries for CH2 the same as for CH1.
CH2? INVert	Query only. Returns CH2 INV: <ON or OFF>.
VMOde?	Query only. Returns the vertical mode setting: VMO: <CH1, CH2, ADD, CHOp, ALT, or XY>.
BWL?	Query only. Returns BWL: <ON or OFF>.
PROBe? CH1 or CH2>	Query only. Returns the probe attenuation coding of the queries channel: CH <1 or 2> PROBe: <NR1>. <NR1> may be 1000, 100, 10, 1, -1, or -2. The -1 value is for identify, and the -2 value is for unknown probe coding.

Table 8-21
Horizontal Commands

Commands	Description
DELAy?	Query Only. Returns the present horizontal delay settings as: DELA VAL: <NR3> , UNI: <S or DIV> .
DELAy? VALue	Query Only. Returns an <NR3> value that represents the present delay value in the units returned by the UNIts query as DELA VAL: <NR3> .
DELAy? UNIts	Query Only. Returns a string of either S or DIV that corresponds to the DELAY? VALue units as DELA UNI <SEC or DIV> . The units are DIV when the SEC/DIV knob is set to EXT CLK.
HORizontal?	Query Only. Returns all present horizontal settings as appropriate for the type of instrument.
HORizontal? ASECDiv	Query Only. Returns an <NR3> value that represents the present A SEC/DIV setting in the form: HOR ASE: <NR3> . The value returned is zero when the SEC/DIV knob is set to EXT CLK.
HORizontal? BSECDiv	Query Only. Returns an <NR3> value that represents the present B SEC/DIV setting in the form: HOR BSE: <NR3> .
HORizontal? EXTclk	Query Only. Returns the state of the external clock HOR EXT: <FAST, SLOW, or OFF> .
HORizontal? HMAg	Query Only. Returns the state of the X10 magnifier as: HOR HMA: <ON or OFF> .
HORizontal? MODE	Query Only. Returns the present horizontal mode setting as: HOR MOD: <ASW, AIN, or BSW> .

Table 8-22
Trigger Commands

Commands	Description
ATRigger?	Query Only. Returns the present A trigger mode, and the value of the A Trigger level.
ATRigger? MODE	Query Only. Returns the present A TRIGGER mode in the form: TR MOD: <NOR, PPA, or SGL>;. PPA is returned for both Peak-to-Peak Auto and TV Field trigger modes. The reply in the same with or without optional [MODE] argument.
ATRigger? LEVEL	Query only. Returns the setting value of the A trigger level. ATR LEV: <NR3> in volts.
SGLswp ARM	Rearms a completed single sweep. An execution error is generated if the instrument is not in SGL SWP mode, and an execution warning is generated if the single sweep is already armed. With OPC ON, a service request status byte for operation complete is generated when the single sweep occurs.
SGLswp?	Query Only. Returns the state of the SGL SWP trigger mode as: SGL <ARM or DON>; when SGL SWP trigger mode is on. If SGL SWP trigger mode is not on, a reply of "SGL;" is made, and an execution warning is generated.
TRIGGERED?	Query Only. Returns the present state of the TRIG'D indicator as: TRI <ON or OFF>;.

Table 8-23
Cursor Commands

Commands	Description
CURSor CHAnnel: <CH1-CH2>	Selects the named channel as the channel from which the cursor voltage difference is returned by the DELTAV? query. No warning is generated if the cursors are directed to an undisplayed channel.
CURSor POSition: <NR1>	Selects the horizontal data point position of the active cursor. If the acquisition is a 1-Kbyte record and the position requested is past 1023 data points, the value is limited to position 1023, and no warning is sent. If the acquisition is a 4-Kbyte record and the position requested is past 4095 data points, a command error service request is generated, and the command is ignored.
CURSor SElect: <CURS1-CURS2>	Selects the named cursor to be positioned by the CURS POS command.
CURSor TARget: ACQuisition	Attaches the displayed cursors to acquisition waveform.
CURSor TARget: <REF1-REF3>	Attaches the displayed cursors to the named reference waveform. If the named reference is not displayed, the command is ignored. No warning is issued for directing the cursors to an undisplayed reference.
CURSor TARget:REF4	Attaches the displayed cursors to REF4. No warning is issued for directing the cursors to REF4 if it is not displayed, but an execution error service request is generated if REF4 is empty.

Table 8-23
Cursor Commands (cont)

Commands	Description
CURSor?	Query Only. Returns all the present cursor argument states in the form: CURS SEL:CH1, TAR:ACQ, CHA:CH1, POS:1047;. Each of the CURSor arguments may be separately queried as in: CURSOR? TAR to obtain the present status of that argument only.
DELTAV?	Query Only. Returns an <NR3> value that represents the present voltage difference between the selected TARget and CHAnnel cursors and the measurement units as either V or PERcent. The form of the return is: DELTAV VAL:0.500e0, UNI:VOL;. PERcent is returned for the units when the VOLT/DIV variable knob is out of the CAL detent position.
DELTAV? VALue	Query Only. Returns the cursor voltage difference only in the form: DELTAV VAL: <NR3> ;. The return defaults to a displayed CHAnnel even if directed elsewhere to an undisplayed CHAnnel.
DELTAV? UNIts	Query Only. Returns the voltage measurement units only in the form: DELTAV UNI: <VOL or PER > ;. See the preceding DELTAV? query description.
DELTAT?	Query Only. Returns an <NR3> value that represents the present time difference between the two cursors with the measurement units in the form: DELTAT VAL: 1.180E-3, UNI:SEC;. The measurement units are returned in DIVisions if the SEC/DIV setting is EXT CLK.

Table 8-23
Cursor Commands (cont)

Commands	Description
DELTAT? VALue	Query Only. Returns the cursor time difference only in the form: DELTAT VAL: <NR3>;. Time difference is returned even when the readout is in frequency units for 1/ Δ t measurements.
DELTAT? UNIts	Query Only. Returns the time measurement units only in the form: DELTAT UNI: <SEC or DIV>;. See the preceding DELTAT? query description.

Table 8-24
Display Commands

Commands	Description
MESsage <NR1> : "message"	<p>Writes the "message" text on the named row. Values of <NR1> row numbers are from 16 (the top row) to 1 (the bottom row). The normal readout displays are turned off by the MESsage <16-1> command. Changing a front-panel control that requires a readout overrides the "message" and returns the normal readout display. The MES [0] command turns off the message display and returns the display to the state it was in when the original message was sent.</p> <p>The message must be enclosed in quote marks. The displayed message lines start at the left edge of the graticule area. If longer than about 40 characters, the message runs off the right edge of the CRT. If the message is too long, it is truncated, and a service request is issued (if RQS is ON).</p> <p>Displaying many message lines can cause display flicker and may exceed the display memory area.</p>
PLOt ABOrt	<p>Stops a plot in progress and returns to the previous mode. PLOt ABOrt is the only command or query that the oscilloscope responds to during a plot. PLOt ABOrt turns off the AUTO argument.</p>
PLOt AUTO: <ON or OFF>	<p>Turns the AUTO plot mode ON or OFF. If AUTO is ON, each waveform is plotted after it is acquired. The graticule will be plotted once in AUTO, if GRAt is ON.</p>

Table 8-24
Display Commands (cont)

Commands	Description
PLOT FORMat: <[XY], HPGL, EPS7, EPS8, or TJet >	Sets the output data format for the named plotter. If one of the named plotters is not selected, the data is plotted in the default XY format. HPGL formats for HP-GP compatible plotters. EPS7 and EPS8 format for 7-bit (low-speed, double-density) and 8-bit (high-speed, double-density) EPSON® format printers respectively. TJet formats for the Hewlett-Packard ThinkJet® printer. With Option 10, a GPIB controller may direct the plotting operation by addressing the plotter to listen and then addressing the oscilloscope to talk and giving the PLOT START command.
PLOT GRAT: <ON or OFF >	Turns the plotted graticule either ON or OFF.
PLOT SPEEd: <NR1 >	The <NR1 > number must be an integer from 1 to 10 and changes the analog plotter pen speed. The units are roughly in divisions per second.
PLOT START	Starts a plot using the parameters selected by PLOT FORMat, PLOT GRAT, and PLOT SPEEd. While a plot is in progress, all commands and queries (except PLOT ABOrt) are ignored.

Table 8-25
Acquisition Commands

Commands	Description
ACquisition CURRent: <ACCpeak AVERage, [DEFault], PEAKdet, or SAMple >	Selects the named mode for the CURRent acquisition type and SEC/DIV setting. If a mode argument is not specified, the command selects the default mode for the present acquisition type and SEC/DIV setting. A service request is generated if the mode asked for is not valid with the present acquisition type or SEC/DIV setting.
ACquisition REPetitive: <[AVERage] ACCpeak, or SAMple >	Selects the named mode for the SEC/DIV settings from 0.05 μ s/div to 0.2 μ s/div (ALT, CHOP) or 0.05 μ s/div (CH 1, CH 2, ADD).. AVERage is the default mode and will be selected if the mode argument is omitted.
ACquisition HSRec: <[SAMple] ACCpeak AVERage >	Selects the named mode for the SEC/DIV settings for 1 μ s/div and 2 μ s/div (and for 0.5 μ s/div in two-channel acquisition). SAMple is the default mode and will be selected if the mode argument is omitted.
ACquisition LSRec: <[PEAKdet] ACCpeak, AVERage, or SAMple >	Selects the named mode for the SEC/DIV settings from 5 μ s/div to 50 ms/div. PEAKdet is the default mode and will be selected if the mode argument is omitted.
ACquisition ROLI: <[PEAKdet] or SAMple >	Selects the PEAKdet or SAMple mode for ROLI acquisitions from 0.1 sec/div to 5 sec/div. ROLI mode acquisitions are untriggered.

Table 8-25
Acquisition Commands (cont)

Commands	Description
ACQuisition SCAn: < [PEAkdet] SAMPLE > ACCpeak AVERage >	Selects the named mode for the SEC/DIV settings for 0.1 sec/div to 5 sec/div.
ACQuisition NUMsweeps: <NR3 >	Sets the number of sweeps done before halting; 0 implies continuous mode (don't halt).
ACQuisition RESet	Command only. Sets sampling at all SEC/DIV settings to its default mode. Default modes are enclosed in brackets ([]) in the commands.
ACQuisition SMOoth: <ON or OFF >	Applies smoothing to the acquired waveform data when ON.
ACQuisition TRIGCount: <NR1 >	Sets the number of data points acquired before the trigger point in the waveform record. The range of the <NR1 > number depends on the record length and the selection of pre- or post-trigger. In pretrigger, the <NR1 > range is 4 to 512 for 1 k records and 16 to 2048 for 4 k records. In post-trigger, the range is from 512 to 1020 for 1 k records and 2048 to 4080 for 4 k records. The resolution of <NR1 > is ± 4 counts.
ACQuisition VECtors: <ON, OFF, or [AUTO] >	Turns Vectors mode to ON, OFF, or AUTO. AUTO selects the most appropriate setting for each acquisition mode.

Table 8-25
Acquisition Commands (cont)

Commands	Description
ACQ <u>is</u> tion <u>W</u> EIght: <NR1 >	Sets the number of acquisitions weighted into an AVEraged waveform record. The valid values for <NR1 > are: 1, 2, 4, 8, 16, 32, 64, 128, and 256. A service request is generated and the command is ignored if the argument is not one of these numbers. If the argument for WEIght is omitted, <NR1 > reverts to 4.
ACQ <u>is</u> tion?	Returns the settings of the acquisition modes in the following short form with LONG set to OFF. ACQ REP:AVE,HSR:SAM,LSR:PEA,SCA:PEA,ROL:PEA,SMO:ON,WEI:4,SWP:1037,NUM:0,POI:4096,TRIGM:POST,TRIGC:2000,SAV:OFF,DIS:SCA,VEC:ON; Each of the acquisition command arguments (except RESet) may be queried separately to find out that argument's status.
ACQ <u>is</u> tion? <u>D</u> ISplay	Query Only. Returns a string of either ROLI or SCAn for the present state of the ROLL/SCAN button. The form of the return is: ACQ DIS: <ROL or SCA >;
ACQ <u>is</u> tion? <u>P</u> OINts	Query Only. Returns an <NR1 > value that is the number of data points in the waveform record. The form of the return is: ACQ POI: <NR1 >;

Table 8-25
Acquisition Commands (cont)

Commands	Description
ACQquisition SAVE	Returns a string of either ON or OFF for the present state of the acquisition system (ON for SAVE and OFF for CONTINUE).
ACQquisition? SWPcount	Query Only. Returns an <NR1> value for the number of sweeps completed in an acquisition. The form of the return is: ACQ SWP: <NR1>;
ACQquisition? TRIGMode	Query Only. Returns a string of either PRE or POST for the present ACQquisition Trigger setting in the following form: ACQ TRIGM: <PRE or POST>;
STORE	Query Only. Returns the present state of the STORE/NON-STORE button in the form: STOR <ON or OFF>;

Table 8-26
Save and Recall Reference Commands

Commands	Description
REFFrom [ACQ]	Selects the acquisition as the source for the waveform data to be saved into one of the numbered reference memories by the SAVeref command. ACQ is the default argument (indicated by the square brackets, ([])) and need not be present in the command to select it as the data source.
REFFrom REF < 1-4 >	Selects the named reference memory as the data source for the next SAVeref command. Acquisition (ACQ) waveforms must first be stored into one of the numbered references (REF1-REF4) before they may be saved into one of the lettered references (REFA-REFZ).
REFFrom REF < A-Z >	Selects the named extended memory location (REFA-REFZ) as the source of waveform data for the next SAVeref command. The total extra memory is 26 Kbytes, and stored waveform records of 1 k to 8 k (averaged 4 k acquisitions) may be stored. The nonvolatile references of the 2232 may not be displayed, plotted, or transmitted directly; they must first be moved to one of the numbered references (REF1-REF4) using the REFFrom and SAVeref commands.
REFDisp REF < 1-3 > : < ON, OFF or EMPTY >	Turns the names reference display ON or OFF. EMPTY erases the named reference display and turns it off. Reference memory locations 1, 2 and 3 are 1024-point memories.

Table 8-26
Save and Recall Reference Commands (cont)

Commands	Description
REFDisp REF4: <ON, OFF or EMPTY>	REF4 stores a 4 k (4096-point) reference waveform and occupies the REF1-REF3 memory locations.
REFDisp REF<A-Z>:EMPTY	The EMPTY command erases named reference if it is not protected (see REFProt command). The lettered references may not be displayed directly; they must be moved to a numbered save reference memory (REF1-REF4).
REFProt REF<A-Z>: <LOCKed, PERM, or UNLOCKed>	These commands control the write protection of the 2232 nonvolatile reference memories (REFA-REFZ). LOCKed and PERM disable further storage into the named reference or erasure of the waveform data. PERM protected waveform data cannot be overwritten using the front-panel controls. See REFStat queries to obtain write protection and bytes free status.
REFormat CHAnnel: <[CH1] or CH2>	Selects which channel of the saved reference to REFormat. If there is no SAVE REF waveform for the named channel, a service request status byte is generated. If an XY waveform is selected for reformatting, either channel may be selected. CH1 is selected without the CH1 argument.
REFormat HMAg:ON	Increases the horizontal gain of the REFORMAT TARget reference waveform set (affects vertical channels) by a factor of ten times.

Table 8-26
Save and Recall Reference Commands (cont)

Commands	Description
REFOFormat HMAg:OFF	Turns off the horizontal magnification of the REFORMAT TARGet reference waveform set.
REFOFormat VGAin: <NR3>	Changes the vertical gain of the reference target and channel designated by REFOFormat TARGet and REFOFormat CHAnnel. This command is not valid for XY waveforms. The maximum <NR3> value permitted is the equivalent of ± 3 detent positions of the VOLT/DIV switch (in a 1-2-5 sequence). An execution error status byte is generated either if the asked-for setting is out of the maximum change range or if it is not a 1-2-5 sequence setting.
REFOFormat TARGet: REF <1-4>	Selects the reference to REFOFormat.
REFOFormat VPOsition: <NR3>	Adjusts the vertical position of the reformatting target waveform. The valid range of <NR3> is ± 10 divisions from the original display position (before any reformatting) with a resolution of one displayed bit.
REFDisp REF <1-4>	Controls the display of the named reference memory location as ON, OFF, or EMPTY.
REFFrom?	Query returns the selected source of waveform data for the SAVeref command. The reply may be from ACQ or any REFErence from (REF1-REF4) and (REFA-REFZ).

Table 8-26
Save and Recall Reference Commands (cont)

Commands	Description
REFOFormat?	Query Only. Returns the status of the REFOFormat command and query arguments. A sample return is: REFO TAR:REF4, CHA: CH2, VGA:0.5E + 0, VPO: + 3.96, HMA:OFF, BAS:0.2E + 0,MOD:CH1; Each of the command arguments may be individually queried for their status with respect to the REFOFormat TARget and CHAnnel reference waveform.
REFOFormat? BASegain	Query Only. Returns the vertical gain setting at which the REFOFormat TARget waveform as acquired as an <NR3> number.
REFOFormat? MODe	Query Only. Returns the vertical mode in which the REFOFormat TARget waveform was acquired (CH1, CH2, ADD, CHOP, ALT, or XY).
REFStat? FILI	Query Only. Returns a thirty-number string that indicates the fill status of each of the reference memories from REF1 to REFz. The numbers are 0 (empty), 1, 2, 4, or 8 and indicate the stored waveform record in Kbytes.
REFStat? FREe	Query Only. Returns the number of free Kbytes in the nonvolatile reference memory as a <NR1> number from 0 to 26.
REFStat? PROTeCt	Query Only. Returns a thirty-character string that indicates the protected status of each of the reference memories from REF1 to REFZ. The characters returned are U, L, or P and correspond to unlocked, locked, or permanent protection status.

Table 8-26
Save and Recall Reference Commands (cont)

Commands	Description
SAVeref REF <1-3>	Command only. Saves the waveform selected by the REFFrom command into the named reference. REF1, REF2, and REF3 are 1 k (1024-point) memory locations. Any 1 k portion of 4 k waveform acquisition (from ACQ or REF4) may be saved as a 1 k reference in REF1-REF3; the 1 k portion stored into REF1-REF3 is determined by the position of the active cursor. The saved reference display is also turned on.
SAVeref REF4	Command only. REF4 is a 4 k (4096-point) memory location.
SAVeref REF <A-Z>	Command only. Saves the waveform selected by the REFFrom command into the named reference (REFA-REFZ). Reference waveforms stored as 4 k records cannot be moved as 1 k records into REF1-REF3; to be either displayed or transmitted 4 k records must be moved into REF4.

Table 8-27
Waveform Commands

Commands	Description
CURVe	<p>Use as a command to send waveform data to the oscilloscope. The DATA TARGet command points to the reference memory where the data is sent. The DATA CHANnel command points to the channel where the data is sent. The DATA ENCDg command tells the oscilloscope the format of the data (HEX, BINary, or ASCii).</p> <p>Use as a query to get waveform data from the oscilloscope. The DATA SOURce and DATA CHANnel commands select the source of the waveform data.</p> <p>The data sent or received is in the form: CURVE <data>; where the <data> is encoded for HEX, BINary, or ASCii in the following form:</p> <p style="padding-left: 2em;">% <byte count> <binary data> <checksum> for BIN,</p> <p style="padding-left: 2em;">#H<byte count> <hex data> <checksum> for HEX, or <ascii data> for ASCii encoding.</p> <p>With ASCii format, each data value is separated by a comma.</p>
DATA CHANnel: <[CH1] or CH2>	<p>Selects the channel of a waveform set from which CURVe?, WAVfrm?, or WFMpre? query will return data and the target channel for waveform data going into oscilloscope.</p> <p>If there is no waveform in the named channel, a service request is sent when the data is requested.</p> <p>At power-up, the selected channel is CH1. CH1 must be selected for an XY acquisition.</p>

Table 8-27
Waveform Commands (cont)

Commands	Description
DATA ENCDg: < ASCii, [BINary], or HEX >	Sets the curve data encoding and decoding format. The power-on default is BINary. Data points are represented as unsigned integers in all formats.
DATA SOURCE: < REF1, REF2, or REF3 >	Selects the named reference memory to provide the waveform data for a WAV?, WFM?, or CURV? query.
DATA SOURCE: < [ACQ] or REF4 >	Selects either the present acquisition or the REF4 reference memory to provide the waveform data for a WAV?, WFM?, or CURV? query. The power-on default is ACQ, and it will be selected if the argument is omitted. A saved 4 k record is moved from the instrument by specifying REF4 as the data source.
DATA TARget: < REF1, REF2, or REF3 >	Selects the named reference memory to receive data sent with a CURve or WFMpre command. At power-on, REF1 is selected.
DATA TARget: REF4	Selects REF4 as the reference memory to receive data sent with a CURve or WFMpre command. The REF4 must be selected as the data target to transfer in a 4 k waveform.
DATA?	Query Only. Returns the selection of data source, target, channel and encoding. The short form of the return is: DAT SOU:ACQ,TAR:REF1,CHA:CH1, ENC:BIN; Each DATA argument may be individually queried to obtain that selection only.

Table 8-27
Waveform Commands (cont)

Commands	Description
WAVfrm?	Query Only. Returns the waveform data from the oscilloscope. The return is the combined waveform preamble and waveform data. The waveform assigned by the DATA SOURCE and DATA CHANNEL commands is sent in the encoding assigned by the DATA ENCODING command. The form of the return is: WFM <ascii preamble>; CURV <waveform data>;

NOTE

The information given in the Waveform Preamble Fields table is primarily to help identify the result of a WFMpre? query. As such, the arguments are not usually sent as individual commands, but are grouped together as a complete waveform preamble. If sent as a single command, an argument value is not accepted (except as noted for ENCdg) until the curve it is supposed to go with is transferred to the selected DATA TARGET reference memory. If any size error in any of the waveform preamble numeric arguments is sent to the oscilloscope, it will be accepted. Then, when the curve data is sent, the error will be rejected, and a waveform preamble error service request will be sent.

Table 8-28
Waveform Preamble Fields

Commands	Description
WFMpre ENCdg: < ASCii, [BINary], or HEX >	Selects the waveform curve data encoding format for transferring data. WFMpre ENCdg and DATA ENCdg operate identically. Data points are represented as unsigned integers in any of the encoding formats.
WFMpre?	Returns the waveform identification string as with the WFMpre? WFId query plus the value for all the waveform preamble arguments. The short form of the return is: WFM WFI: " < identification string > ", NR.P:2048,PT.O:256, PT.F:ENV, XMU:1.0E+3, XOF:0, XUN:S, XIN:10.0E-6, YMU:8.0E-3, YOF:0, YUN:V, ENC:ASC, BN.F:RP, BYT:1,BIT:8, CRV:CHK; Each of the arguments may be queried separately to find out its value.

Table 8-28
Waveform Preamble Fields (cont)

Commands	Description
WFMpre? WFI	<p>Returns an ASCII waveform identification string giving the key features of the waveform. The information returned is: acquisition source, channel, Volts/Div, input coupling, Sec/Div, acquisition mode, and the number of the curve being sent. In XY mode, the CH2 Volts/Div and input coupling are added. The waveform ID is ignored if received as a command. The form of the return is:</p> <p>WFM WFI: "ACQ, CH1, 0.2 mV, DC, 0.5 mS, AVERAGE, CRV#3";</p> <p>or for XY:</p> <p>WFM WFI: "REF4, XY, 20 mV, DC 50 mV, DC, 0.5 mS, SAMPLE, CRV#1";</p> <p style="text-align: center;">NOTE</p> <p style="text-align: center;"><i>The DATA CHANNEL must be CH1 to get the XY information.</i></p>
WFMpre NR.Pts: <NR1>	<p><NR1> is the number of points in the waveform. Each point can be a single Y value (with time implied), an X-Y pair, or a Max-Min pair. Although the record length is either 1024 data point or 4096 data points, the NR.Pts <NR1> value may be 256, 512, 1024, 2048, or 4096 points. The value depends on the number of channels, the acquisition mode, and whether smoothing is on or off. A table expressing the conditions and the record length to NR.Pts ratio value follows:</p>

Table 8-28
Waveform Preamble Fields (cont)

Commands	Description			
WFMpre NR.Pts: <NR1 > (cont)	NR.Pts to Record Length Ratio	Number of Channels	Acquire Mode	SMOOTH
	Rec/1	1	SAMple	NA
	Rec/1	1	AVErage	NA
	Rec/1	1	PEAkdet	ON
	Rec/1	1	ACCpeak	ON
	Rec/2	2	SAMple	NA
	Rec/2	2	AVErage	NA
	Rec/2	2	PEAkdet	ON
	Rec/2	2	ACCpeak	ON
	Rec/2	1	PEAkdet	OFF
	Rec/2	1	ACCpeak	OFF
	Rec/4	2	PEAkdet	OFF
	Rec/4	2	ACCpeak	OFF
<p>For example, if the number of channels is two and the acquisition is peak detect with smoothing off, the number of points for a waveform in a 4 kbyte record is 4096 divided by 4 (1024 points).</p>				

Table 8-28
Waveform Preamble Fields (cont)

Commands	Description
WFMpre PT.Off: <NR1>	<p><NR1> is the trigger position relative to the first data point in the record. For a 1024 point record, <NR1> for PT.Off ranges from 4 to 1024 in increments of 4. The normal values for a 4096 point record range from 4 to 4096.</p> <p style="text-align: center;">NOTE</p> <p><i><NR1> will be a negative value if the trigger occurred before the first data point in the record window. Since any 1024 point window of a 4096 point record may be transferred, the legal values of <NR1> for PT.Off are -3096 to +4096. If the PT.Off value is unknown, -10000 is the <NR1> value returned.</i></p>
WFMpre PT.Fmt: <Y, XY, or ENV>	<p>Point format defines how to interpret the curve data points.</p> <p>Y format means that X-axis information is derived from the waveform preamble and not sent explicitly. The data values represent the vertical amplitude of the waveform at that data point position.</p> <p>XY format means that the data points are in X-Y pairs, with X first.</p> <p>ENV format means that the vertical data is sent in max-min pairs. The data is sent in the form:</p> <p style="text-align: center;">...,y1max,y1min,y2max,y2min,...</p>

Table 8-28
Waveform Preamble Fields (cont)

Commands	Description
WFMpre PT.Fmt: <Y, XY, or ENV > (cont)	However, the max-min data is displayed in the reverse order, with min data first then max data (...y1min,y1max, y2min,y2max,...). ENV is valid for PEAKdet and ACCpeak acquisition modes with SMOOth OFF.
WFMpre XUNits: <S or CLKS >	Gives the units value for the XINcr. If XUN is S, the X-increment is in seconds; if in CLK, the X-increment is unknown. (CLK is returned when the SEC/DIV setting is EXT CLK.)
WFMpre XINcr: <NR3 >	The XINcr <NR3 > value is the time between data points. If XINcr for a waveform being sent to the oscilloscope does not correspond to a legitimate SEC/DIV setting, the new curve data is not accepted, and a command argument error service request is sent (if RQS is ON). The queried XINcr value of <NR3 > is set equal to 1 (0.1E+0) if it is unknown, as is the case for EXT CLK.
WFMpre YUNits: <V or DIVs >	Indicates the units of YMUIt. when the CAL knob of the DATA CHANNEL is not in the detent position, the DIVs argument is returned.
WFMpre YMUIt: <NR3 >	The YMUIt <NR3 > value is the step size of the digitizer (volts between digitizer levels). If the YMUIt for a waveform being sent to the oscilloscope does not correspond to a legitimate VOLTS/DIV setting, the new curve data is not accepted, and waveform preamble error service request is sent (if RQS is ON). The queried YMUIt value of <NR3 > is 40.0E-3 when the VOLTS/DIV CAL knob for the DATA SOURCE is not in the detent position.

Table 8-28
Waveform Preamble Fields (cont)

Commands	Description
WFMpre YOFF: <NR1>	The YOFF <NR1> value is the Y coordinate of ground. If ground level is not known, the value of -10000 is returned.
WFMpre XMULT XOFF	XMULT and XOFF are similar to YMULT and YOFF. They are added to the waveform preamble for XY waveforms. For all XY waveforms, the YUNITS value is valid for both the X and the Y data points. The value of XUNITS is referenced to the sampling rate.
WFMpre BN.Fmt:RP	RP is the only valid argument. It means that the binary format is always right-justified and consists of positive binary integers (also known as unsigned binary integers).
WFMpre BYT/nr: <NR1>	The valid numbers for <NR1> are 1 and 2. Each data point value is represented by two bytes for AVERAGE mode, only one byte in other modes. If two bytes are sent, the most significant byte is sent first. In HEX format, each data point is represented by two ASCII encoded hex characters.
WFMpre BIT/nr: <NR1>	The data points consist of either 8 or 16 bits. NOTE <i>The least significant bits of a 16-bit waveform may or may not be valid, depending on the number of acquisitions averaged.</i>

Table 8-28
Waveform Preamble Fields (cont)

Commands	Description
WFMpre CRVchk: CHKsm0	The CHKsm0 argument indicates that the last byte of a binary curve is a checksum. The checksum byte is the two's complement of the modulo 265 sum of the binary count and curve data bytes. It does not include the word and symbol CURVE % that comes before the binary count.

Table 8-29
Miscellaneous Commands

Commands	Description
INIt	Command only. The INIt command causes the oscilloscope to revert to the power-on default states for the acquisition modes. The menu system is also initialized.
LONG< [ON] or OFF >	With LONG ON, replies to queries are reported with the full command words. With LONG OFF, replies use the short form of the command words. The short form characters are those that appear in capital letters in these command tables and are the minimum characters accepted as valid for commands. The power-on and default states of LONG are ON. The LONG? query returns its state, ON or OFF.
ID?	Query Only. Returns the oscilloscope identification string in the form: ID TEK/2232,V81.1,VERS:xx; The instrument type and version numbers will be reported as appropriate for the instrument queried.
HElP?	Query Only. Returns a list of all the valid command headers available in the instrument queried. All the valid characters of the commands are returned; the short form of the commands (LONG OFF) are in capital letters.

Table 8-29
Miscellaneous Commands (cont)

Commands	Description
SET?	<p>Returns an ASCII string of headers and arguments reflecting the present states of the controls and modes that may be set via the communications interface. The query-only settings are not returned. The string returned by the SET? query may be sent as a command message to the oscilloscope to recreate those settings. the state of the LONG command affects the length of the reply.</p> <p style="text-align: center;">NOTE</p> <p><i>To comply to Codes and Formats, a header is not sent back with the settings string.</i></p>

Table 8-30
Service Request Group Commands

Commands	Description
OPC <[ON] or OFF >	When ON, the oscilloscope sends a service request upon completion of certain system events (if RQS is also ON). Events that request service when completed with OPC ON include: Acquisition completed, and plot completed. When off, OPC (operation completed) events do not generate a service request. The power-on state of OPC is OFF.
RQS <[ON] or OFF >	When ON, the oscilloscope sends a service request (SRQ) when it has an event to report. When OFF, event codes of different priority still accumulate and may be retrieved with an EVEnt? query, but the reply to STAtus? will be a 0. The power-on and default states of RQS are ON.
EVEnt? <NR1 >	Returns an <NR1 > value that is the code number for oldest service-request event (if multiple events are pending). If no events are pending, <NR1 > is 0. Multiple events of different priority are retrieved by sending EVEnt? until 0 is returned. Querying the event clears the service request.

Table 8-31
RS-232-C Specific Commands

Commands	Description						
FLOW <[ON] or OFF>	<p>Enables (ON) or disables (OFF) DC1/DC3 flow control. FLOW ON is the default and power-on state. Binary data transfers cannot be made with FLOW ON. A FLOW? query returns the present state, ON or OFF.</p> <p>With FLOW ON, the <control-S>, <control-Q>, and <control-D> are recognized during data transfers. Their functions are as follows.</p> <table border="0" data-bbox="987 932 1435 1381"> <tr> <td data-bbox="987 932 1208 1016"><control-S></td> <td data-bbox="1208 932 1435 1016">Temporarily suspend output of characters.</td> </tr> <tr> <td data-bbox="987 1016 1208 1142"><control-Q></td> <td data-bbox="1208 1016 1435 1142">Resume character output that has been temporarily suspended.</td> </tr> <tr> <td data-bbox="987 1142 1208 1381"><control-D></td> <td data-bbox="1208 1142 1435 1381">Abort the command or query execution; erase both input and output buffers; reset the message processor.</td> </tr> </table>	<control-S>	Temporarily suspend output of characters.	<control-Q>	Resume character output that has been temporarily suspended.	<control-D>	Abort the command or query execution; erase both input and output buffers; reset the message processor.
<control-S>	Temporarily suspend output of characters.						
<control-Q>	Resume character output that has been temporarily suspended.						
<control-D>	Abort the command or query execution; erase both input and output buffers; reset the message processor.						
REMote <[ON] or OFF>	<p>Enables (ON) or disables (OFF) setting of remote-controllable oscilloscope states. An execution error service request is sent if a control command is sent with REM OFF.</p> <p>REM? returns the present state, ON or OFF.</p>						

Table 8-31
RS-232-C Specific Commands (cont)

Commands	Description
STOP <1 or 2>	Sets the number of stop bits used in transferring character codes. The usual selection is 1 though some printers require two stop bits at certain baud rate settings. STOP is set to 1 at power on. When connecting to a printer or plotter, select a baud rate that uses only one stop bit. STOP? returns the present setting 1 or 2.
STAtus?	Query Only. Returns the current status of the instrument. If no service requests are pending, the status byte returned indicates No Status to Report. If RQS is off, an EVEnt? query must be used to find out if an event occurred and, if so, which one. The EVEnt? query produces more useful information about an event than the service request status byte.

STATUS BYTES AND EVENT CODES

The various status events and errors that can occur are divided into several categories as defined in Table 8-32. Table 8-33 lists the event codes that are returned as the result of an EVEnt? query.

Option 10

If there is more than one event of different priority levels to be reported, the oscilloscope reasserts SRQ until it reports all events of different priority. It does not issue an SRQ for duplicate events pending or for more than one event of the same priority level. Each event is automatically cleared when its status byte is reported. The

controller option can clear all events by repeatedly sending the `EVEnt?` query until a zero status byte is returned. the Device Clear (DCL) interface message may be used to clear all events, except the power-on event.

With RQS set OFF, all service requests (except the power-on SRQ) are prevented. With the service requests turned off, the `EVEnt?` query must be sent to the oscilloscope so that the controller can determine the oscilloscope and event status. The controller may address the oscilloscope and send the `STAtus?` or `EVEnt?` query at any time. It is not necessary to wait for an SRQ. The instrument will return the status byte code for `STA?` status bytes pending and an event code for `EVE?` for events waiting to be reported (or a 0 for no events to report).

Option 12

If there is more than one event of different priority levels to be reported, the oscilloscope has a status byte and event code available for each one. It does not report duplicate events or more than one event of the same priority level. Each event is automatically cleared when its status byte or event code is reported. The Device Clear (DCL) interface message may be used to clear all events, except the power-on event. Querying `EVEnt?` until the return is `EVE 0` clears all pending status bytes and there is no power-on event.

With RQS set OFF, all service requests are prevented. With the service requests turned off, the `EVEnt?` query must be sent to the oscilloscope so that the controller can determine the oscilloscope and event status. The controller may send the `EVEnt?` query at any time, and the instrument will return the code for an event waiting to be reported (or a 0 for no events to report). The controller can clear all events by repeatedly sending the `EVEnt?` query until a zero status byte is returned.

Table 8-32
Status Event and Error Categories

Category	Status Byte					Description
	Binary ^a	Decimal				
		RQS Off		RQS On		
		Not Busy	Busy	Not Busy	Busy	
Command Error	0R1X 0001	33	49	97	113	The instrument received a command that it cannot understand.
Execution Error	0R1X 0010	34	50	98	114	The instrument received a command that it cannot execute. This is caused by either out-of-range arguments or settings that conflict.
Internal Error	0R1X 0011	35	51	99	115	The instrument detected a hardware condition or a firmware problem that prevents operation.
Power On	010X 0001	1	17	65	81	Instrument power was turned on.
Operation Complete	0R0X 0010	2	18	66	82	Operation complete.
Execution Warning	0R1X 0101	37	53	101	117	The instrument received a command and is executing it, but a potential problem may exist. For example, the instrument is out of range, but sending a reading anyway.
No Status	000X 0000	0	16	0	16	There is no status to report.

^a R is set to 1 if RQS is ON; otherwise 0. The X is the busy bit and is set if the oscilloscope is busy at the time the status byte is read. Anytime the instrument is actively processing a command or query, the bit is a 1, otherwise it is a 0.

Table 8-33
Event Codes

EVENT? Code	Instrument Status
000	No status to report.
Command Errors	
101	Command header error.
102	Header delimiter error.
103	Command argument error.
104	Argument delimiter error.
105	Non-numeric argument, numeric expected.
106	Missing argument.
107	Invalid message-unit delimiter.
108	Checksum error.
109	Byte-count error.
151	The argument is too large.
152	Illegal hex character.
153	Non-binary argument; binary or hex expected.
154	Invalid numeric input.
155	Unrecognized argument type.
Execution Errors	
201	Command cannot be executed when in LOCAL.
203	I/O buffers full, output dumped.
205	Argument out of range, command ignored.
206	Group execute trigger ignored.

Table 8-33
Event Codes (cont)

EVENT? Code	Instrument Status
251	Illegal command.
252	Integer overflow.
253	Input buffer overflow.
254	Invalid waveform preamble.
255	Invalid instrument state.
256	GPIB (Option 10) command not allowed.
257	RS-232-C (Option 12) command not allowed.
259	Command not allowed.
260	Cannot execute command with RQS OFF.
261	Reference memory busy with local (front-panel) command.
262	Reference memory non-existent or specified as different size than selected waveform.
263	Plot active; only PLOT ABORT allowed while plotting.
Internal Errors	
351	Firmware failure. Contact your nearest Tektronix Service Center for assistance.
System Events	
401	Power on.
451	Parity error.
452	Framing error.
453	Carrier lost.
454	End of acquisition OPC.

**Table 8-33
Event Codes (cont)**

EVENT? Code	Instrument Status
455	End of plot OPC.
456	Diagnostics test complete OPC.
Execution Warnings	
551	Single sweep is already armed.
552	No ground-dot measurement available.
553	Invalid probe code or identify.
554	Query not valid for current instrument state.
555	Requested setting is out of detent (uncalibrated).
556	MESsage display buffer is full.
557	Waveform preamble is incorrect, has been corrected.
558	Waveform transfer ended abnormally.

APPENDIX A

**PERFORMANCE CHECK
PROCEDURE**

2232 Operators

Downloaded from www.somanuals.com

INTRODUCTION

PURPOSE

The Performance Check Procedure is used to verify the instrument's Performance Requirements statements listed in Table 7-1 and to determine the need for calibration. The performance checks may also be used as an acceptance test or as a preliminary troubleshooting aid.

PERFORMANCE CHECK INTERVAL

To ensure instrument accuracy, check its performance after every 2000 hours of operation or once each year, if used infrequently. A more frequent interval may be necessary, if the instrument is subjected to harsh environments or severe usage.

STRUCTURE

The Performance Check Procedure is structured in subsections to permit checking individual sections of the instrument, whenever a complete Performance Check is not required. At the beginning of each subsection there is an equipment-required list showing only the test equipment necessary for performing the steps in that subsection.

Also at the beginning of each subsection is a list of all the front-panel control settings required to prepare the instrument for performing Step 1 in that subsection. Each succeeding step within a particular subsection should then be performed, both in the sequence presented and in its entirety, to ensure that control-setting changes will be correct for ensuing steps.

TEST EQUIPMENT REQUIRED

The test equipment listed in Table A-1 is a complete list of the equipment required to accomplish the Performance Check Procedure in

Performance Check Procedure

this section. Test equipment specifications described in Table A-1 are the minimum necessary to provide accurate results. Therefore, equipment used must meet or exceed the listed specifications. Detailed operating instructions for test equipment are not given in this procedure. If more operating information is required, refer to the appropriate test equipment instruction manual.

Table A-1
Test Equipment Required

Item and Description	Minimum Specification	Purpose	Example of Suitable Test Equipment
Calibration Generator	Standard-amplitude signal levels: 5 mV to 50 V. Accuracy $\pm 0.3\%$. High-amplitude signal levels: 1 V to 60 V. Repetition rate: 1 kHz. Fast-rise signal level: 1 V. Repetition rate: 1 MHz. Rise time: 1 ns or less. Flatness: $\pm 2\%$.	Signal source for gain and transient response.	TEKTRONIX PG 506A Calibration Generator. ^a
Leveled Sine-Wave Generator	Frequency: 250 kHz to above 100 MHz. Output amplitude: variable from 10 mV to 5 V p-p. Output impedance: 50 Ω . Reference frequency: 50 kHz. Amplitude accuracy: constant within 3% of reference frequency as output frequency changes.	Vertical, horizontal, and triggering checks and adjustments. Display adjustments and Z-Axis check.	TEKTRONIX SG 503 Leveled Sine-Wave Generator. ^a

^a Requires a TM500-Series Power Module.

Table A-1
Test Equipment Required (cont)

Item and Description	Minimum Specification	Purpose	Example of Suitable Test Equipment
Time-Mark Generator	Marker outputs: 10 ns to 0.5 s. Marker accuracy: $\pm 0.1\%$. Trigger output: 1 ms to 0.1 μ s, time-coincident with markers.	Horizontal checks and adjustments. Display adjustment.	TEKTRONIX TG 501 Time-Mark Generator. ^a
Low-Frequency Generator	Range: 1 kHz to 500 kHz. Output amplitude: 300 mV. Output impedance: 600 Ω . Reference frequency: constant within 0.3 dB of reference frequency as output frequency changes.	Low-frequency trigger checks.	TEKTRONIX SG 502 Oscillator. ^a
Pulse Generator	Repetition rate: 1 kHz. Output amplitude: 5 V.	External clock and storage checks	TEKTRONIX PG 501 Pulse Generator. ^a
Digital Voltmeter	Range: 0 to 140 V. Dc voltage accuracy: $\pm 0.15\%$. 4 1/2 digit display.	Power supply checks and adjustments. Vertical adjustment.	TEKTRONIX DM 501A Digital Multimeter. ^a
Coaxial Cable (2 required)	Impedance: 50 Ω . Length: 42 in. Connectors: BNC	Signal inter-connection.	Tektronix Part Number 012-0057-01.
Dual-Input Coupler	Connectors: BNC female-to-dual-BNC male.	Signal inter-connection.	Tektronix Part Number 067-0525-02.
Precision Coaxial Cable	Impedance: 50 Ω . Length: 42 in. Connectors: BNC	Vertical Bandwidth and aberrations checks.	Tektronix Part Number 012-0482-00.

^a Requires a TM500-Series Power Module.

Performance Check Procedure

Table A-1
Test Equipment Required (cont)

Item and Description	Minimum Specification	Purpose	Example of Suitable Test Equipment
T-Connector	Connectors: BNC	Signal inter-connection.	Tektronix Part Number 103-0030-00.
Termination	Impedance: 50 Ω . Connectors: BNC	Signal termination.	Tektronix Part Number 011-0049-01.
Termination	Impedance: 600 Ω . Connectors: BNC.	Signal Termination	Tektronix Part Number 011-0092-00.
10X Attenuator	Ratio: 10X. Impedance: 50 Ω . Connectors: BNC	Vertical compensation and triggering checks.	Tektronix Part Number 011-0059-02.
Adapter	Connectors: BNC male-to-tip plug.	Signal inter-connection.	Tektronix Part Number 175-1178-00.

When equipment other than that recommended is used, control settings of the test setup may need to be altered. If the exact item of equipment given as an example in Table A-1 is not available, check the Minimum Specification column to determine if any other available test equipment might suffice to perform the check or adjustment.

LIMITS AND TOLERANCES

The tolerances given in this procedure are valid for an instrument that is operating in and has been previously calibrated in an ambient temperature between +20°C and +30°C. The instrument also must have had at least a 20-minute warm-up period. Refer to Table 7-1 for tolerances applicable to an instrument that is operating outside this temperature range. All tolerances specified are for the instrument only and do not include test-equipment error.

PREPARATION FOR CHECKS

It is not necessary to remove the instrument cover to accomplish any subsection in the Performance Check Procedure, since all checks are made using operator-accessible front- and rear-panel controls and connectors.

The most accurate display adjustments are made with a stable, well-focused, low-intensity display. Unless otherwise noted, adjust the A and B INTENSITY, STORAGE/READOUT INTENSITY, FOCUS, and TRIGGER LEVEL controls as needed to view the display.

To ensure performance accuracies stated in the Performance Characteristics (Section 7), for the digital portion of the instrument, select the Factory Reset routine. The Factory Reset routine sets the digital part of the instrument to factory default settings. See Table 3-2 for lists of Storage, Acquisition, and Auto Vectors with respect to the SEC/DIV switch setting and the selected Trigger mode.

To select the Factory Reset routine:

Press the ADV FUNCT SETUP button to display the Advanced Functions setup menu. Press Menu Item Select button and pres the Factory Reset button. Return the instrument to display mode by pressing the ADV FUNCT SETUP button a second time.

INDEX TO PERFORMANCE CHECK STEPS

Vertical	Page
1. Check Deflection Accuracy and Variable Range	A-8
2. Check Store Deflection Accuracy	A-9
3. Check Save Expansion and Compression	A-9
4. Check Position Range	A-11
5. Check Acquisition Position Registration	A-11
6. Check Non-Store Aberrations	A-13
7. Check Store Aberrations	A-14
8. Check Bandwidth	A-15
9. Check Repetitive Store Mode and Bandwidth	A-16

Performance Check Procedure

- 10. Check Single Sweep Sample Acquisition A-17
- 11. Check Bandwidth Limit Operation A-17
- 12. Check Common-Mode Rejection Ratio A-18
- 13. Check Non-Store and Store Channel Isolation A-19
- 14. Check Store Pulse Width Amplitude A-20

Horizontal

- 1. Check Timing Accuracy and Linearity A-23
- 2. Check Store Differential and Cursor Timing
Difference Accuracy A-25
- 3. Check Variable Range and Sweep Separation A-27
- 4. Check Delay Time Differential Accuracy A-28
- 5. Check Delay Jitter A-29
- 6. Check Position Range A-30
- 7. Check Store Expansion Range A-30
- 8. Check 4K to 1K Display Compress A-31
- 9. Check Non-Store Sweep Length A-31
- 10. Check X Gain A-32
- 11. Check X Bandwidth A-32

Trigger

- 1. Check Internal A and B Triggering A-34
- 2. Check HF Reject A Triggering A-36
- 3. Check LF Reject A Triggering A-37
- 4. Check External Triggering A-38
- 5. Check External Trigger Ranges A-38
- 6. Check Single Sweep Operation A-39
- 7. Check Acquisition Window Trigger Points A-40
- 8. Check Trigger Level Readout A-41

External Z-Axis, Probe Adjust, External Clock and XY Plotter

- 1. Check External Z-Axis Operation A-43
- 2. Check Probe Adjust Operation A-43
- 3. Check External Clock A-44
- 4. Check XY Plotter A-45

VERTICAL

Equipment Required (see Table A-1):

Calibration Generator	50-Ω BNC Precision Cable
Leveled Sine-Wave Generator	Dual-Input Coupler
Pulse Generator	50-Ω BNC Termination
50-Ω BNC Cable	10X Attenuator

INITIAL CONTROL SETTINGS

Vertical (Both Channels)

POSITION	Midrange
MODE	CH 1
X-Y	Off (button out)
BW LIMIT	On (button in)
VOLTS/DIV	2 mV
VOLTS/DIV Variable	CAL detent
INVERT	Off (button out)
AC-GND-DC	DC

Horizontal

POSITION	Midrange
MODE	A
A SEC/DIV	0.5 ms
SEC/DIV Variable	CAL detent
X10 Magnifier	Off (knob in)

A TRIGGER

VAR HOLDOFF	NORM
Mode	P-P AUTO
SLOPE	Positive (button out)
LEVEL	Midrange
A & B SOURCE	VERT MODE
A COUPL	NORM

Storage

STORE/NON-STORE	NON-STORE (button out)
-----------------	------------------------

PROCEDURE STEPS

1. Check Deflection Accuracy and Variable Range

- a. Connect the standard-amplitude signal from the calibration generator via a 50- Ω cable to the CH 1 OR X input connector.
- b. CHECK—Deflection accuracy is within the limits given in Table A-2 for each CH 1 VOLTS/DIV switch setting and corresponding standard-amplitude signal. When at the 20-mV VOLTS/DIV switch setting, rotate the CH 1 VOLTS/DIV Variable control fully counterclockwise and CHECK that the display decreases to 2 divisions or less. Then return the CH 1 VOLTS/DIV Variable control to the CAL detent and continue with the 50-mV check.

Table A-2
Deflection Accuracy Limits

VOLTS/DIV Switch Setting	Standard Amplitude Signal	Accuracy Limits (Divisions)
2 mV	10 mV	4.90 to 5.10
5 mV	20 mV	3.92 to 4.08
10 mV	50 mV	4.90 to 5.10
20 mV	0.1 V	4.90 to 5.10
50 mV	0.2 V	3.92 to 4.08
0.1 V	0.5 V	4.90 to 5.10
0.2 V	1 V	4.90 to 5.10
0.5 V	2 V	3.92 to 4.08
1 V	5 V	4.90 to 5.10
2 V	10 V	4.90 to 5.10
5 V	20 V	3.92 to 4.08

- c. Move the cable from the CH 1 OR X input connector to the CH 2 OR Y input connector. Set the Vertical MODE switch to CH 2.
- d. Repeat part b using the Channel 2 controls.

2. Check Store Deflection Accuracy

- a. Set:

CH 2 VOLTS/DIV	2 mV
STORE/NON-STORE	STORE (button in)

- b. Set the calibration generator to produce a 5-division signal.
- c. Use the CURSORS control and SELECT C1/C2 switch (push in the CURSORS controls knob) to set one cursor at the bottom of the square wave and the other cursor at the top of the square wave.
- d. CHECK—Deflection accuracy is within the limits given in Table A-3 for each CH 2 VOLTS/DIV switch setting and corresponding standard-amplitude signal.
- e. Move the cable from the CH 2 OR Y input connector to the CH 1 OR X input connector. Set the Vertical MODE switch to CH 1.
- f. Repeat parts c and d using the Channel 1 controls.

3. Check Save Expansion and Compression

- a. Set the CH 1 VOLTS/DIV switch to 0.1 V.
- b. Set the generator to produce a 0.5 div standard-amplitude signal.
- c. Press in the SAVE/CONT button to select SAVE.
- d. Set the CH 1 VOLTS/DIV switch to 10 mV and reposition the display.
- e. CHECK—The display is expanded to 5 division in amplitude.

Performance Check Procedure

Table A-3
Storage Deflection Accuracy

VOLTS/DIV Switch Setting	Standard Amplitude Signal	Divisions of Deflection	Voltage Readout Limits
2 mV	10 mV	4.90 to 5.10	9.80 to 10.20 mV
5 mV	20 mV	3.92 to 4.08	19.6 to 20.4 mV
10 mV	50 mV	4.90 to 5.10	49.0 to 51.0 mV
20 mV	0.1 V	4.90 to 5.10	98.0 to 102.0 mV
50 mV	0.2 V	3.92 to 4.08	198.0 to 204.0 mV
0.1 V	0.5 V	4.90 to 5.10	0.490 to 0.510 V
0.2 V	1 V	4.90 to 5.10	0.980 to 1.010 V
0.5 V	2 V	3.92 to 4.08	1.960 to 2.040 V
1 V	5 V	4.90 to 5.10	4.90 to 5.10 V
2 V	10 V	4.90 to 5.10	9.80 to 10.20 V
5 V	20 V	3.92 to 4.08	19.60 to 20.40 V

f. Set:

CH 1 VOLTS/DIV 0.1 V
SAVE/CONT CONT

- g. Set the generator to produce a 5 division standard-amplitude signal.
- h. Press in the SAVE/CONT button to select SAVE.
- i. Set the CH 1 VOLTS/DIV switch to 1 V.
- j. CHECK – The display is compressed to 0.5 division in amplitude.
- k. Move the cable from the CH 1 OR X input connector to the CH 2 OR Y input connector.

l. Set:

Vertical MODE	CH 2
SAVE/CONT	CONT

m. Repeat parts a through j.

Page A-11 Replace Step 4 with the following:

4. Check Position Range

a. Set:

VOLTS/DIV (both)	10 mV
AC-GND-DC (both)	AC
STORE/NON-STORE	NON-STORE (button out)

b. Set the generator to produce a 0.2-V standard-amplitude signal.

c. CHECK—The bottom of the waveform can be vertically positioned at least 1 division above the center horizontal graticule line when the Channel 2 POSITION control is rotated fully clockwise, and that the top of the waveform can be vertically positioned 1 division below the center horizontal graticule line when the Channel 2 POSITION control is rotated fully counter-clockwise.

d. Move the cable from the CH 2 OR Y input connector to the CH 1 OR X input connector and set the Vertical MODE switch to CH 1.

e. Repeat part c using the Channel 1 controls.

f. Disconnect the test equipment from the instrument.

VOLTS/DIV variable (both)	-
AC-GND-DC (both)	GND
A SEC/DIV	10 μ s

Performance Check Procedure

- b. Position the trace exactly on the center horizontal graticule line using the Channel 1 POSITION control.
- c. Set:
- | | |
|-----------------|-------------------|
| STORE/NON-STORE | STORE (button in) |
| SAVE/CONT | CONT (button in) |
- d. CHECK—Trace remains within 0.5 division of the center graticule line.
- e. Set:
- | | |
|-----------------|------------------------|
| Vertical MODE | CH 2 |
| STORE/NON-STORE | NON-STORE (button out) |
- f. Repeat parts b through d for Channel 2 trace.
- g. Position the trace 0.5 division below the top horizontal graticule line using the Channel 2 POSITION control.
- h. Press in the SAVE/CONT button to select SAVE.
- i. CHECK—Trace shift of 0.5 division or less.
- j. Press in the SAVE/CONT button to select CONT.
- k. Position the trace 0.5 division above the bottom horizontal graticule line using the Channel 2 POSITION control.
- l. Press in the SAVE/CONT button to select SAVE.
- m. CHECK—Trace shift of 0.5 division or less.
- n. Press in the SAVE/CONT button to select CONT.
- o. Set the Vertical MODE switch to CH 1.
- p. Repeat steps g through m for Channel 1 trace.

6. Check Non-Store Aberrations

a. Set:

BW LIMIT	Off (button out)
VOLTS/DIV (both)	2 mV
AC-GND-DC (both)	DC
A SEC/DIV	0.05 μ s
STORE/NON-STORE	NON-STORE (button out)

- b. Connect the calibration generator fast-rise, positive-going square-wave output via a 50- Ω precision cable, a 10X attenuator, and a 50- Ω termination to the CH 1 OR X input connector.
- c. Set the generator to produce a 1-MHz, 5-division display.
- d. CHECK – Display aberrations are within 4% (0.2 division or less) for the following VOLTS/DIV switch settings: 2 mV through 50 mV. Adjust the generator output and attach or remove the 10X attenuator as necessary to maintain a 5-division display at each VOLTS/DIV switch setting.
- e. CHECK – Display aberrations are within 6% (0.25 division or less) for the following VOLTS/DIV switch settings: 0.1 V and 0.2 V. Adjust the generator output and attach or remove the 10X attenuator as necessary to maintain a 5-division display at each VOLTS/DIV switch setting.
- f. Disconnect the cable from the CH 1 OR X input connector. Reconnect the 10X attenuator (if previously removed) and reduce the generator amplitude to minimum.
- g. Connect the cable to the CH 2 OR Y input connector and set the Vertical MODE switch to CH 2.
- h. Set the generator to produce a 5-division display.
- i. Repeat parts d and e using the Channel 2 controls.

Performance Check Procedure

7. Check Store Aberrations

- a. Reconnect the 10X attenuator and 50- Ω termination (if previously removed) and reduce the generator amplitude to minimum.
- b. Set the CH 2 VOLTS/DIV switch to 2 mV.
- c. Set the generator to produce a 5-division display.
- d. Set:

STORE/NON-STORE	STORE (button in)
SAVE/CONT	CONT
- e. Allow acquisition cycle to complete and then press in the SAVE/CONT button to select SAVE.
- f. CHECK—Display aberrations are within 4% (0.2 division or less) for the following VOLTS/DIV switch settings: 2 mV through 50 mV. Adjust the generator output and attach or remove the 10X attenuator as necessary to maintain a 5-division display at each VOLTS/DIV switch setting.
- g. CHECK—Display aberrations are within 6% (0.25 division or less) for the following VOLTS/DIV switch settings: 0.1 V and 0.2 V. Adjust the generator output and attach or remove the 10X attenuator as necessary to maintain a 5-division display at each VOLTS/DIV switch setting.
- h. Disconnect the cable from the CH 2 OR Y input connector. Reconnect the 10X attenuator (if previously removed) and reduce the generator amplitude to minimum.
- i. Connect the cable to the CH 1 OR X input connector and set the Vertical MODE switch to CH 1.
- j. Set the CH 1 VOLTS/DIV switch to 2 mV.
- k. Set the generator to produce a 5-division display.
- l. Press in the SAVE/CONT button to select CONT.

- m. Repeat parts e through g using the Channel 1 controls.
- n. Disconnect the test equipment from the instrument.

8. Check Bandwidth

- a. Set:

Vertical MODE	CH 2
VOLTS/DIV (both)	2 mV
A SEC/DIV	0.2 ms
STORE/NON-STORE	NON-STORE (button out)

- b. Connect the leveled sine-wave generator output via a 50- Ω precision cable and a 50- Ω termination to the CH 2 OR Y input connector.
- c. Set the generator to produce a 50-kHz, 6-division display.
- d. CHECK—Display amplitude is 4.2 divisions or greater as the generator output frequency is increased up to the value shown in Table A-4 for the corresponding VOLTS/DIV switch setting.
- e. Repeat parts c and d for all indicated CH 2 VOLTS/DIV switch settings, up to the output-voltage upper limit of the sine-wave generator being used.
- f. Move the cable from the CH 2 OR Y input connector to the CH 1 OR X input connector.
- g. Set the Vertical MODE switch to CH 1.
- h. Repeat parts c and d for all indicated CH 1 VOLTS/DIV switch settings, up to the output-voltage upper limit of the sine-wave generator being used.

Performance Check Procedure

Table A-4
Settings for Bandwidth Checks

VOLTS/DIV Switch Setting	Generator Output Frequency
2 mV	80 MHz
5 mV to 5 V	100 MHz

9. Check Repetitive Store Mode and Bandwidth

a. Set:

CH 1 VOLTS/DIV	10 mV
A SEC/DIV	0.2 ms

b. Set the generator to produce a 50-kHz, 6-division display.

c. Set:

A SEC/DIV	0.05 μ s
X10 Magnifier	On (knob out)

d. Set the generator to produce a 100-MHz display.

e. Set:

STORE/NON-STORE	STORE (button in)
SAVE/CONT	CONT

NOTE

Allow the points to accumulate for a few seconds before saving the display.

f. Press in the SAVE/CONT button to select SAVE.

g. CHECK—The 100-MHz display is saved.

- h. CHECK – Display amplitude is 4.2 divisions or greater.
- i. Press in the SAVE/CONT button to select CONT.
- j. Set the Vertical MODE switch to BOTH and ALT.
- k. Repeat parts f through h.

10. Check Single Sweep Sample Acquisition

- a. Set:

Vertical MODE	CH 1
A SEC/DIV	5 μ s
X10 Magnifier	Off (knob in)
A TRIGGER Mode	NORM
A & B SOURCE	CH 1
SAVE/CONT	CONT

- b. Set the generator to produce a 50-kHz, 6-division display.
- c. Press in the A TRIGGER Mode SGL SWP button.
- d. Set the generator output to 2 MHz.
- e. Press in the A TRIGGER Mode SGL SWP button.
- f. CHECK – the minimum peak-to-peak envelope amplitude is greater than 5.6 divisions.

11. Check Bandwidth Limit Operation

- a. Set:

BW LIMIT	On (button in)
VOLTS/DIV (both)	10 mV
AC-GND-DC(both)	DC
A SEC/DIV	20 μ s
A TRIGGER Mode	P-P AUTO
A & B SOURCE	VERT MODE
STORE/NON-STORE	NON-STORE (button out)

Performance Check Procedure

- b. Set the generator to produce a 50-kHz, 6-division display.
- c. Adjust the generator output frequency until the display amplitude decreases to 4.2 divisions.
- d. CHECK—Generator output frequency is between 18 and 22 MHz.
- e. Move the cable from the CH 1 OR X input connector to the CH 2 OR Y input connector.
- f. Set the Vertical MODE switch to CH 2.
- g. Repeat parts c and d.
- h. Disconnect the test equipment from the instrument.

12. Check Common-Mode Rejection Ratio

- a. Set:

BW LIMIT	Off (button out)
INVERT	On (button in)

- b. Connect the leveled sine-wave generator output via a 50- Ω cable, a 50- Ω termination, and a dual-input coupler to the CH 1 OR X and the CH 2 OR Y input connectors.
- c. Set the generator to produce a 50-MHz, 6-division display.
- d. Vertically center the display using the Channel 2 POSITION control. Then set the Vertical MODE switch to CH 1 and vertically center the display using the Channel 1 POSITION control.
- e. Set the Vertical MODE switches to BOTH and ADD.
- f. CHECK—Display amplitude is 0.6 division or less.
- g. If the check in part f meets the requirement, skip to part p. If it does not, continue with part h.
- h. Set the Vertical MODE switch to CH 1.

- i. Set the generator to produce a 50-kHz, 6-division display.
- j. Set the Vertical MODE switch to BOTH.
- k. Adjust the CH 1 or CH 2 VOLTS/DIV Variable control for minimum display amplitude.
- l. Set the Vertical MODE switch to CH 1.
- m. Set the generator to produce a 50-MHz, 6-division display.
- n. Set the Vertical MODE switch to BOTH.
- o. CHECK—Display amplitude is 0.6 division or less.
- p. Disconnect the test equipment from the instrument.

13. Check Non-Store and Store Channel Isolation

- a. Set:

Vertical MODE	CH 1
VOLTS/DIV (both)	0.1 V
VOLTS/DIV Variable (both)	CAL detent
INVERT	Off (button out)
Channel 1 AC-GND-DC	DC
Channel 2 AC-GND-DC	GND
A SEC/DIV	0.1 μ s

- b. Connect the leveled sine-wave generator output via a 50- Ω cable and a 50- Ω termination to the CH 1 OR X input connector.
- c. Set the generator to produce a 50-MHz, 5-division display.
- d. Set the Vertical MODE switch to CH 2.
- e. CHECK—Display amplitude is 0.05 division or less.
- f. Move the cable from the CH 1 OR X input connector to the CH 2 OR Y input connector.

Performance Check Procedure

g. Set:

Vertical MODE	CH 1
Channel 1 AC-GND-DC	GND
Channel 2 AC-GND-DC	DC

h. CHECK—Display amplitude is 0.05 division or less.

i. Set:

CH 2 VOLTS/DIV	50 mV
STORE/NON-STORE	STORE (button in)
SAVE/CONT	CONT

j. CHECK—Display amplitude is 0.1 division or less.

k. Move the cable from the CH 2 OR Y input connector to the CH 1 OR X input connector.

l. Set:

Vertical MODE	CH 2
CH 1 VOLTS/DIV	50 mV
CH 2 VOLTS/DIV	0.1 V
Channel 1 AC-GND-DC	DC
Channel 2 AC-GND-DC	GND

m. CHECK—Display amplitude is 0.1 division or less.

n. Disconnect the test equipment from the instrument.

14. Check Store Pulse Width Amplitude

a. Set:

CH 2 VOLTS/DIV	0.5 V
Channel 2 AC-GND-DC	AC
A SEC/DIV	0.05 μ s
STORE/NON-STORE	NON-STORE (button out)
X10 Magnifier	On (knob out)

b. Connect the pulse generator pulse-period output via a 50- Ω coaxial cable and a 50- Ω termination to the CH 2 OR Y input connector.

Performance Check Procedure

- c. Set the generator to produce a .1-ms period, 10-ns pulse duration, 5-division display.
- d. Set X10 Magnifier off (knob in).
- e. Set pulse generator period to 1 ms.
- f. Set A SEC/DIV to 1 ms.
- g. Set the STORE/NON-STORE switch to STORE (button in).
- h. Adjust Horizontal POSITION control to center trace horizontally.
- i. Press the DISPLAY SETUP button to select the DISPLAY menu. Choose SCAN with the Menu Item Select button. Return to the Standard (non-menu) display by pressing the DISPLAY SETUP button again.
- j. CHECK—The amplitude of the display is 2.5 divisions or greater.
- k. Set the A SEC/DIV 0.1 sec.
- l. CHECK—The amplitude of the display is 2.5 divisions or greater.
- m. Disconnect the test equipment from the instrument.

HORIZONTAL

Equipment Required (see Table A-1):

Calibration Generator	50- Ω BNC Cable
Leveled Sine-Wave Generator	50- Ω BNC Termination
Time-Mark Generator	

INITIAL CONTROL SETTINGS

Vertical

Channel 1 POSITION	Midrange
MODE	CH 1
X-Y	Off (button out)
BW LIMIT	Off (button out)
CH 1 VOLTS/DIV	0.5 V
CH 1 VOLTS/DIV Variable	CAL detent
Channel 1 AC-GND-DC	DC

Horizontal

POSITION	Midrange
MODE	A
A SEC/DIV	0.05 μ s
SEC/DIV Variable	CAL detent
X10 Magnifier	Off (knob in)
B DELAY TIME POSITION	Fully counterclockwise

B TRIGGER

SLOPE	Positive (button out)
LEVEL	Fully clockwise

A TRIGGER

VAR HOLDOFF	NORM
Mode	P-P AUTO
SLOPE	Positive (button out)
LEVEL	Midrange
A & B SOURCE	VERT MODE
A COUPL	NORM

Storage

STORE/NON-STORE	NON-STORE (button out)
-----------------	------------------------

PROCEDURE STEPS

1. Check Timing Accuracy and Linearity

- a. Connect the time-mark generator output via a 50- Ω cable and a 50- Ω termination to the CH 1 OR X input connector.
- b. Select 50-ns time markers from the time-marker generator.
- c. Use the Channel 1 POSITION control to center the display vertically. Adjust the A TRIGGER LEVEL control for a stable, triggered display.
- d. Use the Horizontal POSITION control to align the 2nd time marker with the 2nd vertical graticule line.
- e. CHECK—Timing accuracy is within 2% (0.16 division at the 10th vertical graticule line), and linearity is within 5% (0.1 division over any 2 of the center 8 divisions). For checking the timing accuracy of the A SEC/DIV switch settings from 50 ms to 0.5 s, watch the time marker tips only at the 2nd and 10th vertical graticule lines while adjusting the Horizontal POSITION control.
- f. Repeat parts c through e for the remaining A SEC/DIV and time-mark generator setting combinations shown in Table A-5 under the Normal (X1) column.

Performance Check Procedure

Table A-5
Settings for Timing Accuracy Checks

SEC/DIV Switch Setting	Time-Mark Generator Setting	
	Normal (X1)	X10 Magnified
0.05 μ s	50 ns	10 ns
0.1 μ s	0.1 μ s	10 ns
0.2 μ s	0.2 μ s	20 ns
0.5 μ s	0.5 μ s	50 ns
1 μ s	1 μ s	0.1 μ s
2 μ s	2 μ s	0.2 μ s
5 μ s	5 μ s	0.5 μ s
10 μ s	10 μ s	1 μ s
20 μ s	20 μ s	2 μ s
50 μ s	50 μ s	5 μ s
0.1 ms	0.1 ms	10 μ s
0.2 ms	0.2 ms	20 μ s
0.5 ms	0.5 ms	50 μ s
1 ms	1 ms	0.1 ms
2 ms	2 ms	0.2 ms
5 ms	5 ms	0.5 ms
10 ms	10 ms	1 ms
20 ms	20 ms	2 ms
50 ms	50 ms	5 ms
A Sweep Only		
0.1 s	0.1 s	10 ms
0.2 s	0.2 s	20 ms
0.5 s	0.5 s	50 ms

Performance Check Procedure

g. Set:

A SEC/DIV	0.05 μ s
X10 Magnifier	On (knob out)

h. Select 10-ns time markers from the time-mark generator.

i. Use the Horizontal POSITION control to align the 1st time marker that is 25 ns beyond the start of the sweep with the 2nd vertical graticule line.

j. CHECK—Timing accuracy is within 3% (0.24 division at the 10th vertical graticule line), and linearity is within 5% (0.1 division over any 2 of the center 8 divisions). Exclude any portion of the sweep past the 100th magnified division.

k. Repeat parts i and j for the remaining A SEC/DIV and time-mark generator setting combinations shown in Table A-5 under the X10 Magnified column.

l. Set:

Horizontal MODE	B
A SEC/DIV	0.1 μ s
B SEC/DIV	0.05 μ s
X10 Magnifier	Off (knob in)

m. Repeat parts b through k for the B Sweep. Keep the A SEC/DIV switch one setting slower than the B SEC/DIV switch.

2. Check Store Differential and Cursor Time Difference Accuracy

a. Set:

Channel 1 AC-GND-DC	GND
Horizontal MODE	A
A SEC/DIV	0.1 ms
X10 Magnifier	Off (knob in)
STORE/NON-STORE	STORE (button in)

Performance Check Procedure

- b. Use the Channel 1 POSITION control to center the base line vertically and the Horizontal POSITION control to align the start of the trace with the 1st vertical graticule line.
- c. Use the CURSORS control and SELECT C1/C2 (push in the CURSORS control knob) switch to set one cursor exactly on the 2nd vertical graticule line and position the active cursor to the right using the CURSORS control until ΔT readout displays 0.800 ms.
- d. CHECK— Graticule indication of cursor difference at the 10th vertical graticule line is within 0.16 division.
- e. Set the Channel 1 AC–GND–DC switch to DC.
- f. Select 0.1–ms time markers from the time–mark generator.
- g. Align the 2nd time marker with the 2nd vertical graticule line using the Horizontal POSITION control.
- h. Press in the SAVE/CONT button to select SAVE for a stable display.
- i. Use the CURSORS control and SELECT C1/C2 (push in the CURSORS control knob) switch to set the first cursor on the trailing edge of the 2nd time marker.
- j. Press in the CURSORS control knob again to activate the second cursor.
- k. Set the second cursor on the trailing edge of the 10th time marker at the same voltage level as on the 2nd time marker.
- l. CHECK— The ΔT readout is between 0.798 ms and 0.802 ms.
- m. Press in the SAVE/CONT button to select CONT.
- n. Set the A SEC/DIV switch to 0.5 μ s.
- o. Select 0.5– μ s time markers from the time–mark generator.
- p. Align the 2nd time marker with the 2nd vertical graticule line using the Horizontal POSITION control.

NOTE

Allow the points to accumulate for a few seconds before saving the display.

- q. Repeat parts h through k.

NOTE

Pulses with fast rise and fall times have only a few sample points and it may not be possible to place the cursors at exactly the same voltage levels.

- r. CHECK—The ΔT readout is between 3.75 μs and 4.03 μs .

3. Check Variable Range and Sweep Separation

- a. Set:

A and B SEC/DIV	0.2 ms
SEC/DIV Variable	Fully counterclockwise
STORE/NON-STORE	NON-STORE (button out)

- b. Select 0.5-ms time markers from the time-mark generator.

- c. CHECK—Time markers are 1 division or less apart.

- d. Set:

Channel 1 AC-GND-DC	GND
SEC/DIV Variable	CAL detent
Horizontal MODE	BOTH

- e. Use the Channel 1 POSITION control to set the A Sweep at the center horizontal graticule line.

- f. CHECK—The B Sweep can be positioned more than 3.5 divisions above and below the A Sweep when the A/B SWP SEP control is rotated fully clockwise and counterclockwise respectively.

Performance Check Procedure

4. Check Delay Time Differential Accuracy

- a. Use the Horizontal POSITION control to align the start of the A Sweep with the 1st vertical graticule line.
- b. Set the B DELAY TIME POSITION control fully counterclockwise.
- c. CHECK—Intensified portion of the trace starts within 0.5 division of the start of the sweep.
- d. Rotate the B DELAY TIME POSITION control fully clockwise.
- e. CHECK—Intensified portion of the trace is past the 11th vertical graticule line.
- f. Set the A and B SEC/DIV switch to 0.5 μ s.
- g. Repeat parts a through e.
- h. Set:

Channel 1 AC-GND-DC	DC
B SEC/DIV	0.05
B DELAY TIME POSITION	Fully counterclockwise

- i. Select 0.5- μ s time markers from the time-mark generator.
- j. Rotate the B DELAY TIME POSITION control so that the top of the 2nd time marker on the B Sweep is aligned with a selected reference vertical line. Record the DLY= readout for part i.
- k. Rotate the B DELAY TIME POSITION control fully clockwise until the top of the 10th time marker on the B Sweep is aligned with the same selected reference vertical line as in part j. Record the DLY= readout for part i.
- l. CHECK—Delay time readout is within the limits given in Table A-6 (Delay Readout Limits column) by subtracting the delay time reading in part j from part k.
- m. Repeat parts j through l for the remaining B SEC/DIV and time-mark generator settings given in Table A-6, check the 8-division delay time accuracy for each A SEC/DIV switch setting given in column 1 of the table.

Table A-6
Settings for Delay Time Differential Checks

Time-Mark Generator and A SEC/DIV Settings	B SEC/DIV Setting	Eight Division Delay	Delay Readout Limits
0.5 μ s	0.05 μ s	4.000 μ s	3.948 μ s to 4.052 μ s
5 μ s	0.5 μ s	40.00 μ s	39.48 μ s to 40.52 μ s
50 μ s	5 μ s	400.0 μ s	394.8 μ s to 405.2 μ s
0.5 ms	50 μ s	4.000 ms	3.948 ms to 4.052 ms
5 ms	0.5 ms	40.00 ms	39.48 ms to 40.52 ms
50 ms	5 ms	400.0 ms	394.8 ms to 405.2 ms
0.5 s	50 ms	4.000 s	3.948 s to 4.052 s

5. Check Delay Jitter

a. Set:

A SEC/DIV	0.5 ms
B SEC/DIV	0.5 μ s

- b. Select 0.5-ms time markers from the time-mark generator.
- c. Rotate the B DELAY TIME POSITION control to position the intensified zone on the ninth time marker.
- d. Set the Horizontal MODE switch to B.
- e. CHECK—The jitter on the leading edge of the time marker does not exceed 1 division. Disregard slow drift.

Performance Check Procedure

6. Check Position Range

a. Set:

Horizontal MODE	A
A SEC/DIV	10 μ s

- b. Select 10- μ s time markers from the time-mark generator.
- c. CHECK— Start of the sweep can be positioned to the right of the center vertical graticule line by rotating the Horizontal POSITION control fully clockwise.
- d. CHECK— The 11th time marker can be positioned to the left of the center vertical graticule line by rotating the Horizontal POSITION control fully counterclockwise.
- e. Select 50- μ s time markers from the time-mark generator.
- f. Align the 3rd time marker with the center vertical graticule line using the Horizontal POSITION control.
- g. Set the X10 Magnifier knob to On (knob out).
- h. CHECK— Magnified time marker can be positioned to the left of the center vertical graticule line by rotating the Horizontal POSITION control fully counterclockwise.
- i. CHECK— Start of the sweep can be positioned to the right of the center vertical graticule line by rotating the Horizontal POSITION control fully clockwise.

7. Check Store Expansion Range

a. Set:

A SEC/DIV	0.1 ms
X10 Magnifier	Off (knob in)

- b. Select 10- μ s time markers from the time-mark generator.
- c. Use the Horizontal POSITION control to align the start of the A Sweep with the 1st vertical graticule line.

- d. Set the STORE/NON-STORE switch to STORE (button in).
- e. Set the X10 Magnifier knob to On (knob out).
- f. CHECK—The time markers are 1 division apart.

8. Check 4K to 1K Display Compress

- a. Set:

A SEC/DIV	50 μ s
X10 Magnifier	Off (knob in)
1K/4K	4K

- b. Select 0.1-ms time markers from the time-mark generator and check that the time markers are 2 divisions apart.
- c. Rotate the SEC/DIV Variable control out of detent.
- d. CHECK—For 2 time markers per division over the center 8 divisions.

9. Check Non-Store Sweep Length

- a. Set:

SEC/DIV Variable	CAL detent
STORE/NON-STORE	NON-STORE (button out).

- b. Use the Horizontal POSITION control to align the start of the A Sweep with the 1st vertical graticule line.
- c. CHECK—End of the sweep is to the right of the 11th vertical graticule line.
- d. Disconnect the test equipment from the instrument.

Performance Check Procedure

10. Check X Gain

a. Set:

X-Y	On (button in)
CH 1 VOLTS/DIV	10 mV
Horizontal POSITION	Midrange

- b. Connect the standard-amplitude signal from the Calibration Generator via a 50- Ω cable to the CH 1 OR X input connector.
- c. Set the generator to produce a 50-mV signal.
- d. Use the Channel 2 POSITION and Horizontal POSITION controls to center the display.
- e. CHECK—Display is 4.85 to 5.15 horizontal divisions.
- f. Disconnect the test equipment from the instrument.

11. Check X Bandwidth

- a. Connect the leveled sine-wave generator output via a 50- Ω cable and a 50- Ω termination to the CH 1 OR X input connector.
- b. Set the generator to produce a 5-division horizontal display at an output frequency of 50 kHz.
- c. Increase the generator output frequency to 3 MHz.
- d. CHECK—Display is at least 3.5 horizontal divisions.
- e. Disconnect the test equipment from the instrument.

TRIGGER

Equipment Required (see Table A-1):

Calibration Generator	Dual-Input Coupler
Leveled Sine-Wave Generator	50-Ω BNC Termination
Low Frequency Generator	600-Ω BNC Termination
50-Ω BNC Cable	

INITIAL CONTROL SETTINGS

Vertical

POSITION (both)	Midrange
MODE	CH 1
X-Y	Off (button out)
BW LIMIT	Off (button out)
CH 1 VOLTS/DIV	5 mV
CH 2 VOLTS/DIV	50 mV
VOLTS/DIV Variable (both)	CAL detent
INVERT	Off (button out)
AC-GND-DC (both)	DC

Horizontal

POSITION	Midrange
MODE	A
A and B SEC/DIV	0.2 μs
SEC/DIV Variable	CAL detent
X10 Magnifier	Off (knob in)
B DELAY TIME POSITION	Fully counterclockwise

B TRIGGER

SLOPE	Positive (button out)
LEVEL	Midrange

Performance Check Procedure

A TRIGGER

VAR HOLDOFF	NORM
Mode	P-P AUTO
SLOPE	Positive (button out)
LEVEL	Midrange
A & B SOURCE	CH 1
A COUPL	NORM
A EXT COUPL	DC

Storage

STORE/NON-STORE	NON-STORE (button out)
-----------------	------------------------

PROCEDURE STEPS

1. Check Internal A and B Triggering
 - a. Connect the leveled sine-wave generator output via a 50- Ω cable and a 50- Ω termination to the CH 1 OR X input connector.
 - b. Set the generator to produce a 10-MHz, 3.5-division display.
 - c. Set the CH 1 VOLTS/DIV switch to 50 mV.
 - d. CHECK—Stable display can be obtained by adjusting the A TRIGGER LEVEL control for each switch combination given in Table A-7.

Table A-7
Switch Combinations for A Triggering Checks

A TRIGGER Mode	A TRIGGER SLOPE
NORM	Positive
NORM	Negative
P-P AUTO	Negative
P-P AUTO	Positive

Performance Check Procedure

- e. Set the Horizontal MODE switch to B.
- f. CHECK—Stable display can be obtained by adjusting the B TRIGGER LEVEL control in a position other than the B RUNS AFTER DLY position for both the Positive and Negative positions of the B TRIGGER SLOPE switch.
- g. Set:
- | | |
|-----------------|------|
| Vertical MODE | CH 2 |
| Horizontal MODE | A |
| A & B SOURCE | CH 2 |
- h. Move the cable from the CH 1 OR X input connector to the CH 2 OR Y input connector.
- i. Repeat parts d through f.
- j. Set:
- | | |
|-----------------|---------------|
| Horizontal MODE | A |
| A SEC/DIV | 0.1 μ s |
| X10 Magnifier | On (knob out) |
- k. Set the generator to produce a 60-MHz, 1.0-division display.
- l. Repeat parts d through f.
- m. Set:
- | | |
|-----------------|------|
| Vertical MODE | CH 1 |
| Horizontal MODE | A |
| A & B SOURCE | CH 1 |
- n. Move the cable from the CH 2 OR Y input connector to the CH 1 OR X input connector.
- o. Repeat parts d through f.
- p. Set:
- | | |
|-----------------|--------------|
| Horizontal MODE | A |
| A SEC/DIV | 0.05 μ s |

Performance Check Procedure

- q. Set the generator to produce a 100-MHz, 1.5-division display.
- r. Repeat parts d through f.
- s. Set:

Vertical MODE	CH 2
Horizontal MODE	A
A & B SOURCE	CH 2
- t. Move the cable from the CH 1 OR X input connector to the CH 2 OR Y input connector.
- u. Repeat parts d through f.
- v. Disconnect the test equipment from the instrument.

2. Check HF Reject A Triggering

- a. Set:

Vertical MODE	CH 1
VOLTS/DIV (both)	50 mV
Horizontal MODE	A
A SEC/DIV	5 μ s
X10 Magnifier	Off (knob in)
A TRIGGER Mode	NORM
A TRIGGER LEVEL	Midrange
A & B SOURCE	CH 1
- b. Connect the low frequency generator output via a 50- Ω cable and a 600- Ω termination to the CH 1 OR X input connector.
- c. Set the low frequency generator output to produce a 250-kHz, 1-division display.
- d. Adjust the A TRIGGER LEVEL control for a stable display.
- e. Set the A COUPL switch to HF REJ position.
- f. CHECK—Stable display cannot be obtained by adjusting the A TRIGGER LEVEL control for each switch combination given in Table A-7.

g. Set:

Vertical MODE	CH 2
A & B SOURCE	CH 2

h. Move the cable from the CH 1 OR X input connector to the CH 2 OR Y input connector.

i. Repeat part f.

3. Check LF Reject A Triggering

a. Set:

A TRIGGER LEVEL	Midrange
A COUPL	LF REJ

b. Set the generator to produce a 25-kHz, 0.35-division display.

c. CHECK—The display cannot be obtained by adjusting the A TRIGGER LEVEL control.

d. Set the generator to produce a 55-kHz, 0.35-division display.

e. CHECK—Stable display can be obtained by adjusting the A TRIGGER LEVEL control.

f. Set:

Vertical MODE	CH 1
A & B SOURCE	CH 1

g. Move the cable from the CH 2 OR Y input connector to the CH 1 OR X input connector.

h. Repeat parts b through e.

i. Disconnect the test equipment from the instrument.

Performance Check Procedure

4. Check External Triggering

a. Set:

CH 1 VOLTS/DIV	5 mV
A SEC/DIV	0.1 μ s
A & B SOURCE	A EXT
A COUPL	NORM

b. Connect the leveled sine-wave generator output via a 50- Ω cable, a 50- Ω termination, and a dual-input coupler to both the CH 1 OR X and EXT INPUT connectors.

c. Set the leveled sine-wave generator output voltage to 40 mV and the frequency to 10 MHz.

d. CHECK—Stable display can be obtained by adjusting the A TRIGGER LEVEL control for each switch combination given in Table A-7.

e. Set:

CH 1 VOLTS/DIV	50 mV
X10 Magnifier	On (knob out)

f. Set the generator output voltage to 120 mV and the frequency to 60 MHz.

g. Repeat part d.

h. Set the generator output voltage to 150 mV and the frequency to 100 MHz.

i. Repeat part d.

5. Check External Trigger Ranges

a. Set:

CH 1 VOLTS/DIV	0.5 V
A SEC/DIV	20 μ s
X10 Magnifier	Off (knob in)
A TRIGGER SLOPE	Positive (button out)
A TRIGGER Mode	NORM

Performance Check Procedure

- b. Set the generator to produce a 50-kHz, 6.4-division display.
- c. CHECK—Display is triggered along the entire positive slope of the waveform as the A TRIGGER LEVEL control is rotated.
- d. CHECK—Display is not triggered (no trace) at either extreme of rotation.
- e. Set the A TRIGGER SLOPE button to Negative (button in).
- f. CHECK—Display is triggered along the entire negative slope of the waveform as the A TRIGGER LEVEL control is rotated.
- g. CHECK—Display is not triggered (no trace) at either extreme of rotation.

6. Check Single Sweep Operation

- a. Adjust the A TRIGGER LEVEL control to obtain a stable display.
- b. Set:

Channel 1 AC-GND-DC	GND
A & B SOURCE	CH 1
A COUPL	NORM
A SEC/DIV	20 ms
- c. Press in the SGL SWP button. The READY LED should illuminate and remain on.
- d. Set the Channel 1 AC-GND-DC switch to DC.

NOTE

The A INTENSITY control may require adjustment to observe the single-sweep trace.

- e. CHECK—READY LED goes out and a single sweep occurs.
- f. Press in the SGL SWP button several times.

Performance Check Procedure

- g. CHECK—Single-sweep trace occurs, and the READY LED illuminates briefly every time the SGL SWP button is pressed in and released.
- h. Disconnect the test equipment from the instrument.

7. Check Acquisition Window Trigger Points

- a. Set:

Channel 1 AC-GND-DC	GND
A TRIGGER Mode	P-P AUTO
A SEC/DIV	0.1 μ s
STORE/NON-STORE	STORE (button in)
1K/4K	1K

- b. Use the Horizontal POSITION control to align the start of the display acquisition with the 1st vertical graticule line.
- c. Press in the TRIG POS button until the store trigger point (T) is located on the left side of the screen.
- d. CHECK—The POST TRIG point (T) is 1.28 divisions from the start of the display acquisition.
- e. Press the TRIG POS button a second time to position the trigger point to the middle of the display acquisition.
- f. CHECK—The MIDTRIG point (T) is 5.12 divisions from the start of the display acquisition.
- g. Press the TRIG POS button a third time to position the trigger point to the right of the display acquisition.
- h. CHECK—The PRETRIG point (T) is 8.96 divisions from the start of the display acquisition.

8. Check Trigger Level Readout

a. Set:

Vertical MODE	CH 2
Channel 2 VOLTS/DIV	20 mV
INVERT	Off (button out)
Channel 2 AC-GND-DC	DC
A SEC/DIV	0.5 ms
A TRIGGER Mode	NORM
A TRIGGER LEVEL	Midrange
A & B SOURCE	VERT MODE
STORE/NON-STORE	NON-STORE (button out)

- b. Connect the standard-amplitude signal from the Calibration Generator via a 50- Ω cable to the CH 2 OR Y input connector.
- c. Set the generator to produce a 5 division standard-amplitude signal.
- d. Adjust the A Trigger LEVEL control for a stable display and center the waveform on the screen.
- e. Set the Channel 2 VOLTS/DIV switch to 10 mV for a 10-division display.
- f. Rotate the A Trigger LEVEL control clockwise until the triggering becomes unstable.
- g. CHECK – The trigger readout is between 96 mV and 104 mV.
- h. Press in the INVERT button to invert the Channel 2 waveform.
- i. Repeat part e for a stable display.
- j. Rotate the A Trigger LEVEL control counterclockwise until the triggering becomes unstable.
- k. CHECK – The trigger readout is between -96 mV and -104 mV.
- l. Disconnect the test equipment from the instrument.

EXTERNAL Z-AXIS, PROBE ADJUST, EXTERNAL CLOCK, AND X-Y PLOTTER

Equipment Required (see Table A-1):

Leveled Sine-Wave Generator	BNC T-Connector
Pulse Generator	50- Ω BNC Termination
Digital Voltmeter	BNC male-to-tip plug
Two 50- Ω BNC Cable	10X Probe (provided with instrument)

INITIAL CONTROL SETTINGS

Vertical

Channel 1 POSITION	Midrange
MODE	CH 1
X-Y	Off (button out)
BW LIMIT	Off (button out)
CH 1 VOLTS/DIV	1 V
CH 1 VOLTS/DIV Variable	CAL detent
Channel 1 AC-GND-DC	DC

Horizontal

POSITION	Midrange
MODE	A
A SEC/DIV	20 μ s
SEC/DIV Variable	CAL detent
X10 Magnifier	Off (knob in)

A TRIGGER

VAR HOLDOFF	NORM
Mode	P-P AUTO
SLOPE	OUT
LEVEL	Midrange
A & B SOURCE	VERT MODE
A COUPL	NORM

Storage

STORE/NON-STORE	NON-STORE (button out)
-----------------	------------------------

PROCEDURE STEPS

1. Check External Z-Axis Operation

- a. Connect the leveled sine-wave generator output via a 50- Ω cable and a T-connector to the CH 1 OR X input connector. Then connect a 50- Ω cable and a 50- Ω termination from the T-connector to the EXT Z-AXIS INPUT connector on the rear panel.
- b. Set the generator to produce a 5-V, 50-kHz signal.
- c. CHECK – For noticeable intensity modulation. The positive part of the sine wave should be of lower intensity than the negative part.
- d. Disconnect the test equipment from the instrument.

2. Check Probe Adjust Operation

- a. Set:

CH 1 VOLTS/DIV	10 mV
A SEC/DIV	0.5 ms

Performance Check Procedure

- b. Connect the 10X Probe to the CH 1 OR X input connector and insert the probe tip into the PROBE ADJUST jack on the instrument front panel. If necessary, adjust the probe compensation for a flat-topped square-wave display.
- c. CHECK—Display amplitude is 4.75 to 5.25 divisions.
- d. Disconnect the probe from the instrument.

3. Check External Clock

- a. Set:

CH 1 VOLTS/DIV	1 V
A SEC/DIV	1 ms

- b. Connect the Pulse Generator high amplitude output via a 50- Ω cable and a 50- Ω termination to CH 1 OR X input connector.
- c. Set the generator to produce a 10- μ s, 5- μ s duration, 5-division display.
- d. Disconnect the cable from the CH 1 OR X input connector and connect it to the BNC male-to-tip plug via BNC female to BNC female connector.
- e. Insert the BNC male-to-tip plug signal lead and ground lead into pin 1 and pin 9 respectively of the XY Plotter connector.
- f. Set the A SEC/DIV switch to 0.1 sec.
- g. Connect the Calibration Generator high amplitude output via a 50- Ω cable and a 50- Ω termination to CH 1 OR X input connector.
- h. Set the generator to produce a 100-Hz, 5-division display.
- i. Set:

A SEC/DIV	EXT CLK
STORE/NON-STORE	STORE (button in)

- j. Press in the SETUP ACQ button to display the ACQUISITION menu and select Fast with the Ext Clock button. Return the instrument to display mode by pressing the SETUP ACQ button a second time.
- k. CHECK—The 100-Hz signal is displayed on the screen and updated.
- l. Press in the SAVE/CONT button to select SAVE.
- m. CHECK—The display is saved.
- n. Press in the SAVE/CONT button to select CONT.
- o. Disconnect the test equipment from the instrument.

4. Check XY Plotter

- a. Set the A SEC/DIV switch to 10 ms.
- b. Connect the digital voltmeter low lead to either chassis ground or pin 9 (signal ground) of the XY Plotter connector. Connect the volts lead to pin 3 (X Output) of the XY Plotter connector.
- c. Set the digital voltmeter to the 20 V scale.
- d. Press the SETUP PLOT button to display the PLOT menu. Set Plotter Type to XY, Gratic to ON, Auto Plot to OFF, and Plot Speed to 10.
- e. Press Start button to activate the XY Plotter.

NOTE

Voltage reading of the X Output will be negative left of the center vertical graticule line and positive to the right of the center vertical graticule line. Voltage reading of the Y output will be negative below the center horizontal graticule line and positive above the center horizontal graticule line.

- f. Record the voltage reading as the instrument plots the 1st and the 10th graticule line (as the intensity spot moves along the graticule line).

Performance Check Procedure

- g. CHECK—The voltage difference between the 1st and 10th graticule line is between 4.5 V and 5.5 V.
- h. Move the volts lead of the voltmeter from pin 3 (X Output) to pin 5 (Y Output) to the XY Plotter connector.
- i. Press in again the Start button to activate the XY Plotter.
- j. Record the voltage reading as the instrument plots the top and the bottom of the graticule lines (as the intensity spot moves along the graticule line).
- k. CHECK—The voltage difference between the top and bottom graticule line is between 3.6 V and 4.4 V.
- l. Disconnect the test equipment from the instrument.

APPENDIX B

**COMMUNICATION
OPTIONS
SUPPLEMENTAL
INFORMATION**

2232 Operators

INTRODUCTION

This appendix supplies additional information about connecting and using the RS-232-C Communications Option. The Printer/Plotter switch settings for some tested formats and plotter types are shown for both RS-232-C and GPIB options. Questions and answers about the RS-232-C and GPIB options are included in the back of this appendix.

RS-232-C DEVICE INTERCONNECTION

RS-232-C STANDARD

The RS-232-C standard defines the interconnection between two types of devices. They are Data Terminal Equipment (DTE) and Data Communications Equipment (DCE). A DTE device that conforms to the standard has a male RC-232-C connector. Examples are terminals, computers, and printers. Generally, the DTE device is the source of the data, but this is not always the case. A DCE device that conforms to the standard has a female RS-232-C connector. An example of a DCE device is a modem.

DETERMINING DEVICE TYPE

When interconnecting your instrument to other RS-232-C devices you must determine the device type and the connector type. From that information, the interconnection cable you need can be determined.

You cannot reliably determine if a device is DTE or DCE by simply looking at the RS-232-C connector. You must verify the device type from its operator or service manual.

1. To which logical type of device are you connecting?

From the equipment manual, find out if the device is DTE or DCE.

2. Which physical type of connector does the device have?

Male is standard for a DTE connector.

Female is standard for a DCE connector.

If you have a DTE device with a male connector or a DCE device with a female connector, you may use a standard RS-232-C straight through interconnection cable. If the connections are not standard, read the Interconnection Rules. Then read the Interconnection Cable-Type Identification information to find the interconnection cable type you will need for your application.

INTERCONNECTION RULES

There are several simple rules that satisfy most RS-232-C interconnections requirements.

1. A standard RS-232-C cable connects a DTE device to a DCE device. Both devices must adhere to the electrical and mechanical specifications of the RS-232-C standard. The standard cable has a female connector on one end and a male connector on the other end. The Transmit and Receive conductors are not interchanged. The standard RS-232-C cable is sometimes referred to as a straight through cable. In Table B-1, the Cable-Type Identification table, the straight-through cable is referred to as Type A.
2. A Null Modem cable or device may be used to interconnect two DTE or two DCE devices. Generally the cable is custom made with RS-232-C connectors that match the devices to be interconnected. A null modem cable permits two devices of the same type (DCE to DCE and DTE to DTE) to communicate as if they were connected DTE to DCE. The Transmit and Receive lines and the associated handshake line are swapped in the null modem to satisfy the requirements for data transfer between the two devices. See Figure B-1 for the Null Modem cable wiring schematic.

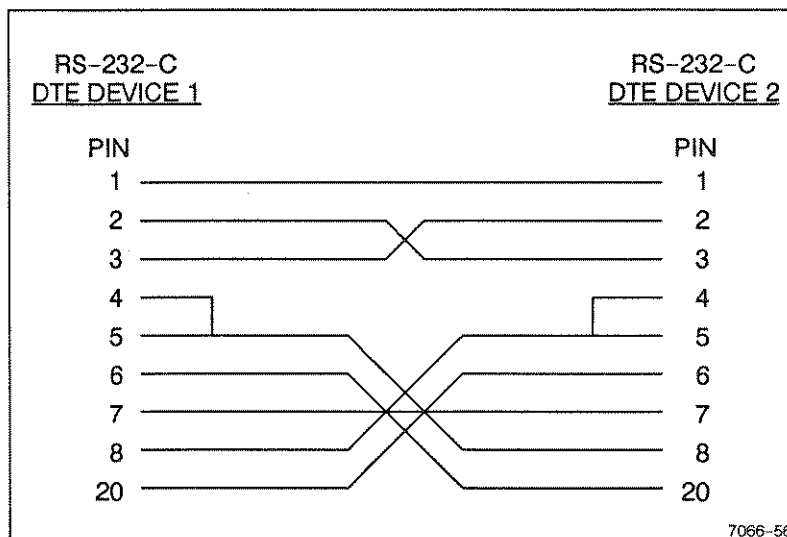

Figure B-1. Null Modem cable wiring (non-handshaking).

3. A Gender Changer has straight-through connections that may be used to convert a non-standard port connector (a DTE device with a female connector or a DCE device with a male connector) for connection with a standard RS-232-C cable. Gender changers come as male-to-male and female-to-female. The male-to-male changer is the most used.

The gender changer is connected between the non-conforming device and the appropriate end of a standard RS-232-C cable. Situations may occur when neither device has conforming connectors; in that case, use gender changers on both devices to permit interconnection with a standard RS-232-C cable (or use one of the specified cables from Table B-1).

4. If non-standard cabling or connectors are used, an interconnection terminal box may be needed to provide user-customized hookups.

The instrument has both a DTE port and a DCE port to make it easy to connect to either a DTE or a DCE device using a standard RS-232-C

cable. Both connectors conform to the electrical and mechanical specifications of the RS-232-C. Therefore, in most cases, you should not have to modify the instrument end of an interconnection cable to hook up other devices with the oscilloscope.

INTERCONNECTION CABLE-TYPE IDENTIFICATION

The cable-type designations found in Table B-1 correspond to the interconnection illustrations following the table. The most used interconnections seen with different RS-232-C printers are covered. In the table, the information in column 1 (Type of Interconnection) is interpreted as follows: DTE/male to DCE/female means a DTE type device with a male RS-232-C connector connected to a DCE type device that has a female RS-232-C connector (a standard RS-232-C male-to-female interconnection).

RS-232-C INTERCONNECTION CABLE-TYPE ILLUSTRATIONS

The cable-wiring illustrations of B-2 through B-9 correspond to the Cable-Type designations of Table B-1. They are divided into the straight-through (Type A) interconnections and the null-modem (Type B) interconnections. Both the straight-through and the null-modem interconnections will also require gender changers when making male-to-male or female-to-female equipment hookups. In summary, the basic cable types are:

1. Standard or straight through cables with a male connector on one end and a female connector on the other.
2. Null modem cables that may be customized to make the necessary connector matings. These come as male-to-female, female-to-female, and male-to-male.
3. Gender changers are straight-through cables with either male connectors or female connectors on both ends.

**Table B-1
Cable-Type Identification**

Type of Interconnection	Cable-Type Designator	Application
Straight-Through Cables		
DTE/male to DCE/female DTE/female to DCE/male	A	Use a straight through cable terminated on one end with a male connector and on the other end with a female connector. This is the "standard" cable connection in our discussion.
DTE/female to DCE/female	A1	Use a male-to-male gender changer and a standard cable.
DTE/male to DCE/male	A2	Use a female-to-female gender changer and a standard cable.
Null-Modem Cables		
DTE/male to DTE/male DCE/male to DCE/male	B	Use a null modem cable terminated with female connectors. This is the "standard null modem" in our discussion.
DTE/female to DTE/male DCE/male to DCE/female	B1	Use a standard null modem with a male-to-male gender changer or use a male-to-female null modem.
DTE/female to DTE/female DCE/female to DCE/female	B2	Use two male-to-male gender changers and a standard null modem cable or use a male-to-male null modem.

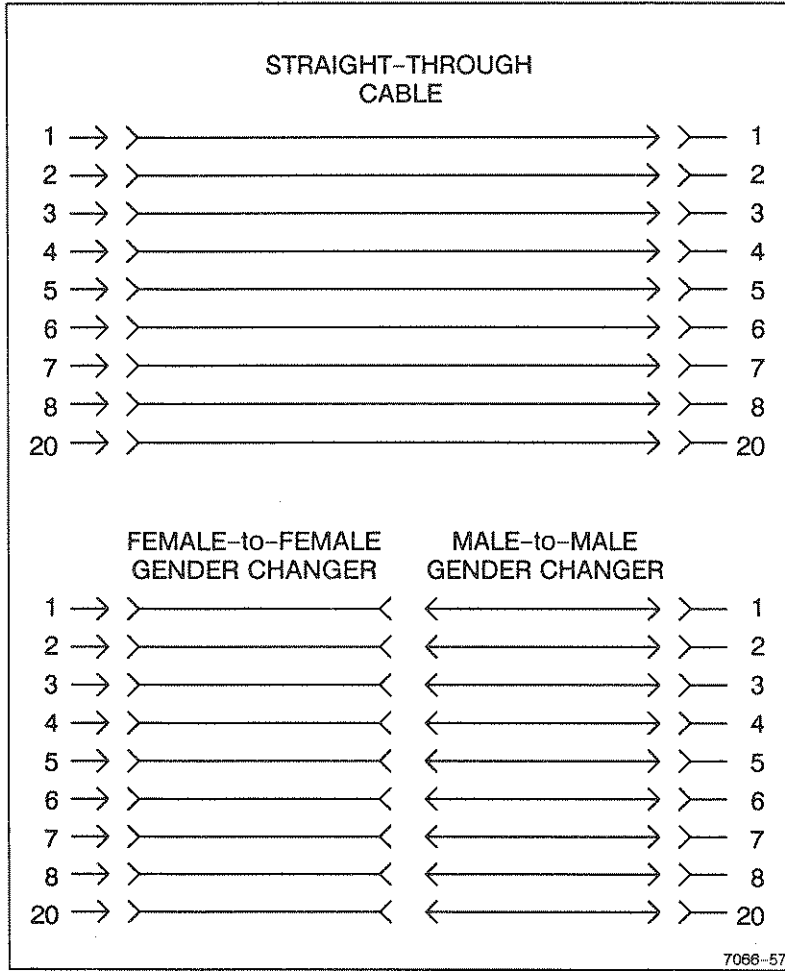

Figure B-2. Type A Connections – DTE male to DCE female.

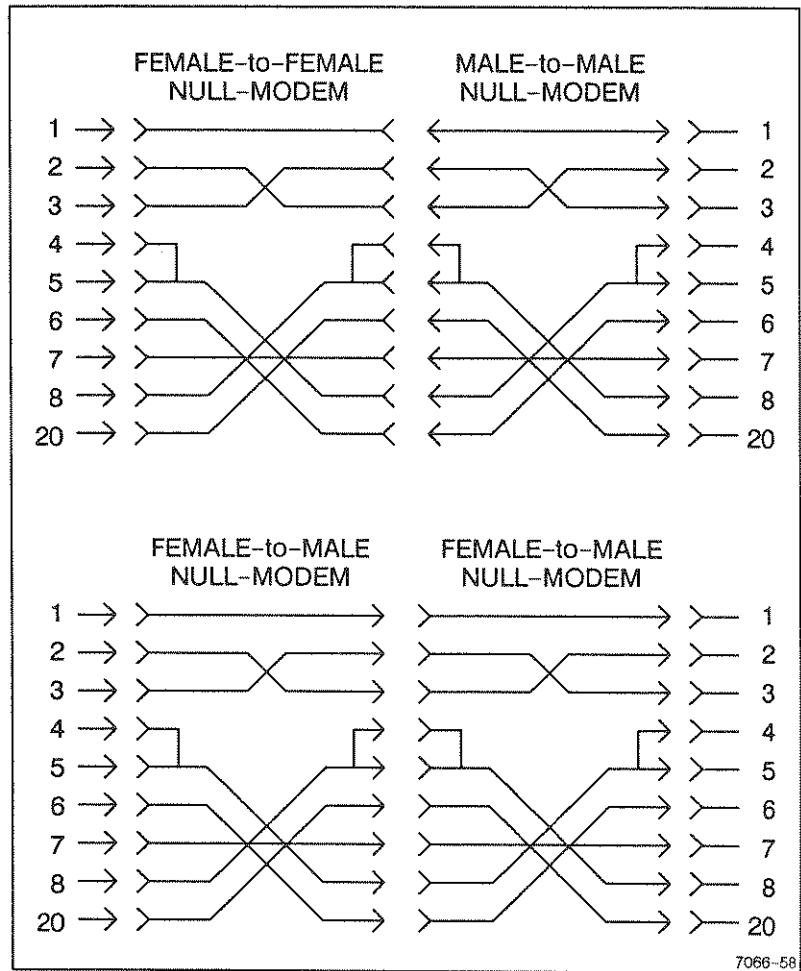

Figure B-3. Type A Connections (cont) – DTE male to DCE female.

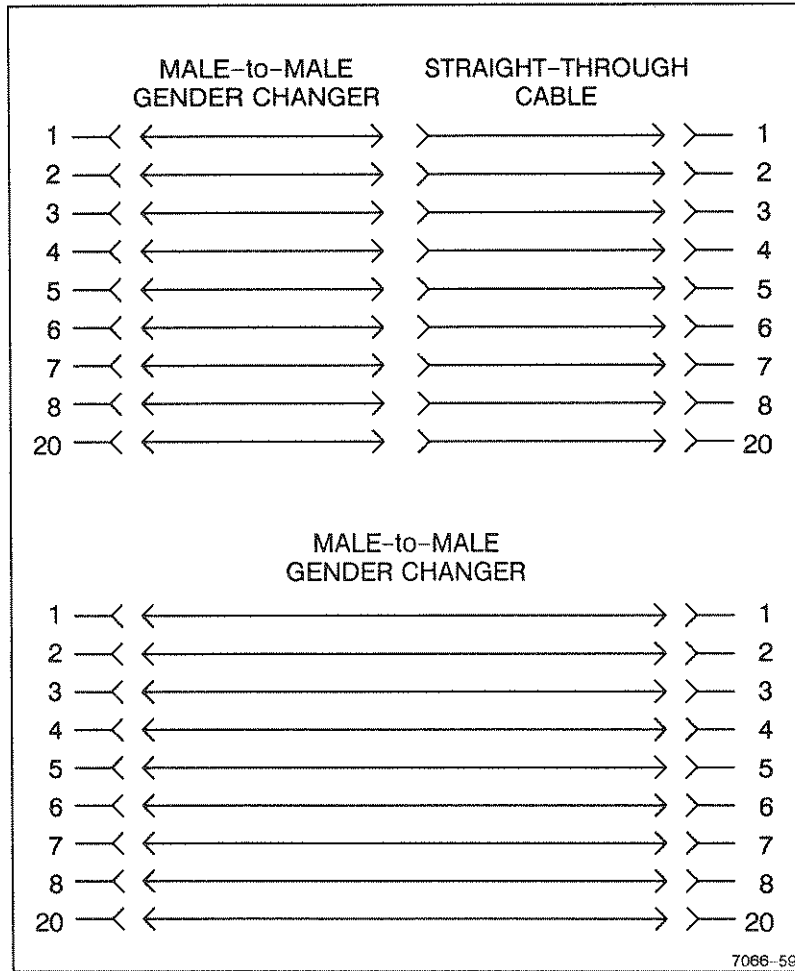

Figure B-4. Type A1 Connections – DTE female to DCE female.

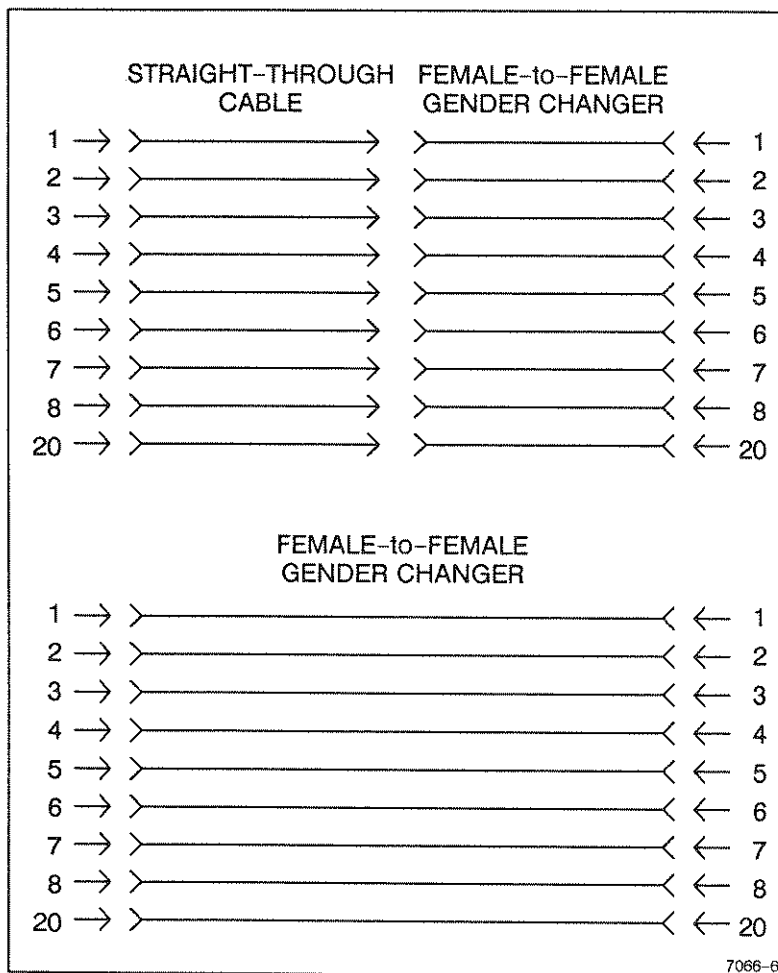

Figure B-5. Type A2 Connections – DTE male to DCE male.

Type B connections require a null-modem cable to connect two devices of the same logical type together. Either two DTE devices or two DCE devices can be made to communicate by externally reversing the data and logic lines as shown in the figures. A gender change is needed for Type B and Type B2 connections. For Type B1

Appendix B

connections, a gender change is needed only to match up to the null-modem cable connectors. Gender changing can be done with the null-modem cable if it is made with the correct gender connectors for the application.

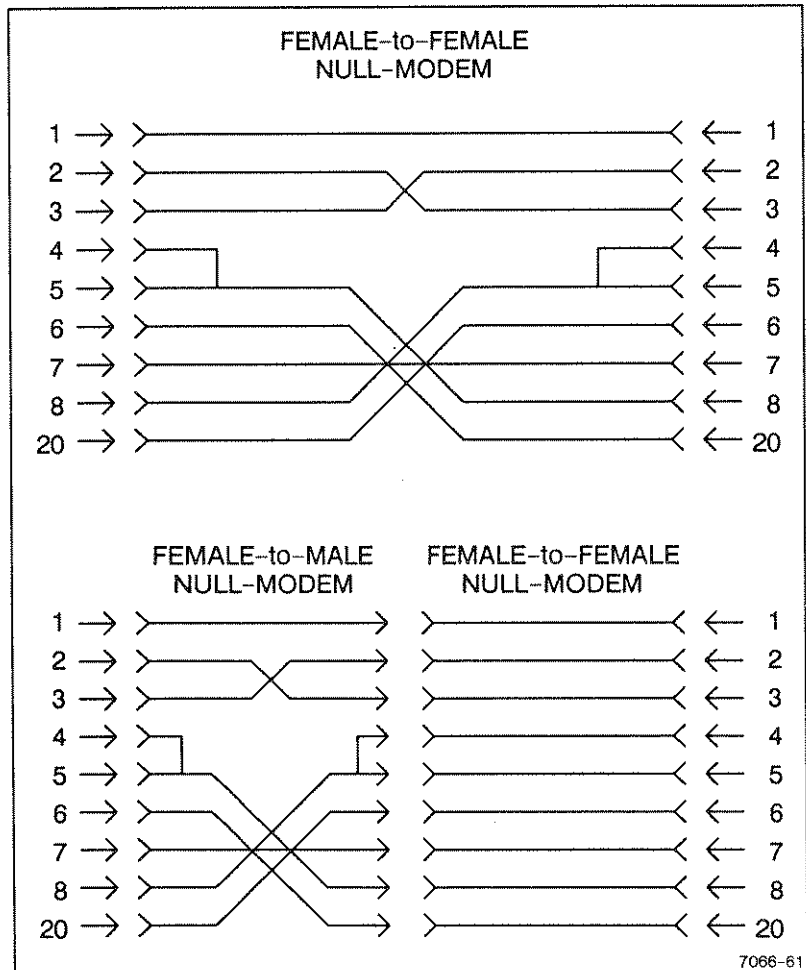

Figure B-6. Type B Connections—DTE male to DTE male and DCE male to DCE male.

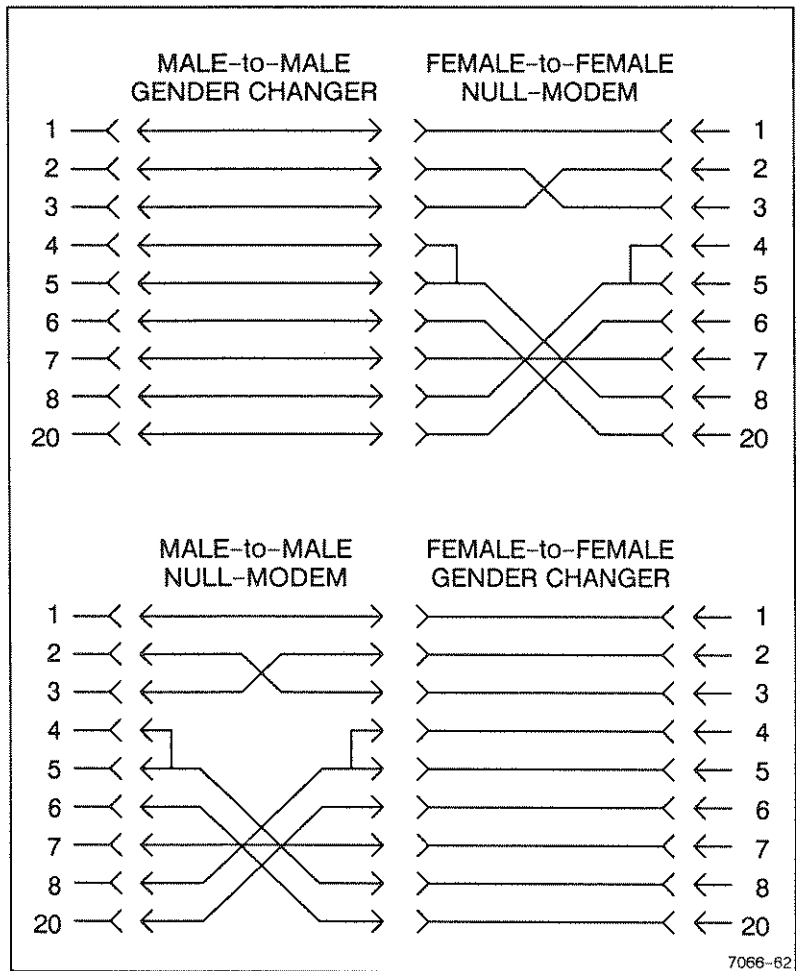
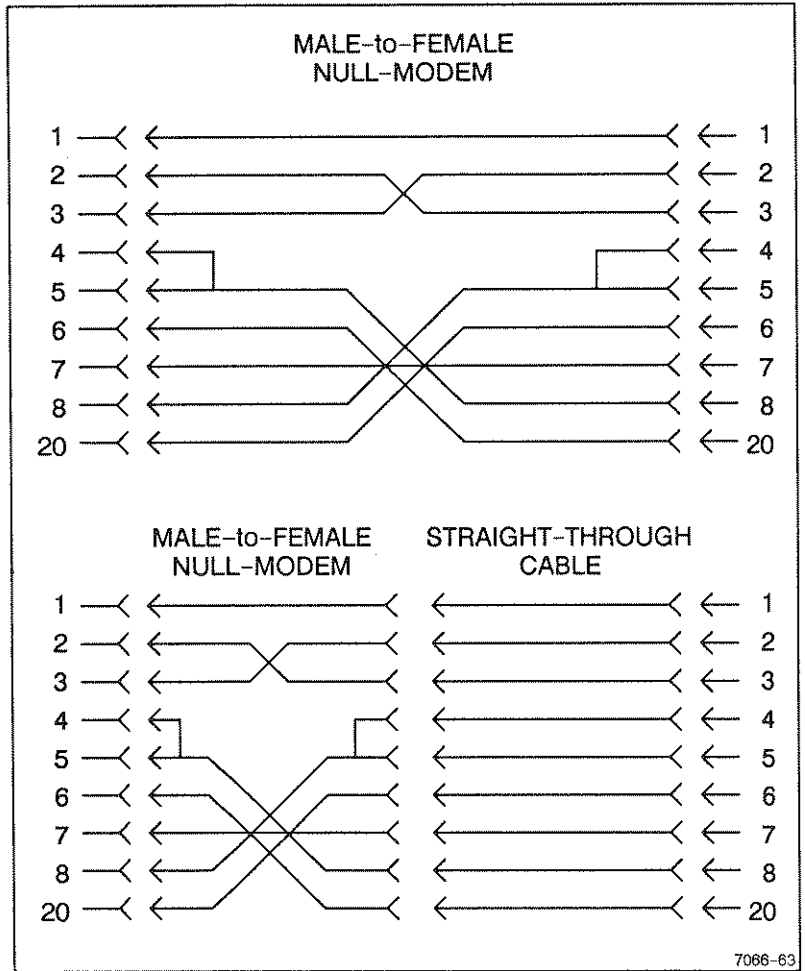

Figure B-7. Type B1 Connections – DTE female to DTE male and DCE female to DCE male.



7066-63

Figure B-8. Type B1 Connections (cont) – DTE female to DTE male and DCE female to DCE male.

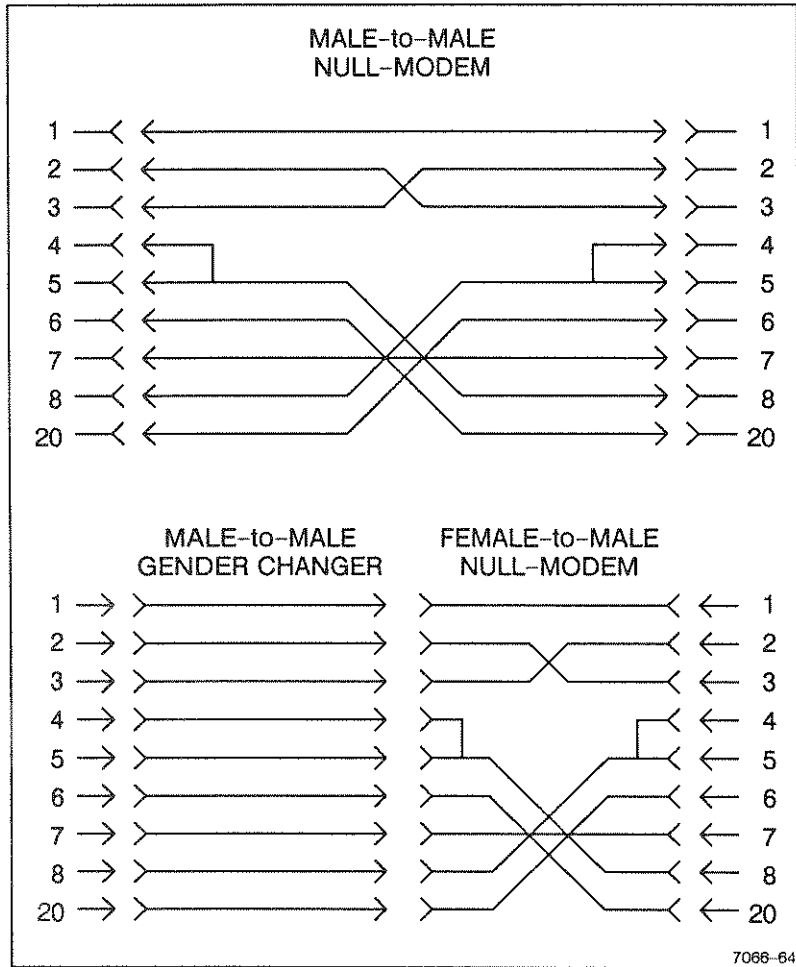

Figure B-9. Type B2 Connections—DTE female to DTE female and DCE female to DCE female.

INTERCONNECTION CABLE PART NUMBERS

Tektronix part numbers and stocks RS-232-C interconnection cables. Part numbers and a description are as follows:

RS-232 Interconnection cable, length 10 ft.	012-0911-00
RS-232 Null-Modem cable, length 16 ft.	012-0689-02

PRINTER/PLOTTER OPERATION

PLOTTER TYPES

Both communication options allow waveform plotting through their communication port or through the X-Y plotter output. Four different digital plotter or printer formats are supported via the communications interface. They are: HP-GL, Epson (both low-speed, double density, and high-speed, double density), ThinkJet, and the standard X-Y plotter.

Digital printer/plotter format can be selected two ways. The first method is to use the PARAMETERS switch settings (read at power on) for the compatible printer/plotter formats. The compatible printer/plotter formats are illustrated in Figures B-10 through B-20. The PARAMETERS switch supports direct oscilloscope to printer/plotter hookup. The second method uses the FORmat commands (described in the Command Tables of Section 8 in this manual) to select the data format when a controller is used to control the communications.

NOTE

With Option 12, a controller and an RS-232-C plotter can not be connected to the oscilloscope at the same time. An X-Y plotter may be connected to the X-Y plotter output and used in conjunction with a controller. With RS-232-C plotters/printers, the RS-232-C controller may still be used to set up the formats, then disconnected to permit the printer to be connected to the oscilloscope. An alternative to disconnecting the controller is to use an interconnecting switching device to switch the oscilloscope between the controller and the printer/plotter. Plotting is then controlled using the front-panel PLOT switches or menus of the oscilloscope.

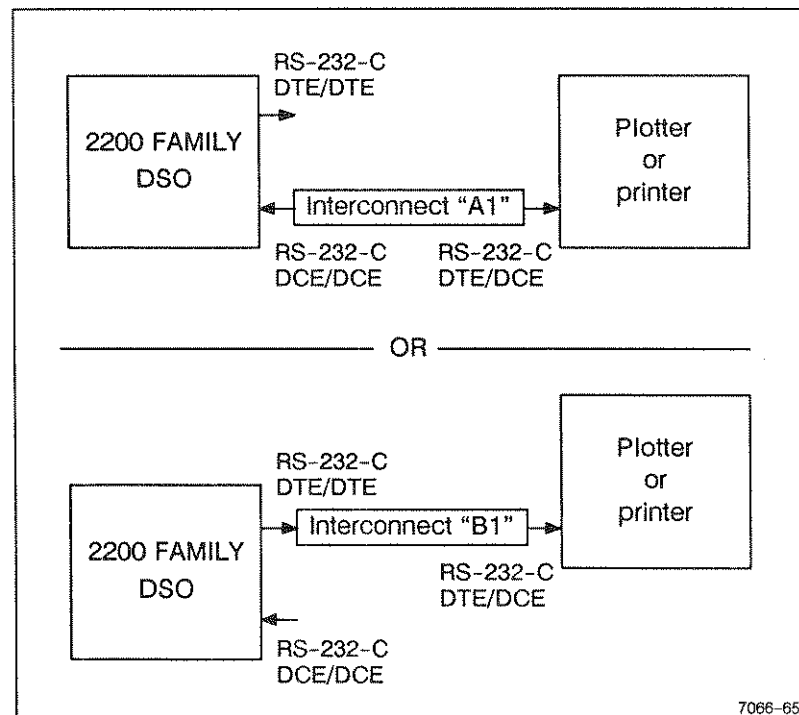

Figure B-10. Option 12 RS-232-C Printer/Plotter interconnects.

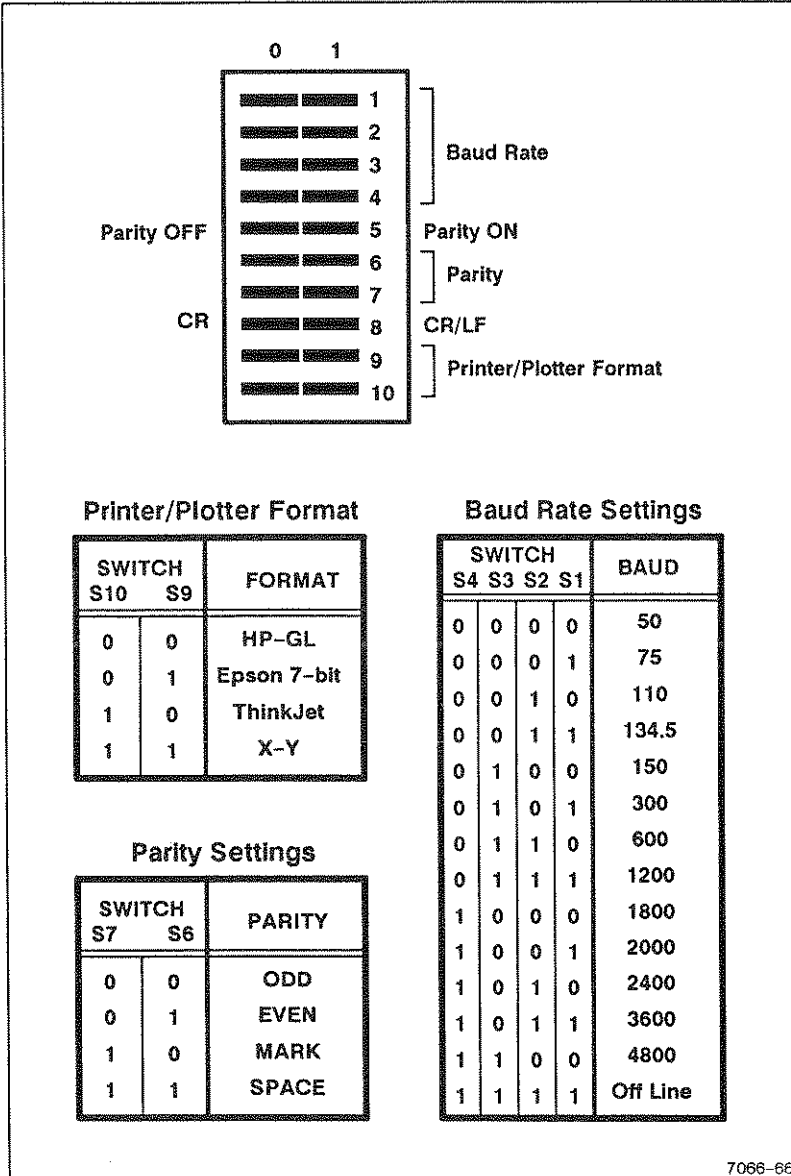

Figure B-11. Option 12 RS-232-C communication parameters.

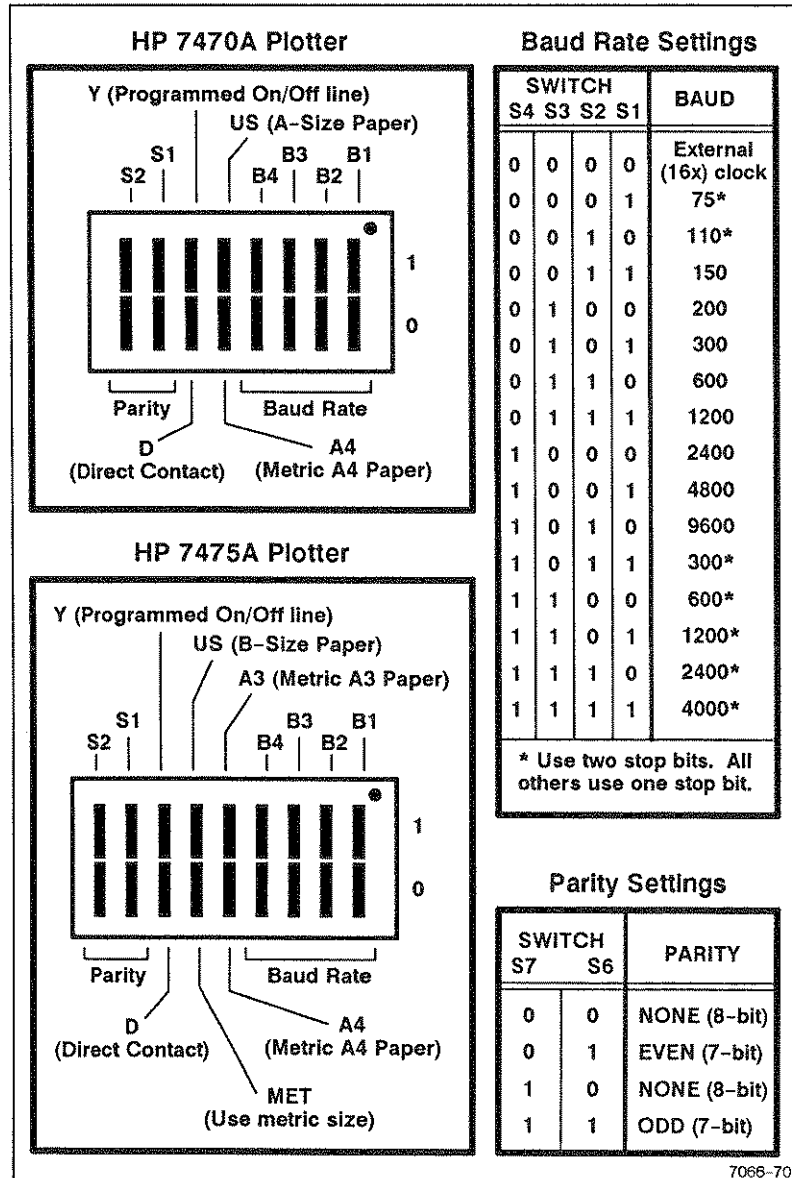

Figure B-12. HP 7470A and HP 745A plotter RS-232-C switch settings.

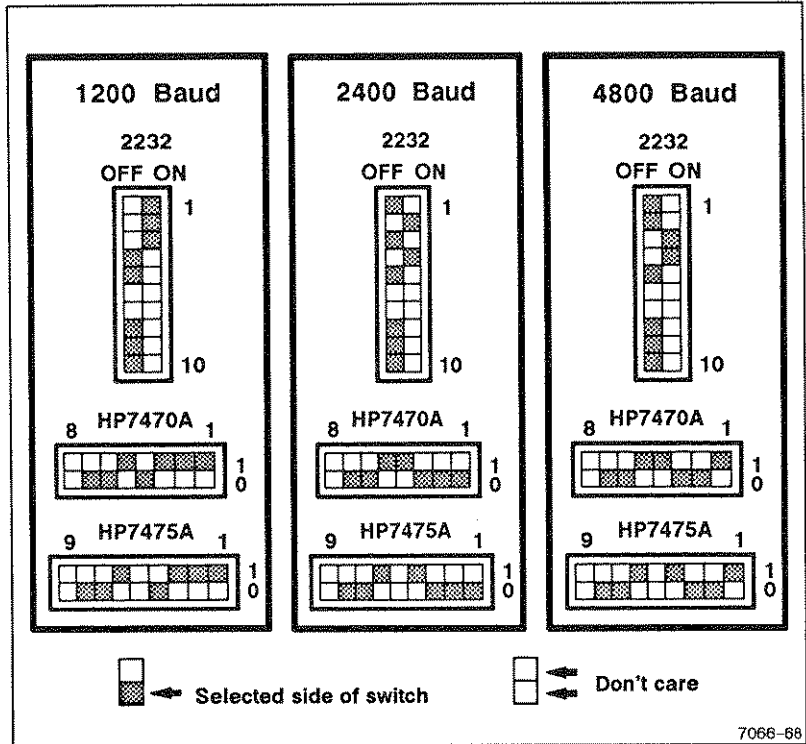

Figure B-13. Option 12 PARAMETERS switch settings for HP-GL compatible plotters.

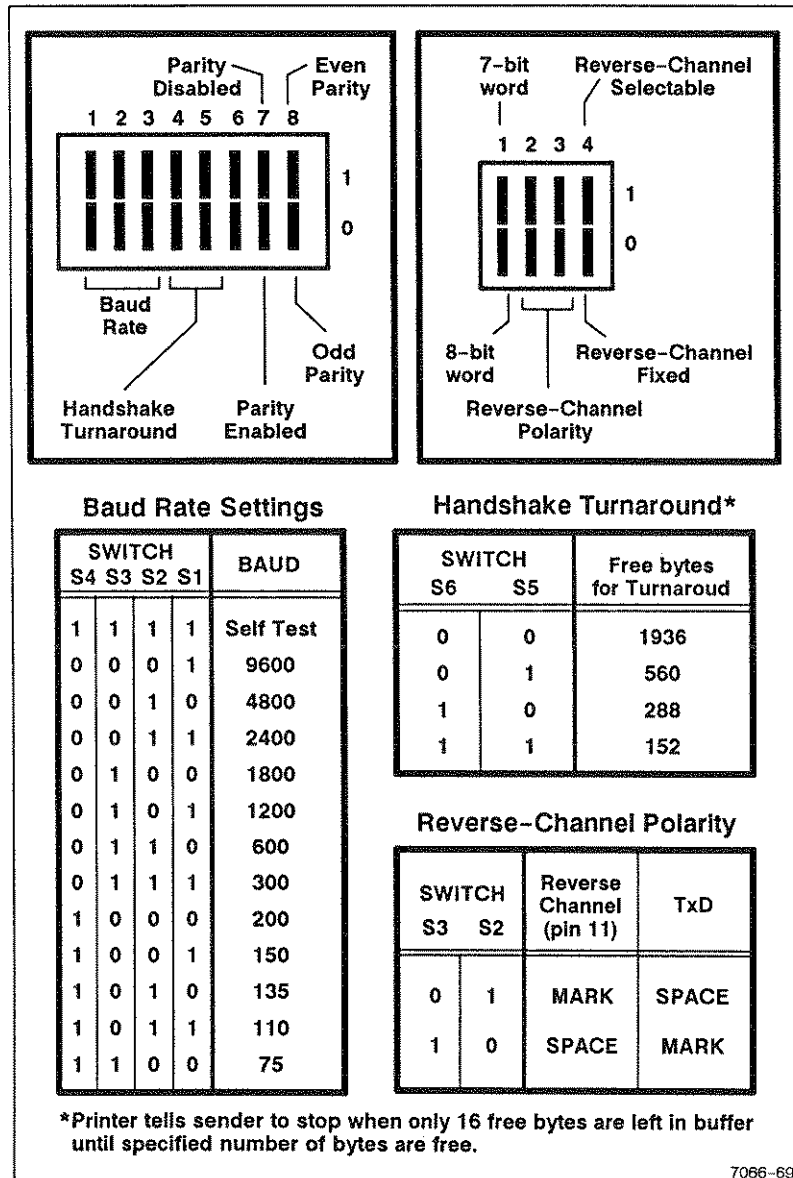

Figure B-14. Epson FX-Series printer RS-232-C switch settings.

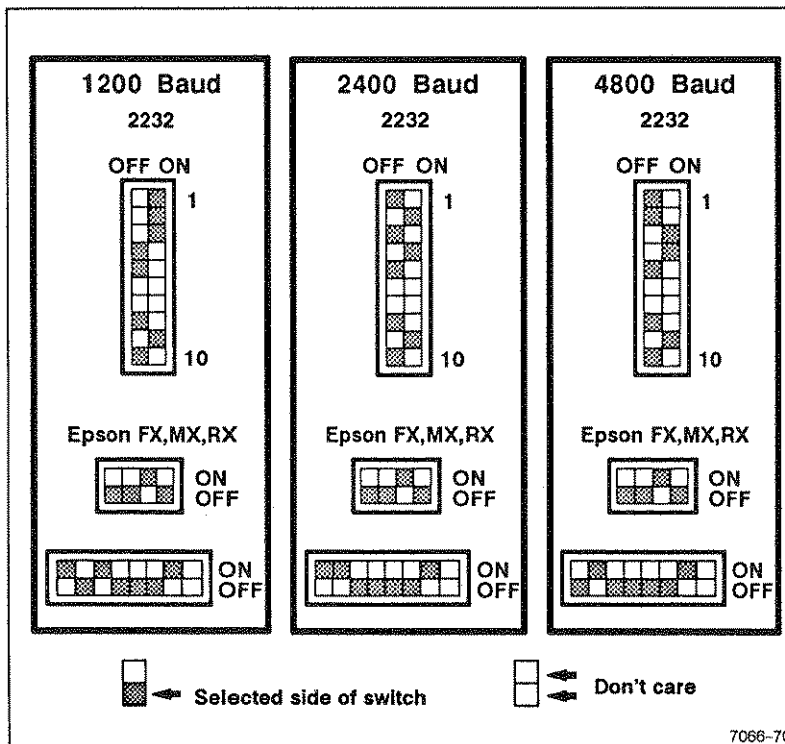

Figure B-15. Option 12 PARAMETERS switch settings for Epson printers.

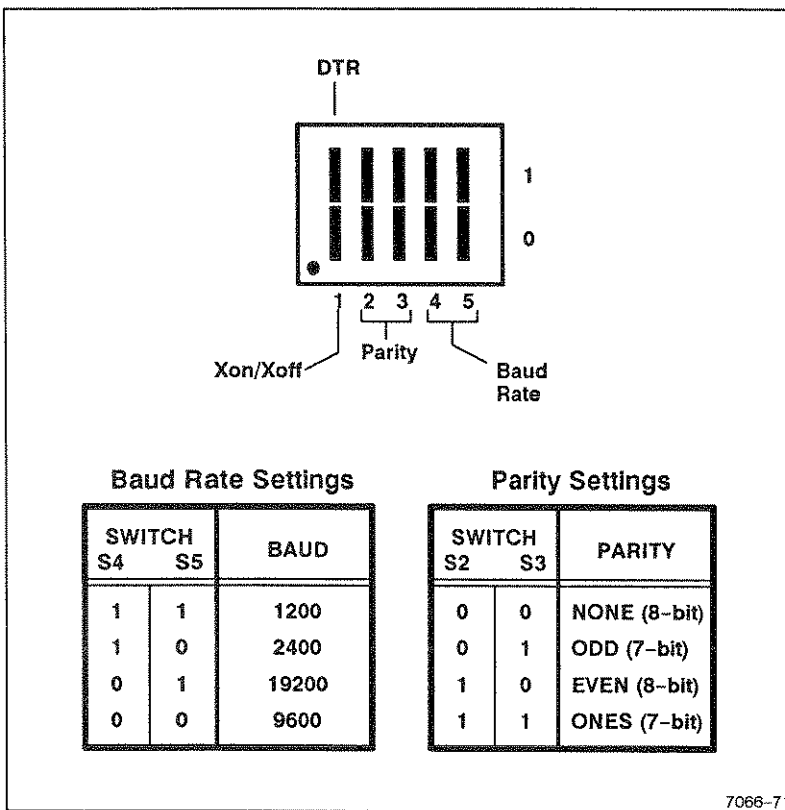

Figure B-16. HP ThinkJet RS-232-C switch settings.

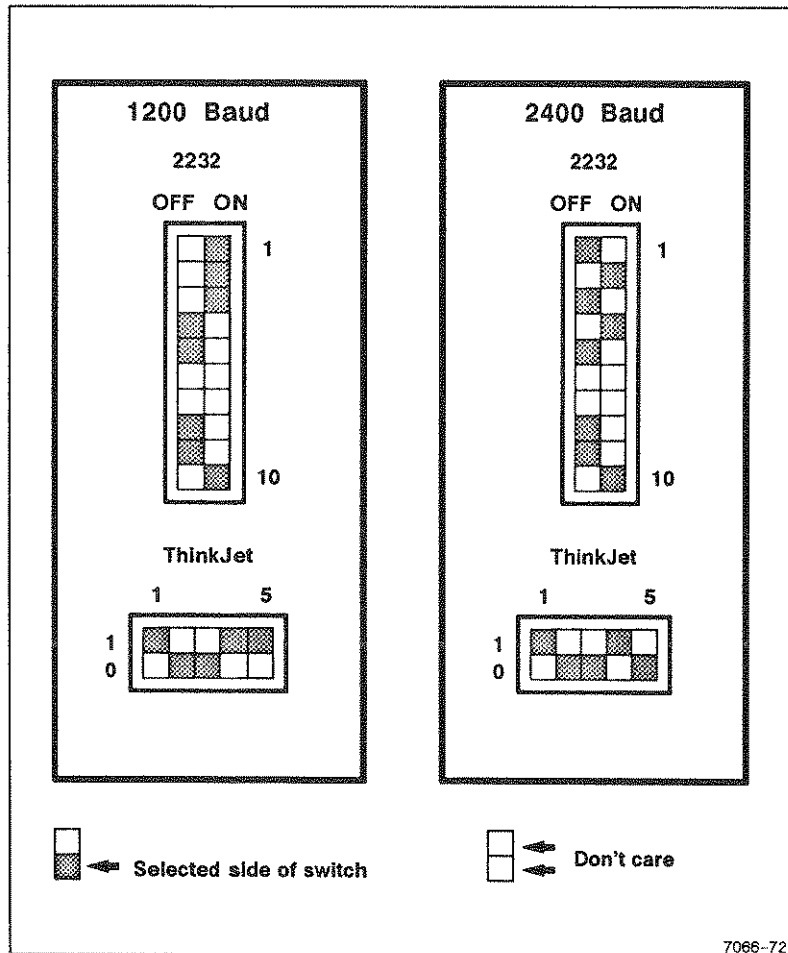

Figure B-17. Option 12 PARAMETERS switch settings for HP ThinkJet printer.

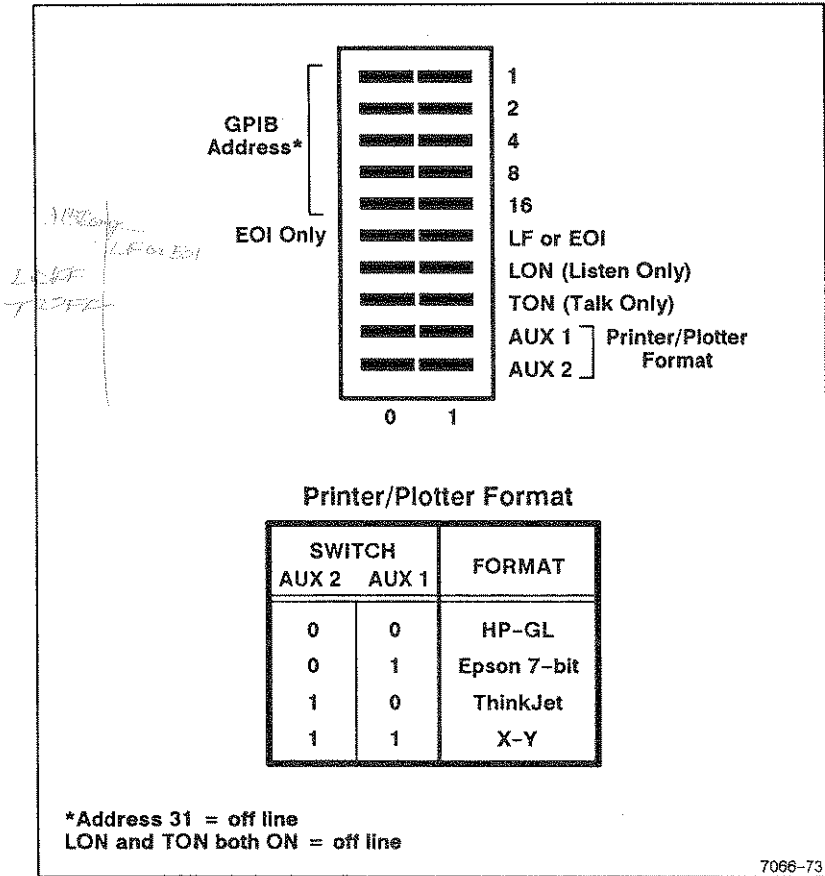

Figure B-18. Option 10 GPIB Interface PARAMETERS switch.

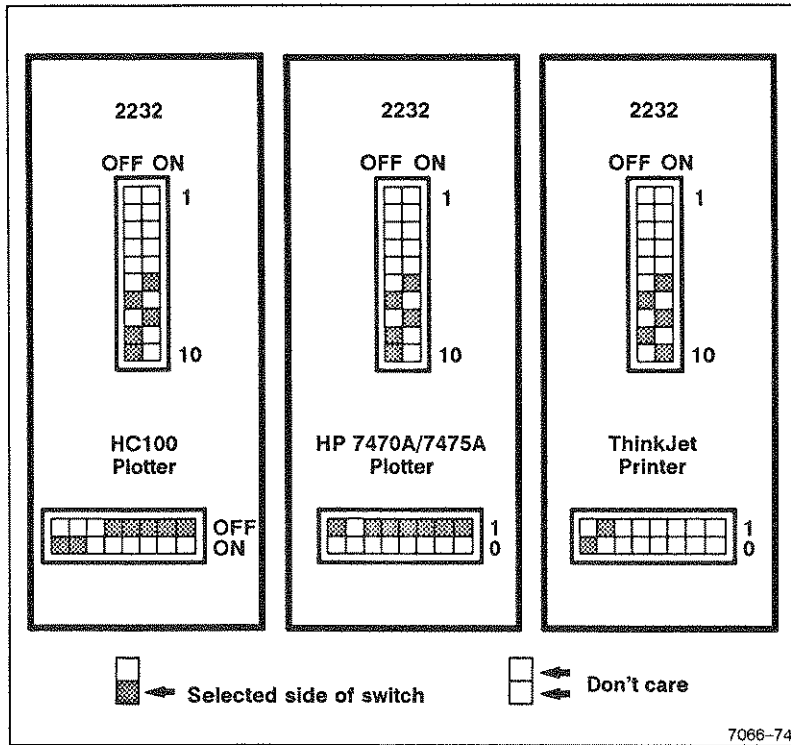

Figure B-19. Option 10 PARAMETERS switch settings for compatible GPIB printers/plotters.

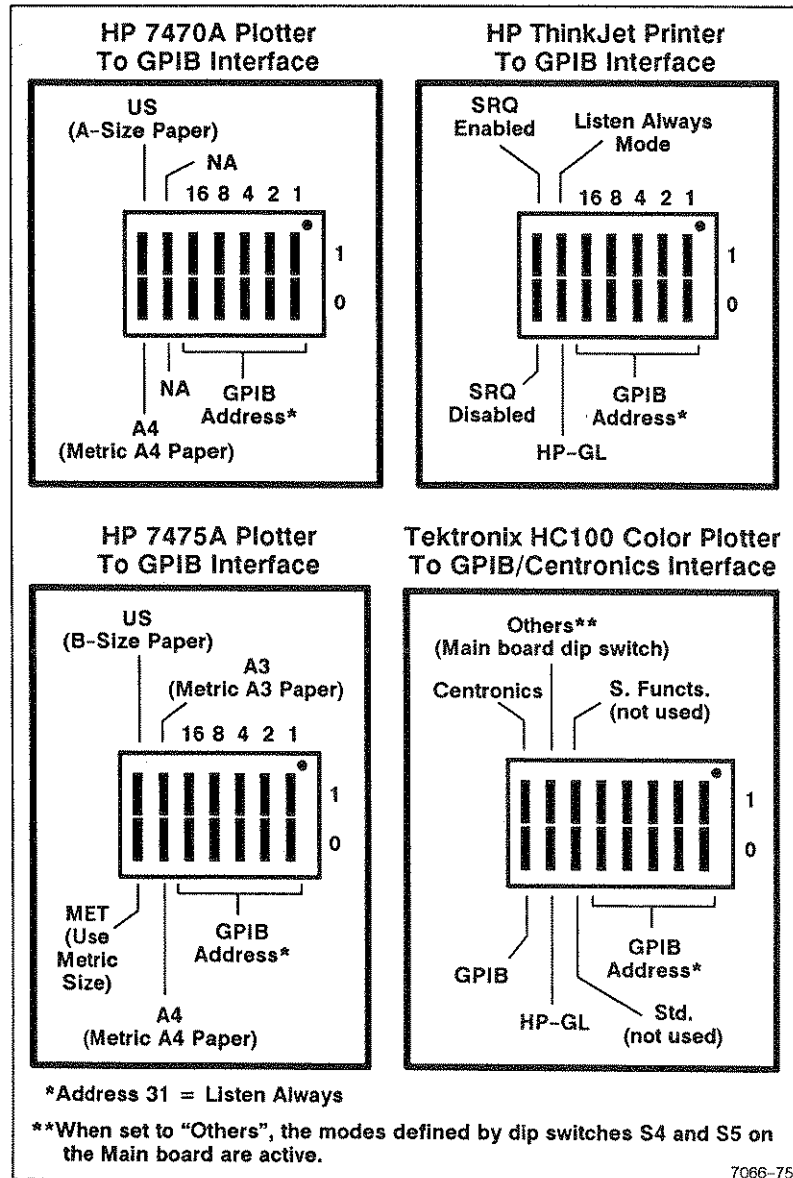

Figure B-20. Switch settings for compatible GPIB plotters.

QUESTIONS AND ANSWERS

Here are answers to some typical questions that you may have about operation of the Communications Options.

Q: What is the data transfer rate?

A: For the Option 10 GPIB interface, the data transfer rate is approximately 1 Kbyte per second. This equates to one waveform per second for 1 K records or about four seconds for 4 K waveform records.

For the Option 12 RS-232-C interface, the data transfer rate depends on the format (ASCII, HEX, or BINARY) and the baud rate. Typical times for 1200, 2400, and 4800 baud are given in Table B-2.

Q: Why does the data transfer rate slow down at 4800 baud?

A: At that baud rate, the internal data buffer of the 2232 fills before the oscilloscope's processor is ready. That interrupts the processor from its other tasks, and it must stop to issue flow control commands to halt further data input while it gets ready to accept the data from the buffer. After it handles the buffer data, it must then start the data input again. All the interrupt handling slows down the transfer rate. At 2400 baud, the oscilloscope's processor is usually ready to handle the incoming data before the buffer fills, and it is not necessary to continually interrupt the data flow.

Q: The operators manual states that multiple commands may be sent in one message line, but sometimes errors are generated when I try this with Option 12. Why is that, and what can I do about it?

Table B-2
RS-232-C Transfer Rates

Baud Rate	Record Size	Format	Transfer Time (Min:Sec)
1200	4K	ASCII	2:20
		HEX	1:10
		BINARY	0:36
	1K	ASCII	0:36
		HEX	0:20
		BINARY	0:10
2400	4K	ASCII	1:15
		HEX	0:40
		BINARY	0:20
	1K	ASCII	0:19
		HEX	0:10
		BINARY	0:05
4800	4K	ASCII	2:39
		HEX	1:16
		BINARY	0:45
	1K	ASCII	0:58
		HEX	0:29
		BINARY	0:13

A: To answer the second question first, write RS-232-C controller programs to send only one command at a time.

For the first question of why multiple commands sometimes cause errors, the answer is that only one command at a time can be reliably handled by the processor. Commands (and arguments to commands) are interpreted and handled as they

Appendix B

are recognized; the oscilloscope processor does not wait for the message terminator to end the message. If a service request is generated by one of the commands in a command string, a correcting action may have to be taken. If the service request is not handled properly, all following commands in a string may not be valid, and the controller program may not be able to continue.

Q: Sometimes when I send commands to change the operating state of the instrument, they are not accepted. What is the problem?

A: The REM ON command must be sent as the first command before attempting to change the operating state of the oscilloscope. The power-on state of REM is OFF.

Q: When I send waveforms to the oscilloscope at 2400 baud or more, I get bad transfers when I try to use binary-encoded curve data. What is the problem?

A: Flow control must be used when sending waveform data to the oscilloscope at the higher baud rates. That is because the input data buffer is only 160 characters long and it fills up before the processor is ready to handle the input. Because of the nature of binary data, flow control can not be used to reliably send or receive binary-encoded curve data. Use either HEX or ASCII encoding instead. HEX-coded waveform data requires fewer characters to be transferred than ASCII-coded waveform data, and therefore is faster than ASCII format. Also, parity must be disabled with the PARAMETERS switch setting for binary data transfers. That setting has to be made before the instrument is turned on since power-on is the only time the switch is read.

Q: What is the size of the oscilloscope's data output buffer?

A: The output buffer is about 1,000 characters.

Q: Why do I sometimes get bad curve data when I operate the DSO in the Repetitive Store Mode?

A: This problem is caused by not allowing enough sweeps to occur to fill the entire waveform record. Repetitive Store Mode (random

equivalent-time sampling) depends on the probability of filling the waveform record in a specified number of sweeps. The more sweeps that are used to sample an input signal, the more probable it is that the waveform record will be filled when the waveform is asked to be transferred. If you receive bad curve data, you must allow more sweeps to occur before requesting the waveform from the oscilloscope.

One way to do this is to set the number of sweeps (via either the oscilloscope's menu controls or a command message) to a value several times larger than the number of sweeps needed for a 50% probability of filling the record (see Controls, Connectors, and Indicators Section 3 of the Operators manual). Also, you can set RQS and OPC on. Then, when the specified number of sweeps have been acquired, the oscilloscope will issue a single SRQ (service request). When the controller software determines that an the end-of-acquisition OPC state caused the service request, it can request the curve data.

Q: When operating in ALT or CHOP Vertical Mode, how do I designate from which channel of the acquisition or reference memory the waveform data is retrieved? How do I designate in which channel of a reference memory the waveform data is stored when sending waveforms to the oscilloscope?

A: The data channel for source and target for waveform transfers is designated using the REFERENCE WAVEFORM commands (see DATA CHANNEL). Either channel of the acquisition or Save Ref memory may be retrieved from the oscilloscope. Waveform data may be sent to either channel of a targeted Save Ref memory (see DATA TARGET).

Q: What is the purpose of the external clock?

A: The external clock can be used to acquire signals that change too slowly for the normal calibrated SEC/DIV settings (for example, one sample every hour). Another use is to synchronize the 2232 so that samples are done on selected events.

Q: Can you re-arm Single Sweep via the communication option?

Appendix B

- A: The Single Sweep function may be armed using the SGLswp ARM command. Single Sweep may also be queried to determine the state of the Single Sweep function (ARM or DONE).
- Q: What is the maximum sensitivity in digital storage?
- A: It is 2 mV/division, the same as in nonstore mode.
- Q: Can I compress, expand, or reposition the stored waveforms?
- A: The 2232 has commands for reformatting a target reference waveform.
- Q: What is the maximum expansion/compression factor for stored waveforms with the 2232?
- A: Vertically, the reformat target waveforms may be expanded or compressed by a factor of ten from their acquired VOLTS/DIV setting. Horizontally, the X10 Magnification feature may be turned on for the reformat target waveforms.
- Q: Can I return a reformatted waveform back to its original settings?
- A: Yes. Query the BASEgain to determine the acquired volts/div setting and set the VGAIN to that setting. To return to the original vertical position, set VPOsition to 0; turn HMag off to regain the acquired sec/div setting.
- Q: Can the baud rate, end-of-line terminator, or parity setups be changed from the RS-232-C controller?
- A: No. Those communications parameters must be set up using the PARAMETERS switch on the oscilloscope's side panel before the oscilloscope is turned on.
- Q: Can the GPIB address of the oscilloscope be changed from the bus or the front-panel?
- A: The GPIB address and other communication parameters are settable only from the PARAMETERS switch on the oscilloscope's side panel, and the switch settings are read only at power on.

Q: Can a waveform preamble be sent to the instrument?

A: Yes, a waveform preamble can be sent to the oscilloscope. That preamble should correspond to the curve data that is sent to the target Save Ref memory.

Q: Can the waveform display be modified by changing the preamble fields?

A: Modifying the preamble information so that it does not correspond to the curve data invalidates the waveform, but it doesn't usually change the way it is displayed. If drastic changes are made to the preamble (such as data encoding or point format), the oscilloscope will probably reject the curve data as not matching the preamble.

Q: What type of averaging is used for the AVERAGE acquisition mode?

A: A normalized averaging algorithm is used.

$$A_s = A_{(s-1)} + (i_s - A_{(s-1)}) (\text{Weight})$$

Where:

A_s = the average after s number of sweeps,
 $A_{(s-1)}$ = the average after $(s-1)$ sweeps,
 i_s = the s th input sample,
Weight = the selectable weighting factor from
1/1 though 1/256 in a power of
2 sequence.

Q: Can I get readout information over the communications interface?

A: CRT display information may be queried individually or obtained as part of the waveform preamble. The volts/div, sec/div, acquisition mode, trigger information, and cursor readouts are all available in the 2232.

Q: What is the 26-K non-volatile memory supplied with the 2232 Communications option, and what are its waveform storage capabilities?

Appendix B

A: Memory space for 26, 1-K waveforms, or 6, 4-K waveforms, or any combination of waveform record totaling not more than 26 K bytes is provided by the added memory. The non-volatile memory is battery-backed for long-term waveform data storage.

Q: Can acquired waveforms be stored in the added memory using the 2232 front-panel controls?

A: Yes. Waveforms may be transferred into and out of the added memory using the Reference menu selections available in the Advanced Functions Menu. Waveforms must be transferred through one of the numbered Safe Ref memory locations (REF1 REF4).

Q: How are the waveforms stored in the added memory addressed via the 2232 communications option?

A: The added memory locations are designated REFA through REFZ. These memory locations are accessed through the REF1 REF4 memory locations for both reading and writing using the REFFrom and SAVeref commands; they cannot be directly accessed.

Q: What are the differences between Peak Detect (PEAK) and Accumulated Peak Detect (ACCPEAK) acquisition modes?

A: Peak Detect and Accumulated Peak Detect are both envelope acquisition modes. Peak Detect captures the maximum and minimum points for each sample interval during each successive acquisition. Accumulated Peak Detect holds previously acquired peak values until reset so that the changes over time are detectable. Accumulated Peak Detect is valid only for triggered acquisitions and is not allowed in untriggered modes. Peak Detect is valid for both triggered and untriggered modes, since no peaks are held between acquisitions.

Q: What is the default number of acquisitions in ACCPEAK mode?

A: The number of sweeps that may be accumulated can be set for a default of continuous (ACQ NUM:0) or any number between 1 through 2047. With each new acquisition, the most-positive and

most-negative values are added to the existing display. When set to a specified number, the acquisition stops when the limit is reached, and the waveform is held displayed.

Q: What is the envelope sampling rate in Peak Detect and Accumulated Peak Detect?

A: 100 megasamples per second.

Q: Can the 2232 cursor positions be addressed over the communications interface?

A: Yes. The cursors may be targeted to the acquisition or a Save Reference waveform and positioned within the waveform record. Their voltage difference and time difference may be queried to determine the readout values.

Q: Is delay time included in the 2232 waveform preamble?

A: No. The preamble does not indicate if the curve data was taken at an A or a B SEC/DIV setting, just what the SEC/DIV setting is for that curve data.

Q: Are the displayed intensified zones seen in a 2232 acquisition stored in either SAVE mode or in SAVE REF memory?

A: Yes, they are saved in both SAVE and in SAVE REF.

Q: What waveform data is sent by a 2232 if the waveform acquired in BOTH Horizontal Mode is requested?

A: The A Sweep waveform is sent.

Q: Can a waveform be sent to a controller from the front panel of the oscilloscope?

A: No, but the waveform may be sent to plotter or printer. With Option 10, the oscilloscope must be in Talk Only mode. With either option, the PARAMETERS switch must be set to output the correct format for the printer or plotter being used. See Section 7 of the Operators Manual and the Printer/Plotter

Appendix B

Q: How fast do these various types of data transfers occur?

A: With the GPIB interface (Option 10), data moves at about 1-Kilobyte/second. This means that a 1-K waveform, plus its associated preamble (contains scaling info, etc) can be moved to or from the scope in about a second. A 4-K waveform will take about four seconds.

The transfer rate on the RS-232 interface (Option 12) depends on data encoding format and baud rate. To move a 1-K, binary-encoded waveform at 1200 baud will take about 10 seconds. The same waveform hex-encoded will take about twice that long, or 20 seconds. At 2400 baud, these times will be cut in half.

Baud rates above 2400 baud are not advised, since the scope will actually spend more time starting and stopping the flow of data (to prevent buffer overflows) than it spends moving the actual data. The net result is that 4800 baud waveform transfer will actually take substantially longer than the same transfer at 2400 baud.

Q: I'm sure I have everything connected right, but I still can't get a waveform to come back from the scope. What am I doing wrong?

A: The 2232 has several places that waveform data can come from. These include Acquisition memory, Reference memories, and Non-volatile memories. Furthermore, each of these memories have two channels of data associated with them (i.e., CH 1 and CH 2). The source of waveform data must be explicitly defined in order to get data from a location other than the current default location. At power-up, the default data source is Channel 1 of Acquisition memory.

For example, if you just powered up the scope and have CH 2 waveform on screen, you must specify the command DATA CHANNEL: CH 2 before you can get the waveform back from the scope.

Q: I have an Option 12 (RS-232) scope and have written a program that seems to run most of the time, but sometimes I don't get all my data back from the scope. What's going on?

A: There are several things that can cause data loss when using the RS-232 interface, and relate to the serial nature of the interface. Some general recommendations should take care of most problems.

First, don't send more than one command to the scope at a time. Sending multiple commands on a single program line can cause order-dependent command strings to execute improperly if the scope is not in the expected mode.

Use flow-control to prevent buffer overflows (and data loss).

The command REMOTE ON must be sent prior to sending any command that will change the 232 operating mode, and prior to any waveform transfer to the scope.

MANUAL CHANGE INFORMATION

At Tektronix, we continually strive to keep up with the latest developments by adding improvements to our products as soon as they are developed and tested.

Sometimes, due to printing and shipping requirements, we can't get these changes immediately into printed manuals. Hence, your manual may contain new change information on the following pages.

A single change may affect several sections. Since the change information sheets are carried in the manual until all changes are permanently entered, some duplication may occur. If no such change pages appear following this page, your manual is correct as printed.

Date: 6-22-89 Change Reference: C5/0689

Product: 2232 OPERATORS

Manual Part Number: 070-7066-00

DESCRIPTION

Product Group 41

USING THE POWER CORD WRAP

To store the Power Cord while not in use, wind the cord tight around the cord holders, then position the male plug in the recessed area of the rear panel.

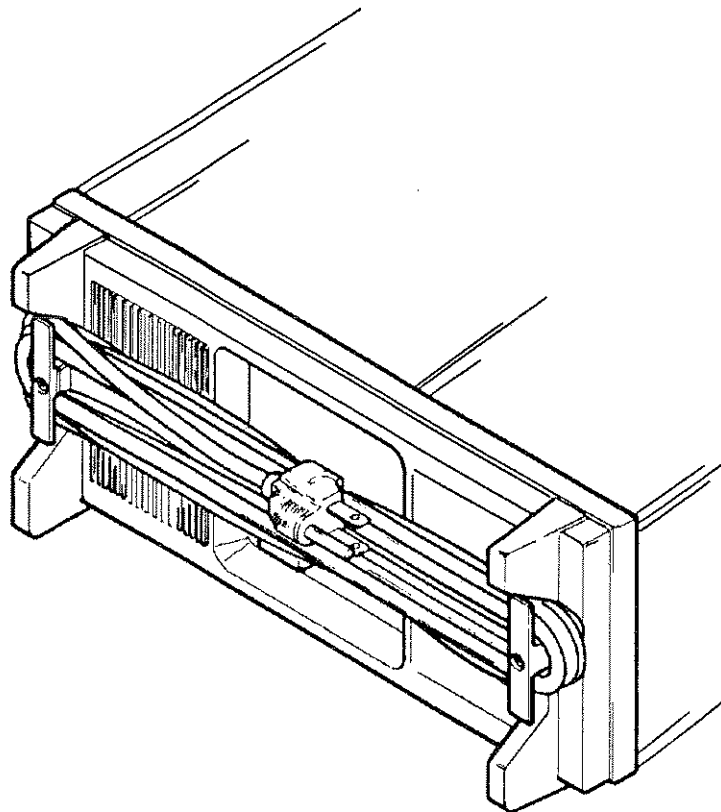

Tektronix
COMMITTED TO EXCELLENCE

MANUAL CHANGE INFORMATION

Date: 6-22-89 Change Reference: C6/0689

Product: 2232 OPERATORS Manual Part Number: 070-7066-00

DESCRIPTION

Product Group 41

INSTALLING THE ACCESSORY POUCH

*REFER TO THE ILLUSTRATION ON THE FOLLOWING
PAGE WHILE PERFORMING THIS PROCEDURE*

1. Place the oscilloscope on a table or work bench with the rear against a firm support or wall and the front facing you.
2. Center the rear of the pouch plate and insert the rear edge of the plate in the space between the cabinet top and the rear panel trim (see part A of illustration).
3. Move the pouch sideways as necessary to line up the key slots in the pouch plate with the keys on the rear panel (the plate will be centered when aligned) and push the plate all the way in (see part B of illustration).
4. Grasp the pouch plate assembly with both hands near the front of the assembly.

NOTE

In the next step, use only enough force to clear the front panel trim with the plate front edge. Excessive force will cause a permanent bow in the plate.

5. Push back on the plate and press down with the heels of your hands to bow the plate enough to slide the front of the plate into the space between the cabinet top and the front panel trim (see part C of illustration).
6. Move the front of the pouch as needed to line up the key slots in the plate with the keys on the front panel.
7. Release the pressure on the plate to allow it to return to its normal flat shape.

MANUAL CHANGE INFORMATION

Product: 2232 OPERATORS

Date: 6-22-89 Change Reference: C6/0689

DESCRIPTION

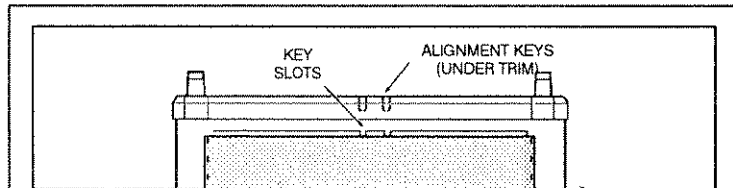

A. CENTER THE POUCH PLATE TO ALIGN THE KEY SLOTS.

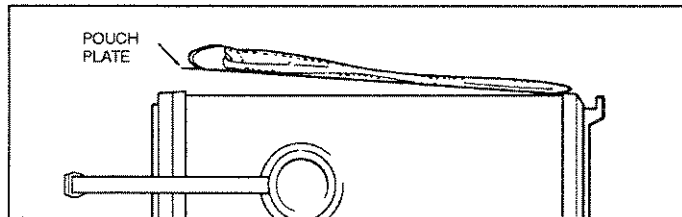

B. PUSH THE POUCH PLATE INTO THE REAR TRIM GAP.

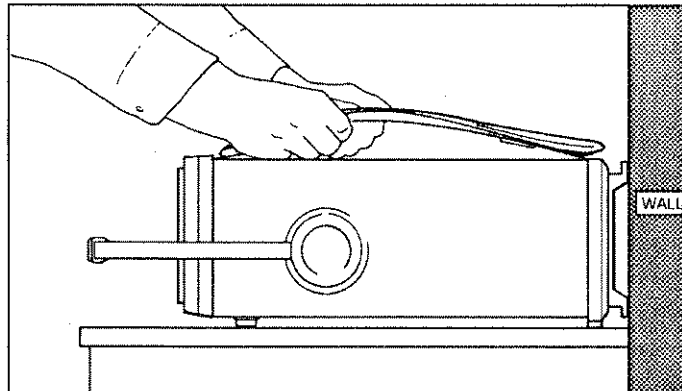

C. BOW THE PLATE AND SLIDE IT INTO THE FRONT TRIM GAP.

Free Manuals Download Website

<http://myh66.com>

<http://usermanuals.us>

<http://www.somanuals.com>

<http://www.4manuals.cc>

<http://www.manual-lib.com>

<http://www.404manual.com>

<http://www.luxmanual.com>

<http://aubethermostatmanual.com>

Golf course search by state

<http://golfingnear.com>

Email search by domain

<http://emailbydomain.com>

Auto manuals search

<http://auto.somanuals.com>

TV manuals search

<http://tv.somanuals.com>