



## **OWNER'S MANUAL**

### **2.4GHz DIGITAL SPREAD SPECTRUM CORDLESS TELEPHONE SYSTEM**

**Model 20-2432**

**Qwest Customer Service (800) 651-6791**



## **Important Safety Instructions**

---

When using your telephone equipment, basic safety precautions should always be followed to reduce the risk of fire, electric shock and injury, including the following:

1. Read and understand all instructions.
2. Follow all warnings and instructions marked on the product.
3. Unplug this product from the wall outlet before cleaning. Do not use liquid cleaners or aerosol cleaners. Use a damp cloth for cleaning.
4. Do not use this product near water (for example, near a bath tub, kitchen sink, or swimming pool).
5. Do not place this product on an unstable cart, stand, or table. The product may fall, causing serious damage to the product.
6. Slots and openings in the cabinet and the back or bottom are provided for ventilation. To protect it from overheating, these openings must not be blocked by placing the product on the bed, sofa, rug, or other similar surface. This product should never be placed near or over a radiator or heat register. This product should not be placed in a built-in installation where proper ventilation is not provided.
7. This product should be operated only from the type of power source indicated on the marking label. If you are not sure of the type of power supply to your home, consult your dealer or local power company.
8. Do not allow anything to rest on the power cord. Do not locate this product where the cord will be abused by persons walking on it.
9. Never push objects of any kind into this product through cabinet slots as they may touch dangerous voltage points or short out parts that could result in a risk of fire or electric shock. Never spill liquid of any kind on the product.
10. To reduce the risk of electric shock, do not disassemble this product. Opening or removing cabinet parts other than specified access doors may expose you to dangerous voltages or other risks. Incorrect reassembling can cause electric shock when the appliance is subsequently used.
11. Do not overload wall outlets and extension cords as this can result in the risk of fire or electric shock.



## **Important Safety Instructions**

12. Unplug this product from the wall outlet and contact the Supplier under the following conditions:
  - A. When the power supply cord or plug is damaged or frayed.
  - B. If liquid has been spilled into the product.
  - C. If the product has been exposed to rain or water.
  - D. If the product does not operate normally by following the operating instructions. Adjust only those controls that are covered by the operating instructions, because improper adjustment of other controls may result in damage and will often require extensive work by an authorized technician to restore the product to normal operation.
  - E. If the product has been dropped and the cabinet has been damaged.
  - F. If the product exhibits a distinct change in performance.
13. Avoid using a telephone (other than a cordless type) during an electrical storm. There may be a remote risk of electric shock from lightning.
14. Do not use the telephone to report a gas leak in the vicinity of the leak.

**SAVE THESE INSTRUCTIONS**

# Introduction

---

The **20-2432** is an advanced cordless telephone that operates in the 2.4GHz frequency range. Your **20-2432** is capable of supporting up to a maximum of 8 Handsets. Using additional Handsets, several people can be using the cordless system at the same time. Some examples:

- 2 Handsets conferenced on a Line 1 call; while 2 additional Handsets are conferenced on a Line 2 call.
- 2 Handsets conferenced on a Line 1 call; while another Handset is in Intercom mode with the Base Unit.
- 1 Handset on Line 1; a different Handset in Intercom mode with the Base Unit; 2 additional Handsets are conferenced on Line 2.

This manual is designed to familiarize you with the **20-2432** cordless telephone. We strongly recommend you read the manual before using your phone.

**To order additional system Handsets (model# 20-2422), battery packs, or headsets, call the Supplier at (800) 651-6791.**

## MENU DRIVEN DISPLAYS

The **20-2432** Handset and Base feature a user-friendly display, making it easy to access the many features of this multi-Handset, cordless system. The three black keys, found directly below the LCD screen, are called soft keys. They are called this because their functions change depending on what you're doing-making a call, reviewing Caller ID, adding a name and number to your Phone Book, etc.

For example, when the Handset is in the idle mode, the LCD displays:



In this case, the 3 soft keys access **REDIAL**, **MENU** and **MEMORY**.

When the Handset is active, the LCD displays:

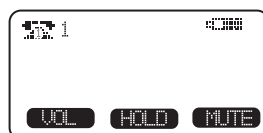

In this case, the 3 soft keys access **VOLUME**, **HOLD** and **MUTE**.

## Parts Check List

1. Base Unit
2. Handset
3. AC Power Adapter
4. Telephone Cords
5. Battery Pack (2)
6. Belt Clip
7. Owner's Manual
8. 2.5mm Headset

To purchase replacement battery packs, call the Supplier at (800) 651-6791.



Handset

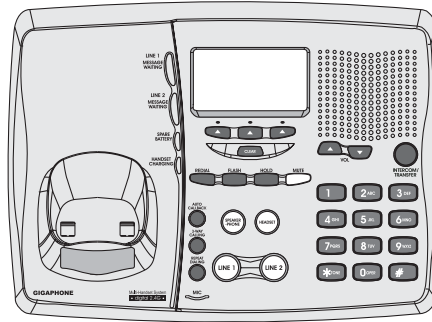

Base Unit

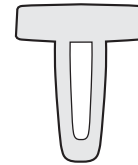

Belt Clip

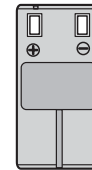

Battery Pack x 2

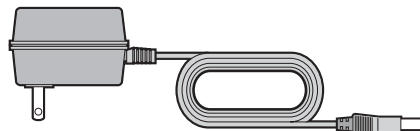

AC Power Adapter

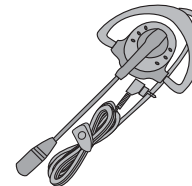

2.5mm Headset

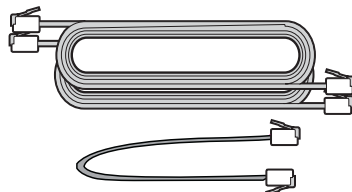

Telephone Line Cord

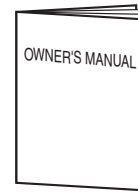

Owner's Manual

## The Handset Layout

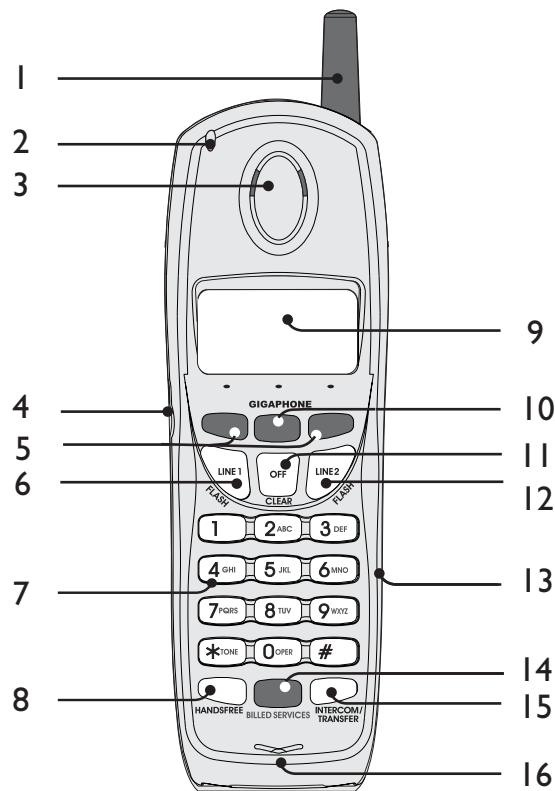

- |                                     |                                                 |
|-------------------------------------|-------------------------------------------------|
| 1. <b>Antenna</b>                   | 9. <b>LCD Display</b>                           |
| 2. <b>Message Waiting Indicator</b> | 10. <b>Select/OK</b>                            |
| 3. <b>Earpiece</b>                  | 11. <b>Off (Clear)</b>                          |
| 4. <b>Headset Jack (2.5mm)</b>      | 12. <b>Line 2 (Flash)</b>                       |
| 5. <b>Scroll Keys</b>               | 13. <b>Battery Compartment(back of Handset)</b> |
| 6. <b>Line 1 (Flash)</b>            | 14. <b>Billed Services Key</b>                  |
| 7. <b>Dialing Keys (0-9,*,#)</b>    | 15. <b>Intercom/Transfer Key</b>                |
| 8. <b>Handsfree Speakerphone</b>    | 16. <b>Microphone</b>                           |

## The Base Unit Layout

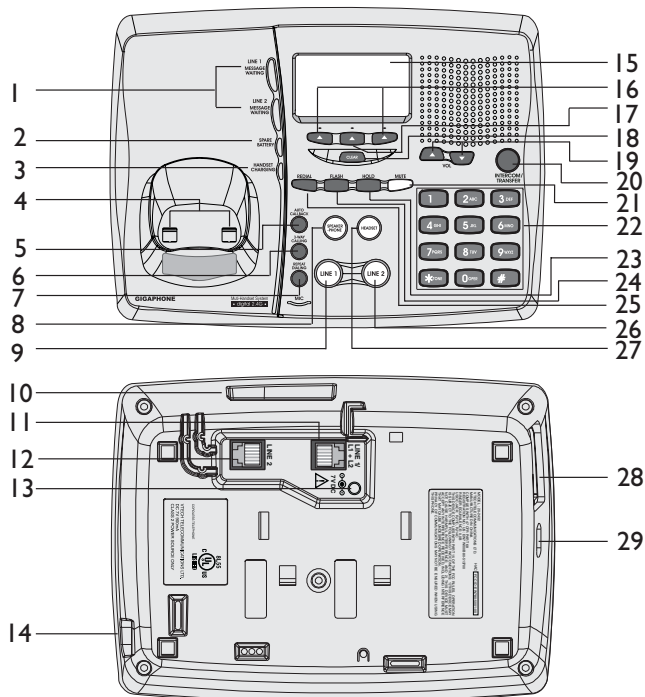

- |                                            |                            |
|--------------------------------------------|----------------------------|
| 1. Message Waiting Indicator (Line1,Line2) | 15. LCD Display            |
| 2. Spare Battery Indicator                 | 16. Scroll Keys            |
| 3. Charge Indicator                        | 17. Select Key             |
| 4. Charging Contacts                       | 18. Clear Key              |
| 5. Auto Callback Key                       | 19. Volume Keys            |
| 6. 3-Way Calling Key                       | 20. Intercom/Transfer Key  |
| 7. Repeat Dialing Key                      | 21. Mute Key               |
| 8. Speakerphone Key                        | 22. Dialing Keys (0-9,*,#) |
| 9. Line 1 Key                              | 23. Hold Key               |
| 10. Data Jack                              | 24. Flash Key              |
| 11. Line 1 Jack                            | 25. Redial Key             |
| 12. Line 2 Jack                            | 26. Line 2 Key             |
| 13. DC Connector                           | 27. Headset Key            |
| 14. Headset Jack                           | 28. Spare Battery Drawer   |
|                                            | 29. Spare Battery Release  |

## Setup

Plug the AC power adapter into an electrical outlet, and the DC connector into the back of the base unit.

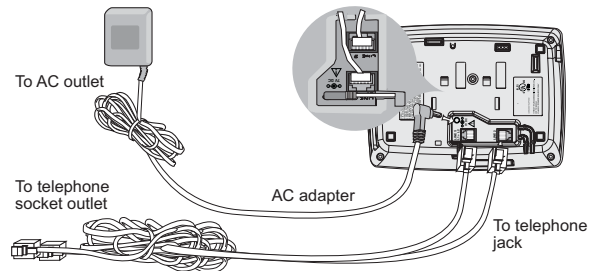

Examples of 1-Line and 2-Line Cords

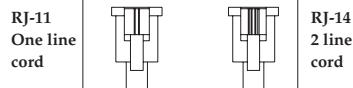

### Connecting to the telephone lines

Your 2-Line **20-2432** will work fine even if you only have one telephone line. We recommend connecting the modular telephone cord to the jack labeled **LINE 1 / L1 + L2**, located on the bottom of the Base Unit. Here are steps for connecting **2** lines:

#### If you have **2 Lines** coming out of a **Single Wall Jack**:

Connect a **4-wire** (RJ-14) modular phone cord between the wall jack and the phone jack labeled **L1 / L1 + L2**.

#### If you have **2 Lines**, each coming out of **Separate Wall Jacks**:

Connect a modular phone cord from the wall jack you want to designate as your **LINE 1**, to the **LINE 1 / L1 + L2** jack on the bottom of the Base Unit. Next, connect a phone cord from the remaining wall jack to the **LINE 2** jack on the Base Unit.

### Data Port

Your 2-Line **20-2432** has a Data Port on the back of the Base Unit. This port provides an easy way to connect your fax machine, laptop computer, modem or other telephone device for direct access to **LINE 2**.

The Data Port only provides access to Line 2, so you must have an active line connected to the **LINE 2** jack on the bottom of the Base Unit. Connect a modular phone cord from the Data Port (look for the small door marked **DATA** on the back of the Base Unit) to your fax, laptop, etc.

**NOTE:** While the Data Port is in use, accidental use of Line 2 by a parallel phone, your **20-2432**, or a Call Waiting ID alert may interrupt the data transmission.



## Installation of Battery Pack in Handset

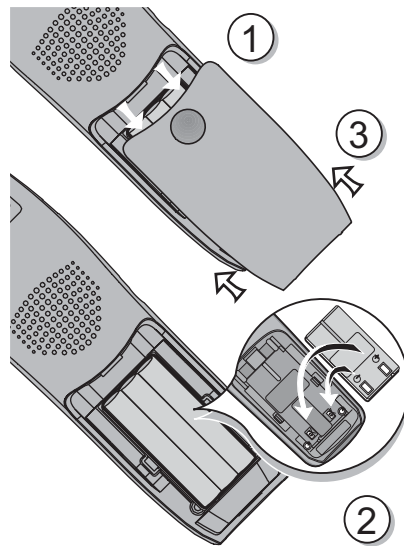

Follow the steps below:

1. Remove the battery cover by pressing on the indent and sliding downward.
2. Place the new battery pack in the handset with the metal contacts aligned with the charge contacts in the battery compartment.
3. Replace the battery cover by sliding it upwards.
4. If the new battery pack is not already charged, place the handset in the base unit, or a remote charging stand, and allow it to charge for 12 hours. After initial charge, a maintenance charge of 8 hours should be sufficient.

The original Handset that is shipped with your **20-2432** system will be automatically registered to the Base. This Handset is **HANDSET 1**.

As you register additional Handsets to the system, they will be assigned extension numbers in the following order: **HANDSET 2, HANDSET 3, HANDSET 4**, etc.

Whenever a charged Handset battery pack is installed, the Handset will automatically begin **SEARCHING FOR BASE** (if previously registered), or it will prompt you to **ENTER BASE ID** to register the new Handset. See **Registration and Operation** for details.

## Charging Of Handset Battery Pack

### Charging Of Handset Battery Pack

The Handset of your **20-2432** cordless telephone is powered by a rechargeable battery pack. It charges automatically whenever the Handset is in the Base Unit.

**You should charge the battery pack for 12 hours when you first receive your phone.** You'll know the battery pack needs charging when:

- The low battery message is displayed :
- The handset seems completely dead, the LCD is completely clear and does not activate when you press the keys.

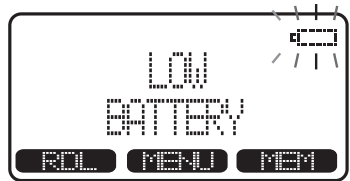

### IMPORTANT:

1. Do not dispose of a battery pack in a fire, the cell may explode.
2. Do not open or mutilate the battery pack. Toxic substances may be released, causing harm to eyes or skin.
3. Exercise care in handling battery packs in order to prevent an accidental short of the charge contacts, potentially causing the battery pack to overheat.
4. Do not dispose of this battery pack into household garbage. Contact your local recycling organization for recommended disposal sites.

## Dial Tone

### Checking for Dial Tone

After the battery is charged press a **LINE** key on the Handset. **PHONE ON** will appear on the Handset display, and you will hear dial tone. If not, see **In Case of Difficulty**.

### Tone/Pulse Selection

See **SELECT TONE/PULSE AT THE BASE UNIT** for details.

**CAUTION:** Use only the power supply provided with your cordless phone.

**IMPORTANT:  
FOR MAXIMUM PERFORMANCE OF YOUR  
CORDLESS TELEPHONE SYSTEM:**

1. Choose a central location for your Base Unit.
2. Install your Base Unit and Extension Handsets away from electronic equipment, such as personal computers, television sets and microwave ovens.
3. In locations where there are multiple cordless telephones, separate base units as much as possible.
4. Install your telephone equipment away from heat sources and sunlight.
5. Avoid excessive moisture, dust or extreme cold.

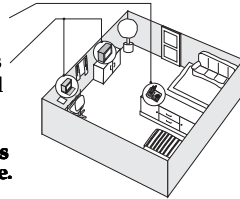

**BEFORE USING YOUR HANDSET(S), CAREFULLY PEEL OFF THE PROTECTIVE FILM, COVERING THE DISPLAY.**

## Spare Battery Charger/Power Backup Function

The **20-2432** uses the spare battery charger in the Base Unit to provide operational backup in the event of a power failure. With a fully charged battery pack in the spare battery charger, you will still be able to place and receive calls from the Handset for up to one hour. During Power Backup mode, you will not be able to use the Base Unit.

The spare battery pack can also be used to replace a drained handset battery, ensuring uninterrupted use.

### NOTE :

When using the **20-2432** during Power Backup mode, audio quality may be compromised due to reduced power availability.

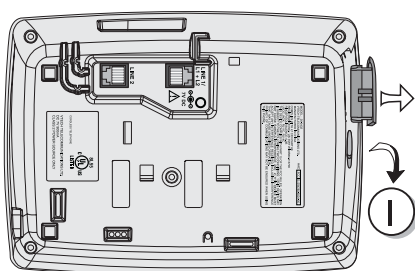

1. Open the spare battery charger by pressing the release button, located on the left-hand side of the Base Unit. A drawer will open to reveal the spare battery compartment.
2. Place a battery pack in the drawer with the charge contacts facing up and to the right.
3. Push the drawer closed.

The spare battery takes 24 hours to fully charge a drained battery.

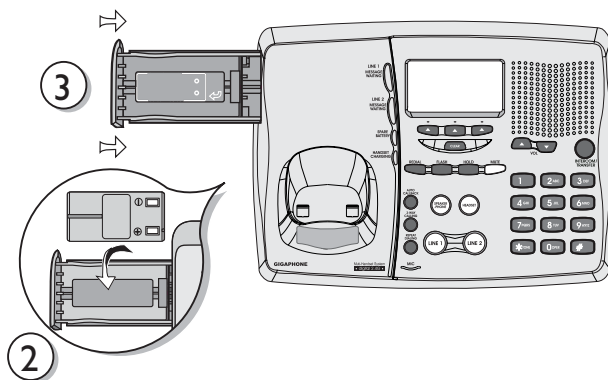

## Registration and Operation

### Registration And Operation Of The 20-2422 Accessory Handset

Your 20-2432 system can operate up to **8 Handsets**.

The accessory Handset consists of the following:

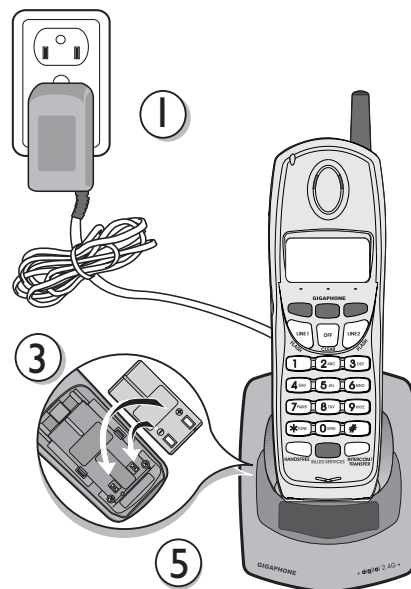
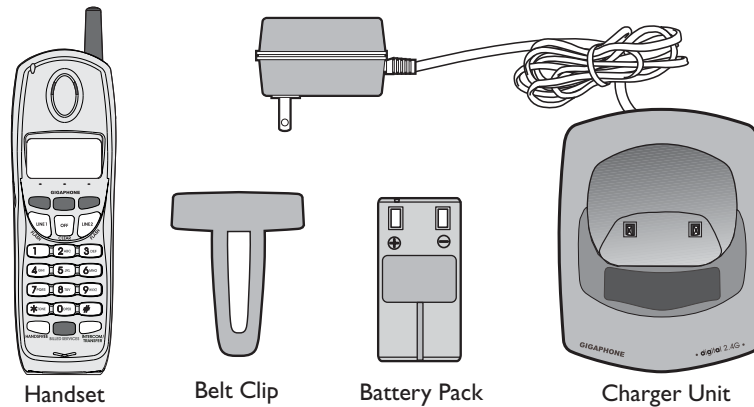

### Setup Of The 20-2422 Accessory Handset

1. Plug the AC power adapter into an electrical outlet.
2. Remove the Handset battery cover by pressing on the indent and sliding downward.
3. Place the new battery pack in the Handset, with the metal contacts aligned with the charge contacts in the battery compartment.
4. Replace the battery cover by sliding it upward.
5. Place the Handset in the Charge Cradle, and allow it to charge for 12 hours. After the initial charge, a maintenance charge of 8 hours should be sufficient.

## Registration and Operation

### Enter Base ID Code

1. After charging the Handset, remove it from its Charge Cradle; the screen will display:

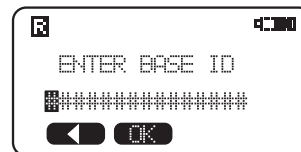

alternating with this screen:



2. If, after charging the Handset, you see:

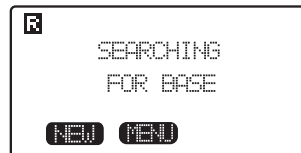

3. Press **NEW**. You will now see the **ENTER BASE ID** screen as described in step 1.

4. Find the **BASE ID Code** by doing the following: (the Base must be in idle (OFF) mode)

- A. At the **Base**, press **MENU**
- B. Scroll down to **DISPLAY BASE-ID**
- C. Press **OK**. The Base screen will display the 15-digit **ID Code**. Afterwards, it will return the idle screen.

5. Enter the 15-digit **Base ID Code** into the **Handset**; then press **OK**.

6. Wait approximately 15 to 60 seconds. You will hear confirmation beeps from the Base and Handset. The newly registered Handset will now assign itself the lowest handset number not previously assigned to a different system Handset (1 through 8).









7. If the Handset displays **REJECTED BY BASE** or continues to display **SEARCHING FOR BASE** for well beyond 60 seconds, try the registration process again by repeating the above steps.

**Congratulations!** You can now enjoy the benefits of your 2-Line Multi-Handset system.

## Handset and Base Indicators

### Handset and Base Icons

Icon	Description
	<p><u>Line In Use indicator</u> On steady with no number next to it when a parallel set is in use. On steady with one or more numbers next to it, indicating which extensions are using the line. For example,  02 indicates that Base (0) and Handset 2 are on a call on Line 1.</p>
	<p><u>Intercom indicator</u> On steady with the extension numbers currently on an intercom call. For example,  02 indicates that the Base and Handset 2 are on an intercom call.</p>
	<p><u>Battery indicator</u> (Only in Handset) Cycles (Low, Medium, and High) when Handset battery is charging. Flashes when a low battery condition is detected.</p>
<b>E</b>	<p><u>Enhanced Mode indicator</u> On steady when active Handset or Base is in Enhanced mode.</p>
<b>M</b>	<p><u>Mute indicator</u> On steady when the Handset or Base microphone is muted.</p>
<b>H</b>	<p><u>Hold indicator</u> On steady when the line is on hold.</p>
	<p><u>Handset Registration indicator</u> (Only in Handset)  is displayed when a Handset is either not registered, is searching for a Base unit.</p>
<b>P</b>	<p><u>AC Power Failure indicator</u> On steady when the AC power fails, the spare battery in the Base Unit is providing power backup.</p>

## Handset and Base Indicators

### Handset LEDs

LED	Description
Message Waiting	<ul style="list-style-type: none"><li>Flash to indicate that you have new messages in your voicemail. Service must be subscribed to through your local telephone company.</li></ul>

### Base LEDs

LED	Description
Line 1 Message Waiting/Line 2 Message Waiting	<ul style="list-style-type: none"><li>Flashes to indicate that you have new messages in your voicemail. Service must be subscribed to through your local telephone company.</li></ul>
Line 1 Line 2	<ul style="list-style-type: none"><li>Lights when line is being used by the <b>20-2432</b> system.</li><li>Flashes when another telephone on the same line (parallel extension) is in use or when line is on hold.</li></ul>
Handset Charging	<ul style="list-style-type: none"><li>Lights whenever the Handset is placed in the Base Unit charging cradle.</li></ul>
Mute	<ul style="list-style-type: none"><li>Lights when Base microphone is muted.</li></ul>
Speakerphone	<ul style="list-style-type: none"><li>Lights when Base Speakerphone is in use.</li></ul>
Spare Battery	<ul style="list-style-type: none"><li>Lights when a Spare Battery pack is charging in the Base Unit charger.</li></ul>
Headset	<ul style="list-style-type: none"><li>Lights when the Headset option is in use on the Base Unit.</li></ul>



## Soft Menu Functions

The **20-2432** has an advanced design that uses a menu structure and soft keys to access all of the built-in features.

Example of the idle mode display:



### RDL (Redial)

Press **RDL** to display the last 5 telephone numbers dialed. The number on the top line is the most recent number dialed.

- Use the **▲/▼** scroll keys to select the desired the number.
- To dial the number, you can simply press a **LINE** or the **HANDSFREE** key.
- You can erase a redial number by scrolling until it is highlighted, then press **SELECT**, and then **ERASE**.
- You can save a redial number to phone book memory by scrolling until it is highlighted, then press **SELECT**, and then press **SAVE**. Then add a name to your entry by following the instructions under **To Store a Number/Name**.

### HANDSET MENU

With the Handset in the idle (OFF) mode, press the **MENU** key to access the following options:

- **CALL HISTORY (Caller ID)**
- **HANDSET SETTINGS**
- **REGISTER**

Use the **▲/▼** scroll keys to select the desired option, then press **OK**. Press the **OFF/CLEAR** key to step back through the menu structure. Press and hold the **OFF/CLEAR** key to return to the idle menu.

### BASE UNIT MENU

With the Base Unit in the idle (OFF) mode, press the **MENU** key to access the following options:

- **CALL HISTORY (Caller ID)**
- **SETUP BASE**
- **DISPLAY BASE-ID**

Press the **CLEAR** key to step back through the menu structure. Press and hold the **CLEAR** key to immediately return to the idle menu.

## Call History (Caller ID)

### NOTES ABOUT CALLER ID & CALL WAITING CALLER ID

These are subscription services, provided by most regional telephone service providers. You must subscribe to these services to get the benefits of these features. If you do not subscribe to Caller ID services, you can still use your **20-2432** and the other features it offers.

Due to regional incompatibilities, Caller ID information may not be available for every call you receive. In addition, the calling party may intentionally block their name and phone number from being sent.

### Caller ID - Call Waiting ID

Your **20-2432** is capable of displaying the name and/or number of the party calling before you answer the phone (**Caller ID**). It is also capable of displaying Caller ID information in conjunction with a Call Waiting alert signal (**Call Waiting Caller ID**). With Call Waiting Caller ID, the Caller ID data is displayed so you can decide whether to answer the incoming call, or continue with your current conversation.

**As new Caller ID/Call Waiting ID are received, your Handset and Base displays will alert to the new, Caller ID records, for example:**

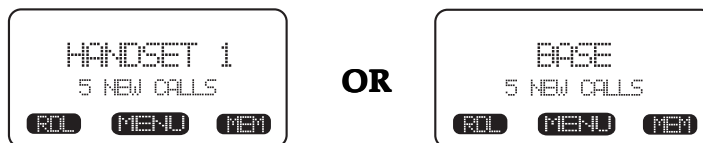

The number of new calls displayed on each system Handset and Base may not be the same. If, for example, you answer a call on **Handset 2**, that Handset will not count the Caller ID information for that call as *new*. However, the other registered Handsets and Base displays will consider it a *new call*, and add it to the **NEW CALLS** total.

After you review all new Caller ID records, the **NEW CALLS** status will be turned off.

The following information explains how to access Caller ID records (**Call History**):

From Handset or Base:

- From the idle (OFF) mode, press **MENU**. **CALL HISTORY** is highlighted. Press **OK**. The Caller ID information of the most recent inbound call will be displayed:



- For example: if the call was from Line 1:

- To view other Caller ID records, use the **▲/▼** scroll keys. You can scroll from newest to oldest record by using the **▼** scroll key, or from oldest to newest by using the **▲** scroll key.

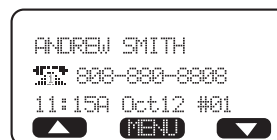

## Call History (Caller ID)

- To dial the displayed number, press the desired **LINE** key (or **HANDSFREE**) on the Handset or **SPEAKERPHONE** on the Base.
- If you need to dial the number differently than how it is displayed, press **MENU. DIAL OPTION \*** is highlighted. Press **OK**.
- Scroll to the desired dialing option, then press **DIAL** or the desired **LINE** (or **HANDSFREE**) on the Handset or **SPEAKERPHONE** on the Base to dial.

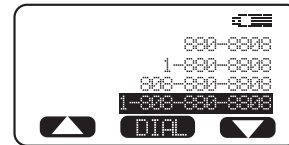
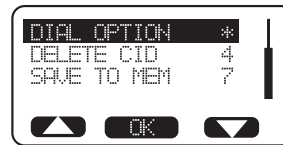

### DIAL OPTION SHORTCUT

With a Caller ID record displayed, press **\***. The 4 possible dialing options are displayed. Scroll to the desired dialing option, then press **DIAL**, or the desired **LINE** key (or **HANDSFREE**) on the Handset or **SPEAKERPHONE** on the Base to dial.

You can also **delete** and **save** Caller ID records in the Directory:

### DELETE

With a Caller ID record displayed, press **MENU**.

Scroll to **DELETE CID 4**. Press **OK**.

The CID record is displayed, with the choices **THIS** (delete only this record) and **ALL** (delete all CID records).

If you press **THIS**, the displayed CID records will be deleted, and you will hear a confirmation beep.

If you press **ALL**, the screen will ask you **Are You Sure?** If you're sure, press **YES**, and all CID records will be deleted. If you decide not to delete all CID records, press **NO**.

### DELETE SHORTCUT

With a Caller ID record displayed, press **4**.

The CID record is displayed, with the choices **THIS** (delete only this record) and **ALL** (delete all CID records).

If you press **THIS**, the displayed CID records will be deleted, and you will hear a confirmation beep.

If you press **ALL**, the screen will ask you **Are You Sure?** If you're sure, press **YES**, and all CID records will be deleted. If you decide not to delete all CID records, press **NO**.



## Handset and Base Settings

### SAVE TO MEMORY

To save a displayed Caller ID record into the directory, press **MENU**. Scroll to **SAVE TO MEM 7**. Press **OK**. **-OR-**

With the CID record displayed, press **7**. The record has been stored in the directory.

If the record you wish to save does not have a name (OUT OF AREA, for example), the screen will ask you to **PLEASE ENTER A NEW NAME**. Use the keypad to enter the name, then press **SAVE**. A guide to the letters and characters can be found in the section entitled **Memory**.

### • RINGERS

**NOTE:** The Handset and Base ringers are adjusted separately. In addition, each line is adjusted separately.

#### Handset:

Press **MENU**, scroll to **HANDSET SETTINGS**, then press **OK**.



**RINGERS** will be highlighted; press **SET**.

Highlight the desired adjustment, then press **SET**.

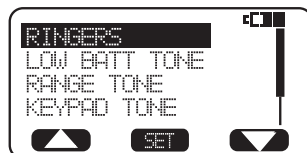

**VOLUME :** Use **◀/▶** to sample the choices of loudness. There are five: OFF, LOW, MEDIUM, MEDIUM-HIGH and HIGH. Press **OK** to confirm your selection.

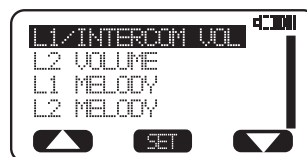

**MELODY :** Use **[-]/[+]** to sample the six melodies. Press **SAVE** to confirm your selection.

#### Base Unit:

Press **MENU**, scroll to **SETUP BASE**, then press **OK**. Now follow the same procedure used for the Handset Ringers.

## Handset and Base Settings

---

- **LOW BATT TONE (Handset only)**

Select this option to turn the Low Battery warning tone On or Off. Press the **OFF** or **ON** soft keys, to make your selection. Press **OK** to confirm your selection and return to the Handset Settings menu. When set to **ON**, the Handset will emit a warning tone when a Low Battery condition is detected. This feature has been preset to **ON** at the factory.

- **RANGE TONE (Handset only)**

Select this option to turn the Out of Range warning tone On or Off. Press the **OFF** or **ON** soft keys, to make your selection. Press **OK** to confirm your selection and return to the Handset Settings menu. When set to **ON**, the Handset will emit a warning tone whenever the Handset is taken out of range of the Base. This feature has been preset to **ON** at the factory.

- **KEYPAD TONE**

**Handset:**

Select this option to turn the Keypad tones On or Off. Press the **OFF** or **ON** soft keys, to make your selection. Press **OK** to confirm your selection and return to the Handset Settings menu. When set to **ON**, the Handset will emit a beep whenever a key is pressed. This feature has been preset to **ON** at the factory.

**Base Unit:**

Press **MENU**, scroll to **SETUP BASE**, then press **SET**. Scroll to **KEYPAD TONE**; press **OK**. Choose **ON** or **OFF**, then press **OK** to confirm your choice.

- **CONTRAST**

**Handset:**

Select this option to adjust the contrast level of the Handset display. Use the **◀/▶** scroll keys to make your selection. The handset display will automatically adjust as you make your selection. Press **OK** to confirm your selection and return to the Handset Settings menu.

**Base Unit:**

Press **MENU**, scroll to **SETUP BASE**, then press **SET**. Scroll to **CONTRAST**; press **OK**. Press **↑** and **↓** to adjust the screen contrast, then press **OK** to confirm your choice.

- **SELECT TONE / PULSE AT THE BASE UNIT**

- With the Base Unit in the idle (OFF) mode, press **MENU**.
- Scroll to **SETUP BASE**, then press **OK**.
- Scroll to **SET PULSE/TONE**, then press **SET**.
- Scroll to the desired line; press **SET**.
- Use the **UP** and **DOWN** arrow keys to highlight the desired dialing mode - **TONE** or **PULSE**. Press **OK** to confirm your choice.

NOTE: Your **20-2432** is preset for **TONE** dialing, the desired mode for most areas.

## Handset and Base Settings

---

### • ENHANCED MODE

Your **20-2432** has an enhanced feature, designed to improve sound quality and range. If you are using your **20-2432** in an area with interference, the Enhanced Mode feature can help to improve both the sound quality and operating range. Actual range will depend on your environment. You can manually turn Enhanced Mode **ON** and **OFF**, or select **AUTO** mode.

#### To select the Enhanced Mode setting:

With the Handset in the idle (on hook) mode, press **MENU**.  
Scroll to **HANDSET SETTINGS**, then press **OK**.  
Scroll down to **ENHANCED MODE**, press **SET**.

Select **ON** to enable Enhanced Mode. When the Handset is in use, an 'E' icon will appear in the upper left corner of the display, indicating that this feature is active.

Select **OFF** to disable Enhanced Mode.

Select **AUTO** to allow your **20-2432** Handset to activate this feature automatically, when conditions warrant it. Your 2-Line **20-2432** is preset at the factory for **AUTO** mode.

Scroll to the desired setting, then press **OK**.

You can also activate Enhanced Mode from the Base Unit. In which case, all registered Handsets will have the same Enhanced Mode setting. With the Base in the idle (OFF) mode, press **MENU**, scroll down to **SETUP BASE**, press **OK**, scroll down to **ENHANCED MODE**, press **SET**, scroll to the desired setting, then press **OK** to confirm your choice.

---

**NOTE:** When Enhanced Mode is activated, your **20-2432** will consume more battery power. This means the standby and talk time of your Handset(s) will be shorter.

---

### • RENAME

#### Naming Your Handset(s)

You can personalize each Handset, giving it a name (Dad's Phone, or Mary's Office, for example) instead of **HANDSET 1**, etc.

With the Handset in the idle (on hook) mode:

- Press **MENU**.
- Scroll to **HANDSET SETTINGS**, then press **OK**.

## Handset and Base Settings

---

- Scroll to **RENAME**, then press **SET**.
- Using the dialing keys, enter the desired name. A guide to the letters and characters can be found in the section entitled **Memory**. The softkey  will move the cursor to the right. Press **MORE** to give you the **DEL** (delete) and **SPACE** options. Press **BACK** to return to the previous screen.
- Press **SAVE** to confirm your Handset name.



You can also name the Base Unit. At the Base, in the idle (OFF) mode, press **MENU**, scroll down to **SETUP BASE**, then press **OK**. Scroll down to **RENAME**, press **SET**, then follow the same steps as above for entering the desired name.

## Register

---

### Handset Deregistration

You can deregister all Handsets at one time. This causes the Base Unit to 'forget' that it has any Handsets at all. You may never have to perform this procedure. One possible reason for deregistration is if you have the maximum number of Handsets (8) registered to your Base, and one Handset should require replacement, the Base will not register the 'new' Handset, because its eight memory slots are occupied. The deregistration procedure will clear the Base Unit's memory, and you will be able to register each Handset again. Individual Handsets cannot be deregistered.

---

**CAUTION: Once you deregister, your Handsets will not be capable of making or receiving calls. You will need to re-register each Handset, one at a time!!**

---

#### To Deregister all Handsets:

- At the Base Unit, in the idle (OFF) mode, press **MENU**.
- Scroll down to **SETUP BASE**, then press **OK**.
- Scroll down to **DEREGISTER ALL**, then press **SET**.

All system Handsets have been deregistered. To register your Handsets again, see **Registration and Operation**, located in the **Getting Started** section of the User's Manual, for details.

### Register

Use this option to register a Handset to the **20-2432** Base. You can register a total of eight Handsets to the **20-2432** Base. This process is activated automatically whenever a new handset is powered up in range of the **20-2432** Base.

You will be prompted to enter the 15-digit Base ID code. See **Registration and Operation**, located in the **Getting Started** section of the manual, for details.

**Note :** Base ID codes are 15 digits long and can include the following characters: 0, 1, 2, 3, 4, 5, 6, 7, 8, 9, or \* .



## Memory

---

### Memory

The Base and each Handset can store up to 50 names/numbers in memory. Each memory location can hold up to 32 digits and up to 16 characters for the name.

When prompted to **ENTER NAME**, use the digit keys to 'spell' the name. Each press of a particular key causes characters to be displayed in the following order:

Number Key	Characters (in order)
1	& ' , . 1
2	A B C a b c 2
3	D E F d e f 3
4	G H I g h i 4
5	J K L j k l 5
6	M N O m n o 6
7	P Q R S p q r s 7
8	T U V t u v 8
9	W X Y Z w x y z 9
0	0
*	*
#	#

# Memory

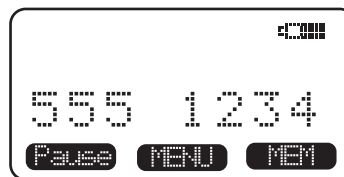
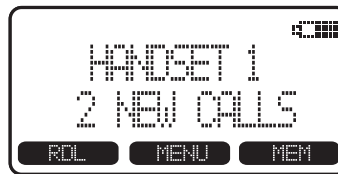

## To Store a Number/Name:

- Starting from the idle screen, enter the number you want to store in memory. If you make a mistake, press **CLEAR** to backspace.
- Be sure to include long distance codes and pauses, (using the **Pause** softkey) if necessary. Press the **MEM** softkey.
- You will then be prompted to **ENTER NAME**. Use the digit keys to 'spell' the name. If you make a mistake, press the **CLR** softkey. To enter a space press **▶**. When finished, press **SAVE**.
- If there is space available in memory, the number/name will be saved and the Handset will return to idle mode.
- If the memory is full the Handset will display **PHONEBOOK IS FULL** and exit to the pre-dial screen without saving the entry.
- Follow the above procedure for storing Number/Names at the Base. The Handset and Base have separate memories.



## Memory

### To Search For and Dial a Number/Name:

- Starting from the idle screen, press the **MEM** softkey to review memory contents.
- Using the  /  softkeys scroll through the memory contents in alphabetical order.
- Or, you can press the **FIND** softkey, enter the first few characters of the name and then press **FIND** to search. If you make a mistake, press **CLR** softkey. The closest match, in alphabetical order, will be displayed.
- Once you find the entry you want, simply press a **LINE** key (or **HANDSFREE**) on the Handset or **SPEAKERPHONE** on the Base to dial the number.

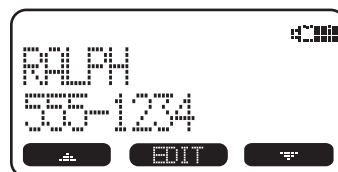
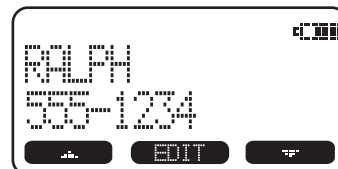
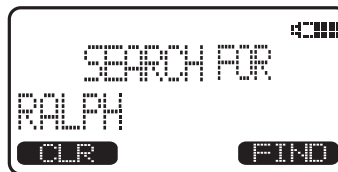
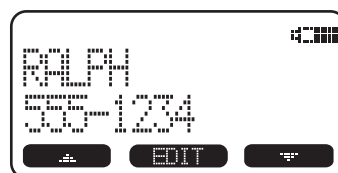

### To Delete a Number/Name:

- Using the steps from 1 to 3 in **To Search For and Dial a Number/Name**, locate the entry you want to delete.
- Press the **EDIT** softkey. The Handset or the Base will display:

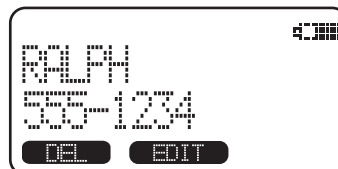

## Memory

- Press the **DEL** softkey. The Handset or the Base will display:
- To delete this record, press **THIS**.
- To delete all records, press **ALL**. To confirm the deletion of **ALL** records, press **YES**. To exit without deleting, press **NO**.

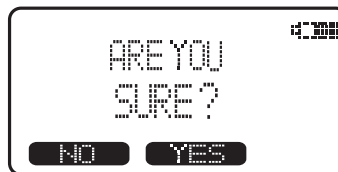
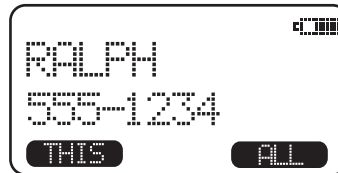

### To Edit a Number/Name

- Using the steps from 1 to 3 in **To Search For and Dial a Number/Name**, locate the entry you want to edit.
- Press the **EDIT** softkey **twice**. The Handset or the Base will display:
- Select **NAME** or **NUM**. Using the  softkey move the cursor to the character you want to edit and then enter the corrections as needed. Press **MORE** to access **DEL**, **BACK** and **PAUSE/SPACE** functions. When finished press the **SAVE** softkey. To exit without saving press **OFF**.
- When finished the Handset or the Base will display the edited entry.

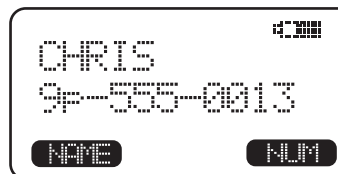
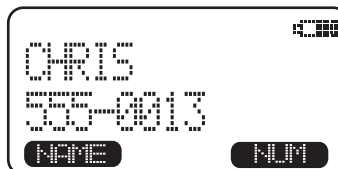
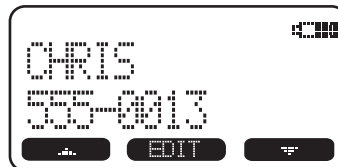

## Handset and Base Operation

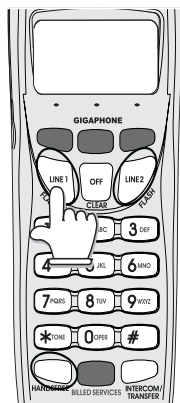

### Making Calls

#### From the Handset

- Press a **LINE** key (or, **HANDSFREE** to use the Handset Speakerphone feature).
- Dial the phone number.
- **- OR -**
- Dial the phone number first; then press a **LINE** key (or **HANDSFREE**).

#### From the Base Unit

- Just like the Handset, you can either access a dial tone first, then dial your number, or you can dial your number first, then access a line.
- With both lines idle, pressing **SPEAKERPHONE** (or **HEADSET** if you are using a headset connected to the Base) will access **LINE 1**.
- If you want to access **LINE 2** with both lines idle, press the **LINE 2** key first, then press **SPEAKERPHONE** (or **HEADSET**).
- If one line is **IN USE**, press **HOLD**, then press **SPEAKERPHONE** (or **HEADSET**) will automatically access the idle line.
- If both lines are **IN USE** (2 or more system Handsets are active, with at least one on each line), pressing **SPEAKERPHONE** (or **HEADSET**) will access the current line.

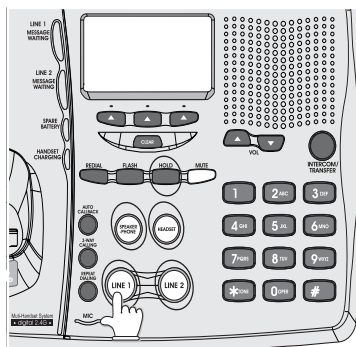

### Redial

#### From the Handset

Each system Handset and Base Unit will remember the last **5** phone numbers dialed. From the *idle* mode, press **RDL**. Scroll until the desired phone number is highlighted. Then press the appropriate **LINE** key to dial the number ( follow the above instructions in **Making Calls**). You can also **delete** and **save** 'redial' numbers in the **Directory**.

# Handset and Base Operation

---

## **ERASE**

Press **RDL**. Scroll to the desired phone number, press **SELECT**, then press **ERASE**.

## **SAVE**

Press **RDL**. Scroll to the desired phone number, press **SELECT**, then press **SAVE**.

You'll then be prompted to **ENTER NAME**. Use the keypad to enter the letters of the name. If you make a mistake, press **CLR** to backspace. To insert a space, press **⏏**. When finished, press **SAVE**.

For more information on entering phone numbers into the Directory, see the section entitled **Memory**.

## **From the Base Unit**

- Follow the same procedure used for the Handset Redial.
- - OR -
- Press the appropriate **LINE** key and then **SPEAKERPHONE** (or **HEADSET**), then press **REDIAL** key to dial the last number in the Base Unit redial memory.

## **Answering Calls**

### **From the Handset**

Press the appropriate **LINE** key, or **HANDSFREE** to use the Handset Speakerphone option.

If the Handset is active on one line when the idle line rings, you will hear a special alert tone, signifying an inbound call. This alert is designed to minimize disruption of the call in progress. You can then:

- Press **OFF** twice to end the first call, then press the appropriate **LINE** key (or **HANDSFREE** to use the Handset Speakerphone option) to answer the new call;
- - OR -
- Press the appropriate **LINE** key to answer the new call. The original call will automatically be placed on **HOLD**. You can end the 'new' call by pressing **OFF**, then return to the original call by pressing the appropriate **LINE** key.

You can also Conference both lines together. See **Conference Calling**, further on in this User's Manual.

### **From the Base Unit**

If a line is ringing, pressing **SPEAKERPHONE** (or **HEADSET** if you are using a Headset connected to the Base) will answer the inbound call.

Press **SPEAKERPHONE** (or **HEADSET**) to end your call.

## Handset and Base Operation

If the Base is active on one line when the idle line rings, you will hear a special alert tone, signifying an inbound call. This alert is designed to minimize disruption of the call in progress. You can then:

- Press **SPEAKERPHONE** (or **HEADSET** if you are using a Headset connected to the Base) to end the first call, then Press **SPEAKERPHONE** or **HEADSET** to answer the new call;
- OR-
- Press the **HOLD** soft key to place the original call on hold. After that, press the appropriate **LINE** key and then **SPEAKERPHONE** (or **HEADSET**) to answer the new call. You can end the "new" call by pressing **SPEAKERPHONE** (or **HEADSET**). Return to the original call by pressing the appropriate **LINE** key and then **SPEAKERPHONE** (or **HEADSET**).

You can also Conference both lines together . See **Conference Calling**, further on in this User's Manual.

### Mute Function

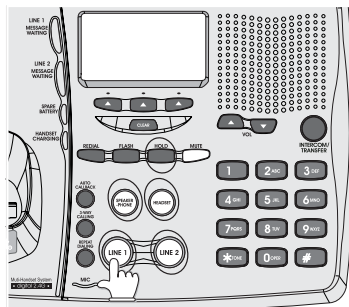
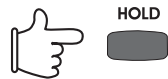
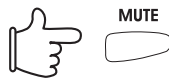

### Flash Function

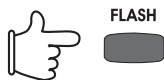

During an active call pressing either the **MUTE** soft key on the Handset or the **MUTE** key on the Base (when in Speakerphone or Headset mode), will disable the microphone. Press **MUTE** again to return to the 2-way conversation.

### Hold Function

#### From the Handset :

- Press the **HOLD** soft key to place a call on hold. To return to the call press the appropriate **LINE**.

#### From the Base :

- During an active call, press the **HOLD** key to place a call on hold. The **LINE** key will flash to indicate a call is on hold.
- To return to the call press the appropriate **LINE** and then press **SPEAKERPHONE** (or **HEADSET**).

You can use your **20-2432** with services such as call waiting. Simply press the **LINE** key on the Handset or the **FLASH** key on the Base (when in Speakerphone or Headset mode) to flash the line.

# Handset and Base Operation

## Adjusting Handset Volume (also applies to the Handset Speakerphone)

**NOTE:** The Handset must be IN USE to adjust the volume.

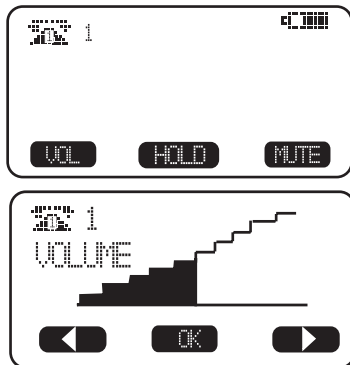

- Press the **VOL** key, located directly below the lower left corner of the display.
- Use the keys directly below the **←** / **→** symbols on the display to raise or lower the Handset volume. Notice the change in the display graph as you adjust the volume. An increase in volume will be represented by an increase in shaded area on the graph. A decrease in volume will result in a reduction of the shaded area.
- Press the **OK** key (top, center) to confirm your adjustment.

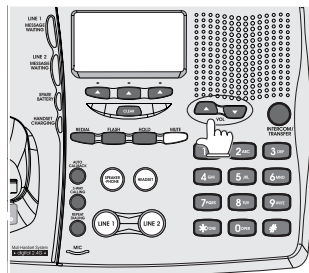

## Base Speakerphone or Headset Volume

- During an active call simply press the Volume **UP** or **DOWN** keys to adjust the Speakerphone or Headset volume. When reach the maximum or the minimum, a triple beep sounds.

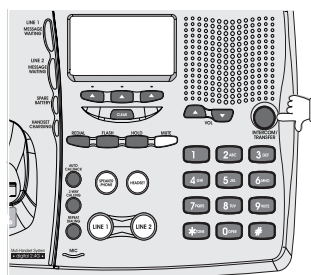

## Intercom/Transfer Function

Press **INTERCOM/TRANSFER** on any Handset or Base registered to your 2-Line 20-2432 system, or the Base Unit.

The screen will display your options, for example:

<b>BASE</b>	<b>0</b>
<b>HANDSET 1</b>	<b>1</b>
<b>HANDSET 2</b>	<b>2</b>
<b>HANDSET 3</b>	<b>3</b>
<b>GLOBAL PAGE</b>	<b>*</b>





## Handset and Base Operation

Highlight the desired destination of your **intercom** then press **OK**. Your screen will display **CALLING HANDSET \_**, **CALLING BASE**, or **PERFORMING GLOBAL PAGE**.

The recipient's screen will display **INTERCOM FROM HANDSET\_**, **INTERCOM FROM BASE** or **GLOBAL CALL FROM HANDSET\_**, or **GLOBAL CALL FROM BASE**.

The recipient presses **INTERCOM/TRANSFER** on the Handset or Base to engage in conversation with the person initiating the page.

**NOTE:** When you initiate a **GLOBAL PAGE**, the first recipient to respond by pressing **INTERCOM/TRANSFER** on the Handset or Base will be able to talk to you via the intercom. Others can join the ongoing intercom call by calling one of the parties involved in the intercom. The unit beeps whenever a party joins an ongoing call.

### Transferring Calls

You can transfer calls on the **20-2432** system from the Base to Handset, Handset to Handset, or Handset to Base.

#### Blind Transfer

You can directly transfer any active call to another **20-2432** extension without notification by doing the following steps:

- Handset or Base must be on an active call.
- Press the **INTERCOM/TRANSFER** on the Handset or Base; scroll to the desired destination of your transfer. Then press **OK**.
- When the other extension answers, the call will automatically be connected to that extension.
- An unanswered call will be placed on hold to the originating Handset/Base if not answered within 30 seconds and ring back in 5 minutes.

#### Announced Transfer:

You can perform an announced transfer (call and advise another extension) of an active call by doing the following steps:

- Handset or Base must be on an active call.
- Place the active call on **HOLD**.
- Press the **INTERCOM/TRANSFER** on the Handset or Base; scroll to the desired destination of your transfer. Then press **OK**.
- When the other extension answers the intercom call, explain they have an active call waiting.
- Either extensions press **INTERCOM/TRANSFER** on the Handset or Base to end the intercom call.
- The other extension presses the appropriate **LINE** key (or the appropriate **LINE** key then **HANDSFREE**) on the Handset, or the appropriate **LINE** key then **SPEAKERPHONE** (or **HEADSET**) on the Base to pick up the call on hold.

### Handsfree Speakerphone Operation

Your **20-2432** Handset has a built-in handsfree Speakerphone. This feature allows you to stand the Handset upright on a table or desktop and have handsfree conversations. For more information, refer to **MAKING CALLS** in **HANDSET AND BASE OPERATION**.

# Handset and Base Operation

## Switching from the Handset Earpiece to Handsfree

While on a call using the Handset earpiece, press **HANDSFREE** on the lower left portion of the Handset.

To return to the Handset earpiece, press **HANDSFREE** again.

## Base Speakerphone Operation

The Base of your **20-2432** is equipped with a duplex Speakerphone. This is a very useful feature for handsfree conversations or conference calls at the base unit. For more information, refer to **MAKING CALLS in HANDSET AND BASE OPERATION.**

### Line in Use Indication Active (off-hook) Handsets:

During a call, the Handset/Base screen will display, in the upper left corner, the **LINE** icon(s) and the **HANDSET/BASE** number(s) (1 – 8; 0 for the Base) currently in use.



### Idle (on-hook) Base Unit:

During a call, the idle Base screen will display, in the upper left corner, the **LINE** icon(s) and the **HANDSET** number(s) currently in use.

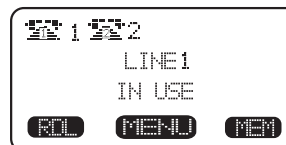

### Idle (on-hook) Handsets:

During a call, the idle Handset(s) will display:

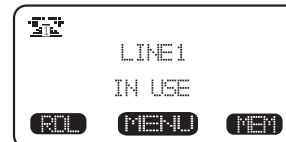

When one or both lines are currently in use by a parallel set (a telephone device other than your **20-2432** system), all registered Handsets and Base will display:

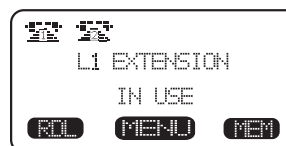

When both lines are in use at the same time, the **L\_EXTENSION IN USE** message will alternate between **1** and **2**.

## Low Battery Indication

When a low battery is detected, the Battery icon will flash and a warning beep is played. The status message **LOW BATTERY** will also be displayed when the Handset is in idle mode. To prevent an unexpected call drop, a drained Handset battery should be replaced by a fully charged spare battery.

## Handset and Base Operation

### Message Waiting Indication

The **20-2432** is compatible with optional voicemail service provided by some local telephone companies. If you subscribe to this service, and you have new, unplayed messages in your voicemail, a Visual Message Waiting Indicator (VMWI) signal is transmitted by your local telephone company.

The **20-2432** will detect a VMWI signal and activate the LINE1/LINE2 Message Waiting lights on the Base and the Message Waiting light on the Handset. In addition, your screen will display:





After you check your messages, the Message Waiting indicators will automatically turn off.

Please note that whenever new, unplayed messages are stored in your voicemail, the local Telephone Company will continue to send a VMWI signal.



### Conference Calling

The **20-2432** is capable of supporting conference calls with up to **two** registered Handsets on each line, and the Base unit.

To enter a conference call, simply access the line with two or more extensions by pressing an appropriate **LINE** key (or an appropriate **LINE** key then **HANDSFREE**) on the Handset, or an appropriate **LINE** key, then **SPEAKERPHONE** (or **HEADSET**) on the Base.

The phone icon   and extension numbers of all local participants will be displayed in the upper left corner of the Handset LCD or the Base **LCD**.

### 2-LINE Conference Calls (Handset or Base)

- Make or answer a call on **LINE 1** or **LINE 2**. Place the call on **Hold**.
- Make or answer a call on the other line. Press **CONF** on the Base or **MORE** then **CONF** on the Handset. You and your parties on **Lines 1** and **2** are now on a 3-way call.
- Press **LINE 1** or **LINE 2** on any other system Handset to join the Conference call.
- Press **SPEAKERPHONE** ( or **HEADSET** ) on the Base to join the Conference call.
- To drop a **LINE** from the Conference call, press **DROP** on the Base or **MORE** then **DROP** on the Handset. Your screen will display **DROP LINE 1**, **DROP LINE 2** and **DROP BOTH LINES**. Using the  /  softkeys scroll to the desired option. Then press **OK**.

## Custom Pay-Per-Use(PPU) Features

Press **BILLED SERVICES** on the Handset, or the 3 dedicated keys on the Base Unit to access the following features:

### **AUTO CALLBACK 3-WAY CALLING REPEAT DIALING**

**AUTO CALLBACK** dials the last party who called you, whether or not you answer the call. A charge may be added to your phone bill each time you use this feature.

**From the Handset:** In the idle (Off) mode, press **BILLED SERVICES**. With **AUTO CALLBACK** highlighted, press the desired **LINE** key.

**From the Base Unit:** In the idle (Off) mode, press the desired **LINE** key, then press **AUTO CALLBACK**.

**3-WAY CALLING** allows you to talk with 2 separate parties from a single line.

#### **From the Handset:**

1. While you are on an active call, press **BILLED SERVICES**.
2. Scroll down to **3 WAY CALLING**, then press **DIAL**.
3. Listen for a dial tone, then dial your second party. After your party answers, press **BILLED SERVICES**, scroll down to **3 WAY CALLING**, then press **DIAL** again. You are now connected to both parties.

#### **From the Base Unit:**

1. While you are on an active call, press **3-WAY CALLING**.
2. Listen for a dial tone, then dial your second party. After your party answers, press **3-WAY CALLING** again. You are now connected to both parties.

**REPEAT DIALING** repeatedly dials the last number you called, over a time interval determined by your local phone company. This is useful in reaching a party whose line is busy. A charge may be added to your phone bill each time this service is used.

**From the Handset:** In the idle (Off) mode, press **BILLED SERVICES**. Scroll down to **REPEAT DIALING**, then press the desired **LINE** key. Once you hear dialing, press **OFF**. If your party answers during the repeat dialing interval, your phone will ring to alert you.

**From the Base Unit:** In the idle (Off) mode, press the desired **LINE** key, then press **REPEAT DIALING**. Once you hear it dialing, press **SPEAKERPHONE**. If your party answers during the repeat dialing interval, your phone will ring to alert you.

**NOTE:** It is likely that your local telephone company will assess charges to use custom features. You should check with your local service provider regarding which custom services are available in your area, and the associated costs for the intentional or unintentional use of Pay Per Use services.

Your local telephone company may provide a monthly subscription to an individual service or a package of services which gives you unlimited usage for a small monthly fee.

## Additional Services

---

Qwest offers a variety of optional calling services. For information on the prices and availability of these and other services in your area, or for additional instructions on using these services, call the number appropriate number referenced below.

### Caller ID

Lets you know who is calling before you answer the phone.

#### To Block Anonymous Calls

1. Use Anonymous Call Rejection, a free service for Caller ID customers, by accessing dial tone and dialing \*77.
2. Anonymous Call Rejection informs callers who have blocked their name and number that he party they are trying to reach does not accept blocked calls. The blocked caller is informed they can unblock their call by hanging up and dialing \*82.
3. To cancel Anonymous Call Rejection, dial \*87.

### Caller ID Blocking Options

Because there way be occasions when you want to call without having your name or number displayed, the following options are available:

#### Per Call Blocking

Blocks your name and number on a per call basis. To use, dial \*67 before you dial the phone number you are calling. There is no charge to use Per Call Blocking, and it is automatically on your line.

#### Line Blocking

Blocks your name and number on all the calls you make unless you unblock with \*82. Line blocking is automatic once you have requested that it be added to your line. To remove blocking on just one call, dial \*82. This will allow your name and number to display on just that one call.

### Call Waiting

A short tone signals that another person is trying to call you when you are on the phone. You can put one call on hold while handling the second call, or alternate between the two.

#### To Use Call Waiting

1. When you hear a brief tone during a call, quickly press the FLASH key on your phone.
2. To return to the first call, or alternate between calls, press the FLASH key again

#### To Cancel Call Waiting

1. Before making a call, dial \*70 on your phone. You will hear three short tones followed by a dial tone.
2. Place your call.
3. Call Waiting is automatically restored when you hang up.

### Call Waiting ID

Has all the benefits of Caller ID and it also lets you identify your Call Waiting calls before you answer.

# Additional Services

---

## Voice Messaging Service

Voice Messaging Service records your incoming calls when you cannot answer, or when you line is busy.

### To Establish Your Voice Messaging Service

The first time you call your Voice Messaging Retrieval number, follow these five easy steps. Voice instructions will guide you through the process.

1. Call your Voice Messaging Retrieval number provided by your Business Office or Customer Training Center. If you do not know your retrieval number, call 1-800-669-7676 (home), or 1-800-776-2777 (business).
2. Then enter your temporary security code 1-2-3-4.
3. Then enter your permanent security code.
4. Then record your name.
5. Then choose your greeting.

## Call Forwarding

Lets you temporarily forward calls to another number you select.

### To Use Call Forwarding

1. Dial \*72 on your telephone.
2. When you hear a second dial tone, dial the number where you want the calls to go. Wait for that person to answer.
3. If the line is busy or no one answers, hang up and repeat steps 1 and 2. Two quick tones indicate that Call Forwarding is working.
4. Check that your calls will be forwarded by dialing \*72. A busy signal indicates Call Forwarding is working.
5. Cancel Call Forwarding by dialing \*73. Two quick tones followed by dial tone means your calls are no longer being forwarded.

## Call Rejection

With Call Rejection, you can avoid unwanted calls.

### To Use Call Rejection

1. To block unwanted calls, dial \*60 and follow the record instructions.
2. If you do not know an unwanted callers number, activate Call Rejection immediately after hanging from their call.
3. To cancel Call Rejection, press \*80.

## Call Trace

With Call Trace you can receive assistance from Qwest or your local police department if you receive harassing obscene telephone calls. This service is available to most customers on a pay per use basis.

### To Use Call Trace

1. Dial \*57 immediately after hanging up from the call to be traced.
2. Follow the recorded to take appropriate action.
3. The telephone number of the caller will be recorded by Qwest. Deterrent action can be taken by Qwest or your local law enforcement agency after 3 calls from the same number are identified.
4. You will not be given the name or telephone number of the person who called you.
5. If it becomes a life threatening situation contact the police immediately.

## Additional Services

---

### Priority Call

#### To Use Priority Call

1. You can store up to 15 different numbers.
2. To establish or change your priority, simply dial \*61 and follow the recorded instructions.
3. To cancel Priority Calling, press \*81.

### Selective Call Forwarding

Selective Call Forwarding transfers calls from specific numbers to another phone number of your choice.

#### To Use Selective Call Forwarding

1. Dial \*63 and follow the recorded instructions.
2. To cancel Selective Call Forwarding, dial \*83 and follow the recorded instructions.

### Speed Calling

Allows you to reach 8 or 30 frequently called numbers by dialing just one or two digits instead of the entire phone number.

#### To Program Speed 8

1. Assign a single digit code from 2 through 9 for each phone number.
2. Dial \*74, enter the assigned, followed by the phone number. A tone indicates the number has been stored.

#### To Program Speed 30

1. Assign a two digit code from 20 through 49 for each phone number.
2. Dial \*75, enter the assigned code, followed by the phone number. A tone indicates the number has been stored.

**Remember to include the area code for long distance calls**

#### To Use Speed Calling

Dial the selected code, followed by #.

## Headset Operation

Your **20-2432** Handset is equipped with a 2.5mm Headset Jack for use with an optional accessory Headset for hands-free operation. If you choose to use the Headset option, you must obtain an optional accessory Headset, which is compatible with the **20-2432**.

**To purchase a Headset, please call 1-800-651-6791.**

Once you have a compatible 2.5mm Headset, locate the Headset Jack on the **20-2432** Handset. Connect the plug on the Headset cord to the jack (under a small rubber flag) on the cordless Handset. The plug should fit securely. Do not force the connection.

### Headset Operation connected to the Handset

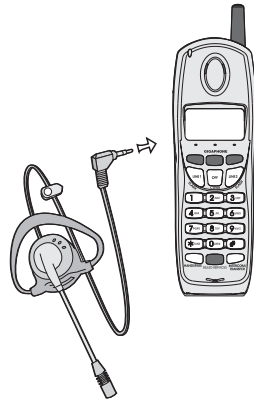

#### NOTE :

Whenever a compatible Headset is connected to the cordless Handset, the microphone on the Handset will be muted. This is done to limit the effect of background noise.

### Headset Operation connected to the Base Unit

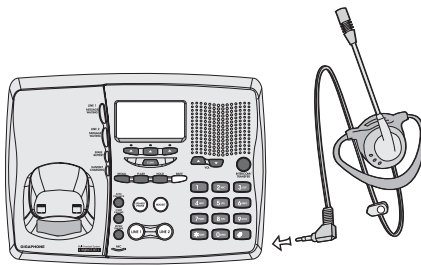

The same type of Headset can be connected to the Base Unit. Facing the Base, the Headset jack can be found on the near corner of the right side panel. When using a Headset attached to the Base, calls are made and answered by pressing the **HEADSET** key. This key is also used to end your call. The Base Speakerphone and Base Headset cannot be used simultaneously. However, you can switch between the two modes by pressing **SPEAKERPHONE** and **HEADSET** without disconnecting your Headset.

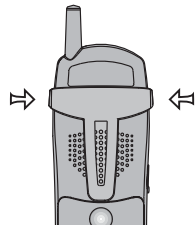

### Belt Clip

The **20-2432** is also equipped with a detachable belt clip. Align the pins on the inside edge of the clip with the notches on the sides of the **20-2432** Handset. The belt clip should snap securely into place. Do not force the connection.



## Maintenance

---

### Taking Care Of Your Telephone

Your **20-2432** cordless telephone contains sophisticated electronic parts, so it must be treated with care.

#### Avoid rough treatment

Place the Handset down gently. Save the original packing materials to protect your telephone if you ever need to ship it.

#### Avoid water

Your telephone can be damaged if it gets wet. Do not use the Handset outdoors in the rain, or handle it with wet hands. Do not install your Base Unit near a sink, bathtub or shower.

#### Electrical storms

Electrical storms can sometimes cause power surges harmful to electronic equipment.

For your own safety, use caution when using electric appliances during storms.

#### Cleaning your telephone

Your telephone has a durable plastic casing that should retain its luster for many years. Clean it only with a soft cloth slightly dampened with water or a mild soap. Do not use excess water or cleaning solvents of any kind.

Remember that electrical appliances can cause serious injury if used when you are wet or standing in water. If your Base Unit should fall into water, **DO NOT RETRIEVE IT UNTIL YOU UNPLUG THE POWER CORD AND TELEPHONE LINE CORDS FROM THE WALL.** Then pull the unit out by the unplugged cords.

## In Case Of Difficulty

---

If you have difficulty operating your phone, the suggestions below should solve the problem. If you still have difficulty after trying these suggestions, call the Supplier at (800) 651-6791.

### The Phone Doesn't Work At All

- Make sure the Power Cord is plugged in.
- Make sure the telephone line cord is plugged firmly into the Base Unit and the telephone wall jack.
- Make sure the batteries are properly charged. If the 'LOW BATTERY' message is shown, the battery pack needs charging.
- Is the Handset registered to the Base? See Registration and Operation.

### No Dial Tone

- First check all the suggestions above.
- If you still don't hear a dial tone, disconnect the Base Unit from the telephone jack and connect a different phone. If there is no dial tone on that phone either, the problem is in your wiring or local service. Contact your local telephone company.

### You Get Noise, Static, Or A Weak Signal Even When You're Near The Base Unit

- Household appliances plugged into the same circuit as the Base Unit can sometimes cause interference. Try moving the appliance or the Base Unit to another outlet.

### You Get Noise, Static, Or A Weak Signal When You're Away From The Base Unit

- You may be out of range. Either move closer to the Base, or relocate the Base Unit.
- The layout of your home may be limiting the range. Try moving the Base Unit to another position.

### The Handset Does Not Ring When You Receive A Call

- Make sure you have the Handset ringer activated. To set the ringer, see **HANDSET** and **BASE SETTINGS**.
- Make sure the telephone line cord is plugged firmly into the Base Unit and the telephone jack. Make sure the power cord is plugged in.
- You may be too far from the Base Unit.
- You may have too many extension phones on your telephone line to allow all of them to ring. Try unplugging some of the other phones.

## In Case Of Difficulty

---

### You Hear Other Calls While Using Your Phone

- Disconnect your Base Unit from the telephone jack, and plug in a regular telephone. If you still hear other calls, the problem is probably in your wiring or local service. Call your local telephone company.

### You Hear Noise In The Handset, And None Of The Keys Or Buttons Work

- Make sure the power cord is plugged in.

### Common Cure For Electronic Equipment

If the unit does not seem to be responding normally, then try putting the Handset in the cradle. If it does not seem to respond, do the following (in the order listed) :

1. Disconnect the power to the Base.
2. Disconnect the Handset battery, and spare battery pack, if applicable.
3. Wait a few minutes.
4. Connect power to the Base.
5. Re-install the battery pack (s)
6. Watch for Handset to display :

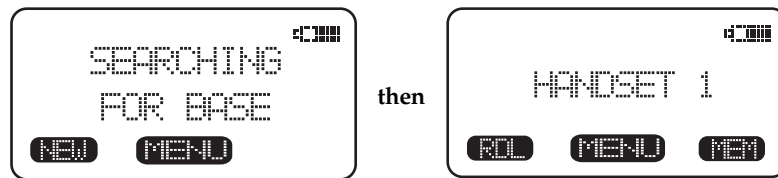

## Limited Warranty

---

The Manufacturer's Limited Warranty, to the original purchaser only, the material and workmanship of this product for ONE YEAR from the date of purchase. The Supplier will repair or replace, at our option, this product without charge should it fail due to a defect in material or workmanship within that time period.

This warranty does not apply to loss or damage which is the result of accident, misuse or negligence. All other warranties, expressed, implied, or statutory, including warranties of fitness for a particular purpose, are limited to the time period listed and are otherwise excluded from this warranty. The manufacturer may, at its option, void the warranty if unauthorized repairs are attempted. Additionally, the manufacturer shall not be liable for any incidental or consequential damage or commercial loss, nor for any other loss or damages.

The manufacturer assumes no responsibility for products sent without prior Return Authorization.

To arrange for service, in or out of warranty, please call the Supplier at (800) 651-6791. For warranty service, proof of purchase is required.

## FCC, ACTA and IC Regulations

---

This equipment complies with Parts 15 of the Federal Communications Commission (FCC) rules for the United States. It also complies with regulations RSS210 and CS-03 of Industry and Science Canada. Operation is subject to the following two conditions: (1) this device may not cause interference, and (2) this device must accept any interference, including interference that may cause undesired operation of the device.

A label is located on the underside of the Base Unit containing either the FCC registration number and Ringer Equivalence Number (REN) or the IC registration number and Load Number. You must, upon request, provide this information to your local telephone company.

This equipment is compatible with inductively coupled hearing aids.

Should you experience trouble with this telephone equipment, please contact the Supplier: **at (800) 651-6791**.

For repair/warranty information. The telephone company may ask you to disconnect this equipment from the line network until the problem has been corrected.

### FCC Part 15

**Warning:** Changes or modifications to this unit not expressly approved by the party responsible for compliance could void the user's authority to operate the equipment.

The equipment has been tested and found to comply with part 15 of the FCC rules. These limits are designed to provide reasonable protection against harmful interference in a residential installation. This equipment generates, uses and can radiate radio frequency energy and, if not installed and used in accordance with the instructions, may cause harmful interference to radio communications. However, there is no guarantee that interference will not occur in a particular installation. If this equipment does cause harmful interference to radio or television reception, which can be determined by turning the equipment off and on, the user is encouraged to try and correct the interference by one or more of the following measures:

- Reorient or relocate the receiving antenna.
- Increase the separation between the equipment and receiver.
- Connect the equipment into an outlet or on a circuit different from that to which the receiver is connected.
- Consult the dealer or an experienced radio/TV technician for help.

# FCC, ACTA and IC Regulations

---

## FCC Part 68 and ACTA

If this equipment was approved for connection to the telephone network prior to July 23, 2001, it complies with Part 68 of the Federal Communications Commission (FCC) rules. If the equipment was approved after that date, it complies with the Part 68 rules and with Technical Requirements for Connection of Equipment to the Telephone Network adopted by the Administrative Council for Terminal Attachments (ACTA). We are required to provide you with the following information.

### 1. Product identifier and REN information

The label on the back or bottom of this equipment contains, among other things, an identifier indicating product approval and the Ringer Equivalence Number (REN). This information must be provided to your local telephone company upon request. For equipment approved prior to July 23, 2001, the product identifier is preceded by the phrase "FCC Reg No." and the REN is listed separately. For equipment approved after that date, the product identifier is preceded by "US" and a colon (:), and the REN is encoded in the product identifier without a decimal point as the sixth and seventh characters following the colon. For example, the product identifier US:AAAEQ03T123XYZ would indicate an REN of 0.3.

The REN is used to determine how many devices you may connect to your telephone line and still have them ring when you are called. In most, but not all areas, the sum of all RENs should be five (5.0) or less. You may want to contact your local telephone company for more information.

### 2. Connection and use with the nationwide telephone network

The plug and jack used to connect this equipment to the premises wiring and the telephone network must comply with the applicable Part 68 rules and technical requirements adopted by ACTA. A compliant telephone cord and modular plug is provided with this product. It is designed to be connected to a compatible modular jack that is also compliant. An RJ11 jack should normally be used for connecting to a single line and an RJ14 jack for two lines. See Installation Instructions in the user's manual. This equipment may not be used with Coin Telephone Lines or with Party Lines. If you have specially wired alarm dialing equipment connected to your telephone line, ensure the connection of this equipment does not disable your alarm equipment. If you have questions about what will disable alarm equipment, consult your telephone company or a qualified installer.

### 3. Repair instructions

If this equipment is malfunctioning, it must be unplugged from the modular jack until the problem has been corrected. Repairs to this telephone equipment can only be made by the manufacturer or its authorized agents. For repair procedures, follow the instructions outlined under the Limited Warranty.

### 4. Rights of the telephone company

If this equipment is causing harm to the telephone network, the telephone company may temporarily discontinue your telephone service. The telephone company is required to notify you before interrupting service. If advanced notice is not practical, you will be notified as soon as possible. You will be given the opportunity to correct the problem and the telephone company is required to inform you of your right to file a complaint with the FCC.

## FCC, ACTA and IC Regulations

---

Your telephone company may make changes in its facilities, equipment, operation, or procedures that could affect the proper functioning of this product. The telephone company is required to notify you if such changes are planned.

### 5. Hearing aid compatibility

If this product is equipped with a corded or cordless handset, it is hearing aid compatible.

### 6. Programming/testing of emergency numbers

If this product has memory dialing locations, you may choose to store police, fire department and emergency medical service telephone numbers in these locations. If you do, please keep three things in mind:

- a We recommend that you also write the telephone number on the directory card, so that you can still dial the emergency number manually if the memory dialing feature doesn't work.
- b This feature is provided only as a convenience, and the manufacturer assumes no responsibility for customer reliance upon the memory feature.
- c Testing the emergency telephone numbers you have stored is not recommended. However, if you do make a call to an emergency number:
  - You must remain on the line and briefly explain the reason for the call before hanging up.
  - Programming/testing of emergency numbers should be performed during off-peak hours, such as in the early morning or late evening, when the emergency services tend to be less busy.

### IC (Industry Canada)

This telephone is registered for use in Canada.

The term "IC:" before the radio certification number only signifies that Industry Canada technical specifications were met.

#### Notice:

This equipment meets the applicable Industry Canada Terminal Equipment Technical Specifications. This is confirmed by the registration number. The abbreviation, IC, before the registration number signifies that registration was performed based on a Declaration of Conformity indicating that Industry Canada technical specifications were met. It does not imply that Industry Canada approved the equipment.

#### Notice:

The Ringer Equivalence Number (REN) for this terminal equipment is 0.0. The REN assigned to each terminal equipment provides an indication of the maximum number of terminals allowed to be connected to a telephone interface. The termination on an interface may consist of any combination of devices subject only to the requirement that the sum of the Ringer Equivalence Numbers of all the devices does not exceed five.

## FCC, ACTA and IC Regulations

---

Before installing this equipment, users should ensure that it is permissible to be connected to the facilities of the local telecommunications company. The equipment must also be installed using an acceptable method of connection. The customer should be aware that compliance with the above conditions may not prevent degradation of services in some situations.

Repairs to certified equipment should be made by an authorized Canadian maintenance facility designated by the supplier. Any repairs or alterations made by the user to this equipment, or equipment malfunctions, may give the telecommunications company cause to request the user to disconnect the equipment.

Users should ensure for their own protection that the electrical ground connections of the power utility, telephone lines and internal metallic water pipe system, if present, are connected together. This precaution may be particularly important in rural areas.

**Caution :**

Users should not attempt to make such connections themselves, but should contact the appropriate electrical inspection authority, or electrician, as appropriate.

Your **20-2432** is designed to operate at the maximum power allowed by the FCC and IC. This means your Handset and Base Unit can communicate only over a certain distance - which will depend on the location of the Base Unit and Handset, weather, and the construction and layout of your home or office.



## Technical Specifications

---

### FREQUENCY CONTROL

Crystal controlled  
PLL synthesizer

### TRANSMIT FREQUENCY

2401.056 - 2481.408 MHz

### RECEIVE FREQUENCY

2401.056 - 2481.408 MHz

### CHANNELS

94 Channels

### NOMINAL EFFECTIVE RANGE

Maximum power allowed by FCC.  
Actual operating range may vary  
according to environmental conditions  
at the time of use.

### SIZE

Handset: 48mm x 33mm x 175mm

Base: 205mm x 146mm x 71mm

### WEIGHT

Handset: 122 grams  
Base: 598 grams  
(excluding battery pack)

### POWER REQUIREMENTS

Handset: 800mAh NiCd Battery Pack  
or 1500mAh NiMH Battery  
Pack

Base: 7 VDC @ 900mA

### MEMORY

Directory: 50 Memory locations;  
32 digits per location.

CID: Alphanumeric Display  
50 Memory locations

**SPECIFICATIONS ARE TYPICAL  
AND MAY CHANGE WITHOUT  
NOTICE.**



91-5598-10-00  
ISSUE0



# Table Of Contents

---

<b>1. Important Safety Instructions</b>	<b>28. Advanced Operations</b>
<b>3. Introduction</b>	28. Handset and Base Operation
4. Parts Check List	28. Making Calls
5. The Handset Layout	28. Redial
6. The Base Unit Layout	29. Answering Calls
<b>7. Getting Started</b>	30. Mute Function
7. Setup	30. Hold Function
8. Installation of Battery Pack in Handset	30. Flash Function
9. Charging Of Handset Battery Pack	31. How to Adjust the Handset Volume
10. Dial Tone	31. Base Speakerphone or Headset Volume
11. Spare Battery Charger/Power Backup Function	31. Intercom/Transfer Function
12. Registration and Operation	32. Transferring Calls
<b>14. Basic Operation</b>	32. Handsfree Speakerphone Operation
14. Handset and Base Indicators	33. Switching from the Handset Earpiece to Handsfree
16. Soft Menu Functions	33. Base Speakerphone Operation
16. RDL (Redial)	33. Line in Use Indication
16. HANDSET MENU	33. Low Battery Indication
16. BASE UNIT MENU	34. Message Waiting Indication
17. Call History (Caller ID)	34. Conference Calling
18. DIAL OPTION SHORTCUT	34. 2-LINE Conference Calls
18. DELETE	<b>35. Additional Information</b>
18. DELETE SHORTCUT	35. Custom Pay-Per-Use (PPU) Features
19. SAVE TO MEMORY	36. Additional Services
19. Handset and Base Settings	36. Caller ID
19. RINGERS	36. Caller ID Blocking Options
20. LOW BATT TONE	36. Call Waiting
20. RANG TONE	36. Call Waiting ID
20. KEYPAD TONE	37. Voice Messaging Service
20. CONTRAST	37. Call Forwarding
20. SELECT TONE/PULSE AT THE BASE UNIT	37. Call Rejection
21. ENHANCED MODE	37. Call Trace
21. RENAME	38. Priority Call
23. Register	38. Selective Call Forwarding
23. Handset Deregistration	38. Speed Calling
23. Register	39. Headset Operation
24. Memory	39. Headset Operation connected to the Handset
25. To Store a Number/Name	39. Headset Operation connected to the Base Unit
26. To Search For and Dial a Number/Name	39. Belt Clip
26. To Delete a Number/Name	40. Maintenance
27. To Edit a Number/Name	41. In Case Of Difficulty
	43. Limited Warranty
	44. FCC, ACTA and IC Regulations
	48. Technical Specifications

## Free Manuals Download Website

<http://myh66.com>

<http://usermanuals.us>

<http://www.somanuals.com>

<http://www.4manuals.cc>

<http://www.manual-lib.com>

<http://www.404manual.com>

<http://www.luxmanual.com>

<http://aubethermostatmanual.com>

Golf course search by state

<http://golfingnear.com>

Email search by domain

<http://emailbydomain.com>

Auto manuals search

<http://auto.somanuals.com>

TV manuals search

<http://tv.somanuals.com>