

Important Safety Instructions

When using your telephone equipment, basic safety precautions should always be followed to reduce the risk of fire, electric shock and injury, including the following:

1. Read and understand all instructions.
2. Follow all warnings and instructions marked on the product.
3. Unplug this product from the wall outlet before cleaning. Do not use liquid cleaners or aerosol cleaners. Use a damp cloth for cleaning.
4. Do not use this product near water (for example, near a bath tub, kitchen sink, or swimming pool).
5. Do not place this product on an unstable cart, stand, or table. The product may fall, causing serious damage to the product.
6. Slots and openings in the cabinet and the back or bottom are provided for ventilation. To protect it from overheating, these openings must not be blocked by placing the product on the bed, sofa, rug, or other similar surface. This product should never be placed near or over a radiator or heat register. This product should not be placed in a built-in-installation where proper ventilation is not provided.
7. This product should be operated only from the type of power source indicated on the marking label. If you are not sure of the type of power supply to your home, consult your dealer or local power company.
8. Do not allow anything to rest on the power cord. Do not locate this product where the cord will be abused by persons walking on it.
9. Never push objects of any kind into this product through cabinet slots as they may touch dangerous voltage points or short out parts that could result in a risk of fire or electric shock. Never spill liquid of any kind on the product.
10. To reduce the risk of electric shock, do not disassemble this product. If service or repair work is required, contact **VTech** Customer Service at **1-800-595-9511**. Opening or removing cabinet parts other than specified access doors may expose you to dangerous voltages or other risks. Incorrect reassembling can cause electric shock when the appliance is subsequently used.
11. Do not overload wall outlets and extension cords as this can result in the risk of fire or electric shock.
12. Unplug this product from the wall outlet:
 - a) When the power supply cord or plug is damaged or frayed.
 - b) If liquid has been spilled into the product.
 - c) If the product has been exposed to rain or water.
 - d) If the product does not operate normally by following the operating instructions. Adjust only those controls that are covered by the operating instructions because improper adjustment of other controls may result in damage and will often require extensive work to restore the product to normal operation.
 - e) If the product has been dropped and the cabinet has been damaged.
 - f) If the product exhibits a distinct change in performance.
13. Avoid using a telephone (other than a cordless type) during an electrical storm. There may be a remote risk of electric shock from lightning.
14. Do not use the telephone to report a gas leak in the vicinity of the leak.



If you have questions about this product, or if you're having difficulty with setup or operation, do not return your phone to the store. Call our Customer Support Center at:

1-800-595-9511

In Canada, call

1-800-267-7377

Introduction

Parts Check List:

1. Handset
2. Base Unit
3. Telephone Line Cord
4. Battery Pack
5. AC Adapter
6. Belt Clip
7. Owner's Manual

To purchase replacement battery packs, call VTECH Communications at 1-800-595-9511. In Canada, call VTECH Electronics at 1-800-267-7377.

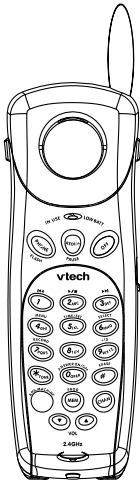

HANDSET

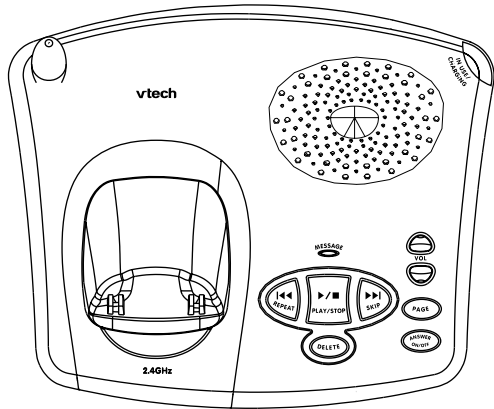

BASE UNIT

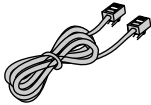

TELEPHONE LINE CORD

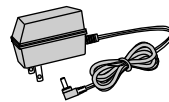

AC ADAPTER

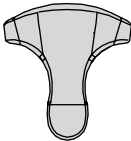

BELT CLIP

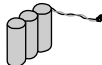

BATTERY



OWNER'S MANUAL

Connecting power to Base Unit

Plug the AC power adapter into an electrical outlet, and the DC connector into the bottom of the Base Unit.

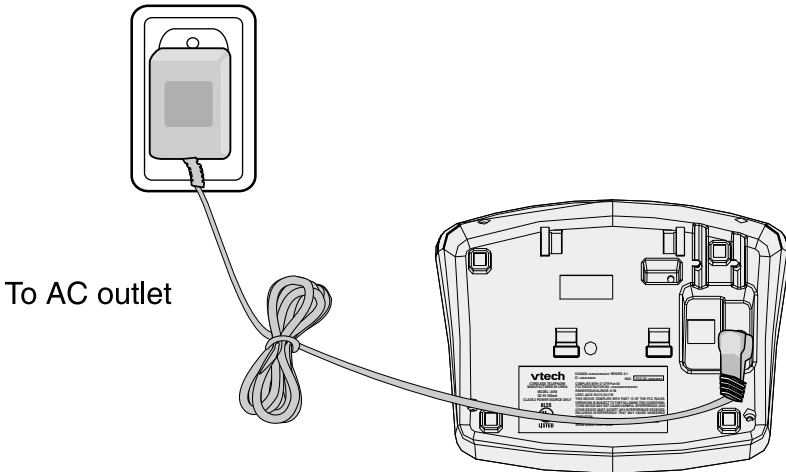

Installation of Battery Pack in Handset

Follow the steps below:

1. Remove the battery cover by pressing on the indent and sliding downward.
2. With the red and black wires at the bottom right corner of the pack, angle the top of the battery into the compartment, under the two 'claws'. Next, press the lower end of the battery pack down, so it snaps in place, under the lower claw. Now, plug the connector into the socket, located below the battery. Slip the wires under the wire guide, located below and to the left of the socket.
3. Replace the battery cover by sliding it upwards.
4. If the new battery pack is not already charged, place the Handset in the Base Unit, and allow it to charge for 12 hours. After the initial charge, a maintenance charge of 8 hours should be sufficient. Maximum talk time is 5 hours on a full charge. Maximum standby time is 5 days.

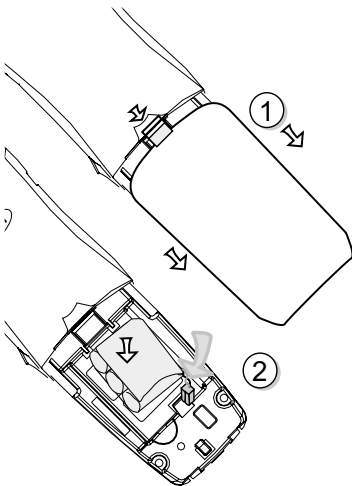

Setup

CAUTION: To reduce the risk of fire or injury, read and follow these instructions:

1. Use only the **Vtech** battery supplied or equivalent.
2. Do not open or mutilate the battery. Released electrolyte is corrosive and may cause damage to the eyes or skin. It may be toxic if swallowed.
3. Exercise care in handling batteries in order not to short the battery with conducting materials such as rings, bracelets, and keys. The battery or conductor may overheat and cause burns.
4. Do not dispose of the battery in a fire. The cell may explode.

Connect to phone line

Plug one end of the telephone line cord into the jack on the bottom of the Base Unit. Plug the other end of this cord into the wall jack.

Checking for dial tone

After the battery pack is charged, pick up the Handset and press the **PHONE** key. The **IN USE** indicator should light up, and you should hear a dial tone; if not, see **IN CASE OF DIFFICULTY**.

Tone/Pulse Selection

See **OPERATING INSTRUCTIONS** for details.



CAUTION: Use only the Vtech power supply provided with your telephone.

IMPORTANT:

For best performance the **VT2458** should be installed as follows:

In an elevated location, in the center of the room, with no obstructions nearby.

In a location that is away from other electrical appliances such as microwave ovens, personal computers, or televisions.

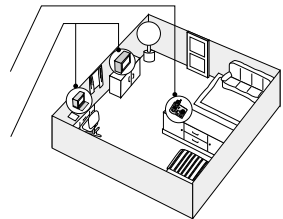

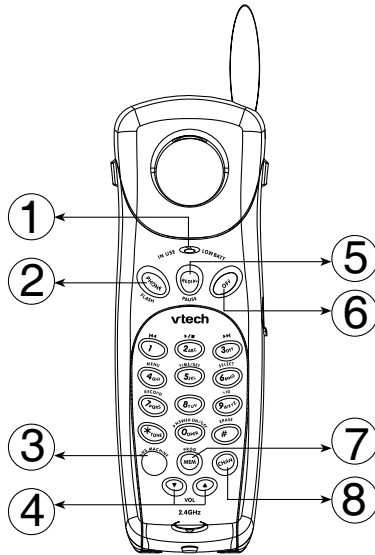

1. IN USE/LOW BATTERY LED

- * Glows when the Handset is in use.
- * Flashes during programming mode.
- * Flashes in cadence with incoming ringing.
- * Flashes slowly when the battery pack needs recharging.

2. PHONE/FLASH

- * Press this key to answer a call or get a dial tone. While on a call, when you receive a Call Waiting alert, press **PHONE/FLASH** to switch between calls.

3. ANSWERING MACHINE

- * Press this key to enter Answering System mode. It will flash while the Handset is controlling the Answering System. It will also flash to alert you to new messages. See the section **Handset Layout For Answering System Operation** for more details.

4. VOLUME UP▲/VOLUME DOWN▼

- * These keys will raise and lower the earpiece volume while either **IN PHONE** or **ANSWERING SYSTEM** mode.

5. REDIAL/PAUSE

- * With the Handset **ON**, pressing this key will dial the last number you called. In Programming mode, **REDIAL/PAUSE** will add a 4 second pause to a dialing sequence.

6. OFF

- * Press this key to end a call. The **OFF** key is also used to exit all modes of operation.

7. PROG/MEM

- * This key is used to enter Programming mode, as well as Memory Dial mode.

8. CHANNEL

- * If you experience noise or interference while on a call, press **CHAN** to switch to a clear channel.

Base Unit Features

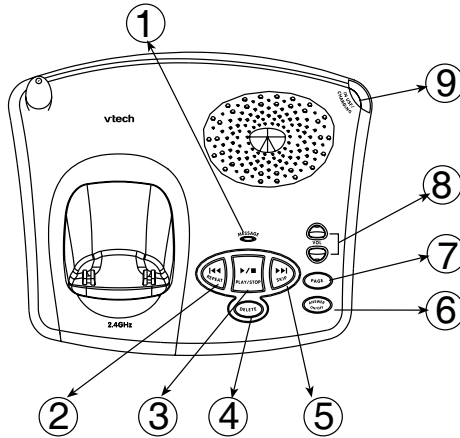

1. MESSAGE LED

- * Flashes slowly to indicate new messages; Glows steadily to indicate old (previously heard) messages; Flashes rapidly to indicate that the Answering System Message is **FULL**.

2. REPEAT

- * During message playback, press **REPEAT** to return to the beginning of the messages being played. Hold down the **REPEAT** key to slow down message playback.

3. PLAY/STOP

- * Press to play messages; press again to stop.

4. DELETE

- * During message playback, press **DELETE** to erase the message being played. During idle mode, press **DELETE** to erase all previously played messages.

5. SKIP

- * During message playback, press **SKIP** to the next message. Hold down the **SKIP** key to speed up message playback.

6. ANSWER ON/OFF LED

- * Glows steadily when the Answering System is **ON** and the day and time has been set; Flashes to indicate that the day and time need to be set.

7. PAGE

- * Press **PAGE** to engage the Handset in a ring sequence, which will last for 60 seconds. You can end the page by pressing **PAGE** again on the Base Unit, or pressing **OFF** on the Handset.

8. VOLUME

- * Raise or lower the Base Unit speaker volume. These are **8** volume levels. At the lowest level (Level **1**), incoming messages cannot be screened at the Base Unit as they come in.

9. IN USE/CHARGING LED

- * Flashes slowly when the Handset is in TALK mode; Flashes in cadence with the inbound ringing; Glows when the Handset is charging in the Base Unit cradle; Flashes when Handset is in **ANSWERING SYSTEM** mode.

Operating Instructions

Making Calls

- Pick up the Handset and press **PHONE**.
- When you hear a dial tone, dial the number.
- The **IN USE** LED will illuminate while the Handset is on a call. If you make a mistake when dialing, press **OFF** to hang up, then press **PHONE** to get the dial tone again.
- You must always press **PHONE** before you can dial a call on the Handset.

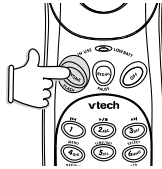

Answering Calls

- When an incoming call is ringing, the **IN USE/CHARGING** LED on the Base and **IN USE/LOW BATT** LED on the Handset will flash.
- To answer a call when the Handset is in the Base, just pick up the Handset. — OR —
- To answer a call when the Handset is away from the Base, press any key on the Handset (except **OFF**). This is very useful in a dark environment; you do not have to fumble around looking for the **PHONE** key to answer the call.

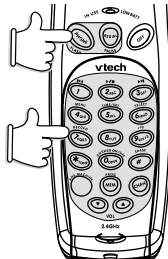
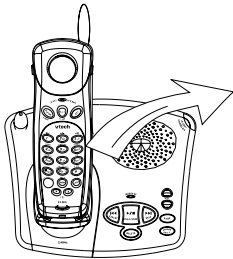

Disconnecting

- To end a call, either place the Handset back in the Base.
- OR —
- Press **OFF** on the Handset.

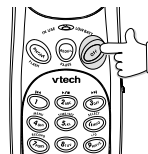
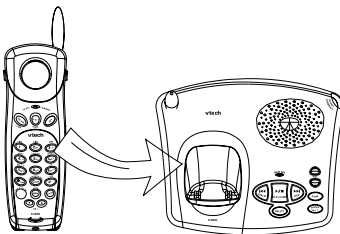

Operating Instructions

Changing Channels

- If you notice interference when using your Handset, press **CHAN** to switch to a clear channel. This function is only available when you are on a call.

TONE/PULSE Setting

NOTE: Your VT 2458 is preset at the factory for **TONE** dialing.

- If you have touch tone service on phone line:
- Press **PROG**, *, *, **MEM** to switch to **TONE** dialing.
- * If you have rotary service, press **PROG/MEM**, *, *, **PROG/MEM** to switch to **PULSE**.
- * To return to touch tone service, press **PROG/MEM**, *, *, **PROG/MEM**.

Temporary Tone

If you have rotary (dial-pulse) telephone service, (**TONE/PULSE** setting is set to **PULSE**), this feature allows you to enter special codes and tones to operate answering machines, use electronic banking services, calling cards, or other special services.

- Dial the call normally.
- Activate the Temporary Tone feature by pressing **TONE** (the * key).
- You can then press the numbers or symbols you need, and your phone will send the proper signals.
- To end the call, press **OFF** or place the Handset back in the Base. The phone will automatically go back to rotary (dial-pulse) service.

Programming the Ringer Type

The Handset ringer is capable of four different types of ringing tones. To select a different ringer type do the following:

- Press **PROG/MEM**.
- Press the **#** key.
- Press a key 1 - 4 to select a ringer type.
- Press the **PROG/MEM** key to confirm.

NOTE: To program, the Handset must be OFF.

Turning Off the Ringer

To turn off the ringer on the Handset, do the following:

- Press **PROG/MEM**.
- Press the **#** key.
- Press **5** to turn off the ringer. Press the **PROG/MEM** key to confirm.
- To turn the ringer on again, see **Programming the Ringer Type**.

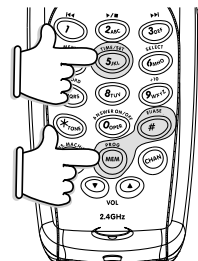
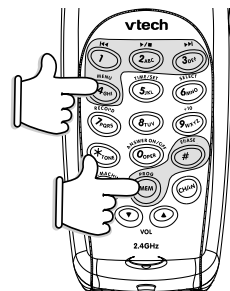
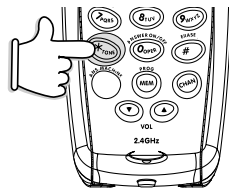
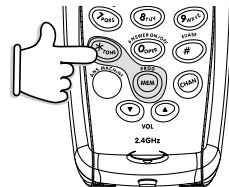
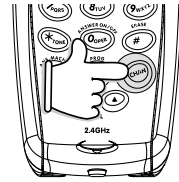

Operating Instructions

Checking the Ringer

To check the ringer which is currently programmed, do the following:

- Press **PROG/MEM**.
- Press the **#** key.
- Press **0**.
- Press the **PROG/MEM** key to confirm.

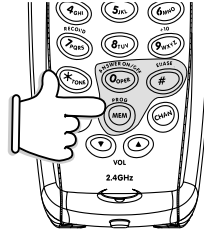

Memory Dialing

- The **VT2458** can store up to 10 different phone numbers that you can dial just by pressing **PHONE**, **PROG/MEM** and one of the number keys (0-9)

Programming Speed Dial Numbers

The Handset must be **OFF**.

- Press **PROG/MEM**. The **IN USE** LED will blink to indicate that you are in the programming mode.
- Press the number of the memory location you wish to store the number in (0-9).
- Using the dial pad, dial the number you want to store. The number can be up to 16 digits long. The number can be entered manually or by using **REDIAL/PAUSE**.
- Press **MEM** to store the phone number to the key you selected. The phone exits **PROG/MEM** mode and emits a tone.

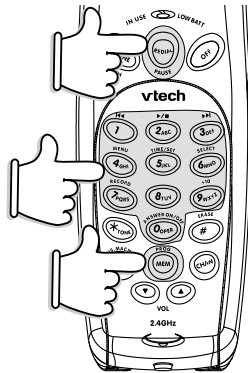

Speed Number Dialing

- Press **PHONE/FLASH** to get a dial tone.
- Press **PROG/MEM** and the memory location number key (0-9).
- For example, to dial the number you assigned to key '8', you would press **PHONE**, **PROG/MEM**, **8**.

To Change or Replace a Speed Dial Number

- To change or replace a stored number in speed dial memory, simply enter the new number and store it in the memory location you wish to change.

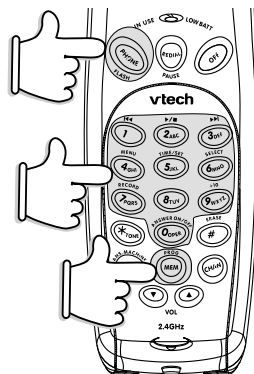

Operating Instructions

Storing Pauses in Memory

- To insert a pause in a phone number, press **PAUSE**. The pause is approximately 4 seconds in length. For longer pauses, press **PAUSE** two or more times. Each additional press adds an additional 4 second pause.
- If your phone is connected to a PBX you can store the PBX access number and a pause before the phone number. For example, to store **9-PAUSE-555-1234** in memory location 8 do the following:
 - Press **PROG**.
 - Press **8**.
 - Press **9**.
 - Press **REDIAL/PAUSE**.
 - Dial **555-1234**.
 - Press **PROG/MEM**.

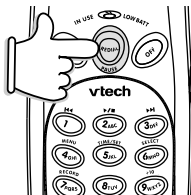

Using Redial

- To redial the last number you called, press **PHONE/FLASH** then press **REDIAL/PAUSE**. The phone will automatically dial the number.

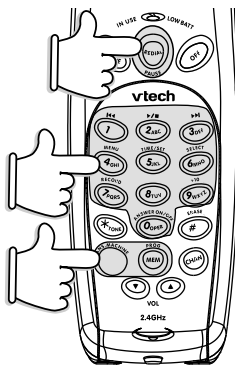

Storing a Redial Number into Speed Dial

- To store the last number you dialed as a Speed Dial number, press **PROG/MEM**, a location number (0-9), **REDIAL/PAUSE**, **PROG/MEM**.

The Page Feature

- From the Base Unit, press **PAGE** to signal the person at the idle Handset.
- To end the page at the Base, press **PAGE** again.
- To end the page at the Handset, press **OFF**.
- If the Handset is in use (off-hook) when **PAGE** is pressed on the Base Unit, the Handset will emit one page alert. If the Handset is not in use (on-hook), the page alert will continue for approximately 60 seconds.
- The page alert will continue for approximately 60 seconds.

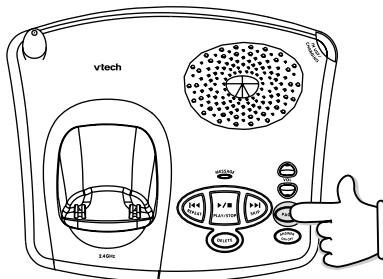

Answering System Operation

Introduction

Your **VT 2458** has a digital Answering Device in the Base Unit, capable of storing approximately 12 minutes of messages.

USE THE VT2458 HANDSET TO PROGRAM YOUR ANSWERING SYSTEM!!!

- You can listen to your messages from the **Handset** or the **Base Unit**.
- You can also screen messages while your callers leave them from either the **Handset** or the **Base Unit**.

Call Screening from Base Unit

Simply keep the Base Unit volume level above the minimum setting. You will hear messages at the Base Unit as your callers leave them.

Call Screening from Handset

Press **ANS. MACHINE** on the Handset as a message comes in. You will be able to hear your caller, but your caller cannot hear you. If you want to talk to your caller now, press **PHONE/FLASH**. The answering system will return to idle mode.

Handset Layout For Answering System Operation

With the Handset in the idle mode (on hook), first press **ANS. MACHINE** to enter Answering System mode, then one of the following keys:

KEY	FUNCTION
1	Repeat current message
2	Play/Stop(playback or recording)
3	Skip to the next message
4	MENU (for programming your Answering System)
5	SET (for programming your Answering System)
6	SELECT (for programming your Answering System)
7	Record(Outgoing Messages and Memos)
9	Increment by 10 (for programming time and security code)
0	Answering System ON/OFF
#	Erase

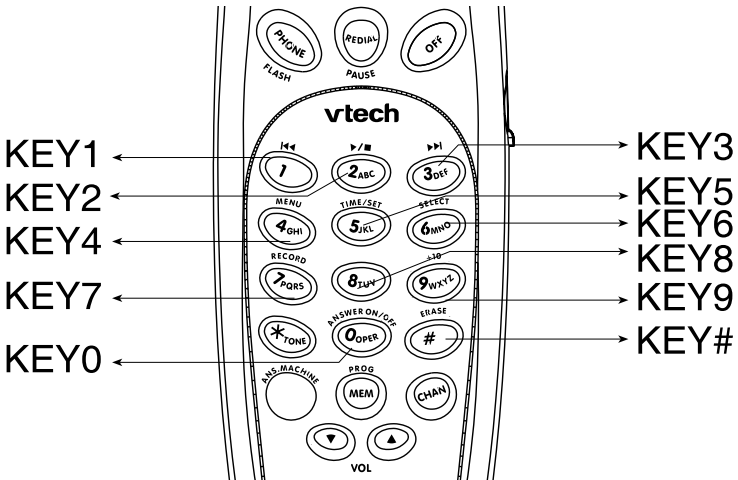

Press **ANS. MACHINE** or **OFF** to exit Answering System mode.

Answering System Setup

Before using your **VT 2458** Answering System, follow these programming steps:

1 Set Outgoing Message

Record your greeting to be heard by callers. If you do not record a greeting, your **VT 2458** will play a default greeting.

- Press **ANS. MACHINE** on the Handset.
- Press **4 (MENU)**. The voice prompt says "Set Outgoing Message".
- Press **7 (Record)**. The voice prompt says "Now Recording", followed by a beep. Speak into the Handset to record your announcement.
Press **2 (Stop)** when done. Your recorded announcement will be played for you.

2 Set Security Code

Your 2 digit security code gives you access to your **VT 2458** Answering System from a telephone at a different location. Factory preset to **19**, your security code can be any number, from **10** to **99**.

- Press **ANS. MACHINE** on the Handset.
- Press **4 (MENU)** twice, until you hear: "Set Security Code".
- Press **6 (SELECT)** to increment the security code by one per each press. Press **9** to increment by **10**.
- Press **5 (TIME/SET)** to confirm your security code selection. You can either press **4 (MENU)** to continue programming, or **OFF** to exit programming.

3 Set Audible Message Alert

This feature provides a beep tone at the Base Unit every 10 seconds, alerting you to new messages.

- Press **ANS. MACHINE** on the Handset.
- Press **4 (MENU)** three times. You will hear: "Set Audible Message Alert".
- Press **6 (SELECT)** to toggle between **ON** and **OFF**.
- Press **5 (TIME/SET)** to confirm your selection.
- Press **4 (MENU)** to continue programming, or **OFF** to exit.

4 Set Announce Only

Your **VT 2458** Answering System can also play your greeting, without taking messages from callers. In this case, **ANNOUNCE ONLY** is set to **ON**.

- Press **ANS. MACHINE** on the Handset.
- Press **4 (MENU)** four times. You will hear: "Set Announce Only".
- Press **6 (SELECT)** to toggle between **ON** and **OFF**.
- Press **5 (TIME/SET)** to confirm your selection.
- Press **4 (MENU)** to continue programming, or **OFF** to exit.

Answering System Setup

Now, follow the steps in **1 SET OUTGOING MESSAGE** to record your “Announce Only” greeting. The **VT 2458** Answering System will retain both outgoing greetings; one for **Normal** (record messages) mode, and one for **Announce Only** mode.

NOTE!!!! THE ANSWERING SYSTEM IS PRESET AT THE FACTORY FOR ANNOUNCE ONLY OFF. THIS IS THE NORMAL MODE, REQUIRED FOR YOUR VT 2458 TO RECEIVE MESSAGES FROM CALLERS.

5 Set Base Ringer

You can turn your Base Unit On or Off. This is independent of the Handset ringer.

- Press **ANS. MACHINE** on the Handset.
- Press **4 (MENU)** six times. You will hear: “Set Base Ringer”.
- Press **6 (SELECT)** to toggle between **ON** and **OFF**.
- Press **5 (TIME/SET)** to confirm your selection.
- Press **4 (MENU)** to continue programming, or **OFF** to exit.

6 Set Number of Rings

Choose between **2, 4, 6**, or **Toll Saver**. Toll Saver will cause the Answering System to activate after **4** rings if there are no new, unplayed messages, and after **2** rings if there are new, unplayed messages.

- Press **ANS. MACHINE** on the Handset.
- Press **4 (MENU)** six times. You will hear: “Set Number of Rings”.
- Press **6 (SELECT)** to choose between **2, 4, 6** and **Toll Saver**.
- Press **5 (TIME/SET)** to confirm your selection.
- Press **4 (MENU)** to continue programming, or **OFF** to exit.

NOTE: DURING PROGRAMMING, PRESS **ANS. MACHINE OR **OFF** AT ANY TIME TO EXIT.**

Checking and Setting Day and Time

- Press **ANS. MACHINE** on the Handset.
- Press **5 (TIME/SET)**. The current Day and Time setting can be heard from the Handset and Base.
- After the current day and time announcement, the system will announce, “To set day and time, press **TIME /SET**.” to change the current setting. Press **5 (TIME/SET)** again.
- Press **6 (SELECT)** until hear the correct day; then press **5 (TIME/SET)**.
- Press **6 (SELECT)** until hear the correct hour; then press **5 (TIME/SET)**.
- Press **6 (SELECT)** until hear the correct minute (or press **9** to increment the minutes by **10**); then press **5 (TIME/SET)**. Your setting will be played for you. You can press **ANS.MACHINE** or **OFF** to exit.

Answering System Setup

Recording a Memo

- Press **ANS. MACHINE** on the Handset.
- Press **7 (RECORD)**. After the prompt: "Now Recording", speak into the Handset.
- Press **OFF** or **ANS. MACHINE** to end recording and exit Answering System mode, or press **2 (STOP)** to end recording and stay in Answering System mode.

Turning Your Answering System ON/OFF

Your **VT 2458** Answering System is turned **ON** when you first apply power to it. From the Handset you can turn the system **ON** and **OFF**.

- Press **ANS. MACHINE** on the Handset.
- Press **0**. Through the earpiece, you will hear "Answering Machine **OFF** (or **ON**). Continued presses of the **0** key will toggle between **ON** and **OFF**.
- Press **OFF** to exit programming mode.

Answering System Setup

PLAYBACK OF GREETINGS, MESSAGES AND MEMOS

From the Base Unit

Use the **PLAY/STOP** to start and stop playback of messages and memos.

- Press the **▶▶|SKIP** key to jump ahead to the next message.
- Hold the **▶▶|SKIP** key to speed up message playback.
- Press the **◀◀REPEAT** key to return to the beginning of the current message. 2 consecutive presses of the **◀◀REPEAT** key will take you back to the previous message.
- Hold the **◀◀REPEAT** key to slow down message playback.
- Press **DELETE** while a message is playing to erase that message.
- Press and Hold **DELETE** while the Answering System is idle to erase **all** previously heard messages.
- Adjust the Base Unit speaker volume using the **VOL UP ▲** and **DOWN ▼** keys.

The **MESSAGE** LED blinks when there are new messages. It glows steadily when it contains only old, previously heard messages.

From the Handset

- Press **ANS.MACHINE** on the Handset.
- Press **2 (PLAY)** to hear messages from the Handset.
- Press **1** to **repeat** the message; press **3** to **skip** to the next message.
- Press **# (DELETE)** to erase the current message.
- Press **OFF** or **ANS. MACHINE** to end message playback and exit Answering System mode; or press **2 (STOP)** to end message playback and stay in Answering System mode.

NOTE: Your VT 2458 prevents accidental erasure of unplayed messages

To Hear Your Outgoing Greeting

- Press **ANS.MACHINE** on the Handset.
- Press **4 (MENU)**.
- Press **2 (PLAY/STOP)**.
- Press **4 (MENU)** to continue programming, or **OFF** to exit.

Remote Operation of Your VT2458 Answering System

You can access messages and change your greeting remotely, using a touch tone phone from a different line or location.

Dial the phone number associated with the line to your **VT 2458**. While the greeting is playing, press your 2 digit **security code**.

You are now in **remote access** mode.

A voice menu will first tell you how many new and old messages you have, and then, after a pause, you will hear a review of the following remote commands:

REMOTE COMMANDS

#1	HELP MENU
#2	PLAY ALL MESSAGE
#4	REPEAT CURRENT MESSAGE
#4, #4	PLAY PREVIOUS MESSAGE
#5	STOP (Playback or Recording)
#6	SKIP TO NEXT MESSAGE
#7	REVIEW GREETING (Outgoing Message)
#9	ERASE CURRENT MESSAGE
#0	ANSWERING SYSTEM ON/OFF
*7	RECORD GREETING (Outgoing Message)
*8	RECORD MEMO
*0	HANG UP

NOTE: You do not have to wait until the voice menu announces the command to execute a particular remote function.

Headset Operation

Your **VT2458** Handset is equipped with a 2.5mm Headset Jack for use with an optional accessory Headset for hands-free operation. If you choose to use the Headset option, you must obtain an optional accessory Headset, which is compatible with the **VT2458**.

To purchase a Headset, call VTECH Customer Service at 1-800-595-9511.

Once you have a compatible 2.5mm Headset, locate the Headset Jack on the **VT2458** Handset. Connect the plug on the Headset cord to the jack on the cordless Handset.

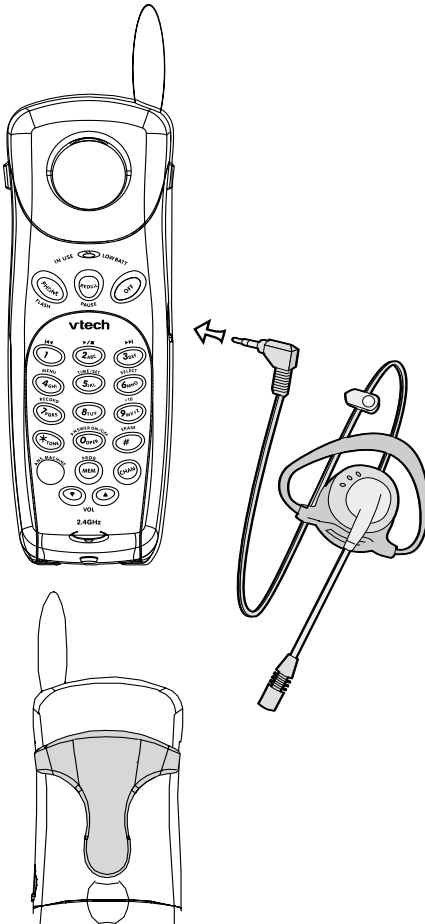

The plug should fit securely. Do not force the connection.

NOTE :

Whenever a compatible Headset is connected to the cordless Handset, the microphone on the Handset will be muted. This is done to limit the effect of background noise.

Many compatible Headsets have a reversible, monaural design. You can wear your Headset on either ear, leaving one ear free for room conversation.

Belt Clip

The **VT2458** is also equipped with a detachable belt clip. Align the pins on the inside edge of the clip with the notches on the sides of the Handset. The belt clip should snap securely into place. Do not force the connection.

Maintenance

Taking Care Of Your Telephone

Your **VT2458** cordless telephone contains sophisticated electronic parts, so it must be treated with care.

Avoid rough treatment

Place the Handset down gently. Save the original packing materials to protect your telephone if you ever need to ship it.

Avoid water

Your telephone can be damaged if it gets wet. Do not use the Handset outdoors in the rain, or handle it with wet hands. Do not install your Base Unit near a sink, bathtub or shower.

Electrical storms

Electrical storms can sometimes cause power surges harmful to electronic equipment. For your own safety, use caution when using electric appliances during storms.

Cleaning your telephone

Your telephone has a durable plastic casing that should retain its luster for many years. Clean it only with a soft cloth slightly dampened with water or a mild soap. Do not use excess water or cleaning solvents of any kind.

Remember that electrical appliances can cause serious injury if used when you are wet or standing in water. If your Base Unit should fall into water, ***DO NOT RETRIEVE IT UNTIL YOU UNPLUG THE POWER CORD AND TELEPHONE LINE CORDS FROM THE WALL.*** Then pull the unit out by the unplugged cords.

In Case Of Difficulty

If you have difficulty operating your phone, the suggestions below should solve the problem. If you still have difficulty after trying these suggestions, call VTECH Communications at 1-800-595-9511. In Canada, call VTECH Electronics at 1-800-267-7377.

The Phone Doesn't Work At All

- Make sure the Power Cord is plugged in.
- Make sure the telephone line cord is plugged firmly into the Base Unit and the telephone wall jack.
- Make sure the batteries are properly charged. If the '**LOW BATTERY**' LED is slowly flashing, the battery pack needs charging.

No Dial Tone

- First check all the suggestions above.
- If you still don't hear a dial tone, disconnect the Base Unit from the telephone jack and connect a different phone. If there is no dial tone on that phone either, the problem is in your wiring or local service. Contact your local telephone company.

You Get Noise, Static, Or A Weak Signal Even When You're Near The Base Unit

- Household appliances plugged into the same circuit as the Base Unit can sometimes cause interference. Try moving the appliance or the Base Unit to another outlet.

You Get Noise, Static, Or A Weak Signal When You're Away From The Base Unit

- You may be out of range. Either move closer to the Base, or relocate the Base Unit.
- The layout of your home may be limiting the range. Try moving the Base Unit to another position.

The Handset Does Not Ring When You Receive A Call

- Make sure you have the Handset ringer activated. To set the ringer, see ***Programming the Ringer Type***.
- Make sure the telephone line cord is plugged firmly into the Base Unit and the telephone jack. Make sure the power cord is plugged in.
- You may be too far from the Base Unit.
- You may have too many extension phones on your telephone line to allow all of them to ring. Try unplugging some of the other phones.

You Hear Other Calls While Using Your Phone

- Disconnect your Base Unit from the telephone jack, and plug in a regular telephone. If you still hear other calls, the problem is probably in your wiring or local service. Call your local telephone company.

In Case Of Difficulty

You Hear Noise In The Handset, And None Of The Keys Or Buttons Work

- Make sure the power cord is plugged in.

Common Cure For Electronic Equipment

If the unit does not seem to be responding normally, then try putting the Handset in the cradle. If it does not seem to respond, do the following(in the order listed) :

1. Disconnect the power to the Base.
2. Disconnect the Handset battery.
3. Wait a few minutes.
4. Connect power to the Base.
5. Re-install the battery pack, and return the Handset to the charge cradle.
6. After a few seconds, try using your Handset again.

Warranty Statement

What does this limited warranty cover?

- The manufacturer of this **VTECH** product, **VTECH Communications**, warrants to the holder of a valid proof of purchase (“Consumer” or “you”) that the product and all accessories provided by **VTECH** in the sales package (“Product”) are free from material defects in material and workmanship, pursuant to the following terms and conditions, when installed and used normally and in accordance with operation instructions. This limited warranty extends only to the Consumer for Products purchased and used in the United States of America.

What will VTECH Communications do if the Product is not free from material defects in materials and workmanship during the limited warranty period (“Materially Defective Product”)?

- During the limited warranty period, VTECH’s authorized service representative will repair or replace at VTECH’s option, without charge, a Materially Defective Product. If we repair this product, we may use new or refurbished replacement parts. If we choose to replace this product, we may replace it with a new or refurbished product of the same or similar design. VTECH will return repaired or replacement products to you in working condition. VTECH will retain defective parts, modules, or equipment. Repair or replacement of Product, at VTECH’S option, is your exclusive remedy. You should expect the repair or replacement to take approximately 30 days.

How long is the limited warranty period ?

- The limited warranty period for the product extends for ONE(1)YEAR from the date of purchase if we repair or replace a Materially Defective Product under the terms of this limited warranty. This limited warranty also applies to repaired or replacement Products for a period of either (a) 90 days from the date the repaired or replacement Product is shipped to you or (b) the time remaining on the original one-year warranty; whichever is longer.

What is not covered by this limited warranty ?

This limited warranty does not cover

1. Product that has been subjected to misuse, accident, shipping or other physical damage, improper installation, abnormal operation or handling, neglect, inundation, fire, water or other liquid intrusion; or
2. Product that has been damaged due to repair, alteration or modification by anyone other than an authorized service representative of VTECH; or
3. Product to the extent that the problem experienced is caused by signal conditions, network reliability or cable or antenna systems; or
4. Product to the extent that the problem is caused by use with non-VTECH electrical accessories; or
5. Product whose warranty/quality stickers, Product serial numbers plates or electronic serial numbers have been removed, altered or rendered illegible; or
6. Product purchased, used, serviced, or shipped for repair from outside the United States, or used for commercial or institutional purposes (including but not limited to Products used for rental purposes); or

Warranty Statement

7. Product returned without valid proof of purchase (see 2 below); or
8. Charges for installation or set up, adjustment of customer controls, and installation or repair of systems outside the unit.

How do you get warranty service?

- To obtain warranty service in the United States of America, call 1 800-595-9511 for instructions regarding where to return the Product. Before calling for service, please check the user's manual. A check of the Product controls and features may save you a service call.
- Except as provided by applicable law, you assume the risk of loss or damage during transit and transportation and are responsible for delivery or handling charges incurred in the transport of Product(s) to the service location . VTECH will return repaired or replaced product under this limited warranty to you, transportation, delivery or handling charges prepaid .VTECH assumes no risk for damage or loss of the Product in transit.
- If the Product failure is not covered by this limited warranty, or proof of purchase does not meet the terms of this limited warranty, VTECH will notify you and will request that you authorize the cost of repair prior to any further repair activity. You must pay for the cost of repair and return shipping costs for the repair of Products that are not covered by this limited warranty.

What must you return with the Product to get warranty service?

1. Return the entire original package and contents including the Product to the VTECH service location along with a description of the malfunction or difficulty;
2. Include "valid proof of purchase" (sales receipt) identifying the Product purchased (Product model) and the date of purchase or receipt; and
3. Provide your name, complete and correct mailing address, and telephone number.

Other Limitations

- This warranty is the complete and exclusive agreement between you and VTECH. It supersedes all other written or oral communications related to this Product. VTECH provides no other warranties for this product. The warranty exclusively describes all of VTECH's responsibilities regarding the product. There are no other express warranties. No one is authorized to make modifications to this limited warranty and you should not rely on any such modification.

State Law Rights: This warranty gives you specific legal rights, and you may also have other rights which vary from state to state.

Warranty Statement

Limitations: Implied warranties, including those of fitness for a particular purpose and merchantability (an unwritten warranty that the product is fit for ordinary use) are limited to one year from date of purchase. Some states do not allow limitations on how long an implied warranty lasts, so the above limitation may not apply to you.

- In no event shall VTECH be liable for any indirect, special, incidental, consequential, or similar damages (including, but not limited to lost profits or revenue, inability to use the product, or other associated equipment, the cost of substitute equipment, and claims by third parties) resulting from the use of this product. Some states do not allow the exclusion or limitation of incidental or consequential damages, so the above limitation or exclusion may not apply to you.

FCC, ACTA and IC Regulations

This equipment complies with Parts 15 of the Federal Communications Commission (FCC) rules for the United States. It also complies with regulations RSS210 and CS-03 of Industry and Science Canada. Operation is subject to the following two conditions: (1) this device may not cause interference, and (2) this device must accept any interference, including interference that may cause undesired operation of the device.

A label is located on the underside of the Base Unit containing either the FCC registration number and Ringer Equivalence Number (REN) or the IC registration number and Load Number. You must, upon request, provide this information to your local telephone company.

This equipment is compatible with inductively coupled hearing aids.

Should you experience trouble with this telephone equipment, please contact:

VTech Communications Inc.

CUSTOMER SERVICE at 1-800-595-9511. In Canada, call VTECH Electronics at 1-800-267-7377.

For repair/warranty information. The telephone company may ask you to disconnect this equipment from the line network until the problem has been corrected.

FCC Part 15

Warning: Changes or modifications to this unit not expressly approved by the party responsible for compliance could void the user's authority to operate the equipment. The equipment has been tested and found to comply with part 15 of the FCC rules. These limits are designed to provide reasonable protection against harmful interference in a residential installation. This equipment generates, uses and can radiate radio frequency energy and, if not installed and used in accordance with the instructions, may cause harmful interference to radio communications. However, there is no guarantee that interference will not occur in a particular installation. If this equipment does cause harmful interference to radio or television reception, which can be determined by turning the equipment off and on, the user is encouraged to try and correct the interference by one or more of the following measures:

- Reorient or relocate the receiving antenna.
- Increase the separation between the equipment and receiver.
- Connect the equipment into an outlet or on a circuit different from that to which the receiver is connected.
- Consult the dealer or an experienced radio/TV technician for help.

FCC, ACTA and IC Regulations

FCC and ACTA Information

If this equipment was approved for connection to the telephone network prior to July 23, 2001, it complies with Part 68 of the Federal Communications Commission (FCC) rules. If the equipment was approved after that date, it complies with the Part 68 rules and with Technical Requirements for Connection of Equipment to the Telephone Network adopted by the Administrative Council for Terminal Attachments (ACTA). We are required to provide you with the following information.

1. Product identifier and REN information

The label on the back or bottom of this equipment contains, among other things, an identifier indicating product approval and the Ringer Equivalence Number (REN). This information must be provided to your local telephone company upon request. For equipment approved prior to July 23, 2001, the product identifier is preceded by the phrase "FCC Reg No." and the REN is listed separately. For equipment approved after that date, the product identifier is preceded by "US" and a colon (:), and the REN is encoded in the product identifier without a decimal point as the sixth and seventh characters following the colon. For example, the product identifier US:AAAEQ03T123XYZ would indicate an REN of 0.3.

The REN is used to determine how many devices you may connect to your telephone line and still have them ring when you are called. In most, but not all areas, the sum of all RENs should be five (5.0) or less. You may want to contact your local telephone company for more information.

2. Connection and use with the nationwide telephone network

The plug and jack used to connect this equipment to the premises wiring and the telephone network must comply with the applicable Part 68 rules and technical requirements adopted by ACTA. A compliant telephone cord and modular plug is provided with this product. It is designed to be connected to a compatible modular jack that is also compliant. An RJ11 jack should normally be used for connecting to a single line and an RJ14 jack for two lines. See Installation Instructions in the user's manual. This equipment may not be used with Coin Telephone Lines or with Party Lines. If you have specially wired alarm dialing equipment connected to your telephone line, ensure the connection of this equipment does not disable your alarm equipment. If you have questions about what will disable alarm equipment, consult your telephone company or a qualified installer.

3. Repair instructions

If this equipment is malfunctioning, it must be unplugged from the modular jack until the problem has been corrected. Repairs to this telephone equipment can only be made by the manufacturer or its authorized agents. For repair procedures, follow the instructions outlined under the Limited Warranty.

4. Rights of the telephone company

If this equipment is causing harm to the telephone network, the telephone company may temporarily discontinue your telephone service. The telephone company is required to notify you before interrupting service. If advance notice is not practical, you will be notified as soon as possible. You will be given the opportunity to correct the problem and the telephone company is required to inform you of your right to

FCC, ACTA and IC Regulations

file a complaint with the FCC. Your telephone company may make changes in its facilities, equipment, operation, or procedures that could affect the proper functioning of this product. The telephone company is required to notify you if such changes are planned.

5. Hearing aid compatibility

If this product is equipped with a corded or cordless handset, it is hearing aid compatible.

6. Programming/testing of emergency numbers

If this product has memory dialing locations, you may choose to store police, fire department and emergency medical service telephone numbers in these locations. If you do, please keep three things in mind:

- a. We recommend that you also write the telephone number on the directory card, so that you can still dial the emergency number manually if the memory dialing feature doesn't work.
- b. This feature is provided only as a convenience, and the manufacturer assumes no responsibility for customer reliance upon the memory feature.
- c. Testing the emergency telephone numbers you have stored is not recommended.

However, if you do make a call to an emergency number:

- You must remain on the line and briefly explain the reason for the call before hanging up.
- Programming/testing of emergency numbers should be performed during off-peak hours, such as in the early morning or late evening, when the emergency services tend to be less busy.

IC (Industry Canada)

This telephone is registered for use in Canada.

The term "IC:" before the radio certification number only signifies that Industry Canada technical specifications were met.

Notice:

This equipment meets the applicable Industry Canada Terminal Equipment Technical Specifications. This is confirmed by the registration number. The abbreviation, IC, before the registration number signifies that registration was performed based on a Declaration of Conformity indicating that Industry Canada technical specifications were met. It does not imply that Industry Canada approved the equipment.

Notice:

The Ringer Equivalence Number (REN) for this terminal equipment is 0.1. The REN assigned to each terminal equipment provides an indication of the maximum number of terminals allowed to be connected to a telephone interface. The termination on an interface may consist of any combination of devices subject only to the requirement that the sum of the Ringer Equivalence Numbers of all the devices does not exceed five.

FCC, ACTA and IC Regulations

Repairs to certified equipment should be made by an authorized Canadian maintenance facility designated by the supplier. Any repairs or alterations made by the user to this equipment, or equipment malfunctions, may give the telecommunications company cause to request the user to disconnect the equipment.

Users should ensure for their own protection that the electrical ground connections of the power utility, telephone lines and internal metallic water pipe system, if present, are connected together. This precaution may be particularly important in rural areas.

Caution :

Users should not attempt to make such connections themselves, but should contact the appropriate electrical inspection authority, or electrician, as appropriate.

Your **Cordless Phone** is designed to operate at the maximum power allowed by the FCC and IC. This means your Handset and Base Unit can communicate only over a certain distance - which will depend on the location of the Base Unit and Handset, weather, and the construction and layout of your home or office.

The RBRC® Seal



The **RBRC®** Seal on the nickel-cadmium battery indicates that VTech Communications, Inc. is voluntarily participating in an industry program to collect and recycle these batteries at the end of their useful lives, when taken out of service within the United States and Canada.

The **RBRC®** program provides a convenient alternative to placing used nickel-cadmium batteries into the trash or municipal waste, which may be illegal in your area.

VTech's participation in **RBRC®** makes it easy for you to drop off the spent battery at local retailers participating in the **RBRC®** program or at authorized VTech product service centers. Please call **1-800-8-BATTERY™** for information on Ni-Cd battery recycling and disposal bans/restrictions in your area. VTech's involvement in this program is part of its commitment to protecting our environment and conserving natural resources.

RBRC® is a registered trademark of Rechargeable Battery Recycling Corporation.

Technical Specifications

FREQUENCY CONTROL

Crystal controlled
PLL synthesizer

(including antenna)

WEIGHT

Handset : 178.7 grams
Base : 303.8 grams
(excluding battery pack)

TRANSMIT FREQUENCY

Base: 2411.15 - 2418.4 MHz
Handset: 912.75 - 917.10 MHz

POWER REQUIREMENTS

Handset: 3.6V 400mAh Ni-Cd
Battery Pack

RECEIVE FREQUENCY

Base: 912.75 - 917.10 MHz
Handset: 2411.15 - 2418.4 MHz

Base : 9V DC @ 500mA

CHANNELS

30 Channels

MEMORY

Speed Dial: 10 Memory locations
16 digits per location

NOMINAL EFFECTIVE RANGE

Maximum power allowed by FCC and IC. Actual operating range may vary according to environmental conditions at the time of use.

**SPECIFICATIONS ARE TYPICAL AND
MAY CHANGE WITHOUT NOTICE.**

SIZE

Handset :203.3mmx56.0mmx39.8mm
(including antenna)

Base :168.1mmx130mmx114mm

vtech

VTECH TELECOMMUNICATIONS LTD.

A member of THE VTECH GROUP OF COMPANIES.

Distributed in the U.S.A. by VTech Communications Inc.; Beaverton, Oregon.

Distributed in Canada by VTech Electronics Canada Ltd., Suite 200, 7671 Alderbridge Way, Richmond, B.C. V6X 1Z9.

Copyright 2002 for VTECH TELECOMMUNICATIONS LTD.
Printed in China

91-5449-10-00
ISSUE 0

Table of Contents

Important Safety Instructions	1
Introduction	2
Parts Check List	2
Getting Started	3
Setup	3
Setup	4
Handset Features	5
Base Unit Features	6
Basic Operation	7
Operating Instructions	7
Making Calls	7
Answering Calls	7
Disconnecting	7
Changing Channels	8
TONE/PULSE Setting	8
Temporary Tone	8
Programming the Ringer Type	8
Turning Off the Ringer	8
Checking the Ringer	9
Memory Dialing	9
Programming Speed Dial Numbers	9
Speed Number Dialing	9
To Change or Replace a Speed Dial Number	9
Storing Pauses in Memory	10
Using Redial	10
Storing a Redial Number into Speed Dial	10
The Page Feature	10
Advanced Operation	11
Answering System Operation	11
Introduction	11
Call screening from Base Unit	11
Call Screening from Handset	11
Handset Layout For Answering System Operation	12
Answering System Setup	13
Set Outing Message	13
Set Security Code	13
Set Audible Message Alert	13
Set Announce Only	13
Set Base Rings	14
Set Number of Rings	14
Checking and Setting Day and Time	14
Recording a Memo	15
Turning Your Answering System ON/OFF	15
Play back of Greetings, Messages and Memos	16
Remove Operation of Your VT2458 Answering System	17
Additional Information	18
Headset Operation	18
Belt Clip	18
Maintenance	19
In Case Of Difficulty	20
Warranty Statement	22
FCC, ACTA and IC Regulations	25
The RBRC® Seal	28
Technical Specifications	29

Free Manuals Download Website

<http://myh66.com>

<http://usermanuals.us>

<http://www.somanuals.com>

<http://www.4manuals.cc>

<http://www.manual-lib.com>

<http://www.404manual.com>

<http://www.luxmanual.com>

<http://aubethermostatmanual.com>

Golf course search by state

<http://golfingnear.com>

Email search by domain

<http://emailbydomain.com>

Auto manuals search

<http://auto.somanuals.com>

TV manuals search

<http://tv.somanuals.com>