

# Introduction

---

Thank you for choosing **VTech GiGA5.8x**, the most advanced cordless telephone operates in the **5.8GHz** frequency range. Upgraded with a large colour LCD display and lots of extra features, **GiGA5.8x** brings convenience and pleasure to your daily communication with your loved ones.

This manual is designed to familiarise you with the **GiGA5.8x VT5801** Accessory Handset setup, registration and basic functions. For detailed operational instructions, please refer to your **GiGA5.8x VT5836** or **VT5886** User's Manual.

## Important:

The **VT5801** is an Accessory Handset for use with the **GiGA5.8x VT5836** or **VT5886** systems. You must have one of these Base Units in order to use the **VT5801** Accessory Handset.



**If you have questions about this product, or if you're having difficulty with setup or operation, do not return your phone to the store. Call our Customer Service at: 852-2776 3223**

# Important Safety Instructions

---

When using your telephone equipment, basic safety precautions should always be followed to reduce the risk of fire, electric shock and injury, including the following:

1. Read and understand all instructions.
2. Follow all warnings and instructions marked on the product.
3. Unplug this product from the wall outlet before cleaning. Do not use liquid cleaners or aerosol cleaners. Use a damp cloth for cleaning.
4. Do not use this product near water (for example, near a bath tub, kitchen sink, or swimming pool).
5. Do not place this product on an unstable cart, stand, or table. The product may fall, causing serious damage to the product.
6. Slots and openings in the cabinet and the back or bottom are provided for ventilation. To protect it from overheating, these openings must not be blocked by placing the product on the bed, sofa, rug, or other similar surface. This product should never be placed near or over a radiator or heat register. This product should not be placed in a built-in installation where proper ventilation is not provided.
7. This product should be operated only from the type of power source indicated on the marking label. If you are not sure of the type of power supply to your home, consult your power company.
8. Do not allow anything to rest on the power cord. Do not locate this product where the cord will be abused by persons walking on it.
9. Never push objects of any kind into this product through cabinet slots as they may touch dangerous voltage points or short out parts that could result in a risk of fire or electric shock. Never spill liquid of any kind on the product.
10. To reduce the risk of electric shock, do not disassemble this product. Opening or removing cabinet parts other than specified access doors may expose you to dangerous voltages or other risks. Incorrect reassembling can cause electric shock when the appliance is subsequently used.
11. Do not overload wall outlets and extension cords as this can result in the risk of fire or electric shock
12. Unplug this product from the wall outlet and refer servicing to VTech under the following conditions:
  - A. When the power supply cord or plug is damaged or frayed.
  - B. If liquid has been spilled into the product.

## Important Safety Instructions

---

- C. If the product has been exposed to rain or water.
  - D. If the product does not operate normally by following the operating instructions. Adjust only those controls that are covered by the operating instructions, because improper adjustment of other controls may result in damage.
  - E. If the product has been dropped and the cabinet has been damaged.
  - F. If the product exhibits a distinct change in performance.
- 13.** Avoid using a telephone (other than a cordless type) during an electrical storm. There may be a remote risk of electric shock from lightning.
- 14.** Do not use the telephone to report a gas leak in the vicinity of the leak.

**VTECH ELECTRONICS (HK) LTD.**

Customer Service: 852-2776 3223.

**SAVE THESE INSTRUCTIONS**

## Parts Check List

1. Handset
2. Charger Wall Mounting Bracket
3. Belt Clip
4. Handset Charger
5. Software CD-ROM Disc
6. Battery Pack
7. User's Manual
8. Audio Patch Cable
9. USB Cable



Handset

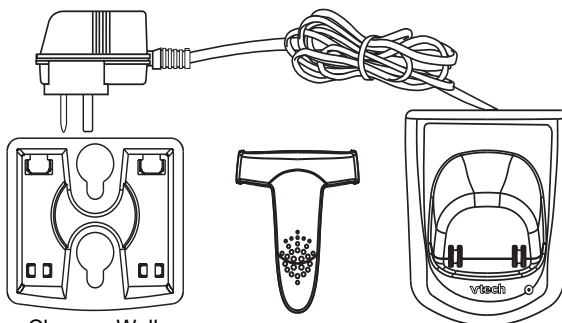

Charger Wall Mounting Bracket

Belt Clip

Handset Charger

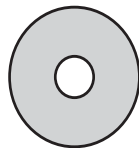

Software CD-ROM Disc

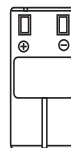

Battery Pack

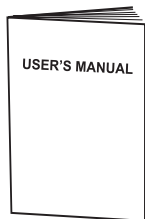

User's Manual

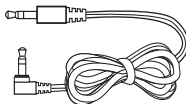

Audio Patch Cable

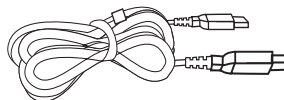

USB Cable

# The Handset Layout

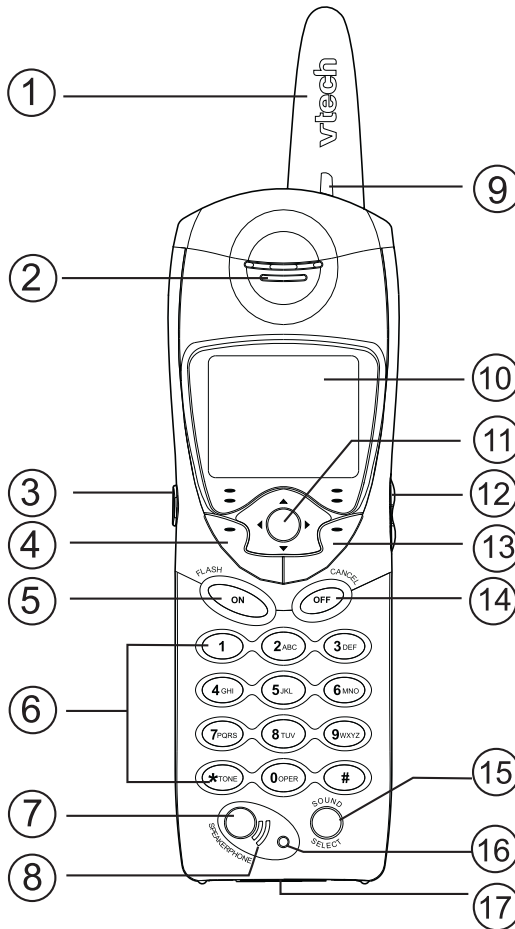

- |  |                        |
|--|------------------------|
| 1. Antenna   | 10. Colour LCD Display |
| 2. Earpiece  | 11. 5 -Way Joystick    |
| 3. Headset Jack and Audio Patch Cable Jack (2.5mm) | 12. Volume Keys        |
| 4. Soft/Select Key                                 | 13. Soft Key           |
| 5. On/Flash Key                                    | 14. Off/Cancel Key     |
| 6. Dialing Keys (0-9, * , #)                       | 15. Sound Select Key   |
| 7. Speakerphone Key                                | 16. Microphone         |
| 8. Speakerphone LED                                | 17. USB Cable Jack     |
| 9. Message Waiting /In Use/ Incoming Ringing LED   |                        |

## Setup

### Connecting Power to Handset Charger

Because the **VT5801** is an accessory Handset to the **VT 5836** or **VT5886**, all you need to do is choose the location for your Handset Charger, and plug in the power supply into an electrical outlet.

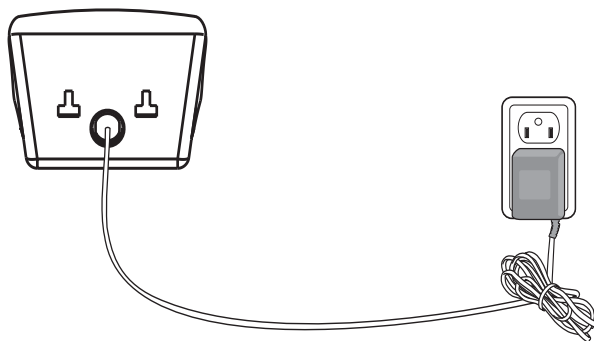

### Installation and charging of Battery Pack in Handset

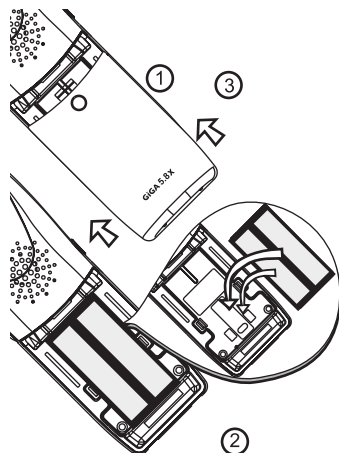

Follow the steps below:

1. Remove the battery compartment cover by pressing on the indent and sliding downward.
2. Place the new battery pack in the Handset with the metal contacts aligned with the charge contacts in the battery compartment.
3. Replace the battery compartment cover by sliding it upwards.
4. Place the Handset in the charger, and allow to charge for at least 12 hours.
5. Please note that the first charging after prolonged storage may yield a lower capacity than normal. However, capacity will be restored after 2 to 3 charging/discharging cycles.
6. After the first charge, a maintenance charge of 8 hours will be sufficient.

## Setup

---

### Battery Life

A fully charged battery provides an average talk time of about 8 hours or standby time of 5 days.

**NOTE:** Talk time and standby time may vary depending on operating conditions.

### Battery Indicator

Ten minutes before the battery charge level gets too low to operate the Handset, an empty battery icon will start flashing, five short tones are generated, and a LOW BATTERY message is displayed.

If you continue to use the Handset without charging or replacing the battery (spare battery purchased separately), the Handset will turn off automatically when the battery charge level is no longer sufficient to power up the Handset, and the call will be dropped.

### Charging the Handset Battery Pack

After a low battery indication, place the Handset in the charger, and ensure that the CHARGING light turns on.

With the exception of the first charge, the battery pack is typically charged in 8 hours.

**NOTE:** If you repeatedly get a low battery indication, even after 8 hours of charging, then the battery should be replaced.

As you register additional Handsets to VT5836 or VT5886 system, they will be assigned extension numbers in the following order: **HANDSET 2, HANDSET 3, HANDSET 4**, and so forth.

Whenever a charged Handset battery pack is installed, the Handset will automatically begin **Searching For Base...** (if previously registered), or it will prompt you to **Enter Base ID** to register the new Handset.

**BEFORE USING YOUR HANDSET(S), CAREFULLY PEEL OFF THE PROTECTIVE FILM, COVERING THE DISPLAY.**

## Registration

### Registering an VT5801 Handset for the first time

After charging, the screen will display:

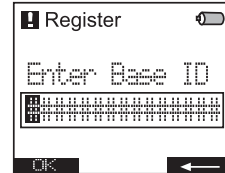

Find the **BASE ID Code** by doing the following (Base must be OFF):

- 1) At the Base, press **MENU**.
- 2) Scroll down to **DISPLAY BASE-ID**, then press **OK**.
- 3) Enter the 15-digit Base ID Code into the Handset. If you make a mistake, move the joystick to the left ( ◀ ) to backspace or press the right softkey ( ← ) to erase a character.
- 4) Press **OK** to complete the registration process.

**NOTE:** If the Handset, after charging, says “**Searching for Base...**”, press the **NEW** soft key. “**Enter Base ID**” will now be displayed. Follow the steps above.

Wait approximately 15-60 seconds. You will hear confirmation beeps from the Base and Handset. The newly registered Handset will now be assigned the lowest extension number not previously assigned to a different system Handset (1 - 6).













If you do not enter the correct digit sequence, you will see “**Invalid Base ID!**” and hear an **error** tone. move the joystick to the left ( ◀ ) to backspace or press the right softkey ( ← ) to erase a character, and carefully re-enter the **Base ID Code**.

**NOTE:** The 15-digit **BASE ID Code** may contain numbers and characters, such as \*. **Make sure you carefully enter all 15 digits.**



# Handset Indicators

## Handset Icons

Icon	Description
 	<p>Line In Use Indicator</p> <ul style="list-style-type: none"> <li>On steady with one or more numbers next to it, indicating which extensions are using the line. For example,  12 indicates that Handset 1 and Handset 2 are on an outside call.</li> <li>Appears in idle or phone on modes to indicate a parallel set in use. It replaces phone on icon during phone on mode and parallel set is detected.</li> </ul>
	<p>Handset Number Indicator</p> <ul style="list-style-type: none"> <li>Indicates the Handset number. It's permanently displayed at the top left corner after the Handset has found the Base.</li> </ul>
	<p>Searching for Base Indicator</p> <ul style="list-style-type: none"> <li>Indicates that the Handset is still searching for the Base.</li> </ul>
	<p>Intercom Indicator</p> <ul style="list-style-type: none"> <li>On steady with the extension numbers currently on an intercom call. For example,  02 indicates that the Base and Handset 2 are on intercom call.</li> </ul>
<p>H</p>	<p>Hold indicator</p> <ul style="list-style-type: none"> <li>On steady when the line is on hold.</li> </ul>
<p>M</p>	<p>Mute indicator</p> <ul style="list-style-type: none"> <li>On steady when the Handset microphone is muted.</li> </ul>
	<p>Ringer Off indicator</p> <ul style="list-style-type: none"> <li> is displayed when the ringer is turned off.</li> </ul>
	<p>Battery indicator</p> <ul style="list-style-type: none"> <li>When the Handset is removed from the charger, this lets you know the level of charge in the battery pack, from <b>FULL</b> () to <b>EMPTY</b> (.</li> <li>Cycles (Low, Medium, and Full) when Handset battery is charging.</li> <li>Flashes when a low battery condition is detected.</li> </ul>
	<p>Answering Machine Indicator</p> <ul style="list-style-type: none"> <li>Indicates that the answering machine is answering an incoming call</li> </ul> <p>Note: This is only applicable to the Handset registered with intergrated Base Answering Machine.</p>

# Handset Menu

## Joystick Operation

- This Handset is equipped with a 5-way navigation joystick: **Left** (◀), **Right** (▶), **Up** (▲), **Down** (▼), and **In** (●).
- The joystick allows you to access the Handset's advanced features and settings.
- Press the joystick in **any direction** to access the Main Menu when in idle or screen saver mode.
- Press joystick **Left** (◀), **Right** (▶), **Up** (▲), or **Down** (▼), to navigate through the menu screen.
- Press joystick **In** (●) to make a selection. Alternatively, pressing the left softkey in some screens will also allow you to select the highlighted option.

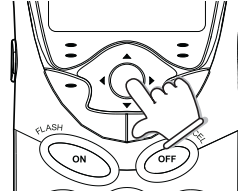

## Menu Shortcuts

- When viewing menu options, pressing the corresponding number on the dialing keypad will automatically go to and select that item.
- For example, in the Main Menu screen, pressing the 1 key will automatically take you to the Intercom menu screen, pressing the 6 key will automatically take you to the Settings menu screen.
- Similarly, when viewing a list menu, pressing the corresponding number will automatically select that option, and save it, if necessary. For example, pressing the 2 key when in the Appearance screen will select and save the GREEN option.

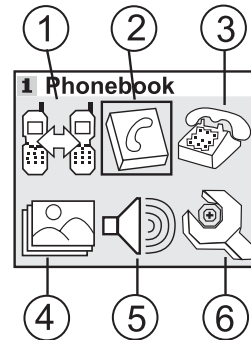

## Main Menu

Press the joystick **in** or left soft key to display the 6 menu options. Then use the joystick to navigate to the desired menu option for selection. You can also press the dialing key assigned for each icon (see information below for the assigned keys), to activate the menu option.

**Intercom**  (dialing key 1) - talk between

Handsets(s) and Base Unit, or use to page the cordless Handset(s).

**Phonebook**  (dialing key 2) - enter and retrieve up to 50 names and phone numbers, along with a distinctive ring and image for each.

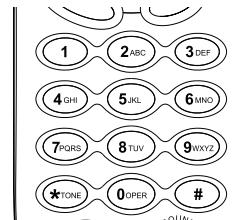



1. Intercom
2. Phonebook
3. Calls Log
4. Pictures
5. Sounds & Alerts
6. Settings





## Handset Menu

**Calls Log**  (dialing key 3) - review Caller ID data; select and dial from the Caller ID data or from the Redial list that accounts for the last 10 dialed phone numbers.

**Pictures**  (dialing key 4) - choose from the many preset images or download new images into the Handset to be used as your idle screen (wall paper) or assign an image to a specific phonebook directory.

**Sounds & Alerts**  (dialing key 5) - Record custom sound clips, turn ringer and vibrate feature on and off, select main ringer tone, turn tones (low battery, keypad, and out-of-range) on and off.

**Settings**  (dialing key 6) - Set the time; adjust screen contrast; reset to default settings; change color of the text; register new Handsets; change screen language.

Press the joystick , ,  or  to navigate to the desired menu option. You can also press the dialing key assigned to each menu item. The top menu is assigned to dialing key 1 and so forth on the menu.

### Intercom

#### From Handset to Base

- With the **Intercom** icon highlighted, press the joystick **in** or assigned dialing key to reveal your intercom options, for example:
- With the Base option highlighted, press the joystick **in** or press the left soft key for confirmation. Or, press the assigned dialing key 0. The screen will display:
- The Base will ring, then automatically enter intercom mode.
- To end the intercom call, press **OFF** on the Handset or **INTERCOM** on the Base.

#### 1 Intercom Call

Base  
Handset 2  
GLOBAL PAGE

#### Calling Base





#### 1 Intercom Call

Base  
Handset 2  
GLOBAL PAGE

#### Calling Handset 2



#### From Handset to Handset

- With the **Intercom** icon highlighted, press the joystick **in** or press the left soft key.
- Press the joystick  or  to navigate to the desired Handset. Press the joystick **in** or press the left soft key for confirmation. Or press the assigned dialing key (1 – 6) directly.
- The ringing Handset can respond by pressing **ON** or any of the number keys.
- To end an intercom call, press **OFF** on either Handset.

## Handset Menu

### Global Page from Handset

- With the **Intercom** icon highlighted, press the joystick **in** or press the left soft key.
- Press the joystick **▲** or **▼** to navigate to **GLOBAL PAGE** or press “ \* ” key.
- Press the joystick **in** or press the left soft key for confirmation.
- Any registered Handset or Base can answer the global page, thus entering Intercom mode.
- To end the intercom call, press **OFF** on the Handset or **INTERCOM** on the Base.

1 Intercom Call  
Base  
Handset 2  
**GLOBAL PAGE**

Performing  
global page



### Phonebook



With this icon highlighted, press the joystick **in** or press the left soft key to reveal the contents of your phonebook. If there are no entries, the screen will display **Phonebook is empty**. The **VT5801** can store up to 50 names/numbers in the phonebook directory, along with a distinctive ring and image for each directory. Each memory location can hold up to 32 digits and up to 16 characters, including space, for the name.

When prompted to **ENTER NAME**, use the digit keys to ‘spell’ the name. Each press of a particular key causes characters to be displayed in the following order:

Number Key	Characters (in order)
1	& ' , . 1
2	A B C a b c 2
3	D E F d e f 3
4	G H I g h i 4
5	J K L j k l 5
6	M N O m n o 6
7	P Q R S p q r s 7
8	T U V t u v 8
9	W X Y Z w x y z 9
0	0
*	✕
#	#

# Handset Menu

## Adding Phonebook Entries

- From the Handset idle (**OFF**) mode, press the joystick in **any direction** or press the left softkey. The **Phonebook** icon should be highlighted. Press the joystick **in** or left soft key again.

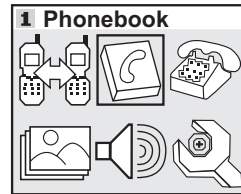

- Press **NEW**.

**NOTE:** When phone book is full, pressing NEW, "Phonebook is Full" displays and an error tone sounds.

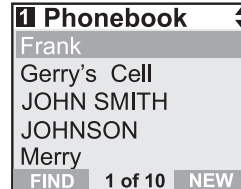

- You will then be prompted to **Enter Name**. Use the digit keys to 'spell' the name. If you make a mistake, press the  softkey. You can add a space between characters by pressing the **1** key. When finished, press **OK**.

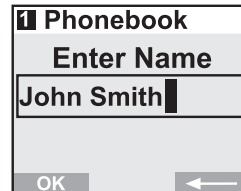

- Enter the number you want to store in **Phonebook**. Press and hold the **#** key to insert a pause. When finished, press **OK**.

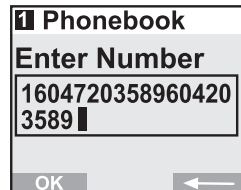

- The screen will display:

**NOTE:** If there is no need to have distinctive ringing pattern and distinctive image, you can press **SAVE** now.

- If you wish the phone to alert you to calls from this number by changing to a distinctive ringing pattern, press the joystick **▲** or **▼** to scroll to **RINGER** : **◀ Default ▶**.
- Press the joystick **◀** or **▶** to sample the ringer options.



— OR —

- Press the joystick **in** then press the joystick **▲** or

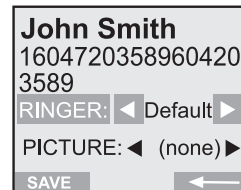

## Handset Menu

- ▼ to sample the ringer options.
- Press **OK** for confirmation.

**NOTE:** There are 8 traditional ring tones and 12 recorded personal ringers. For Recordable Ringer, please refer to page 20 for details.

**NOTE:** If there is no need to have distinctive image, you can press **SAVE** now.

- If you wish to be visually alerted to calls from this number by changing to a distinctive image, press the joystick ▲ or ▼ to scroll to **PICTURE : ◀ (none) ▶**.
- Press the joystick ◀ or ▶ to sample the pictures and images options.  
— OR —
- Press the joystick **in** then press the joystick ▲ or ▼ to sample the pictures and images options.
- Press **OK** for confirmation.

**NOTE:** To create your own pictures, please refer to page 21 for details.

- Once you've selected a picture, press **SAVE**.
- Your phonebook entry has been saved and the screen will display:

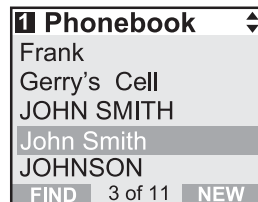
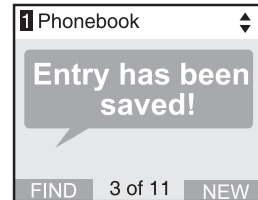
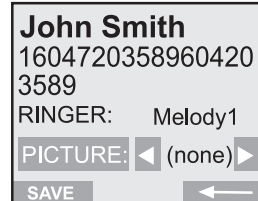

### Searching for and Dialing Phonebook Entries

- From the Handset idle (**OFF**) mode, press the joystick **in any direction**. The Phonebook icon should be highlighted. Press the joystick **in** or left soft key again.
- Press the joystick ▲ or ▼ to scroll through the contents in alphabetical order.

— OR —

You can enter the first characters of the name directly. The closest match, in alphabetical order, will be displayed

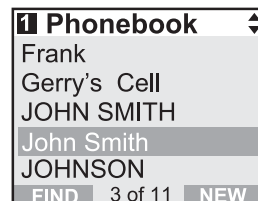
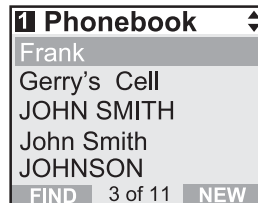

# Handset Menu

— OR —

You can press **FIND** softkey, enter the first few characters of the name and then press **OK** to search. If you make a mistake, press **←** softkey. The closest match, in alphabetical order, will be displayed.

- Once you can find the entry you want, simply press **ON** or **SPEAKERPHONE** to dial the number.

## Editing Phonebook Entries

- Following the first 2 steps in **Searching for and Dialing Phonebook Entries**, locate the entry you want to edit.

- Press the joystick **in**. The screen will display:
- Press **EDIT** softkey.

- Press the joystick **▲** or **▼** to the option you want to edit then enter the corrections as needed. Press the softkey **←** for deleting.

- When finished, press the **SAVE** softkey. The screen will display the edited entry.

## Deleting Phonebook Entries

- Following the first 2 steps in **Searching for and Dialing Phonebook Entries**, locate the entry you want to delete.

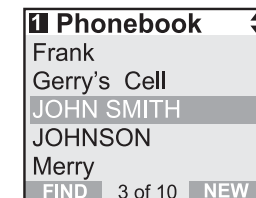
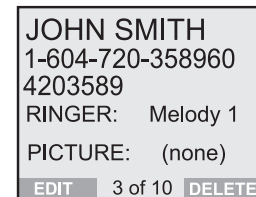
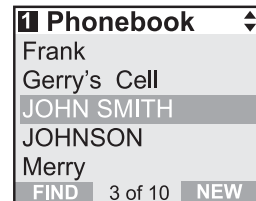
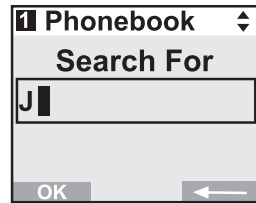

## Handset Menu

- Press the joystick **in**. The screen will display:

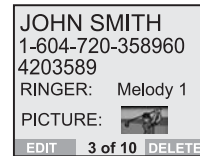

- Press **DELETE** softkey. The screen will display:
- To confirm the deletion, press **YES**. To exit without deleting, press **NO**.

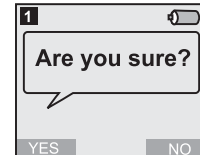

### Calls Log



With this icon highlighted, press the joystick **in** or left soft key to view your Caller ID and Redial options:

**Review CID Log**  
**Clear CID Log**  
**Review Redial**  
**Clear Redial**

Move the joystick **▲** or **▼** to highlight the desired option, then press the joystick **in** or press the left soft key. You can also press the dialing key assigned to each menu item. The top menu is assigned to dialing key 1 and so forth on down the menu.

**NOTE:** you can also view your Caller ID and Redial options from the Idle Menu by selecting the **REDIAL** and **CID LOG** using the soft keys.

**Review CID Log** (dialing key 1)- allows you to scroll through the 50 current Caller ID and Call Waiting records received. With a CID record displayed, you can **SAVE** it in the phonebook, press **ON** or **SPEAKERPHONE** to dial the number, or **DELETE** the entry from the log.

**Clear CID Log** (dialing key 2)- choose this option if you want to delete all CID records at once. You will be asked **Are you sure?** Choosing **YES** clears all records. Choosing **NO** returns you to the previous screen.

**Review Redial** (dialing key 3)- select this option to display the last 10 numbers you dialed. Use the joystick to highlight the desired number, press and hold joystick **in** to view numbers that are longer than 11 digits, then press **ON** or **SPEAKERPHONE** to dial. You can press **SAVE** to save it in the phonebook, or press **DELETE** to erase.



## Handset Menu

**Clear Redial** (dialing key 4) - select this option to delete all phone numbers stored in redial memory. You will be asked Are you sure? Choosing **YES** clears all records. Choosing **NO** returns you to the previous screen.

### Settings



With this icon highlighted, press the joystick **in** or left soft key to reveal the following menu:



**Set Time**(dialing key 2) - this option allows you to set the time to be displayed on the bottom of the idle screen. If you subscribe to Caller ID, this feature will set and update the clock.

**NOTE:** Press the number key for changing the time.



**Contrast**(dialing key 3) - this option allows you to adjust the Handset screen contrast.



**Reset Settings**(dialing key 6) - this option allows you to return the Handset to factory-preset settings. There are 4 options can be reset:

- Clear My Clips**
- Clear My Pictures**
- Clear Phonebook**
- Default Settings**

Choose the desired option that you want to reset. You will be asked **Are you sure?** Choosing **YES** for reset. Choosing **NO** returns you to the previous screen.



**Language** (dialing key 5, preset to English) - this option allows you to change the screen prompts to English, Spanish or French.



**Register**(dialing key 4)- this options will allow you to return the Handset to the **Enter Base ID** screen.



**Appearance**(dialing key 1) - this option allows you to change the color of the text at the top and bottom of the Handset screen. Your color choices are:

- Blue**
- Green**
- Tan**
- Rose**

Press the joystick  to navigate to the desired option and to make the change, or press the dialing key that is assigned to the icon.

For confirmation, press the joystick **in** or press **SAVE** softkey.

## Handset Menu

### Sounds & Alerts



With this icon highlighted, press the joystick **in** or left soft key to reveal the following options:



**Ringer Control**(dialing key 2) - this option allows you to change the Ringer Volume, turn the Ringer **On/Off** and control the Vibrating Ringer.



**Ringers**(dialing key 3) - this option allows you to assign a new Ring Tone. You can choose one of 8 traditional ringers, and 12 musical ringers to choose from. Please refer to the **Recordable Ringer** section on page 20 for details on how to record your own personalized ringer.



**Range Tone**(dialing key 6)- this option allows you to turn the Range Tone **On/Off**.



**Keypad Tone**(dialing key 5) - this option allows you to turn the Keypad Tone **On/Off**



**Low Battery Tone**(dialing key 4)--this option allows you to turn the Low Battery Tone **On/Off**



**Sound Clips**(dialing key 1)- this option allows you to record and access your personal melodies. See the section **Ringer C.I.Y.** on page 20 for details.

Press the joystick  to navigate to the desired option and to make the change, or press the dialing key that is assigned to the icon.

For confirmation, press the joystick **in** or press **SAVE** softkey.

### Pictures



Your **VT5801** is preset with the following number of images:

**My Pictures – 10 images**

**Images – 9 images**

**Emotions – 10 images**

**CD ROM – 15 new images (not stored in handset)**

You have the ability to assign one image as your background for the idle

## Handset Menu

---

screen (wall paper) or assign a specific image to a phonebook directory in the available 50 directories.

### Set a Wallpaper image

To set a wallpaper image, select the icon **Pictures**  in the main menu. Then choose an image in one of the three (**My Pictures**, **Images** or **Emotions**) menu options. Once you have selected the image, press the **SET** soft key to set the image as your wallpaper. You will receive a message on the screen confirming "**Wallpaper Set!**" and an audio confirmation.

To assign a personal image into your Handset, see the Picture Download section in page 21 for instructions.

**NOTE:** After 30 seconds of inactivity, your Handset will go into idle mode. While in idle mode, your handset will display a digital clock. To illuminate the idle screen and read the clock, simply press the volume button.

### Clear a Wallpaper image



To set a wallpaper image, select the icon **Pictures**  in the main menu. Press the joystick up or down until **Clear Wallpaper** is highlighted. Then press the joystick **in** or left soft key to clear the wallpaper.

## Ringer C.I.Y.

You can easily record a unique ringer to be used as either your Default Ringer or for a Distinctive Ringer for assigning to a individual phonebook directory. You can either record using the provided Audio Patch Cord (not the USB cord), or simply use the Handset microphone. You are allowed to record 9 unique ringers for a maximum of 10 seconds each.

**Note:** Your **VT5801** Handset is preset with many musical (i.e. Jazz, R&B, Reggae, Rock, etc) ringer options for you to use as your default ringer or a distinctive ringer for a phonebook directory. Three of them are protected. You can't replace them. You can replace the other 6 preset ringers with your own ones. Or you can record your own ringers in another 3 blank locations in "My Clips". You may find 10 additional sound clips excluding what preset in the Handset on the accompanied CD-ROM.

To record a ringer, follow these steps.

- Select the **Sounds & Alerts** icon  in the Main Menu.
- Select the **Sound Clips** icon .
- If you are using the Audio Patch Cord, insert the 3.5mm plug (larger plug) into the headset jack of your PC or audio source. Insert the 2.5mm plug (smaller plug) into the Headset jack on the side of the **VT5801** Handset.
- You can listen to the playing music through your Handset speaker after connecting the Audio Patch Cord when selecting the **Record Preview** menu option. Adjust the recording volume at the audio source, if necessary. When you hear what you desire to record, press **RECORD**.
- If you want to use the Handset microphone to record ringers, select the **Record Clip** menu option. Start recording after you hear a beep.
- Hit the **STOP** soft key when you want to stop the recording.
- After the recording is finished, you have the choice to **PLAY** or **SAVE** the recording. If you Save your recording, it will prompt **Enter Clip Name**. Enter a name for the recorded melody. If you make a mistake, press  soft key to backspace. Press **SAVE** to confirm. "**Clip has been saved**" will display. The melody will be stored in the My Clips section. You can listen to all of your recorded musical ringers in **My Clips**.

**Note:** When you want to use the Handset microphone to record ringers, do not insert the Audio Patch Cord into the headset jack.

# Picture Download

## Download your own image

Do you have a favorite image stored in your personal computer that you would like to use as your **VT5801** wallpaper or to assign to one of your 50 available phonebook directories? Using the provided Image Editor Software, you can view and convert your image. Once you have selected your file and viewed your image in the software, use the included USB cord to send the converted image directly into the Handset. You'll start by downloading the software into your computer:

### ONE-TIME SOFTWARE INSTALLATION

1. Insert the enclosed Image Editor Tool CD into your personal computer.
2. You will immediately see a pop-up window giving you three options:
  - a. Install/Uninstall the Vtech **VT5801** Image Editor
  - b. Browse the installation CD
  - c. Visit Vtech on the web



To install the software, click on the **Install/Uninstall the Vtech VT5801 Image Editor** icon  and follow the download instructions.

3. After the installation process is complete, you will find a **Vtech VT5801 Image Editor** icon  on your PC desktop. Click on this icon to run the Image Editor software.

Once you have installed the software, follow these steps to view and convert your selected image.

### Image Download

- Click on the **OPEN**  icon, Then the pictures in the accompanied CD-ROM Disc can be found automatically. Or navigate to the directory where your desired image file is stored, and open the file.
- You will see your image displayed in the middle of the screen and inside the telephone display on the right. You can select the following options to edit your image:

  -Zoom In and Zoom Out

  -Rotate Left and Rotate Right

## Picture Download

---



-Adjust Brightness and Contrast



-Adjust Color

- Before downloading your image, make sure that the provided USB cord is correctly installed into your computer (using the large connector) and Handset (using the small connector). After you have completed the image editing process, press **Send to Phone**  and then your image will be downloaded into the Handset. Within a few seconds, you will see the new image displayed on your Handset and it will be saved in your **My Pictures** directory. You have the option to either **SET** (set the picture to be wall paper) or **DELETE** the downloaded image. You are able to have a total of 14 images stored in the **My Pictures** directory. You can delete the preset images in this directory. Additional image samples can be found on the accompanying CD-ROM.

**NOTE:** Do not leave the USB cord connected to the Handset for an extended period of time. This will drain battery.

**NOTE:** All preset images in My Pictures can be deleted and replaced by new ones. You can record 14 images in My Pictures in total.

# Handset Operation

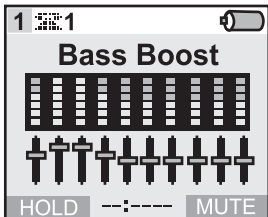
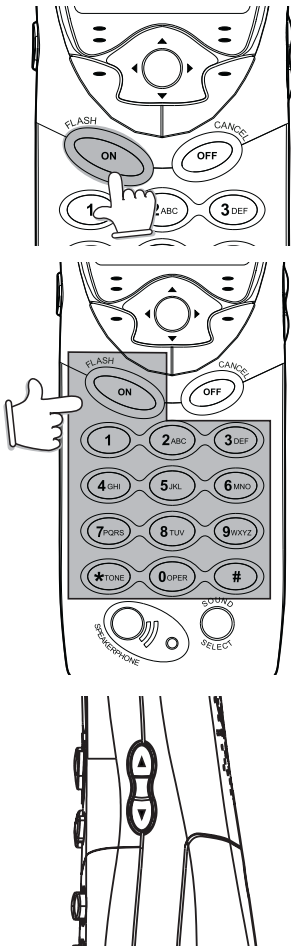

## Making Calls

From the Handset



- Press **ON** (or, **SPEAKERPHONE** to use the Handset Speakerphone feature). Dial the phone number.

-OR-

Dial the phone number first; then press **ON** (or **SPEAKERPHONE**).

- Press **OFF** to end your call or place the Handset in charger cradle to end your call.

## Answering Calls

From the Handset



- Press any key except **OFF** and the softkeys.
- Press **OFF** to end your call.

-OR-

- Place the Handset in charger cradle to end your call.

## How to Adjust the Handset Volume

The volume control is on the **right** edge of the Handset. During a call, press the **▲** or **▼** key to adjust the listening volume to a comfortable level. The procedure is the same for the Handset earpiece, Headset and Speakerphone.

## Sound Select

The Sound Select feature incorporates the latest in acoustic design, and provides four different sound quality settings to suit your preference, providing a more comfortable telephone conversation.

During a call, you can adjust the quality of the sound to best suit your hearing. Pressing **SOUND SELECT** repeatedly will cycle you through four different frequency responses:

**BASS** - Low Frequency sounds enhanced

# Handset Operation

**MID** - Mid-Range sounds enhanced  
(This is the recommended setting for hearing aid users)

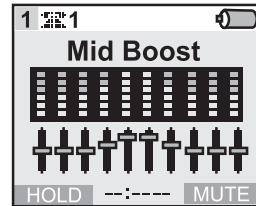

**TREBLE** - High Frequency sounds enhanced

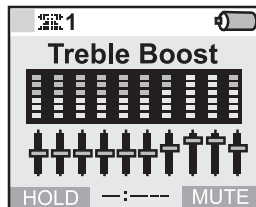

**NATURAL** - No frequency enhancement (Your Handset is preset with this selection)

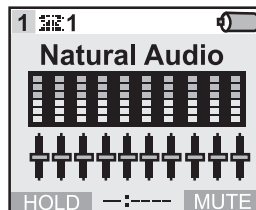

The Handset will graphically display the four modes.

**NOTE:** The Sound Select feature can't be use when in Speakerphone or Headset talking mode.

## Mute Function

During an active call pressing either the **MUTE** soft key on the Handset or the **MUTE** softkey on the Base (when in Speakerphone mode), will disable the microphone. Press **MUTE** again to return to normal 2-way conversation.

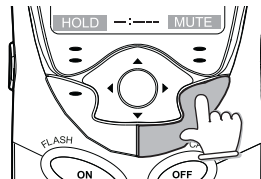

## Hold Function

### From the Handset :

- Press the **HOLD** soft key to place a call on hold. To return to the call, press the **ON** (or **SPEAKERPHONE**) key.

**Note:** The Handset will display **CALL ON HOLD** when a call is placed on hold. If you have new calls in call log, "**CALL ON HOLD**" will display alternately. After 5 seconds, An **H** will be displayed to remind you a call is on hold.

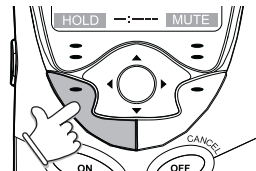

If a call remains on Hold for 5 minutes, your **VT5801** will ring to remind you the call is being held. The phone will display **Call On Hold Ring Back!** You have 30 seconds to return to the call before it is dropped.



# Handset Operation

## Flash Function

You can use your **VT5801** with services such as Call Waiting. Simply press the **ON/FLASH** key on the Handset

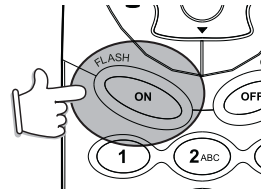

## Conference Calling

The **VT5836** or **VT5886** is capable of supporting conference calls with up to two registered Handsets, and the Base Unit. To enter a conference call, simply access the line with two or more extensions by pressing **ON** (or **SPEAKERPHONE**) on the Handset or **SPEAKERPHONE** on the Base. The phone icon  and two or more extension numbers will be displayed in the upper left corner of the Handset display.

## Transferring Calls

You can transfer calls from your **VT5801** to other registered Handsets or to the Base without notification (Blind Transfer) or with notification (Announced Transfer) by doing the following steps:

### Blind Transfer

- Press the joystick **in** then press joystick **▲** or **▼** to the desired destination.
- Press the joystick **in** again for confirmation.
- The ringing Handset or Base can pick up the transferred call just like any incoming call.

### Announced Transfer

- Press **HOLD** to place your call on hold.
- Press the joystick in any direction then press joystick **◀** to **Intercom**, press the joystick **in** again for confirmation.
- OR-
- Press the joystick in any direction then press the dialing key 1.
- Press joystick **▲** or **▼** to the desired destination.
- For confirmation, press the joystick **in** again.
- When the ringing Handset or Base answers, announce that there's an active call on hold.
- Press **OFF** (on the Handset) or **INTERCOM** (on the Base).
- Press **ON** (on the 'destination' Handset) or **SPEAKER PHONE** (on the 'destination' Base) to pick up the call on hold.

## Headset Accessories

Your **VT5801** cordless Handset is equipped with a 2.5mm Headset Jack for use with an optional accessory Headset for hands-free operation. If you choose to use the Headset option, you must obtain an optional accessory Headset, which is compatible with the **VT5801**.

**To purchase a Headset, call VTech Customer Service at 852-2776 3223.**

Once you have a compatible 2.5mm Headset, locate the Headset Jack on the Handset. Connect the plug on the Headset cord to the jack (covered with a small rubber flap) on the cordless Handset. The plug should fit securely. Do not force the connection.

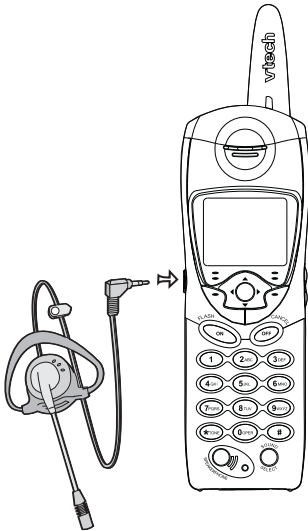

### NOTE:

Whenever a compatible Headset is connected to the cordless Handset, the microphone on the Handset will be muted. This is done to limit the effect of background noise.

Many compatible Headsets have a reversible, monaural design. You can wear your Headset on either ear, leaving one ear free for room conversation.

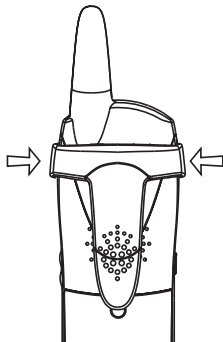

### Belt Clip

The **VT5801** is also equipped with a detachable belt clip. Align the pins on the inside edge of the clip with the notches on the sides of the Handset. The belt clip should snap securely into place. Do not force the connection.

# Maintenance

---

## Taking Care Of Your Telephone

Your **VT5801** cordless telephone contains sophisticated electronic parts, so it must be treated with care.

### Avoid rough treatment

Place the Handset down gently. Save the original packing materials to protect your telephone if you ever need to ship it.

### Avoid water

Your telephone can be damaged if it gets wet. Do not use the Handset outdoors in the rain, or handle it with wet hands. Do not install your Base Unit near a sink, bathtub or shower.

### Electrical storms

Electrical storms can sometimes cause power surges harmful to electronic equipment.  
For your own safety, use caution when using electric appliances during storms.

### Cleaning your telephone

Your telephone has a durable plastic casing that should retain its luster for many years. Clean it only with a soft cloth slightly dampened with water or a mild soap. Do not use excess water or cleaning solvents of any kind.

Remember that electrical appliances can cause serious injury if used when you are wet or standing in water. If your Base Unit should fall into water, **DO NOT RETRIEVE IT UNTIL YOU UNPLUG THE POWER CORD AND TELEPHONE LINE CORDS FROM THE WALL.** Then pull the unit out by the unplugged cords.

## In Case Of Difficulty

---

If you have difficulty operating your phone, the suggestions below should solve the problem. If you still have difficulty after trying these suggestions, call VTech Customer Service at 852-2776 3223.

### The Phone Doesn't Work At All

- Make sure the Power Cord is plugged into the electrical outlet.
- Make sure the telephone line cord is plugged firmly into the Base Unit and the telephone wall jack.
- Make sure the batteries are properly charged. If the 'LOW BATTERY' message is shown, the battery pack needs charging.
- Is the Handset registered to the Base? See **Registration** on page 8.

### No Dial Tone

- First check all the suggestions above.
- If you still don't hear a dial tone, disconnect the Base Unit from the telephone jack and connect a different phone. If there is no dial tone on that phone either, the problem is in your wiring or local service. Call your local telephone company.

### You Get Noise, Static, Or A Weak Signal Even When You're Near The Base Unit

- Household appliances plugged into the same circuit as the Base Unit can sometimes cause interference. Try moving the appliance or the Base Unit to another outlet.

### You Get Noise, Static, Or A Weak Signal When You're Away From The Base Unit

- You may be out of range. Either move closer to the Base, or relocate the Base Unit.
- The layout of your home may be limiting the range. Try moving the Base Unit to another position.

### The Handset Does Not Ring When You Receive A Call

- Make sure you have the Handset ringer activated. To set the ringer, see **Sounds & Alerts**.
- Make sure the telephone line cord is plugged firmly into the Base Unit and the telephone jack. Make sure the power cord is plugged in.
- You may be too far from the Base Unit.
- You may have too many extension phones on your telephone line to allow all of them to ring. Try unplugging some of the other phones.

## In Case Of Difficulty

---

### Your Handset vibrates or shakes when a call comes in

- It is likely that your Vibrating Handset Ringer option has been set to **ON**. If you'd like to turn it off, see **Sounds & Alerts - Ringer CONTROL**.

### You Hear Other Calls While Using Your Phone

- Disconnect your Base Unit from the telephone jack, and plug in a regular telephone. If you still hear other calls, the problem is probably in your wiring or local service. Call your local telephone company.

### You Hear Noise In The Handset, And None Of The Keys Or Buttons Work

- Make sure the power cord is plugged in.

### Common Cure For Electronic Equipment

If the unit does not seem to be responding normally, then try putting the Handset in the cradle. If it does not seem to respond, do the following (in the order listed) :

1. Disconnect the power to the Base.
2. Disconnect the Handset battery, and spare battery pack, if applicable.
3. Wait a few minutes.
4. Connect power to the Base.
5. Re-install the battery pack(s).
6. Watch for Handset to display :



then

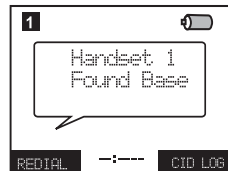

# Technical Specifications

---

## FREQUENCY CONTROL

Crystal controlled  
PLL synthesizer

## TRANSMIT FREQUENCY

Base : 5744.736-5825.952 MHz  
Handset : 2401.056-2482.272 MHz

## RECEIVE FREQUENCY

Base : 2401.056-2482.272 MHz  
Handset: 5744.736 - 5825.952 MHz

## CHANNELS

95 Channels

## SIZE

Handset : 193mm x 52mm x 40mm  
(including antenna)  
Charger : 77mm x 69mm x 54mm

## WEIGHT

Handset : 148.5 grams  
(excluding battery pack)  
Charger : 233.2 grams

## POWER REQUIREMENTS

Handset : 2.4V 400mAh NiMH  
Battery Pack  
Charger : 6 VDC @ 300mA

## MEMORY

Speed Dial: 50 Memory locations, up  
to 32 digits per location.  
CID : Alphanumeric Display  
50 Memory locations

**SPECIFICATIONS ARE TYPICAL  
AND MAY CHANGE  
WITHOUT NOTICE.**

# Table of Contents

---

<b>Introduction.....</b>	<b>1</b>
<b>Important Safety Instructions.....</b>	<b>2</b>
<b>Getting Started.....</b>	<b>4</b>
Parts Check List.....	4
The Handset Layout.....	5
Setup.....	6
Registration.....	8
<b>Basic Operation.....</b>	<b>9</b>
Handset Indicators.....	9
Handset Menu.....	10
Joystick Operation.....	10
Menu Shortcuts.....	10
Main Menu.....	10
Intercom.....	11
Phonebook.....	12
Calls Log.....	16
Settings.....	17
Sounds & Alerts.....	18
Pictures.....	18
Ringer C.I.Y. ....	20
Pictures Download .....	21
<b>Advance Operation.....</b>	<b>23</b>
Handset Operation.....	23
Making Calls.....	23
Answering Calls.....	23
How to Adjust the Handset Volume.....	23
Sound Select.....	23
Mute Function.....	24
Hold Function.....	24
Flash Function.....	25
Conference Calling.....	25
Transferring Calls.....	25
Blind Transfer.....	25
Announced Transfer.....	25
<b>Additional Information.....</b>	<b>26</b>
Headset Accessories.....	26
Belt Clip.....	26
Maintenance.....	27
In Case Of Difficulty.....	28
Technical Specifications.....	30

# vtech



## GIGA 5.8x

數碼室內無線電話系統

### VT 5801

(Accessory Handset Only)

## USER'S MANUAL



VTECH TELECOMMUNICATIONS LTD.  
[www.vtech.com](http://www.vtech.com)



# MAXIMISE THE USE AND PLEASURE YOU GET FROM YOUR **GiGA 5.8x**



## Use additional handsets

Your **GiGA 5.8x** is expandable to support up to maximum 6 handsets on only one phone jack. With additional handsets you can enjoy free internal conversations and a walkie talkie function, as well as four-way conferencing (2 handsets, base speakerphone, and an outside party).



## Spare Battery Charger/Power Backup

Your **GiGA 5.8x** uses the spare battery charger in the base unit to provide operational backup in the event of a power failure. The spare battery pack can also be used to replace a drained handset battery, ensuring uninterrupted use of the phone.



## Headset operation

Your **VT 5801** is equipped with a 2.5mm headset jack for use with a headset for hands-free operation.

To order additional system handsets (VT5801 and/or VT5820), battery packs, or headsets, call

**VTech Customer Service at 852-2776 3223**

VTech Electronics (HK) Ltd.

Rm 708, 7/F., Laford Centre, 838 Lai Chi Kok Road, Kowloon, Hong Kong.

Tel: 852-2776 3223

## Free Manuals Download Website

<http://myh66.com>

<http://usermanuals.us>

<http://www.somanuals.com>

<http://www.4manuals.cc>

<http://www.manual-lib.com>

<http://www.404manual.com>

<http://www.luxmanual.com>

<http://aubethermostatmanual.com>

Golf course search by state

<http://golfingnear.com>

Email search by domain

<http://emailbydomain.com>

Auto manuals search

<http://auto.somanuals.com>

TV manuals search

<http://tv.somanuals.com>