

Congratulations

on purchasing your new VTech product.
Before using this telephone, please read the
Important safety instructions
on page 35 of this manual.

This manual has all the feature operations and troubleshooting necessary to install and operate your new VTech telephone. Please review this manual thoroughly to ensure proper installation and operation of this innovative and feature rich VTech product. For support, shopping, and everything new at VTech, visit our website at www.vtechphones.com. In Canada go to www.vtechcanada.com.

Table of contents

Installation	1	Make, answer and end calls	12
Parts checklist	1	Speakerphone	12
Install handset battery	2	Mute	12
Telephone base installation	3	Volume	13
Belt clip & headset	4	Ringer mute.	13
DSL service.	5	Call waiting	13
Wall mounting bracket installation	6	Find handset	14
Desk/table bracket installation	6	Voicemail	14
Telephone settings	7	Advanced operation	15
Handset layout	7	Directory	15
Telephone base layout	8	Store a directory entry	15
Ringer volume	9	Character chart.	16
Ringer tone	9	Search the directory	17
Key tone	10	Dial a directory entry	17
Language	10	Edit a directory entry	18
Clear voicemail	11	Delete a directory entry.	18
Dial type	11	About caller ID	19
Basic operation	12	Caller ID	20

Table of contents

Review the call log	20	About cordless telephones	37
Dial a call log entry	21	Warranty	37
Save an entry to the directory	21	FCC, ACTA and IC regulations	39
Delete one or all entries in call log	22	The RBRC® seal	40
Call log display screen messages	22	Technical specifications	41
Redial list	23	Index	42
Dial from redial	23		
Delete a redial entry	23		
Handset display screen messages.	24		
Handset and telephone base indicators	26		
Handset lights	26		
Telephone base lights	26		
Handset icons	26		
Battery	27		
Troubleshooting	28		
Important safety instructions	35		
Operating range	36		
Maintenance	36		

Installation

Parts checklist

Remember to save your sales receipt and original packaging in case it is necessary to ship your telephone for warranty service. Check to make sure the telephone package includes the following:

1. Battery
2. Battery compartment cover
3. Telephone line cord
4. Belt clip
5. Base power adapter
6. Handset
7. Telephone base with wall mounting/desktop bracket
8. User's manual



1. Battery



2. Battery compartment cover



3. Telephone line cord



4. Belt clip

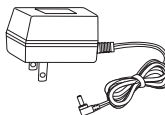

5. Base power adapter

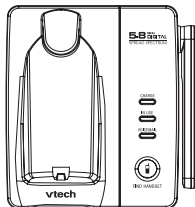

6. Handset

7. Telephone base with wall mounting/
desktop bracket

8. User's manual

note

- To purchase replacement batteries, or obtain a replacement power adapter, visit our website at www.vtechphones.com or call 1 (800) 595-9511. In Canada, go to www.vtechcanada.com or call 1 (800) 267-7377.

note

- If the handset will not be used for a long period of time, remove the battery to prevent possible leakage.
- To purchase replacement batteries, visit our website at www.vtechphones.com or call 1 (800) 595-9511. In Canada, go to www.vtechcanada.com or call 1 (800) 267-7377.
- After you install the battery, there may be enough power for short calls.

Installation

Install handset battery

- Align the two holes of the battery plug with the socket pins in the handset battery compartment, matching the red and black wires to the color-coded label.
- Place the battery in the compartment with the wires in the upper left corner.
- Position the battery compartment cover and slide it towards the unit until it clicks into place.
- For optimal performance, we recommend that you charge the handset for 16 hours.

You can keep the battery charged by returning the handset to the telephone base after each use. When the battery power is fully depleted, a full recharge takes about 16 hours.

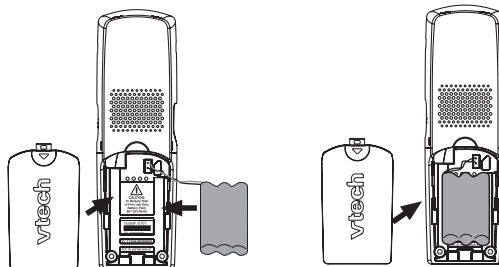
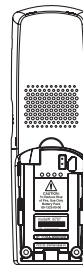

Installation

Telephone base installation

It is recommended to install the telephone base away from any electronic equipment and appliances such as personal computers, computer routers, television sets, microwave ovens, and refrigerators. Avoid excessive heat, cold, dust or moisture. When a location is selected, install the telephone base and the charger as shown below.

- Plug the connector into the power jack at the bottom of the telephone base. Route cords through slots and plug the power adapter into an electrical outlet not controlled by a wall switch.
- Plug one end of the telephone line cord into the telephone line jack at the bottom of the telephone base. Route the telephone line cord through slot, then plug the other end of the cord into the modular wall telephone outlet.

Plug the telephone line cord into a telephone jack.

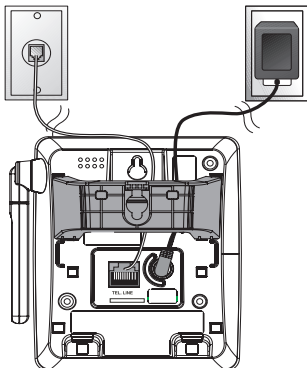

Plug power adapter into an electrical outlet not controlled by a wall switch.

note

- Use only the VTech battery and AC power adapter (or equivalent) supplied with this telephone. To obtain a replacement, visit our website at www.vtechphones.com or call 1 (800) 595-9511. In Canada go to www.vtechcanada.com or call 1 (800) 267-7377.
- This power unit is intended to be correctly oriented in a vertical or floor mount position. The prongs are not designed to hold the plug in place if it is plugged into a ceiling, under-the-table or cabinet outlet.

note

- To purchase a headset, visit our website at www.vtechphones.com or call 1 (800) 595-9511. In Canada, go to www.vtechcanada.com or call 1 (800) 267-7377.
- Whenever a compatible headset is connected to the cordless handset, the microphone on the handset will be muted. This reduces background noise and improves the sound quality.
- If the sound quality of the headset is poor, try unplugging it, and firmly plugging it in again.

Installation

Belt clip & headset (optional)

For hands-free telephone conversations, use any industry standard 2.5mm headset (purchased separately). For best results, use a VTech 2.5mm headset.

Headset

Plug the 2.5 mm headset into the jack on the side of the handset (beneath the small rubber flap).

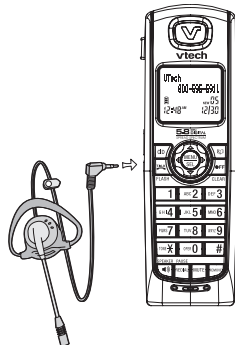

Belt clip

Align the pins on the inside edge of the clip with the notches on the sides of the handset.

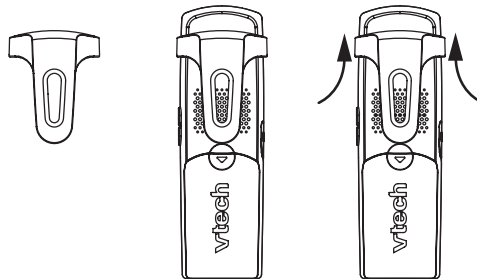

Installation

If you subscribe to DSL service

If you receive high speed internet through your telephone line (commonly referred to as DSL), and you are experiencing interference during telephone conversations and/or your caller ID features are not functioning properly, install a DSL filter to the telephone line between the telephone base and the telephone wall jack. Contact your DSL service provider for a DSL filter.

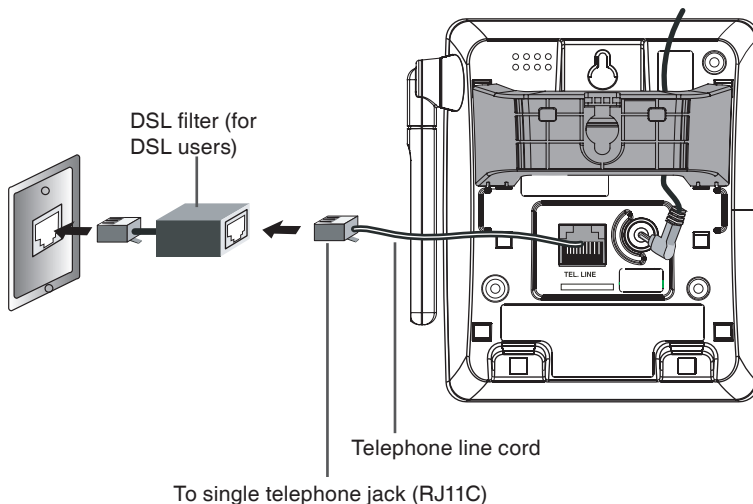

note

- Most DSL providers recommend installing a DSL filter in every telephone jack. Your DSL service provider may provide more information regarding telephone interference.

Installation

Wall mounting bracket installation (optional)

Your telephone base comes with the wedge installed, ready for desktop use. If you prefer to mount your telephone on the wall (optional), it is designed to mount on a standard telephone wall plate. For wall mounting, follow these instructions:

- First, insert the lower portion tabs of the wall mounting bracket into the lower grooves in the telephone base, then snap the upper portion tabs of the wall mounting bracket into place.
- Mount the telephone base on the wall by positioning it so the mounting studs will fit into the holes on the telephone base and wall mounting bracket. Slide the telephone base down on the mounting studs until it locks into place.
- To remove the bracket, press both upper portion tabs firmly inward and pull the bracket downward until it release from the grooves.

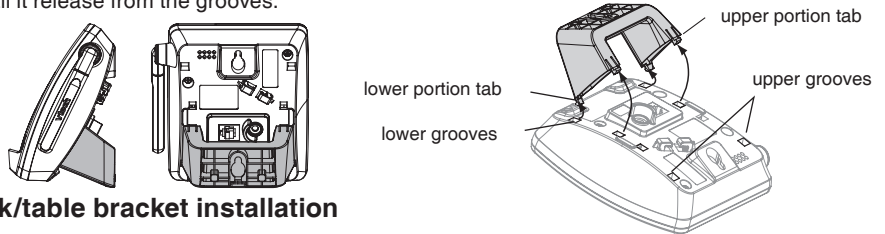

Desk/table bracket installation

To place your telephone base on a desk or table, insert the wall mounting/desktop bracket.



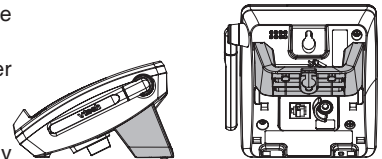



- Insert the lower portion tabs of the bracket into the upper grooves of the telephone base.
- Snap the upper portion tabs of the bracket into place.
- To remove the bracket, press both upper portion tabs firmly inward and pull the bracket upward until it is released from the grooves.



Telephone settings

Handset layout

1. Earpiece
2. CID (caller ID)
3. Headset jack (2.5mm)
4. **TALK**/FLASH
5. Dial pad keys (0-9, *, #)
6. **RECALL**/SPEAKER
7. **REDIAL**/PAUSE
8. Microphone
9. Handset display
10. **BOOKMARKS**/Directory
11. Volume (▲/▼)
12. NavKey
13. **OFF**/CLEAR
14. **REMOVE**
15. **MUTE**

Press the center NavKey  to display menus. Press the up or down NavKey  or  to navigate through menus (page 10). Press the left or right NavKey  or  to navigate through menus (page 10). Press the center NavKey  to select a highlighted menu item.

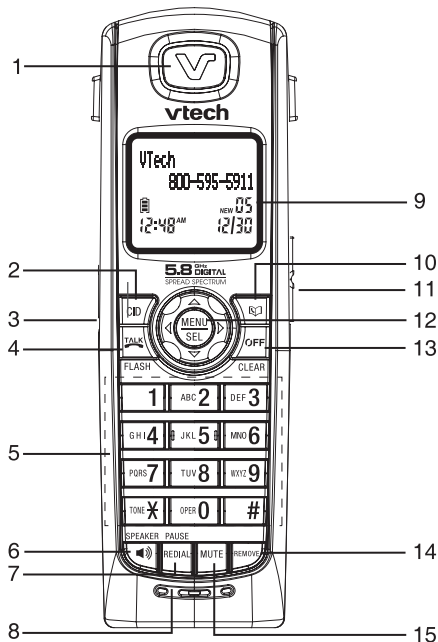
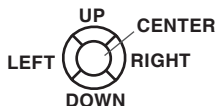

Telephone settings

Telephone base layout

1. CHARGE light
2. IN USE light
3. VOICEMAIL light
4. FIND HANDSET
5. Antenna

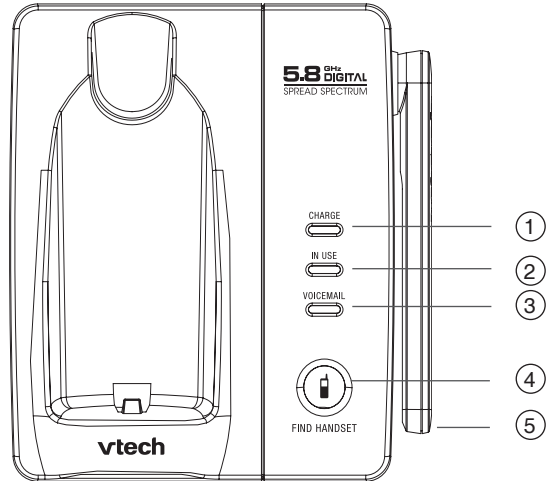







Telephone settings

Ringer volume

Your telephone has seven volume levels to choose from. You can adjust ringer volume either by the volume control on the right side of the handset, or in the handset menu. To change the ringer volume:

- Make sure the handset is in idle mode.
- Press the volume button ▲▼ to display the current volume level on the screen.
- Press **VOL ▲** or **VOL ▼** to choose the desired volume level. When finished, the new volume level will be saved.

-OR-







- Press the center NavKey  in idle mode to display the menu.
- Press the up or down NavKey  or  to reach **RINGER VOLUME**, then press the center NavKey .
- Press the left or right NavKey  or  to adjust the volume. A sample of each ringer volume will be played when scrolling through the choices.
- Press the center NavKey  to save. You'll hear a confirmation tone.

```
>RINGER VOLUME
RINGER TONE
```

```
RINGER VOLUME
■■■■■
```

Ringer tone

This feature allows you to choose from ten ringer tones for incoming calls. To choose a ringer tone:

- Press the center NavKey  in idle mode to display menu.
- Press the up or down NavKey  or  to reach **RINGER TONE**, and press the center NavKey .
- Press the up or down NavKey  or  to choose the desired ringer tone. A sample of the ringer tone will be played when scrolling through the choices.
- Press the center NavKey  to save. You'll hear a confirmation tone.

```
>RINGER TONE
KEY TONE
```

```
RINGER TONE
1
```

note

- Ringer will be off if the volume is set to zero, and a ringer off icon will be displayed.
- If the ringer is turned off while scrolling through the options in **RINGER MELODY**, the sample of ringer will not be heard.







note

- When the telephone is in pulse dial mode, it is possible to switch to temporary tone dial mode during an ongoing call by pressing ***TONE**. Once pressed, tone dial mode will be used for the rest of the call. After hang up, the telephone will return to pulse dialing for the next call.

Telephone settings







Key tone

If you set the key tone to off, you will not hear a beep tone when you press any of the handset keys.

- Press the center NavKey  in idle mode to display menu.
- Press the up or down NavKey  or  to reach **KEY TONE**, then press the center NavKey .
- Press the up or down NavKey  or  to choose between **ON** or **OFF** then press the center NavKey  to confirm. You'll hear a confirmation beep if **KEY TONE** is on.

Language

The language menu allows you to select between **ENGLISH**, **FRANÇAIS** or **ESPAÑOL** to be used in all menus and screen displays. To change the language:

- Press the center NavKey  in idle mode to display menu.
- Press the up or down NavKey  or  to reach **LANGUAGE**, then press the center NavKey .
- Press the up or down NavKey  or  to scroll through the choices, then press the center NavKey  to confirm selection. You'll hear a confirmation beep if **KEY TONE** is on.

```
>KEY TONE  
LANGUAGE
```

```
KEY TONE  
ON
```





```
>LANGUAGE  
CLR VOICE MAIL
```

```
LANGUAGE  
ENGLISH
```

Telephone settings

Clear voicemail

In this menu, you can turn off the network message indicator on the handset screen.







- Press the center NavKey  in idle mode to display menu.
- Press the up or down NavKey  or  to reach **CLR VOICE MAIL**, then press the center NavKey .
- Press the center NavKey  when **TURN INDICATOR OFF?** displays, or press **OFF/CLEAR** to cancel.

```
>CLR VOICE MAIL
DIAL TYPE
```

```
TURN INDICATOR
OFF?
```

Dial type

The dial type is preset to touch tone. If you would like to change this setting to dial pulse (rotary):

- Press the center NavKey  in idle mode to display menu.
- Press the up or down NavKey  or  to reach **DIAL TYPE**, then press the center NavKey .
- Press the up or down NavKey  or  to choose between **TONE** or **PULSE**, then press the center NavKey  to confirm.

```
>DIAL TYPE
DIRECTORY
```

```
DIAL TYPE
TONE
```

note

- The screen displays the elapsed time as you talk (in hours, minutes and seconds).
- While entering a number to dial, press **REMOVE** or **OFF/CLEAR** to backspace; press and hold **REDIAL/PAUSE** to insert a pause.

Basic operation

Make, answer and end calls

- To make a call press **TALK/FLASH** or **SPEAKER**, then dial the number.
-OR-
- Dial the number then press **TALK/FLASH** or **SPEAKER**.
- To answer a call, press **TALK/FLASH**, **SPEAKER** or any of the dial pad keys (**0-9, #, ***).
- To end a call, press **OFF/CLEAR**, or put the handset in the telephone base.

Speakerphone

- During a call, press **SPEAKER** on the handset to select between speakerphone and normal handset use.

Mute

The mute function allows you to hear the other party, but they will not be able to hear you. To use the mute function:

- During a call, press **MUTE** on the handset.
- The screen will display the **MUTE** icon.
- Press **MUTE** again to resume the conversation.

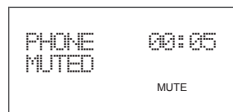
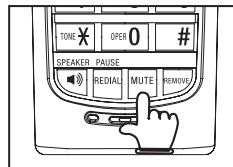
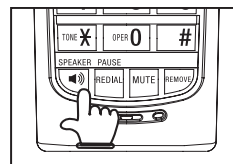
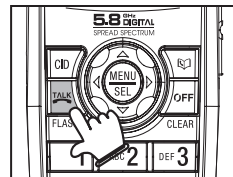

Basic operation

Volume

- During a call, use the volume button on the right side of the handset to adjust the listening volume.
- Press **VOL ▲** or **VOL ▼** to adjust the volume to a comfortable level.

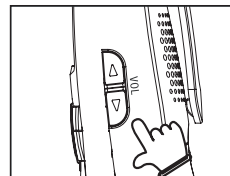

Ringer mute

This feature allows you to mute the ringer temporarily when the telephone is ringing.

- Press **OFF/CLEAR** or **MUTE** on the handset to temporarily silence the ringer. The screen displays **RINGER MUTE**.
- The next call will ring normally.

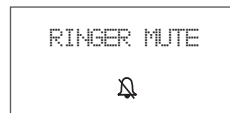

Call waiting

If you subscribe to call waiting service, you will hear a tone to signify there is an incoming call when you are on a call.

- Press **TALK/FLASH** on the handset to answer the new incoming call and put the current call on hold.
- Press **TALK/FLASH** at anytime to alternate between calls.

Basic operation

Find handset

This feature allows the telephone base to page the handset.

- Press **FIND HANDSET** on telephone base. The handset will ring and its screen will display **PAGING**.
- To stop paging, press **FIND HANDSET** again on the telephone base, **TALK/FLASH** or any dial pad keys (**0-9, #, ***) on the handset.



Voicemail

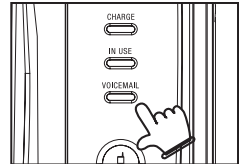
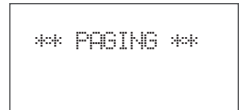

If you subscribe to voicemail service and you have a new voicemail message, the **VOICEMAIL** indicator on the telephone base will flash and the handset will display **NEW VOICE MAIL** . Please contact your local telephone company for more information about voicemail service.



Advanced operation

Directory







The directory on the handset can store up to 50 entries, each entry consists up to 32 digits and 16 characters.

- The directory can be accessed while in idle mode by pressing  or the center NavKey  twice.
- Press **OFF/CLEAR** to exit the menu without saving any changes.
- **DIRECTORY EMPTY** is displayed on screen when there is no entry in the directory.



DIRECTORY EMPTY

Store a directory entry

- Press the center NavKey  in idle mode to display menu, then press the center NavKey  to enter the directory.
- Press the up or down NavKey  or  to choose **STORE** when in the directory menu. Press the center NavKey  to select.
- The screen displays **ENTER NUMBER**. Use the dial pad to enter the number. Press **REMOVE** to backspace, or press and hold **REDIAL/PAUSE** for at least three seconds to insert a dialing pause. A **p** will be displayed to show the dialing pause. Press the center NavKey .
- The screen displays **ENTER NAME**. Use the dial pad (see the **Character chart** on page 16) to enter the name. Press **REMOVE** to backspace, or press **#** to insert a space. Press the center NavKey .
- When the directory is full and a save is attempted, **LIST FULL** will be displayed.
- If you attempt to save a number already stored in the directory, **ALREADY SAVED** will display.



>DIRECTORY
CALL LOG



>STORE
REVIEW



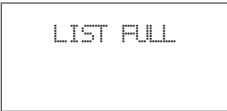

ENTER NUMBER



LIST FULL

note

- When you enter a name, the handset will automatically display the first character of each word in uppercase.
- Press the up or down NavKey  or  to move the cursor one space to the left or right.
- Press # to enter a space.

Advanced operation

Character chart

Use the dial pad and the chart below to enter a name (up to 16 characters). Each press of a particular key causes characters to be displayed in the following order:

Number Key	Characters by number of key presses								
	1	2	3	4	5	6	7	8	9
1	1	#	'	,	-	.	&		
2	A	B	C	2	a	b	c		
3	D	E	F	3	d	e	f		
4	G	H	I	4	g	h	i		
5	J	K	L	5	j	k	l		
6	M	N	O	6	m	n	o		
7	P	Q	R	S	7	p	q	r	s
8	T	U	V	8	t	u	v		
9	W	X	Y	Z	9	w	x	y	z
0	0								
*	*	?	!	/	()	@		
#	space								



- When entering characters, press **REMOVE** to backspace. To remove the entire name or number, press and hold REMOVE for at least three seconds.
- To insert a dialing pause, press and hold REDIAL/PAUSE for at least three seconds until a lowercase **p** appears on the handset screen.

Advanced operation

Search the directory

Entries are sorted alphabetically, and names beginning with numbers are presented first. An alphabetical search can be done after entering the directory.

For example, press **5 (JKL)** once to find Jenny, twice to find Kristen, or three times to find Linda.

- Press  to enter the directory, or press the center NavKey  to choose **REVIEW** when in the directory.
- Use the dial pad to display the first name beginning with a letter associated with that key.









```
>REVIEW  
STORE
```













```
VTECH  
188005959511
```

Dial a directory entry

- Press  to enter the directory, or press the center NavKey  to choose **REVIEW** when in the directory menu.
- Press the up or down NavKey  or  to scroll to the desired entry, or use the alphabetical search to find it.
- Press /FLASH or /SPEAKER to dial the entry.

Advanced operation





Edit a directory entry

- Press  to enter the directory, or press the center NavKey  and use the up or down NavKey  or  to choose **REVIEW** when in the directory menu and press the center NavKey .
- Press the up or down NavKey  or  to scroll to the desired entry, or use the alphabetical search to find the number. Press the center NavKey .
- The screen displays **EDIT NUMBER**. Use the dial pad to enter the number.
- Press **REMOVE** to backspace, or press and hold REDIAL/PAUSE for at least three seconds to insert a dialing pause. Press the center NavKey .
- The screen displays **EDIT NAME**. Use the dial pad (see the **Character chart** on page 16) to enter the name.
- Press **REMOVE** to backspace, or press **#** to insert a space. Press the center NavKey  to confirm.

```
EDIT NUMBER
595-9511_
```

```
EDIT NAME
VTECH_
```

Delete a directory entry

- Press  to enter the directory, or press the center NavKey  to choose **REVIEW** when in the directory menu.
- Use the up or down NavKey  or  to scroll to the desired entry, or use the alphabetical search to find the number.
- Press **REMOVE** to delete the selected entry, you'll hear a confirmation tone.

Advanced operation

About caller ID

The caller ID with call waiting feature in this telephone let you see the name and telephone number of the caller before answering the call, even when you're already on a call. These features require services provided by your local telephone company.

Contact your telephone company if:

- you have both caller ID and call waiting, but as separate services (you may need combined service),
- you have only caller ID service, or only call waiting service, or
- you do not subscribe to any caller ID or call waiting services but wish to try these services.

You can use this telephone with regular caller ID service, and you can use its other features without subscribing to either caller ID or combined caller ID with call waiting service. There may be fees for these services, and these services may not be available in all areas.

The caller ID features will work only if both you and the caller are in areas offering caller ID service, and if both telephone companies use compatible equipment.

note



- Due to regional service differences, the caller ID information may not be available for every incoming call. In addition, the callers may intentionally block their name and/or telephone number.
- The time of the handset is automatically set and updated with incoming caller ID information if you subscribe to this service.

Advanced operation



Caller ID

If you subscribe to caller ID service, information about each caller will be displayed after the first or second ring. This information will be stored in the call log.

- The call log can store up to 50 entries.
- You can review, redial, and copy the entry into the directory.
- Entries are displayed in reverse chronological order, from the newest to the oldest entry.
- When the call log is full, the oldest entry is deleted to make room for new incoming call information.
- **XX MISSED CALL** and the **NEW** icon will be displayed on screen if there are new call log entries (including missed and un-reviewed calls.)
- **CALL LOG EMPTY** will be displayed on screen if there are no call log entries.

The call log can be accessed on the handset by pressing **CID**, or pressing the center NavKey  then **CALL LOG**, then press the center NavKey  again. If the telephone number of caller ID matches the exact telephone number in the directory, the name of the entry will be shown, otherwise, the name will be shown as delivered by the telephone company.

Review the call log

- When in the call log, use the up or down NavKey  or  to scroll through the call log on the handset.
- The name, number, date and time of all incoming calls are displayed on the screen.
- There will be an error tone when the list reaches the top or the end of the call log.

```
HANDSET X
XX MISSED CALLS
```





```
CALL LOG EMPTY
```

```
>CALL LOG
RINGER VOLUME
```

```
A. PERSON
595-9511
3:45AM 1/02
```

Advanced operation

Dial a call log entry





- When in the call log, use the up or down NavKey  or  to scroll to the desired entry.
- Press # repeatedly to display the possible dialing options when the telephone number in call log consists of 7, 8, 10 or 11 digits. For example, if the original number is 800-595-5911, then the various dialing options are:
- Press /FLASH or /SPEAKER to dial the entry.

```

595-5911
1-595-5911
800-595-5911
1-800-595-5911

```

Save an entry to the directory

- When in the call log, press the up or down NavKey  or  to scroll to the desired entry. Press # repeatedly to display the possible dialing options when the telephone number in call log consists of 7, 8, 10 or 11 digits. For example, if the original number is 800-595-5911, then the various dialing options are:
- Press the center NavKey  to save the entry.
- If the entry has a name and a number, the screen displays **SAVED**.
- If the entry only has a name or a number, **EDIT NAME** or **EDIT NUMBER** will be displayed on screen. Use the dial pad to enter the name or number, then press the center NavKey  to save the entry.
- If the entry does not have a name and a number, **UNABLE TO SAVE** will be displayed on screen.

```

595-5911
1-595-5911
800-595-5911
1-800-595-5911

```

```

SAVED

```

```

UNABLE TO SAVE



```

note

- While reviewing the call log, press # repeatedly to display the other dialing options. The available options are: (1 + area code + number, area code + number, 1 + number, number only).

Advanced operation

Delete one or all entries in call log

- While in the call log, press the up or down NavKey  or  to scroll to the desired entry.
- Press **REMOVE** to delete an entry. Press and hold REMOVE to delete all entries, the screen display **DELETE ALL CALLS?** then press the center NavKey  to confirm, you'll hear a confirmation tone.



DELETE ALL
CALLS?

Call log display screen messages

Display:	Means:
PRIVATE NAME	The other party is blocking the name information.
PRIVATE NUMBER	The other party is blocking the telephone number information.
PRIVATE CALLER	The other party is blocking the name and number information.
UNKNOWN NAME	This caller's name is unavailable.
UNKNOWN NUMBER	This caller's number is unavailable.
UNKNOWN CALLER	No call information is available about this caller.
LONG DISTANCE	This is a long distance call.

Advanced operation

Redial list



The telephone stores the five most recently dialed numbers in the redial list. You can review, redial, or save numbers into the directory.

- When there are already five entries in the redial list, the oldest entry is deleted to make room for the newest entry.
- Entries are displayed in reverse chronological order, i.e. from the most recent to the oldest entry.

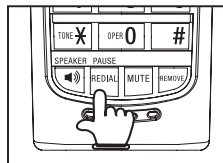

The redial list can be accessed on the handset by pressing **REDIAL/PAUSE** while in idle mode.



Dial from redial

- While in the redial list, press **REDIAL**, or press the up or down NavKey  or  to scroll to the desired number.
- Press **TALK/FLASH** or **SPEAKER** to dial the number.
- To change the number before dialing, press the center NavKey  to select the number, and use the dial pad to change the number.
- Press **REMOVE** to backspace, or press and hold **REDIAL/PAUSE** for at least three seconds to insert a dialing pause. Press **TALK/FLASH** or **SPEAKER** to dial the number.

Delete a redial entry

- When in the redial list, press **REDIAL/PAUSE**, or press the up or down NavKey  or  to scroll to the number to be deleted.
- Press and hold **REMOVE** to delete the redial entry and you'll hear a confirmation tone.

Handset display screen messages

ALREADY SAVED	The telephone number you have entered is already stored in the directory.
CALL LOG EMPTY	There are no call log entries.
CONNECTING.....	The cordless handset is searching for the telephone base.
DIRECTORY EMPTY	There are no entries in the directory.
INCOMING CALL	There is an incoming call.
LIST FULL	The directory is full.
LOW BATTERY	The battery needs to be recharged.
NO LINE	There is no telephone line connected.
PAGING	The cordless handset locator has been activated.
ENDED	You have just ended a call.
LINE IN USE	The telephone line is in use.
MUTED	The microphone is muted during a conversation.
PLACE IN CHARGER	The battery is very low. The handset should be placed in the telephone base.

Handset display screen messages

RINGER MUTE	The ringer is muted temporarily during incoming call.
SAVED	Your operation has been saved.
UNABLE TO CALL TRY AGAIN	The handset is moved out of range.
UNABLE TO SAVE	You are attempting to save caller ID entry with no name or number.
WARNING CHECK BATTERY!	The battery is not installed or not installed properly in the handset. -OR - The battery needs to be replaced. -OR - An incorrect battery has been installed by mistake. Use only the supplied VTech battery or equivalent.
XX MISSED CALLS	There are un-reviewed calls in your call log.
MICROPHONE ON	MUTE has been turned off and the person on the other end can hear you.
NEW VOICE MAIL	There are new voice mail message(s).
PHONE	The handset is in use.
SPEAKER	The handset speakerphone is in use.

Handset and telephone base indicators



Handset lights

	<ul style="list-style-type: none">• On when the handset speakerphone is in use.
---	---

Telephone base lights

IN USE	<ul style="list-style-type: none">• Flashes when there is an incoming call, or another handset is in use.• On when the handset is in use.
VOICEMAIL	<ul style="list-style-type: none">• Flashes when there is a new message on the answer machine.
CHARGE	<ul style="list-style-type: none">• On when the handset is in the telephone base.

Handset icons

MUTE	<ul style="list-style-type: none">• Microphone is muted.
	<ul style="list-style-type: none">• Ringer off.
NEW	<ul style="list-style-type: none">• New call log entries.
NEW VOICEMAIL	<ul style="list-style-type: none">• New voicemail received.
SPEAKER	<ul style="list-style-type: none">• In speakerphone mode.
Battery indicator 	<ul style="list-style-type: none">• Cycles (low, medium, and full) when handset battery is charging.• Flashes when a low battery condition is detected.

Battery

After the battery is fully charged, you can expect the following performance:

Operation	Operating time
While in use (talking)	approximately 8 hours
While not in use (standby*)	approximately 96 hours (4 days)

*Handset is off the telephone base but not in use.

The battery needs charging when:

- A new battery is installed in the handset.
- The telephone beeps twice when taken off the telephone base.
- Battery indicator on the handset display is flashing.

CAUTION:

To reduce the risk of fire or injury to persons, read and follow these instructions:

1. Use only the battery provided (part number 89-1323-00-00) or equivalent. To order a replacement, visit our website at www.vtechphones.com or call 1 (800) 595-9511. In Canada go to www.vtechcanada.com or call 1 (800) 267-7377.
2. Do not dispose of the battery in a fire, it may explode. Check with local waste management codes for special disposal instructions.
3. Do not open or mutilate the battery. Released electrolyte is corrosive and may cause burns or injury to the eyes or skin. The electrolyte may be toxic if swallowed.
4. Exercise care in handling batteries in order not to create a short circuit with conductive materials such as rings, bracelets, and keys. The battery and/or conductor may overheat and cause burns.
5. Charge the battery provided with or identified for use with this product only in accordance with the instructions and limitations specified in this manual.

WARNING:

TO PREVENT FIRE OR SHOCK HAZARD, DO NOT EXPOSE THIS PRODUCT TO WATER OR ANY TYPE OF MOISTURE.

www.vtechphones.com

Download from Www.Somanuals.com. All Manuals Search And Download.

Troubleshooting

If you have difficulty operating your telephone, please try the suggestions below. For Customer Service, visit our website at www.vtechphones.com, or call VTech Communications at 1 (800) 595-9511. In Canada go to www.vtechcanada.com or call VTech Telecommunications Canada Ltd. at 1 (800) 267-7377.

Problem	Suggestion
My telephone does not work at all.	<ul style="list-style-type: none">• Make sure the battery is installed and charged correctly (see pages 2 and 27). For optimum daily performance, return the cordless handset to the telephone base after use.• Make sure the power adapter is securely plugged into an outlet not controlled by a wall switch.• Make sure the telephone line cord is plugged firmly into the telephone base and the modular wall jack.• Unplug the unit's electrical power. Wait for approximately 15 seconds, then plug it back in. Allow up to one minute for the cordless handset and telephone base to synchronize.• Charge the battery in the cordless handset for at least 16 hours.• Remove and re-insert the battery. If that still does not work, it may be necessary to purchase a new battery.• Disconnect the telephone base from the modular jack and plug in a working telephone. If this telephone does not work, the problem is probably in the wiring or the local service. Call the local telephone company.
LOW BATTERY is displayed on screen.	<ul style="list-style-type: none">• Place the handset in the telephone base for recharging.• Remove and re-install the battery and use it normally until fully discharged, then recharge the handset on the telephone base for 16 hours.• If the above measures do not correct the problem, the battery may need to be replaced.

Troubleshooting

Problem	Suggestion
The battery does not charge in the handset or the handset battery does not accept charge.	<ul style="list-style-type: none">• Make sure the handset is placed in the telephone base correctly. The CHARGE light on the telephone base should be on.• If the cordless handset is in the telephone base but the CHARGE light is not on, refer to The charge light is off in this section.• It may be necessary to purchase a new battery. Please refer to the Battery section (see page 27) of this user's manual.• The telephone might be malfunctioning. Please refer to the Warranty section (see page 37) of this user's manual for further instruction.
The CHARGE light is off.	<ul style="list-style-type: none">• Clean the charging contacts on the cordless handset and telephone base each month using a pencil eraser or a dry non-abrasive fabric.• Make sure the power adapter and telephone line cord are plugged in correctly and securely.• Unplug the power adapter. Wait for 15 seconds before plugging it back in. Allow up to one minute for the cordless handset and telephone base to reset.• The telephone might be malfunctioning. Please refer to the Warranty section (see page 37) of this user's manual for further instruction.

Troubleshooting

Problem	Suggestion
The CHARGE Indicator on the telephone base is flashing.	<ul style="list-style-type: none">• This is a signal that the battery is very low, completely depleted, or when there is no electrical contact between the battery and the telephone base.• Ensure the connector of the battery is securely plugged into the handset and place the handset in the telephone base for charging.
There is no dial tone.	<ul style="list-style-type: none">• First, try all the above suggestions.• Move the cordless handset closer to the telephone base. It might be out of range.• The telephone line cord might be malfunctioning. Try installing a new telephone line cord.• Disconnect the telephone base from the telephone jack and connect a different telephone. If there is no dial tone on the telephone either, the problem is in your wiring or local service. Contact your local telephone company.
The telephone does not ring when there is an incoming call.	<ul style="list-style-type: none">• Make sure the ringer is on. (See page 9).• Make sure the telephone line cord and power adapter are plugged in properly (see page 3).• The cordless handset may be too far from the telephone base. Move it closer to the telephone base.• There may be too many extension phones on the telephone line to allow all of them to ring simultaneously. Try unplugging some of them.• If the other telephones in your home are having the same problem, the problem is in the wiring or local service. Contact the local telephone company (charges may apply).• Other electronic products can cause interference to your cordless telephone. Try installing your telephone as far away as possible from the following electronic devices: wireless routers, radios, radio towers, pager towers, cellular telephones, digital telephones, intercoms, room monitors, televisions, VCRs, personal computers, kitchen appliances, and other cordless telephones.

Troubleshooting

Problem	Suggestion
The telephone does not ring when there is an incoming call.	<ul style="list-style-type: none">• Test a working telephone at the telephone jack. If another telephone has the same problem, the problem is in the telephone jack. Contact your local telephone company (charges may apply).• The telephone line cord might be malfunctioning. Try installing a new telephone line cord.• Re-install the battery and place the cordless handset in the telephone base.• Wait for the cordless handset to synchronize with the telephone base. Allow up to one minute for this to take place.
I cannot dial out.	<ul style="list-style-type: none">• First, try all the above suggestions.• Make sure there is a dial tone before dialing. It is normal if the cordless handset takes a second or two to synchronize with the telephone base before producing a dial tone. Wait an extra second before dialing.• Makes sure the telephone is set to the correct dial mode (pulse dial or tone dial) for the service in your area. Refer to the Dial type section of this user's manual (page 11) to set the dial mode.• If the other telephones in your home are having the same problem, the problem is in the wiring or local service. Contact your local telephone company (charges may apply).• Eliminate any background noise. Noise from a television, radio, or other appliances may cause the telephone to not dial out properly. If you cannot eliminate the background noise, first try muting the cordless handset before dialing, or dialing from another room in your home with less background noise.

Troubleshooting

Problem	Suggestion
<p>There is noise or interference during a telephone conversation.</p> <p>My calls fade out or cut in and out when I am using the cordless handset.</p>	<ul style="list-style-type: none">• The handset may be out of range. Move it closer to the telephone base.• Appliances or other cordless telephones plugged into the same circuit as the telephone base can cause interference. Try moving the appliance or telephone base to another outlet.• Other electronic products can cause interference to your cordless telephone. Try installing your telephone as far away as possible from the following electronic devices: wireless routers, radios, radio towers, pager towers, cellular telephones, digital telephones, intercoms, room monitors, televisions, VCRs, personal computers, kitchen appliances, wireless routers, and other cordless telephones.• Microwave ovens operate on the same frequency as your telephone. It is normal to experience static on your telephone while the microwave oven is operating. Do not install this telephone in the same outlet or near a microwave oven.• If your telephone is plugged in with a modem or a surge protector, plug the telephone (or modem/surge protector) into a different location. If this solves the problem, re-locate your telephone or modem farther apart from each other, or use a different surge protector.• The layout of your home or office might be limiting the operating range. Try moving the telephone base to another location, preferably a higher location for better reception.• Disconnect the telephone base from the modular jack and plug in a corded telephone. If calls are still not clear, the problem is probably in the wiring or local service. Contact your local service company (charges may apply).• If the other telephones in your home are having the same problem, the problem is in the wiring or local service. Contact the local telephone company (charges may apply).• Do you have DSL service? If yes, you need to have a DSL filter installed at every telephone jack that has a telephone connected to it. Contact your DSL service provider for filter information.

Troubleshooting

Problem	Suggestion
I hear other calls when using the telephone.	<ul style="list-style-type: none">• Disconnect the telephone base from the telephone jack. Plug in a different telephone. If you still hear other calls, the problem is probably in the wiring or local service. Call your local telephone company.
I hear noise in the cordless handset, and none of the keys or buttons work.	<ul style="list-style-type: none">• Make sure the telephone line cord is plugged in securely.
My caller ID features are not working properly.	<ul style="list-style-type: none">• Caller ID is a subscription service. You must subscribe to this service from your local telephone company for this feature to work on your telephone.• The caller may not be calling from an area which supports caller ID.• Both you and the caller's telephone companies must use equipment which are compatible with caller ID service.• If you subscribe to DSL service, install a DSL filter to the telephone line between the telephone base and the telephone line jack. Contact your DSL service provider for filter information.
The system does not receive caller ID or the system does not display caller ID during call waiting.	<ul style="list-style-type: none">• Make sure you subscribe to Caller ID with Call Waiting features services provided by the local telephone company.• The caller may not be calling from an area which supports caller ID.• Both you and the caller's telephone companies must use equipment which are compatible with caller ID service.• If you subscribe to DSL service, install a DSL filter to the telephone line between the telephone base and the telephone line jack. Contact your DSL service provider for filter information.

Troubleshooting

Problem	Suggestion
My cordless handset beeps and is not performing normally.	<ul style="list-style-type: none">• Make sure the power cord is securely plugged into the telephone base. Plug the unit into a different working electrical outlet not controlled by a wall switch.• Move the cordless handset closer to the telephone base. It may be out of range.• Reset the telephone base by unplugging the unit's electrical power. Wait for 15 seconds and plug it back in again. Allow up to one minute for the cordless handset and the telephone base to synchronize.• Other electronic products can cause interference to your cordless telephone. Try installing your telephone as far away from these electronic devices as possible: wireless routers, radios, radio towers, pager towers, cellular telephones, intercoms, room monitors, televisions, personal computers, kitchen appliances and other cordless telephones.
Common cure for electronic equipment.	<ul style="list-style-type: none">• If the unit is not responding normally, try putting the cordless handset in the telephone base. If it does not seem to respond, try the following (in the order listed):• Disconnect the power to the telephone base.• Disconnect the battery on the cordless handset.• Wait a few minutes before connecting power to the telephone base.• Re-install the battery and place the cordless handset into the telephone base.• Wait for the cordless handset to synchronize its connection with the telephone base. Allow up to one minute for this to take place.

Important safety instructions

When using your telephone equipment, basic safety precautions should always be followed to reduce the risk of fire, electric shock and injury, including the following:

1. Read and understand all instructions.
2. Follow all warnings and instructions marked on the product.
3. Unplug this product from the wall outlet before cleaning. Do not use liquid or aerosol cleaners. Use a damp cloth for cleaning.
4. Do not use this product near water (for example, near a bathtub, kitchen sink, or swimming pool).
5. Do not place this product on an unstable table, shelf, stand or other unstable surfaces.
6. Slots and openings in the back or bottom of the telephone base and handset are provided for ventilation. To protect them from overheating, these openings must not be blocked by placing the product on a soft surface such as a bed, sofa or rug. This product should never be placed near or over a radiator or heat register. This product should not be placed in any area where proper ventilation is not provided.
7. This product should be operated only from the type of power source indicated on the marking label. If you are not sure of the type of power supply in your home, consult your dealer or local power company.
8. Do not allow anything to rest on the power cord. Do not install this product where the cord may be walked on.
9. Never push objects of any kind into this product through slots in the base or handset as they may touch dangerous voltage points or short out parts that could result in a risk of fire or electric shock. Never spill liquid of any kind on the product.
10. To reduce the risk of electric shock, do not disassemble this product, but take it to an authorized service facility. Opening or removing parts of the telephone base or handset other than specified access doors may expose you to dangerous voltages or other risks. Incorrect reassembling can cause electric shock when the product is subsequently used.
11. Do not overload wall outlets and extension cords as this can result in the risk of fire or electric shock.
12. This power unit is intended to be correctly oriented in a vertical or floor mount position. The prongs are not designed to hold the plug in place if it is plugged into a ceiling or under-the-table/cabinet outlet.
13. Unplug this product from the wall outlet and refer servicing to an authorized service facility under the following conditions:
 - A. When the power supply cord or plug is damaged or frayed.
 - B. If liquid has been spilled onto the product.
 - C. If the product has been exposed to rain or water.
 - D. If the product does not operate normally by following the operating instructions. Adjust only those controls that are covered by the operation instructions, as improper adjustment of other controls may result in damage and often requires extensive work by an authorized technician to restore the product to normal operation.
 - E. If the product has been dropped and the telephone base and/or handset has been damaged.
 - F. If the product exhibits a distinct change in performance.
14. Avoid using a telephone (other than cordless) during an electrical storm. There is a remote risk of electric shock from lightning.
15. Do not use the telephone to report a gas leak in the vicinity of the leak.
16. Only put the handset of your telephone next to your ear when it is in normal talk mode.

SAVE THESE INSTRUCTIONS

www.vtechphones.com

Download from Www.Somanuals.com. All Manuals Search And Download.

Operating range

This cordless telephone operates with the maximum power allowed by the Federal Communications Commission (FCC). Even so, this handset and telephone base can communicate over only a certain distance ----which can vary with the locations of the telephone base and handset, the weather, and the layout of your home or office.

When the handset is out of range, the handset will display **Searching**. The user can access the handset directory, and certain parts of the menu system, i.e. handset setting and registration, but not the time setting and base setting. **Not possible** will be displayed if access is tried.

If there is a call while the handset is out of range, it might not ring, or if it does ring, the call might not connect well when you press TALK/FLASH. Move closer to the telephone base, then press TALK/FLASH to answer the call.

If the handset moves out of range during a telephone conversation, there might be interference.

To improve reception, move closer to the base.

Maintenance

Taking care of your telephone

Your cordless telephone contains sophisticated electronic parts, so it must be treated with care.

Avoid rough treatment

Place the handset down gently. Save the original packing materials to protect your telephone if you ever need to ship it.

Avoid water

Your telephone can be damaged if it gets wet. Do not use the handset outdoors in the rain, or handle it with wet hands. Do not install your telephone base near a sink, bathtub or shower.

Electrical storms

Electrical storms can sometimes cause power surges harmful to electronic equipment. For your own safety, use caution when using electric appliances during storms.

Cleaning your telephone

Your telephone has a durable plastic casing that should retain its luster for many years. Clean it only with a soft cloth slightly dampened with water or a mild soap. Do not use excess water or cleaning solvents of any kind.

Remember that electrical appliances can cause serious injury if used when you are wet or standing in water. If your telephone base should fall into water, DO NOT RETRIEVE IT UNTIL YOU UNPLUG THE POWER CORD AND TELEPHONE LINE CORDS FROM THE WALL. Then pull the unit out by the unplugged cords.

About cordless telephones

- **Privacy:** the same features that make a cordless telephone convenient create some limitations. Telephone calls are transmitted between the base and the cordless handset by radio waves, so there is a possibility that your cordless telephone conversations could be intercepted by radio receiving equipment within range of the cordless handset. For this reason, you should not think of cordless telephone conversations as being as private as those on corded telephones.
- **Electrical Power:** The telephone base of this cordless telephone must be connected to a working electrical outlet. The electrical outlet should not be controlled by a wall switch. Calls cannot be made from the cordless handset if the telephone base is unplugged or switched off, or if the electrical power is interrupted.
- **Potential TV Interference:** Some cordless telephones operate at frequencies that may cause interference to televisions and VCRs. To minimize or prevent such interference, do not place the telephone base of the cordless telephone near or on top of a TV or VCR. If interference is experienced, moving the cordless telephone farther away from the TV or VCR will often reduce or eliminate the interference. (Applies to 25 channel cordless telephones only).
- **Rechargeable Batteries:** This product contains either Nickel-Cadmium or Nickel-Metal Hydride rechargeable batteries. Exercise care in handling batteries in order not to short the battery with conducting material such as rings, bracelets, and keys. The battery or conductor may overheat and cause harm. Observe proper polarity between the battery and the battery charger.
- **Nickel-Metal Hydride Rechargeable Batteries:** Dispose of these batteries in a safe manner. Do not burn or puncture. Like other batteries of this type, if burned or punctured, they could release caustic material which could cause injury.

Warranty

What does this limited warranty cover?

The manufacturer of this VTech Product warrants to the holder of a valid proof of purchase ("Consumer" or "you") that the Product and all accessories provided in the sales package ("Product") are free from defects in material and workmanship, pursuant to the following terms and conditions, when installed and used normally and in accordance with the Product operating instructions. This limited warranty extends only to the Consumer for Products purchased and used in the United States of America and Canada.

What will VTech do if the Product is not free from defects in materials and workmanship during the limited warranty period ("Materially Defective Product")?

During the limited warranty period, VTech's authorized service representative will repair or replace at VTech's option, without charge, a Materially Defective Product. If we repair the Product, we may use new or refurbished replacement parts. If we choose to replace the Product, we may replace it with a new or refurbished Product of the same or similar design. We will retain defective parts, modules, or equipment. Repair or replacement of the Product, at VTech's option, is your exclusive remedy. VTech will return repaired or replacement Products to you in working condition. You should expect the repair or replacement to take approximately 30 days.

How long is the limited warranty period?

The limited warranty period for the Product extends for ONE (1) YEAR from the date of purchase. If VTech repairs or replaces a Materially Defective Product under the terms of this limited warranty, this limited warranty also applies to repaired or replacement Product for a period of either (a) 90 days from the date the repaired or replacement Product is shipped to you or (b) the time remaining on the original one-year warranty; whichever is longer.

What is not covered by this limited warranty?

This limited warranty does not cover:

1. Product that has been subjected to misuse, accident, shipping or other physical damage, improper installation, abnormal operation or handling, neglect, inundation, fire, water or other liquid intrusion; or
2. Product that has been damaged due to repair, alteration or modification by anyone other than an authorized service representative of VTech; or
3. Product to the extent that the problem experienced is caused by signal conditions, network reliability, or cable or antenna systems; or

4. Product to the extent that the problem is caused by use with non-VTech accessories; or
5. Product whose warranty/quality stickers, product serial number plates or electronic serial numbers have been removed, altered or rendered illegible; or
6. Product purchased, used, serviced, or shipped for repair from outside the United States of America or Canada, or used for commercial or institutional purposes (including but not limited to Products used for rental purposes); or
7. Product returned without valid proof of purchase (see item 2 below); or
8. Charges for installation or set up, adjustment of customer controls, and installation or repair of systems outside the unit.

How do you get warranty service?

To obtain warranty service in the United States of America, please call 1 (800) 595-9511; In Canada, please call 1 (800) 267-7377. NOTE: Before calling for service, please review the user's manual - a check of the Product controls and features may save you a service call.

Except as provided by applicable law, you assume the risk of loss or damage during transit and transportation and are responsible for delivery or handling charges incurred in the transport of the Product(s) to the service location. VTech will return repaired or replaced Product under this limited warranty to you, transportation, delivery or handling charges prepaid. VTech assumes no risk for damage or loss of the Product in transit. If the Product failure is not covered by this limited warranty, or proof of purchase does not meet the terms of this limited warranty, VTech will notify you and will request that you authorize the cost of repair prior to any further repair activity. You must pay for the cost of repair and return shipping costs for the repair of Products that are not covered by this limited warranty.

What must you return with the Product to get warranty service?

1. Return the entire original package and contents including the Product to the VTech service location along with a description of the malfunction or difficulty; and
2. Include "valid proof of purchase" (sales receipt) identifying the Product purchased (Product model) and the date of purchase or receipt; and
3. Provide your name, complete and correct mailing address, and telephone number.

Other Limitations

This warranty is the complete and exclusive agreement between you and VTech. It supersedes all other written or oral communications related to this Product. VTech provides no other warranties for this Product. The warranty exclusively describes all of VTech's responsibilities regarding the Product. There are no other express warranties. No one is authorized to make modifications to this limited warranty and you should not rely on any such modification.

State/Provincial Law Rights: This warranty gives you specific legal rights, and you may also have other rights, which vary from state to state or province to province.

Limitations: Implied warranties, including those of fitness for a particular purpose and merchantability (an unwritten warranty that the Product is fit for ordinary use) are limited to one year from date of purchase. Some states/provinces do not allow limitations on how long an implied warranty lasts, so the above limitation may not apply to you. In no event shall VTech be liable for any indirect, special, incidental, consequential, or similar damages (including, but not limited to lost profits or revenue, inability to use the Product or other associated equipment, the cost of substitute equipment, and claims by third parties) resulting from the use of this Product. Some states/provinces do not allow the exclusion or limitation of incidental or consequential damages, so the above limitation or exclusion may not apply to you.

Please retain your original sales receipt as proof of purchase.

FCC, ACTA and IC regulations

FCC Part 15

This equipment has been tested and found to comply with the requirements for a Class B digital device under Part 15 of the Federal Communications Commission (FCC) rules. These requirements are intended to provide reasonable protection against harmful interference in a residential installation. This equipment generates, uses and can radiate radio frequency energy and, if not installed and used in accordance with the instructions, may cause harmful interference to radio communications. However, there is no guarantee that interference will not occur in a particular installation. If this equipment does cause harmful interference to radio or television reception, which can be determined by turning the equipment off and on, the user is encouraged to try to correct the interference by one or more of the following measures:

- Reorient or relocate the receiving antenna.
- Increase the separation between the equipment and receiver.
- Connect the equipment into an outlet on a circuit different from that to which the receiver is connected.
- Consult the dealer or an experienced radio/TV technician for help.

Changes or modifications to this equipment not expressly approved by the party responsible for compliance could void the user's authority to operate the equipment.

To ensure safety of users, the FCC has established criteria for the amount of radio frequency energy that can be safely absorbed by a user or bystander according to the intended usage of the product. This product has been tested and found to comply with the FCC criteria. The handset may be safely held against the ear of the user. The telephone base shall be installed and used such that parts of the user's body other than the hands are maintained at a distance of approximately 20 cm (8 inches) or more. If you choose to use a clipping device, please make sure to only use the supplied VTech belt clip.

FCC Part 68 and ACTA

This equipment complies with Part 68 of the FCC rules and with technical requirements adopted by the Administrative Council for Terminal Attachments (ACTA). The label on the back or bottom of this equipment contains, among other things, a product identifier in the format US:AAAEQ##TXXXX. This identifier must be provided to your local telephone company upon request.

The plug and jack used to connect this equipment to premises wiring and the telephone network must comply with applicable Part 68 rules and technical requirements adopted by ACTA. A compliant telephone cord and modular plug is provided with this product. It is designed to be connected to a compatible modular jack that is also compliant. An RJ11 jack should normally be used for connecting to a single line and an RJ14 jack for two lines. See Installation Instructions in the user's manual.

The Ringer Equivalence Number (REN) is used to determine how many devices you may connect to your telephone line and still have them ring when you are called. The REN for this product is encoded as the 6th and 7th characters following the US: in the product identifier (e.g., if ## is 03, the REN is 0.3). In most, but not all areas, the sum of all RENs should be five (5.0) or less. For more information, please contact your local telephone company.

This equipment may not be used with Party Lines. If you have specially wired alarm dialing equipment connected to your telephone line, ensure the connection of this equipment does not disable your alarm equipment. If you have questions about what will disable alarm equipment, consult your telephone company or a qualified installer.

If this equipment is malfunctioning, it must be unplugged from the modular jack until the problem has been corrected. Repairs to this telephone equipment can only be made by the manufacturer or its authorized agents. For repair procedures, follow the instructions outlined under the Limited Warranty.

If this equipment is causing harm to the telephone network, the telephone company may temporarily discontinue your telephone service. The telephone company is required to notify you before interrupting service. If advance notice is not practical, you will be notified as soon as possible. You will be given the opportunity to correct

the problem and the telephone company is required to inform you of your right to file a complaint with the FCC. Your telephone company may make changes in its facilities, equipment, operation, or procedures that could affect the proper functioning of this product. The telephone company is required to notify you if such changes are planned.

If this product is equipped with a corded or cordless handset, it is hearing aid compatible.

If this product has memory dialing locations, you may choose to store emergency telephone numbers (e.g., police, fire, medical) in these locations. If you do store or test emergency numbers, please:

- Remain on the line and briefly explain the reason for the call before hanging up.
- Perform such activities in off-peak hours, such as early morning or late evening.

Industry Canada

This equipment complies with regulations RSS210 and CS-03 of Industry Canada. Operation is subject to the following two conditions: (1) this device may not cause interference, and (2) this device must accept any interference, including interference that may cause undesired operation of the device.

The term "IC: " before the certification/registration number only signifies that the Industry Canada technical specifications were met.

The Ringer Equivalence Number (REN) for this terminal equipment is 0.1. The REN is an indication of the maximum number of devices allowed to be connected to a telephone interface. The termination on an interface may consist of any combination of devices subject only to the requirement that the sum of the RENs of all the devices does not exceed five.

The RBRC® seal



The RBRC® seal on the nickel-metal-hydride battery indicates that VTech Communications, Inc. is voluntarily participating in an industry program to collect and recycle these batteries at the end of their useful lives, when taken out of service within the United States and Canada.

The RBRC® program provides a convenient alternative to placing used nickel-metal-hydride batteries into the trash or municipal waste, which may be illegal in your area.

VTech's participation in RBRC® makes it easy for you to drop off the spent battery at local retailers participating in the RBRC® program or at authorized VTech product service centers. Please call **1-800-8-BATTERY™** for information on Ni-MH battery recycling and disposal bans/restrictions in your area. VTech's involvement in this program is part of its commitment to protecting our environment and conserving natural resources.

RBRC® is a registered trademark of Rechargeable Battery Recycling Corporation.

Technical specifications

Frequency control	Crystal controlled PLL synthesizer
Transmit frequency	Telephone base: 5725-5850 MHz Handset: 2400-2483 MHz
Receive frequency	Telephone base: 2400-2483.5 MHz Handset: 5725-5850 MHz
Channels	95
Nominal effective range	Maximum power allowed by FCC and IC. Actual operating range may vary according to environmental conditions at the time of use.
Size	Handset: 158.7mm X 52.7mm X 41.3mm Telephone base: 128.7mm X 122.6mm X 77.5mm
Weight	Handset: 145.0 grams (including battery) Telephone base: 423.8 grams
Power requirements	Handset: 3 cells AAA 3.6V 600mAh NiMH battery Telephone base: DC 9V@ 400mA
Memory	Directory: 50 memory locations; up to 32 digits, 16 characters per location Call log: 50 memory locations

Index

- A**
 - About caller ID 19
 - About cordless telephones 37
 - Advanced operation 15

- B**
 - Basic operation 12
 - Battery 2, 27
 - Belt clip & headset 4

- C**
 - Caller ID 20
 - Call log display screen messages 22
 - Call waiting 13
 - Character chart 16
 - Clear voicemail 11

- D**
 - Delete a directory entry 18
 - Delete a redial entry 23
 - Delete one or all entries in call log 22
 - Desk/table bracket installation 6
 - Dial a call log entry 21
 - Dial a directory entry 17
 - Dial from redial 23
 - Dial type 11
 - Directory 15
 - DSL service 5

- E**
 - Edit a directory entry 18

- F**
 - FCC, ACTA and IC regulations 39
 - Find handset 14

- H**
 - Handset and telephone base lights 26
 - Handset display screen messages 24
 - Handset icons 26
 - Handset layout 7
 - Handset lights 26

- I**
 - Important safety instructions 35
 - Index 42
 - Install handset battery 2
 - Installation 1

- K**
 - Key tone 10

- L**
 - Language 10

Index

M

- Maintenance 36
- Make, answer and end calls 12
- Mute 12

O

- Operating range 36

P

- Parts checklist 1

R

- Redial list 23
- Review the call log 20
- Ringer mute 13
- Ringer tone 9
- Ringer volume 9

S

- Save an entry to the directory 21
- Search the directory 17
- Speakerphone 12
- Store a directory entry 15

T

- Technical specifications 41
- Telephone base installation 3
- Telephone base layout 8
- Telephone base lights 26
- Telephone settings 7
- The RBRC® seal
- Troubleshooting 28

V

- Voicemail 14
- Volume 13

W

- Wall mounting bracket installation 6
- Warranty 37

VTECH TELECOMMUNICATIONS LTD.

A member of THE VTECH GROUP OF COMPANIES.

Distributed in the U.S.A. by VTech Communications, Inc., Beaverton, Oregon

Distributed in Canada by VTech Telecommunications Canada, Ltd., Richmond, B.C.

Copyright ©2007 for VTECH TELECOMMUNICATIONS LTD.

Printed in China.

91-001052-010-100

vtech[®]
Innovation Beyond Technology™



User's manual

www.vtechphones.com

Model: i6717

Download from Www.Somanuals.com. All Manuals Search And Download.

5.8^{GHz}
Digital

Free Manuals Download Website

<http://myh66.com>

<http://usermanuals.us>

<http://www.somanuals.com>

<http://www.4manuals.cc>

<http://www.manual-lib.com>

<http://www.404manual.com>

<http://www.luxmanual.com>

<http://aubethermostatmanual.com>

Golf course search by state

<http://golfingnear.com>

Email search by domain

<http://emailbydomain.com>

Auto manuals search

<http://auto.somanuals.com>

TV manuals search

<http://tv.somanuals.com>