

Quick start guide for model LS5146

Install the telephone base

Install the telephone base as shown below.

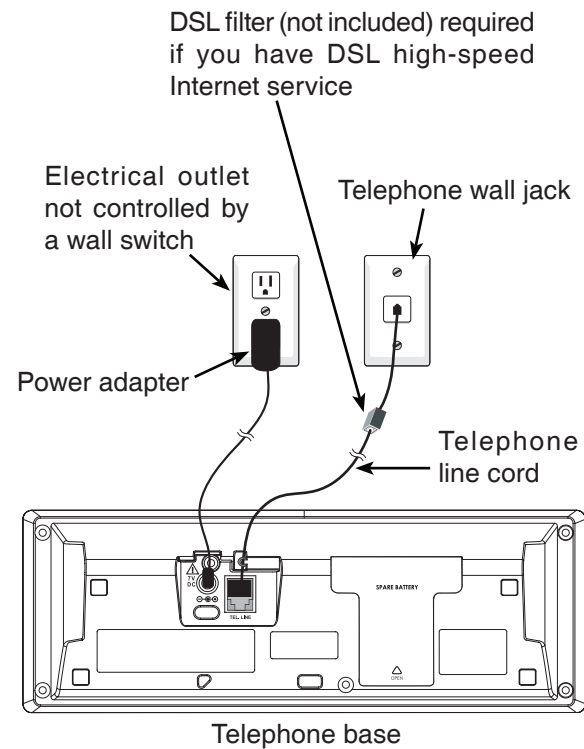

NOTES:

1. Use only the power adapter and battery supplied with your VTech telephone.
2. For complete feature instructions, please refer to your user's manual.

Battery installation and charging

Install the battery as shown below. For optimal performance, charge the handset battery for at least 16 hours before use.

1. Press the tab and slide the battery compartment cover downwards.
2. Insert the plug as indicated. Make sure it is plugged securely and matches the color-coded label inside the battery compartment.

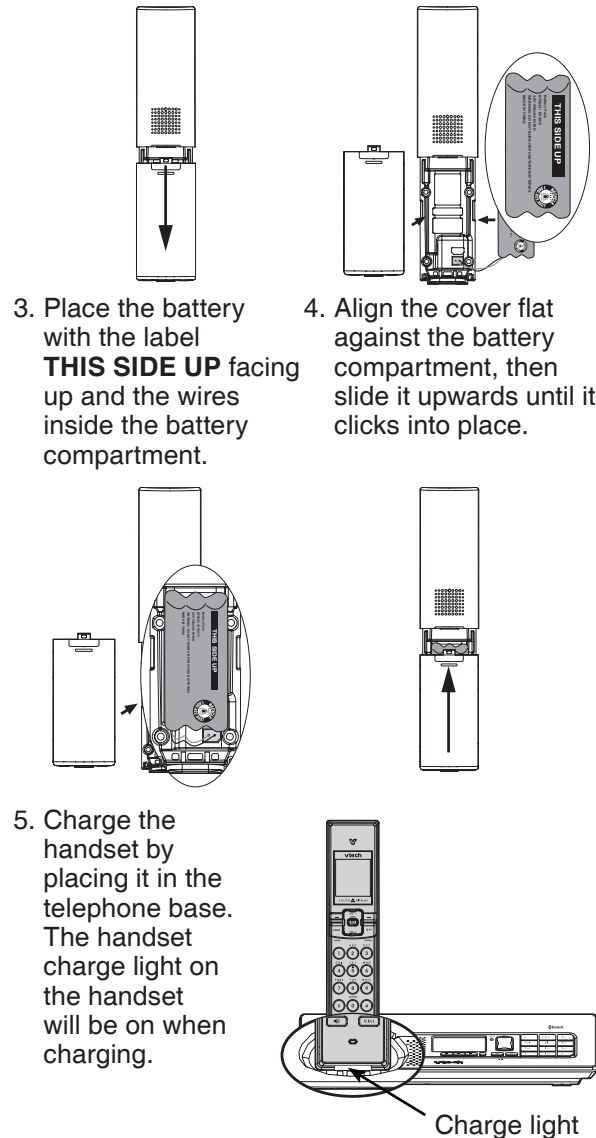

Pair your first Bluetooth cell phone

To pair and connect your first Bluetooth cell phone:

1. Press **CELL** on the telephone base.
2. Press the **YES** softkey.
3. Set your cell phone to search for or add new devices, then press the **NEXT** softkey.
4. Once your cell phone finds your **VTech LS5146**, select it and then enter the PIN **0000** on your cell phone.
5. When pairing is completed, press the **YES** softkey on the telephone base.

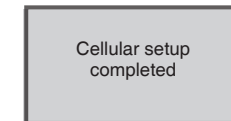
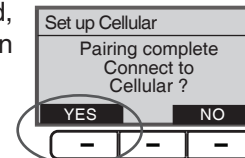
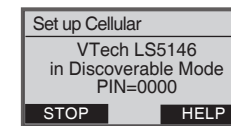
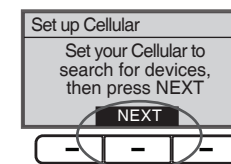
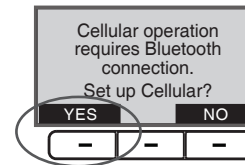
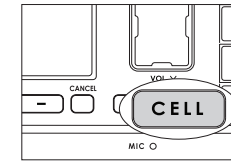

Pair your first Bluetooth headset

To pair and connect your first Bluetooth headset:

1. Press the **MENU** softkey on the telephone base.
2. Press the **UP** and **DOWN** NavKeys to highlight **Bluetooth**, then press the **SELECT** softkey.
3. Press the **UP** and **DOWN** NavKeys to highlight **Set up Headset**, then press the **SELECT** softkey.
4. Set your headset to discoverable mode, then press the **NEXT** softkey.
5. Once the telephone base finds your headset, select it and then press the **PAIR** softkey.
6. Enter your headset's PIN on the telephone base, then press the **DONE** softkey. The default PIN for most headsets is **0000**.
7. When the pairing is completed, press the **YES** softkey on the telephone base.

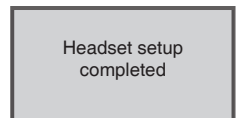
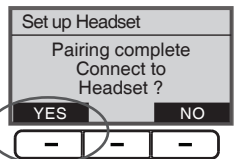
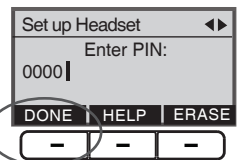
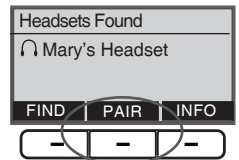
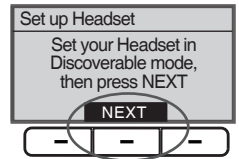
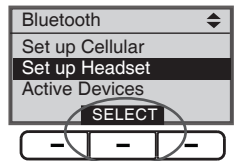
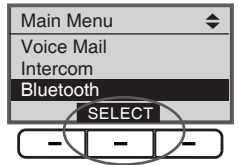

Make, receive and end calls

To make a **HOME** call:

- Dial the telephone number, then press **HOME/FLASH** or  on the handset, or **HOME** on the telephone base.

To receive a **HOME** call:

- Press **HOME/FLASH** or  on the handset or **HOME** on the telephone base.

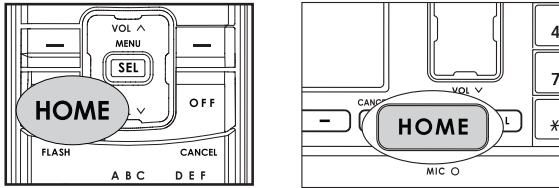

If you have a Bluetooth headset connected, press the call button on your headset to receive **HOME** calls.

To make a **CELL** call:

- Dial the telephone number, then press **CELL** on the handset or telephone base.

To receive a **CELL** call:

- Press **CELL** or  on the handset or **CELL** on the telephone base.

To end a **HOME** or **CELL** call on the handset:

- Press the **OFF/CANCEL** or return the handset in the telephone base or charger.

To end a call on the telephone base:

- Press **HOME** for a **HOME** call.
- Press **CELL** for a **CELL** call

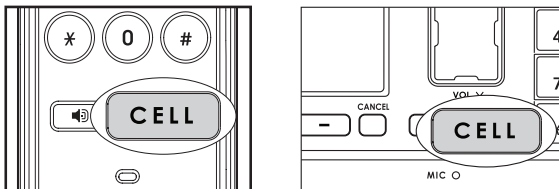

Voice mail setup

If you subscribe to voice mail service provided by your telephone service provider, you can easily access your voice mail features using the right NavKey on the handset or telephone base when the telephone is not in use, but you must first set your voice mail codes on the telephone base.

To set your voice mail codes:

1. Press the **MENU** softkey on the telephone base.
2. Press the **UP** and **DOWN** NavKeys to highlight **Settings**, then press the **SELECT** softkey.
3. Press the **UP** and **DOWN** NavKeys to highlight **Voice Mail Codes**, then press the **SELECT** softkey.
4. Press the **UP** and **DOWN** NavKeys to highlight **Voice Mail access**, **Play Messages**, **Skip Message**, **Repeat Message**, **Delete Message**, **Msg Time Stamp**, then press the **SELECT** softkey.
5. Use the dial pad to enter your access number.
 - Press the **ERASE** softkey to delete a highlighted character.
 - Press and hold the **#** key to enter a two-second dialing pause (if necessary) and then enter your PIN or password.
6. Press the **SAVE** softkey to confirm your setting.

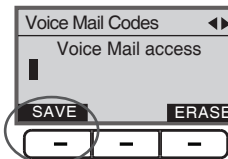
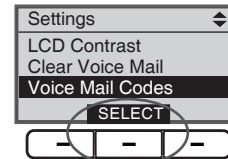
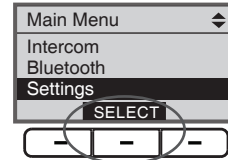

Access to voice mail codes

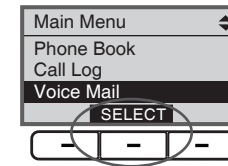

To access your programmed voice mail codes:

1. Press **MENU/SEL** on the handset or the **MENU** softkey on the telephone base.
2. Press the **UP** or **DOWN** NavKeys to select **Voice Mail**.
3. Press **MENU/SEL** on the handset or the **SELECT** softkey on the telephone base to dial your voice mail service.
4. When connected to your service, press the **OPTIONS** softkey to display various call options.
5. Press the **UP** and **DOWN** NavKeys to highlight one of the below options, then press the **SELECT** softkey.
 - **Play Messages**
 - **Skip Message**
 - **Repeat Message**
 - **Delete Message**
 - **Msg Time Stamp**
 - **Hold Home Call**
6. Press **MENU/SEL** on the handset or the **SELECT** softkey on the telephone base.

More about Bluetooth

You can make and receive calls using the **HOME** and **CELL** lines. The **HOME** line is your conventional telephone land line. The **CELL** line is the communications service provided through your Bluetooth enabled cell phone.

Before using your Bluetooth device(s) with the telephone base, make sure that:

- Your cell phone and/or headset devices are not connected to any other Bluetooth device(s) and the Bluetooth wireless function is on.
- Your device is connected to the telephone base and on the **Active Devices** list.

If you experience difficulty using your Bluetooth cell phone:

1. Make sure that your Bluetooth cell phone is working properly. See your Bluetooth device(s) user's manual for more information.
2. Delete the **VTech LS5146** device on your cell phone, then delete your cell phone on the **Pair Devices** list.
3. Repeat the pairing process in **Pair your first Bluetooth cell phone** in this Quick start guide.

IMPORTANT!

If your product is not working properly:

- Refer to the **Troubleshooting** section of the user's manual.
- Visit our website at www.vtechphones.com or call 1 (800) 595-9511. In Canada, go to www.vtechcanada.com or 1 (800) 267-7377.

The **BLUETOOTH®** word mark and logos are owned by Bluetooth SIG, Inc. and any use of such marks by VTech Holdings Limited is under license. VTech Holdings Limited is a member of Bluetooth SIG, Inc. Other trademarks and trade names are those of their respective owners.

Free Manuals Download Website

<http://myh66.com>

<http://usermanuals.us>

<http://www.somanuals.com>

<http://www.4manuals.cc>

<http://www.manual-lib.com>

<http://www.404manual.com>

<http://www.luxmanual.com>

<http://aubethermostatmanual.com>

Golf course search by state

<http://golfingnear.com>

Email search by domain

<http://emailbydomain.com>

Auto manuals search

<http://auto.somanuals.com>

TV manuals search

<http://tv.somanuals.com>