

# vtech®

## USER'S MANUAL



Model: mi6821

**5.8**  
GHz  
Digital Spread  
Spectrum

**Expandable System with Caller ID**

**FEATURING:** Caller ID\* / Call Waiting • Handset  
Speakerphone • Headset Compatible (2.5mm)

# Important Safety Instructions

---

When using your telephone equipment, basic safety precautions should always be followed to reduce the risk of fire, electric shock and injury, including the following:

1. Read and understand all instructions.
2. Follow all warnings and instructions marked on the product.
3. Unplug this product from the wall outlet before cleaning. Do not use liquid or aerosol cleaners. Use a damp cloth for cleaning.
4. Do not use this product near water (for example, near a bath tub, kitchen sink or swimming pool).
5. Do not place this product on an unstable surface, such as a table, shelf or stand. The product may fall, causing serious damage.
6. Slots and openings in the back or bottom of the base unit and handset are provided for ventilation. To protect them from overheating, these openings must not be blocked by placing the product on a soft surface such as a bed, sofa or rug. This product should never be placed near or over a radiator or heat register. This product should not be placed in any area where proper ventilation is not provided.
7. This product should be operated only from the type of power source indicated on the marking label. If you are not sure of the type of power supply in your home, consult your dealer or local power company.
8. Do not allow anything to rest on the power cord. Do not install this product where the cord may have anyone walking on it.
9. Never push objects of any kind into this product through slots in the base or handset as they may touch dangerous voltage points or short out parts that could result in a risk of fire or electric shock. Never spill liquid of any kind on the product.
10. To reduce the risk of electric shock, do not disassemble this product, but take it to an authorized service facility. Opening or removing parts of the base or handset other than specified access doors may expose you to dangerous voltages or other risks. Incorrect reassembling can cause electric shock when the product is subsequently used.
11. Do not overload wall outlets and extension cords as this can result in the risk of fire or electric shock.
12. Unplug this product from the wall outlet and refer servicing to an authorized service facility under the following conditions:
  - A. When the power supply cord or plug is damaged or frayed.
  - B. If liquid has been spilled onto the product.
  - C. If the product has been exposed to rain or water.
  - D. If the product does not operate normally by following the operating instructions. Adjust only those controls that are covered by the operating instructions, as improper adjustment of other controls may result in damage and often requires extensive work by an authorized technician to restore the product to normal operation.
  - E. If the product has been dropped and the base and/or handset has been damaged.
  - F. If the product exhibits a distinct change in performance.
13. Avoid using a telephone (other than cordless) during an electrical storm. There is a remote risk of electric shock from lightning.
14. Do not use the telephone to report a gas leak in the vicinity of the leak.
15. Only put the handset of your telephone next to your ear when it is in normal talk mode.

# Important Safety Instructions

---

**VTECH COMMUNICATIONS INC.** Customer Service: 1-800-595-9511. In Canada, call VTech Telecommunications Canada Ltd. at 1-800-267-7377.

**BEFORE USING YOUR mi 6821 SYSTEM, CAREFULLY PEEL OFF THE PROTECTIVE FILM COVERING THE DISPLAYS.**

## **Introduction**

The **mi 6821** is an advanced cordless telephone set, capable of supporting four handsets.

This manual is designed to familiarize you with this cordless telephone. We strongly recommend you read the manual before using your phone.

# Parts Check List

1. Handset
2. Base Unit
3. Base Wall Mounting Bracket
4. Base Power Adapter
5. Telephone Line Cord
6. Belt Clip
7. User's Manual
8. Battery

To purchase replacement batteries, visit us on the web at [www.vtechphones.com](http://www.vtechphones.com) or call VTech Communications, Inc. at 1-800-595-9511. In Canada, call VTech Telecommunications Canada Ltd. at 1-800-267-7377.

**NOTE:** Use only VTech batteries (part number 89-1323-00-00).



Handset

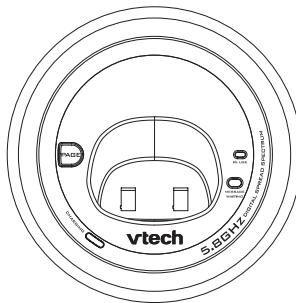

Base Unit

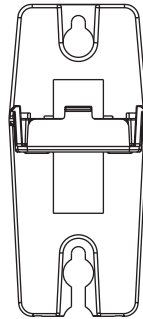

Base Wall Mounting Bracket

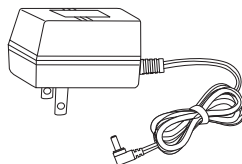

Base Power Adapter

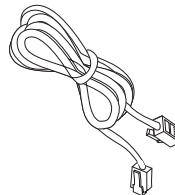

Telephone Cord Line



Belt Clip

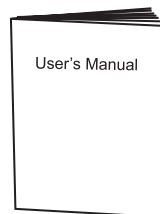

User's Manual



Battery

# The Handset Layout

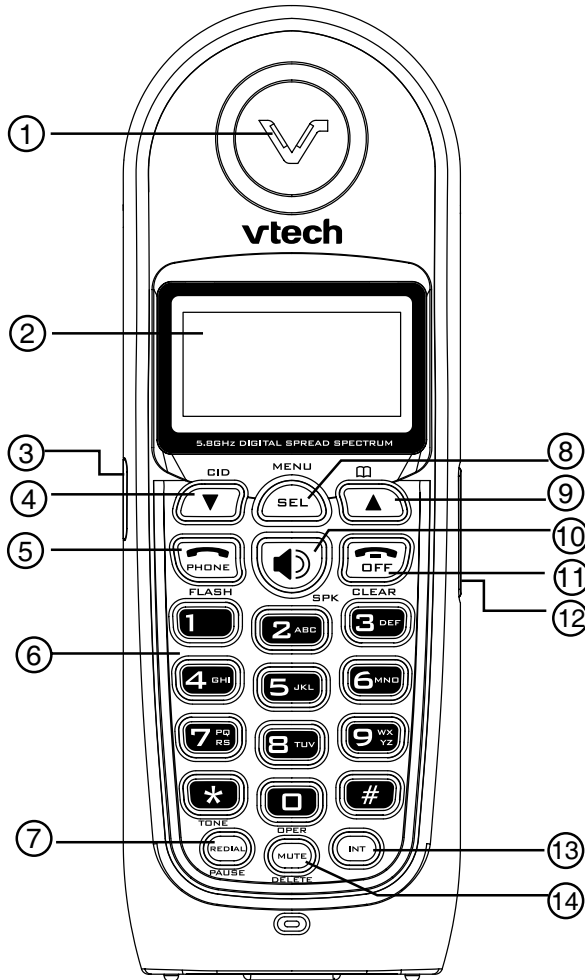

- |                             |                          |
|-----------------------------|--------------------------|
| 1. Earpiece                 | 8. Select (Menu)         |
| 2. LCD Display              | 9. Phonebook (Scroll Up) |
| 3. Headset Jack (2.5mm)     | 10. Speakerphone         |
| 4. CID (Scroll Down)        | 11. Off (Clear)          |
| 5. Phone (Flash)            | 12. Volume Control       |
| 6. Dialing Keys (0-9, *, #) | 13. Intercom             |
| 7. Redial (Pause)           | 14. Mute (Delete)        |

## The Base Unit Layout

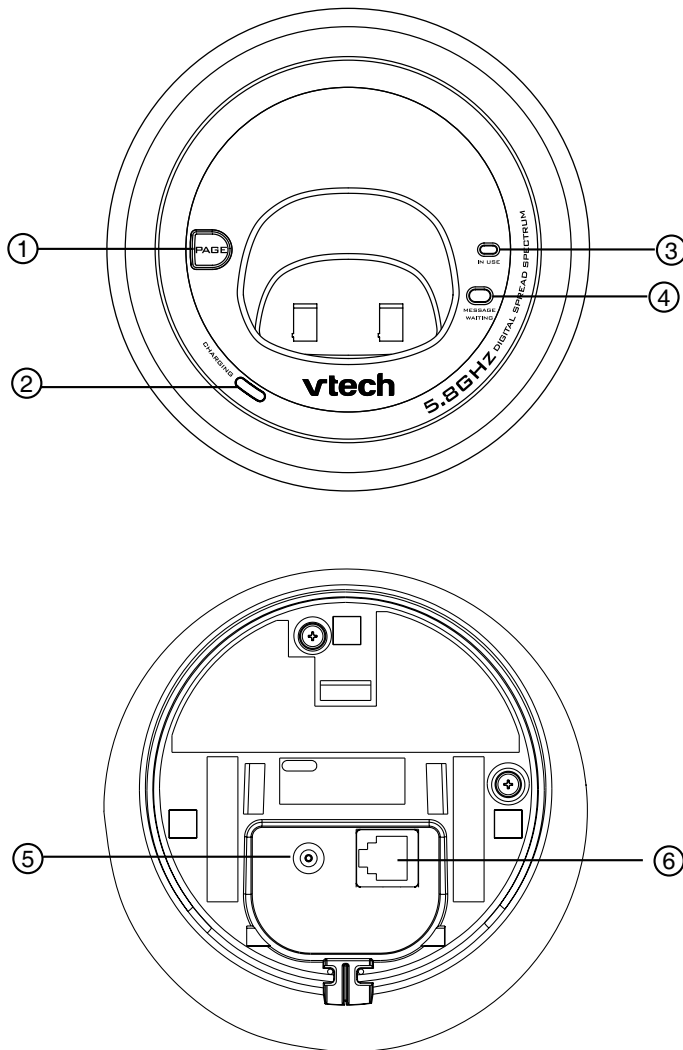

1. Page Key
2. Charging LED
3. In Use LED
4. Message Waiting LED
5. Connector Jack
6. Telephone Jack

## Setup

### Connecting power to Base Unit

Plug the power adapter into an electrical outlet, and the connector into the connector jack at the bottom of the base unit.

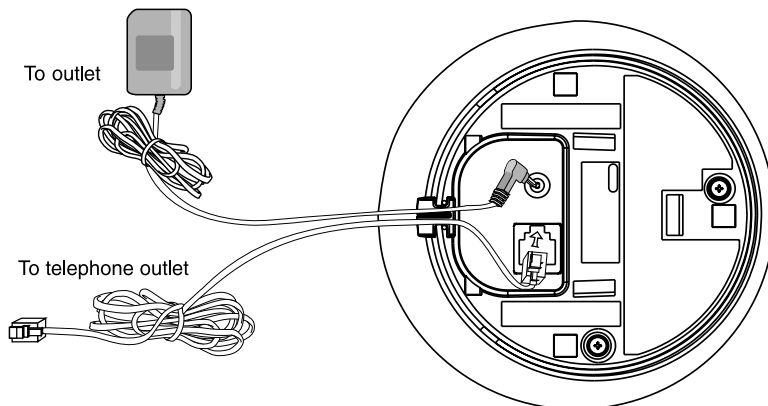

**CAUTION:** Use only the VTech power supply provided with your telephone.

### Installation of Battery

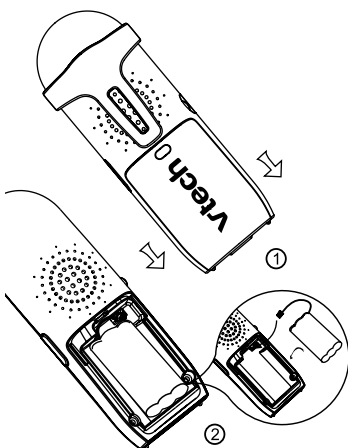

1. Remove battery compartment cover by pressing on the indentation and sliding downward.
2. Align the two holes in the plug with the socket pins, then snap the plug into place. Place the battery in the compartment with the wires in the upper right corner.
3. Replace the battery cover by sliding it upwards.
4. If the new battery is not already charged, place the handset in its base unit and allow it to charge for 10-12 hours. After that, be sure to place the handset in its base when not in use to insure maximum daily performance. After the initial charge, a maintenance charge of 8 hours should be sufficient.
5. Average talk time on a fully charged battery is about nine hours, standby time is approximately four days.

## Setup

### Charging of the Handset Battery

The handset of your cordless telephone is powered by rechargeable battery. It charges automatically whenever the handset is in its base unit.

**You should charge the batteries for 10-12 hours when you first receive your phone.** You will know the battery needs charging when:

- The low battery message is displayed:
- The handset seems completely dead, the LCD is completely clear and does not activate when you press the keys.



### IMPORTANT:

1. Do not dispose of batteries in a fire, they might explode.
2. Do not open or mutilate the batteries. Toxic substances may be released, causing harm to eyes or skin.
3. Exercise care in handling batteries in order to prevent an accidental short of the charge contacts, potentially causing the batteries to overheat.
4. Do not dispose of these batteries into household garbage, they should be properly recycled.
5. Do not charge the batteries with other electrical devices.
6. If the phone will not be used for a long period of time, remove the battery to prevent possible leakage.

### Connecting to Phone Line

Plug one end of the telephone line cord into the jack on the back of the base unit. Then plug the other end of this cord into the wall jack. Before connecting to phone line, be sure to charge the battery for at least 12 hours.

### Checking for Dial Tone

After the battery is charged, press **PHONE** on the handset. The LCD displays **PHONE** and shows a call timer, and you will hear a dial tone. If not, see **In Case of Difficulty**.



## Setup

**IMPORTANT!** FOR MAXIMUM PERFORMANCE OF YOUR CORDLESS TELEPHONE SYSTEM:

1. Choose a central location for your base unit.
2. Install your base unit and extension handsets away from electronic equipment, such as personal computers, television sets and microwave ovens.
3. In locations where there are multiple cordless telephones, separate the base units as far away as possible.
4. Install your telephone equipment away from heat sources and sunlight.
5. Avoid excessive moisture, dust or extreme cold.

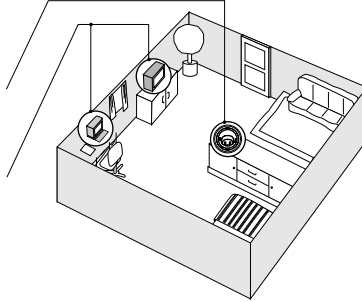

## Wall Mounting

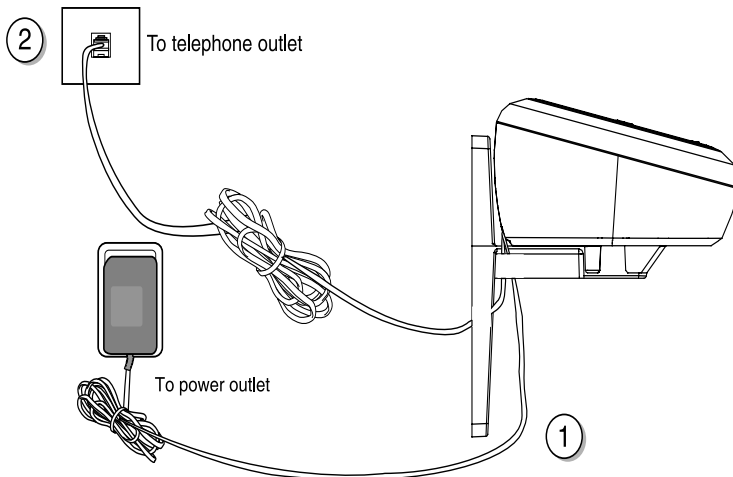

The wall mount bracket is designed for use on standard wall mount plates only. Wall mounting is optional.

1. Plug the adapter into an electrical outlet, and the connector to the bottom of the base unit.
2. Connect the telephone line cord to the jack at the bottom of the base unit, and the other end to the wall jack.
3. Line up the tabs on the wall mount adapters with the holes at the bottom of the base unit. Snap the wall mount bracket firmly in place.
4. Mount the base unit on the wall. Position the base unit so the mounting studs will fit into the holes on the wall mount bracket. Slide base unit down on the mounting studs until it locks into place.



# Handset and Base Indicators

## Handset Icons

Icon	Description
MUTE	<ul style="list-style-type: none"> <li>• Turns on when the microphone is muted.</li> </ul>
NEW	<ul style="list-style-type: none"> <li>• Turns on when there are new call log entries.</li> </ul>
	<ul style="list-style-type: none"> <li>• Turns on when the ringer is muted.</li> </ul>
	<ul style="list-style-type: none"> <li>• Low battery indicator and charging indicator</li> </ul>

## Handset LED

LED	Description
	<ul style="list-style-type: none"> <li>• LED is on when in handsfree mode.</li> </ul>

## Base LEDs

LED	Description
IN USE	<ul style="list-style-type: none"> <li>• On when the phone is off hook.</li> <li>• Flashes when an extension phone is off hook.</li> </ul>
CHARGING	<ul style="list-style-type: none"> <li>• On when the handset is charging in the base.</li> </ul>
MESSAGE WAITING	<ul style="list-style-type: none"> <li>• Flashes when the visual message waiting signal has been detected. Service must be subscribed through your local telephone company.</li> </ul>

# Handset Operation

## Making Calls

- Press **PHONE** (or, **SPK** to use the handset speaker-phone feature). Dial the phone number.  
-OR-
- Dial the phone number first. If make a mistake, press **DELETE** or **CLEAR** to clear it .If you desire, press and hold **PAUSE** to add pauses. Then press **PHONE** (or **SPK**).
- Press **OFF** or place the handset in the base to end your call.

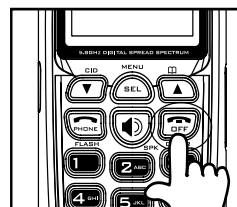
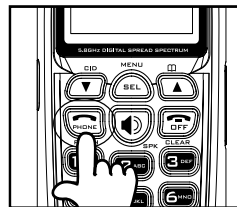

## Answering Calls

- Press **PHONE**, **SPK**, or any dial pad keys.
- Press **OFF** or place the handset in the base to end your call.

## Speakerphone Operation

Your **mi 6821** handset has a built-in handsfree speaker-phone. This feature allows you to stand the handset up right on a table or desktop and have handsfree conversations. During a call you can press **SPK** to change to a handsfree conversation from normal handset use. Press **OFF** or place the handset in the base to hang up.

**Adjusting Handset Volume** (also applies to the handset speakerphone and headset)

The volume control is on the right edge of the handset. During a call, press **VOL +** or **-** key to adjust the listening volume to a comfortable level. When you reach the maximum or minimum setting, a double-beep will sound.

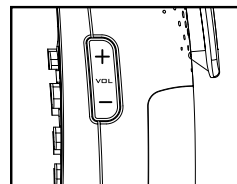

## Flash Function

You can use your **mi 6821** with services such as call waiting. When you receive a call waiting signal, simply press the **FLASH** key to switch to the new call. Press **FLASH** again to switch back to the original call.

**NOTE:** Use **FLASH** to access other phone company subscriber services, as described by your provider.

## Redial Function

- Press **REDIAL** to display the last telephone number dialed from the handset (up to 32 digits). Use **▲** or **▼** to scroll through the five previously dialed numbers. When the beginning or the end of the redial list is reached, a double beep will sound.
- When the desired number is reached, press **PHONE**

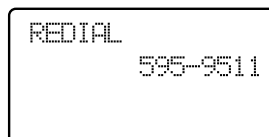

# Handset Operation

or **SPK** to dial.

- Press **OFF** to exit the redial review list.

**NOTE:** When redial memory is empty, and **REDIAL** is pressed, a double beep will sound. When the desired entry displays, press **DELETE** to delete it. You'll hear a confirmation beep.

## Temporary ringer adjustments

When handset is ringing, to silence the handset's ringer, press **OFF** or **MUTE**, or adjust the ringer level to level 0 by using the handset volume keys.

This adjustment is temporary, and only last for the current ringing call. The ringer volume will return to its normal setting once the call is answered, or the ringing stops.

## Mute Function

- During an active call, press the **MUTE** key to disable the microphone. The screen will display:
- Press **MUTE** again to return to normal two way conversation. **MICROPHONE ON** will display briefly.

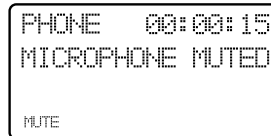

PHONE 00:00:15  
MICROPHONE MUTED  
MUTE

## Intercom Call

If you have registered accessory handsets (model **mi 6820**) to your **mi 6821** base, you can intercom between system handsets.

- From the idle (off) mode, press **INT**. The first handset (HS1) will display:
- Select a number of the handset to be called. The display will change to (X is handset number):
- Press **INT** or **PHONE** or **SPK** on handset X to answer the intercom call. The screens will display:
- Press **INT** or **OFF** on either handset to end the call.

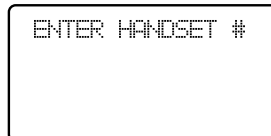

ENTER HANDSET #

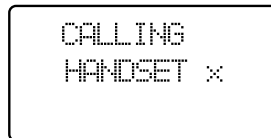

CALLING  
HANDSET X

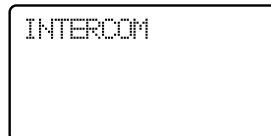

INTERCOM

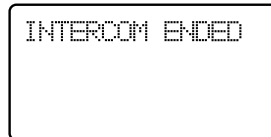

INTERCOM ENDED

## Handset Operation

**NOTE:** If HSX is out of range, or on an external call, when HS1 attempts to intercom it, the display of HS1 will show:

UNABLE TO CALL  
TRY AGAIN

### Call Forward

If you have registered accessory handsets (model **mi 6820**) to your base, you can forward calls between system handsets. An external call can be forwarded from one handset (HS1) to any other handset.

- A handset (HS1), on an external call can forward it to any other handset .
- Press the **INT** key on HS1, it will display:
- Enter the handset number you wish to forward to. HS1 will display:
- HS2 can press **PHONE** to answer the call.

ENTER HANDSET #

CALL FORWARDED

CALL BACK

**NOTE:** If HS2 does not respond in about one minute the external call will be returned to HS1 and the display will show:

If the returned call is not answered within one minute, the external call will end automatically.

### Conference Call

If you have registered accessory handsets (model **mi 6820**) to your **mi 6821** base, you can have conference calls between system handsets.

It is possible to establish a conference between any two handsets and the external line.

If a handset already has a connection to the external line, and any other handset goes off-hook, a conference is immediately established. Both handsets will show:

CONF. 00:00:25

### Base Operation

From the base unit, press **PAGE** to locate the handsets.

- When the handset is in idle, press **PAGE**. The handsets will beep and display:
- To end the page, press **PHONE**, **SPK**, or any dial pad key (**0-9**, **\***, **#**) at the handset, or press **PAGE** at the base.

BASE IS  
PAGING

## Phonebook Operation

Your **mi 6821** can store up to 50 numbers with names in memory. Each memory location can hold up to 32 digits for the number and 16 characters for the name.

**NOTE:** If you register additional handsets to your **mi 6821** base, the handsets share a common phonebook, which is stored in the base. This means that entries inserted by one handset are available for all handsets, and if one deletes a phonebook entry, it will disappear from all handsets.

When one handset is accessing the phonebook, the other handsets cannot access it at the same time. If this is attempted, **NOT AVAILABLE AT THIS TIME** will display.

### Storing a New Entry

- Press **MENU**.
- With **PHONEBOOK** highlighted, press **SEL**.
- Press **▼** to select **STORE**. Press **SEL**.
- You will be prompted to **ENTER NUMBER**. Use the dialing keys to enter the number you wish to store in the phonebook. Press the **DELETE** key to backspace and make corrections. Press **SEL**.
- You will then be prompted to **ENTER NAME**. Use the dialing keys to spell the name. Use the **▲** and **▼** to move the cursor. Press **DELETE** to backspace and make corrections. Press **SEL**.
- You'll hear a confirmation tone, and the new phonebook entry will be displayed.

>STORE  
REVI EW

ENTER NUMBER  
800-595-9511\_

ENTER NAME  
\_

### NOTES:

- If the phonebook is full, the handset will display **PHONEBOOK IS FULL**.
- You can also press **REDIAL** then **▲** or **▼** to scroll to the previously dialed number from the redial list you want to store in the phonebook. Press **SEL**.
- While entering numbers, press and hold **PAUSE** to add pauses if necessary.
- If there is a duplicate number in the phonebook, the display will show:

PHONEBOOK  
IS FULL

NUMBER ALREADY  
IN PHONEBOOK

# Phonebook Operation

Each press of a particular key causes characters to be displayed in the following order:

Key	Characters by number of key presses								
	1	2	3	4	5	6	7	8	9
1	space	1							
2	A	B	C	2	a	b	c		
3	D	E	F	3	d	e	f		
4	G	H	I	4	g	h	i		
5	J	K	L	5	j	k	l		
6	M	N	O	6	m	n	o		
7	P	Q	R	S	7	p	q	r	s
8	T	U	V	8	t	u	v		
9	W	X	Y	Z	9	w	x	y	z
0	0								
*	*	?	!	/	(	)			
#	#	'	,	-	.	&			

### Reviewing/Dialing from the Phonebook

- Press **MENU**. With **PHONEBOOK** highlighted, press **SEL**. With the **REVIEW** highlighted, press **SEL**.

- OR -

With the handset idle, press ▲, the handset goes directly into phonebook review mode.

- Scroll through the phonebook entries using the ▲ and ▼ keys or enter first character of the name to be searched (using the digit keys) and continue navigating using the ▲ or ▼ as scroll keys, until you reach the entry to be dialed.

**NOTE:** When reviewing the phonebook, the second line of the display will show the phone number, up to 16 digits. For numbers longer than 16 digits, only the first 13 digits will be shown. Press \* or # to scroll the phone number to see the additional digits.

- Press **PHONE** or **SPK**, to dial the number.

**NOTE:** If there are no entries in the phonebook, when it is accessed, **PHONEBOOK IS EMPTY** will display.

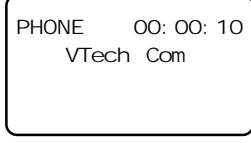
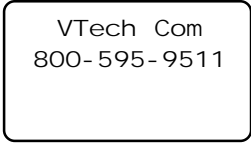



# Phonebook Operation

## Editing a Phonebook Entry

- Follow the first two steps in **Reviewing/Dialing from the Phonebook** (page 15) to reach the entry to be edited.
- Press **SEL**.
- Press **DELETE** to backspace then enter the correct number. Press and hold **PAUSE** to add pauses if necessary. You can also press **REDIAL**, then **▲** or **▼** to scroll to the previously dialed number from redial list you want to store in the phonebook. Press **SEL**.
- Press **SEL** to confirm.

VTech Com  
800-595-9511

EDI T NUMBER  
800-595-9511\_

- You are now prompted to **EDIT NAME**. Press **DELETE** to backspace, then use the dialing keys to enter the correct name (see page 15). Use the **▲** and **▼** to move the cursor.
- Press **SEL** to confirm. A confirmation tone will sound.

EDI T NAME  
VTech

VTech  
595-9511

## Delete a Phonebook Entry

- Follow the first two steps in **Reviewing/Dialing from the Phonebook** (page 15) to reach the entry to be deleted.
- Press **DELETE** to delete the entry. A confirmation tone will sound.
- The handset will then move to the next entry, if any.

VTech Com  
800-595-9511

VTech  
595-9511

## Calls Log (Caller ID - Call Waiting)

### Caller ID - Call Waiting ID

Your **mi 6821** is capable of displaying the name and/or number of the party calling before you answer the phone (**Caller ID** or **CID**). It is also capable of displaying CID information in conjunction with a call waiting alert signal (**Call Waiting Caller ID**). With call waiting CID, the CID data is displayed so you can decide whether to answer the incoming call, or continue with your current conversation. Your **mi 6821** can hold up to 50 CID entries.

#### NOTES ABOUT CALLER ID & CALL WAITING CALLER ID

These are subscription services, provided by most regional telephone service providers. You must subscribe to these services to get the benefits of these features. If you do not subscribe to caller ID services, you can still use your **mi 6821** and the other features it offers.

Due to regional incompatibilities, CID information may not be available for every call you receive. In addition, the calling party may intentionally block their name and/or phone number from being sent.

When one handset is accessing the call log, the other handsets can not access it at the same time. If this is attempted, **NOT AVAILABLE AT THIS TIME** will display.

- As new CID/call waiting ID records are received, your handset display will alert you to the new caller ID records, for example:
- After you review all new CID records, the **NEW** call indication will be turned off and the screen will show:
- If the call log is full, the oldest entry is deleted to make room for the new call. If the call log is empty when you try to enter to call log review, a message of the following message is displayed:

```
HANDSET1
5 NEW CALLS
NEW
```

```
HANDSET1
5 NEW CALLS
NEW
```

```
CALL LOG
IS EMPTY
```

### Reviewing Caller ID

You can review the CID record via the menu, as described below or by pressing the CID key (quick access key) while in idle mode and the handset jumps directly to CID review.

- In idle mode, press **MENU**.
- Press the ▼ key to scroll to **CALL LOG**.

```
>CALL LOG
RINGER VOLUME
```

## Calls Log (Caller ID - Call Waiting)

- Press **SEL**. Use ▲ or ▼ to scroll through the call log entries.
- When the beginning or the end of the call log is reached, you'll hear a double beep.

**NOTE:** The **NEW** icon in the left down corner indicates the call is not yet reviewed.

```
UTech Com
800-595-9511
NEW 2/23 11:59AM
```

### Storing a Caller ID

- Follow the steps in **Reviewing Caller ID** to scroll to the record to be stored.
- To change the format of the number you wish to store in memory, press the # key repeatedly. The handset will cycle through the alternate dialing options (1 + area code + number, area code + number, 1+ number, or number only). Press **SEL** to store the displayed number.
- You'll hear a confirmation tone and the screen will display:
- If the CID isn't able to detect a name, **EDIT NAME** will be prompted. If unable to detect the number, **EDIT NUMBER** will be prompted. You will then need to enter the name and/or the number.
- If both name and number are missing, for example as in a private listing, the request will be rejected with the message:
- If the phone number already exists in the phonebook, the entry will not be stored, and the screen will show:
- If the phonebook is full, the screen will show:

```
ADDED TO
PHONEBOOK
```

```
UNABLE TO CALL
TRY AGAIN
```

```
NUMBER ALREADY
IN PHONEBOOK
```

```
PHONEBOOK
IS FULL
```

```
UTech Com
800-595-9511
NEW 2/23 11:59AM
```

### Dialing from Caller ID

- Follow the steps in **Reviewing Caller ID** to scroll to the entry to be dialed.
- To change the number before calling, press # repeatedly to see the dialing options (1 + area code + phone number; area code + phone number; 1 + phone number; number only) then press **PHONE** (or **SPK**) to dial the number.

## Calls Log (Caller ID - Call Waiting)

---

### Deleting Caller ID

- Follow the steps in **Reviewing Caller ID** to scroll to the record to be deleted.
- Press the **DELETE** key. A confirmation tone will sound and the previous CID record will be displayed on the screen.
- To delete all the CID records, press and hold the **DELETE** key. The screen will ask **DELETE ALL CALLS?** Press **SEL** to confirm. Or, press **OFF** to return to the CID record previously displayed.

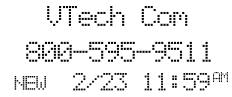

VTech Com  
800-595-9511  
NEW 2/23 11:59AM



DELETE ALL  
CALLS?

# Handset Settings

## Ringer Volume

- From idle (off) mode, press **MENU** then ▲ or ▼ key to **RINGER VOLUME**.
- Press **SEL**. The current ringer volume will be shown:
- Press the ▲ and ▼ keys or enter a digit (0 through 6) to the desired volume. The current ring tone is played. At the lowest setting, display will show:
- The handset will not ring when a call comes in if ringer volume is set to the lowest setting.
- Press **SEL** to confirm.

>RINGER VOLUME  
RINGER TONE

RINGER VOLUME  
■■■■■

RINGER VOLUME



## Ringer Tone

- From the idle (off) mode, press **MENU** then ▲ or ▼ key to **RINGER TONE**.
- Press **SEL**. You will then be prompted to choose **INTERCOM CALL** or **OUTSIDE CALL**. Press the ▲ or ▼ keys to select the desired option.
- Press **SEL**. Press the ▲ and ▼ keys (or enter a digit 0 through 9) to sample the ring tones. The screen will show:
- Press **SEL** to confirm.

>RINGER TONE  
KEY TONE

>INTERCOM CALL  
OUTSIDE CALL

INTERCOM TONE  
1

## Key Tone (preset to ON)

- From idle (off) mode, press **MENU** then ▲ or ▼ key to select **KEY TONE**.
- Press **SEL**. The current setting will be shown. Use the ▲ and ▼ keys to scroll to **ON** or **OFF**. When set to on, the handset will emit a beep whenever a key is pressed.
- When the desired option is shown, press **SEL** to confirm.

>KEY TONE  
LANGUAGE

>KEY TONE  
LANGUAGE

## Handset Settings

### Language (preset to English)

- From the idle (off) mode, press **MENU** then ▲ or ▼ key to **LANGUAGE**.
- Press **SEL**. Press the ▲ or ▼ keys to scroll from English to French or Spanish.
- Press **SEL** to confirm.

```
>LANGUAGE
  CLEAR MSG WAIT
```

### Message Waiting

Your telephone can detect a visual message waiting signal (VMWI), generated by many telephone service providers. If you subscribe to voice mail service from your local telephone company (fee required), and a VMWI is provided, the handset will display **MESSAGE WAITING** and the base **MESSAGE WAITING** light will flash, alerting you to new messages.

```
LANGUAGE
  FRENCH
```

Once you have reviewed all new messages, the VMWI alert will automatically be turned off.

### Clear Message Waiting

If, after reviewing all new voice mail messages, the VMWI alert still remains on the screen and the **MESSAGE WAITING** LED on base is still flashing, you can turn it off manually:

- From the idle (off) mode, press **MENU** then ▲ or ▼ key to **CLEAR MSG WAIT**.
- Press **SEL**. The will be asked **TURN INDICATOR OFF?** Press **SEL** to confirm. To exit, press **OFF**.

```
>CLEAR MSG WAIT
  DIAL TYPE
```

```
TURN INDICATOR
  OFF?
```

### Dial Type (preset to Tone)

- From the idle (off) mode, press **MENU** then ▲ or ▼ key to **DIAL TYPE**.

```
>DIAL TYPE
  PHONE BOOK
```

# Handset Settings

---

- Press **SEL** then use ▲ or ▼ key to scroll from **TONE** to **PULSE**.
- Press **SEL** to confirm.



DIAL TYPE  
PULSE

**NOTE:** When the phone is set for pulse dial mode, it is possible to switch to temporary tone mode during an ongoing call by pressing \*. Once pressed, tone will be used for rest of the call. After you hang up, the phone will return to pulse dialing for the next call.

# Headset Operation

## Headset Operation

Your **mi 6821** handset is equipped with a 2.5mm headset jack for use with an optional accessory headset for handsfree conversations. If you choose to use the headset option, you must obtain an optional accessory headset that is compatible with the **mi 6821**.

**To purchase a headset, visit us on the web at [www.vtechcanada.com](http://www.vtechcanada.com) or call VTech Customer Service at 1-800-267-7377.**

Once you have a compatible 2.5mm headset, locate the headset jack on the **mi 6821** handset. Connect the plug on the headset cord to the jack (under a small rubber flap) on the cordless handset. The plug should fit securely. Do not force the connection.

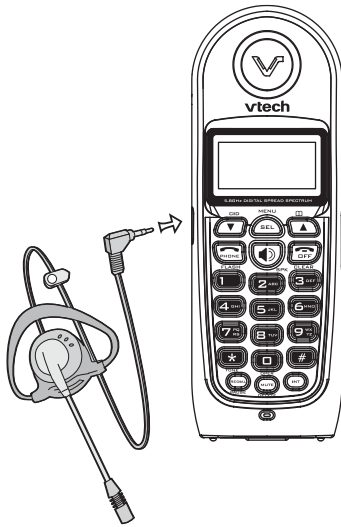

### NOTE:

- Whenever a compatible headset is connected to the cordless handset, the microphone on the handset will be muted. This is done to limit the effect of background noise.
- When a compatible headset is connected to the cordless handset, your speaker phone feature will be disabled. To use your speakerphone feature, simply disconnect the headset from the handset.

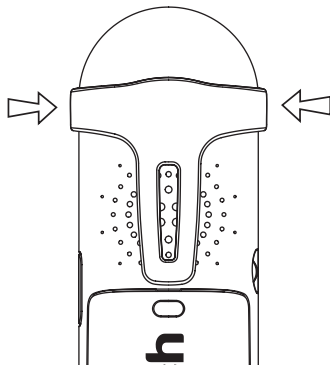

### Belt Clip

The **mi 6821** is also equipped with a detachable belt clip. Align the pins on the inside edge of the clip with the notches on the sides of the handset. The belt clip should snap securely into place. Do not force the connection.



# Maintenance

---

## Taking care of your telephone

Your cordless telephone contains sophisticated electronic parts, so it must be treated with care.

## Avoid rough treatment

Place the handset down gently. Save the original packing materials to protect your telephone if you ever need to ship it.

## Avoid water

Your telephone can be damaged if it gets wet. Do not use the handset outdoors in the rain, or handle it with wet hands. Do not install your base unit near a sink, bathtub or shower.

## Electrical storms

Electrical storms can sometimes cause power surges harmful to electronic equipment. For your own safety, use caution when using electric appliances during storms.

## Cleaning your telephone

Your telephone has a durable plastic casing that should retain its luster for many years. Clean it only with a soft cloth slightly dampened with water or a mild soap. Do not use excess water or cleaning solvents of any kind.

Remember that electrical appliances can cause serious injury if used when you are wet or standing in water. If your base unit should fall into water, **DO NOT RETRIEVE IT UNTIL YOU UNPLUG THE POWER CORD AND TELEPHONE LINE CORDS FROM THE WALL.** Then pull the unit out by the unplugged cords.

## In Case Of Difficulty

---

If you have difficulties in operating your phone, the suggestions below should solve the problem. If you still have difficulties after trying these suggestions, call VTech Communications at 1-800-595-9511. In Canada, call VTech Telecommunications Canada Ltd. at 1-800-267-7377.

### **The Phone Doesn't Work At All**

- Make sure the power cord is plugged in.
- Make sure the telephone line cord is plugged firmly into the base unit and the telephone wall jack.
- Make sure the battery is properly charged. If you get a **LOW BATTERY** message or indication, the battery needs to be charged.

### **No Dial Tone**

- First check all the suggestions above.
- If you still don't hear a dial tone, disconnect the base unit from the telephone jack and connect a different phone. If there is no dial tone on that phone either, the problem is in your wiring or local service. Contact your local telephone company.

### **You Get Noise, Static, Or A Weak Signal Even When You're Near The base unit**

- Household appliances plugged into the same circuit as the base unit can sometimes cause interference. Try to move the appliance or the base unit to another outlet.

### **You Get Noise, Static, Or A Weak Signal When You're Away From The base unit**

- You may be out of range. Either move closer to the base, or relocate the base unit.
- The layout of your home may be limiting the range. Try to move the base unit to another position.

### **The Handset Does Not Ring When You Receive A Call**

- Make sure you have the ringers activated.
- Make sure the telephone line cord is plugged firmly into the base unit and the telephone jack. Make sure the power cord is plugged in.
- You may be too far from the base unit.
- You may have too many extension phones on your telephone line to allow all of them to ring. Try to unplug some of the other phones.

### **You Hear Other Calls While Using Your Phone**

- Disconnect your base unit from the telephone jack, and plug in a corded telephone. If you still hear other calls, the problem is probably in your wiring or local service. Call your local telephone company.

### **You Hear Noise In The Handset, And None Of The Keys Or Buttons Work**

- Make sure the power cord is plugged in.

# In Case Of Difficulty

---

## Common Cure For Electronic Equipment

If the unit does not seem to be responding normally, then try to put the handset in its base. If it does not seem to respond, do the following (in the order listed):

1. Disconnect the power to the base.
2. Disconnect the handset battery.
3. Wait a few minutes.
4. Connect power to the base.
5. Reinstall the battery.
6. Watch for handset to display **HANDSET**.



# Warranty Statement

---

## What does this limited warranty cover?

- The manufacturer of this VTech product, VTech Communications, warrants to the holder of a valid proof of purchase (“Consumer” or “you”) that the product and all accessories provided by VTech in the sales package (“Product”) are free from material defects in material and workmanship, pursuant to the following terms and conditions, when installed and used normally and in accordance with operation instructions. This limited warranty extends only to the Consumer for Products purchased and used in the United States of America.

## What will VTech Communications do if the Product is not free from material defects in materials and workmanship during the limited warranty period (“Materially Defective Product”)?

- During the limited warranty period, VTech’s authorized service representative will repair or replace at VTech’s option, without charge, a Materially Defective Product. If we repair this product, we may use new or refurbished replacement parts. If we choose to replace this product, we may replace it with a new or refurbished product of the same or similar design. VTech will return repaired or replacement products to you in working condition. VTech will retain defective parts, modules, or equipment. Repair or replacement of Product, at VTech’s option, is your exclusive remedy. You should expect the repair or replacement to take approximately 30 days.

## How long is the limited warranty period?

- The limited warranty period for the product extends for ONE(1) YEAR from the date of purchase if we repair or replace a Materially Defective Product under the terms of this limited warranty. This limited warranty also applies to repaired or replacement Products for a period of either (a) 90 days from the date the repaired or replacement Product is shipped to you or (b) the time remaining on the original one-year warranty; whichever is longer.

## What is not covered by this limited warranty?

This limited warranty does not cover:

1. Product that has been subjected to misuse, accident, shipping or other physical damage, improper installation, abnormal operation or handling, negligent, inundation, fire, water or other liquid intrusion; or
2. Product that has been damaged due to repair, alteration or modification by anyone other than an authorized service representative of VTech; or
3. Product to the extent that the problem experienced is caused by signal conditions, network reliability or cable or antenna systems; or
4. Product to the extent that the problem is caused by use with non-VTech electrical accessories; or
5. Product whose warranty/quality stickers, Product serial numbers plates or electronic serial numbers have been removed, altered or rendered illegible; or
6. Product purchased, used, serviced, or shipped for repair from outside the United States, or used for commercial or institutional purposes (including but not limited to Products used for rental purposes); or
7. Product returned without valid proof of purchase (see 2 below); or
8. Charges for installation or set up, adjustment of customer controls, and installation or repair of systems outside the unit.

# Warranty Statement

---

## How do you get warranty service?

- To obtain warranty service in the United States of America, call 1-800-595-9511, in Canada, call 1-800-267-7377 for instructions regarding where to return the Product. Before calling for service, please check the user's manual. A check of the Product controls and features may save you a service call.
- Except as provided by applicable law, you assume the risk of loss or damage during transit and transportation and are responsible for delivery or handling charges incurred in the transport of Product(s) to the service location. VTech will return repaired or replaced product under this limited warranty to you, transportation, delivery or handling charges prepaid. VTech assumes no risk for damage or loss of the Product in transit.
- If the Product failure is not covered by this limited warranty, or proof of purchase does not meet the terms of this limited warranty, VTech will notify you and will request that you authorize the cost of repair and return shipping costs for the repair of Products that are not covered by this limited warranty.

## What must you return with the Product to get warranty service?

1. Return the entire original package and contents including the Product to the VTech service location along with a description of the malfunction or difficulty;
2. Include "valid proof of purchase" (sales receipt) identifying the Product purchased (Product model) and the date of purchase or receipt; and
3. Provide your name, complete and correct mailing address, and telephone number.

## Other Limitations

- This warranty is the complete and exclusive agreement between you and VTech. It supersedes all other written or oral communications related to this Product. VTech provides no other warranties for this product. The warranty exclusively describes all of VTech's responsibilities regarding the product.

There are no other express warranties. No one is authorized to make modifications to this limited warranty and you should not rely on any such modification.

**State Law Rights:** This warranty gives you specific legal rights, and you may also have other rights, which vary from state to state.

**Limitations:** Implied warranties, including those of fitness for a particular purpose and merchantability (an unwritten warranty that the product is fit for ordinary use) are limited to one year from date of purchase. Some states do not allow limitations on how long an implied warranty lasts, so the above limitation may not apply to you.

- In **no** event shall VTech be liable for any indirect, special, incidental, consequential, or similar damages (including, but not limited to lost profits or revenue, inability to use the product, or other associated equipment, the cost of substitute equipment, and claims by third parties) resulting from the use of this product, some states do not allow the exclusion or limitation of incidental or consequential damages, so the above limitation or exclusion may not apply to you.

# FCC, ACTA, and IC Regulations

This equipment complies with Parts 15 of the Federal Communications Commission (FCC) rules for the United States. It also complies with regulations RSS210 and CS-03 of Industry and Science Canada. Operation is subject to the following two conditions: (1) this device may not cause interference, and (2) this device must accept any interference, including interference that may cause undesired operation of the device.

A label is located on the underside of the base unit containing either the FCC registration number and Ringer Equivalence Number (REN) or the IC registration number and Load Number. You must, upon request, provide this information to your local telephone company.

This equipment is compatible with inductively coupled hearing aids. Should you experience trouble with this telephone equipment, please contact VTech Communications Inc CUSTOMER SERVICE at 1-800-595-9511. In Canada, call VTech Telecommunications Canada Ltd. at 1-800-267-7377 for repair/warranty information. The telephone company may ask you to disconnect this equipment from the line network until the problem has been corrected.

## **FCC Part 15**

Warning: Changes or modifications to this unit not expressly approved by the party responsible for compliance could void the user's authority to operate the equipment.

The equipment has been tested and found to comply with part 15 of the FCC rules. These limits are designed to provide reasonable protection against harmful interference in a residential installation. This equipment generates, uses and can radiate radio frequency energy and, if not installed and used in accordance with the instructions, may cause harmful interference to radio communications.

However, there is no guarantee that interference will not occur in a particular installation. If this equipment does cause harmful interference to radio or television reception, which can be determined by turning the equipment off and on, the user is encouraged to try and correct the interference by one or more of the following measures:

- Reorient or relocate the receiving antenna.
- Increase the separation between the equipment and receiver.
- Connect the equipment into an outlet or on a circuit different from that to which the receiver is connected.
- Consult the dealer or an experienced radio/TV technician for help.

To ensure safety of users, the FCC has established criteria for the amount of radio frequency energy that can be safely absorbed by a user or bystander according to the intended usage of the product. This product has been tested and found to comply with the FCC criteria. The handset has such a low power that it does not require testing. It may be safely held against the ear of the user. The base unit shall be installed & used such that parts of the user's body other than the hands should be maintained at a comfortable distance of approximately 20 cm or more.

## **FCC Part 68 and ACTA**

If this equipment was approved for connection to the telephone network prior to July 23, 2001, it complies with Part 68 of the Federal Communications Commission (FCC) rules. If the equipment was approved after that date, it complies with the Part 68 rules and with Technical Requirements for Connection of Equipment to the Telephone Network adopted

# FCC, ACTA, and IC Regulations

---

by the Administrative Council for Terminal Attachments (ACTA). We are required to provide you with the following information.

## 1. Product identifier and REN information

The label on the back or bottom of this equipment contains, among other things, an identifier indicating product approval and the Ringer Equivalence Number (REN). This information must be provided to your local telephone company upon request. For equipment approved prior to July 23, 2001, the product identifier is preceded by the phrase "FCC Reg No." and the REN is listed separately. For equipment approved after that date, the product identifier is preceded by "US" and a colon (:), and the REN is encoded in the product identifier without a decimal point as the sixth and seventh characters following the colon. For example, the product identifier US:AAEQ03T123XYZ would indicate an REN of 0.3. The REN is used to determine how many devices you may connect to your telephone line and still have them ring when you are called. In most, but not all areas, the sum of all RENs should be five (5.0) or less. For more information, please contact your local telephone company.

## 2. Connection and use with the nationwide telephone network

The plug and jack used to connect this equipment to the premises wiring and the telephone network must comply with the applicable Part 68 rules and technical requirements adopted by ACTA. A compliant telephone cord and modular plug is provided with this product. It is designed to be connected to a compatible modular jack that is also compliant. An RJ11 jack should normally be used for connecting to a single line and an RJ14 jack for two lines. See Installation Instructions in the user's manual. This equipment may not be used with Coin Telephone Lines or with Party Lines. If you have specially wired alarm dialing equipment connected to your telephone line, ensure the connection of this equipment does not disable your alarm equipment. If you have questions about what will disable alarm equipment, consult your telephone company or a qualified installer.

## 3. Repair instructions

If this equipment is malfunctioning, it must be unplugged from the modular jack until the problem has been corrected. Repairs to this telephone equipment can only be made by the manufacturer or its authorized agents. For repair procedures, follow the instructions outlined under the Limited Warranty.

## 4. Rights of the telephone company

If this equipment is causing harm to the telephone network, the telephone company may temporarily discontinue your telephone service. The telephone company is required to notify you before interrupting service. If advance notice is not practical, you will be notified as soon as possible. You will be given the opportunity to correct the problem and the telephone company is required to inform you of your right to file a complaint with the FCC. Your telephone company may make changes in its facilities, equipment, operation, or procedures that could affect the proper functioning of this product. The telephone company is required to notify you if such changes are planned.

## 5. Hearing aid compatibility

If this product is equipped with a corded or cordless handset, it is hearing aid compatible.

# FCC, ACTA, and IC Regulations

---

## 6. Programming/testing of emergency numbers

If this product has memory dialing locations, you may choose to store police, fire department and emergency medical service telephone numbers in these locations. If you do, please keep three things in mind:

- a. We recommend that you also write the telephone number on the directory card, so that you can still dial the emergency number manually if the memory dialing feature doesn't work.
- b. This feature is provided only as a convenience, and the manufacturer assumes no responsibility for customer reliance upon the memory feature.
- c. Testing the emergency telephone numbers you have stored is not recommended. However, if you do make a call to an emergency number:
  - You must remain on the line and briefly explain the reason for the call before hanging up.
  - Programming/testing of emergency numbers should be performed during off-peak hours, such as in the early morning or late evening, when the emergency services tend to be less busy.

### IC (Industry Canada)

This telephone is registered for use in Canada.

The term "IC:" before the radio certification number only signifies that Industry Canada technical specifications were met.

#### Notice:

This equipment meets the applicable Industry Canada Terminal Equipment Technical Specifications. This is confirmed by the registration number. The abbreviation, IC, before the registration number signifies that registration was performed based on a Declaration of Conformity indicating that Industry Canada technical specifications were met. It does not imply that Industry Canada approved the equipment.

#### Notice:

The Ringer Equivalence Number (REN) for this terminal equipment is 0.1. The REN assigned to each terminal equipment provides an indication of the maximum number of terminals allowed to be connected to a telephone interface. The termination on an interface may consist of any combination of devices subject only to the requirement that the sum of the Ringer Equivalence Numbers of all the devices does not exceed five.

Before installing this equipment, users should ensure that it is permissible to be connected to the facilities of the local telecommunications company. The equipment must also be installed using an acceptable method of connection. The customer should be aware that compliance with the above conditions may not prevent degradation of services in some situations.

Repairs to certified equipment should be made by an authorized Canadian maintenance facility designated by the supplier. Any repairs or alterations made by the user to this equipment, or equipment malfunctions, may give the telecommunications company cause to request the user to disconnect the equipment.

Users should ensure for their own protection that the electrical ground connections of the power utility, telephone lines and internal metallic water pipe system, if present,



## FCC, ACTA, and IC Regulations

---

are connected together. This precaution may be particularly important in rural areas.

**Caution:**

Users should not attempt to make such connections themselves, but should contact the appropriate electrical inspection authority, or electrician, as appropriate.

Your cordless phone is designed to operate at the maximum power allowed by the FCC and IC. This means your handset and base unit can communicate only over a certain distance - which will depend on the location of the base unit and handset, weather, and the construction and layout of your home or office.

# Technical Specifications

---

## FREQUENCY CONTROL

Crystal controlled  
PLL synthesizer

## TRANSMIT FREQUENCY

Base: 5725 - 5850 MHz  
Handset: 2400 - 2483.5 MHz

## RECEIVE FREQUENCY

Base: 2400 - 2483.5 MHz  
Handset: 5725 - 5850 MHz

## CHANNELS

95 Channels

## NOMINAL EFFECTIVE RANGE

Maximum power allowed by FCC and IC. Actual operating range may vary according to environmental conditions at the time of use.

## SIZE

Handset: 136mm x 47mm x 29.5mm  
(including antenna)  
Base: 110mm x 108.40mm x 55.6mm

## WEIGHT

Handset: 136 grams  
(excluding batteries)  
Base: 138 grams

## POWER REQUIREMENTS

Handset: 3.6V 600mAh NiMH  
Base: 8 V DC @ 650mA

## MEMORY

Phonebook: 50 Memory locations; up to 32 digits for number, 16 characters for name, per location.  
CID: 50 memory locations

**SPECIFICATIONS ARE TYPICAL  
AND MAY CHANGE WITHOUT  
NOTICE.**

# Table Of Contents

---

<b>IMPORTANT SAFETY INSTRUCTIONS</b> .....	<b>1</b>
Introduction.....	2
Parts Check List.....	3
The Handset Layout.....	4
The Base Unit Layout.....	5
<b>GETTING STARTED</b> .....	<b>6</b>
<b>SETUP</b> .....	<b>6</b>
Connecting power to Base Unit.....	6
Installation of Battery.....	6
Charging of the Handset Battery.....	7
Connecting to Phone Line.....	7
Checking for Dial Tone.....	7
Wall Mounting.....	9
<b>BASIC OPERATION</b> .....	<b>10</b>
Handset and Base Indicators.....	10
Handset Icons.....	10
Handset LED.....	10
Base LEDs.....	10
Handset Operation.....	11
Making Calls.....	11
Answering Calls.....	11
Speakerphone Operation.....	11
Flash Function.....	11
Redial Function.....	11
Temporary ringer adjustments.....	12
Mute Function.....	12
Intercom Call.....	12
Call Forward.....	13
Call Transfer.....	13
Conference Call.....	13
Base Operation.....	13
Phonebook Operation.....	14
Storing a New Entry.....	14
Reviewing/Dialing from the Phonebook.....	15
Editing a Phonebook entry.....	15
Delete a Phonebook entry.....	16
Editing a Phonebook Entry.....	16
Calls Log (Caller ID - Call Waiting).....	17
Caller ID - Call Waiting ID.....	17
Reviewing Caller ID.....	17
Storing a Caller ID.....	18
Dialing from Caller ID.....	18
Deleting Caller ID.....	19
Handset Settings.....	20

# Table Of Contents

---

Ringer Volume.....	20
Ringer Tone.....	20
Key Tone (preset to ON).....	20
Language (preset to English).....	21
Message Waiting.....	21
Clear Message waiting.....	21
Dial Type (preset to Tone).....	21
<b>ADVANCED OPERATION.....</b>	<b>23</b>
HEADSET OPERATION.....	23
<b>ADDITIONAL INFORMATION.....</b>	<b>24</b>
Maintenance.....	24
In Case Of Difficulty.....	25
Warranty Statement.....	27
FCC, ACTA, and IC Regulations.....	29

**vtech**

VTECH TELECOMMUNICATIONS LTD.

**vtech** A member of THE VTECH GROUP OF COMPANIES.

Distributed in the U.S.A. by VTech Communications, Inc. Beaverton,  
Oregon, 97008

Distributed in Canada by VTech Telecommunications Canada Ltd.,  
Richmond, B.C., V6X 1Z9.

Printed in China

91-000159-030-000  
ISSUE 0

Congratulations on your purchase  
of this VTech product

## NEED HELP?

Our representatives are here  
to help you with any questions  
concerning the operation of this  
product, available accessories,  
or any other related issues.

Call Toll Free:

**1-800-595-9511**

In Canada, Call:

**1-800-267-7377**

or visit our website at  
[www.vtechcanada.com](http://www.vtechcanada.com)

## Free Manuals Download Website

<http://myh66.com>

<http://usermanuals.us>

<http://www.somanuals.com>

<http://www.4manuals.cc>

<http://www.manual-lib.com>

<http://www.404manual.com>

<http://www.luxmanual.com>

<http://aubethermostatmanual.com>

Golf course search by state

<http://golfingnear.com>

Email search by domain

<http://emailbydomain.com>

Auto manuals search

<http://auto.somanuals.com>

TV manuals search

<http://tv.somanuals.com>