

Important Safety Instructions

When using your telephone equipment, basic safety precautions should always be followed to reduce the risk of fire, electric shock and injury to persons, including the following:

1. Read and understand all instructions.
2. Follow all warnings and instructions marked on the product.
3. Unplug this product from the wall outlet before cleaning. Do not use liquid cleaners or aerosol cleaners. Use a damp cloth for cleaning.
4. Do not use this product near water (for example, near a bath tub, kitchen sink, or swimming pool).
5. Do not place this product on an unstable cart, stand, or table. The product may fall, causing serious damage to the product.
6. Slots and openings in the cabinet and the back or bottom are provided for ventilation. To protect it from overheating, these openings must not be blocked by placing the product on the bed, sofa, rug, or other similar surface. This product should never be placed near or over a radiator or heat register. This product should not be placed in a built-in installation where proper ventilation is not provided.
7. This product should be operated only from the type of power source indicated on the marking label. If you are not sure of the type of power supply to your home, consult your dealer or local power company.
8. Do not allow anything to rest on the power cord. Do not locate this product where the cord will be abused by persons walking on it.
9. Never push objects of any kind into this product through cabinet slots as they may touch dangerous voltage points or short out parts that could result in a risk of fire or electric shock. Never spill liquid of any kind on the product.
10. To reduce the risk of electric shock, do not disassemble this product, but take it to an authorized service facility. Opening or removing cabinet parts other than specified access doors may expose you to dangerous voltages or other risks. Incorrect reassembling can cause electric shock when the appliance is subsequently used.
11. Do not overload wall outlets and extension cords as this can result in the risk of fire or electric shock.

Important Safety Instructions

12. Unplug this product from the wall outlet and refer servicing to an authorized service facility under the following conditions:
 - A. When the power supply cord or plug is damaged or frayed.
 - B. If liquid has been spilled into the product.
 - C. If the product has been exposed to rain or water.
 - D. If the product does not operate normally by following the operating instructions. Adjust only those controls that are covered by the operating instructions, because improper adjustment of other controls may result in damage and will often require extensive work by an authorized technician to restore the product to normal operation.
 - E. If the product has been dropped and the cabinet has been damaged.
 - F. If the product exhibits a distinct change in performance.
13. Avoid using a telephone (other than a cordless type) during an electrical storm. There may be a remote risk of electric shock from lightning.
14. Do not use the telephone to report a gas leak in the vicinity of the leak.

SAVE THESE INSTRUCTIONS

Introduction

The QW2432 is an advanced cordless telephone that operates in the 2.4GHz frequency range. Your QW2432 is capable of supporting up to a maximum of 4 Handsets. Using additional Handsets, up to three people can be conferenced on a call (2 Handsets and the Base Speakerphone), or two extensions can be conferenced on a call, while two other extensions can be talking internally, using the Intercom feature.

This manual is designed to familiarize you with the QW2432 cordless telephone.

To order additional Handsets (model QW2422) or headsets, call Qwest at 800-244-1111.

IMPORTANT

Please record the Base ID#(BS ID) printed on the underside of the 2432 Base in the space below. Please be certain to include all 15 digits/characters.

Base ID# _____

Parts Check List

1. Base Unit
2. Handset
3. AC Power Adapter
4. Telephone Cord
5. Battery Pack
6. Wall Mounting Bracket
7. Belt Clip
8. Owner's Manual



Handset

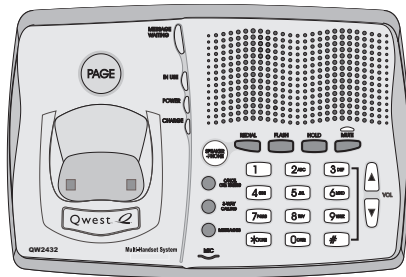

Base Unit

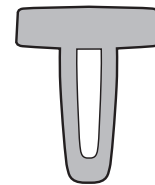

Belt Clip

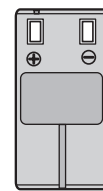

Battery Pack

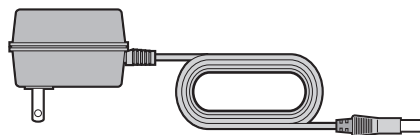

AC Power Adapter

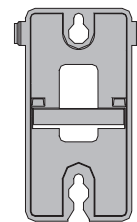

Wall Mounting Bracket

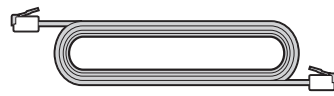

Telephone Line Cord

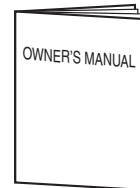

Owner's Manual

The Handset Layout

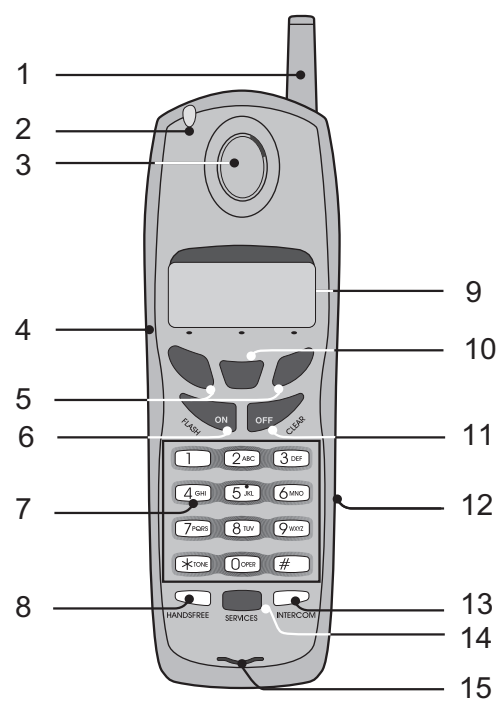

- | | |
|------------------------------|-------------------------|
| 1. Antenna | 9. LCD Display |
| 2. Message Waiting Indicator | 10. Select |
| 3. Earpiece | 11. Off (Clear) |
| 4. Headset Jack (2.5mm) | 12. Battery Compartment |
| 5. Scroll Keys | 13. Intercom |
| 6. On (Flash) | 14. Services Key |
| 7. Dialing Key (0-9) | 15. Microphone |
| 8. Handsfree Speakerphone | |

The Base Unit Layout

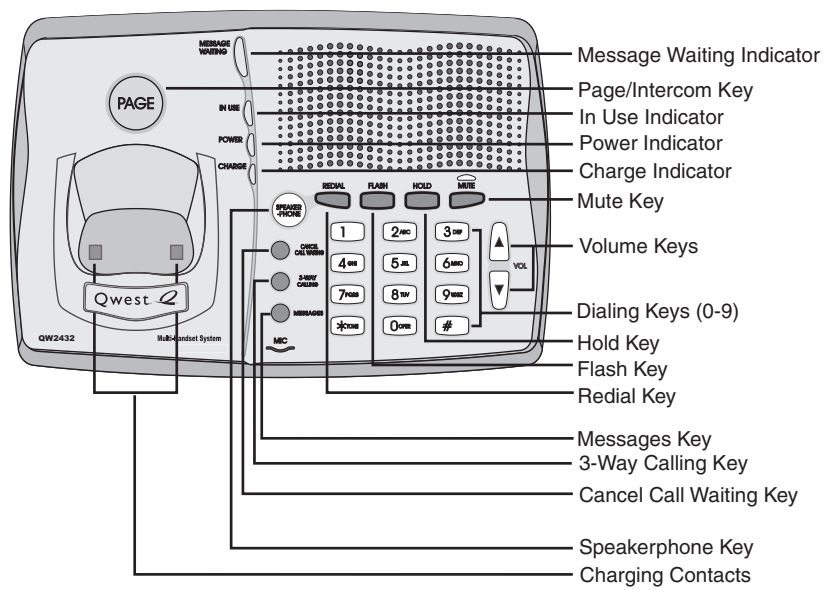
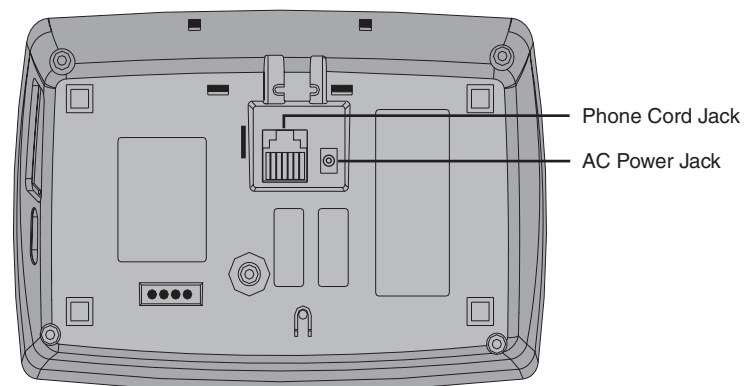

Setup

Plug the AC power adapter into an electrical outlet, and the DC connector into the back of the base unit.

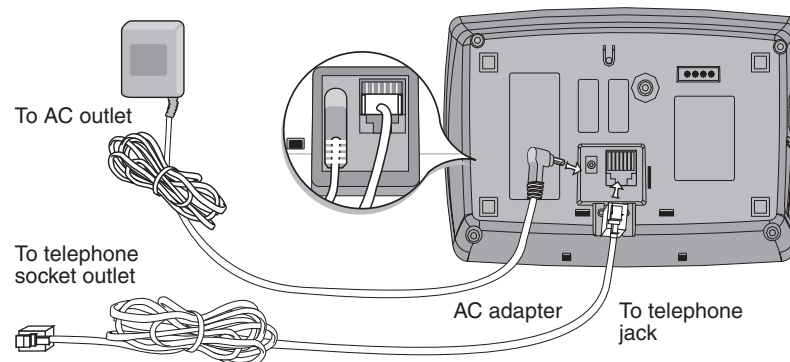

Connecting to phone line

Plug one end of the telephone line cord into the jack on the back of the base unit. Plug the other end of this cord into the wall jack.

Checking for dial tone

After the battery is charged press **ON** on the Handset. The Phone icon  will appear on the handset display, and you will hear dial tone. If not, see In Case of Difficulty.

Tone/Pulse selection

See BASE SETTINGS for details.



CAUTION: Use only the Qwest power supply provided with your Qwest Unit.

IMPORTANT:
For best performance the QW2432
Should be installed as follows:

In an elevated location, in the center of the room, with no obstructions nearby.

In a location that is away from other electrical appliances such as microwave ovens, personal computers, or televisions.

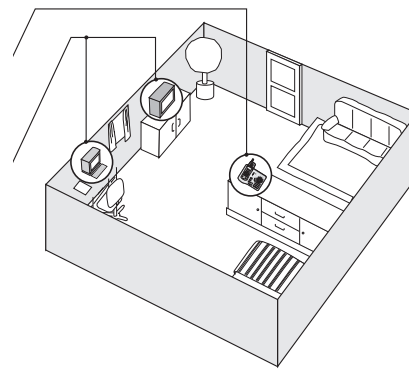

Installation of Battery Pack in Handset

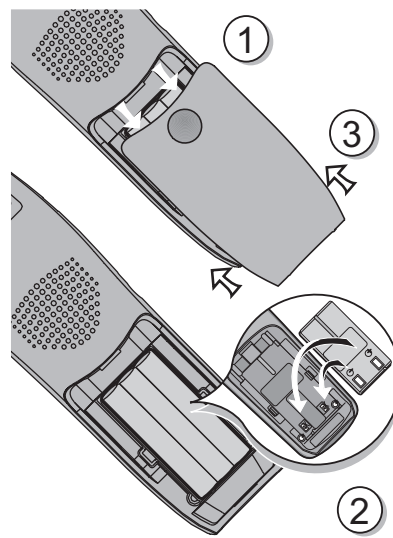

Follow the steps below:

1. Remove the battery cover by pressing on the indent and sliding downward.
2. Place the new battery pack in the handset with the metal contacts aligned with the charge contacts in the battery compartment.
3. Replace the battery cover by sliding it upwards.
4. If the new battery pack is not already charged, place the handset in the base unit, or a remote charging stand, and allow it to charge for 12 hours. After initial charge, a maintenance charge of 8 hours should be sufficient.

The original Handset that is shipped with your QW2432 system will be automatically registered to the Base. This Handset is **HANDSET 1**.

As you register additional Handsets to the system, they will be assigned extension numbers in the following order: **HANDSET 2**, **HANDSET 3**, and finally **HANDSET 4**.

Whenever a Handset battery pack is installed, the Handset will automatically begin **SEARCHING FOR BASE** (if previously registered), or it will prompt you to **ENTER BASE ID** to register the new Handset.

Spare Battery Charger/Power Backup Function

The QW2432 can use a the spare battery in the Base Unit to provide operational backup in the event of a power failure. With a fully charged battery pack in the spare battery charger, you will still be able to place and receive calls from the Handset for up to 5 hours.

The spare battery pack can also be used to replace a drained handset battery, ensuring uninterrupted use.

A spare battery can be purchased from most retail stores that carry electronic equipment.

NOTE :

When using the QW2432 during Power Backup mode, audio quality may be compromised due to reduced Power availability.

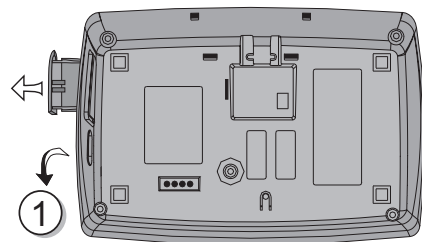

1. Open the spare battery charger by pressing the release button, located on the right-hand side of the Base Unit. A drawer will open to reveal the spare battery compartment.
2. Place a battery pack in the drawer with the charge contacts facing up and to the left.
3. Push the drawer closed.

The spare battery takes 24 hours to fully charge a drained battery.

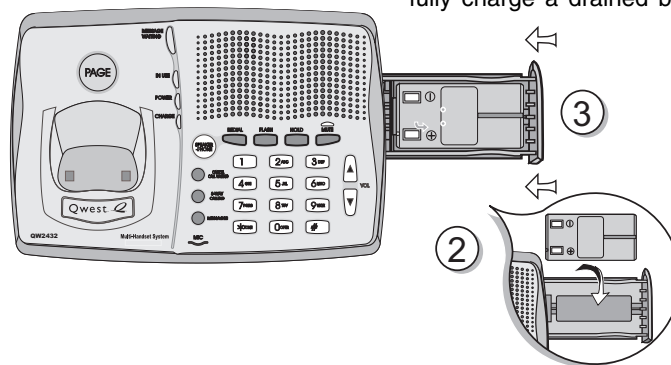

Charging Of Handset Battery Pack

The Handset of your QW2432 cordless telephone is powered by a rechargeable battery pack. It charges automatically whenever the Handset is in the Base Unit.

You should charge the battery pack for 12 hours when you first receive your phone. You'll know the battery pack needs charging when:

- The low battery message is displayed :
- The handset seems completely dead, the LCD is completely clear and does not activate when you press the keys.



CAUTION: TO REDUCE THE RISK OF FIRE OR INJURY TO PERSONS BY BATTERY, READ AND FOLLOW THESE INSTRUCTIONS.

1. Use only the appropriate type and size battery pack specified in the instruction manual provided for this product.
2. Do not dispose of the battery pack in a fire. The cell may explode. Check with State and local codes for possible special disposal instructions.
3. Do not open or mutilate the battery pack. Released electrolyte is corrosive and may cause damage to the eyes or skin. It may be toxic if swallowed.
4. Exercise care in handling battery in order not to short the battery with conducting materials such as rings, bracelets, and keys. The battery or conductor may overheat and cause burns.
5. Charge the battery pack provided with or identified for use with this product only in accordance with the instructions and limitations specified in the instruction manual.
6. Observe proper polarity orientation between the battery pack and battery charger.

Wall Mounting

The Wall Mount bracket is designed for use on standard Wall Mount plates only.

1. Line up the tabs on the wall mount adapter with the holes on the back of the base unit. Snap the wall mount bracket firmly in place.
2. Plug the AC adapter into an electrical outlet, and the DC connector to the back of the base unit. If the handset battery pack has not been charged previously, place the handset in the base unit cradle, and allow it to charge for 12 hours.
3. Connect the telephone line cord to the jack on the back of the base unit, and the other end to the wall jack.
4. Mount the base unit on the wall. Position the base unit so the mounting studs will fit into the holes on the wall mount bracket. Slide base unit down on the mounting studs until it locks into place.

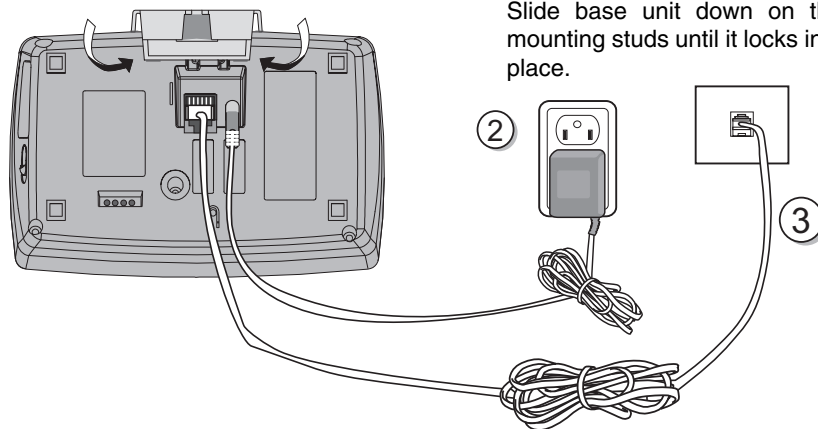
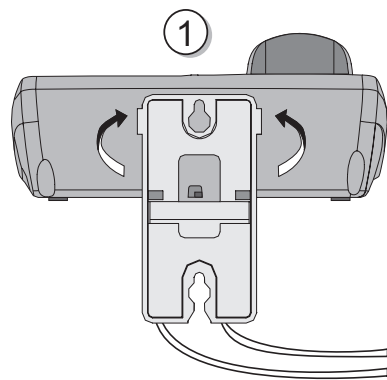

Registration and Operation

Registration and Operation of the QW2422 Accessory Handset

Your QW2432 system can operate up to 4 Handsets.

The accessory Handset consists of the following:

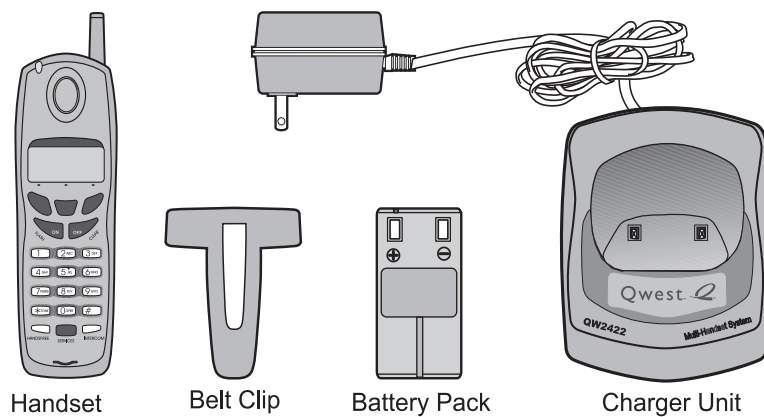

Handset

Belt Clip

Battery Pack

Charger Unit

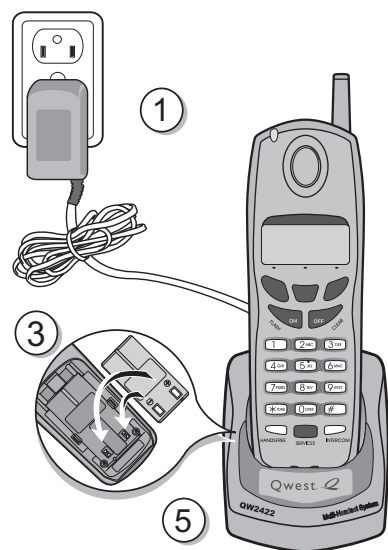

Setup of the QW2422 Accessory Handset

1. Plug the AC power adapter into an electrical outlet.
2. Remove the Handset battery cover by pressing on the indent and sliding downward.
3. Place the new battery pack in the Handset, with the metal contacts aligned with the charge contacts in the battery compartment.
4. Replace the battery cover by sliding it upward.
5. Place the Handset in the Charge Cradle, and allow it to charge for 12 hours. After the initial charge, a maintenance charge of 8 hours should be sufficient.

Registration and Operation

Enter Base ID Code

1. After charging the Handset, remove it from its Charge Cradle, the screen will display:



2. Press **NEW**, then enter the 15 digit Base Unit ID code, located on the underside of the Base Unit.

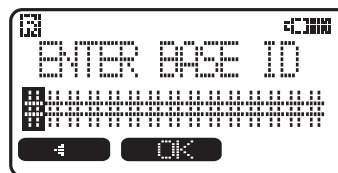

3. Press **OK**. The Handset will display: **PLEASE WAIT!!**

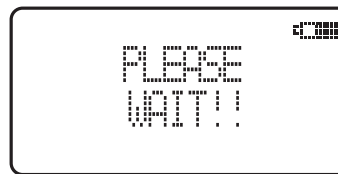

4. Wait approximately 15 seconds. The Handset will display: **FOUND BASE V14**







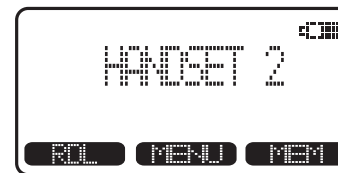

If the Handset displays: **BASE BUSY TRY LATER**, this indicates that the system is in use. Wait until the Base Unit is in the idle (on hook) mode, and repeat step 2 to 4.

Congratulations! You can now enjoy the benefits of your multi-Handset system.



Handset and Base Indicators

Handset Icons

Icon	Description
	<u>Line In Use indicator</u> On steady with no number next to it when a parallel set is in use. On steady with one or more numbers next to it, indicating which extensions are using the line. For example,  12 indicates that Handset 1 and Handset 2 are on an outside call.
	<u>Intercom indicator</u> On steady with the extension numbers currently on an intercom call. For example,  02 indicates that the Base and Handset 2 are on an intercom call.
	<u>Battery indicator</u> Cycles (Low, Medium, and High) when Handset battery is charging. Flashes when a low battery condition is detected.
M	<u>Mute indicator</u> On steady when the Handset microphone is muted.
H	<u>Hold indicator</u> On steady when the line is on hold.
	<u>Handset Registration indicator</u>  is displayed when a Handset is either not registered, or is searching for a Base unit.

Handset and Base Indicators

Handset LEDs

LED	Description
Message Waiting	<ul style="list-style-type: none">Flashes to indicate that you have new messages in your voicemail. Service must be subscribed to through your local telephone company.

Base LEDs

LED	Description
Message Waiting	<ul style="list-style-type: none">Flashes to indicate that you have new messages in your voicemail. Service must be subscribed to through your local telephone company
Power	<ul style="list-style-type: none">Lights when base unit is receiving power from wall outletFlashes when unit is in Power Backup mode.
Line In Use	<ul style="list-style-type: none">Lights when line is being used by a handset of the QW2432 system.Flashes when another telephone on the same line (parallel extension) is in use.Flashes following ringing cadence during ringing.
Charging	<ul style="list-style-type: none">Lights whenever the handset is placed in the base unit charging cradle.
Mute	<ul style="list-style-type: none">Lights when base microphone is muted.
Speakerphone	<ul style="list-style-type: none">Flashes when HOLD function is activated.Lights when base speakerphone is in use.

Soft Menu Functions



The QW2432 has an advanced design that uses a menu structure and soft keys to access all of the built-in features.



Example of the idle mode display:

RDL (Redial)



Press **RDL** to display the last 5 telephone numbers dialed. The number on top line is the most recent number dialed.

- Use the  /  scroll keys to select the desired number.
- To dial the number, you can simply press the **ON** or **HANDSFREE** key.



MENU



With the Handset in the idle (OFF) mode, press the **MENU** key to access the following options:

- **CALLS LOG (CALLER ID)**
- **HANDSET SETTINGS**
- **RANGER EXTENDER**
- **REGISTER**

Use the  /  scroll keys to select the desired option, then press **OK**.

Calls Log (Caller ID)

From the idle (OFF) mode, press **MENU**, use the  /  scroll keys to select **CALLS LOG**, then press **OK**. The Caller ID information of the most recently received call will be displayed.

To scroll to other records, use the  /  scroll keys.

To dial the number displayed, you can simply press the **ON** or **HANDSFREE** key.

You can also press the **CID** key to access the following options (**DEL**, **OPT#**, **SAVE**):

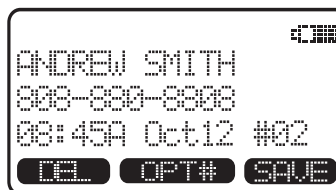

DEL : Select this option to delete THIS or ALL records in Caller ID memory.

OPT# : Select this option to display up to four possible dialing strings of the number stored in Caller ID memory. If a number is provided in the Caller ID data, the possible options to choose from will be either 7, 8, 10, or 11 digits. For example, if the original number in Caller ID memory was 808-880-8808, then the display options will be:

Use the UP and DOWN keys to make selection, and then press **DIAL**, **ON** or **HANDSFREE** to dial the number.

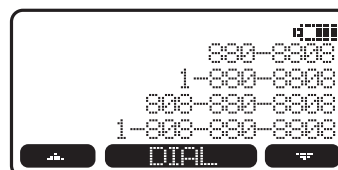

SAVE Select this option to save the displayed Caller ID record into Speed Dial Memory. Only Caller ID records with telephone numbers can be saved into Speed Dial Memory. If you need to modify the number after saving, see TO EDIT A NUMBER.

Caller ID - Call Waiting ID

Your QW2432 is capable of displaying the name and/or number of the party calling before you answer the phone (**Caller ID**). It is also capable of displaying Caller ID information in conjunction with a Call Waiting alert signal (**Call Waiting Caller ID**). With Call Waiting Caller ID, the Caller ID data is displayed so you can decide whether to answer the incoming call, or continue with your current conversation.

NOTES ABOUT CALLER ID & CALL WAITING CALLER ID



These are subscription services, provided by most regional telephone service providers. You must subscribe to these services to get the benefits of these features. If you do not subscribe to Caller ID services, you can still use your QW2432 and the other features it offers.



Due to regional incompatibilities, Caller ID information may not be available for every call you receive. In addition, the calling party may intentionally block their name and phone number from being sent.

Handset Settings

From the Handset Settings menu you can select the following options to modify:

- **RINGER VOLUME**



Select this option to adjust the ringer volume. Use the  /  scroll keys to adjust the volume up or down. A Handset will display a graphic indicator of the selected volume setting. Press **OK** to confirm your selection and return to the Handset Settings menu.
- **RINGER MELODY**



Select this option to adjust the ringer melody or tone. Use the  /  scroll keys to select from the six available tones. Press **OK** to confirm your selection and return to the Handset Settings menu.
- **LOW BATT TONE**

Select this option to turn the Low Battery warning tone **ON** or **OFF**. Press the OFF or ON soft keys, to make your selection. Press **OK** to confirm your selection and return to the Handset Settings menu. When set to **ON**, the Handset will emit a warning tone when a Low Battery condition is detected.
- **RANGE TONE**

Select this option to turn the Out of Range warning tone **ON** or **OFF**. Press the OFF or ON soft keys, to make your selection. Press **OK** to confirm your selection and return to the Handset Settings menu. When set to **ON**, the Handset will emit a warning tone whenever the Handset is taken out of range of the Base.
- **KEYPAD TONE**

Select this option to turn the Keypad tones **ON** or **OFF**. Press the OFF or ON soft keys, to make your selection. Press **OK** to confirm your selection and return to the Handset Settings menu. When set to **ON**, the Handset will emit a beep whenever a key is pressed.
- **CONTRAST**

Select this option to adjust the contrast level of the Handset display. Use the  /  scroll keys to make your selection. The handset display will automatically adjust as you make your selection. Press **OK** to confirm your selection and return to the Handset Settings menu.
- **LANGUAGE**

Select this option to change the display from English to Spanish. Use the  /  scroll keys to select language, then press **OK** to confirm your choice.

Range Extender

Your **QW2432** has an enhanced feature that is designed to improve performance. If you are using your **QW2432** in an area with excessive interference, or you require a moderate increase in operating range, the Range Extender feature can help to improve both the sound quality and range. Actual range will depend on your environment.

To select the Range Extender setting, follow the procedure listed below:

- In the idle(OFF) mode, press **MENU** and use the scroll keys to select **RANGE EXTENDER**, then press **OK**.
- There are 3 option settings in the **RANGE EXTENDER** menu:
 1. Select **OFF** to disable **RANGE EXTENDER**
 2. Select **ON** to enable **RANGE EXTENDER**. An "E" icon will appear in the upper left corner of Handset display, indicating that **RANGE EXTENDER** is **ON**.
 3. Select **AUTO** to allow your **QW2432** to automatically monitor the signal strength between the handset and base unit, and activate whenever necessary. With this option selected, your **QW2432** may occasionally enable or disable the **RANGE EXTENDER** feature. When **RANGE EXTENDER** is enabled, an "E" icon will appear in the upper left corner of the Handset display.
- Use the scroll keys to select the desired setting, and then press **OK** to confirm the selection.



Note: When Range Extender mode is enabled, your **QW2432** will consume more battery power. That means the standby and talk time of your Handset will be shorter.

Register

Use this option to register a Handset to the **QW2432** Base. You can register a total of four Handsets to the **QW2432** Base. This process is activated automatically whenever a new handset is powered up in range of the **QW2432** Base.

You will be prompted to enter the 15-digit Base ID code printed on the underside of the base unit. After entering this code, press **OK**. The Handset will display **SEARCHING FOR BASE**, and then **FOUND BASE V14** when the process is complete.

Note: Base ID codes are 15 digits long and can include the following characters: 0, 1, 2, 3, 4, 5, 6, 7, 8, 9, *, or #.

MEM (Memory)

The QW2432 can store up to 50 names/numbers in memory. Each memory location can hold up to 32 digits and up to 16 characters for the name.

When prompted to **ENTER NAME**, use the digit keys to 'spell' the name. Each press of a particular key causes characters to be displayed in the following order:

Number Key	Characters (in order)
1	& ' , . 1
2	A B C a b c 2
3	D E F d e f 3
4	G H I g h i 4
5	J K L j k l 5
6	M N O m n o 6
7	P Q R S p q r s 7
8	T U V t u v 8
9	W X Y Z w x y z 9
0	0
*	*
#	#

MEM (Memory)

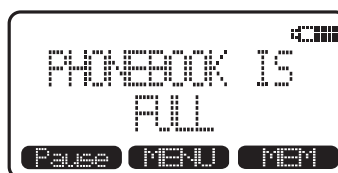
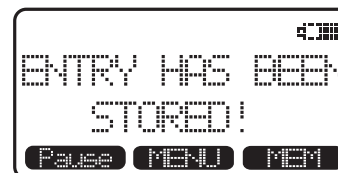
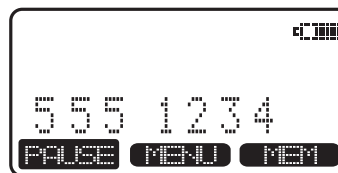
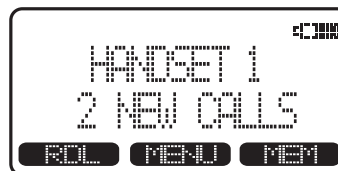

To Store a Number/Name:

- Starting from the idle screen, enter the number you want to store in memory.
- Be sure to include long distance codes and pauses (using the **PAUSE** softkey) if necessary. Press the **MEM** softkey.
- You will then be prompted to **ENTER NAME**. Use the digit keys to 'spell' the name. If you make a mistake, press the **CLR** softkey. To enter a space press **PAUSE**. When finished, press **SAVE**.
- If there is space available in memory, the number/name will be saved and the Handset will return to idle mode.
- If the memory is full the Handset will display **PHONEBOOK IS FULL** and exit to the idle screen without saving the entry.



MEM (Memory)

To Search For and Dial a Number/Name:

- Starting from the idle screen, press the **MEM** softkey to review memory contents.
- Using the  /  softkeys scroll through the memory contents in alphabetical order.
- Or, you can press the **FIND** softkey, enter the first few characters of the name and then press **FIND** to search. If you make a mistake, press **CLR** softkey. The closest match, in alphabetical order, will be displayed.
- Once you find the entry you want, simply press **ON** or **HANDSFREE** to dial the number.

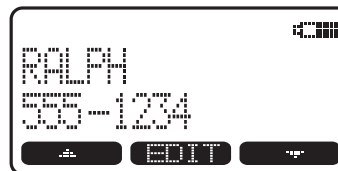
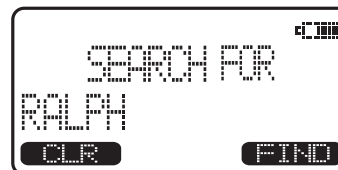
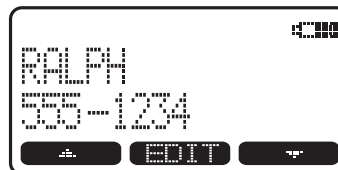
**To Delete a Number/Name:**

- Using the steps from 1 to 3 in **To Search For and Dial a Number/Name**, locate the entry you want to delete.
- Press the **EDIT** softkey. The Handset will display:

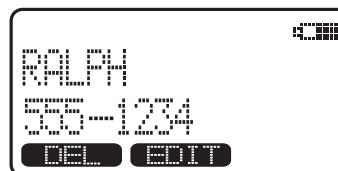
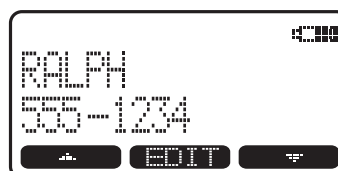

MEM (Memory)

- Press the **DEL** softkey. The Handset will display:
- To delete the displayed records, press **THIS**. To delete all records, press **ALL**.
- To confirm the deletion of **ALL** records, press **YES**. To exit without deleting press **NO**.

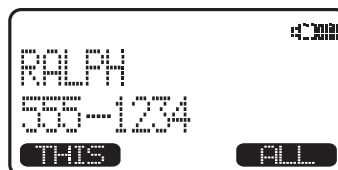

To Edit a Name or a Number

- Using the steps from 1 to 3 in **To Search For and Dial a Number/Name**, locate the entry you want to edit.
- Press the **EDIT** softkey twice. Then choose **NAME** or **NUM**
- Using the  softkey move the cursor to the character you want to edit and then enter the corrections as needed. Press **MORE** access **DEL**, **BACK** and **PAUSE** (when edit a name, **SPACE**) function. When finished press the **SAVE** softkey. To exit without saving press **OFF**.
- When finished the handset will display the edited entry.

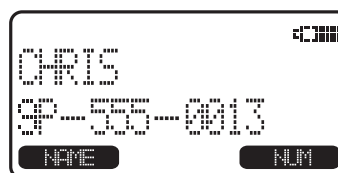
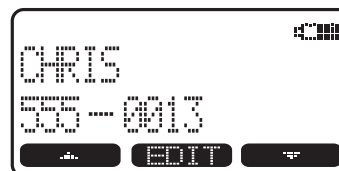

Base Settings

The QW2432 Base unit has several settings that can be adjusted according to your preference and system requirements.



Select Base Ringer Melody:

- The phone must be off.
- Press the star key three times (*******). The Base will emit a happy tone and the Power and Line In Use LEDs will flash rapidly.
- Press the **1,2,3,4,5**, or **6** keys to select the Ringer Melody. After each key press, the Base will emit a 1-second preview of the selected ringer.
- To save the selected ringer (and exit) press **#** .
- To exit without saving press ***** .

Select Tone / Pulse:

- The phone must be off.
- Press the star key three times (*******). The Base will emit a happy tone and the Power and Line In Use LEDs will flash rapidly.
- Press the **7** key to toggle between TONE and PULSE dialing mode. The Line In Use LED will toggle ON when TONE is selected and OFF when PULSE is selected.
- To save the TONE/PULSE selection (and exit) press **#** .
- To exit without saving press ***** .

Select Base Ringer Volume and OFF:

- The phone must be off.
- Press the star key three times (*******). The Base will emit a happy tone and the Power and Line In Use LEDs will flash rapidly.
- Press the volume up and down keys ( / ) to adjust the Base Ringer volume. After each press of the volume keys, the Base will emit the selected Ringer and volume setting for one second.
- To turn the Base ringer OFF, press the volume down key () until no ringer preview is played.
- To save the Ringer Volume selection (and exit) press **#** .
- To exit without saving press ***** .

Handset and Base Operation

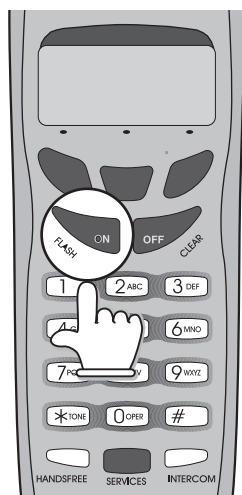

Making Calls

From the Handset



- Press **ON** (or, **HANDSFREE** to use the Handset Speakerphone feature). Dial the phone number.

-OR-

- Dial the phone number first; then press **ON** (or **HANDSFREE**).
- Press **OFF** to end your call.

Answering Calls

From the Handset



- Press any key except **OFF** and the softkey.
- Press **OFF** to end your call.

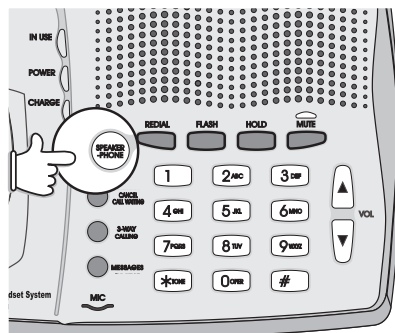

Making Calls

From the Base Unit



- Press **SPEAKERPHONE**. Dial the phone number.
- Press **SPEAKERPHONE** to end your call.

Answering Calls

From the Base Unit



- Press **SPEAKERPHONE**.
- Press **SPEAKERPHONE** to end your call.

Redial from Base Unit



- Pressing **REDIAL** will immediately dial the last number in the base unit redial memory. Hold down the **REDIAL** key for more than 2 seconds to erase the contents in redial memory. This is to prevent the accidental dialing of the number stored in redial memory.

Handset and Base Operation

Mute Function



During an active call pressing either the **MUTE** soft key on the Handset or the **MUTE** key on the Base (when in speakerphone mode), will disable the microphone. Press **MUTE** key again to return to normal 2-way conversation.

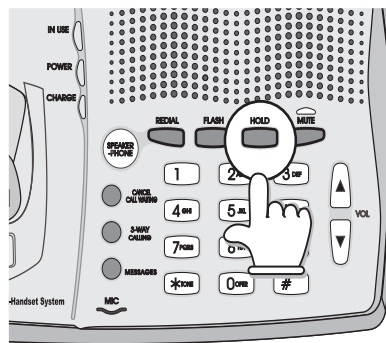

Hold Function



From the Handset :

- Press the **HOLD** soft key to place a call on hold. To return to the call press the **ON** or **HANDSFREE** key.

From the Base :

- During an active call, press the **HOLD** key to place a call on hold. The **SPEAKERPHONE** LED will flash to indicate a call is on hold.
- To return to the call press either **HOLD** or **SPEAKERPHONE**.

Flash Function



You can use your QW2432 with services such as Call Waiting. Simply press the **ON** key on the Handset or the **FLASH** key on the Base (when in speakerphone mode) to FLASH the line.

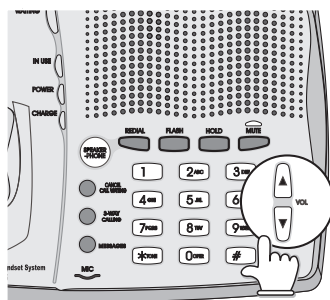

Volume Control



From the Handset:

During an active call press the **VOL** soft key, then use the **UP** and **DOWN** soft keys to adjust the earpiece volume.

From the Base:

During an active call simply press the Volume **UP** or **DOWN** keys to adjust the speakerphone volume. You will hear a special tone when you reach the highest or lowest setting.

Handset and Base Operation

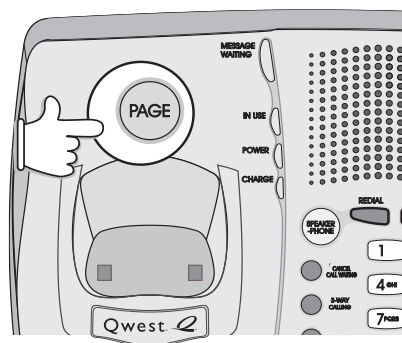

Page/Intercom



From Base to ALL Handsets :

- To page all Handsets from the Base press the **PAGE/INTERCOM** key. This will cause all Handsets linked with this Base to ring.
- Each Handset will display **GLOBAL CALL FROM BASE**.
- Any Handset can then answer the PAGE, and enter INTERCOM mode with the Base by pressing the **INTERCOM** key.
- To end an intercom call, press **OFF** on the Handset or **PAGE/INTERCOM** on the Base.

From Base to a particular Handset :

- Press the Base **PAGE/INTERCOM** key, then press the number of the Handset you want to call (e.g. **INTERCOM 2**).
- Handset 2 can then answer the intercom call by pressing **INTERCOM** key.
- To end an intercom call press **OFF** on the Handset or **PAGE/INTERCOM** on the Base.

From Handset to Base :

- Press the **INTERCOM** key followed by 0.
- The Base will ring once and then automatically enter **INTERCOM** mode.
- To end an intercom call press **OFF** on the Handset or **PAGE/INTERCOM** on the Base.

From Handset to Handset :

- Press the **INTERCOM** key followed by the number of the other Handset you wish to call (e.g. **INTERCOM 3**).
- Handset 3 can then answer the intercom call by pressing the **INTERCOM** key.
- To end the intercom call press **OFF** on either Handset.

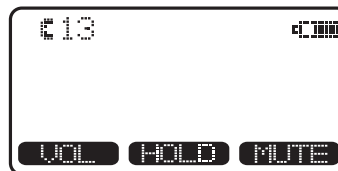

All Call from Handset

- Press the **INTERCOM** key followed by the *****. All registered Handsets and the Base will ring.
- Any Handset or the Base can answer by pressing **INTERCOM**.
- To end the intercom call press **OFF** on Handset, or press **PAGE/INTERCOM** on Base.

Handset and Base Operation

Handsfree Speakerphone Operation

Your QW2432 handset has a built-in handsfree speakerphone. This feature allows you to stand the Handset upright on a table or desktop and have handsfree conversations. For more information, refer to **MAKING CALLS in HANDSET AND BASE OPERATION**.

Base Speakerphone Operation

The Base of your QW2432 is equipped with a full duplex speakerphone. This is a very useful feature for handsfree conversations or conference calls at the base unit. For more information, refer to **MAKING CALLS in HANDSET AND BASE OPERATION**.

Line in Use Indication

On the Handset :

When the telephone line is currently being used by a system Handset or the QW2432 Base, a status message similar to this will display on idle Handset(s):

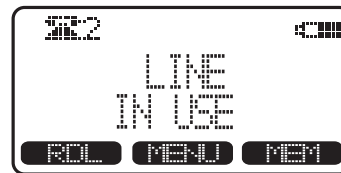

When the telephone line is currently being used by a parallel set (a telephone device other than the QW2432 on the same line); the phone icon will remain on steadily, and **EXTENSION IN USE** will be displayed.

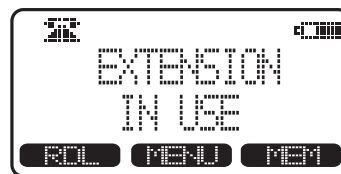

On the Base :

When a system Handset or a QW2432 Base is currently being used, the LINE IN USE LED on the base will illuminate steadily. When a parallel set is currently being used, the LINE IN USE LED on the base will flash.

Low Battery Indication

When a low battery is detected, the Battery icon will flash and a warning beep is played. The status message **LOW BATTERY** will also be displayed when the Handset is in idle mode. To prevent an unexpected call drop, a drained Handset battery should be replaced by a fully charged spare battery.

Handset and Base Operation

Message Waiting Indication

The QW2432 is compatible with optional voicemail service provided by some local telephone companies. If you subscribe to this service, and you have new, unplayed messages in your voicemail, a Visual Message Waiting Indicator (VMWI) signal is transmitted by your local telephone company.

The QW2432 will detect a VMWI signal and activate a the Message Waiting light on the Base and the Message Waiting light on the Handset.

After you check your messages, the Message Waiting indicators will automatically turn off.

Please note that whenever new, unplayed messages are stored in your voicemail, the local Telephone Company will continue to send a VMWI signal.

Conference Calling

The QW2432 is capable of supporting conference calls with up to two registered Handsets, and the Base unit.

To enter a conference call, simply access the line with two or more extensions by pressing **ON** (or **HANDSFREE**) on the Handset or **SPEAKERPHONE** on the Base.

The phone icon  and two or more extension numbers will be displayed in the upper left corner of the Handset.

Transferring Calls

You can transfer calls on the QW2432 system from the Base to Handset, Handset to Handset, or Handset to Base.

Blind Transfer

You can directly transfer any active call to another system extension without notification by doing the following steps:

- Handset or Base must be on an active call.
- Press the **INTERCOM** key followed by the number of the Handset (**1,2,3,4**) or Base (**0**) that you wish to transfer the call to.
- When the other extension answers, the call will automatically be connected to the other extension.
- An unanswered call will ring back to the originating Handset/Base if not answered within 30 seconds. And if still not answered within 30, the call will automatically be end.

Handset and Base Operation

Announced Transfer:

You can perform an announced transfer (call and advise another extension) of an active call by doing the following steps:

- Handset or Base must be on an active call.
- Place the active call on **HOLD**.
- Press the **INTERCOM** key followed by the number of the Handset (**1,2,3,4**) or Base (**0**) that you wish to transfer the call to.
- When the other extension answers the intercom call, explain they have an active call waiting.
- Either extensions press **OFF** to end the intercom call.
- The other extension presses **ON** (or **HANDSFREE**) on the Handset, or **SPEAKERPHONE** on the Base to pick up the call on hold.

Network Service Features

Additional Base Features

CANCEL CALL WAITING will deactivate Call Waiting before placing an important call. Press this key before dialing. During that call, there will be no interruption from Call Waiting. After you hang up, Call Waiting will be reactivated for your next call.

3-WAY CALLING allows you to talk with 2 separate parties from a single line.

- 1) Call your first party. Wait for the first party to answer.
- 2) Press **3-WAY CALLING**. Wait for dial tone.
- 3) Call your second party.
- 4) After the call is answered, press **3-WAY CALLING** again.

MESSAGES dials * 98, which is the code to access Qwest Voice Messaging from your home in the Qwest region. If you subscribe to Qwest Voice Messaging, when you see the Message Waiting Indicator select **MESSAGES** to listen to your messages.

Additional Handset Features

Press **SERVICES** on your Handset for access to other popular custom features offered by many telephone companies:

1. **MESSAGES** - dials * 98 to access Voice Messages
2. **3-WAY CALLING** - to set up a 3-Way Call
3. **CANCEL CALL WT** - to deactivate Call Waiting for that call
4. **LAST CALL RTN** - dials * 69 to get the number of your last incoming call
5. **REJECT ANON.** - prevents ringing from callers that blocked Caller ID
6. **ACCEPT ANON.** - turns off Anonymous Rejection
7. **CONTINUOUS DIAL** - to redial a number that's busy (for up to 30 min.)
8. **CALL FWD ON** - dials * 72 to initiate sequence to set up Call Forwarding
9. **CALL FWD OFF** - turns off Call Forwarding

NOTE: It is likely that your local telephone company will assess charges to use network service features. You should check with your local service provider regarding the custom services that are available in your area and the associated costs for the intentional or unintentional use of network services. Your local telephone company may provide a monthly subscription to an individual service or a package of services that gives you unlimited usage for a small monthly fee.

Headset Operation

Your QW2432 cordless telephone is equipped with a 2.5mm Headset Jack for use with an optional accessory Headset for hands-free operation.

To purchase a Headset, call 800-244-1111.

Once you have a compatible 2.5mm Headset, locate the Headset Jack on the Handset. Connect the plug on the Headset cord to the jack on the cordless Handset. The plug should fit securely. Do not force the connection.

Operation

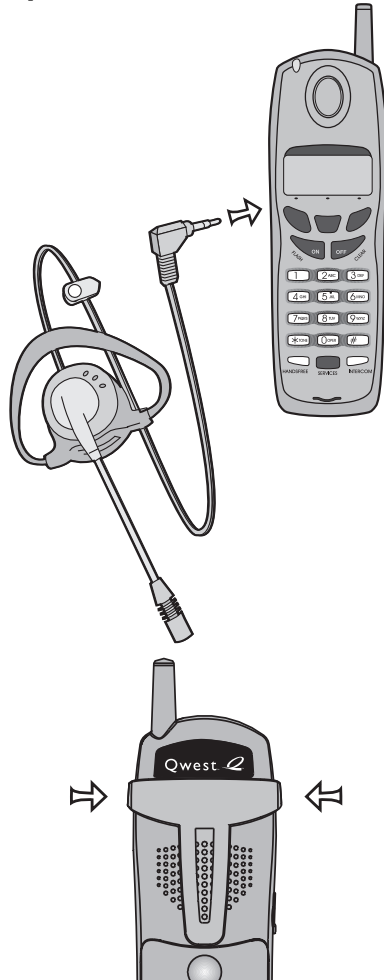

NOTE :

Whenever a compatible Headset is connected to the cordless Handset, the microphone on the Handset will be muted. This is done to limit the effect of background noise.

Belt Clip

The Handset is also equipped with a detachable belt clip. Align the pins on the inside edge of the clip with the notches on the sides of the Handset. The belt clip should snap securely into place. Do not force the connection.

Maintenance

Taking Care Of Your Telephone

Your QW2432 cordless telephone contains sophisticated electronic parts, so it must be treated with care.

Avoid rough treatment

Place the Handset down gently. Save the original packing materials to protect your telephone if you ever need to ship it.

Avoid water

Your telephone can be damaged if it gets wet. Do not use the Handset outdoors in the rain, or handle it with wet hands. Do not install your Base Unit near a sink, bathtub or shower.

Electrical storms

Electrical storms can sometimes cause power surges harmful to electronic equipment.

For your own safety, use caution when using electric appliances during storms.

Cleaning your telephone

Your telephone has a durable plastic casing that should retain its luster for many years. Clean it only with a soft cloth slightly dampened with water or a mild soap. Do not use excess water or cleaning solvents of any kind.

Remember that electrical appliances can cause serious injury if used when you are wet or standing in water. If your Base Unit should fall into water, **DO NOT RETRIEVE IT UNTIL YOU UNPLUG THE POWER CORD AND TELEPHONE LINE CORDS FROM THE WALL.** Then pull the unit out by the unplugged cords.

In Case Of Difficulty

If you have difficulty operating your phone, the suggestions below should solve the problem. If you still have difficulty after trying these suggestions, call the Customer Service at 800-651-6791.

The Phone Doesn't Work At All

- Make sure the Power Cord is plugged in.
- Make sure the telephone line cord is plugged firmly into the Base Unit and the telephone wall jack.
- Make sure the batteries are properly charged. If the 'LOW BATTERY' message is shown, the battery pack needs charging.

No Dial Tone

- First check all the suggestions above.
- If you still don't hear a dial tone, disconnect the Base Unit from the telephone jack and connect a different phone. If there is no dial tone on that phone either, the problem is in your wiring or local service. Contact your local telephone company.

You Get Noise, Static, Or A Weak Signal Even When You're Near The Base Unit

- Household appliances plugged into the same circuit as the Base Unit can sometimes cause interference. Try moving the appliance or the Base Unit to another outlet.

You Get Noise, Static, Or A Weak Signal When You're Away From The Base Unit

- You may be out of range. Either move closer to the Base, or relocate the Base Unit.
- The layout of your home may be limiting the range. Try moving the Base Unit to another position.

The Handset Does Not Ring When You Receive A Call

- Make sure you have the Handset ringer activated. To set the ringer, see HANDSET SETTINGS and BASE SETTINGS.
- Make sure the telephone line cord is plugged firmly into the Base Unit and the telephone jack. Make sure the power cord is plugged in.
- You may be too far from the Base Unit.
- You may have too many extension phones on your telephone line to allow all of them to ring. Try unplugging some of the other phones.

In Case Of Difficulty

You Hear Other Calls While Using Your Phone

- Disconnect your Base Unit from the telephone jack, and plug in a regular telephone. If you still hear other calls, the problem is probably in your wiring or local service. Call your local telephone company.

You Hear Noise In The Handset, And None Of The Keys Or Buttons Work

- Make sure the power cord is plugged in.

Common Cure For Electronic Equipment

If the unit does not seem to be responding normally, then try putting the Handset in the cradle. If it does not seem to respond, do the following (in the order listed) :

1. Disconnect the power to the Base.
2. Disconnect the Handset battery, and spare battery pack, if applicable.
3. Wait a few minutes.
4. Connect power to the Base.
5. Re-install the battery pack (s)
6. Watch for Handset to display :



then

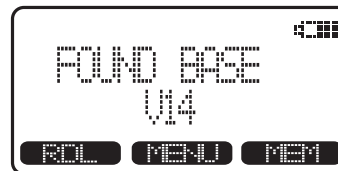

Warranty Statement

WHAT DOES OUR WARRANTY COVERS?

- Any defect in material or workmanship.

FOR HOW LONG AFTER THE ORIGINAL PURCHASE?

- To the original purchaser only - ONE YEAR.

WHAT WILL WE DO?

- At our option, repair or replace your unit.

WARRANTY RETURNS?

- In the Qwest region, call Customer Service for Return Authorization at: 800-651-6791
- Properly pack your unit. Include any cables & accessories that were originally provided with the product. We recommend using the original carton and packing materials.
- Ship the unit following the instructions provided by Qwest Customer Service
- Qwest assumes no responsibility for units sent without prior Return Authorization.

WHAT DOES OUR WARRANTY NOT COVER?

- Batteries
- Damage from misuse, neglect, or acts of nature (lightning, floods, power surges, etc.)
- Products with may have been modified or incorporated into other products
- Products purchased and/or operated outside the USA, its territories.
- Products serviced by the owner or a service facility not expressly authorized by **Qwest Customer Service**.
- Products purchased more than 12 months from current date
- Units purchased in "AS IS" condition, or units purchased as "Distressed Merchandise".

HOW DOES STATE LAW OR PROVINCIAL LAW RELATE TO THIS WARRANTY?

- This warranty gives you specific rights. You may also have other rights which vary from state to state.

FCC Regulations

This equipment complies with Parts 15 of the Federal Communications Commission (FCC) rules for the United States. It also complies with regulations RSS210 and CS-03 of Industry and Science Canada. Operation is subject to the following two conditions: (1) this device may not cause interference, and (2) this device must accept any interference, including interference that may cause undesired operation of the device.

A label is located on the underside of the Base Unit containing either the FCC registration number and Ringer Equivalence Number (REN) and Load Number. You must, upon request, provide this information to your local telephone company.

This equipment is compatible with inductively coupled hearing aids.

Should you experience trouble with this telephone equipment, please contact:

Customer Service at 800-651-6791. The telephone company may ask you to disconnect this equipment from the line network until the problem has been corrected.

FCC Part 15

Warning: Changes or modifications to this unit not expressly approved by the party responsible for compliance could void the user's authority to operate the equipment.

The equipment has been tested and found to comply with part 15 of the FCC rules. These limits are designed to provide reasonable protection against harmful interference in a residential installation. This equipment generates, uses and can radiate radio frequency energy and, if not installed and used in accordance with the instructions, may cause harmful interference to radio communications. However, there is no guarantee that interference will not occur in a particular installation. If this equipment does cause harmful interference to radio or television reception, which can be determined by turning the equipment off and on, the user is encouraged to try and correct the interference by one or more of the following measures:

- Reorient or relocate the receiving antenna.
- Increase the separation between the equipment and receiver.
- Connect the equipment into an outlet or on a circuit different from that to which the receiver is connected.
- Consult the dealer or an experienced radio/TV technician for help.

FCC Regulations

FCC Part 68

The FCC requires that you connect your cordless telephone to the nationwide telephone network through a modular telephone jack (USOC RJ11C, RJ11W or RJ14).

Your telephone company may discontinue your service if your equipment causes harm to the telephone network. They will notify you in advance of disconnection, if possible. During notification, you will be informed of your right to file a complaint with the FCC.

Occasionally, your telephone company may make changes in its facilities, equipment, operation, or procedures that could affect the operation of your equipment. If so, you will be given advance notice of the change to give you an opportunity to maintain uninterrupted service.

The Base Unit contains no user serviceable parts. The Handset contains a user replaceable battery pack.

If it is determined that your telephone equipment is malfunctioning, the FCC requires that it not be used and that it be unplugged from the modular jack until the problem has been corrected. Repairs to this telephone equipment can only be made by the manufacturer or its authorized agents or by others who may be authorized by the FCC. For repair procedures, follow the instructions outlined under the Limited Warranty.

This equipment may not be used on coin service provided by the phone company or Party Lines.

The REN is useful in determining the number of devices you may connect to your telephone line and still enable the devices to ring when you receive a call. The general rule is that the REN value should not exceed 5.0A total; however, contact your local telephone company for the specific number in your area.

Technical Specifications

FREQUENCY CONTROL

Crystal controlled
PLL synthesizer

TRANSMIT FREQUENCY

2401.056 - 2482.272 MHz

RECEIVE FREQUENCY

2401.056 - 2482.272 MHz

CHANNELS

95 Channels

NOMINAL EFFECTIVE RANGE

Maximum power allowed by FCC.
Actual operating range may vary
according to environmental conditions
at the time of use.

SIZE

Handset : 48mm x 33mm x 175mm

Base : 170mm x 115mm x 60mm

WEIGHT

Handset : 170 grams

Base : 348 grams

POWER REQUIREMENTS

Handset : 800mAh NiCd Battery
Pack or 1500mAh NiMH
Battery Pack

Base : 7 VDC @ 900mA

MEMORY

Speed Dial: 50 Memory locations, into
32 digits per location.

CID : Alpha Numeric Display
50 Memory locations

**SPECIFICATIONS ARE TYPICAL
AND MAY CHANGE WITHOUT
NOTICE.**

Table Of Contents

1. Important Safety Instructions	25. Advanced Operations
3. Introduction	25. Handsfree and Base Operation
4. Parts Check List	25. Making Calls
5. The Handset Layout	25. Answering Calls
6. The Base Unit Layout	25. Redial from Base Unit
7. Getting Started	26. Mute Function
7. Setup	26. Hold Function
8. Installation of Battery Pack in Handset	26. Flash Function
9. Spare Battery Charger/Power Backup Function	26. Volume Control
10. Charging Of Handset Battery Pack	27. Page/Intercom
11. Wall Mounting	28. Handsfree Speakerphone Operation
12. Registration and Operation	28. Base Speakerphone Operation
14. Basic Operation	28. Line in Use Indication
14. Handset and Base Indicators	28. Low Battery Indication
16. Soft Menu Functions	29. Message Waiting Indication
16. RDL (Redial)	29. Conference Calling
16. MENU	29. Transferring Calls
17. Calls Log (Caller ID)	31. Additional Information
18. Handset Settings	31. Network service Features
19. Register	32. Headset Operation
20. MEM (Memory)	33. Maintenance
21. To Store a Number/Name	34. In Case Of Difficulty
22. To Search For and Dial a Number/Name	36. Warranty Statement
22. To delete a Number/Name	37. FCC Regulations
23. To Edit a Name or a Number	39. Technical Specifications
24. Base Setting	

91-5366-10-00
ISSUE 0

Free Manuals Download Website

<http://myh66.com>

<http://usermanuals.us>

<http://www.somanuals.com>

<http://www.4manuals.cc>

<http://www.manual-lib.com>

<http://www.404manual.com>

<http://www.luxmanual.com>

<http://aubethermostatmanual.com>

Golf course search by state

<http://golfingnear.com>

Email search by domain

<http://emailbydomain.com>

Auto manuals search

<http://auto.somanuals.com>

TV manuals search

<http://tv.somanuals.com>