

vtech

with **Caller ID Digital Answering System**
Cordless Phone System
USER'S MANUAL
t2447



caller ID / call waiting *

Digital answering system
with 3 mailboxes and
15 minutes record time.

90 name and number
caller ID memory

CALLER ID

**DIGITAL
ANSWERING
SYSTEM**

Important Safety Instructions

When using your telephone equipment, basic safety precautions should always be followed to reduce the risk of fire, electric shock and injury, including the following:

1. Read and understand all instructions.
2. Follow all warnings and instructions marked on the product.
3. Unplug this product from the wall outlet before cleaning. Do not use liquid cleaners or aerosol cleaners. Use a damp cloth for cleaning.
4. Do not use this product near water (for example, near a bath tub, kitchen sink, or swimming pool).
5. Do not place this product on an unstable cart, stand, or table. The product may fall, causing serious damage to the product.
6. Slots and openings in the cabinet and the back or bottom are provided for ventilation. To protect it from overheating, these openings must not be blocked by placing the product on the bed, sofa, rug, or other similar surface. This product should never be placed near or over a radiator or heat register. This product should not be placed in a built-in installation where proper ventilation is not provided.
7. This product should be operated only from the type of power source indicated on the marking label. If you are not sure of the type of power supply to your home, consult your dealer or local power company.
8. Do not allow anything to rest on the power cord. Do not locate this product where the cord will be abused by persons walking on it.
9. Never push objects of any kind into this product through cabinet slots as they may touch dangerous voltage points or short out parts that could result in a risk of fire or electric shock. Never spill liquid of any kind on the product.
10. To reduce the risk of electric shock, do not disassemble this product, but take it to an authorized service facility. Opening or removing cabinet parts other than specified access doors may expose you to dangerous voltages or other risks. Incorrect reassembling can cause electric shock when the appliance is subsequently used.
11. Do not overload wall outlets and extension cords as this can result in the risk of fire or electric shock.
12. Unplug this product from the wall outlet and refer servicing to an authorized service facility under the following conditions:
 - A. When the power supply cord or plug is damaged or frayed.
 - B. If liquid has been spilled into the product.
 - C. If the product has been exposed to rain or water.
 - D. If the product does not operate normally by following the operating instructions. Adjust only those controls that are covered by the operating instructions, because improper adjustment of other controls may result in damage and will often require extensive work by an authorized technician to restore the product to normal operation.
 - E. If the product has been dropped and the cabinet has been damaged.
 - F. If the product exhibits a distinct change in performance.

Important Safety Instructions

13. Avoid using a telephone (other than a cordless type) during an electrical storm. There may be a remote risk of electric shock from lightning.
14. Do not use the telephone to report a gas leak in the vicinity of the leak.
15. Only put the Handset of your telephone next to your ear when it is in normal talk mode.

Before You Begin

Enhanced 2.4GHz Technology - Dual Band transmission combines the best of 2.4GHz and 900MHz technologies, providing enhanced performance over standard cordless telephones.

Before You Begin

Parts Check List:

- | | |
|--------------------------|-------------------------------|
| 1. Base Unit | 5. Battery |
| 2. Handset | 6. Belt Clip |
| 3. Base AC Power Adaptor | 7. User's Manual |
| 4. Telephone Line Cord | 8. Base Wall Mounting Bracket |

To purchase replacement battery packs, call VTech Communications, Inc. at 1-800-595-9511. In Canada, call VTech Telecommunications Canada Ltd. at 1-800-267-7377.



Handset

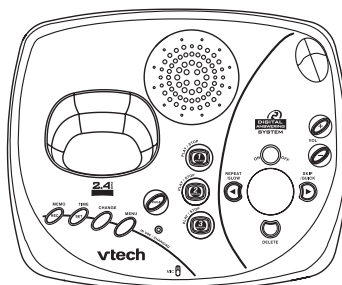

Base Unit



Belt Clip



Battery

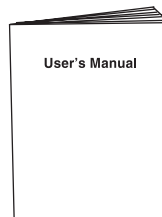

User's Manual

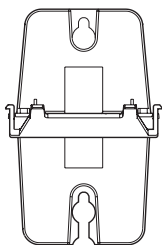

Base Wall
Mounting Bracket

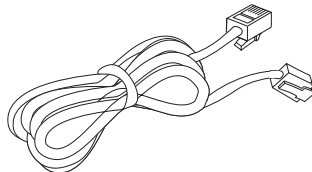

Telephone Line Cord

The Handset Layout

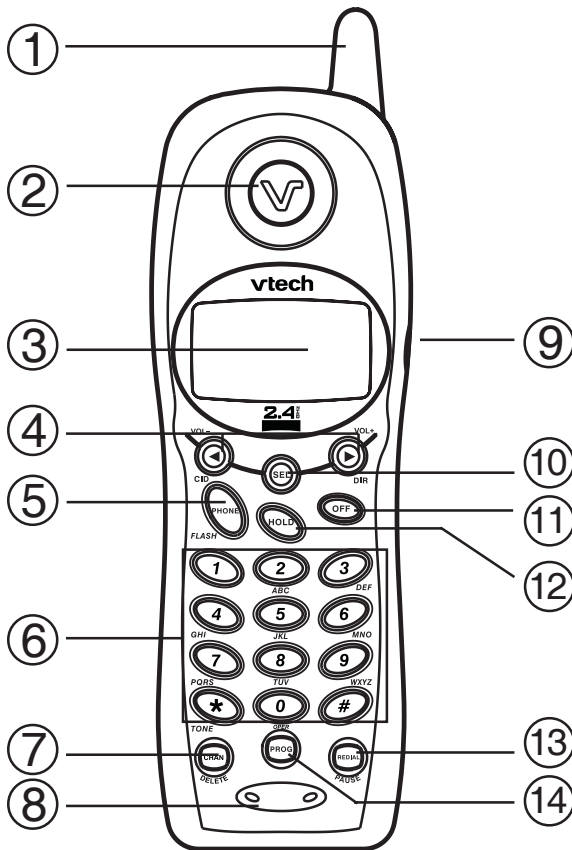

- | | |
|------------------------------|----------------------|
| 1. Antenna | 8. Microphone |
| 2. Earpiece | 9. Headset Jack |
| 3. LCD | 10. Sel Key |
| 4. Left and Right Arrow Keys | 11. Off Key |
| 5. Phone/Flash Key | 12. Hold Key |
| 6. Dialing Keys (0-9,*,#) | 13. Redial/Pause Key |
| 7. Chan/Delete Key | 14. Prog Key |

The Base Unit Layout

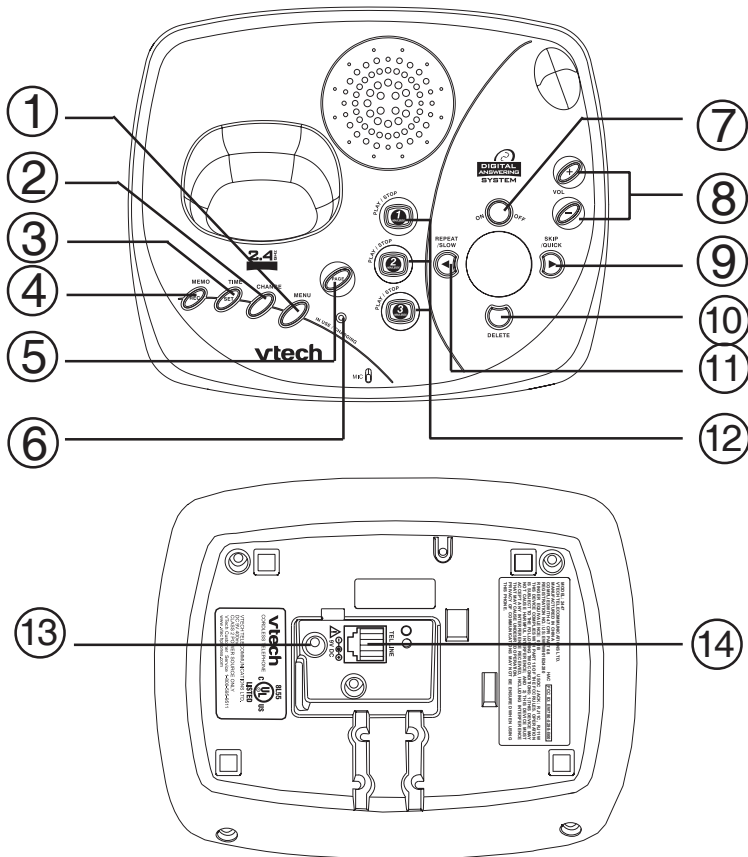

- | | |
|--------------------------|------------------------------|
| 1. Menu Key | 8. Volume +/- Keys |
| 2. Change Key | 9. Skip/Quick Key |
| 3. Time/Set Key | 10. Delete Key |
| 4. Memo/Rec Key | 11. Repeat/Slow Key |
| 5. Page Key | 12. Play/Stop (Mailbox) Keys |
| 6. In Use/Charging Light | 13. DC Connector Jack |
| 7. On/Off Key | 14. Telephone Line Jack |

Installation

Before You Install

1. **Choose a location for the Base near an electrical outlet and a telephone jack.** This phone requires a modular telephone jack and a standard electrical outlet (110V AC) not controlled by a wall switch.
2. **Install the Handset battery.** Use only VTECH batteries.

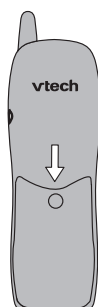

- a) Remove battery compartment cover by pressing on the indentation and sliding downward.

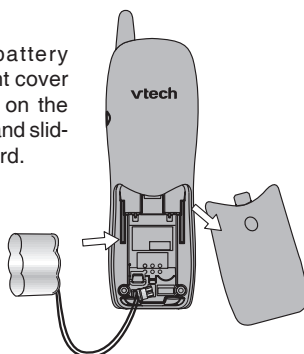

- b) Align the two holes in the plug with the socket pins, then snap the plug into place.
- c) Place the battery in the compartment with the wires in the lower right corner. Angle the top of the battery under the top claws first, then snap the bottom of the battery in. Place the wires under the guide, located below the battery.
- d) Replace battery compartment cover.

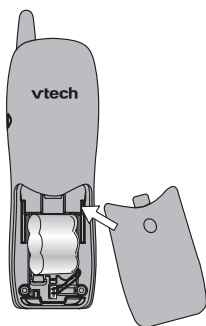

3. Plug the DC connectors to the Base. Plug the AC adaptors into an electrical outlet. Connect the telephone line cord to the jack on the Base, and the other end to a modular telephone jack, as illustrated on the next page.
4. Place the Handset in the Base. Charge the battery for 10-12 hours.

Installation

Table/Desk Installation

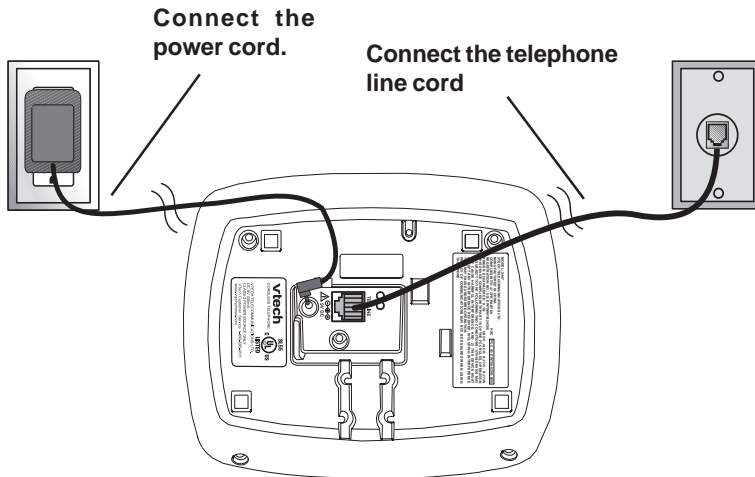

1. Check for Dial Tone

After the battery is charged, pick up the Handset and press **PHONE**, you should hear a dial tone.

2. Set Time and Date

If you subscribe to Caller ID service, the date and time will be set automatically with the first incoming call. If you do not have Caller ID service, you can set the date and time manually.

- Press **PROG**, and then press ◀ or ▶ until **DATE/TIME** is displayed. Press **SEL**.
- The month is flashing. Press ◀ or ▶ until the screen displays the correct month. Press **SEL**.
- The day is flashing. Press ◀ or ▶ until the screen displays the correct day. Press **SEL**.
- The hour is flashing. Press ◀ or ▶ until the screen displays the correct hour. Press **SEL**.
- The minute is flashing. Press ◀ or ▶ until the screen displays the correct minute. Press **SEL**.
- **AM** or **PM** is flashing. Press ◀ or ▶ to choose **AM** or **PM**. Press **SEL**.

Installation

Wall Mounting

The Wall Mount bracket is designed for use on standard wall mount plates only.

1. Run the power and telephone line cords through the slots in the bracket, connecting them to the jacks located on the underside of the Base.
2. Plug the AC adapter into an electrical outlet. If the battery has not been previously charged, place the Handset in its Base, and allow it to charge for 12 hours.
3. Connect the telephone line cord to the wall jack.
4. Line up the tabs on the wall mount bracket with the slots on the bottom of the Base Unit. Snap the bracket firmly in place.
5. Mount the Base on the wall. Position the Base Unit so the mounting studs will fit into the holes on the wall mount bracket. Slide the Base Unit down on the mounting studs until it locks into place.

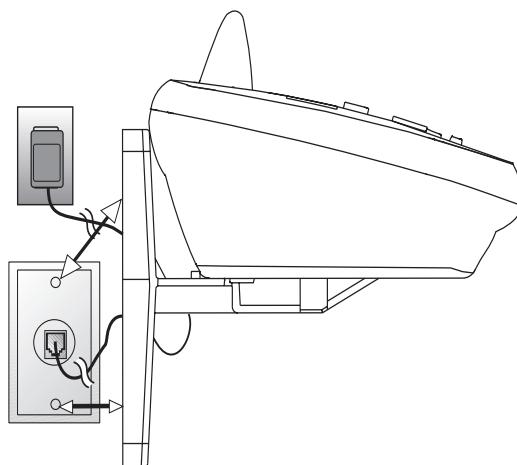

Telephone Operation

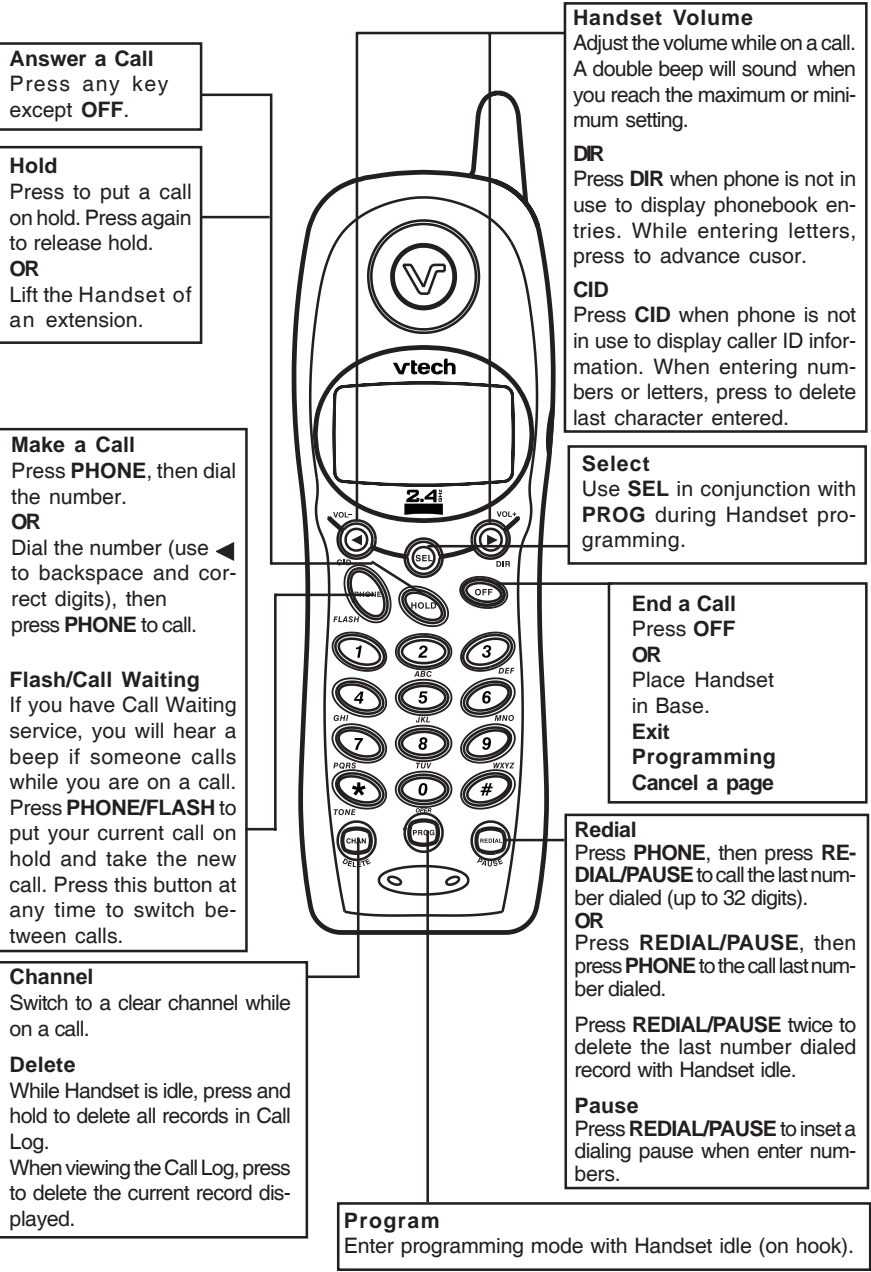

Telephone Operation

Page

Press to page the Handset for up to 60 seconds. Press again, press **OFF** on Handset or place Handset in Base to cancel the page.

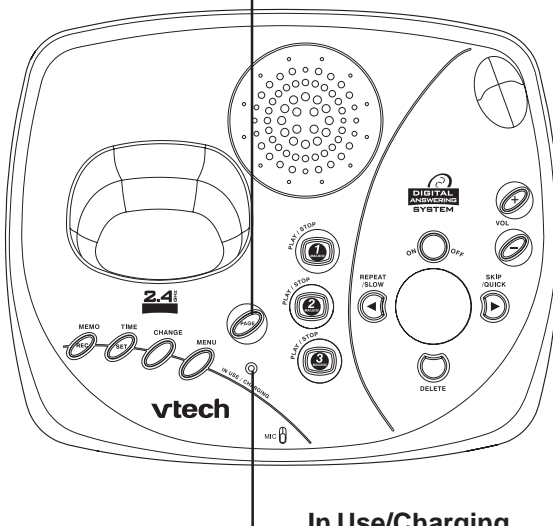

In Use/Charging

- Flashes in unison with the ring of an incoming call.
- Flashes slowly when the Handset is in use.
- Flashes rapidly when a call is on hold.
- Glows steadily when the Handset is charging.

Telephone Operation

Handset Ringer Style/Battery Save

You can select from four different Handset ringer styles, or turn the ringer off and extend the battery life.

1. Make sure the Handset is off.
2. Press **PROG**.
3. Press **▶** until the screen displays **RINGER:**.
4. Press **SEL**. The current setting blinks, and you will hear a sample of the ring.
5. Press **◀** or **▶** to select **RINGER:1, 2, 3, 4** or **OFF**. You will hear a sample of each ring.
6. Press **SEL** to choose the displayed ringer setting.

Set Dial Mode

If you have touch tone service, the phone is ready to use as soon as the battery is charged. If you have pulse (rotary) service, you'll need to change the dial mode.

1. Press **PROG**.
2. Press **▶** Until screen displays **DIAL MODE & SETTING**.
3. Press **SEL**. The current setting blinks.

DIAL MODE: TONE

Default setting: Tone

4. Press **▶** to display tone or pulse.
5. Press **SEL**.

Set Language

1. Press **PROG** to begin programming.
2. Press **◀** or **▶** until **LANGUAGE** is displayed.
3. Press **SEL**. The current setting blinks.

ENGLISH

Default setting: English

4. Press **▶** to display **ENGLISH, ESPANOL** or **FRENCH**
5. Press **SEL** to select displayed language and exit.

Temporary Tone Dialing

If you have pulse (rotary) service only, you can change from pulse to touch tone dialing during a call by pressing ***TONE**. This is useful if you need to send touch tone signals for access to telephone banking or long-distance services.

1. Dial the number.
2. Press ***TONE**. Buttons pressed after this send touch tone signals.
3. After you hang up, the phone automatically returns to pulse (rotary) service.

Telephone Operation

Display Screen Messages

Screen Displays:	When:
------------------	-------

** RINGING **	There is a call coming in.
CONNECTING...	The Handset is waiting for a dial tone.
PHONE ON	The Handset is in use.
SCANNING...	The Handset is changing to another of the 30 channels available.
** PAGING **	The Base is paging the Handset.
HOLD	There is a call on hold.
BATTERY LOW	The Battery needs to be recharged.
NO CONNECT	<ol style="list-style-type: none">1. Displays and a sad tone sounds when the Base power is off and PHONE is pressed.2. Displays and a sad tone sounds when Handset is out of range and an attempt to dial is failed.

Speed Dial

You can store up to 9 telephone numbers with names (up to 15 characters, 24 digits each location) you dial frequently into the Speed dial memory locations you assign (1 through 9) in the Handset.

You can also store telephone numbers with names alphabetically in the directory. See **Telephone Directory** for instructions.

NOTES:

1. The entries you store in Speed dial memory will be marked with 01 through 09 and also display in the directory.
2. Press **OFF** at any time to exit speed dial mode.

Store a Number/Name in Memory

1. Press **PROG**. Then press ◀ or ▶ until the screen displays **SPEED DIAL**.
2. Press **SEL**. The screen displays **ENTER 1-9**.

NOTE: When memory is full, the screen displays **MEMORY FULL**, an error tone sounds, and you will not be able to store a new record until you delete a stored record the speed dial memory or telephone directory.

3. Press the key (1 through 9) to assign the memory location for your entry. The screen displays **ENTER NAME**.

NOTE: If the location is not empty, your new entry will be stored in place of the old and will delete the former entry. Take caution to not save over entries you do not wish to delete from memory.

4. Using the chart below, enter up to 15 characters for the name you're storing. Use ◀ to backspace and make corrections; use ▶ to add a space.

Dial Key	Presses					
	1	2	3	4	5	6
1:	1					
2:	A	B	C	2		
3:	D	E	F	3		
4:	G	H	I	4		
5:	J	K	L	5		
6:	M	N	O	6		
7:	P	Q	R	S	7	
8:	T	U	V	8		
9:	W	X	Y	Z	9	
0:	0					
*	*					
#:	&	'		-	.	#

5. When you finish entering the name, press **SEL** or **PROG**. The screen displays **ENTER NUMBER**.
6. Enter the telephone number. Use ◀ to backspace and make corrections. Press **REDIAL/PAUSE** to enter a pause if necessary.

Speed Dial

— OR —

Press **REDIAL/PAUSE** to display the last number dialed from this phone.

7. Press **SEL** or **PROG** to store your entry. The screen displays **DISTINCT RING?** and the current setting.
8. Press **◀** or **▶** to change the setting. Choose **Y** (yes) if you wish the phone to alert you to calls from this number by assigning a distinctive ringer after the first ring. Choose **N** (no) for a normal ringer.
9. Press **SEL** or **PROG** to confirm your selection. If you chose **Y** in step eight, a **🔔** will be displayed with the entry.

Edit a Number/Name Stored in Memory

1. Press and hold the memory location key (1 through 9) of the entry you wish to edit.
2. When the screen displays the entry you want to edit, press **SEL**. **EDIT** flashes in the screen.



```
SPEED EDIT ERASE
800-595-9511
01
```

3. Press **SEL**. The screen displays the name and number. The flashing cursor appears at the end of the name. Use **◀**, **▶** and the dial pad keys to edit the name. Press **SEL** to move on to edit the number. Use **◀** to backspace and make corrections. Press **SEL** to move on to edit the Distinctive Ring setting.
4. Press **SEL** to save the edited information.

Delete a Number/Name Stored in Memory

1. Press and hold the memory location key (1 through 9) of the entry you wish to delete.
2. When the screen displays the entry you want to delete, press **SEL**. Then press **▶** until **ERASE** flashes.



```
SPEED EDIT ERASE
800-595-9511
01
```

3. Press **SEL**. The screen displays **ERASE NO YES** and the number. The current choice flashes.
4. Press **▶** until **YES** flashes.
5. Press **SEL**. You will hear a confirmation beep.

Dial a Speed Dial Entry

1. Press and hold the memory location key (1 through 9) of the entry you wish to dial.
2. Press **PHONE** to dial.

Speed Dial

Reassign Locations in Memory

1. Press and hold the memory location key (1 through 9) of the entry you wish to reassign.
2. When the screen displays the entry you want to reassign, press **SEL**. Then press ◀ until **SPEED** flashes.



```
SPEED EDIT ERASE
800-595-9511
01
```

3. Press **SEL**. The screen displays **ENTER 1-9**.
4. Press the keys (1 through 9) to reassign this entry into another speed dial location. You will hear a confirmation beep.

Telephone Directory

Your **t 2447** can store 50 (including 9 speed dial entries) telephone numbers with names (up to 15 characters for the name and 24 digits for the number).

NOTE: Press **OFF** at any time to exit the directory.

Store a Number/Name in the Directory

1. Press **PROG**. The screen displays **DIRECTORY**.
2. Press **SEL**. The screen displays **ENTER NAME**.
3. Using the chart below, enter up to 15 characters for the name you're storing with the number. Use **◀** to backspace and make corrections; use **▶** to advance and add a space.

Dial Key	Presses					
	1	2	3	4	5	6
1:	1					
2:	A	B	C	2		
3:	D	E	F	3		
4:	G	H	I	4		
5:	J	K	L	5		
6:	M	N	O	6		
7:	P	Q	R	S	7	
8:	T	U	V	8		
9:	W	X	Y	Z	9	
0:	0					
*:	*					
#:	&	'	,	-	.	#

4. When you finish entering the name, press **SEL** or **PROG**. The screen displays **ENTER NUMBER**.
5. Enter the telephone number. Use **◀** to backspace and make a correction. Press **REDIAL/PAUSE** to store a pause if necessary.
— OR —
Press **REDIAL/PAUSE** to display the last number dialed.
6. Press **SEL** or **PROG**. The screen displays **DISTINCT RING?** and the current setting.
7. Press **◀** or **▶** to change the setting. Choose **Y** (yes) if you wish the phone to

Telephone Directory

alert you to calls from this number by changing to a distinctive ringer after the first ring. Choose **N** (no) for a normal ringer.

- Press **SEL** or **PROG** to confirm your selection. If you chose **Y** in step 7, a  will be displayed with the directory entry.

NOTE: When the memory is full the screen will display **MEMORY FULL**, an error tone sounds and you will not be able to store a new number until you delete a stored number to make room for another entry.

Edit a Number/Name Stored in the Directory

- Press **▶** (**DIR**). The screen displays **DIRECTORY**.
- Press **◀** or **▶** to scroll alphabetically through entries stored in directory.
— **OR** —
Press the dial pad key for the first letter of the entry you want to edit.
- When the screen displays the entry you want to edit, press **SEL**. **EDIT** flashes on the screen.



SPEED EDIT ERASE
800-595-9511

- Press **SEL**. The screen displays the name and number. The flashing cursor appears at the end of the name. Use **◀**, **▶** and the dial pad keys to edit the name. Press **SEL** to confirm and move on to edit the number. Use **◀** to backspace and make corrections. Press **SEL** to confirm and move to edit the Distinctive Ring setting.
- Press **SEL** to save the edited information.

Delete a Number/Name Stored in the Directory

- Press **▶** (**DIR**). The screen displays **DIRECTORY**.
- Press **◀** or **▶** to scroll alphabetically through entries stored in directory.
— **OR** —
Press the dial pad key for the first letter of the entry you want to delete.
- When the screen displays the entry you want to delete, press **SEL**. Then press **▶** until **ERASE** flashes.



SPEED EDIT ERASE
800-595-9511

- Press **SEL**. The screen displays **ERASE NO YES** and the number. The current choice flashes.
- Press **▶** until **YES** flashes.
- Press **SEL**. You'll hear a confirmation beep.

Telephone Directory

Move a Number/Name to Speed Dial Memory

1. Press ► (DIR). The screen displays **DIRECTORY**.
2. Press ◀ or ▶ to scroll alphabetically through entries stored in directory.
— OR —

Press the dial pad key for the first letter of the entry you want to move.

3. When the screen displays the entry you want to move, press **SEL**. Then press ◀ until **SPEED** flashes.



SPEED EDIT ERASE
800-535-9511

4. Press **SEL**. The screen displays **ENTER 1-9**.
5. Press the key (1 through 9) to move this entry from the normal directory to the Speed Dial memory and assign the memory location. You will hear a confirmation beep. A memory location number (01 through 09) will be displayed with this entry.

Dial a Number from the Directory

1. Press ► (DIR). The screen displays **DIRECTORY**.
2. Press ◀ or ▶ to scroll alphabetically through entries stored in directory.
— OR —
Press the dial pad key for the first letter of the entry you want to dial.
Press ◀ or ▶ to scroll through the contents.
3. When the screen displays the entry you want to dial, press **PHONE**.

Caller ID Operation

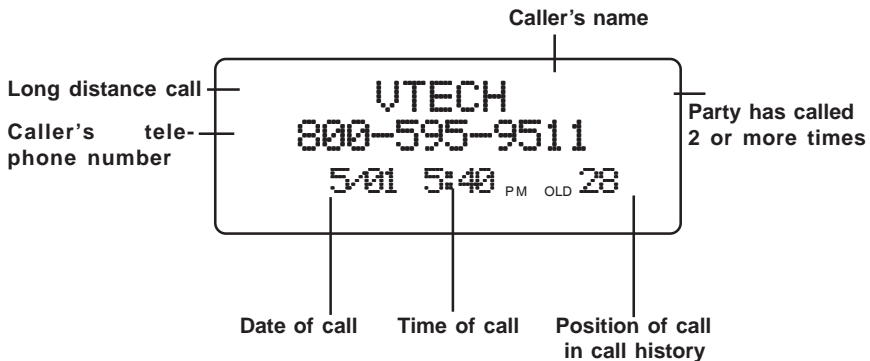

About Call History (Caller ID)

Your **t 2447** can store up to 90 calls in Caller ID memory. The most recent call will have the highest number. When the memory is full, the oldest call will be deleted to make room for new incoming call information.

For each call that comes in, the screen displays the following information between the first and second rings:

- Your caller's name (up to 15 letters are sent by your telephone company).
- The caller's area code and telephone number.
- The time and date of the call.
- The repeat Tag (*:*) in the upper right corner, indicating the party has called more than once.

If you answer a call before the information appears on the screen, it will not be in the call history.

NOTE: Press **OFF** at any time to exit call history.

Review Call History

1. Press **◀ (CID)** to view call history.
2. Use **◀** or **▶** to scroll through records in call history.

Delete Records from Call History

Delete a Specific Call:

1. Locate the record you want to delete from call history.
2. Press **DELETE**. You'll hear a confirmation beep.

Delete All Calls:

1. With the Handset in idle (**OFF**) mode, press and hold **DELETE**. The screen displays **ERASE ALL NO YES**. The current choice flashes.
2. Press **▶** until **YES** flashes.
3. Press **SEL**. You will hear a confirmation beep.

Caller ID Operation

Dial a Displayed Number

1. Locate the record in call history you want to dial.
2. If you wish to change how the number is dialed, press **#**. The screen displays any alternate dialing sequences available for this call (area code + number; 1 + area code + number; number only; 1+ number).
3. Press **SEL**. **DIAL** flashes in the screen.



DIAL PROGRAM
800-595-9511
5:01 5:40 PM

4. Press **SEL** again. The number is automatically dialed.
— OR —
When the number is correctly displayed for dialing, press **PHONE**.

Store a Call History Record in the Directory

1. Locate the record in the call history you want to store in the directory.
2. If you wish to change how the number is stored, press **#**. The screen displays any alternate dialing sequences available for this call (area code + number; 1 + area code + number; number only; 1+ number).
3. Press **SEL**, then press **▶** until **PROGRAM** flashes.



DIAL PROGRAM
800-595-9511
5:01 5:40 PM

4. Press **SEL** three times. The screen displays:



DISTINCT RING? N
800-595-9511
5:01 5:40 PM

5. Press **◀** or **▶** to select **Y** or **N** for distinctive ringer.
6. Press **SEL**. You will hear a confirmation beep. If you choose **Y** in step 5, a **D** will be displayed with the directory entry.

Display Screen Messages

Screen Displays: When:

PRIVATE	The other party is blocking name and/or number information.
UNKNOWN	Your phone company is unable to receive information about this caller's name and/or number.
* (after the name)	This caller has called you more than once.

Answering System Operation

Audible Indicators

Your **t 2447** gives you voice prompts for feature operations and voice confirmations when you press a button or complete an operation.

Setting the Clock

1. Press **TIME/SET**. The system announces the clock setting, then announces: *"To Set Day and Time, press **TIME/SET**."*
2. Press **TIME/SET**.
3. Press **CHANGE** until the system announces the correct day, then press **TIME/SET**.
4. Press **CHANGE** until the system announces the correct hour, then press **TIME/SET**.
5. Press **CHANGE** until the system announces the correct minute, then press **TIME/SET**.
6. Press **CHANGE** until the system announces the correct year, then press **TIME/SET**. The system announces the current clock setting.

NOTES:

1. You can choose to set the time manually, or you can allow it to be set automatically with incoming Caller ID information. The time will be set automatically only if you subscribe to Caller ID service provided by your local telephone company.
2. To advance the minutes or years by increments of 10, press and hold **CHANGE**.

About Mailboxes

This answering system has three voice mailboxes. Callers using a touch tone phone can select the mailbox in which their messages will be recorded by pressing **1**, **2** or **3**. If the caller does not select a specific mailbox, their message will be recorded in Mailbox **1**.

About Announcements

- You can record two different announcements — one for normal answering and one for when you've set the system to play an announcement only.
- Use normal answering when you want the system to record callers' messages. Use **Announce Only** when you want to give information to callers without accepting messages.
- If you choose not to record an announcement, the system answers with a pre-recorded announcement.
- The normal answering pre-recorded announcement says: *"Hello. I'm unable to answer your call right now. Please leave your name, number and a message after the tone."* The **Announce Only** pre-recorded announcement says: *"Hello, I'm unable to answer your call right now. Please call again. Thank you."*
- By setting **Announce Only** to **ON** or **OFF**, you decide which announcement your callers will hear when the system answers a call (the system comes set for normal answering, with **Announce Only** turned **OFF**). See **Set Announce Only**, located in the **Feature Summary** chart later in this section, to change your announcement selection.

Answering System Operation

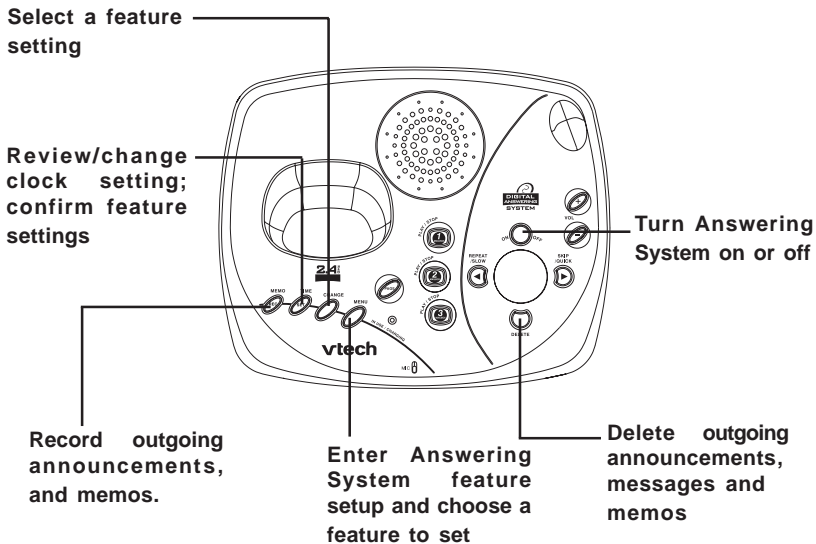

Record Your Announcement

NOTE: If you have assigned different mailboxes to different people, be sure to tell callers in your announcement to press **1**, **2**, or **3** to leave a message in the appropriate mailbox. For example: *“Thank you for calling. To leave a message for Bob, press 1 now. To leave a message for Sue, press 2 now. To leave a message for Elmo, press 3 now. Or, wait for the beep, and leave your message.”*

1. Press **MENU** until you hear *“Record Outgoing Message.”*
2. Press **MEMO/REC**. After you hear *“Now recording”* followed by a beep, speak toward the Base to record an announcement up to 90 seconds long.
3. Press any **MAILBOX** button to stop recording. The system plays back your recorded message.

To Review Your Announcement at Any Time

1. Press **MENU** until you hear *“Record Outgoing Message.”*
2. Press any **MAILBOX** button.

To Delete Your Announcement

Press **DELETE** during announcement playback. The system will use the pre-recorded announcement until you record a new one.

Answering System Operation

Setting Up Your Answering System

You can set up one feature at a time, or you can set up the first feature and then move on to set up the remaining features in sequence.

1. Make sure the answering system is **ON**.
2. Press **MENU** until the system announces the feature you want to set. Refer to the **Feature Summary** below for a description of the features and your choices.
3. Press **CHANGE** until the system announces the desired setting.
4. Press **TIME/SET** to confirm your selection.
5. Press **MENU** to move on to the next feature, or press a **MAILBOX** button to save and exit Feature Setup.

Feature Summary

System announces:	Description/directions:
"Set Security Code" 50*	Press CHANGE to choose the remote access code you will use to access features and functions of the answering system from a touch tone phone. You can select any two digit code, from 40 to 99.
"Set Audible Message Alert " Off* On	When Message Alert is turned on, the base beeps once every 10 seconds when new messages have been received.
"Set Announce Only" Off * On	When you turn Announce Only On , callers hear your announcement, but cannot leave a message.
"Set Base Ringer" On * Off	Turn the Base ringer on or off.
"Set Number of Rings" 2 4* 6 Toll Saver	Choose how many times the phone will ring before the system answers a call. With Toll Saver active, the system answers after two rings when you have new messages and after four rings when you have no new messages.

NOTES:

1. To advance the remote access code by increments of 10, press and hold **CHANGE**.
2. You can exit Feature Setup at any time by pressing a **MAILBOX** button.

Answering System Operation

Listen to, Save & Delete Messages

The system automatically saves your messages until you delete them, and can store approximately 15 minutes of messages, memos, and announcements (up to a maximum of 99 messages). Your caller can leave a message of up to 4 minutes in length.

A **MAILBOX** key will flash to alert you to new, unplayed messages. If all messages in a mailbox have been reviewed, the key will glow steadily. A mailbox containing both old and new messages will play only the new messages first. After all new messages are played, press the **MAILBOX** key again to hear all messages.

Before playing a message, the system announces the day and time it was received. While the message plays, the Message Window displays the number of the message. After playing the last message in a mailbox, the system announces "End of messages." If the system has less than five minutes of recording time left, it announces remaining time.

Message Window

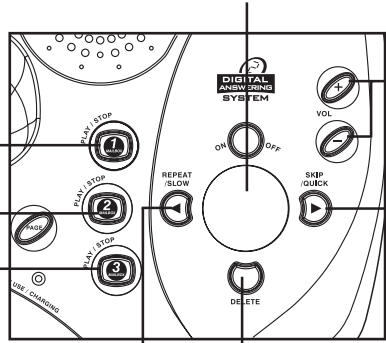

The diagram shows a control panel with several buttons and a display. The buttons are labeled: **PLAY/STOP** (three buttons), **REPEAT**, **REPEAT SLOW**, **SKIP QUICK**, **DELETE**, **ADJUST PLAYBACK VOLUME** (two knobs), and **DIGITAL ANSWERING SYSTEM**. A **ONE CHANGING** indicator is also present. Lines connect these buttons to descriptive text blocks.

Adjust Playback Volume .

Skip/Quick Messages
Press to skip to the next message; press and hold to speed up playback.

Repeat/Slow Messages
Press to repeat a message; press twice to play the previous message; press and hold to slow down playback.

Delete Messages
To delete a message, press **DELETE** while the message is playing.
Press **DELETE** then press a **MAILBOX** button to delete all old messages in that mailbox.
You cannot delete a message until it's been reviewed; deleted messages cannot be recovered.

Play Messages
Press to play messages in a mailbox. Press again to stop playback.

Answering System Operation

Call Screening/Intercept

1. Make sure the answering system is **ON**, and set the message playback volume is set above level 1 so you can hear the caller's message.
2. If you decide to take the call, press **PHONE** on the Handset.
3. If you pick up an extension phone during the announcement and the announcement does not stop right away, press and release the telephone switchhook.

Record a Memo

You can record a memo up to four minutes long, which is stored as an incoming message.

1. Press and release **REC/MEMO**.
2. Press a **MAILBOX** button to select a mailbox for the memo. After the beep, speak toward the microphone. The Message Window displays the length of your memo.
3. To stop recording, press the **MAILBOX** button again.

Message Window Display

Window Display: when:

0	No messages in any mailbox.
1 - 99	Total number of messages in all mailboxes, or current message number during message playback.
0 - 99 ↔ F	Memory is full, or total number of messages is 99.
Counting 1 to 99	Duration of memo recording or announcement (up to 90 seconds).
99, (flashing)	Length of recording is more than 99 seconds.
1 - 8, (steady for one second)	Indicates volume level selected when VOL - or VOL + is pressed.
40 - 99	Current Remote Access Code while setting.
A	Announce Only mode.
ON or OF, steady for one second	Displayed when any setting is changed from on or off.
CL ↔	Clock needs to be set.
--	System is answering a call or is in remote operation.
--, (flashing)	System is in programming mode or initializing.

Answering System Operation

Connect with the Answering System From a Remote Location

You can access many features of this system remotely from a touch tone phone.

1. Dial your telephone number.
2. When the system answers, enter your Remote Access Code (preset to **50**).
The system beeps once and then announces the number of new messages.
3. Enter a remote command (see **Remote Access Commands** below).
4. Press ***0** to exit remote operation.

Voice Menu

The system has voice prompts to help you with remote operation. Press ***5** to hear the menu while remotely connected to the answering system.

Remote Access Commands

Function:	Command:
Play messages	Press # , then the appropriate mailbox number (1, 2 or 3). The system plays new messages. If there are no new messages, the system plays old messages.
Repeat a message	Press #4 while message is playing; press #4#4 to back up to previous message.
Skip a message	Press #6 while message is playing to advance to the next message.
Stop	Press #5 .
Save messages	Hang up.
Delete message	Press #9 while message is playing.
Review announcement	Press #7 ; system plays announcement, then beeps.
Record announcement	Press *7 ; after beep, record announcement, press #5 to stop. System plays back announcement.
Record memo	Press *8 , then mailbox number where you want memo recorded; speak after the beep; press #5 when finished.
End remote access call	Press *0 .

Answering System Operation

Remote Access Commands (continued)

Function:	Command:
Turn system off	Press #0 ; the system announces, " <i>Answering machine off.</i> " Press #0 again to turn the system back on.
Turn system on	When system is off, it answers after 10 rings and announces, " <i>Please enter your security code.</i> " Enter your access code, then press # 0 .

NOTE: If no key is pressed within 10 seconds of entering remote access, the voice menu will be announced. After the voice menu announcement, if no key is pressed within 20 seconds, the remote access call will automatically end.

Batteries

Battery Care and Maintenance

- Maximum talk time on a fully charged battery is approximately six hours. Maximum standby time is seven days.
- The Battery needs charging when:
 - A new battery is installed in the Handset.
 - The phone beeps twice every five seconds.
 - The screen displays **BATTERY LOW** and the low battery icon.
- Place the Handset in the base so the **CHARGING** light turns on. The Battery is typically fully charged in 10 hours.
- You can keep the battery fully charged by returning the Handset to the base after each use.
- If you repeatedly get a low battery indicator, even after charging overnight, the battery should be replaced.

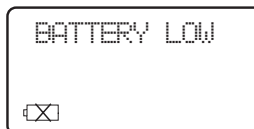

CAUTION: To reduce the risk of fire or injury to persons or damage to the telephone, read and follow these instructions carefully:
Charge the battery provided with or identified for use with this product only in accordance with the instructions and limitations specified in the User's Manual.

Replacing the Handset Battery

1. Remove the battery compartment cover on the Handset by pressing on the indentation and sliding the cover downward.
2. Lift out the old battery and disconnect.
3. Align the two holes in the new battery's plug with the socket pins, and snap the plug into place. Snap the battery in the compartment, as described in the Installation section (see page 7).
4. Replace the cover by sliding it up into place.
5. The new battery must be charged before using the phone. Place the Handset in the Base and allow it to charge for at least 12 hours the first charge. The telephone might operate before that, but for best performance, let the battery charge fully.

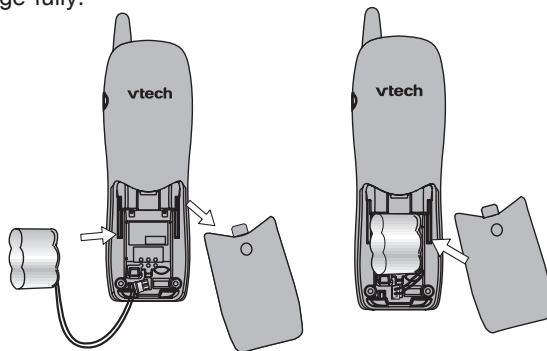

Headset Operation

Your **t 2447** Handset is equipped with a 2.5mm Headset Jack for use with an optional accessory Headset for handsfree operation. If you choose to use the Headset option, you must obtain an optional accessory Headset, which is compatible with the **t 2447**.

To purchase a Headset, call VTech Customer Service at 1-800-595-9511.

Once you have a compatible 2.5mm Headset, locate the Headset Jack on the **t 2447** Handset. Connect the plug on the Headset cord to the jack (under a small rubber flap) on the cordless Handset. The plug should fit securely. Do not force the connection.

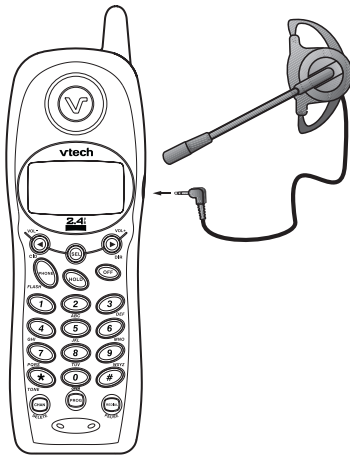

NOTE:

Whenever a compatible Headset is connected to the cordless Handset, the microphone on the Handset will be muted. This is done to limit the effect of background noise.

Belt Clip

The **t 2447** is also equipped with a detachable belt clip. Align the pins on the inside edge of the clip with the notches on the sides of the Handset. The belt clip should snap securely into place. Do not force the connection.

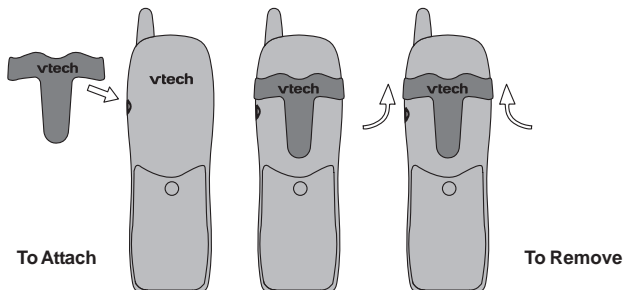

In Case of Difficulty

If you have difficulties in operating your phone, the suggestions below should solve the problem. If you still have difficulties after trying these suggestions, call VTECH Communications at 1-800-595-9511. In Canada, call VTECH Telecommunications Canada Ltd. at 1-800-267-7377.

The phone doesn't work at all

- Make sure the Power Cord is plugged in.
- Make sure the telephone line cord is plugged firmly into the Base Unit and the telephone wall jack.
- Make sure the battery is properly charged. If you get a **BATTERY LOW** message or indication, the battery needs charging.

No dial tone

- First check all the suggestions above.
- If you still don't hear a dial tone, disconnect the Base Unit from the telephone jack and connect a different phone. If there is no dial tone on that phone either, the problem is in your wiring or local service. Contact your local telephone company.

You get noise, static, or a weak signal even when you're near the Base Unit

- Household appliances plugged into the same circuit as the Base Unit can sometimes cause interference. Try to move the appliance or the Base Unit to another outlet.

You get noise, static, or a weak signal when you are away from the Base Unit

- You may be out of range. Either move closer to the Base, or relocate the Base Unit.
- The layout of your home may be limiting the range. Try to move the Base Unit to another position.

The Handset does not ring when you receive a call

- Make sure you have the ringers activated. Refer to the section(s) on **Handset Ringer Style/ Battery Save** (see page 12) in this User's Manual.
- Make sure the telephone cord is plugged firmly into the Base Unit and the telephone jack. Make sure the power cord is plugged in.
- You may be too far from the Base Unit.
- You may have too many extension phones on your telephone line to allow all of them to ring. Try to unplug some of the other phones.

You hear other calls while using your phone

- Disconnect your Base Unit from the telephone jack, and plug in a regular telephone. If you still hear other calls, the problem is probably in your wiring or local service. Call your local telephone company.

In Case of Difficulty

You hear noise in the Handset, and none of the keys or buttons work

- Make sure the power cord is plugged in.

Common cure for electronic equipment

If the unit does not seem to be responding normally, then try putting the Handset in the cradle. If it does not seem to respond, do the following (in the order listed):

1. Disconnect the power to the Base.
2. Disconnect the Handset battery.
3. Wait a few minutes.
4. Connect power to the Base.
5. Re-install the battery.
6. Wait for the Handset to re-establish its link with the Base. To be safe, allow up to one minute for this to take place.

Your answering system is not recording messages

- Make sure system is turned on (the **ON/OFF** key is illuminated).
- Make sure **Announce Only** feature is set to **OFF**.

You cannot hear recorded messages

- Using the Base volume control, raise the volume to a comfortable listening level.

CL is flashing in the Base Message Window Display

- You need to set the day and time. Refer to the section on **Set the Clock** (see page 23) in this User's Manual.

Maintenance

Taking care of your telephone

Your cordless telephone contains sophisticated electronic parts, so it must be treated with care.

Avoid rough treatment

Place the Handset down gently. Save the original packing materials to protect your telephone if you ever need to ship it.

Avoid water

Your telephone can be damaged if it gets wet. Do not use the Handset outdoors in the rain, or handle it with wet hands. Do not install your Base Unit near a sink, bathtub or shower.

Electrical storms

Electrical storms can sometimes cause power surges harmful to electronic equipment. For your own safety, use caution when using electric appliances during storms.

Cleaning your telephone

Your telephone has a durable plastic casing that should retain its luster for many years. Clean it only with a soft cloth slightly dampened with water or a mild soap. Do not use excess water or cleaning solvents of any kind.

Remember that electrical appliances can cause serious injury if used when you are wet or standing in water. If your Base Unit should fall into water, **DO NOT RETRIEVE IT UNTIL YOU UNPLUG THE POWER CORD AND TELEPHONE LINE CORDS FROM THE WALL.** Then pull the unit out by the unplugged cords.

Warranty Statement

What does this limited warranty cover?

- The manufacturer of this VTech product, VTech Communications, warrants to the holder of a valid proof of purchase (“Consumer” or “you”) that the product and all accessories provided by VTech in the sales package (“Product”) are free from material defects in material and workmanship, pursuant to the following terms and conditions, when installed and used normally and in accordance with operation instructions. This limited warranty extends only to the Consumer for Products purchased and used in the United States of America.

What will VTech Communications do if the Product is not free from material defects in materials and workmanship during the limited warranty period (“Materially Defective Product”)?

- During the limited warranty period, VTech’s authorized service representative will repair or replace at VTech’s option, without charge, a Materially Defective Product. If we repair this product, we may use new or refurbished replacement parts. If we choose to replace this product, we may replace it with a new or refurbished product of the same or similar design. VTech will return repaired or replacement products to you in working condition. VTech will retain defective parts, modules, or equipment. Repair or replacement of Product, at VTech’s option, is your exclusive remedy. You should expect the repair or replacement to take approximately 30 days.

How long is the limited warranty period?

- The limited warranty period for the product extends for ONE (1) YEAR from the date of purchase if we repair or replace a Materially Defective Product under the terms of this limited warranty. This limited warranty also applies to repaired or replacement Products for a period of either (a) 90 days from the date the repaired or replacement Product is shipped to you or (b) the time remaining on the original one-year warranty; whichever is longer.

What is not covered by this limited warranty?

This limited warranty does not cover:

1. Product that has been subjected to misuse, accident, shipping or other physical damage, improper installation, abnormal operation or handling, neglect, inundation, fire, water or other liquid intrusion; or
2. Product that has been damaged due to repair, alteration or modification by anyone other than an authorized service representative of VTech; or
3. Product to the extent that the problem experienced is caused by signal conditions, network reliability or cable or antenna systems; or
4. Product to the extent that the problem is caused by use with non-VTech electrical accessories; or
5. Product whose warranty/quality stickers, Product serial numbers plates or electronic serial numbers have been removed, altered or rendered illegible; or
6. Product purchased, used, serviced or shipped for repair from outside the United

Warranty Statement

States, or used for commercial or institutional purposes (including but not limited to Products used for rental purposes); or

7. Product returned without valid proof of purchase (see 2 below); or
8. Charges for installation or set up, adjustment of customer controls and installation or repair of systems outside the unit.

How do you get warranty service?

- To obtain warranty service in the United States of America, call 1-800-595-9511 for instructions regarding where to return the Product. Before calling for service, please check the user's manual. A check of the Product controls and features may save you a service call.
- Except as provided by applicable law, you assume the risk of loss or damage during transit and transportation and are responsible for delivery or handling charges incurred in the transport of Product(s) to the service location. VTech will return repaired or replaced product under this limited warranty to you, transportation, delivery or handling charges prepaid. VTech assumes no risk for damage or loss of the Product in transit.
- If the Product failure is not covered by this limited warranty, or proof of purchase does not meet the terms of this limited warranty, VTech will notify you and will request that you authorize the cost of repair prior to any further repair activity. You must pay for the cost of repair and return shipping costs for the repair of Products that are not covered by this limited warranty.

What must you return with the Product to get warranty service?

1. Return the entire original package and contents including the Product to the VTech service location along with a description of the malfunction or difficulty;
2. Include "valid proof of purchase" (sales receipt) identifying the Product purchased (Product model) and the date of purchase or receipt; and
3. Provide your name, complete and correct mailing address, and telephone number.

Other Limitations

- This warranty is the complete and exclusive agreement between you and VTech. It supersedes all other written or oral communications related to this Product. VTech provides no other warranties for this product. The warranty exclusively describes all of VTech's responsibilities regarding the product. There are no other express warranties. No one is authorized to make modifications to this limited warranty and you should not rely on any such modification.

State Law Rights: This warranty gives you specific legal rights, and you may also have other rights which vary from state to state.

Limitations: Implied warranties, including those of fitness for a particular purpose and merchantability (an unwritten warranty that the product is fit for ordinary use) are limited to one year from date of purchase. Some states do

Warranty Statement

not allow limitations on how long an implied warranty lasts, so the above limitation may not apply to you.

- In no event shall VTech be liable for any indirect, special, incidental, consequential, or similar damages (including, but not limited to lost profits or revenue, inability to use the product, or other associated equipment, the cost of substitute equipment, and claims by third parties) resulting from the use of this product. Some states do not allow the exclusion or limitation of incidental or consequential damages, so the above limitation or exclusion may not apply to you.

FCC, ACTA and IC Regulations

This equipment complies with Parts 15 of the Federal Communications Commission (FCC) rules for the United States. It also complies with regulations RSS210 and CS-03 of Industry and Science Canada. Operation is subject to the following two conditions: (1) this device may not cause interference, and (2) this device must accept any interference, including interference that may cause undesired operation of the device.

A label is located on the underside of the Base Unit containing either the FCC registration number and Ringer Equivalence Number (REN) or the IC registration number and Load Number. You must, upon request, provide this information to your local telephone company.

This equipment is compatible with inductively coupled hearing aids. Should you experience trouble with this telephone equipment, please contact:

VTech Communications, Inc.

Customer Service at 1-800-595-9511. In Canada, call VTech Telecommunications Canada Ltd., at 1-800-267-7377.

For repair/warranty information, the telephone company may ask you to disconnect this equipment from the line network until the problem has been corrected.

FCC Part 15

Warning: Changes or modifications to this unit not expressly approved by the party responsible for compliance could void the user's authority to operate the equipment.

The equipment has been tested and found to comply with part 15 of the FCC rules. These limits are designed to provide reasonable protection against harmful interference in a residential installation. This equipment generates, uses and can radiate radio frequency energy and, if not installed and used in accordance with the instructions, may cause harmful interference to radio communications. However, there is no guarantee that interference will not occur in a particular installation. If this equipment does cause harmful interference to radio or television reception, which can be determined by turning the equipment off and on, the user is encouraged to try and correct the interference by one or more of the following measures:

- Reorient or relocate the receiving antenna.
- Increase the separation between the equipment and receiver.
- Connect the equipment into an outlet or on a circuit different from that to which the receiver is connected.
- Consult the dealer or an experienced radio/TV technician for help.

FCC Part 68 and ACTA

If this equipment was approved for connection to the telephone network prior to July 23, 2001, it complies with Part 68 of the Federal Communications Commission (FCC) rules. If the equipment was approved after that date, it complies with the Part 68 rules and with Technical Requirements for Connection of Equipment to the Telephone Network adopted by the Administrative Council for Terminal Attachments (ACTA). We are required to provide you with the following information.

FCC, ACTA and IC Regulations

1. Product identifier and REN information

The label on the back or bottom of this equipment contains, among other things, an identifier indicating product approval and the Ringer Equivalence Number (REN). This information must be provided to your local telephone company upon request. For equipment approved prior to July 23, 2001, the product identifier is preceded by the phrase "FCC Reg No." and the REN is listed separately. For equipment approved after that date, the product identifier is preceded by "US" and a colon (:), and the REN is encoded in the product identifier without a decimal point as the sixth and seventh characters following the colon. For example, the product identifier US:AAAEQ03T123XYZ would indicate an REN of 0.3.

The REN is used to determine how many devices you may connect to your telephone line and still have them ring when you are called. In most, but not all areas, the sum of all RENs should be five (5.0) or less. For more information, please contact your local telephone company.

2. Connection and use with the nationwide telephone network

The plug and jack used to connect this equipment to the premises wiring and the telephone network must comply with the applicable Part 68 rules and technical requirements adopted by ACTA. A compliant telephone cord and modular plug is provided with this product. It is designed to be connected to a compatible modular jack that is also compliant. An RJ11 jack should normally be used for connecting to a single line and an RJ14 jack for two lines. See Installation Instructions in the user's manual. This equipment may not be used with Coin Telephone Lines or with Party Lines. If you have specially wired alarm dialing equipment connected to your telephone line, ensure the connection of this equipment does not disable your alarm equipment. If you have questions about what will disable alarm equipment, consult your telephone company or a qualified installer.

3. Repair instructions

If this equipment is malfunctioning, it must be unplugged from the modular jack until the problem has been corrected. Repairs to this telephone equipment can only be made by the manufacturer or its authorized agents. For repair procedures, follow the instructions outlined under the Limited Warranty.

4. Rights of the telephone company

If this equipment is causing harm to the telephone network, the telephone company may temporarily discontinue your telephone service. The telephone company is required to notify you before interrupting service. If advance notice is not practical, you will be notified as soon as possible. You will be given the opportunity to correct the problem and the telephone company is required to inform you of your right to file a complaint with the FCC. Your telephone company may make changes in its facilities, equipment, operation, or procedures that could affect the proper functioning of this product. The telephone company is required to notify you if such changes are planned.

FCC, ACTA and IC Regulations

5. Hearing aid compatibility

If this product is equipped with a corded or cordless handset, it is hearing aid compatible.

6. Programming/testing of emergency numbers

If this product has memory dialing locations, you may choose to store police, fire department and emergency medical service telephone numbers in these locations. If you do, please keep three things in mind:

- a We recommend that you also write the telephone number on the directory card, so that you can still dial the emergency number manually if the memory dialing feature doesn't work.
- b This feature is provided only as a convenience, and the manufacturer assumes no responsibility for customer reliance upon the memory feature.
- c Testing the emergency telephone numbers you have stored is not recommended. However, if you do make a call to an emergency number:
 - You must remain on the line and briefly explain the reason for the call before hanging up.
 - Programming/testing of emergency numbers should be performed during off-peak hours, such as in the early morning or late evening, when the emergency services tend to be less busy.

IC (Industry Canada)

This telephone is registered for use in Canada.

The term "IC:" before the radio certification number only signifies that Industry Canada technical specifications were met.

Notice: This equipment meets the applicable Industry Canada Terminal Equipment Technical Specifications. This is confirmed by the registration number. The abbreviation, IC, before the registration number signifies that registration was performed based on a Declaration of Conformity indicating that Industry Canada technical specifications were met. It does not imply that Industry Canada approved the equipment.

Notice: The Ringer Equivalence Number (REN) for this terminal equipment is 0.1. The REN assigned to each terminal equipment provides an indication of the maximum number of terminals allowed to be connected to a telephone interface. The termination on an interface may consist of any combination of devices subject only to the requirement that the sum of the Ringer Equivalence Numbers of all the devices does not exceed five.

Before installing this equipment, users should ensure that it is permissible to be connected to the facilities of the local telecommunications company. The equipment must also be installed using an acceptable method of connection. The customer should be aware that compliance with the above conditions may not prevent degradation of services in some situations.

FCC, ACTA and IC Regulations

Repairs to certified equipment should be made by an authorized Canadian maintenance facility designated by the supplier. Any repairs or alterations made by the user to this equipment, or equipment malfunctions, may give the telecommunications company cause to request the user to disconnect the equipment.

Users should ensure for their own protection that the electrical ground connections of the power utility, telephone lines and internal metallic water pipe system, if present, are connected together. This precaution may be particularly important in rural areas.

Caution: Users should not attempt to make such connections themselves, but should contact the appropriate electrical inspection authority, or electrician, as appropriate.

Your telephone is designed to operate at the maximum power allowed by the FCC and IC. This means your Handset and Base Unit can communicate only over a certain distance - which will depend on the location of the Base Unit and Handset, weather, and the construction and layout of your home or office.

The RBRC® Seal



The **RBRC®** Seal on the nickel-cadmium battery indicates that VTech Communications, Inc. is voluntarily participating in an industry program to collect and recycle these batteries at the end of their useful lives, when taken out of service within the United States and Canada.

The **RBRC®** program provides a convenient alternative to placing used nickel-cadmium batteries into the trash or municipal waste, which may be illegal in your area.

VTech's participation in **RBRC®** makes it easy for you to drop off the used battery at local retailers participating in the **RBRC®** program or at authorized VTech product service centers. Please call **1-800-8-BATTERY™** for information on Ni-Cd battery recycling and disposal bans/restrictions in your area. VTech's involvement in this program is part of its commitment to protecting our environment and conserving natural resources.

RBRC® is a registered trademark of Rechargeable Battery Recycling Corporation.

Technical Specifications

FREQUENCY CONTROL

Crystal controlled
PLL synthesizer

TRANSMIT FREQUENCY

Base: 2410.2 - 2418.9 MHz
Handset: 912.75 - 917.10 MHz

RECEIVE FREQUENCY

Base: 912.75 - 917.10 MHz
Handset: 2410.2 - 2418.9 MHz

CHANNELS

30 Channels

NOMINAL EFFECTIVE RANGE

Maximum power allowed by FCC and IC. Actual operating range may vary according to environmental conditions at the time of use.

SIZE

Handset: 186.01mm x 56.01mm x 36.36mm
Base: 171mm x 140.52mm x 90.09mm

WEIGHT

Handset: 188 grams
Base: 345 grams

POWER REQUIREMENTS

Handset: 3.6V 400mAh Ni-Cd Battery Pack
Base: 9V DC @ 400mA

MEMORY

Speed Dial: 9 Memory locations; up to 24 digits, 15 characters per location
Directory: 50 Memory locations; up to 24 digits, 15 characters per location
CID: 90 Memory locations

SPECIFICATIONS ARE TYPICAL AND MAY CHANGE WITHOUT NOTICE.

Table Of Contents

Important Safety Instructions.....	1
Before You Begin.....	3
Parts Check List.....	4
The Handset Layout.....	5
The Base Unit Layout.....	6
Getting Started.....	7
Installation.....	7
Before You Install.....	7
Table/Desk Installation.....	8
Wall Mounting.....	9
Basic Operation.....	10
Telephone Operation.....	10
Handset Ringer Style/Battery Save	12
Set Dial Mode.....	12
Set Language.....	12
Temporary Tone Dialing.....	12
Call Forward.....	12
Display Screen Messages	13
Speed Dial	14
Store a Number/Name in Memory	14
Edit a Number/Name Stored in Memory	15
Delete a Number/Name Stored in Memory	15
Dial a Speed Dial Entry	15
Reassign Locations in Memory	16
Telephone Directory.....	17
Store a Number/Name in the Directory	17
Edit a Number/Name Stored in the Directory	18
Delete a Number/Name Stored in the Directory	18
Move a Number/Name to Speed Dial Memory	19
Dial a Number from the Directory	19
Caller ID Operation.....	20
About Call History(Caller ID).....	20
Review Call History.....	20
Delete Records from Call History.....	20
Dial a Displayed Number.....	21
Store a Call History Record in the Directory.....	21
Display Screen Messages.....	21
Answering System Operation	22
Audible Indicators	22
Setting the Clock.....	22
About Mailboxes	22
About Announcements.....	22
Record Your Announcement	23
Setting up Your Answering System.....	24

Table Of Contents

Feature Summary.....	24
Listen to, Save & Delete Messages.....	25
Call Screening/Intercept	26
Record a Memo	26
Message Window Display	26
Connect with the Answering System From a Remote Location.....	27
Voice Menu.....	27
Remote Access Commands	27
Batteries.....	29
Battery Care and Maintenance.....	29
Replacing the Handset Battery	29
Headset Operation.....	30
Belt Clip.....	30
Additional Information.....	31
In Case of Difficulty.....	31
Maintenance.....	33
Warranty Statement.....	34
FCC, ACTA and IC Regulations.....	37
The RBRC® Seal.....	41
Technical Specifications.....	42

vtech

VTECH TELECOMMUNICATIONS LTD.

vtech A member of THE VTECH GROUP OF COMPANIES.

Distributed in the U.S.A. by VTech Communications, Inc. Beaverton,
Oregon, 97008

Distributed in Canada by VTech Telecommunications Canada Ltd. 7671
Alderbridge Way, Richmond, B.C. V6X 1Z9.

Copyright 2004 for VTECH TELECOMMUNICATIONS LTD.
Printed in China

91-5792-10-00
ISSUED 0

Replacement Battery Order Form

Part Number (Description)	QTY	X	Price	=	Subtotal
---------------------------	-----	---	-------	---	----------

80-5074-01-00
(SBA Series Battery, 3.6V 400mAh Ni-Cd) _____ x \$14.95 = _____

For orders up to \$80, add \$6.95 Shipping _____

For orders over \$80, add \$9.95 Shipping _____

+ Sales Tax (if applicable) _____

TOTAL _____

SHIPPING INFORMATION

NAME _____

ADDRESS _____

CITY _____ STATE _____ ZIP _____

DAY TIME PHONE () _____

DELIVERY IS LIMITED TO THE CONTINENTAL US, ALASKA, HAWAII, PUERTO RICO, AND THE US VIRGIN ISLANDS. NO DELIVERY TO PO BOXES OR APO ADDRESSES.

METHOD OF PAYMENT: DO NOT SEND CASH

CHECK

MONEY ORDER

VISA

MASTERCARD

AMERICAN EXPRESS

DISCOVER

Checks and Money Orders should be made payable to VTech Communications, Inc.

BILLING INFORMATION

CREDIT CARD # _____

EXPIRATION DATE _____ SECURITY CODE* _____

CARDHOLDER'S SIGNATURE _____

BILLING ADDRESS IF PAYING BY CREDIT CARD (as it appears on your credit card statement)

NAME _____

ADDRESS _____

CITY _____ STATE _____ ZIP _____

*The last three or four digits on the signature strip (back side) of your credit card.

Place order form and payment in envelope and send to:

VTech Communications, Inc.
PO Box 178
Valley Park, MO 63088-0178

You may also order online at
www.vtechphones.com
or by calling 1-800-595-9511



Free Manuals Download Website

<http://myh66.com>

<http://usermanuals.us>

<http://www.somanuals.com>

<http://www.4manuals.cc>

<http://www.manual-lib.com>

<http://www.404manual.com>

<http://www.luxmanual.com>

<http://aubethermostatmanual.com>

Golf course search by state

<http://golfingnear.com>

Email search by domain

<http://emailbydomain.com>

Auto manuals search

<http://auto.somanuals.com>

TV manuals search

<http://tv.somanuals.com>