

DIGITAL 900MHZ
CORDLESS PHONE
MODEL VT 1900

VT 1900

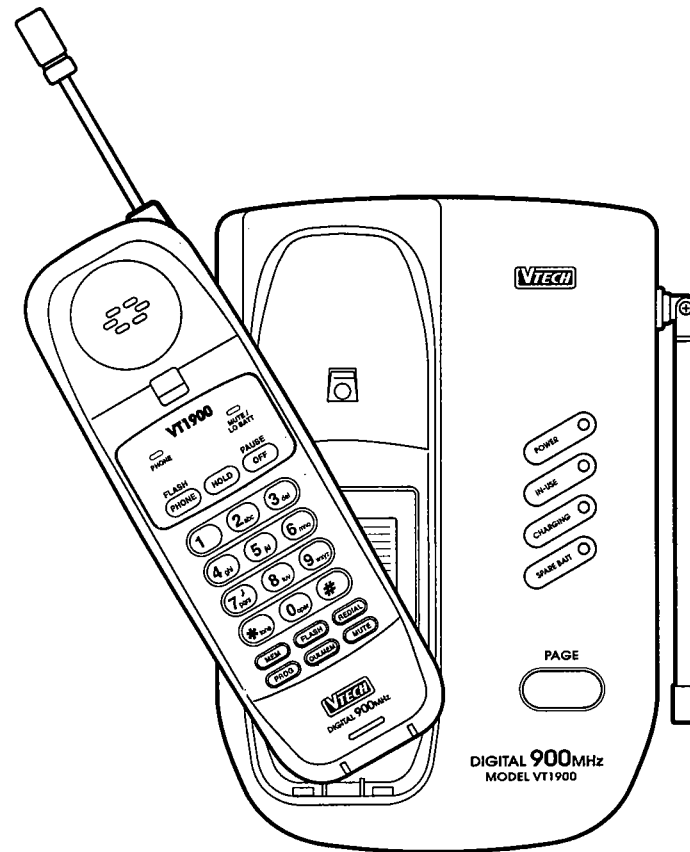

VTECH COMMUNICATIONS LTD.



Is a trademark of VTECH COMMUNICATIONS LTD., a member of THE VTECH GROUP OF COMPANIES.

Distributed in the U.S.A. by VTECH Communications, 8770 SW Nimbus Avenue / Beaverton, Oregon, 97008.

Distributed in Canada by VTECH Electronics Canada Ltd., Suite 200 - 7671 Alderbridge Way Richmond, B.C. V6X 1Z9.

Copyright 1996 for VTECH COMMUNICATIONS LTD..

91-4032-10-00
ISSUE 0



VTECH COMMUNICATIONS LTD.

INSTRUCTION
manual

TABLE OF CONTENTS

	Page
INTRODUCTION	1
SPECIAL FEATURES	2
PARTS CHECK LIST	3
THE HANDSET LAYOUT	4
THE BASESET LAYOUT	5
FCC AND IC REGULATIONS	6
IMPORTANT SAFETY INSTRUCTION	9
REPLACING THE HANDSET PACK.....	11
GETTING STARTED	12
QUICK REFERENCE GUIDE	16
SPEED DIAL MEMORY	17
Memory Storing	17
Memory Dialing	17
Quick Memory Dialing	17
Using Redial.....	17
BASIC OPERATION	18
Making Calls	18
Disconnecting	18
Extension in use Indicator	18
Volume Controls	18
Flash	18
Redial	18
Hold	18
Mute	18
Ringer Mute	18
Page	18
ADVANCED FUNCTIONS	19
Temporay Tone	19
Programming The Ringer	19
Changing Ringer Types	19
Turning Off The Ringer	20
Checking The Ringer Type	20
MEMORY DIALING	21
Storing Speed Dial Numbers	21
Memory Dialing	21
Quick Memory Dialing	21
Storing Numbers Using Redial	22
Dialing From Memory	22
Changing Stored Numbers	23
Deleting Stored Numbers	23
Storing Special Codes	23
MAINTENANCE	24
OUT OF RANGE INDICATION	25
IN CASE OF DIFFICULTY	26
WARRANTY	28
TECHICAL SPECIFICATIONS	29

INTRODUCTION

Congratulations! You have purchased one of the most sophisticated cordless telephones on the market! The VTech VT1900 has been designed to offer a new standard in cordless telephone technology.

Unlike most other cordless phones, the VTech VT1900 digitizes your voice using advanced ADPCM digital voice coding to provide noise and distortion free performance. In most conditions you will not be able to tell you are using a cordless phone. Gone are the annoyances of static, interference and having to listen to other people's conversations on your cordless phone.

The VTech VT1900 scrambles your voice before it transmits it. This allows you the security of knowing that no one can tune in and eavesdrop on your conversations.

With the VTech VT1900 the user can easily answer a call on the handset by simply pressing any key other than the OFF, MUTE or Volume Keys. This is very useful in a dark environment, so that the user does not have to fumble around looking for the PHONE key to answer the call.

The VTech VT1900 also provides a one-way Page/find. Pressing the base PAGE key will cause the handset to ring in a manner which distinguishes it from normal incoming ringing. This can be used to alert the handset user or to simply locate the handset in the event that it is misplaced.

The VTech VT1900 uses special memory in both the base and handset which is not susceptible to power failures. This provides permanent storage of all speed dial numbers, as well as the base and handset security codes.

When a spare battery is installed in the base unit, the VTech VT1900 uses this battery to provide operational backup in case of power failure. In this way you have access to all normal phone functions during a total power outage. Calls can still be placed and received without interruption. More than 5 hours backup will be possible with a fully charged battery in the base unit.

The VTech VT1900 also informs you that another extension is currently off-hook on the same phone line. The phone will also alert you when you are Out of Range even when you're not using the phone!

INTRODUCTION

SPECIAL FEATURES

- 900 MHz Operation
- Fully Digital Link between Handset and Base with ADPCM voice coding
- Digitally-Scrambled Voice Communication
- 20 location Programmable Memory for 20 Digit Phone Number
- Quick MEM - automatically dials a designated number at the touch of a single key
- 10 Channel Operation with auto channel selection
- Out-of-Range indication while the handset is in use or in standby mode
- Removable handset battery pack
- Spare battery charger in the base unit
- Complete battery back-up in case of power failure (with spare battery installed in base)
- Easy answer - When the phone rings simply press any key other than OFF, MUTE, or the Volume Keys on the handset to answer
- Auto hang up when returning the handset to the base cradle
- Extension in use indicator
- 24 Bit Digital Security Code for 16.8 million combinations
- DTMF and Pulse Dialing
- Low Battery Detect and Warning indicator
- Handset Power Saving for 7 days Standby time
- 7.0 Hours continuous talk time
- Volume Adjust on Handset
- REDIAL, HOLD, PAGE and MUTE
- Hearing-Aid Compatible Receiver
- Detachable power supply Non-volatile storage of security code and speed dial memories
- Programmable Ringer Types

This manual is designed to make you familiar with the VTech VT1900. We strongly recommend you read the manual before using your phone.

INTRODUCTION

Parts Check List

1. Base unit, Handset and AC adapter
2. One-Line Telephone Cord
3. Battery Pack
4. Mounting screws for wall mounting
5. Wall mount accessory

To purchase replacement battery packs, call VTECH Communications at 1-800-624-5688. In Canada, call VTECH Electronics at 1-800-267-7377.

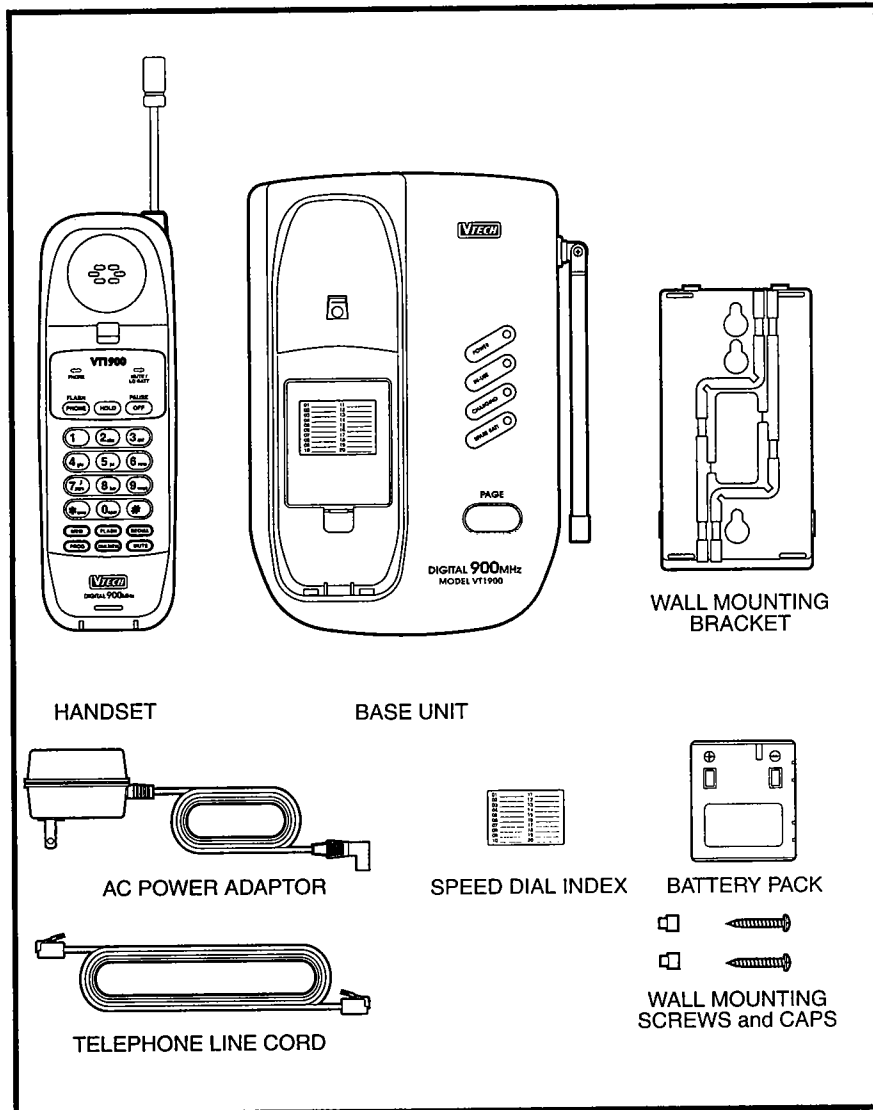

THE HANDSET LAYOUT

HANDSET UNIT CONTROLS AND FUNCTIONS

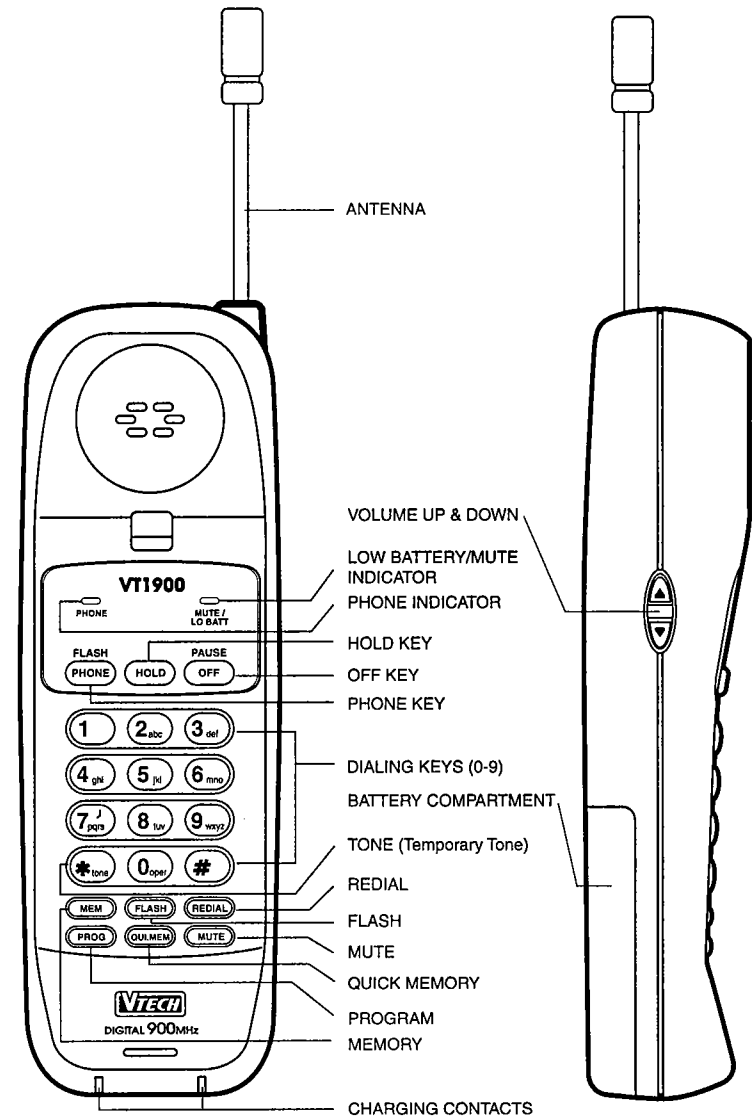

MAIN FEATURES ON HANDSET

BASE UNIT CONTROLS AND FUNCTIONS

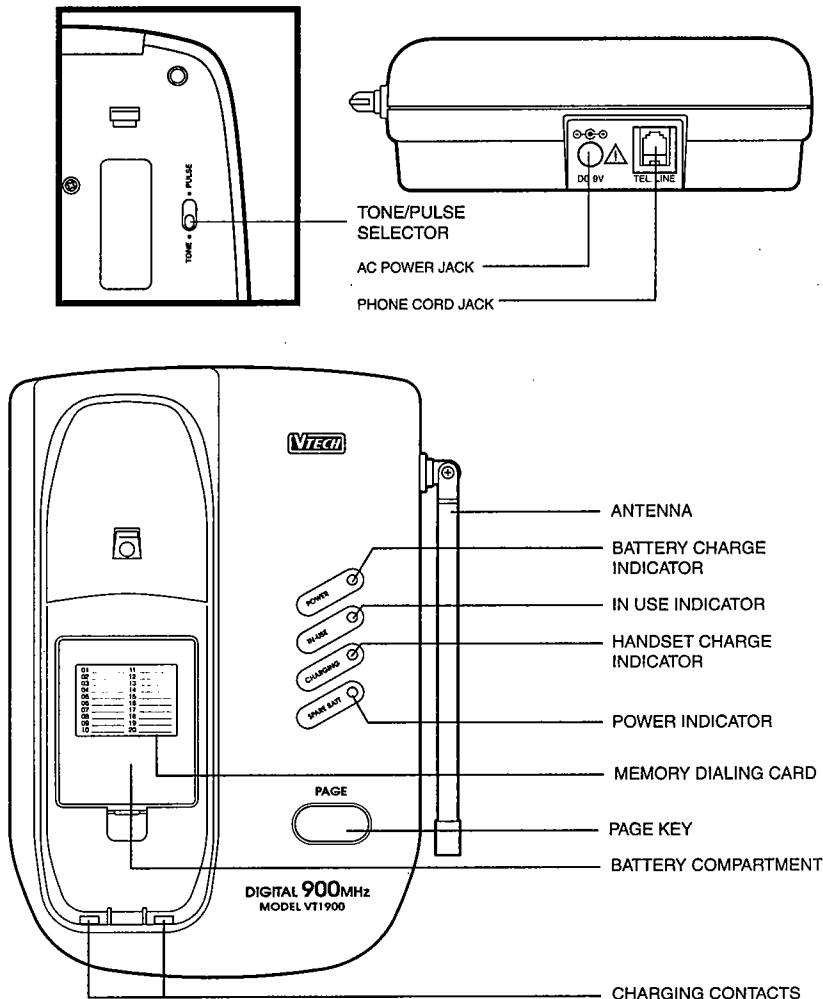

MAIN FEATURES ON BASE UNIT

This equipment complies with Parts 15 and 68 of the Federal Communications Commission (FCC) rules for the United States. It also complies with regulations RSS210 and CS-03 of Industry and Science Canada. Operation is subject to the following two conditions: (1) this device may not cause interference, and (2) this device must accept any interference, including interference that may cause undesired operation of the device.

A label is located on the underside of the base unit containing either the FCC registration number and Ringer Equivalence Number (REN) or the IC registration number and Load Number. You must, upon request, provide this information to your local telephone company.

This equipment is compatible with inductively coupled hearing aids.

Should you experience trouble with this telephone equipment, please contact:

VTECH COMMUNICATIONS
 SERVICE DEPT. at 1-800-624-5688.
 In Canada, call VTECH Electronics at 1-800-267-7377.

For repair/warranty information. The telephone company may ask you to disconnect this equipment from the line network until the problem has been corrected.

FCC Part 15

Warning: Changes or modifications to this unit not expressly approved by the party responsible for compliances could void the user's authority to operate the equipment.

The equipment has been tested and found to comply with part 15 of the FCC rules. These limits are designed to provide reasonable protection against harmful interference in a residential installation. This equipment generates, uses and can radiate radio frequency energy and, if not installed and used in accordance with the instructions, may cause harmful interference to radio communications. However, there is no guarantee that interference will not occur in a particular installation. If this equipment does cause harmful interference to radio or television reception, which can be determined by turning the equipment off and on, the user is encouraged to try and correct the interference by one or more of the following measures:

- Reorient or relocate the receiving antenna.
- Increase the separation between the equipment and receiver.
- Connect the equipment into an outlet or on a circuit different from that to which the receiver is connected.
- Consult the dealer or an experienced radio/TV technician for help.

FCC and IC Regulations

FCC Part 68

The FCC requires that you connect your cordless telephone to the nationwide telephone network through a modular telephone jack (USOC RJ11C, RJ11W or RJ14).

Your telephone company may discontinue your service if your equipment causes harm to the telephone network. They will notify you in advance of disconnection, if possible. During notification, you will be informed of your right to file a complaint with the FCC.

Occasionally, your telephone company may make changes in its facilities, equipment, operation, or procedures that could affect the operation of your equipment. If so, you will be given advance notice of the change to give you an opportunity to maintain uninterrupted service.

The base unit contains no user serviceable parts. The handset contains a user replaceable battery pack.

If it is determined that your telephone equipment is malfunctioning, the FCC requires that it not be used and that it be unplugged from the modular jack until the problem has been corrected. Repairs to this telephone equipment can only be made by the manufacturer or its authorized agents or by others who may be authorized by the FCC. For repair procedures, follow the instructions outlined under the VTECH Limited Warranty.

This equipment may not be used on coin service provided by the phone company or Party Lines.

The REN is useful in determining the number of devices you may connect to your telephone line and still enable the devices to ring when you receive a call. The general rule is that the REN value should not exceed 5.0A total; however, contact your local telephone company for the specific number in your area.

IC (Industry Canada)

This telephone is registered for use in Canada.

Notice: The LOAD NUMBER (LN) assigned to each terminal device denotes the percentage of the total load to be connected to a telephone loop which is used by the device, to prevent overloading. The termination of a loop may consist of any combination of devices subject only to the requirement that the sum of the load numbers of all devices not exceed 100.

Notice: The Industry Canada label identifies certified equipment. This certification means that the equipment meets certain telecommunications network protective, operational and safety requirements. The Department does not guarantee the equipment will operate to the user's satisfaction.

FCC and IC Regulations

Before installing this equipment, users should ensure that it is permissible to be connected to the facilities of the local telecommunications company. The equipment must also be installed using an acceptable method of connection. The customer should be aware that compliance with the above conditions may not prevent degradation of services in some situations.

Repairs to certified equipment should be made by an authorized Canadian maintenance facility designated by the supplier. Any repairs or alterations made by the user to this equipment, or equipment malfunctions, may give the telecommunications company cause to request the user to disconnect the equipment.

Users should ensure for their own protection that the electrical ground connections of the power utility, telephone lines and internal metallic water pipe system, if present, are connected together. This precaution may be particularly important in rural areas.

Caution: Users should not attempt to make such connections themselves, but should contact the appropriate electrical inspection authority, or electrician, as appropriate.

Your VTech VT1900 is designed to operate at the maximum power allowed by the FCC and IC. This means your handset and base unit can communicate only over a certain distance - which will depend on the location of the base unit and handset, weather, and the construction and layout of your home or office.

If you move the handset out of range during a phone conversation, you will hear an 'Out of Range' tone to tell you to move closer to the base. If you do not move within range within 25 seconds the call is automatically disconnected.

If you move out of range when the handset is in standby mode, it will give an 'Out of Range' tone to tell you that the handset will not be able to receive or place calls.

IMPORTANT SAFETY INSTRUCTIONS

When using your telephone equipment, basic safety precautions should always be followed to reduce the risk of fire, electric shock and injury to persons, including the following:

1. Read and understand all instructions.
2. Follow all warnings and instructions marked on the product.
3. Unplug this product from the wall outlet before cleaning. Do not use liquid cleaners or aerosol cleaners. Use a dry cloth for cleaning.
4. Do not use this product near water, for example, near a bath tub, wash bowl, kitchen sink, or laundry tub, in a wet basement, or near a swimming pool.
5. Do not place this product on an unstable cart, stand, or table. The telephone may fall, causing serious damage to the telephone.
6. Slots and openings in the cabinet and the back or bottom are provided for ventilation, to protect it from overheating, these openings must not be blocked or covered. The openings should never be blocked by placing the product on the bed, sofa, rug, or other similar surface. This product should never be placed near or over a radiator or heat register. This product should not be placed in a built-in installation unless proper ventilation is provided.

7. This product should be operated only from the type of power source indicated on the marking label. If you are not sure of the type of power supply to your home, consult your dealer or local power company.
8. Do not allow anything to rest on the power cord. Do not locate this product where the cord will be abused by persons walking on it.
9. Do not overload wall outlets and extension cords as this can result in the risk of fire or electric shock.
10. Never push objects of any kind into this product through cabinet slots as they may touch dangerous voltage points or short out parts that could result in a risk of fire or electric shock. Never spill liquid of any kind on the product.
11. To reduce the risk of electric shock, do not disassemble this product, but take it to a qualified service personnel when some service or repair work is required. Opening or removing covers may expose you to dangerous voltages or other risks. Incorrect reassembly can cause electric shock when the appliance is subsequently used.

IMPORTANT SAFETY INSTRUCTIONS

CAUTION: TO REDUCE THE RISK OF FIRE OR INJURY TO PERSONS BY BATTERY, READ AND FOLLOW THESE INSTRUCTIONS.

12. Unplug this product from the wall outlet and refer servicing to qualified service personnel under the following condition:
 - A. When the power supply cord plug is damaged or frayed.
 - B. If liquid has been spilled into the product.
 - C. If the product has been exposed to rain or water.
 - D. If the product does not operate normally by following the operating instructions. Adjust only those controls, that are covered by the operating instructions because improper adjustment of other controls may result in damage and will often require extensive work by a qualified technician to restore the product to normal operation.
 - E. If the product has been dropped or the cabinet has been damaged.
 - F. If the product exhibits a distinct change in performance.
 13. Do not use the telephone to report a gas leak in the vicinity of the leak.
1. Use only the appropriate type and size battery pack specified in the instruction manual provided for this product.
 2. Do not dispose of the battery pack in a fire. The cell may explode. Check with State and local codes for possible special disposal instructions.
 3. Do not open or mutilate the battery pack. Released electrolyte is corrosive and may cause damage to the eyes or skin. It may be toxic if swallowed.
 4. Exercise care in handling battery in order not to short the battery with conducting materials such as rings, bracelets, and keys. The battery or conductor may overheat and cause burns.
 5. Charge the battery pack provided with or identified for use with this product only in accordance with the instructions and limitations specified in the instructions manual provided for this product.
 6. Observe proper polarity orientation between the battery pack and battery charger.

SAVE THESE INSTRUCTIONS

REPLACING THE HANDSET PACK

Follow the steps below:

1. Remove the battery case cover by pressing on the ridged lines and sliding downward.

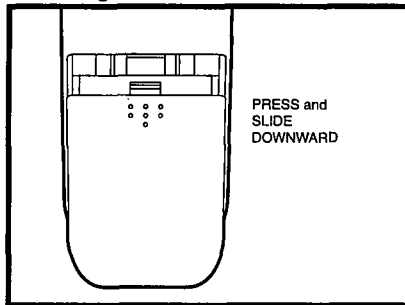

2. Discard the old battery pack. Don't put the old battery pack in a trash compactor or a fire - it could burst.

3. Place the new battery pack in its housing with the metal contacts facing down.

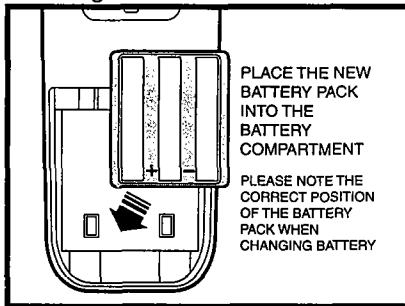

4. Replace the battery case cover by sliding the cover upwards.

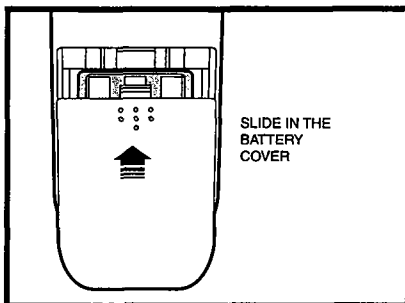

5. If the new battery pack is not already charged, place the handset in the cradle of the base unit to allow it to charge for 8 hours.

CAUTION:
To Reduce the Risk of Fire or Injury to Persons, Read and Follow the Instructions

1. Use only VTECH rechargeable battery pack.
2. Do not dispose of the battery in a fire. The cell may explode.

IMPORTANT:
Do not dispose of this battery into household garbage. For information on recycling or proper disposal, consult your local solid waste collection or disposal organization.

3. Do not open or mutilate the battery. Released electrolyte is corrosive and may cause damage to the eyes or skin. It may be toxic if swallowed.
4. Exercise care in handling batteries in order not to short the battery with conducting materials such as rings, bracelets, and keys. The battery or conductor may overheat and cause burns.

To purchase replacement battery packs, call VTECH Communications at 1-800-624-5688. In Canada, call VTECH Electronics at 1-800-267-7377.

GETTING STARTED

SETTING UP YOUR VTECH VT1900

1. Choose an area near an electrical outlet and a telephone wall jack.
2. Connect your telephone Line Cord.

AC POWER ADAPTER

Plug the AC power adapter into an electrical outlet and the DC connector to the back of the base unit.

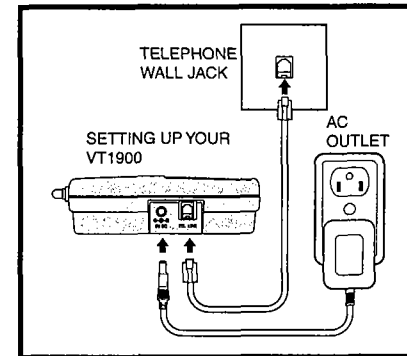

HANDSET RINGER

The handset ringer is programmed ON as the factory default setting. Refer to **PROGRAMMING THE RINGER** on page 19 for more information.

SETTING THE TONE/PULSE SWITCH

The **TONE/PULSE** switch is located on the bottom of the base unit and is factory set to **TONE**. If you have touch tone service, do not change the switch setting. If you have rotary (Pulse) service, set the switch to **PULSE**.

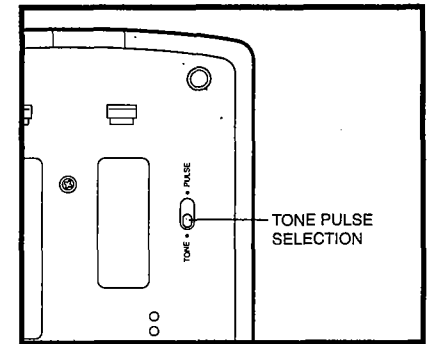

CHARGE THE HANDSET BATTERY PACK BEFORE USE

The battery pack recharges automatically whenever the handset is in the base unit. The batteries must be charged for 24 hours before using your phone for the first time.

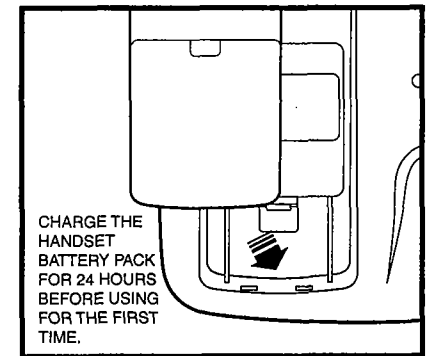

GETTING STARTED

Fill in the telephone number card on the base unit.

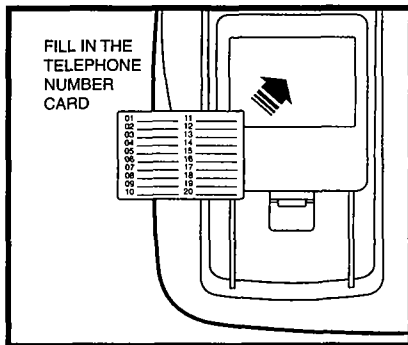

CHEAK FOR A DIAL TONE.

After the batteries are charged, pick up the handset. Now press PHONE on the handset, you should hear dial tone. If not, see 'IN CASE OF DIFFICULTY' on page 26.

CAUTION:

1. Never install telephone wiring during a lightning storm.
2. Never install telephone jacks in wet locations unless the jack is specifically designed for wet locations.
3. Never touch uninsulated telephone wires or terminals unless the telephone line has been disconnected at the network interface.
4. Use caution when installing or modifying telephone lines.

GETTING STARTED

WALL INSTALLATION USING MOUNTING SCREWS PROVIDED

Tools You Will Need: A hammer, a nail, a pencil or ballpoint pen, a Phillips head (+) screwdriver, and the Wall Mounting Template included in the back of this booklet.

1. Choose a spot near an electrical outlet and a telephone jack.

Your phone requires a modular telephone jack and a standard electrical outlet (120v AC). The power cord is six feet long; make sure there is an electrical outlet within reach of the base. The outlet should not be controlled by a wall switch. If the switch is ever turned off, the phone will not operate.

2. Choose and mark the mounting position.

The mounting screws should screw into a wooden stud within the wall—they will not hold securely in wallboard alone. Locate a wall stud in the area where you want to install your telephone. Use the Wall-Mounting Template and a pencil to mark the screw positions on the wall over the stud (Figure 1). Put the template aside.

3. Install the mounting sleeves and screws.

Start the screw holes by lightly tapping a nail into the marks you made on the wall. Remove the nail from the wall. Now slip the mounting sleeves onto the screws as

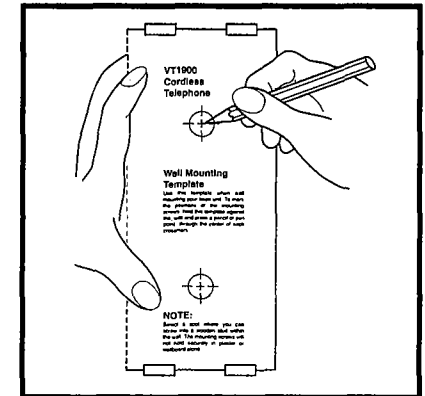

Figure 1

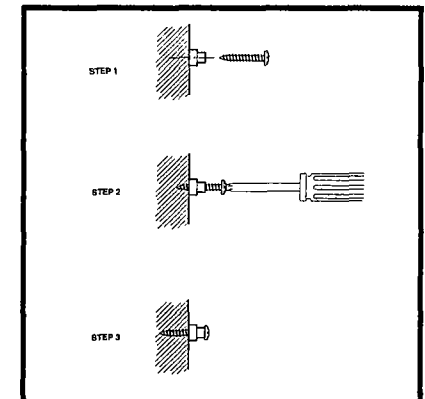

Figure 2

shown, with the smaller end of the sleeve toward the screw head. Insert the screws into the holes you started. Tighten the screws until the larger end of the mounting sleeve is flat against the wall (Figure 2).

USING THE WALL MOUNT ADAPTOR

1. Position the wall mount bracket on the base.

Line up the tabs on the wall mount adaptor with the holes on the bottom of the base (Figure 1). Snap the wall mount bracket firmly in place.

2. Mount the base on the wall.

Position the base so the mounting studs will fit into the holes on the bottom of the base. Position the power cord to extend down the wall the phone is to be mounted on. Slide the base down on the mounting studs until it locks into place.

3. Connect the telephone line cord.

The telephone line cord has a snap-in plug at each end. Insert one of the plugs into the jack on the bottom of the base. Insert the other end of the plug into the wall jack.

4. Plug the ac adaptor on the power cord into an electrical outlet (Figure 2).

5. Set the TONE/PULSE SWITCH on the base unit.

If you have touch tone service on your phone line, set the switch to TONE. If you have rotary service, set the switch to PULSE (Figure 3).

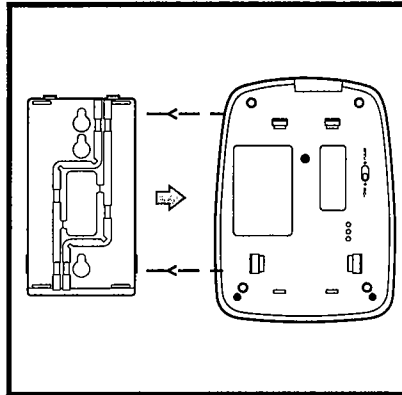

Figure 1

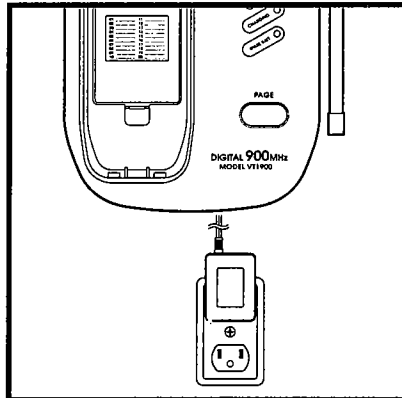

Figure 2

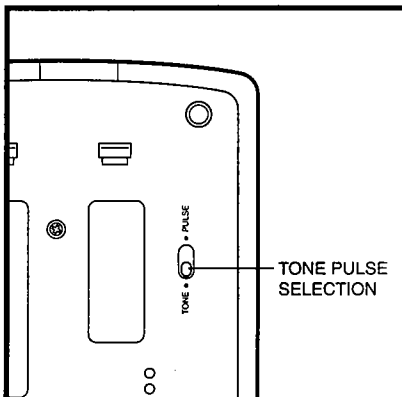

Figure 3

Here's a brief guide to the features and functions of your VTech VT1900 cordless telephone:

SET-UP

- Connect telephone line cord to base unit and telephone jack.
- Plug AC adaptor into a standard electrical outlet
- Set Dial Mode switch to **PULSE** or **TONE**. The unit is factory set to **TONE**.
- Let handset batteries charge for 24 hours before first use.

MAKING CALLS

- Press the **PHONE** key on the handset. When you hear a dial tone, dial the number.

ANSWERING CALLS

- To answer a call on the handset, press any key other than **OFF**, **MUTE**, or the Volume Keys on the handset. The handset will auto-answer when lifted off the base cradle.

HANGING UP

Press **OFF** on the handset or place the handset in the base cradle to hang up a call.

TO PLACE A CALL ON HOLD

- Press **HOLD** on the handset to place an active call on hold.
- The **PHONE** LED will flash to indicate call is on hold.
- Press **HOLD** again to return to the call.

TO MUTE A CALL

- Press **MUTE** on the handset to disable the handset microphone.
- The **MUTE/LO.BATT LED** will stay on continuously.
- Press **MUTE** again to return to normal operation.

TO PAGE THE HANDSET

- To page from the base, press **PAGE**.
- To cancel the page, either press **PAGE** again on the base or press **OFF** on the handset.

MEMORY STORING

- The phone should be **OFF**.
- Press **PROG**.
- Enter the two digit memory location (00 .. 20).
- Enter the number you wish to store, up to a maximum of 20 digits.
- Press **MEM** to store number and exit program mode.

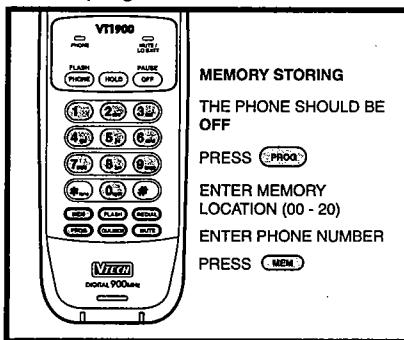

MEMORY DIALING

- Press the **PHONE** key.
- Press **MEM**.
- Enter the memory location of the number you wish to dial (00..20).
- The number stored in memory will be automatically dialed.

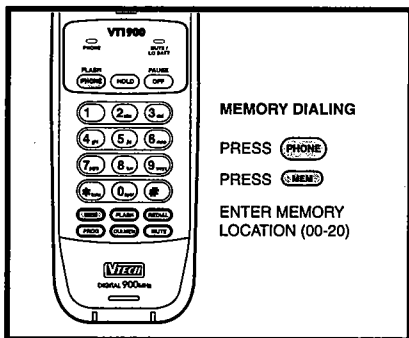

QUICK MEMORY DIALING

- Press the **PHONE** key.
- Press **QUI. MEM**.
- The phone number stored in memory location 00 will be automatically dialed after a 2 second delay.

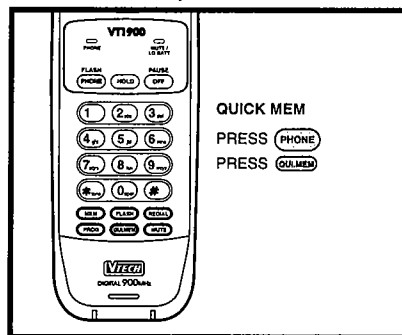

NOTE:

You can press **PHONE** before **QUICK MEM**, but it is not required.

USING REDIAL

- Press the **PHONE** key, then **REDIAL** to automatically redial out the last number you dialed.

MAKING CALLS

You can make calls directly from the handset whether you are at the base or away from it.

1. Press the **PHONE** key and wait for a dial tone.
2. Then dial the number you want.

If you make a mistake when dialing, press **OFF** to hang up, then press the **PHONE** key to get the dial tone again.

DISCONNECTING

To end a call, either place the handset back in the base, or press **OFF** on the handset.

EXTENSION IN USE INDICATOR

When another extension is in use on the same line, and the VTech VT1900 is in standby mode, the **PHONE** LED will flash.

Extension in use indication will not function when the handset is out of range.

VOLUME CONTROLS

The handset has a digital volume control.

The volume controls for the handset are located on the side of the unit. Press the **▲** or **▼** keys to increase or decrease the volume. Holding either key down will continuously change the volume setting. The ear piece volume level will change accordingly.

FLASH

You can use your VTech VT1900 cordless phone with services such as Call Waiting. Instead of pressing the switch-hook (as you would on a regular phone) press the **FLASH** key.

REDIAL

To **REDIAL** the last number you dialed, press the **PHONE** key, then press **REDIAL**. The phone will automatically dial the number.

HOLD

Press **HOLD** on the handset to place an active call on hold. The **PHONE** LED will flash to indicate call is on hold. Press **HOLD** again to return to the call.

MUTE

Press **MUTE** on the handset to disable the handset microphone. The **MUTE/LO BATT** LED will stay on continuously. Press **MUTE** again to return to normal operation.

RINGER MUTE

- Press **MUTE** on the handset during incoming ringing will disable the ringer for the duration of the call.

PAGE

To page from the base, press **PAGE**. To cancel the page, either press **PAGE** again on the base or press **OFF** on the handset.

ADVANCED FUNCTIONS

TEMPORARY TONE

If you have a rotary (dial-pulse) telephone service, (**TONE/PULSE** switch is set to **PULSE**), this feature allows you to enter special codes and tones to operate answering machines, use electronic banking services, calling cards, or other special services.

First, dial the call normally. Then activate the Temporary Tone feature by pressing ***** (TONE key). You can then press the numbers or symbols you need, and your phone will send the proper signals.

To end the call, press **OFF** or place the handset back in the base. The phone will automatically go back to rotary (dial-pulse) service.

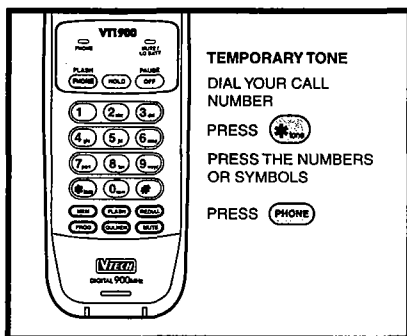

PROGRAMMING THE RINGER

The handset ringer is capable of four different types of ringer tones for each line. The following section details how to select different ringer types and how to turn off the handset ringer.

CHANGING RINGER TYPES

To program, the handset must be **OFF**.

To select a different ringer type do the following:

- Press **PROG**
- Press the **#** key.
- Press:
 - 1 for ringer type 1
 - 2 for ringer type 2
 - 3 for ringer type 3
 - 4 for ringer type 4
 - 0 for ringer off (ringer disabled)
- Press **PROG** or **OFF** exit program mode.

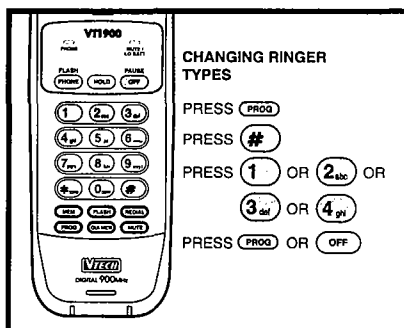

ADVANCED FUNCTIONS

TURNING OFF THE RINGER

To turn off the ringer do the following:

- Press **PROG**
- Press the **#** key.
- Press **0**
- Press **PROG** or **OFF** to exit

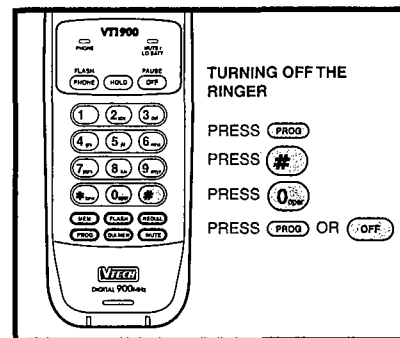

CHECKING THE RINGER TYPE

To test the present ringer type, do the following:

- Press **PROG**
- Press the **#** key
- Press **#** to test the ringer
- Press **PROG** or **OFF** to exit

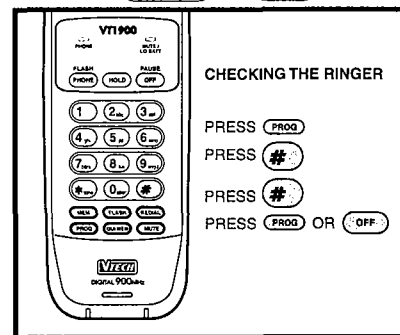

MEMORY DIALING

The VTech VT1900 is capable of memory dialing. You can dial by pressing the memory location in which the number was stored.

STORING SPEED DIAL NUMBERS

To program a speed dial location, do the following:

- With the phone **OFF** mode.
- Press **PROG**. The **PHONE LED** will flash quickly to indicate that the unit is in program mode.
- Enter the memory location (00..20) you wish to store the number in.
- Enter the phone number to be stored, up to a maximum of 20 digits.
- Press **MEM** to store the number and exit program mode. The unit will emit a happy tone (a short series of beeps) to confirm successful programming and exit program mode.
- If programming is unsuccessful the unit will generate an error tone.

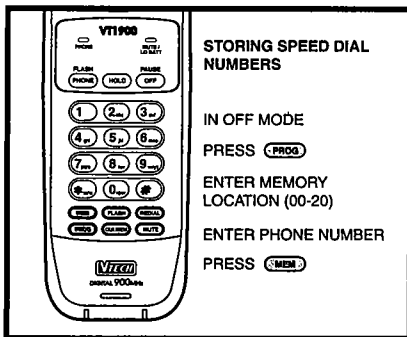

QUICK MEMORY DIALING

The **QUI. MEM** key gives you one button access to the speed dial number stored in memory location 00. This may be a frequently dialed friend, business, or emergency number, such as 911.

There are two ways to dial using

QUICK MEM. KEY

- Press **PHONE**.
- Press **QUI. MEM**.
- The phone number stored in memory location 00 will be automatically dialed.

OR

- With the Handset **OFF**, press **QUI. MEM**.
- The phone number stored in memory location 00 will be automatically dialed after a 2 second delay.

MEMORY DIALING

STORING NUMBERS USING REDIAL

To store the last number dialed into a permanent memory location, do the following:

- With the phone in the **OFF** mode.
- Press **PROG**. The **PHONE LED** will flash to indicate the unit is in program mode.

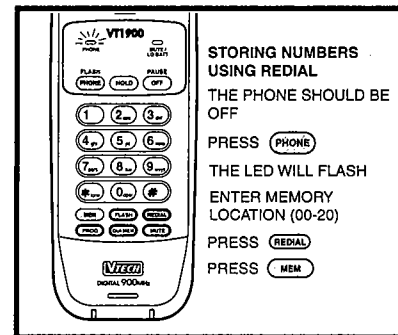

- Enter the memory location you wish to store the number in.
- Press **REDIAL**.
- Press **MEM** to store the number and exit program mode. The unit will emit a happy tone (a series of short beeps) to confirm successful programming.
- If programming is unsuccessful the unit will generate an error tone

DIALING FROM MEMORY

- Press **PHONE** to get a line.
- Press **MEM**.
- Enter a 2 digit location number (00-20)
- The number stored in that location will be automatically dialed.

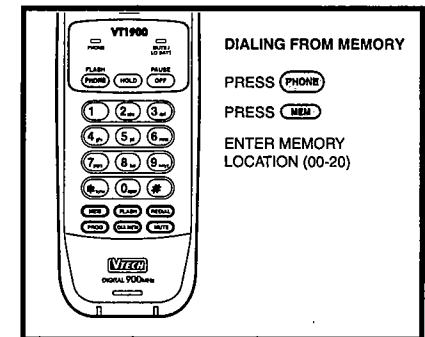

MEMORY DIALING

CHANGING STORED NUMBERS

To change or replace a stored number, simply store a new number in the desired memory location following the instructions listed in, **STORING SPEED DIAL NUMBERS**. See page 21.

DELETING STORED NUMBERS

- To delete a stored number from memory do the following:
- Press **PROG** to enter program mode.
- Enter the memory location (00..20).
- Press **MEM** to exit program mode.

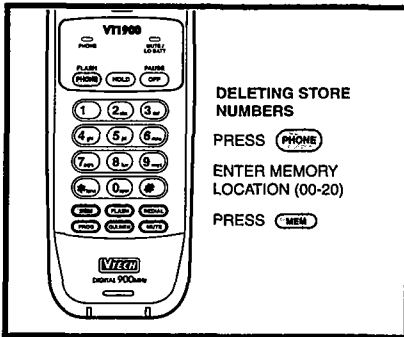

NOTE:

Stored numbers are retained in memory even if the base loses its power or the handset battery is removed.

STORING SPECIAL CODES

To insert a pause in a phone number, press **HOLD** at the appropriate point when entering the number. This inserts a 2 second pause. For longer pauses, press **HOLD** two or more times. Each press makes the pause 2 seconds longer and is treated as a stored digit.

If your phone is connected to a PBX you can store the PBX access number and a pause before the phone number. For example, to store 9-PAUSE-555-1234 in memory location 08, do the following:

- Press **PROG**
- Press 08 (memory location)
- Press 9
- Press **HOLD**
- Dial 5551234
- Press **MEM**

MAINTENANCE

TAKING CARE OF YOUR TELEPHONE.

Your VTech VT1900 cordless telephone contains sophisticated electronic parts, so it must be treated with care.

Avoid rough treatment

Place the handset down gently. Save the original packing materials to protect your telephone if you ever need to ship it.

Avoid water

Your telephone can be damaged if it gets wet. Do not use the handset outdoors in the rain, or handle it with wet hands. Do not install your base unit near a sink, bathtub or shower.

Electrical storms

Electrical storms can sometimes cause power surges harmful to electronic equipment.

For your own safety, use caution when using electric appliances during storms.

Cleaning your telephone

Your telephone has a durable plastic casing that should retain its luster for many years. Clean it only with a soft cloth slightly dampened with water or a mild soap. Do not use excess water or cleaning solvents of any kind.

Remember that electrical appliances can cause serious injury if used when you are wet or standing in water. If your base unit should fall into water, **DO NOT RETRIEVE IT UNTIL YOU UNPLUG THE POWER CORD AND TELEPHONE LINE CORDS FROM THE WALL**. Then pull the unit out by the unplugged cords.

OUT OF RANGE INDICATION

If the handset is moved to a point where the base and handset can no longer communicate, the handset will make a quick series of beeps to signal Out of Range.

OUT OF RANGE WHEN PHONE IS ON

If you are presently engaged in a phone conversation move closer to the base. If the base unit does not communicate with the handset within 25 seconds of losing contact, it will automatically hang up.

OUT OF RANGE WHEN PHONE IS OFF

If the phone is **OFF**, the handset and base still monitor each other to make sure that they can communicate. If the handset is moved out of range, the handset will make a series of beeps, and then the **PHONE** and **MUTE/LO.BATT LEDS** will flash continually. The handset will re-link with the base automatically once it is brought back within range. The unit will then be able to receive and place calls.

When the base unit is unplugged from the power supply, the handset will give the **Out of Range** warning beep. Plug the base in again and this will stop.

NOISE OR INTERFERENCE

Your VTech VT1900 cordless telephone has auto-channel scan circuitry which will detect excess noise and change the channel of the phone to reduce it. This is done automatically.

Since the VTech VT1900 is a fully digital phone, it does not suffer from noise associated with regular cordless phones. At times you may experience occasional "drop outs" especially at the extreme edges of the phone's range. Simply move closer to the base unit and this will disappear.

AUTOMATIC SECURITY CODING

Your VTech VT1900 phone is programmed with a digital security code, which is factory set from 16.8 million possible codes. This unique security code allows your handset and base to recognize each other, and minimizes the possibility of another cordless phone using your telephone line.

IN CASE OF DIFFICULTY

If you have difficulty operating your phone, the suggestions below should solve the problem. If you still have difficulty after trying these suggestions, call VTECH Communications at 1-800-624-5688. In Canada, call **VTECH Electronics at 604-273-5131**.

THE PHONE DOESN'T WORK AT ALL.

- Make sure the power cord is plugged in.
- Make sure the telephone line cord is plugged firmly into the base unit and the telephone wall jack.
- Make sure the batteries are properly charged. If the **MUTE/LO BATT LED** is flashing, the battery pack needs charging.

NO DIAL TONE.

First check all the suggestions above. If you still don't hear a dial tone, disconnect the base unit from the telephone jack and connect a different phone. If there is no dial tone on that phone either, the problem is in your wiring or local service. Call your local telephone company.

YOU GET NOISE, STATIC, OR A WEAK SIGNAL EVEN WHEN YOU'RE NEAR THE BASE UNIT.

Household appliances plugged into the same circuit as the base unit can sometimes cause interference. Try moving the appliance or the base unit to another outlet.

YOU GET NOISE, STATIC, OR A WEAK SIGNAL WHEN YOU'RE AWAY FROM THE BASE UNIT.

- You may be out of range. Either move close to the base, or relocate the base unit.
- The layout of your home may be limiting the range. Try moving the base unit to another position.

THE HANDSET DOES NOT RING WHEN YOU RECEIVE A CALL.

Make sure you have the handset ringer activated. To set the ringer see page **PROGRAMMING THE RINGER** on page 19.

- Make sure the telephone line cord is plugged firmly into the base unit and the telephone jack. Make sure the power cord is plugged in.
- You may be too far from the base unit.
- You may have too many extension phones on your telephone line to allow all of them to ring. Try unplugging some of the other phones.

IN CASE OF DIFFICULTY

YOU HEAR OTHER CALLS WHILE USING YOUR PHONE.

Disconnect your base unit from the telephone jack, and plug in a regular telephone. If you still hear other calls, the problem is probably in your wiring or local service. Call your local telephone company.

YOU HEAR NOISE IN THE HANDSET, AND NONE OF THE KEYS OR BUTTONS WORK.

Make sure the power cord is plugged in.

COMMON CURE FOR ELECTRONIC EQUIPMENT

Electronics, like people, can sometimes get confused. If the unit does not seem to be responding normally, then try putting the handset in the cradle. If it does not seem to respond after trying this a few times, do the following (in the order listed):

1. Disconnect the power to the base.
2. Disconnect the handset battery.
3. Wait a few minutes.
4. Connect power to the base.
5. Connect the handset battery.
6. Put the handset in the base.

Warranty

LIMITED WARRANTY

VTECH Communications warrants, to the original purchaser only, the material and workmanship of this product for **ONE YEAR** from the date of purchase. VTECH will repair or replace, at our option, this product without charge should it fail due to a defect in material or workmanship within that time period.

This warranty does not apply to loss or damage which is the result of accident, misuse or negligence. All other warranties, expressed, implied, or statutory, including warranties of fitness for a particular purpose, are limited to the time period listed and are otherwise excluded from this warranty. VTECH may, at its option, void the warranty if unauthorized repairs are attempted. Additionally, VTECH shall not be liable for any incidental or consequential damage or commercial loss, nor for any other loss or damages.

VTECH assumes no responsibility for products sent without prior Return Authorization.

To arrange for service, in or out of warranty, please call our Customer Service department at 1-800-624-5688; In Canada, call VTECH Electronics at 1-800-267-7377 for Return Authorization. **For warranty service, proof of purchase is required.**

TECHNICAL SPECIFICATIONS

FREQUENCY CONTROL

Crystal Controlled Dual PLL Synthesizer

TRANSMIT FREQUENCY

Handset: 925.05 MHz to 927.75 MHz (All ten channels within this range)

Base: 902.3 MHz to 905.0 MHz (All ten channels within this range)

RECEIVE FREQUENCY

Handset: 902.3 MHz to 905.0 MHz (All ten channels within this range)

Base: 925.05 MHz to 927.75 MHz (All ten channels within this range)

NOMINAL EFFECTIVE RANGE

Maximum power allowed by FCC and IC. Actual operating range may vary according to environmental conditions at the time of use.

SIZE

Handset: 188 x 62 x 35mm

Base : 210 x 145 x 148

WEIGHT

Handset: 282g

Base : 428g

POWER REQUIREMENTS

Handset: Self-contained nickel-cadmium rechargeable battery supply, 3.6V nominal, 600mAh capacity.

Base : 9VDC @ 300mA

MEMORY

Speed Dial: 20 Memory locations, 20 digits per location.

**SPECIFICATIONS ARE TYPICAL AND
MAY CHANGE WITHOUT NOTICE**

VT1900 Cordless Telephone

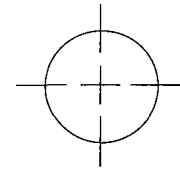

Wall Mounting Template

Use this template when wall mounting your base unit. To mark the positions of the mounting screws, hold this template against the wall, and press a pencil or pen point through the center of each crossmark.

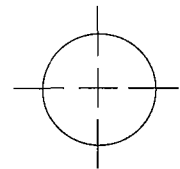

NOTE:

Select a spot where you can screw into a wooden stud within the wall. The mounting screws will not hold securely in plaster or wallboard alone.

Free Manuals Download Website

<http://myh66.com>

<http://usermanuals.us>

<http://www.somanuals.com>

<http://www.4manuals.cc>

<http://www.manual-lib.com>

<http://www.404manual.com>

<http://www.luxmanual.com>

<http://aubethermostatmanual.com>

Golf course search by state

<http://golfingnear.com>

Email search by domain

<http://emailbydomain.com>

Auto manuals search

<http://auto.somanuals.com>

TV manuals search

<http://tv.somanuals.com>