



INTRODUCTION

Congratulations! You have purchased one of the most sophisticated cordless telephones on the market! The VTech VT 1901 has been designed to offer a new standard in cordless telephone technology.

Unlike most other cordless phones, the VTech VT 1901 digitizes your voice using advanced ADPCM digital voice coding to provide noise and distortion free performance. In most conditions you will not be able to tell you are using a cordless phone. Gone are the annoyances of static, interference and having to listen to other people's conversations on your cordless phone.

The VTech VT 1901 scrambles your voice before it transmits it. This ensures that no one can tune in and eavesdrop on your conversations.

With the VTech VT 1901 the user can easily answer a call on the handset by simply pressing any key other than the OFF, MUTE or Volume Keys. This is very useful in a dark environment, so that the user does not have to fumble around looking for the PHONE key to answer the call.

The VTech VT 1901 also provides a one-way Page/find. Pressing the base PAGE key will cause the handset to ring in a manner which distinguishes it from normal incoming ringing. This can be used to alert the handset user or to simply locate the handset in the event that it is misplaced.

The VTech VT 1901 uses special memory in both the base and handset which is not susceptible to power failures. This provides permanent storage of all memory dial numbers, as well as the base and handset security codes.

When an optional spare battery pack is installed in the base unit, the VTech VT 1901 uses this battery to provide operational backup in case of power failure. In this way you have access to all normal phone functions during a total power outage. Calls can still be placed and received without interruption. More than 5 hours backup will be possible with a fully charged battery in the base unit.

The VTech VT 1901 informs you that another extension is currently in use on the same phone line. The phone will also alert you when you are Out of Range even when you're not using the phone!





INTRODUCTION

SPECIAL FEATURES

- 900 MHz Operation
- Fully Digital Link between Handset and Base with ADPCM voice coding
- Digitally-Scrambled Voice Communication
- 20 location Programmable Memory for 20 Digit Phone Number
- Quick MEM - automatically dials a designated number at the touch of a single key
- 10 Channel Operation with auto channel selection
- Out-of-Range indication while the handset is in use or in standby mode
- Removable handset battery pack
- Spare battery charger in the base unit
- Complete battery back-up in case of power failure (with optional spare battery pack installed in Base Unit)
- Easy answer - When the phone rings simply press any key other than OFF, MUTE, or the Volume Keys on the handset to answer
- Auto hang up when returning the handset to the base cradle
- Extension In Use indicator
- 24 Bit Digital Security Code
- DTMF and Pulse Dialing
- Low Battery Detect and Warning indicator
- Up to 7.0 hours continuous talk time, Or 7 days standby time.
- Volume Adjust on Handset
- REDIAL, HOLD, PAGE and MUTE
- Hearing-Aid Compatible Receiver
- Detachable power supply. Non-volatile storage of security code and memory dial memories
- Programmable Ringer Types

This manual is designed to make you familiar with the VTech VT1901. We strongly recommend you read the manual before using your phone.



INTRODUCTION

Parts Check List

1. Base unit, Handset and AC adaptor
2. One-Line Telephone Cord
3. Battery Pack
4. Wall mount accessory

To purchase replacement battery packs, call VTECH Communications at 1-800-595-9511. In Canada, call VTECH Electronics at 1-800-267-7377.

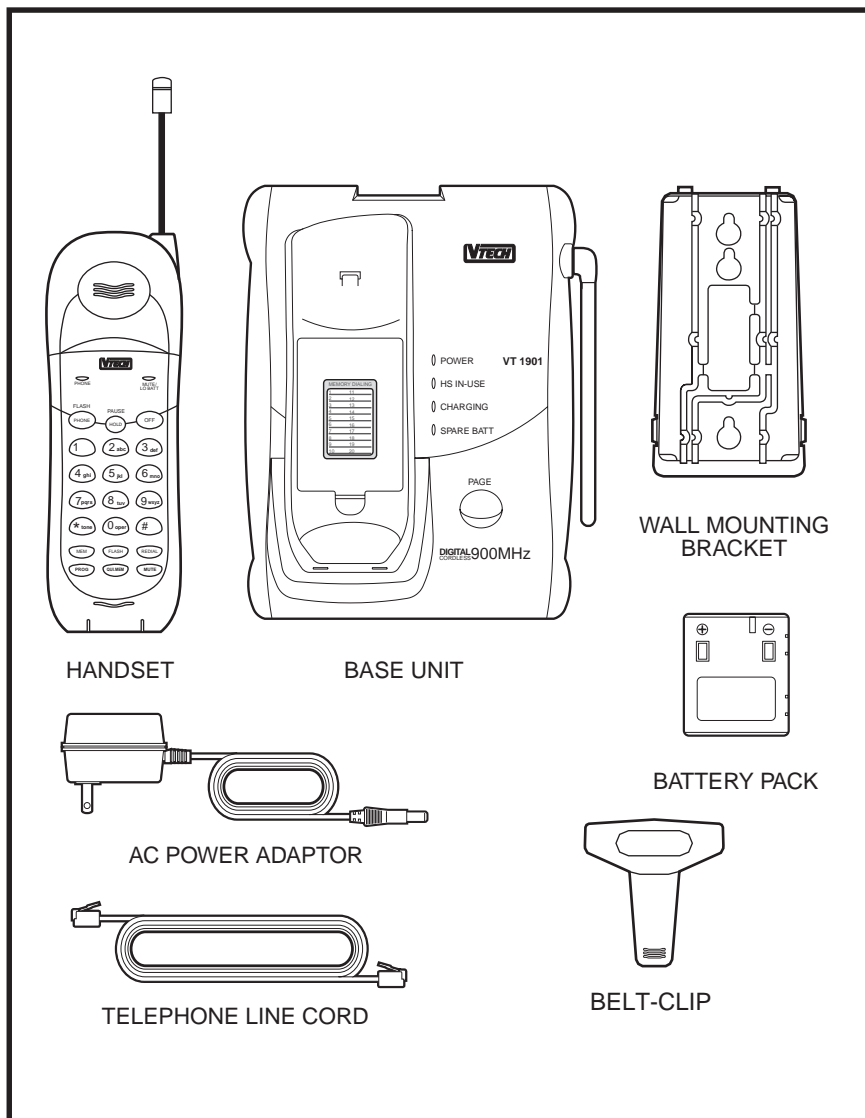



THE HANDSET LAYOUT

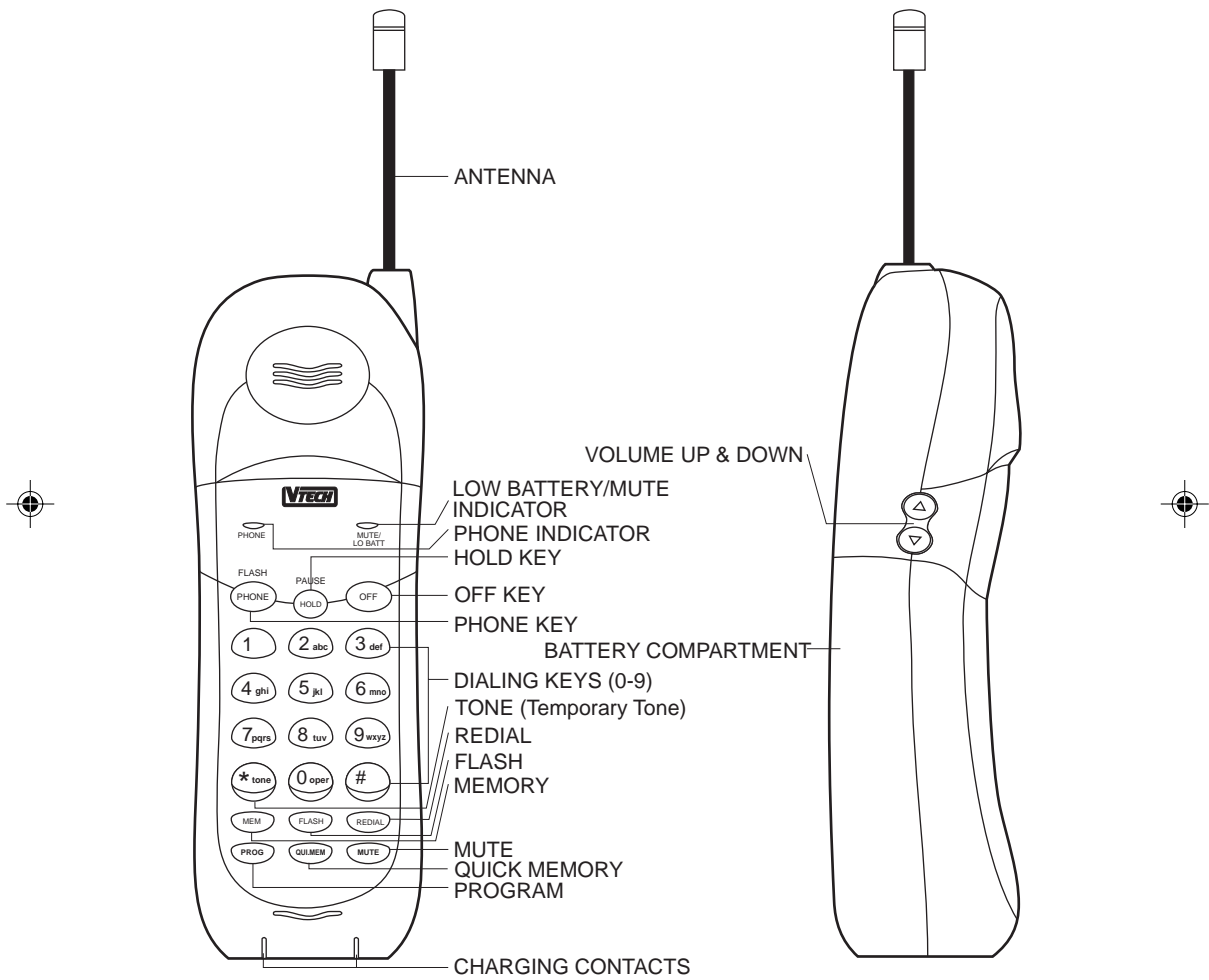

HANDSET FEATURES





THE BASE UNIT LAYOUT

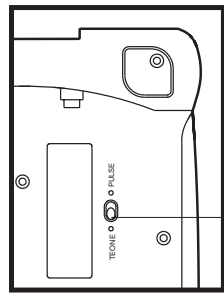

TONE/PULSE
SELECTOR

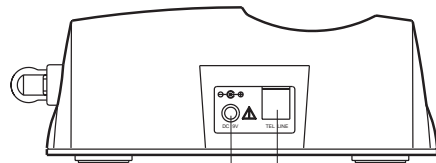

AC POWER JACK

PHONE CORD JACK

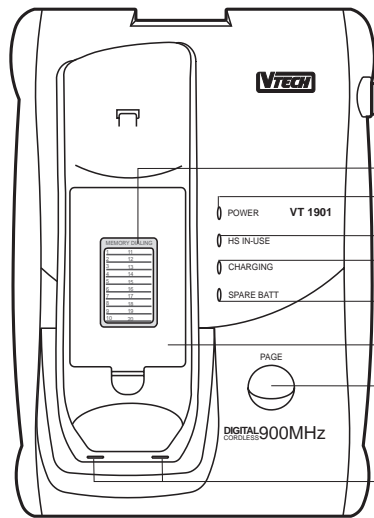

ANTENNA

MEMORY DIALING

POWER INDICATOR

IN USE INDICATOR

HANDSET CHARGE

INDICATOR

SPARE BATTERY INDICATOR

BATTERY COMPARTMENT

PAGE KEY

CHARGING CONTACTS

BASE UNIT FEATURES





FCC and IC Regulations

This equipment complies with Parts 15 and 68 of the Federal Communications Commission (FCC) rules for the United States. It also complies with regulations RSS210 and CS-03 of Industry and Science Canada. Operation is subject to the following two conditions: (1) this device may not cause interference, and (2) this device must accept any interference, including interference that may cause undesired operation of the device.

A label is located on the underside of the base unit containing either the FCC registration number and Ringer Equivalence Number (REN) or the IC registration number and Load Number. You must, upon request, provide this information to your local telephone company.

This equipment is compatible with inductively coupled hearing aids.

Should you experience trouble with this telephone equipment, please contact:

VTECH COMMUNICATIONS

SERVICE DEPT. at 1-800-595-9511. In Canada, call VTECH Electronics at 1-800-267-7377.

For repair/warranty information. The telephone company may ask you to disconnect this equipment from the line network until the problem has been corrected.

FCC Part 15

Warning: Changes or modifications to this unit not expressly approved by the party responsible for compliances could void the user's authority to operate the equipment.

The equipment has been tested and found to comply with part 15 of the FCC rules. These limits are designed to provide reasonable protection against harmful interference in a residential installation. This equipment generates, uses and can radiate radio frequency energy and, if not installed and used in accordance with the instructions, may cause harmful interference to radio communications. However, there is no guarantee that interference will not occur in a particular installation. If this equipment does cause harmful interference to radio or television reception, which can be determined by turning the equipment off and on, the user is encouraged to try and correct the interference by one or more of the following measures:

- Reorient or relocate the receiving antenna.
- Increase the separation between the equipment and receiver.
- Connect the equipment into an outlet or on a circuit different from that to which the receiver is connected.
- Consult the dealer or an experienced radio/TV technician for help.





FCC and IC Regulations

FCC Part 68

The FCC requires that you connect your cordless telephone to the nationwide telephone network through a modular telephone jack (USOC RJ11C, RJ11W or RJ14).

Your telephone company may discontinue your service if your equipment causes harm to the telephone network. They will notify you in advance of disconnection, if possible. During notification, you will be informed of your right to file a complaint with the FCC.

Occasionally, your telephone company may make changes in its facilities, equipment, operation, or procedures that could affect the operation of your equipment. If so, you will be given advance notice of the change to give you an opportunity to maintain uninterrupted service.

The base unit contains no user serviceable parts. The handset contains a user replaceable battery pack.

If it is determined that your telephone equipment is malfunctioning, the FCC requires that it not be used and that it be unplugged from the modular jack until the problem has been corrected. Repairs to this telephone equipment can only be made by the manufacturer or its authorized agents or by others who may be authorized by the FCC. For repair procedures, follow the instructions outlined under the VTECH Limited Warranty.

This equipment may not be used on coin service provided by the phone company or Party Lines.

The REN is useful in determining the number of devices you may connect to your telephone line and still enable the devices to ring when you receive a call. The general rule is that the REN value should not exceed 5.0A total; however, contact your local telephone company for the specific number in your area.

IC (Industry Canada)

This telephone is registered for use in Canada.

Notice:The REN assigned to this device denotes the number of devices you may connect to the telephone loop which is used by the device to prevent overloading. The termination on a loop may consist of any combination of devices subjected only to the requirement that the sum of the REN does not exceed five (5.0).

Notice:The Industry Canada label identifies certified equipment. This certification means that the equipment meets certain telecommunications network protective, operational and safety requirements. The Department does not guarantee the equipment will operate to the user's satisfaction.





FCC and IC Regulations

Before installing this equipment, users should ensure that it is permissible to be connected to the facilities of the local telecommunications company. The equipment must also be installed using an acceptable method of connection. The customer should be aware that compliance with the above conditions may not prevent degradation of services in some situations.

Repairs to certified equipment should be made by an authorized Canadian maintenance facility designated by the supplier. Any repairs or alterations made by the user to this equipment, or equipment malfunctions, may give the telecommunications company cause to request the user to disconnect the equipment.

Users should ensure for their own protection that the electrical ground connections of the power utility, telephone lines and internal metallic water pipe system, if present, are connected together. This precaution may be particularly important in rural areas.

Caution: Users should not attempt to make such connections themselves, but should contact the appropriate electrical inspection authority, or electrician, as appropriate.

Your VTech VT1901 is designed to operate at the maximum power allowed by the FCC and IC. This means your handset and base unit can communicate only over a certain distance - which will depend on the location of the base unit and handset, weather, and the construction and layout of your home or office.





IMPORTANT SAFETY INSTRUCTIONS

When using your telephone equipment, basic safety precautions should always be followed to reduce the risk of fire, electric shock and injury to persons, including the following:

1. Read and understand all instructions.
2. Follow all warnings and instructions marked on the product.
3. Unplug this product from the wall outlet before cleaning. Do not use liquid cleaners or aerosol cleaners. Use a dry cloth for cleaning.
4. Do not use this product near water, for example, near a bath tub, wash bowl, kitchen sink, or laundry tub, in a wet basement, or near a swimming pool.
5. Do not place this product on unstable cart, stand, or table. The telephone may fall, causing serious damage to the telephone.
6. Slots and openings in the cabinet and the back or bottom are provided for ventilation, to protect it from overheating, these openings must not be blocked or covered. The openings should never be blocked by placing the product on the bed, sofa, rug, or other similar surface. This product should never be placed near or over a radiator or heat register. This product should not be placed in a built-in installation unless proper ventilation is provided.
7. This product should be operated only from the type of power source indicated on the marking label. If you are not sure of the type of power supply to your home, consult your dealer or local power company.
8. Do not allow anything to rest on the power cord. Do not locate this product where the cord will be abused by persons walking on it.
9. Do not overload wall outlets and extension cords as this can result in the risk of fire or electric shock.
10. Never push objects of any kind into this product through cabinet slots as they may touch dangerous voltage points or short out parts that could result in a risk of fire or electric shock. Never spill liquid of any kind on the product.
11. To reduce the risk of electric shock, do not disassemble this product, but take it to a qualified service personnel when some service or repair work is required. Opening or removing covers may expose you to dangerous voltages or other risks. Incorrect reassembly can cause electric shock when the appliance is subsequently used.



IMPORTANT SAFETY INSTRUCTIONS

12. Unplug this product from the wall outlet and refer servicing to qualified service personnel under the following condition:

- A. When the power supply cord plug is damaged or frayed.
- B. If liquid has been spilled into the product.
- C. If the product has been exposed to rain or water.
- D. If the product does not operate normally by following the operating instructions. Adjust only those controls, that are covered by the operating instructions because improper adjustment of other controls may result in damage and will often require extensive work by a qualified technician to restore the product to normal operation.
- E. If the product has been dropped or the cabinet has been damaged.
- F. If the product exhibits a distinct change in performance.

13. Do not use the telephone to report a gas leak in the vicinity of the leak.

CAUTION: TO REDUCE THE RISK OF FIRE OR INJURY TO PERSONS BY BATTERY, READ AND FOLLOW THESE INSTRUCTIONS.

- 1. Use only the appropriate type and size battery pack specified in the instruction manual provided for this product.
- 2. Do not dispose of the battery pack in a fire. The cell may explode. Check with State and local codes for possible special disposal instructions.
- 3. Do not open or mutilate the battery pack. Released electrolyte is corrosive and may cause damage to the eyes or skin. It may be toxic if swallowed.
- 4. Exercise care in handling battery in order not to short the battery with conducting materials such as rings, bracelets, and keys. The battery or conductor may overheat and cause burns.
- 5. Charge the battery pack provided with or identified for use with this product only in accordance with the instructions and limitations specified in the instructions manual provided for this product.
- 6. Observe proper polarity orientation between the battery pack and battery charger.

SAVE THESE INSTRUCTIONS



REPLACING THE HANDSET BATTERY PACK

Charging the handset batteries

The handset of your VTech VT 1901 cordless telephone is powered by a rechargeable battery pack. It charges automatically whenever the handset is in the base. You should charge the battery pack for 16 hours when you first receive your phone. You'll know the battery pack needs charging when:

- The phone emits a warning tone when you press the PHONE key.
- The **MUTE/LO BATT LED** is slowly flashing
- The handset seems completely dead; no lights are evident, and pressing keys do not generate a beep.

To Charge The Battery Pack

To charge the battery pack, place the handset in the base unit. The CHARGE indicator will light to show the handset is seated properly and the battery pack is charging. It is recommended that the battery pack be charged for at least 16 hours initially and 8 hours for maintenance charging. You can use your telephone before that with diminished capacity, but it is best to charge the battery pack fully. It will take several recharge cycles to maximize the charge capacity of your battery pack. The maximum battery life between charges is 7 hours of continuous talk time or 7 days of stand by.

Alternatively, if you have purchased a spare battery pack and it has been charging in the base unit, simply

exchange the drained handset battery pack with the fully charged replacement battery pack from the base charger. Place the drained handset battery pack into the base charger to recharge.

The base spare battery charger does NOT charge a battery pack as quickly as the handset battery charger. A full charge requires 24 hours, when using the spare battery charger.

IT'S IMPOSSIBLE TO OVER-CHARGE THE BATTERY PACK

The battery pack can be recharged many times, but if you get a low-battery signal even after 8 hours of maintenance charging in the base cradle (or 24 hours in the base spare battery charger), the battery pack(s) should be replaced.

To purchase replacement battery packs, call VTECH Communications at 1-800-595-9511. In Canada, call VTECH Electronics at 1-800-267-7377.



REPLACING THE HANDSET BATTERY PACK

Follow the steps below:

1. Remove the battery case cover by pressing on the ridged lines and sliding downward.

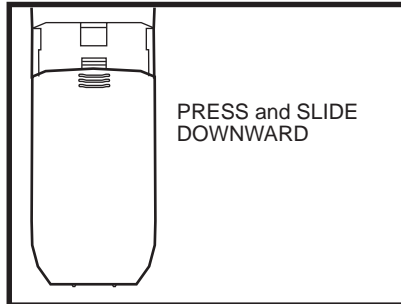

2. Discard the old battery pack. Don't put the old battery pack in a trash compactor or a fire - it could burst.
3. Place the new battery pack in the battery compartment with the metal contacts facing down.

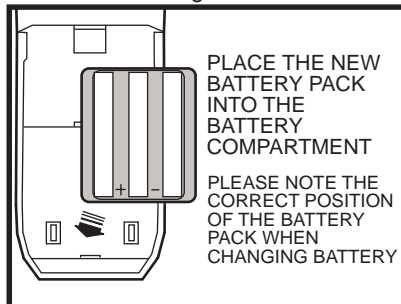

4. Replace the battery case cover by sliding the cover upwards.

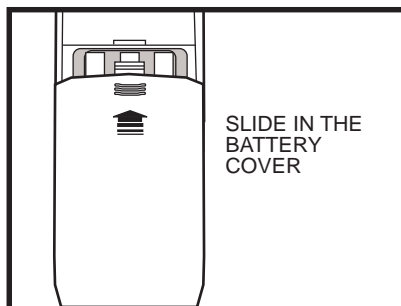

5. If the new battery pack is not already charged, place the handset in the cradle of the base unit to allow it to charge for 16 hours.

CAUTION:
To Reduce the Risk of Fire or Injury to Persons, Read and Follow the Instructions

1. Use only VTECH rechargeable battery pack.
2. Do not dispose of the battery in a fire. The cell may explode.

IMPORTANT:
Do not dispose of this battery into household garbage. For information on recycling or proper disposal, consult your local solid waste collection or disposal organization.

3. Do not open or mutilate the battery. Released electrolyte is corrosive and may cause damage to the eyes or skin. It may be toxic if swallowed.
4. Exercise care in handling batteries in order not to short the battery with conducting materials such as rings, bracelets, and keys. The battery or conductor may overheat and cause burns.

To purchase replacement battery packs, call VTECH Communications at 1-800-595-9511. In Canada, call VTECH Electronics at 1-800-267-7377.



REPLACING THE HANDSET BATTERY PACK

A WORD ABOUT RECHARGEABLE BATTERIES

Your Nicad battery pack recharges whenever the Handset is returned to the Base Unit cradle. You may return the Handset to its cradle whenever you're not using the phone.

However, to *maximize* the life of your battery pack, do not return your **VT 1901** Handset to the Base Unit cradle for recharging until the **MUTE/LO BATT** begins to flash.

SPARE BATTERY CHARGER

The VT 1901 has a built-in Spare Battery Charger, which is located in the cradle of the Base Unit.

NOTE: In order to benefit from this feature, you must obtain an optional Spare Battery pack from an authorized VTech dealer, or by contacting VTech Customer Service at 1-800-595-9511

Installation

Remove the Spare Battery charger cover by pressing the release tab and lifting up.

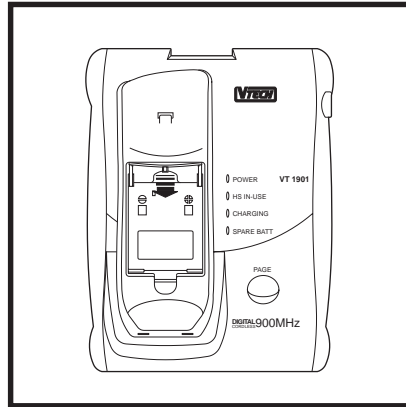

Place a battery pack in the Spare Battery charger. Make sure the metal charging contacts on the underside of the battery pack are aligned with the charging contact in the Spare Battery charger.

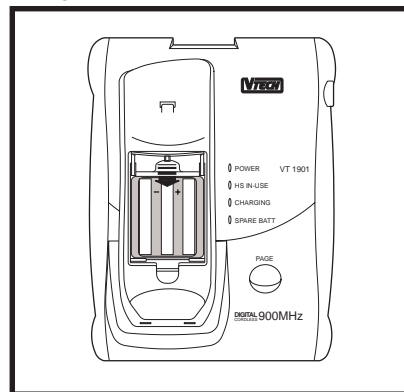



REPLACING THE HANDSET BATTERY PACK

Power Backup

When a Spare Battery pack is installed in the Base Unit, the VTech VT 1901 uses this battery to provide operational backup in case of a power failure. If you have a fully charged battery pack in the Spare Battery charger and there is a power outage, you will still be able to place and receive calls for up to five hours.

Replacing a Drained Handset battery The spare battery pack can also be used to replace a drained Handset battery pack to ensure uninterrupted use. Be sure to put the drained battery in the Spare Battery charger for recharging.

Please note that the Spare battery pack recharges at a slower rate than a battery pack charging in the Handset. It takes 24 hours to fully charge a battery pack in the Spare Battery charger.



GETTING STARTED

SETTING UP YOUR VTECH VT 1901

Choose an area near an electrical outlet and a telephone wall jack.

AC POWER ADAPTOR

Plug the AC power adaptor into an electrical outlet and the DC connector to the back of the base unit.

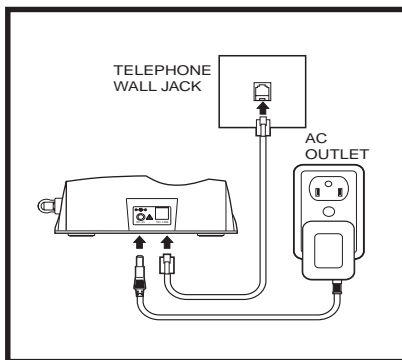

HANDSET RINGER

The handset ringer is programmed ON as the factory default setting. Refer to **PROGRAMMING THE RINGER** on page # for more information.

SETTING THE TONE/PULSE SWITCH

The **TONE/PULSE** switch is located on the bottom of the base unit and is factory set to **TONE**. If you have touch tone service, do not change the switch setting. If you have rotary (Pulse) service, set the switch to **PULSE**.

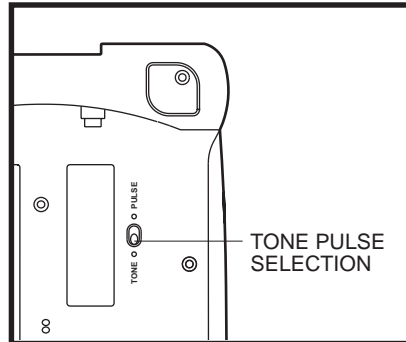

CHARGE THE HANDSET BATTERY PACK BEFORE USE

The battery pack recharges automatically whenever the handset is in the base unit. The battery pack must be charged for 16 hours before using your phone for the first time.

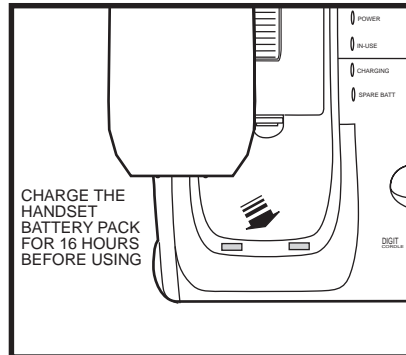

CONNECT TELEPHONE LINE CORD

Plug one end of the telephone cord into a wall jack, and the other end into the back of the Base Unit.



GETTING STARTED

CHECK FOR A DIAL TONE.

After charging the battery pack, rotate the Base Unit antenna to an upright position. Pick up the Handset, making sure the Handset antenna is fully extended. Now press PHONE , you should hear dial tone. If not, see '**IN CASE OF DIFFICULTY**' on page #?

Fill in the telephone number card on the base unit.

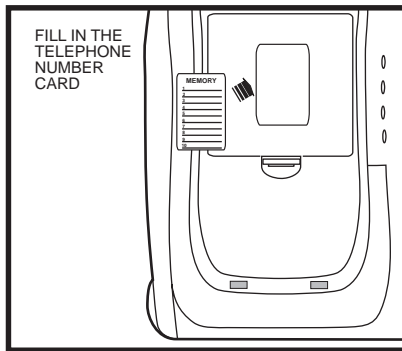

CAUTION:

1. Never install telephone wiring during a lightning storm.
2. Never install telephone jacks in wet locations unless the jack is specifically designed for wet locations.
3. Never touch uninsulated telephone wires or terminals unless the telephone line has been disconnected at the network interface.
4. Use caution when installing or modifying telephone lines.

WALL MOUNTING

USING THE WALL MOUNT ADAPTOR

1. Choose a spot near an electrical outlet and a telephone jack.

Your phone requires a modular telephone jack and a standard electrical outlet (120v AC). The power cord is six feet long; make sure there is an electrical outlet within reach of the Base Unit. The outlet should not be controlled by a wall switch. If the switch is ever turned off, the phone will not operate.

2. Position the wall mount bracket on the base.

Line up the tabs on the wall mount adaptor with the holes on the bottom of the base (Figure 1). Snap the wall mount bracket firmly in place.

3. Mount the base on the wall.

Position the base so the mounting studs will fit into the holes on the bottom of the base. Position the power cord to extend down the wall the phone is to be mounted on. Slide the base down on the mounting studs until it locks into place.

4. Connect the telephone line cord.

The telephone line cord has a snap-in plug at each end. Insert one of the plugs into the jack on the bottom of the base. Insert the other end of the plug into the wall jack.

5. Plug the AC adaptor into an electrical outlet and the DC connector on the back of the Base Unit.

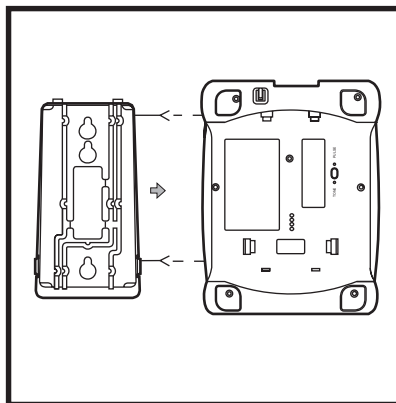

Figure 1

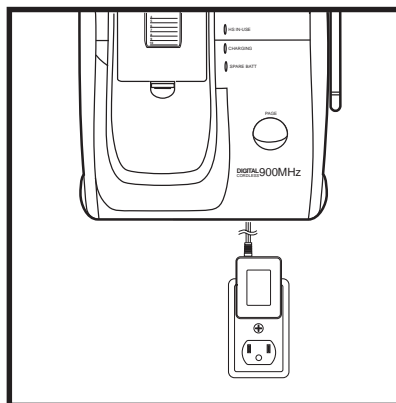

Figure 2



QUICK REFERENCE GUIDE

SET-UP

- Plug AC adaptor into a standard electrical outlet and connect to Base Unit.
- Set Dial Mode switch to **(PULSE)** or **(TONE)**. The unit is factory set to **(TONE)**.
- Let handset battery pack charge for 16 hours before first use.
- Connect telephone line cord to Base Unit and telephone jack.

MAKING CALLS

- Press the **(PHONE)** key. When you hear a dial tone, dial the number.

ANSWERING CALLS

- To answer a call press any key other than **(OFF)**, **(MUTE)**, or the Volume Keys. The handset will auto-answer when lifted off the base cradle.

HANGING UP

Press **(OFF)**, or place the handset in the base cradle to hang up a call.

TO PLACE A CALL ON HOLD

- Press **(HOLD)** to place an active call on hold.
- The **PHONE** LED will flash to indicate call is on hold.
- Press **(HOLD)** again to return to the call.

TO MUTE A CALL

- Press **(MUTE)** to disable the handset microphone.
- The **MUTE/LO BATT** LED will stay on continuously.
- Press **(MUTE)** again to return to two way conversation

TO PAGE THE HANDSET

- To page from the Base Unit, press **(PAGE)**.
- To cancel the page, either press **(PAGE)** again on the Base Unit or press **(OFF)** on the handset.

QUICK REFERENCE GUIDE

STORING MEMORY DIAL NUMBERS

- The phone should be **OFF**.
- Press **PROG**.
- Enter the two digit memory location (00 .. 20).
- Enter the number you wish to store, up to a maximum of 20 digits.
- Press **MEM** to store number and exit program mode.

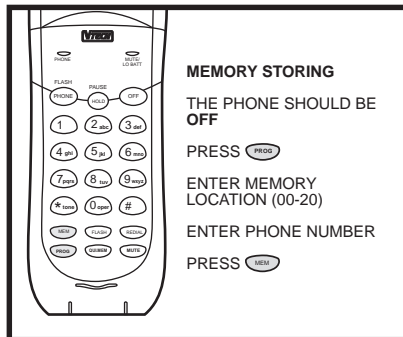

MEMORY DIALING

- Press the **PHONE** key.
- Press **MEM**.
- Enter the memory location of the number you wish to dial (00..20).
- The number stored in memory will be automatically dialed.

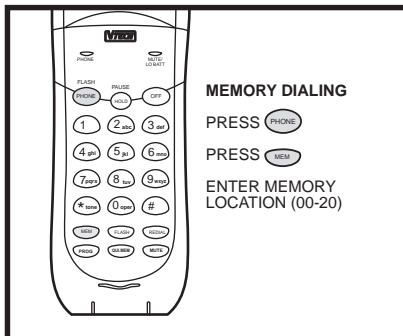

QUICK MEMORY DIALING

- Press the **PHONE** key.
- Press **QUI. MEM**.
- The phone number stored in memory location 00 will be automatically dialed after a 2 second delay.

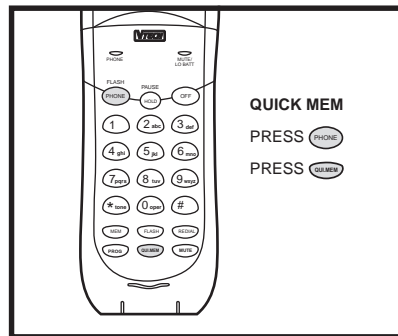

NOTE:

You can press **PHONE** before **QUI.MEM**, but it is not required.

USING REDIAL

- Press the **PHONE** key, then **REDIAL** to automatically redial the last number you dialed.

BASIC OPERATION

ANSWERING CALLS

When the Handset is in the Base Unit cradle, simply pick up the Handset to answer an incoming call.

When the Handset is away from the Base Unit press any key other than **OFF**, **MUTE** or the Volume keys to answer an incoming call.

MAKING CALLS

1. Press the **PHONE** key and wait for a dial tone.
2. Then dial the number you want.

If you make a mistake when dialing, press **OFF** to hang up, then press the **PHONE** key to get the dial tone again.

DISCONNECTING

To end a call, either place the handset back in the Base Unit, or press **OFF**.

EXTENSION IN USE INDICATOR

When another phone is in use on the same line, and the VTech VT1901 is in standby mode, the **PHONE** LED will flash slowly.

Extension In Use indication will not function when the Handset is out of range.

VOLUME CONTROLS

The volume controls for the handset are located on the side of the unit. Press the **▲** or **▼** keys to increase or decrease the volume. Holding either key down will continuously change the volume setting. The earpiece volume level will change accordingly. There are four volume levels.

FLASH

You can use your VTech VT1901 cordless phone with services such as Call Waiting. Simply press the **FLASH** key.

REDIAL

To **REDIAL** the last number you dialed, press the **PHONE** key, then press **REDIAL**. The phone will automatically dial the number.

HOLD

Press **HOLD** to place an active call on hold.

The **PHONE** LED will flash to indicate call is on hold.

Press **HOLD** again to return to the call.

MUTE

Press **MUTE** to disable the handset microphone.

The **MUTE/LO BATT** LED will stay on continuously.

Press **MUTE** again to return to two way conversation.

RINGER MUTE

Press **MUTE** during incoming ringing to disable the ringer for the duration of the call.

PAGE

To page from the base, press **PAGE**.

To cancel the page, either press **PAGE** again on the base or press **OFF** on the handset.

ADVANCED FUNCTIONS

TEMPORARY TONE

If you have rotary (dial-pulse) telephone service (**TONE/PULSE** switch is set to **PULSE**), this feature allows you to temporarily switch to TONE dialing for such purposes as remote access to answering machines, bank-by-phone services, use of calling cards and other special services.

First, dial the call normally. Then activate the Temporary Tone feature by pressing ***** (TONE key). You can then press the numbers or symbols you need, and your phone will send the proper tones.

To end the call, press **OFF** or place the handset back in the base. The phone will automatically go back to rotary (dial-pulse) service.

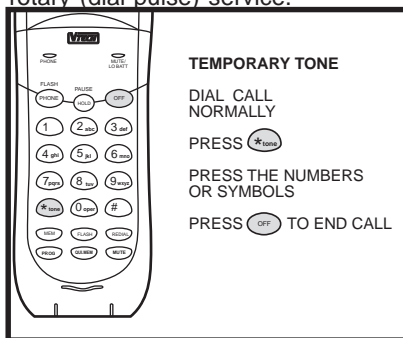

PROGRAMMING THE RINGER

The handset ringer is capable of four different types of ringer tones. The following section details how to select different ringer types and how to turn off the handset ringer.

CHANGING RINGER TYPES

To program, the handset must be **OFF**.

To select a different ringer type do the following:

- Press **PROG**
- Press the **#** key.
- Press:
 - 1 for ringer type 1
 - 2 for ringer type 2
 - 3 for ringer type 3
 - 4 for ringer type 4
- Press **PROG** or **OFF** to exit program mode.

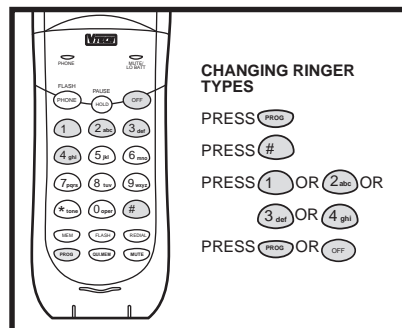



ADVANCED FUNCTIONS

TURNING OFF THE RINGER

To turn off the ringer do the following:

- Press **PROG**
- Press the **#** key.
- Press **0**
- Press **PROG** or **OFF** to exit

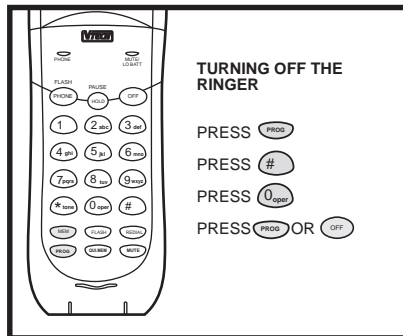

CHECKING THE RINGER TYPE

To hear the present ringer type, do the following:

- Press **PROG**
- Press the **#** key
- Press **#** to test the ringer
- Press **PROG** or **OFF** to exit

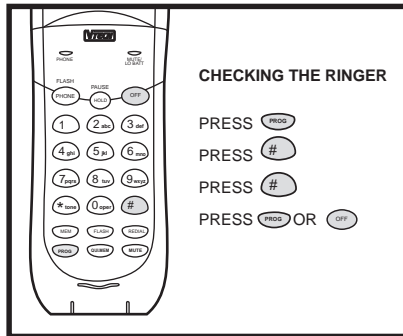

MEMORY (SPEED) DIALING

STORING SPEED DIAL NUMBERS

To program a speed dial location, do the following:

- The phone should be **OFF**.
- Press **(PROG)**. The **PHONE LED** will flash quickly to indicate that the unit is in program mode.
- Enter the memory location (00..20) you wish to store the number in.
- Enter the phone number to be stored, up to a maximum of 20 digits.
- Press **(MEM)** to store the number and exit program mode. The unit will emit a happy tone (a short series of beeps) to confirm successful programming and exit program mode.
- If programming is unsuccessful, the unit will generate an error tone.

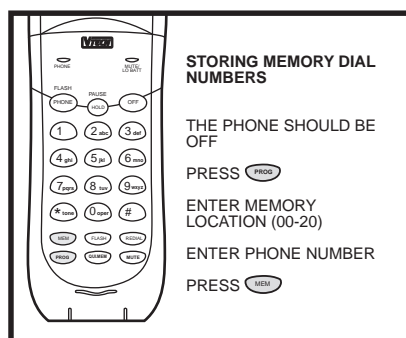

QUICK MEMORY DIALING

The **QUI. MEM** key gives you one button access to the MEMORY DIAL number stored in memory location 00. This may be a frequently dialed friend, business, or emergency number, such as 911.

There are two ways to dial using the **QUI. MEM KEY**

- Press **(PHONE)**.
- Press **(QUI. MEM)**.
- The phone number stored in memory location 00 will be automatically dialed.

OR

- With the Handset **OFF**, press **(QUI. MEM)**.
- The phone number stored in memory location 00 will be automatically dialed after a 2 second delay.

MEMORY (SPEED) DIALING

STORING NUMBERS USING REDIAL

To store the last number dialed into a permanent memory location, do the following:

- The phone should be **OFF**.
- Press **PROG**. The **PHONE LED** will flash quickly to indicate the unit is in program mode.

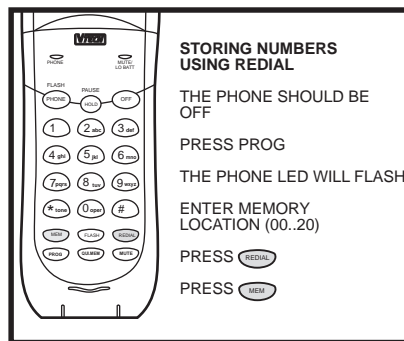

- Enter the memory location (00..20) you wish to store the number in.
- Press **REDIAL**.
- Press **MEM** to store the number and exit program mode. The unit will emit a happy tone (a series of short beeps) to confirm successful programming.
- If programming is unsuccessful the unit will generate an error tone.

DIALING FROM MEMORY

- Press **PHONE** to get dial tone.
- Press **MEM**.
- Enter a 2 digit location number (00..20)
- The number stored in that location will be automatically dialed.

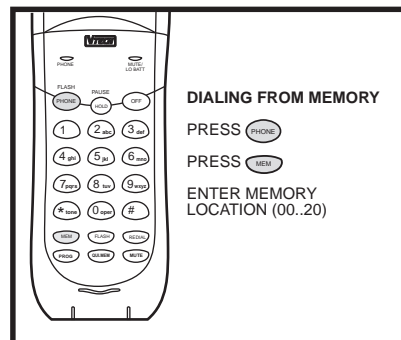

MEMORY (SPEED) DIALING

CHANGING STORED NUMBERS

To change or replace a stored number, simply store a new number in the desired memory location following the instructions listed in **STORING MEMORY DIAL NUMBERS**. See page 21.

DELETING STORED NUMBERS

To delete a stored number from memory do the following:

- Press **PROG** to enter program mode.
- Enter the memory location (00..20).
- Press **MEM** to exit program mode.

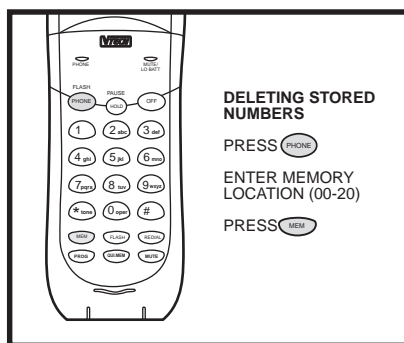

NOTE:

Stored numbers are retained in memory even if the base loses its power or the handset battery is removed.

STORING SPECIAL CODES

To insert a pause in a phone number, press **HOLD** at the appropriate point when entering the number. This inserts a 2 second pause. For longer pauses, press **HOLD** two or more times. Each press makes the pause 2 seconds longer, and is treated as a stored digit.

If your phone is connected to a **PBX** you can store the PBX access number and a pause before the phone number. For example, to store 9-PAUSE-555-1234 in memory location 08, do the following:

- Press **PROG**
- Press 08 (memory location)
- Press 9
- Press **HOLD** (pause)
- Dial 5551234
- Press **MEM**



MAINTENANCE

TAKING CARE OF YOUR TELEPHONE.

Your VTech VT1901 cordless telephone contains sophisticated electronic parts, so it must be treated with care.

Avoid rough treatment
Place the handset down gently.
Save the original packing materials to protect your telephone if you ever need to ship it.

Avoid water
Your telephone can be damaged if it gets wet. Do not use the handset outdoors in the rain, or handle it with wet hands. Do not install your base unit near a sink, bathtub or shower.

Electrical storms
Electrical storms can sometimes cause power surges harmful to electronic equipment.

For your own safety, use caution when using electric appliances during storms.

Cleaning your telephone

Your telephone has a durable plastic casing that should retain its luster for many years. Clean it only with a soft cloth slightly dampened with water or a mild soap. Do not use excess water or cleaning solvents of any kind.

Remember that electrical appliances can cause serious injury if used when you are wet or standing in water. If your base unit should fall into water, **DO NOT RETRIEVE IT UNTIL YOU UNPLUG THE POWER CORD AND TELEPHONE LINE CORDS FROM THE WALL.** Then pull the unit out by the unplugged cords.





ADDITIONAL OPERATING TIPS

If the handset is moved to a point where the base and handset can no longer communicate, the handset will make a quick series of beeps to signal Out of Range.

OUT OF RANGE WHEN PHONE IS ON

If you are presently engaged in a phone conversation move closer to the base. If the base unit does not communicate with the handset within 25 seconds of losing contact, it will automatically hang up.

OUT OF RANGE WHEN PHONE IS OFF

If the phone is **OFF**, the handset and base still monitor each other to make sure that they can communicate. If the handset is moved out of range, the handset will make a series of beeps, and then the **PHONE** and **MUTE/LO.BATT LEDS** will flash continually. The handset will re-link with the base automatically once it is brought back within range. The unit will then be able to receive and place calls.

When the base unit is unplugged from the power supply, the handset will give the **Out of Range** warning beep. Plug the base in again and this will stop.

NOISE OR INTERFERENCE

Your VTech VT1901 cordless telephone has auto-channel scan circuitry which will detect excess noise and change the channel of the phone to reduce it. This is done automatically.

Since the VTech VT1901 is a fully digital phone, it does not suffer from noise associated with regular cordless phones. At times you may experience occasional "drop outs", especially at the extreme edges of the phone's range. Simply move closer to the base unit and this will disappear.

AUTOMATIC SECURITY CODING

Your VTech VT1901 phone is programmed with a digital security code, which is factory set from 16.8 million possible codes. This unique security code allows your handset and base to recognize each other, and minimizes the possibility of another cordless phone using your telephone line.





IN CASE OF DIFFICULTY

If you have difficulty operating your phone, the suggestions below should solve the problem. If you still have difficulty after trying these suggestions, call VTECH Communications at 1-800-595-9511. In Canada, call **VTECH Electronics at 604-273-5131**.

THE PHONE DOESN'T WORK AT ALL.

- Make sure the power cord is plugged in.
- Make sure the telephone line cord is plugged firmly into the base unit and the telephone wall jack.
- Make sure the batteries are properly charged. If the **MUTE/LO BATT LED** is flashing, the battery pack needs charging.

NO DIAL TONE.

First check all the suggestions above. If you still don't hear a dial tone, disconnect the base unit from the telephone jack and connect a different phone. If there is no dial tone on that phone either, the problem is in your wiring or local service. Call your local telephone company.

YOU GET NOISE, STATIC, OR A WEAK SIGNAL EVEN WHEN YOU'RE NEAR THE BASE UNIT.

Household appliances plugged into the same circuit as the base unit can sometimes cause interference. Try moving the appliance or the base unit to another outlet.

YOU GET NOISE, STATIC, OR A WEAK SIGNAL WHEN YOU'RE AWAY FROM THE BASE UNIT.

- You may be out of range. Either move close to the base, or relocate the base unit.
- The layout of your home may be limiting the range. Try moving the base unit to another position.

THE HANDSET DOES NOT RING WHEN YOU RECEIVE A CALL.

Make sure you have the handset ringer activated. To set the ringer see **PROGRAMMING THE RINGER** on page 19.

- Make sure the telephone line cord is plugged firmly into the base unit and the telephone jack. Make sure the power cord is plugged in.
- You may be too far from the base unit.
- You may have too many extension phones on your telephone line to allow all of them to ring. Try unplugging some of the other phones.





IN CASE OF DIFFICULTY

YOU HEAR OTHER CALLS WHILE USING YOUR PHONE.

Disconnect your base unit from the telephone jack, and plug in a regular telephone. If you still hear other calls, the problem is probably in your wiring or local service. Call your local telephone company.

YOU HEAR NOISE IN THE HANDSET, AND NONE OF THE KEYS OR BUTTONS WORK.

Make sure the power cord is plugged in.

COMMON CURE FOR ELECTRONIC EQUIPMENT

Electronics, like people, can sometimes get confused. If the unit does not seem to be responding normally, then try putting the handset in the cradle. If it does not seem to respond after trying this a few times, do the following (in the order listed):

1. Disconnect the power to the base.
2. Disconnect the handset battery.
3. Wait a few minutes.
4. Connect power to the base.
5. Connect the handset battery.
6. Put the handset in the base.





Warranty

WARRANTY STATEMENT

WHAT DOES OUR WARRANTY COVER?

- Any defect in material or workmanship.

FOR HOW LONG AFTER THE ORIGINAL PURCHASE?

- To the original purchaser only - ONE YEAR.

WHAT WILL VTECH DO?

- At our option, repair or replace your unit.

HOW DO I SEND MY UNIT, IN OR OUT OF WARRANTY?

- Call VTECH Communications customer service for Return Authorization at:
1-800-595-9511 in Canada 1-800-267-7377
- Properly pack your unit. Include any cables & accessories which were originally provided with the product. We recommend using the original carton and packing materials.
- Include in the package a copy of the sales receipt or other evidence of date of original purchase (if the unit was purchased within the last twelve months).
- Print your name and address, along with a description of the defect, and include this in the package.
- Include payment for any service or repair not covered by warranty, as determined by VTECH Communications.
- Ship the unit via UPS Insured, or equivalent to:

VTECH COMMUNICATIONS

8770 SW NIMBUS AVENUE BEAVERTON, OREGON 97008

IN CANADA VTECH ELECTRONICS

200-7671 Alderbridge Way Richmond, B.C. V6X 1Z9

VTECH Communications assumes no responsibility for units sent without prior Return Authorization.

WHAT DOES OUR WARRANTY NOT COVER?

- Batteries
- Damage from misuse, neglect, or acts of nature (lightning, floods, power surges, etc.)
- Products which may have been modified or incorporated into other products
- Products purchased and/or operated outside the USA, its territories, or Canada.
- Products serviced by the owner or a service facility not expressly authorized by VTECH Communications
- Products purchased more than 12 months from current date
- Units purchased in "AS IS" condition, or units purchased as "Distressed Merchandise".

HOW DOES STATE LAW OR PROVINCIAL LAW RELATE TO THIS WARRANTY?

- This warranty gives you specific rights. You may also have other rights which vary from state to state or province to province.





TECHNICAL SPECIFICATIONS

FREQUENCY CONTROL

Crystal Controlled Dual PLL Synthesizer

TRANSMIT FREQUENCY

Handset: 925.05 MHz to 927.75 MHz (All ten channels within this range)

Base: 902.3 MHz to 905.0 MHz (All ten channels within this range)

RECEIVE FREQUENCY

Handset: 902.3 MHz to 905.0 MHz (All ten channels within this range)

Base: 925.05 MHz to 927.75 MHz (All ten channels within this range)

NOMINAL EFFECTIVE RANGE

Maximum power allowed by FCC and IC. Actual operating range may vary according to environmental conditions at the time of use.

SIZE

Handset: 188 x 62 x 35mm

Base : 210 x 145 x 148

WEIGHT

Handset: 282g

Base : 428g

POWER REQUIREMENTS

Handset: Self-contained nickel-cadmium rechargeable battery supply, 3.6V nominal, 600mAh capacity.

Base : 9VDC @ 300mA

MEMORY

Memory Dial: 20 Memory locations, 20 digits per location.

**SPECIFICATIONS ARE TYPICAL AND
MAY CHANGE WITHOUT NOTICE**



TABLE OF CONTENTS

	Page
INTRODUCTION	1
SPECIAL FEATURES	2
PARTS CHECK LIST	3
THE HANDSET LAYOUT	4
THE BASE UNIT LAYOUT	5
FCC AND IC REGULATIONS	6
IMPORTANT SAFETY INSTRUCTIONS	9
REPLACING THE HANDSET BATTERY PACK	10
GETTING STARTED	14
WALL MOUNTING	16
QUICK REFERENCE GUIDE	18
BASIC OPERATION	20
Answering Calls.....	20
Making Calls	20
Disconnecting	20
Extension In Use Indicator	20
Volume Controls	20
Flash	20
Redial	20
Hold	20
Mute	20
Ringer Mute	20
Page	20
ADVANCED FUNCTIONS	21
Temporary Tone	21
Programming The Ringer	21
Changing Ringer Types	21
Turning Off The Ringer	22
Checking The Ringer Type	22
MEMORY (SPEED) DIALING	23
Storing Speed Dial Numbers	23
Memory Dialing	23
Quick Memory Dialing	23
Storing Numbers Using Redial	24
Dialing From Memory	24
Changing Stored Numbers	25
Deleting Stored Numbers	25
Storing Special Codes	25
MAINTENANCE	26
ADDITIONAL OPERATING TIPS	27
IN CASE OF DIFFICULTY	28
WARRANTY	30
TECHNICAL SPECIFICATIONS	31



VTECH COMMUNICATIONS LTD.



Is a trademark of VTECH COMMUNICATIONS LTD., a member of THE VTECH GROUP OF COMPANIES.

Distributed in the U.S.A. by VTECH Communications, 8770 SW Nimbus Avenue / Beaverton, Oregon, 97008.
Distributed in Canada by VTECH Electronics Canada Ltd., Suite 200 - 7671 Alderbridge Way Richmond, B.C. V6X 1Z9.

Copyright 1997 for VTECH COMMUNICATIONS LTD..

91-5005-13-00
ISSUE 0



Free Manuals Download Website

<http://myh66.com>

<http://usermanuals.us>

<http://www.somanuals.com>

<http://www.4manuals.cc>

<http://www.manual-lib.com>

<http://www.404manual.com>

<http://www.luxmanual.com>

<http://aubethermostatmanual.com>

Golf course search by state

<http://golfingnear.com>

Email search by domain

<http://emailbydomain.com>

Auto manuals search

<http://auto.somanuals.com>

TV manuals search

<http://tv.somanuals.com>