

USER'S MANUAL

VT 1921

900MHz CORDLESS TELEPHONE



VTECH

VTECH COMMUNICATIONS LTD.

VTECH

Is a trademark of VTECH COMMUNICATIONS LTD., a member of THE VTECH GROUP OF COMPANIES.

Distributed in the U.S.A. by VTECH Communications, 8770 SW Nimbus Avenue / Beaverton, Oregon, 97008.
Distributed in Canada by VTECH Electronics Canada Ltd., Suite 200 - 7671 Alderbridge Way Richmond, B.C. V6X 1Z9.

Copyright 1997 for VTECH COMMUNICATIONS LTD..
Printed in China

91-5082-10-00
ISSUE 0

VTECH

VTECH COMMUNICATIONS LTD.

IMPORTANT

BEFORE USING YOUR NEW PHONE, WE STRONGLY RECOMMEND YOU READ THIS MANUAL THOROUGHLY.



OPTIONAL HEADSET INSTALLATION AND OPERATING INSTRUCTIONS

OPERATION

NOTE: Whenever a compatible Headset is connected to the cordless Handset, the microphone on the Handset will be **MUTED**. This is done to limit the effect of background noise.

The following operational characteristics apply to **VTech** Headsets. The same may also apply to other (non-**VTech**) compatible headsets, but **VTech** assumes no responsibility for their performance.

The **VTech** brand compatible Headset has a monaural design which is reversible, so you can wear your Headset on either the left or right ear, leaving one ear free for room conversation.

The headband can be adjusted to fit the contour of your head. Using both hands, slide the headband up or down so that it rests comfortably on your head with the speaker cushion centered against your ear.

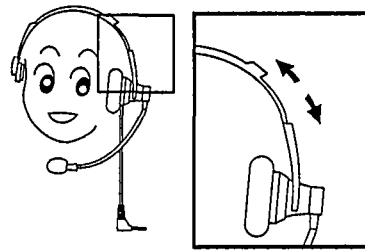

For maximum sound quality, the flexible microphone should be positioned at the corner of your mouth, about one inch from your mouth.

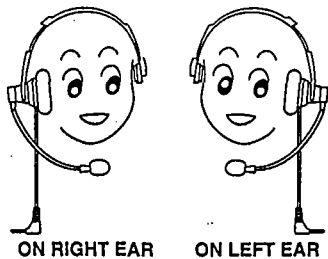
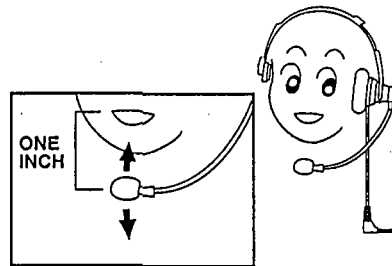

OPTIONAL HEADSET INSTALLATION AND OPERATING INSTRUCTIONS

Your **VTech** cordless telephone is equipped with a 2.5mm Headset Jack for use with an **optional** accessory Headset for hands-free operation

If you choose to use the Headset option, you must do the following:

INSTALLATION

Obtain an optional accessory Headset, which is compatible with the **VTech** cordless telephone

Please contact **VTech Communications Customer Service**, toll-free at **1-800-595-9511**, in Canada at **1-800-267-7377**, for dealer information in your local area. You can also purchase a compatible Headset directly from **VTech Communications Customer Service**.

Once you have a compatible 2.5mm Headset, locate the Headset Jack on the Handset of your **VTech** cordless telephone. Connect the plug on the Headset to the jack on the cordless Handset. The plug should fit securely. Do not force the connection. See illustration

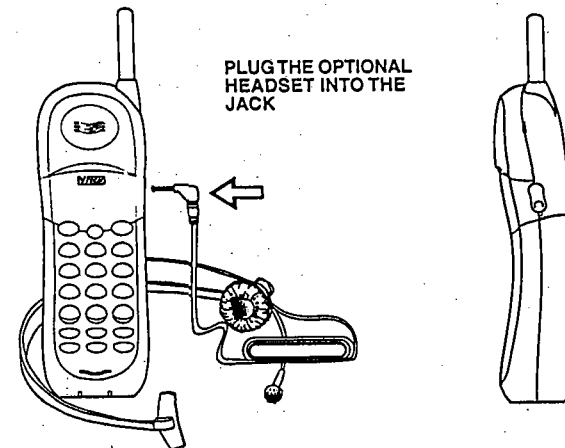

TABLE OF CONTENTS

| | Page |
|-------------------------------------|------|
| INTRODUCTION | 1 |
| Special Features | 2 |
| Parts Check List | 3 |
| FCC AND IC REGULATIONS | 4 |
| IMPORTANT SAFETY INSTRUCTIONS | 7 |
| REPLACING THE BATTERY PACK | 9 |
| GETTING STARTED | 13 |
| WALL MOUNTING | 15 |
| THE LCD DISPLAY | 16 |
| THE HANDSET LAYOUT | 17 |
| THE BASE UNIT LAYOUT | 18 |
| QUICK REFERENCE GUIDE | 19 |
| BASIC OPERATION | 21 |
| ADVANCED FUNCTIONS | 22 |
| CID With Call Waiting | 22 |
| Switching Calls | 22 |
| Temporary Tone | 22 |
| Programming The Ringer | 22 |
| Changing Ringer Types | 22 |
| CALL WAITING | 22 |
| TEMPORARY TONE | 22 |
| Turning Off The Ringer | 23 |
| Checking The Ringer Type | 23 |
| CLR/DEL Key Function | 23 |
| Advanced Dialing | 24 |
| MEMORY DIALING | 25 |
| Storing Speed Dial Numbers | 25 |
| Dialing From Memory | 26 |
| Changing Stored Numbers | 26 |
| Deleting Stored Numbers | 26 |
| Storing Special Codes | 27 |
| CID-CALLER ID | 28 |
| CID-CALLER ID | 28 |
| Receiving and Storing Calls | 28 |
| Dialing From CID Memory | 28 |
| Out Of Area Calls | 29 |
| "Private" Calls | 29 |
| Transmission Error | 29 |
| Reviewing Numbers | 30 |
| Deleting Numbers | 31 |
| ADDITIONAL OPERATING TIPS | 32 |
| MAINTENANCE | 33 |
| IN CASE OF DIFFICULTY | 35 |
| WARRANTY | 36 |
| TECHNICAL SPECIFICATIONS | 37 |

INTRODUCTION

Congratulations! You have purchased one of the most sophisticated cordless telephones on the market! The VT 1921 has been designed to offer a new standard in cordless telephone technology.

Unlike most other cordless phones, the VT 1921 digitizes your voice using advanced ADPCM digital voice coding to provide noise and distortion free performance. In most conditions you will not be able to tell you are using a cordless phone. Gone are the annoyances of static, interference and having to listen to other people's conversations on your cordless phone.

The VT 1921 scrambles your voice before it transmits it. This allows you the security of knowing that no one can tune in and eavesdrop on your conversations.

The VT 1921 decodes and displays name and/or number Caller ID (CID) information where available and when subscribed to. The alpha-numeric display can show both the name and number of the calling party. Up to 24 name characters or 11 phone number digits can be displayed on the LCD.

With the VT 1921, the user can easily answer a call by pressing any key other than the OFF, MUTE or VOLUME Keys. In addition, the handset keypad and LCD illuminate while the handset rings to signal an incoming call. This is very useful in a dark environment. The VT 1921 also provides a one-way Page/Find. Pressing the base

PAGE key will cause the handset to ring in a manner which distinguishes it from normal incoming ringing. This can be used to alert the handset user, or to simply locate the handset in the event that it is misplaced.

The VT 1921 uses special memory in both the base and handset which is not susceptible to power failures. This provides permanent storage of all memory dial numbers, CID information as well as the base and handset security codes.

When an optional battery pack is installed in the base unit, the VT 1921 uses this battery pack to provide operational backup in case of power failure. In this way you have access to all normal phone functions during a total power outage. Calls can still be placed and received without interruption. More than 5 hours backup will be possible with a fully charged battery pack in the base unit.

The VT 1921 informs you that another extension is currently in use on the same phone line. The phone will also alert you when you are Out of Range, even when you're not using the phone!

INTRODUCTION

SPECIAL FEATURES

- 900 MHz Operation.
- Fully Digital Link between Handset and Base with ADPCM voice coding.
- Digitally-Scrambled Voice Communication.
- Name / Number CID display.
- 2 row by 12 character 5x7 dot matrix alpha-numeric LCD.
- 50 CID memory locations.
- Backlit LCD on the handset.
- Backlit handset keypad.
- 20 location Programmable Memory for 20 Digit Phone Number.
- 10 Channel Operation with auto channel selection.
- Out-of-Range indication while the handset is in use or in standby mode.
- Removable handset battery pack.
- Spare battery charger in the base unit.
- Complete battery back-up in case of power failure (with optional spare battery pack installed in base).
- Face-up Handset charging.

- Easy answer - When the phone rings, simply press any key other than OFF, MUTE, or the Volume Keys on the handset to answer.
- Auto hang up when returning the handset to the base' cradle.
- Extension in use indicator.
- 24 Bit Digital Security Code.
- DTMF and Pulse Dialing.
- Low Battery Detect and Warning indicator.
- Up to 7 hours continuous talk time or 7 days standby time.
- Volume Adjust on Handset.
- REDIAL, HOLD, PAGE and MUTE.
- Hearing-Aid Compatible Receiver.
- Detachable power supply.
- Non-volatile storage of security code and memory dial records.
- Programmable Ringer Types.

This manual is designed to make you familiar with the VT 1921. We strongly recommend you read the manual before using your phone.

INTRODUCTION

Parts Check List

1. Base unit, Handset and AC adaptor
2. One-Line Telephone Cord
3. Battery Pack
4. Wall mount accessory
5. Belt clip

To purchase replacement battery packs, call VTECH Communications at 1-800-595-9511 in the U.S. and 1-800-267-7377 in Canada.

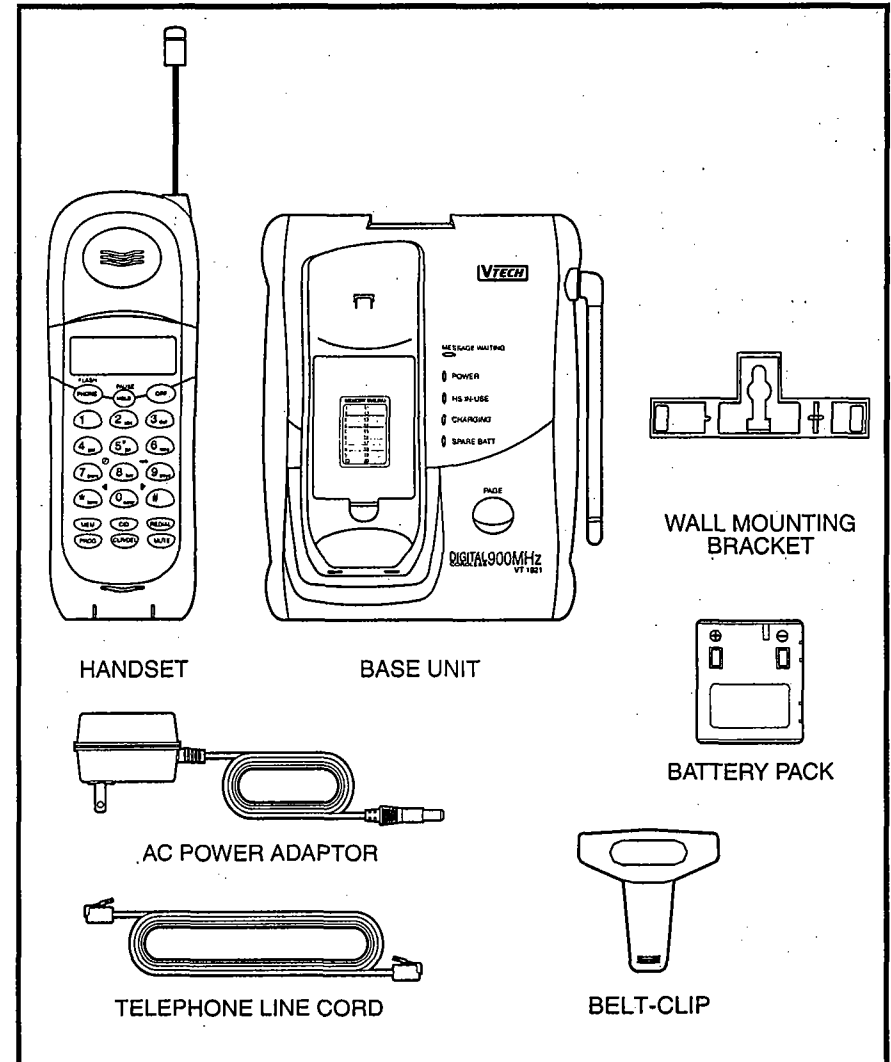

This equipment complies with Parts 15 and 68 of the Federal Communications Commission (FCC) rules for the United States. It also complies with regulations RSS210 and CS-03 of Industry and Science Canada. Operation is subject to the following two conditions: (1) this device may not cause interference, and (2) this device must accept any interference, including interference that may cause undesired operation of the device.

A label is located on the underside of the base unit containing either the FCC registration number and Ringer Equivalence Number (REN) or the IC registration number and Load Number. You must, upon request, provide this information to your local telephone company.

This equipment is compatible with inductively coupled hearing aids.

Should you experience trouble with this telephone equipment, please contact:

VTECH COMMUNICATIONS
SERVICE DEPT. at 1-800-595-9511
in the U.S. and 1-800-267-7377
in Canada.

For repair/warranty information. The telephone company may ask you to disconnect this equipment from the line network until the problem has been corrected.

FCC Part 15

Warning: Changes or modifications to this unit not expressly approved by the party responsible for compliances could void the user's authority to operate the equipment.

The equipment has been tested and found to comply with part 15 of the FCC rules. These limits are designed to provide reasonable protection against harmful interference in a residential installation. This equipment generates, uses and can radiate radio frequency energy and, if not installed and used in accordance with the instructions, may cause harmful interference to radio communications. However, there is no guarantee that interference will not occur in a particular installation. If this equipment does cause harmful interference to radio or television reception, which can be determined by turning the equipment off and on, the user is encouraged to try and correct the interference by one or more of the following measures:

- Reorient or relocate the receiving antenna.
- Increase the separation between the equipment and receiver.
- Connect the equipment into an outlet or on a circuit different from that to which the receiver is connected.
- Consult the dealer or an experienced radio/TV technician for help.

FCC Part 68

The FCC requires that you connect your cordless telephone to the nationwide telephone network through a modular telephone jack (USOC RJ11C, RJ11W or RJ14).

Your telephone company may discontinue your service if your equipment causes harm to the telephone network. They will notify you in advance of disconnection, if possible. During notification, you will be informed of your right to file a complaint with the FCC.

Occasionally, your telephone company may make changes in its facilities, equipment, operation, or procedures that could affect the operation of your equipment. If so, you will be given advance notice of the change to give you an opportunity to maintain uninterrupted service.

The base unit contains no user serviceable parts. The handset contains a user replaceable battery pack.

If it is determined that your telephone equipment is malfunctioning, the FCC requires that it not be used and that it be unplugged from the modular jack until the problem has been corrected. Repairs to this telephone equipment can only be made by the manufacturer or its authorized agents or by others who may be authorized by the FCC. For repair procedures, follow the instructions outlined under the VTECH Limited Warranty.

This equipment may not be used on coin service provided by the phone company or Party Lines.

The REN is useful in determining the number of devices you may connect to your telephone line and still enable the devices to ring when you receive a call. The general rule is that the REN value should not exceed 5.0A total; however, contact your local telephone company for the specific number in your area.

IC (Industry Canada)

This telephone is registered for use in Canada.

Notice: The REN assigned to this device denotes the number of devices you may connect to the telephone loop which is used by the device to prevent overloading. The termination on a loop may consist of any combination of devices subjected only to the requirement that the sum of the REN does not exceed five (5.0).

Notice: The Industry Canada label identifies certified equipment. This certification means that the equipment meets certain telecommunications network protective, operational and safety requirements. The Department does not guarantee the equipment will operate to the user's satisfaction.

Before installing this equipment, users should ensure that it is permissible to be connected to the facilities of the local telecommunications company. The equipment must also be installed using an acceptable method of connection. The customer should be aware that compliance with the above conditions may not prevent degradation of services in some situations.

Repairs to certified equipment should be made by an authorized Canadian maintenance facility designated by the supplier. Any repairs or alterations made by the user to this equipment, or equipment malfunctions, may give the telecommunications company cause to request the user to disconnect the equipment.

Users should ensure for their own protection that the electrical ground connections of the power utility, telephone lines and internal metallic water pipe system, if present, are connected together. This precaution may be particularly important in rural areas.

Caution: Users should not attempt to make such connections themselves, but should contact the appropriate electrical inspection authority, or electrician, as appropriate.

Your VT 1921 is designed to operate at the maximum power allowed by the FCC and IC. This means your handset and base unit can communicate only over a certain distance - which will depend on the location of the base unit and handset, weather, and the construction and layout of your home or office.

When using your telephone equipment, basic safety precautions should always be followed to reduce the risk of fire, electric shock and injury to persons, including the following:

1. Read and understand all instructions.
2. Follow all warnings and instructions marked on the product.
3. Unplug this product from the wall outlet before cleaning. Do not use liquid cleaners or aerosol cleaners. Use a damp cloth for cleaning.
4. Do not use this product near water (for example, near a bath tub, kitchen sink, or swimming pool).
5. Do not place this product on an unstable cart, stand, or table. The product may fall, causing serious damage to the product.
6. Slots and openings in the cabinet and the back or bottom are provided for ventilation. To protect it from overheating, these openings must not be blocked by placing the product on the bed, sofa, rug, or other similar surface. This product should never be placed near or over a radiator or heat register. This product should not be placed in a built-in installation where proper ventilation is not provided.

7. This product should be operated only from the type of power source indicated on the marking label. If you are not sure of the type of power supply to your home, consult your dealer or local power company.
8. Do not allow anything to rest on the power cord. Do not locate this product where the cord will be abused by persons walking on it.
9. Never push objects of any kind into this product through cabinet slots as they may touch dangerous voltage points or short out parts that could result in a risk of fire or electric shock. Never spill liquid of any kind on the product.
10. To reduce the risk of electric shock, do not disassemble this product, but take it to a VTECH authorized service facility. Opening or removing cabinet parts other than specified access doors may expose you to dangerous voltages or other risks. Incorrect reassembling can cause electric shock when the appliance is subsequently used.
11. Do not overload wall outlets and extension cords as this can result in the risk of fire or electric shock.

IMPORTANT SAFETY INSTRUCTIONS

12. Unplug this product from the wall outlet and refer servicing to a VTech authorized service facility under the following conditions:
- When the power supply cord or plug is damaged or frayed.
 - If liquid has been spilled into the product.
 - If the product has been exposed to rain or water.
 - If the product does not operate normally by following the operating instructions. Adjust only those controls that are covered by the operating instructions, because improper adjustment of other controls may result in damage and will often require extensive work by a VTech authorized technician to restore the product to normal operation.
 - If the product has been dropped and the cabinet has been damaged.
 - If the product exhibits a distinct change in performance.
13. Avoid using a telephone (other than a cordless type) during an electrical storm. There may be a remote risk of electric shock from lightning.
14. Do not use the telephone to report a gas leak in the vicinity of the leak.

VTECH COMMUNICATIONS
SERVICE DEPT. at 1-800-595-9511
in the U.S. and 1-800-267-7377
In Canada.

SAVE THESE INSTRUCTIONS

REPLACING THE BATTERY PACK

CHARGING THE HANDSET BATTERY PACK

The handset of your VT 1921 cordless telephone is powered by a rechargeable battery pack. It charges automatically whenever the handset is in the base. You should charge the battery pack for 16 hours when you first receive your phone. You'll know the battery pack needs charging when:

- The phone emits a warning tone when you press the PHONE key.
- The low battery message is displayed:



- The handset seems completely dead, the LCD is clear and the handset does not beep when you press the keys.

To Charge The Battery Pack

To charge the battery pack, place the handset in the base unit. The CHARGE indicator will light to show the handset is seated properly and the battery pack is charging. It is recommended that the battery pack be charged for at least 16 hours initially and 8 hours for maintenance charging. You can use your telephone before that with diminished capacity, but it is best to charge the battery pack fully. It will take several recharge cycles to maximize the charge capacity of your battery pack. The maximum battery life between charges is 7 hours of continuous talk time or 7 days of stand by.

Alternatively, if you have purchased a spare battery pack and it has been charging in the base unit, simply exchange the drained handset battery pack with the fully charged replacement battery pack from the base charger. Place the drained handset battery pack into the base charger to recharge.

The base spare battery charger does NOT charge a battery pack as quickly as the handset battery charger. A full charge requires 24 hours when using the spare battery charger.

IT'S IMPOSSIBLE TO OVER CHARGE THE BATTERY PACK

The battery pack can be recharged many times, but if you get a low-battery signal even after 16 hours of charging in the base cradle (or 24 hours in the base spare battery charger), the battery pack(s) should be replaced.

To purchase replacement battery packs, call VTech Communications at 1-800-595-9511 in the U.S. and VTech Electronics Canada Ltd at 1-800-267-7377 in Canada.

A WORD ABOUT RECHARGEABLE BATTERIES

Your Nicad battery pack recharges whenever the Handset is returned to the Base Unit cradle. You may return the Handset to its cradle whenever you're not using the phone.

REPLACING THE BATTERY PACK

Follow the steps below:

1. Remove the battery case cover by pressing on the ridged lines and sliding downward.

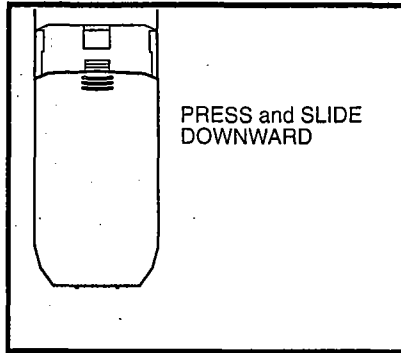

2. Discard the old battery pack. Don't put the old battery pack in a trash compactor or a fire - it could burst.
3. Place the new battery pack in its housing with the metal contacts facing down.

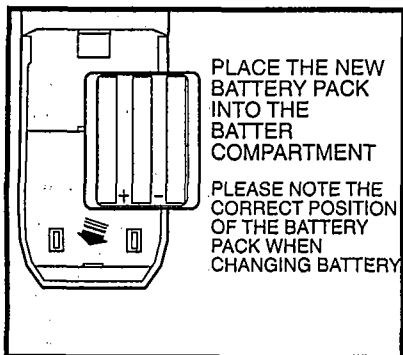

4. Replace the battery case cover by sliding the cover upwards.

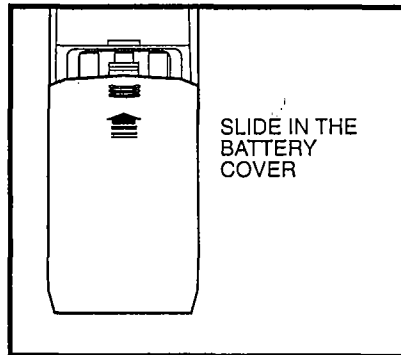

5. If the new battery pack is not already charged, place the handset in the cradle of the base unit to allow it to charge for 16 hours.

CAUTION:
To Reduce the Risk of Fire or Injury to persons, read and Follow the Instructions

1. Use only VTECH rechargeable battery pack.
2. Do not dispose of the battery in a fire. The cell may explode.

IMPORTANT: Do not dispose of this battery into household garbage. For information on recycling or proper disposal, consult your local solid waste collection or disposal organization.

3. Do not open or mutilate the battery. Released electrolyte is corrosive and may cause damage to the eyes or skin. It may be toxic if swallowed.

REPLACING THE BATTERY PACK

4. Do not dispose of the battery in a fire. The cell may explode.



The RBRC Seal

The RBRC® Seal on the (easily removable) nickel-cadmium battery (contained in our product) indicates that VTech Communications, INC. is voluntarily participating in an industry program to collect and recycle these batteries at the end of their useful lives, when taken out of service within the United States and Canada.

The RBRC® program provides a convenient alternative to placing used nickel-cadmium batteries into the trash or municipal waste, which be illegal in your areas.

VTech's payments to RBRC® make it easy for you to drop off the spent battery at local retailers participating in the RBRC® program or at authorized VTech product service centers. Please call

1-800-8-BATTERY™ for information on Ni-Cd battery recycling and disposal bans/restrictions in your area. VTech's involvement in this program is part of its commitment to protecting our environment and conserving natural resources.

Remove the nickel-cadmium battery pack by pressing on the lock knob and sliding downward as mentioned on this page.

RBRC® is a registered trademark of Rechargeable Battery Recycling Corporation.

REPLACING THE BATTERY PACK

- Exercise care in handling batteries in order not to short the battery with conducting materials such as rings, bracelets, and keys. The battery or conductor may overheat and cause burns.

To purchase replacement battery packs, call VTECH at 1-800-595-9511 in the U.S. and 1-800-267-7377 in Canada.

SPARE BATTERY CHARGER

The VT 1921 has a built-in spare Battery Charger, which is located in the cradle of the Base Unit.

NOTE: In order to benefit from this feature, you must obtain an optional Spare Battery from an authorized VTECH dealer or by contacting VTECH Customer Service at 1-800-595-9511 in the U.S.A. and VTECH Electronics Canada Ltd. at 1-800-267-7377 in Canada.

Installation

Remove the Spare Battery charger cover by pressing the release tab and lifting up.

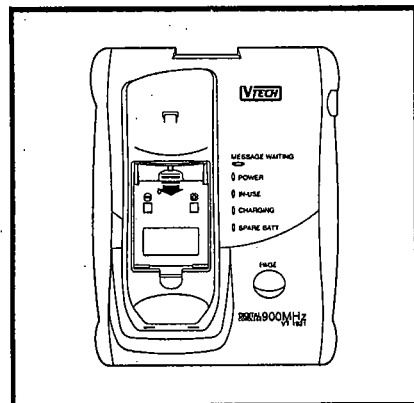

Place a battery pack in the Spare Battery charger. Make sure the metal charging contacts on the underside of the battery pack are aligned with the charging contacts in the Spare Battery charger.

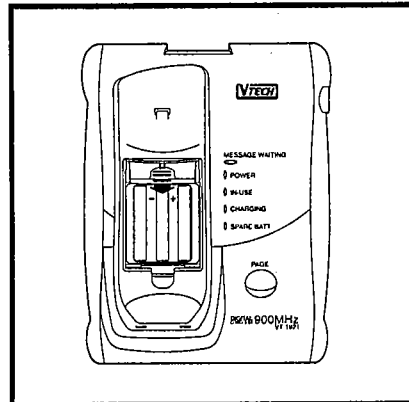

Power Backup

When a Spare Battery pack is installed in the Base Unit, the VT 1921 uses this battery pack to provide operational backup in case of a power failure. If you have a fully charged battery pack in the Spare Battery pack charger and there is a power outage, you will still be able to place and receive calls for up to five hours. However, Caller ID may not function properly.

Replacing a Drained Handset battery

The Spare battery pack can also be used to replace a drained Handset battery pack to ensure uninterrupted use. Be sure to put the drained battery pack in the Spare Battery charger for recharging.

Please note that the Spare Battery compartment charges at a slower rate than a battery pack charging in the Handset. It takes 24 hours to fully charge a battery pack in the Spare Battery charger.

GETTING STARTED

Setting Up Your VT-1921

Choose an area near an electrical outlet and a telephone wall jack.

AC Power Adaptor

Plug the AC power adaptor into an electrical outlet and the DC connector to the back of the base unit.

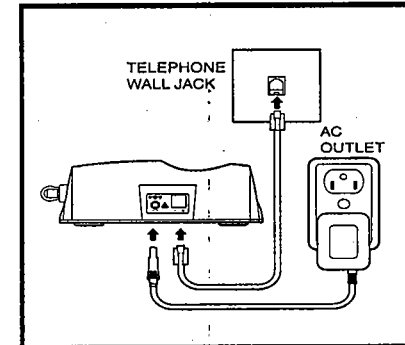

CAUTION: Use only CLASS 2 9V DC POWER SUPPLY included with your phone.

Handset Ringer

The handset ringer is programmed ON as the factory default setting. Refer to **PROGRAMMING THE RINGER** on page 23 for more information.

Setting the Tone/Pulse Switch

The TONE/PULSE switch is located on the bottom of the base unit and is factory set to TONE. If you have touch tone service, do not change the switch setting. If you have rotary (Pulse) service, set the switch to PULSE.

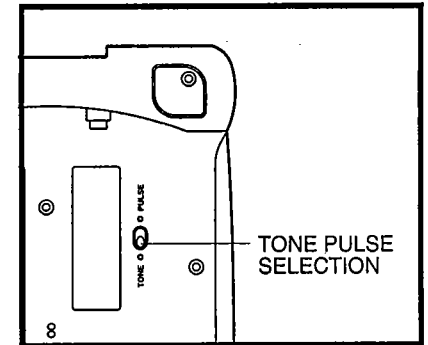

Charge the handset battery pack before use. The battery pack recharges automatically whenever the handset is in the base unit. The batteries must be charged for 16 hours before using your phone for the first time.

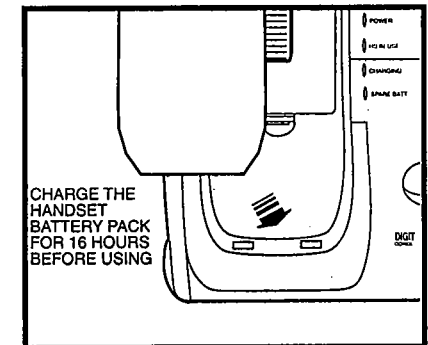

Connect Telephone Line Cord

Plug one end of the telephone cord into a wall jack and the other end into the back of the Base Unit.

GETTING STARTED

Check for a dial tone. After the battery pack is charged, rotate the Base Unit antenna to an upright position. Pick up the Handset and press **PHONE**. "PHONE ON" will appear on the LCD, and you will hear a dial tone. If not, see 'IN CASE OF DIFFICULTY' on page 34.

Fill in the telephone number card on the base unit.

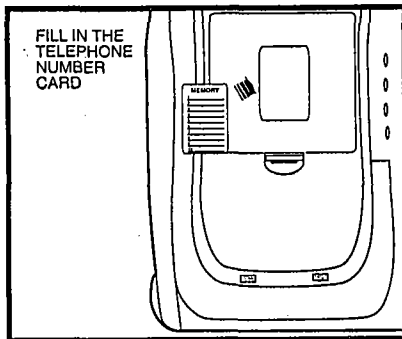

CAUTION:

1. Never install telephone wiring during a lightning storm.
2. Never install telephone jacks in wet locations unless the jack is specifically designed for wet locations.
3. Never touch uninsulated telephone wires or terminals unless the telephone line has been disconnected at the network interface.
4. Use caution when installing or modifying telephone lines.

WALL MOUNTING

USING THE WALL MOUNT ADAPTOR

1. Position the wall mount bracket on the base.

Line up the tabs on the wall mount adaptor with the holes on the bottom of the base (Figure 1). Snap the wall mount bracket firmly in place.

2. Mount the base on the wall.

Position the base so the mounting studs will fit into the holes on the bottom of the base. Position the power cord to extend down the wall the phone is to be mounted on. Slide the base down on the mounting studs until it locks into place.

3. Connect the telephone line cord.

The telephone line cord has a snap-in plug at each end. Insert one of the plugs into the jack on the bottom of the base. Insert the other end of the plug into the wall jack.

4. Plug the AC adaptor into an electrical outlet and the DC connector into the power jack located on the back of the Base Unit.

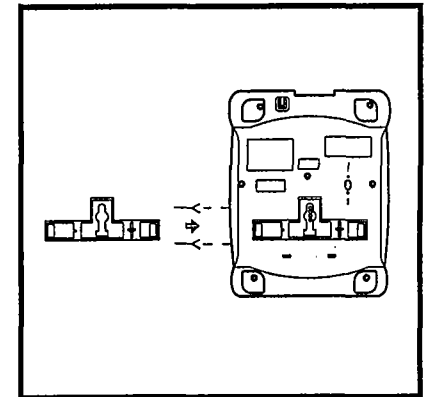

Figure 1

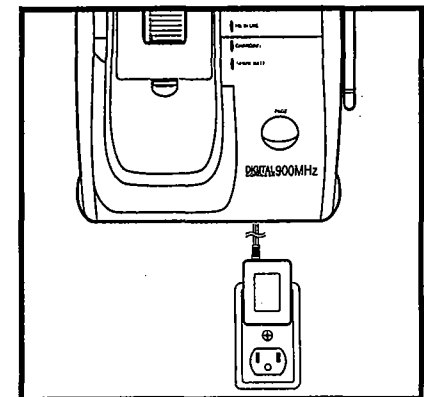

Figure 2

THE LCD DISPLAY

ABCDEFGHIJKL
123456789*#

LCD Display Messages

PHONE ON

the PHONE ON indicator is displayed when the phone is in use.

VOLUME 

shows the handset volume setting.

LOW BATTERY

is displayed when the unit is in a low-battery condition. The handset typically operates for at least 5 minutes after the low battery indication first appears.

BASE PAGING
HANDSET

is displayed when the Base Unit pages the handset.

CALL ON HOLD

is displayed when the handset is on hold.

MICROPHONE
MUTED

is displayed when the handset microphone has been muted.

RINGER OFF
SELECTED

is displayed when the handset ringer has been programmed off.

CHANNEL
SEARCHING...

is displayed when the handset has lost communication with the base unit and is attempting to reestablish a link by scanning all channels.

FOUND
CHANNEL X

is displayed if communication with the base is reestablished.

EXTENSION
IN USE

is displayed while in OFF mode, if another phone is currently using the same line.

THE HANDSET LAYOUT

THE HANDSET FEATURES

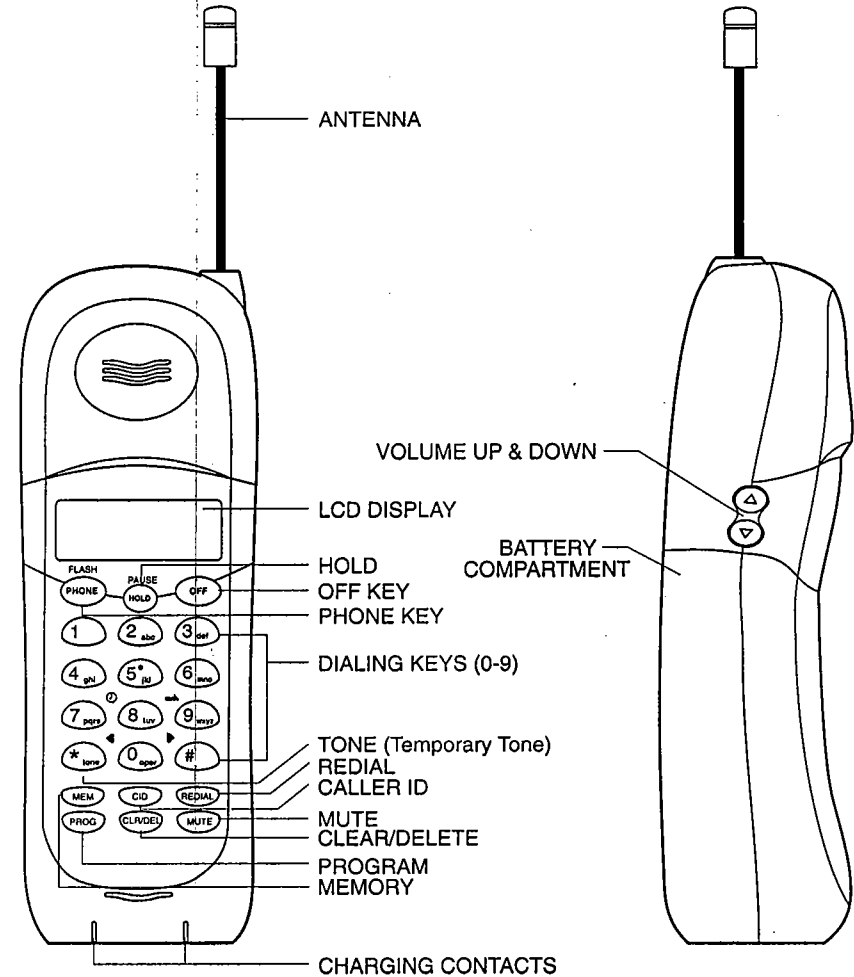

THE BASE UNIT FEATURES

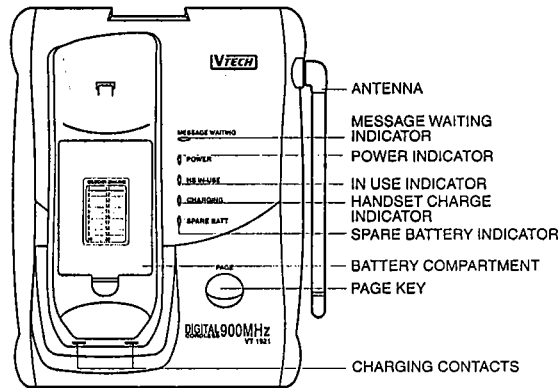
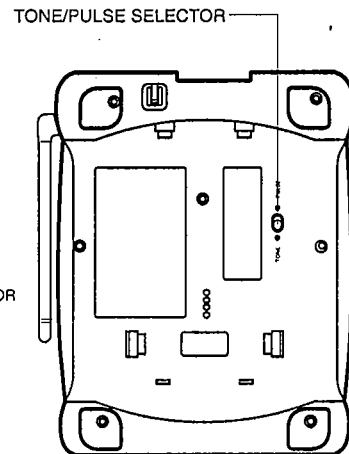
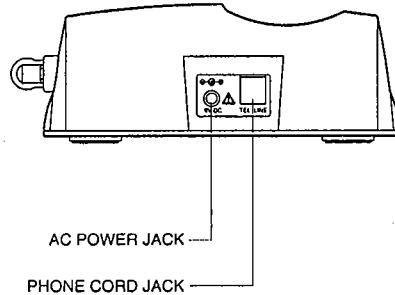

TO MUTE A CALL

- Press **(MUTE)** to disable the handset microphone.
- Press **(MUTE)** again to return to normal two way conversation.

TO PAGE THE HANDSET

- To page from the base, press **(PAGE)**.
- To cancel the **PAGE** either press **(PAGE)** again on the base or press **(OFF)** on the handset.

STORING MEMORY (SPEED) DIAL NUMBERS

- The phone should be **OFF**.
- Enter the number you wish to store on the LCD up to a maximum of 20 digits.

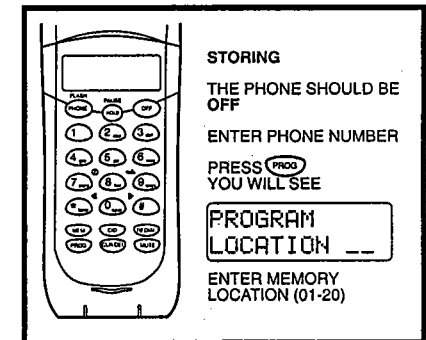

- Press **(PROG)**. The LCD will display "PROGRAM LOCATION _ _ _"
- Enter a two digit memory location (01 .. 20), the unit will store the number, emit a happy tone to confirm successful programming and exit program mode.

SET-UP

- Plug AC adaptor into a standard electrical outlet and Base Unit
- Set Dial Mode switch to **PULSE** or **TONE**. The unit is factory set to **TONE**.
- Let the handset battery pack charge for 16 hours before first use.
- Connect telephone line cord to base unit and telephone jack.

MAKING CALLS

- Press the **(PHONE)** key. When the "PHONE ON" indicator is displayed and you hear a dial tone, dial the number.
- OR
- Enter the number to be dialed on the **LCD** and then press the **(PHONE)** key.

ANSWERING CALLS

- To answer a call, press any key other than **(OFF)**, **(MUTE)**, or the Volume Keys. The handset will NOT auto-answer when lifted off the base cradle.

HANGING UP

- Press **(OFF)** or place the handset in the cradle to hang up a call.

TO PLACE A CALL ON HOLD

- Press **(HOLD)** on the handset to place an active call on hold. Press **(HOLD)** again to return to the call.

MEMORY DIALING (SPEED DIALING)

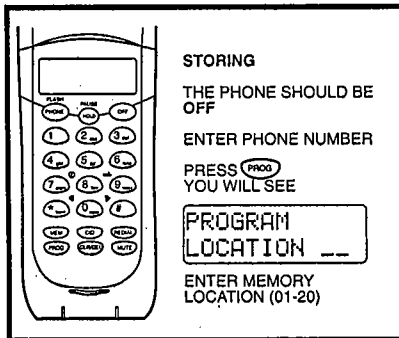

- Press the **PHONE** key.
- Press **MEM**.
- Enter the memory location of the phone number you wish to dial (01...20). The number will be displayed on the LCD and will be dialed.

CID - CALLER ID

- To view information stored in CID memory, press **CID** on the handset.



- The display will show the most recent call received.

- To view the time and date of the call press and hold the 7 key. The time and date will be shown along with the phone number. You will see something like:



As long as the key is held down.

- To view other calls, scroll backwards and forwards by using the (*****) and (**#**) keys.
- To view additional digits not shown on the display, press the **→** (**9**) key
- To exit press **OFF**.

USING REDIAL

- Press the **PHONE** key, then **REDIAL** to automatically redial out the last number you dialed.

Or

- Press **REDIAL** so that the number is shown on the display and then press the **PHONE** key.

HOLD

- Press **HOLD** to put a call on hold.
- To return to the call, press **HOLD** again

MAKING CALLS

NOTE: There are two different ways to dial a number:

1. Press the **PHONE** key and wait for dial tone. Then dial the number you want.
- Or
2. Enter the number onto the display first, then press the **PHONE** key. This will dial the number that is displayed on the LCD after 2 seconds. See "ADVANCED DIALING" on Page 24

If you make a mistake when dialing, press **OFF** to hang up, then press the **PHONE** key to get the dial tone again.

DISCONNECTING

To end a call, either place the handset back in the base, or press **OFF** on the handset.

ANSWERING CALLS

When the Handset rings, press any key other than **OFF**, **MUTE** or the **VOLUME** keys to answer your call.

VOLUME CONTROLS

The volume controls for the handset are located on the side of the unit. Press the (up) or (down) keys to increase or decrease the volume. Holding either key down will continuously change the volume setting. The earpiece volume level indicator on the LCD will change accordingly. There are four volume levels.

FLASH

You can use your VT 1921 cordless phone with services such as Call Waiting. Simply press the **PHONE** key to FLASH the line.

REDIAL

To **REDIAL** the last number you dialed, press the **PHONE** key, then press **REDIAL**. The phone will automatically dial the number. The number will be shown on the display.

CLEARING THE DISPLAY

The display can be cleared by pressing and holding the **CLEAR/DEL** key down until the display clears.

MUTE

- Press **MUTE** during conversation to disable the handset microphone.
- Press **MUTE** again to return to normal operation.

RINGER MUTE

- Press **MUTE** during incoming ringing to disable the ringer for the duration of the call.

HOLD

- Press **HOLD** to place an active call on hold.
- The LCD will display CALL ON HOLD.
- Press **HOLD** again to return to the call.

PAGE/HANDSET LOCATOR

- To page from the Base Unit, press **PAGE**.
- The LCD will display BASE PAGING HANDSET.
- To cancel the page, either press **PAGE** again on the Base Unit, or press **OFF** on the Handset.

ADVANCED FUNCTIONS

CALL WAITING

While you are on a call, you will hear an alert signal, warning that a second caller is trying to reach you. CALL WAITING is a subscription service, available from most local telephone service providers. Contact your provider for details.

If you subscribe to this service linked with CALLER ID (CID), the name and/or phone number of the second caller can be displayed on the LCD immediately after hearing the CALL WAITING alert. For more details, see **CID-CALLER ID**.

Switching calls using FLASH

- To switch over to the new call, press the **PHONE** key; the first call is put on hold.
- To switch back to the first call, press the **PHONE** key again.

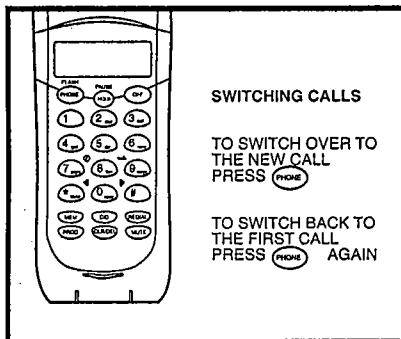

Message Waiting

Your VT 1921 is capable of detecting a Visual Message Waiting Indication, generated by many phone service providers. If you subscribe to Voicemail service from your local telephone company, and Visual Message Waiting Indication is provided, the VT 1921 will display the following data to alert you to new, unplayed messages:



Simultaneously, the Message Waiting indicator on the Base will flash slowly. Once you have reviewed your new messages, the **MSG. WAITING** indication on the handset, and the Message Waiting indicator light on the Base will be cleared.

You can temporarily clear the Message Waiting screen. With the Handset in the OFF mode.

Press and Hold **CLR/DEL** until the handset displays:



Press **CLR/DEL** to confirm your decision.

Pressing any key other than **CLR/DEL** will cancel the operation.

The Message Waiting indication alert may reappear, as long as unplayed messages remain in your Voicemail box.

NOTE:

Message Waiting works in conjunction with Voicemail service from many local phone companies. This is an optional service. You are not required to subscribe to it.

ADVANCED FUNCTIONS

Temporary Tone

If you have rotary (dial-pulse) telephone service (**TONE/PULSE** switch is set to **PULSE**), this feature allows you to temporarily switch to **TONE** dialing for such purposes as remote access to answering machines, bank-by-phone services, use of calling cards and other special services.

First, dial the call normally. Then activate the Temporary Tone feature by pressing **TONE** (the * key). You can then press the numbers or symbols you need, and your phone will send the proper signals.

To end the call, press **OFF** or place the handset back in the base. The phone will automatically go back to rotary (dial-pulse) service.

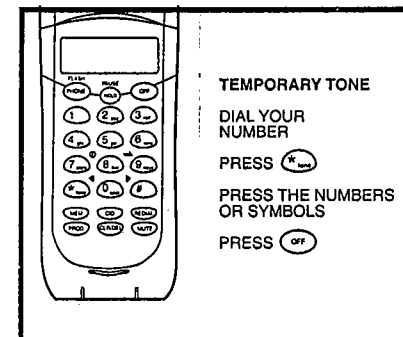

Programming The Ringer

The handset ringer is capable of four different types of ringer tones. The following sections detail how to select different ringer types and how to turn off the handset ringer.

Changing Ringer Types

To program, the handset must be **OFF**.

To select a different ringer type do the following:

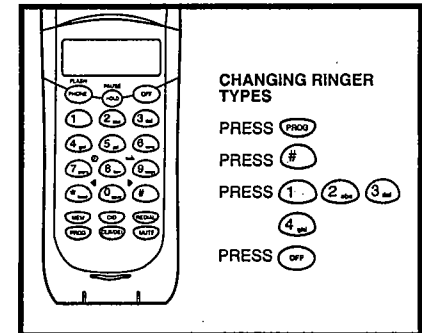

Press: **PROG**

Press: **#**

Press: 1 for ringer type 1

2 for ringer type 2

3 for ringer type 3

4 for ringer type 4

The handset LCD will show the ringer type selected, for example



Press **PROG** or **OFF** to exit.

Turning Off The Ringer

To turn off the ringer do the following:

ADVANCED FUNCTIONS

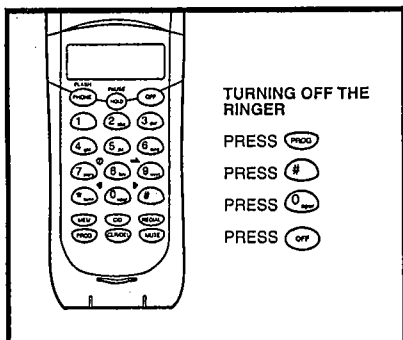

Checking The Ringer Type

To test the present ringer type, do the following:

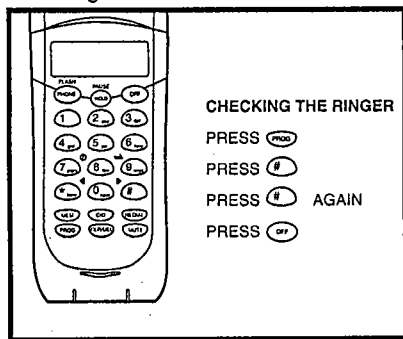

Press **PROG** or **OFF** to exit.

CLR/DEL Key Function

The **CLEAR** and **DELETE** functions can be accessed separately depending on how long the key is held down. For example, to clear the last digit entered on the display, press the **CLR/DEL** key for less than 1 second. Press and hold the **CLR/DEL** key for more than 1 second to completely clear the LCD.

The delete function is also used to delete CID and memory dial records, see **DELETING STORED NUMBERS**, and **DELETING NUMBERS**.

Advanced Dialing

There are two different ways to dial a number:

1. Press the **PHONE** key and wait for a dial tone. Then dial the number you want either manually, using **MEMORY (MEM)** dialing, **CID** dialing or **REDIAL**.
2. Enter the number you wish to dial on the display first. Then press the **PHONE** key. This will dial the number which is displayed on the LCD after 2 seconds.

NOTE: The phone will dial any number which is shown on the display. If you do not want to dial the number shown on the LCD, it can be changed by:

- Press and hold **CLR/DEL** until the display is cleared, then dial normally.
- OR
- Press **OFF** and start over.

MEMORY DIALING

Storing Memory (Speed) Dial numbers

To program a speed dial location, do the following:

- With the phone **OFF**, enter the telephone number you wish to store. (20 Digits Maximum).
- Enter program mode by pressing **PROG**. The display will show the following:

PROGRAM
LOCATION.....

- Enter the memory location (01..20) you wish to store the number in. As soon as the second memory location digit is entered, the unit will emit a happy tone (a short series of beeps) to confirm successful programming and exit program mode.

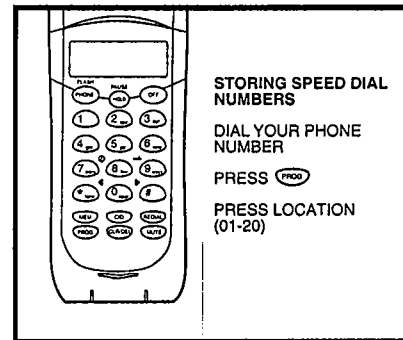

If programming is unsuccessful the unit will display:

PROGRAMMING
INCOMPLETE

Unsuccessful programming can result from not correctly completing the programming sequence. For example, if after entering a number on the LCD and entering program mode, the **OFF** key were pressed instead of entering a valid memory location, the "PROGRAMMING INCOMPLETE" message would appear. If this message appears, simply repeat the programming sequence.

MEMORY DIALING

Dialing From Memory

- Press **(PHONE)** to get a line.
- Press **(MEM)**, you're prompted to enter a speed dial location number:



SPEED DIAL
LOCATION_

- Enter a 2 digit location number (01-20)
 - The number stored in that location will be displayed and immediately dialed.
- Or
- Beginning from the OFF mode, press **(MEM)** followed by a 2 digit location number (01-20).
 - Press **(MEM)** again to exit memory dial mode and leave the number on the display.
 - Note that if digits were on the display prior to entering memory dial mode, the contents of the speed dial memory will be appended to those digits. For example, if 1503 was on the LCD and the contents of the memory location is 6438981, then the display would show the following upon exiting memory dial mode:



1503643898
1

Press **(PHONE)**, the number on the display will be dialed after a 2 second pause.

NOTE:

The ability to temporarily add memory contents to digits already entered on the display operates in the same way for CID and speed dial memories.

In this way, long distance and area codes (for example, 1503) can be entered on the LCD and can preface numbers recalled from CID memory before dialing. This is important because only the last 7 digits of any number are displayed when dialing from CID memory.

Changing Stored Numbers

To change or replace a stored number simply enter the new number on the display and store it in the memory location you wish to change.

Deleting Stored Numbers

- Press **(MEM)**. The display will change to "SPEED DIAL LOCATION_ _".
- Enter memory location number (01-20).
- Press **(CLEAR/DEL)** key. The display will change to "LOCATION XX DELETED".



LOCATION XX
DELETED

- Press **(OFF)** to exit.

NOTE:

Stored numbers are retained in memory even if the base loses its power or the handset battery is removed.

MEMORY DIALING

Storing Special Codes

To insert a pause in a phone number, press **(HOLD)** at the appropriate point when entering the number on the LCD. This inserts a 2 second pause. A " P " appears in the display to show the pause. For longer pauses, press **(HOLD)** two or more times. Each press makes the pause 2 seconds longer and is treated as a stored digit.

If your phone is connected to a PBX, you can store the PBX access number and a pause before the phone number. For example, to store 9-PAUSE-555-1234 in memory location 08, do the following:

1. Press **(9)**
2. Press **(HOLD)**
3. Dial 5551234
4. Press **(PROG)**
5. Enter 08

CID-CALLER ID

CID - CALLER ID

Your VT 1921 cordless phone is capable of displaying the name and/or phone number of the person calling, before you answer the phone. Subscription to Caller ID service through your local phone company is required to utilize this feature.

If you subscribe to alphanumeric (name & number) Caller ID service, the calling party's name and phone number (when available) will be displayed on the LCD screen while the phone is ringing.

If you subscribe to numeric (number only) Caller ID service, the calling party's phone number (when available) will be displayed on the LCD screen while the phone is ringing.

CALL WAITING CALLER ID (TYPE II CID)

Your VT 1921 cordless phone is also capable of displaying Caller ID information in connection with a Call Waiting signal. If you are on a call, and receive a Call Waiting alert signal, the LCD will display the name and/or number (when available) of the party trying to reach you. As above, subscription to Call Waiting ID service through your local phone company is required in order to utilize this feature.

A WORD ABOUT CALLER ID - CID

Due to regional incompatibilities, Caller ID information may not be available for every call you receive. In addition, the calling party may intentionally block their name & phone number from being sent.

NOTE:

You must be in an area where CID service is available and you must subscribe to it to use this feature.

If you do not subscribe to the CID service, the phone will still operate normally except that the CID information is not received or displayed.

Receiving and Storing Calls

This unit receives and displays all CID information, including the caller's telephone number, the caller's name and the exact date and time of the call.

The phone sequentially numbers these call records and retains them in the unit's CID memory for later review. These call record numbers are displayed as the first two digits in the display. The unit can store up to 50 numbers in its memory.

Once the CID memory is full, any new call forces a deletion of the oldest call record.

DIALING FROM CID MEMORY

NOTE:

Only the last 7 digits of any number are displayed when dialing from CID memory.

For example, when you press and hold the 7 (☎) key to view the phone number, you would see the following:

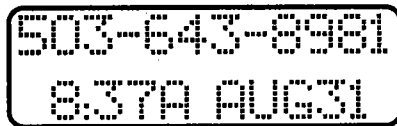

503-643-8981
8:37A AUG31

CID-CALLER ID

However, when you dial directly from CID memory, only the last 7 digits of the received telephone number will be used. Consequently, you would actually dial this:



6438981

The VT 1921 was designed to accommodate this situation. If you need to temporarily add a long distance prefix and /or area code (such as 1503) before the CID number, do the following:

- Beginning from the standby mode, key in the necessary digits. Your display will look like this:



1503

- Then, to temporarily add the last 7 digits only from a CID memory, press **(CID)**.
- Using the \square (*) and \square (#) keys, scroll through the received calls to locate the number you wish to dial.
- Once you have located the number you wish to dial, simply press **(PHONE)**. The last seven digits will be added to the numbers already in the LCD, and the whole number shown below will be automatically dialed.



1503643898

1

Special Message Indicators Out Of Area Calls

If for any reason the telephone number of the caller is unavailable, or if the caller is outside the CID service area, the message UNAVAILABLE is displayed on the LCD.



UNAVAILABLE

Private Calls

If the caller has exercised the option to block his or her number from being sent, then the display will show PRIVATE.



PRIVATE

Transmission Error

If an error is detected, then the CID information is incomplete and will not be displayed. "TRANSMISSION ERROR" will be displayed on the LCD screen.



TRANSMISSION
ERROR

The occasional appearance of "TRANSMISSION ERROR" on your display does not indicate a problem with your unit or your telephone line. However, if this appears frequently, you may want to notify your telephone company.

CID-CALLER ID

Reviewing Numbers

Calls stored in memory can be reviewed by pressing **(CID)**. The display will show the number of the most recent (CALL #01). The top line of the display is used to indicate the memory location number and the bottom line of the display shows the name, see below:

01 ABC COMP→
503-643-8981

There may be additional characters in the name which can not be shown on the current display. Press the → (9) key. This will overwrite the CID memory location on the top line to show up to a maximum of 15 alpha characters for the duration of the key press. The first 12 alpha characters will be on the top line with up to 3 additional characters on the second line.

01 ABC COMP→
ANY LTD.

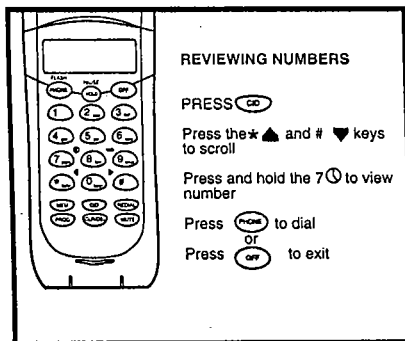

To find out the corresponding phone number as well as the date and time of the call, press and hold the **7** key. The date and time will be shown. Releasing the key will again show the caller's name.

503-643-8981
8:37A AUG31

Pressing the **(◀*)** key displays the next lower in sequence call record. Likewise, pressing the **(▶#)** key displays the next higher in sequence call record. The higher the call number, the older the call.

To save you time in reviewing call records, you can "wrap-around" the call history log. For example, if you press the **(◀*)** key enough to scroll back to the first record, pressing it again will force the display to go to the very end of the call record.

The LCD will display "-EMPTY-" when no CID Message was recorded.

01 -EMPTY-

CID-CALLER ID

DELETING NUMBERS

Pressing the **(CLR/DEL)** button deletes the CID number displayed.

- While the phone is in CID mode, press the **(CLR/DEL)** key once to delete the current call and the display will show:

DELETING
SINGLE CALL

- The older CID records will be moved forward by one location .

- Press and hold the **(CLR/DEL)** key for more than 2 seconds to delete the entire contents of CID memory. The display will show the following, for a final confirmation, before the entire CID memory is erased:

DELETE ALL?
DEL TO ALLOW

- Pressing any key other than **(CLR/DEL)** will cancel the operation. Pressing **(CLR/DEL)** will confirm the operation and the display will then show:

DELETING
ALL CALLS

- The message will remain on the display for 2 seconds.

ADDITIONAL OPERATING TIPS

NOISES OR INTERFERENCE

Your VT 1921 cordless telephone has auto-channel scan circuitry which will detect excess noise and change the channel of the phone to reduce it. This is done automatically.

Since the VT 1921 is a fully digital phone, it does not suffer from noise associated with regular cordless phones. At times you may experience occasional "drop outs", especially at the extreme edges of the phone's range. Simply move closer to the base unit and this will disappear.

AUTOMATIC SECURITY CODING

Your VT 1921 phone is factory set with 16.8 million possible security codes. This unique security code allows your handset and base to recognize each other, and minimizes the possibility of another cordless phone using your telephone line.

OUT OF RANGE INDICATION

If the handset is moved to a point where the base and handset can no longer communicate, the handset will display the following:

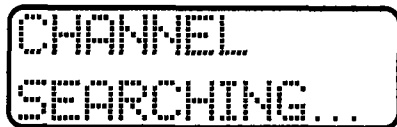

CHANNEL
SEARCHING...

OUT OF RANGE WHEN PHONE IS ON

If you are presently engaged in a phone conversation move closer to the base. If the base unit does not communicate with the handset within 25 seconds of losing contact, it will automatically hang up, and display:



CALL DROPPED

OUT OF RANGE WHEN PHONE IS OFF

If the phone is OFF, the handset and base still monitor each other to make sure that they can communicate. If the handset is moved out of range, the handset will make a series of beeps, and will then display "CHANNEL SEARCHING" on the LCD. At 15 second intervals the handset will scan all channels in an attempt to reestablish communication with the base. This process does not require user intervention; the handset will re-link with the base automatically once it is brought back within range. The unit will then be able to receive and place calls.

When the base unit is unplugged from the power supply, the handset will give the "Out of Range" warning beep. Plug the base in again and this will stop.

MAINTENANCE

TAKING CARE OF YOUR TELEPHONE.

Your VT 1921 cordless telephone contains sophisticated electronic parts, so it must be treated with care.

Avoid rough treatment.

Place the handset down gently. Save the original packing materials to protect your telephone if you ever need to ship it.

Avoid water.

Your telephone can be damaged if it gets wet. Do not use the handset outdoors in the rain, or handle it with wet hands. Do not install your base unit near a sink, bathtub or shower.

Electrical storms

Electrical storms can sometimes cause power surges harmful to electronic equipment.

For your own safety, use caution when using electric appliances during storms.

Cleaning your telephone

Your telephone has a durable plastic casing that should retain its luster for many years. Clean it only with a soft cloth slightly dampened with water or a mild soap. Do not use excess water or cleaning solvents of any kind.

Remember that electrical appliances can cause serious injury if used when you are wet or standing in water. If your base unit should fall into water, **DO NOT RETRIEVE IT UNTIL YOU UNPLUG THE POWER CORD AND TELEPHONE LINE CORDS FROM THE WALL.** Then pull the unit out by the unplugged cords.

IN CASE OF DIFFICULTY

If you have difficulty operating your phone, the suggestions below should solve the problem. If you still have difficulty after trying these suggestions, call VTECH Communications at 1-800-595-9511 in the U.S. and VTech Electronics Canada Ltd at 1-800-267-7377 in Canada.

THE PHONE DOESN'T WORK AT ALL

- Make sure the Power Cord is plugged
- Make sure the telephone line cord is plugged firmly into the base unit and the telephone wall jack.
- Make sure the batteries are properly charged. If the 'LOW BATTERY' message is shown, the battery pack needs charging.

NO DIAL TONE

- First check all the suggestions above.
- If you still don't hear a dial tone, disconnect the base unit from the telephone jack and connect a different phone. If there is no dial tone on that phone either, the problem is in your wiring or local service. Call your local telephone company.

YOU GET NOISE, STATIC OR A WEAK SIGNAL EVEN WHEN YOU'RE NEAR THE BASE UNIT

- Household appliances plugged into the same circuit as the base unit can sometimes cause interference. Try moving the appliance or the base unit to another outlet.

YOU GET NOISE, STATIC OR A WEAK SIGNAL WHEN YOU'RE AWAY FROM THE BASE UNIT

- You may be out of range. Either move close to the base, or relocate the base unit.
- The layout of your home may be limiting the range. Try moving the base unit to another position.

THE HANDSET DOES NOT RING WHEN YOU RECEIVE A CALL

- Make sure you have the handset ringer activated. To set the ringer, see "PROGRAMMING THE RINGER".
- Make sure the telephone line cord is plugged firmly into the base unit and the telephone jack. Make sure the power cord is plugged in.
- You may be too far from the base unit.
- You may have too many extension phones on your telephone line to allow all of them to ring. Try unplugging some of the other phones.

YOU HEAR OTHER CALLS WHILE USING YOUR PHONE

- Disconnect your base unit from the telephone jack, and plug in a regular telephone. If you still hear other calls, the problem is probably in your wiring or local service. Call your local telephone company.

YOU HEAR NOISE IN THE HANDSET, AND NONE OF THE KEYS OR BUTTONS WORK

Make sure the power cord is plugged in.

IN CASE OF DIFFICULTY

COMMON CURE FOR ELECTRONIC EQUIPMENT

Electronics, like people, can sometimes get confused. If the unit does not seem to be responding normally, then try putting the handset in the cradle. If it does not seem to respond after trying this a few times, do the following (in the order listed):

1. Disconnect the power to the base.
2. Disconnect (remove) the handset battery pack.
3. Remove the base unit battery pack, where applicable.
4. Wait a few minutes.
5. Connect power to the base.
6. Install the handset battery pack.
7. Install the base unit battery pack, where applicable.
8. Place the handset in the base unit cradle. If the handset has not been recently charged, allow 8 hours before use.

WARRANTY STATEMENT

WHAT DOES OUR WARRANTY COVER?

- Any defect in material or workmanship.

FOR HOW LONG AFTER THE ORIGINAL PURCHASE?

- To the original purchaser only - ONE YEAR.

WHAT WILL VTECH DO?

- At our option, repair or replace your unit.

HOW DO I SEND MY UNIT, IN OR OUT OF WARRANTY?

- In the U.S. Call VTECH Communications customer service for Return Authorization at:
1-800-595-9511 in Canada call 1-800-267-7377
- Properly pack your unit. Include any cables & accessories which were originally provided with the product. We recommend using the original carton and packing materials.
- Include in the package a copy of the sales receipt or other evidence of date of original purchase (if the unit was purchased within the last twelve months).
- *Print your name and address, along with a description of the defect, and include this in the package Or Vtech Electronics.*
- Include payment for any service or repair not covered by warranty, as determined by VTECH Communications.
- Ship the unit via UPS Insured, or equivalent to the address provided by VTECH Communications or VTECH Electronics.

VTECH Communications assumes no responsibility for units sent without prior Return Authorization.

WHAT DOES OUR WARRANTY NOT COVER?

- Batteries
- Damage from misuse, neglect, or acts of nature (lightning, floods, power surges, etc.)
- Products which may have been modified or incorporated into other products
- Products purchased and/or operated outside the USA, its territories, or Canada.
- Products serviced by the owner or a service facility not expressly authorized by VTECH Communications
- Products purchased more than 12 months from current date
- Units purchased in "AS IS" condition, or units purchased as "Distressed Merchandise".

HOW DOES STATE LAW OR PROVINCIAL LAW RELATE TO THIS WARRANTY?

- This warranty gives you specific rights. You may also have other rights which vary from state to state as province to province.

TECHNICAL SPECIFICATIONS

FREQUENCY CONTROL

Crystal Controlled Dual PLL Synthesizer

TRANSMIT FREQUENCY

Handset: 925.05 MHz to 927.75 MHz
(All ten channels within this range)

Base : 902.3 MHz to 905.0 MHz
(All ten channels within this range)

RECEIVE FREQUENCY

Handset: 902.3 MHz to 905.0 MHz
(All ten channels within this range)

Base : 925.05 MHz to 927.75MHz
(All ten channels within this range)

NOMINAL EFFECTIVE RANGE

Maximum power allowed by FCC and IC. Actual operating range may vary according to environmental conditions at the time of use.

SIZE

Handset: 19 x 6 x 3.5cm (L x W x T)
Maximum (Antenna excluded)

Base : 21.5 x 15.5 x 5.5cm (L x W x T)
Maximum (Antenna excluded)

WEIGHT

Handset: 295 grams
Base : 470 grams

POWER REQUIREMENTS

Handset: Self-contained nickel-cadmium rechargeable battery supply, 3.6V nominal, 600mAh capacity.

Base: 9VDC @ 300mA

MEMORY

Speed Dial: 20 Memory locations, 20 digits per location.

CID : Alpha Numeric Display 50 Memory locations

SPECIFICATIONS ARE TYPICAL AND MAY CHANGE WITHOUT NOTICE.



VTECH

POWER

IN USE

CHARGING

PAGE

900 MHz
CORDLESS

VT 9111



PLEASE RECYCLE THESE CASCALS
SEPARATELY FROM OTHER WASTE OR
RECYCLE THEM IN THE RECYCLING BIN
OR AT A RECYCLING CENTER. USE
ONLY THE RECYCLING SYMBOLS FOR
PLASTIC, METAL, PAPER, GLASS,
ELECTRONIC WASTE, AND OTHER
WASTE. DO NOT RECYCLE THESE
CASCALS IN THE RECYCLING BIN.
RECYCLING SYMBOLS ARE NOT
SUPPORTED BY ALL COUNTRIES. IT
MAY BE NECESSARY TO RECYCLE
THESE CASCALS SEPARATELY.
PLEASE RECYCLE THESE CASCALS
SEPARATELY FROM OTHER WASTE OR
RECYCLE THEM IN THE RECYCLING BIN
OR AT A RECYCLING CENTER. USE
ONLY THE RECYCLING SYMBOLS FOR
PLASTIC, METAL, PAPER, GLASS,
ELECTRONIC WASTE, AND OTHER
WASTE. DO NOT RECYCLE THESE
CASCALS IN THE RECYCLING BIN.
RECYCLING SYMBOLS ARE NOT
SUPPORTED BY ALL COUNTRIES. IT
MAY BE NECESSARY TO RECYCLE
THESE CASCALS SEPARATELY.





Download from www.Somanuals.com. All Manuals Search And Download.







Free Manuals Download Website

<http://myh66.com>

<http://usermanuals.us>

<http://www.somanuals.com>

<http://www.4manuals.cc>

<http://www.manual-lib.com>

<http://www.404manual.com>

<http://www.luxmanual.com>

<http://aubethermostatmanual.com>

Golf course search by state

<http://golfingnear.com>

Email search by domain

<http://emailbydomain.com>

Auto manuals search

<http://auto.somanuals.com>

TV manuals search

<http://tv.somanuals.com>