

INTRODUCTION

Congratulations! You have purchased one of the most sophisticated cordless telephones on the market! The VTech VT 1922 has been designed to offer a new standard in cordless telephone technology.

Unlike most other cordless phones, the VTech VT 1922 digitizes your voice using advanced ADPCM digital voice coding to provide noise and distortion free performance. In most conditions you will not be able to tell you are using a cordless phone. Gone are the annoyances of static, interference and having to listen to other people's conversations on your cordless phone.

The VTech VT 1922 scrambles your voice before it transmits it. This allows you the security of knowing that no one can tune in and eavesdrop on your conversations.

The VTech VT 1922 decodes and displays name and/or number Caller ID (CID) information where available and when subscribed to. The alpha-numeric display can show both the name and number of the calling party. Up to 15 name characters or 11 phone number digits can be displayed on the LCD.

With the VTech VT 1922, the user can easily answer a call by pressing any key other than the OFF, MUTE or VOLUME Keys. In addition, the Handset display illuminates when the phone rings. This is very useful in a dark environment.

The VTech VT 1922 also provides a one-way Page/Find. Pressing the base PAGE key will cause the handset to ring in a manner which distinguishes it from normal incoming

ringing. This can be used to alert the handset user, or to simply locate the handset in the event that it is misplaced.

The VTech VT 1922 uses special memory in both the base and handset which is not susceptible to power failures. This provides permanent storage of all memory dial numbers, CID information as well as the base and handset security codes.

When an optional battery pack is installed in the base unit, the VTech VT 1922 uses this battery pack to provide operational backup in case of power failure. In this way you have access to all normal phone functions during a total power outage. Calls can still be placed and received without interruption. More than 5 hours backup will be possible with a fully charged battery pack in the base unit.

The VTech VT 1922 informs you that another extension is currently in use on the same phone line. The phone will also alert you when you are Out of Range, even when you're not using the phone!

INTRODUCTION

SPECIAL FEATURES

- 900 MHz Operation.
- Fully Digital Link between Handset and Base with ADPCM voice coding.
- Digitally-Scrambled Voice Communication.
- Name / Number CID display.
- 2 row by 12 character 5x7 dot matrix alpha-numeric LCD.
- 50 CID memory locations.
- Backlit Handset display.
- 20 location Programmable Memory for 20 Digit Phone Number.
- 10 Channel Operation with auto channel selection.
- Out-of-Range indication while the handset is in use or in standby mode.
- Removable handset battery pack.
- Spare battery charger in the base unit.
- Complete battery back-up in case of power failure (with optional spare battery pack installed in base).
- Face-up Handset charging.
- Easy answer - When the phone

- rings, simply press any key other than OFF, MUTE, or the Volume Keys on the handset to answer.
- Auto hang up when returning the handset to the base cradle.
- Extension in use indicator.
- Tone and Pulse Dialing.
- Low Battery Detect and Warning indicator.
- Up to 7 hours continuous talk time or 7 days standby time.
- Volume Adjust on Handset.
- REDIAL, HOLD, PAGE and MUTE.
- Hearing-Aid Compatible Receiver.
- Detachable power supply.
- Non-volatile storage of security code and memory dial records.
- Programmable Ringer Types.
- 2.5mm Headset Jack.

This manual is designed to make you familiar with the VTech VT 1922. We strongly recommend you read the manual before using your phone.

INTRODUCTION

Parts Checklist

1. Base unit, Handset and AC adaptor
2. One-Line Telephone Cord
3. Battery Pack
4. Wall mount accessory
5. Belt clip

To purchase replacement battery packs, call VTECH Communications at 1-800-595-9511. In Canada, call VTECH Electronics at 1-800-267-7377

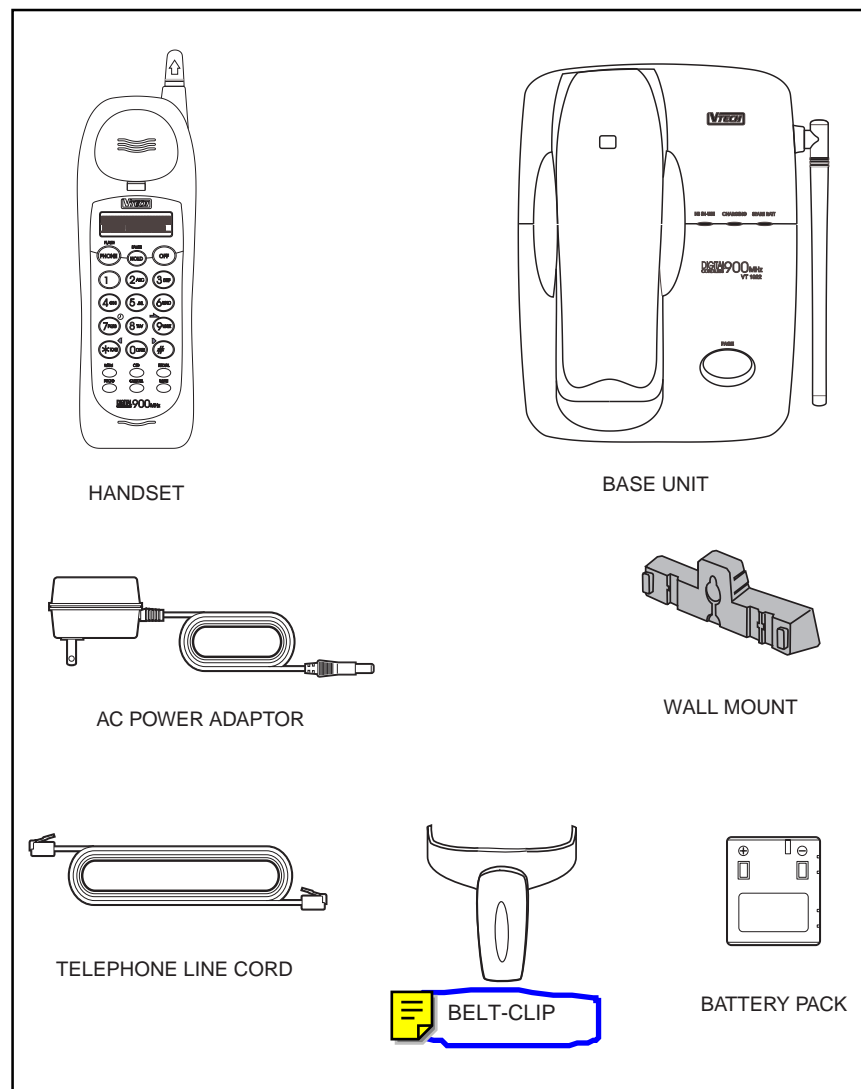

This equipment complies with Parts 15 and 68 of the Federal Communications Commission (FCC) rules for the United States. It also complies with regulations RSS210 and CS-03 of Industry and Science Canada. Operation is subject to the following two conditions: (1) this device may not cause interference, and (2) this device must accept any interference, including interference that may cause undesired operation of the device.

A label is located on the underside of the base unit containing either the FCC registration number and Ringer Equivalence Number (REN) or the IC registration number and Load Number. You must, upon request, provide this information to your local telephone company.

This equipment is compatible with inductively coupled hearing aids.

Should you experience trouble with this telephone equipment, please contact:

VTECH COMMUNICATIONS

SERVICE DEPT. at 1-800-595-9511. In Canada, call VTECH Electronics at 1-800-267-7377.

For repair/warranty information. The telephone company may ask you to disconnect this equipment from the line network until the problem has been corrected.

FCC Part 15

Warning: Changes or modifications to this unit not expressly approved by the party responsible for compliances could void the user's authority to operate the equipment.

The equipment has been tested and found to comply with part 15 of the FCC rules. These limits are designed to provide reasonable protection against harmful interference in a residential installation. This equipment generates, uses and can radiate radio frequency energy and, if not installed and used in accordance with the instructions, may cause harmful interference to radio communications. However, there is no guarantee that interference will not occur in a particular installation. If this equipment does cause harmful interference to radio or television reception, which can be determined by turning the equipment off and on, the user is encouraged to try and correct the interference by one or more of the following measures:

- Reorient or relocate the receiving antenna.
- Increase the separation between the equipment and receiver.
- Connect the equipment into an outlet or on a circuit different from that to which the receiver is connected.
- Consult the dealer or an experienced radio/TV technician for help.

FCC Part 68

The FCC requires that you connect your cordless telephone to the nationwide telephone network through a modular telephone jack (USOC RJ11C, RJ11W or RJ14).

Your telephone company may discontinue your service if your equipment causes harm to the telephone network. They will notify you in advance of disconnection, if possible. During notification, you will be informed of your right to file a complaint with the FCC.

Occasionally, your telephone company may make changes in its facilities, equipment, operation, or procedures that could affect the operation of your equipment. If so, you will be given advance notice of the change to give you an opportunity to maintain uninterrupted service.

The base unit contains no user serviceable parts. The handset contains a user replaceable battery pack.

If it is determined that your telephone equipment is malfunctioning, the FCC requires that it not be used and that it be unplugged from the modular jack until the problem has been corrected. Repairs to this telephone equipment can only be made by the manufacturer or its authorized agents or by others who may be authorized by the FCC. For repair procedures, follow the instructions outlined under the VTECH Limited Warranty.

This equipment may not be used on coin service provided by the phone company or Party Lines.

The REN is useful in determining the number of devices you may connect to your telephone line and still enable the devices to ring when you receive a call. The general rule is that the REN value should not exceed 5.0A total; however, contact your local telephone company for the specific number in your area.

IC (Industry Canada)

This telephone is registered for use in Canada.

Notice: The REN assigned to this device denotes the number of devices you may connect to the telephone loop which is used by the device to prevent overloading. The termination on a loop may consist of any combination of devices subjected only to the requirement that the sum of the REN does not exceed five (5.0)

Notice: The Industry Canada label identifies certified equipment. This certification means that the equipment meets certain telecommunications network protective, operational and safety requirements. The Department does not guarantee the equipment will operate to the user's satisfaction.

Before installing this equipment, users should ensure that it is permissible to be connected to the facilities of the local telecommunications company. The equipment must also be installed using an acceptable method of connection. The customer should be aware that compliance with the above conditions may not prevent degradation of services in some situations.

Repairs to certified equipment should be made by an authorized Canadian maintenance facility designated by the supplier. Any repairs or alterations made by the user to this equipment, or equipment malfunctions, may give the telecommunications company cause to request the user to disconnect the equipment.

Users should ensure for their own protection that the electrical ground connections of the power utility, telephone lines and internal metallic water pipe system, if present, are connected together. This precaution may be particularly important in rural areas.

Caution: Users should not attempt to make such connections themselves, but should contact the appropriate electrical inspection authority, or electrician, as appropriate.

Your VTech VT1922 is designed to operate at the maximum power allowed by the FCC and IC. This means your handset and base unit can communicate only over a certain distance - which will depend on the location of the base unit and handset, weather, and the construction and layout of your home or office.

When using your telephone equipment, basic safety precautions should always be followed to reduce the risk of fire, electric shock and injury to persons, including the following:

1. Read and understand all instructions.
2. Follow all warnings and instructions marked on the product.
3. Unplug this product from the wall outlet before cleaning. Do not use liquid cleaners or aerosol cleaners. Use a damp cloth for cleaning.
4. Do not use this product near water (for example, near a bath tub, kitchen sink, or swimming pool).
5. Do not place this product on an unstable cart, stand, or table. The product may fall, causing serious damage to the product.
6. Slots and openings in the cabinet and the back or bottom are provided for ventilation. To protect it from overheating, these openings must not be blocked by placing the product on the bed, sofa, rug, or other similar surface. This product should never be placed near or over a radiator or heat register. This product should not be placed in a built-in installation where proper ventilation is not provided.
7. This product should be operated only from the type of power source indicated on the marking label. If you are not sure of the type of power supply to your home, consult your dealer or local power company.
8. Do not allow anything to rest on the power cord. Do not locate this product where the cord will be abused by persons walking on it.
9. Never push objects of any kind into this product through cabinet slots as they may touch dangerous voltage points or short out parts that could result in a risk of fire or electric shock. Never spill liquid of any kind on the product.
10. To reduce the risk of electric shock, do not disassemble this product, but take it to a VTech authorized service facility. Opening or removing cabinet parts other than specified access doors may expose you to dangerous voltages or other risks. Incorrect reassembling can cause electric shock when the appliance is subsequently used.
11. Do not overload wall outlets and extension cords as this can result in the risk of fire or electric shock.

12. Unplug this product from the wall outlet and refer servicing to a VTech authorized service facility under the following conditions:
 - A. When the power supply cord or plug is damaged or frayed.
 - B. If liquid has been spilled into the product.
 - C. If the product has been exposed to rain or water.
 - D. If the product does not operate normally by following the operating instructions. Adjust only those controls that are covered by the operating instructions, because improper adjustment of other controls may result in damage and will often require extensive work by a VTech authorized technician to restore the product to normal operation.
 - E. If the product has been dropped and the cabinet has been damaged.
 - F. If the product exhibits a distinct change in performance.
13. Avoid using a telephone (other than a cordless type) during an electrical storm. There may be a remote risk of electric shock from lightning.
14. Do not use the telephone to report a gas leak in the vicinity of the leak.

VTECH COMMUNICATIONS
SERVICE DEPT. at 1-800-595-9511.
In Canada, call VTECH Electronics at 1-800-267-7377.

SAVE THESE INSTRUCTIONS

CHARGING THE HANDSET BATTERY PACK

The handset of your VTech VT 1922 cordless telephone is powered by a rechargeable battery pack. It charges automatically whenever the handset is in the base. You should charge the battery pack for 16 hours when you first receive your phone. You'll know the battery pack needs charging when:

- The phone emits a warning tone when you press the PHONE key.
- The low battery message is displayed:



- The handset seems completely dead, the LCD is clear and the handset does not beep when you press the keys.

To Charge The Battery Pack

To charge the battery pack, place the handset in the base unit. The CHARGE indicator will light to show the handset is seated properly and the battery pack is charging. It is recommended that the battery pack be charged for at least 16 hours initially and 8 hours for maintenance charging. You can use your telephone before that with diminished capacity, but it is best to charge the battery pack fully. It will take several recharge cycles to maximize the charge capacity of your battery pack. The maximum battery life between charges is 7 hours of continuous talk time or 7 days of stand by.

Alternatively, if you have purchased a spare battery pack and it has been charging in the base unit, simply exchange the drained handset battery pack with the fully charged replacement battery pack from the base charger. Place the drained handset battery pack into the base charger to recharge.

The base spare battery charger does NOT charge a battery pack as quickly as the handset battery charger. A full charge requires 24 hours when using the spare battery charger.

IT'S IMPOSSIBLE TO OVERCHARGE THE BATTERY PACK

The battery pack can be recharged many times, but if you get a low-battery signal even after 16 hours of charging in the base cradle (or 24 hours in the base spare battery charger), the battery pack(s) should be replaced.

To purchase replacement battery packs, call VTECH Communications at 1-800-595-9511. In Canada, call VTECH Electronics at 1-800-267-7377.

A WORD ABOUT RECHARGEABLE BATTERIES

Your Ni-Cd battery pack recharges whenever the Handset is returned to the Base Unit cradle. You may return the Handset to its cradle whenever you're not using the phone.

However, to *maximize* the life of your battery pack, do not return your **VT1922** Handset to the Base Unit cradle for recharging unit the **LOW BATTERY** indication appears.

REPLACING THE BATTERY PACK

Follow the steps below:

1. Remove the battery case cover by pressing on the ridged lines and sliding downward.

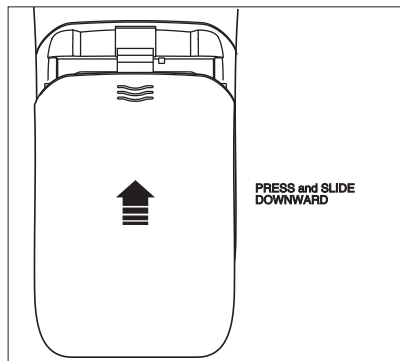

2. Discard the old battery pack. Don't put the old battery pack in a trash compactor or a fire - it could burst.
3. Place the new battery pack in its housing with the metal contacts facing down.

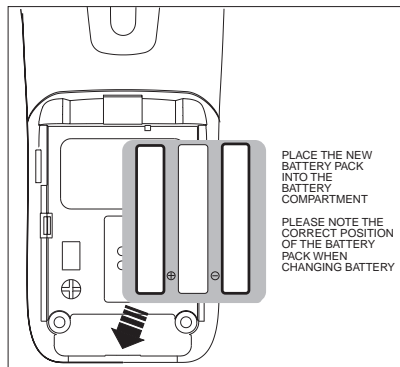

4. Replace the battery case cover by sliding the cover upwards.

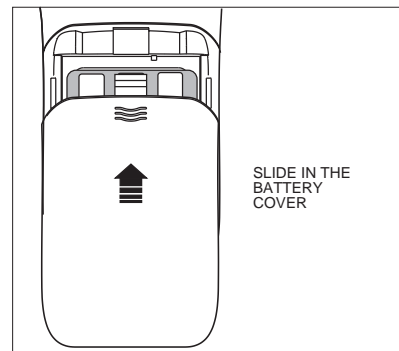

5. If the new battery pack is not already charged, place the handset in the cradle of the base unit to allow it to charge for 16 hours.

CAUTION:

To Reduce the Risk of Fire or Injury to persons, read and Follow the instructions

1. Use only VTECH rechargeable battery pack.
2. Do not dispose of the battery in a fire. The cell may explode.

IMPORTANT: Do not dispose of this battery into household garbage. For information on recycling or proper disposal, consult your local solid waste collection or disposal organization.

3. Do not open or mutilate the battery. Released electrolyte is corrosive and may cause damage to the eyes or skin. It may be toxic if swallowed.

REPLACING THE BATTERY PACK

4. Exercise care in handling batteries in order not to short the battery with conducting materials such as rings, bracelets, and keys. The battery or conductor may overheat and cause burns.

To purchase replacement battery packs, call VTECH Communications at 1-800-595-9511. In Canada, call VTECH Electronics at 1-800-267-7377.

SPARE BATTERY CHARGER

The VT 1922 has a built-in Spare Battery Charger, which is located in the cradle of the Base Unit.

NOTE: In order to benefit from this feature, you must obtain an optional Spare Battery from an authorized VTech dealer, or by contacting VTech Customer Service at 1-800-595-9511 in the U.S.A and 1-800-267-7377 in canada.

Installation

Remove the Spare Battery charger cover by pressing the release tab and lifting up.

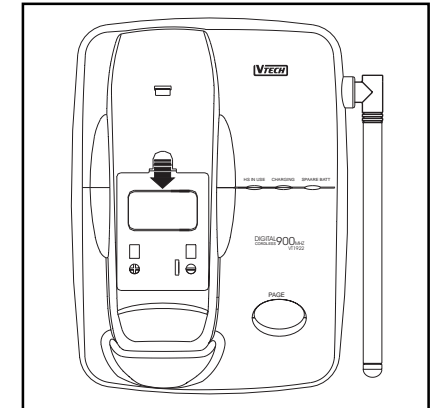

Place a battery pack in the Spare Battery charger. Make sure the metal charging contacts on the underside of the battery pack are aligned with the charging contacts in the Spare Battery charger.

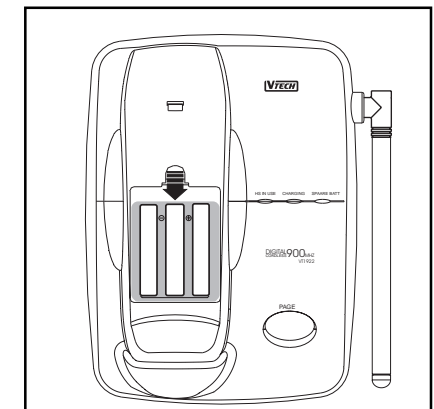

Power Backup

When a Spare Battery pack is installed in the Base Unit, the VTech VT 1922 uses this battery pack to provide operational backup in case of a power failure. If you have a fully charged battery pack in the Spare Battery pack charger and there is a power outage, you will still be able to place and receive calls for up to five hours.

Replacing a Drained Handset battery

The Spare battery pack can also be used to replace a drained Handset battery pack to ensure uninterrupted use. Be sure to put the drained battery pack in the Spare Battery charger for recharging.

Please note that the Spare Battery compartment charges at a slower rate than a battery pack charging in the Handset. It takes 24 hours to fully charge a battery pack in the Spare Battery charger.

The RBRC™ Seal



The RBRC® Seal on the battery indicates that VTech Communications, INC. is voluntarily participating in an industry program to collect and recycle these batteries at the end of their useful lives, when taken out of service within the United States and Canada.

The RBRC® program provides a convenient alternative to placing used nickel-cadmium batteries into the trash or municipal waste, which may be illegal in your area.

VTech's partnership with RBRC® makes it easy for you to drop off used batteries at local retailers participating in the RBRC® program.

Please call **1-800-8-BATTERY™** for information on Ni-Cd battery recycling and disposal bans/restrictions in your area. VTech's involvement in this program is part of its commitment to protecting our environment and conserving natural resources.

Remove the nickel-cadmium battery pack by pressing on the lock knob and sliding downward as mentioned on this page.

RBRC® is a registered trademark of Rechargeable Battery Recycling Corporation.

Setting Up Your VTech VT 1922

Choose an area near an electrical outlet and a telephone wall jack.

AC Power Adapter

Plug the AC power adapter into an electrical outlet and the DC connector to the back of the base unit.

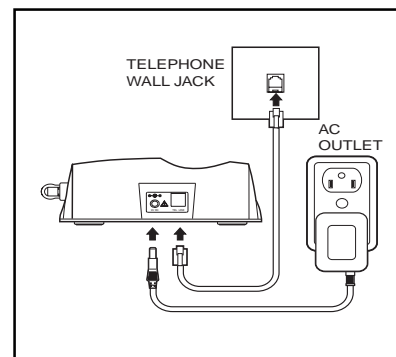

CAUTION:
Use only CLASS 2 9V DC POWER SUPPLY included with your phone.

Handset Ringer

The handset ringer is programmed ON as the factory default setting. Refer to **PROGRAMMING THE RINGER** on page 24 for more information.

Setting the Tone/Pulse Switch

The **TONE/PULSE** switch is located on the bottom of the base unit and is factory set to **TONE**. If you have touch tone service, do not change the switch setting. If you have rotary (Pulse) service, set the switch to **PULSE**.

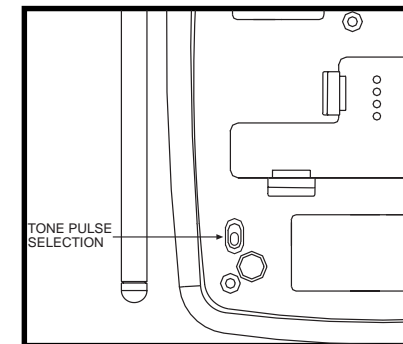

Charge the handset battery pack

before use. The battery pack recharges automatically whenever the handset is in the base unit. The batteries must be charged for 16 hours before using your phone for the first time.

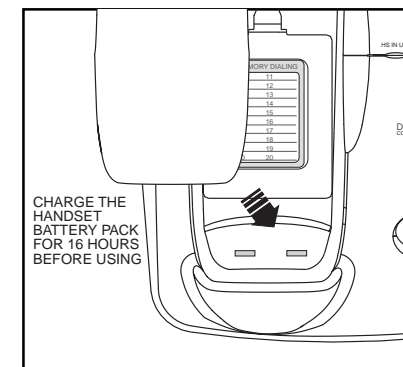

Connect Telephone Line Cord

Plug one end of the telephone cord into a wall jack and the other end into the back of the Base Unit.

Check for a dial tone. After the battery pack is charged, rotate the Base Unit antenna to an upright position. Pick up the Handset and press **PHONE** "PHONE ON" will appear on the LCD, and you will hear a dial tone. If not, see 'IN CASE OF DIFFICULTY' on page 35

Fill in the telephone number card on the base unit.

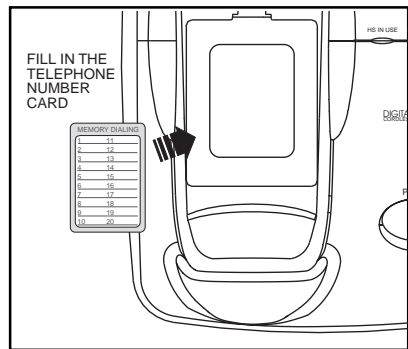

CAUTION:

1. Never install telephone wiring during a lightning storm.
2. Never install telephone jacks in wet locations unless the jack is specifically designed for wet locations.
3. Never touch uninsulated telephone wires or terminals unless the telephone line has been disconnected at the network interface.
4. Use caution when installing or modifying telephone lines.

USING THE WALL MOUNT ADAPTER

1. Choose a spot near an electrical outlet and a telephone jack.

Your phone requires a modular telephone jack and a standard electrical outlet (120v AC). The power cord is six feet long; make sure there is an electrical outlet within reach of the Base Unit. The outlet should not be controlled by a wall switch. If the switch is ever turned off, the phone will not operate.

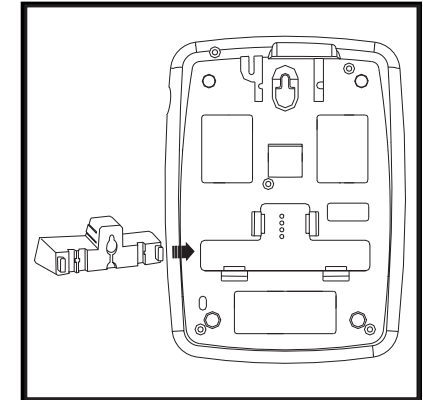

Figure 1

2. Position the wall mount bracket on the base.

Line up the tabs on the wall mount adaptor with the holes on the bottom of the base (Figure 1). Snap the wall mount bracket firmly in place.

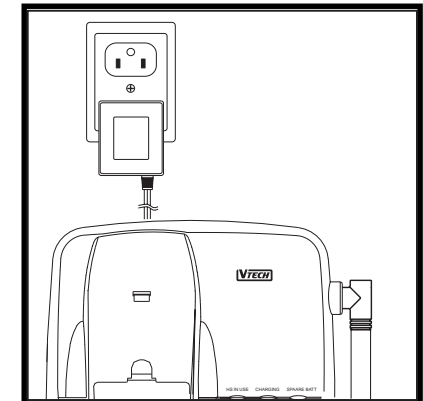

Figure 2

3. Mount the base on the wall.

Position the base so the mounting studs will fit into the holes on the bottom of the base. Position the power cord to extend down the wall the phone is to be mounted on. Slide the base down on the mounting studs until it locks into place.

4. Connect the telephone line cord.

The telephone line cord has a snap-in plug at each end. Insert one of the plugs into the jack on the bottom of the base. Insert the other end of the plug into the wall jack.

5. Plug the AC adapter into an electrical outlet and the DC connector into the power jack located on the back of the Base Unit .

THE LCD DISPLAY



LCD Display Messages



the PHONE ON indicator is displayed when the phone is in use.

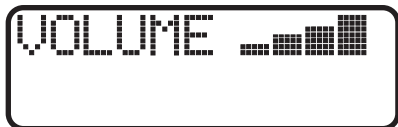

shows the handset volume setting.



is displayed when the unit is in a low-battery condition. The handset typically operates for at least 5 minutes after the low battery indication first appears.



is displayed when the Base Unit pages the handset.



is displayed when the handset is on hold.

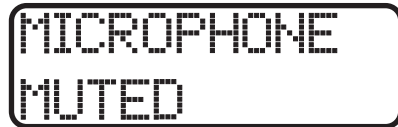

is displayed when the handset microphone has been muted.



is displayed when the handset ringer has been programmed off.

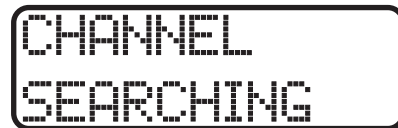

is displayed when the handset has lost communication with the base unit and is attempting to reestablish a link by scanning all channels.

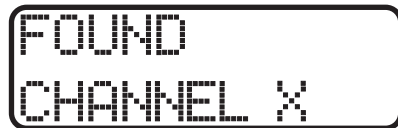

is displayed if communication with the base is reestablished.



is displayed while in OFF mode, if another phone is currently using the same line.

THE HANDSET LAYOUT

THE HANDSET FEATURES

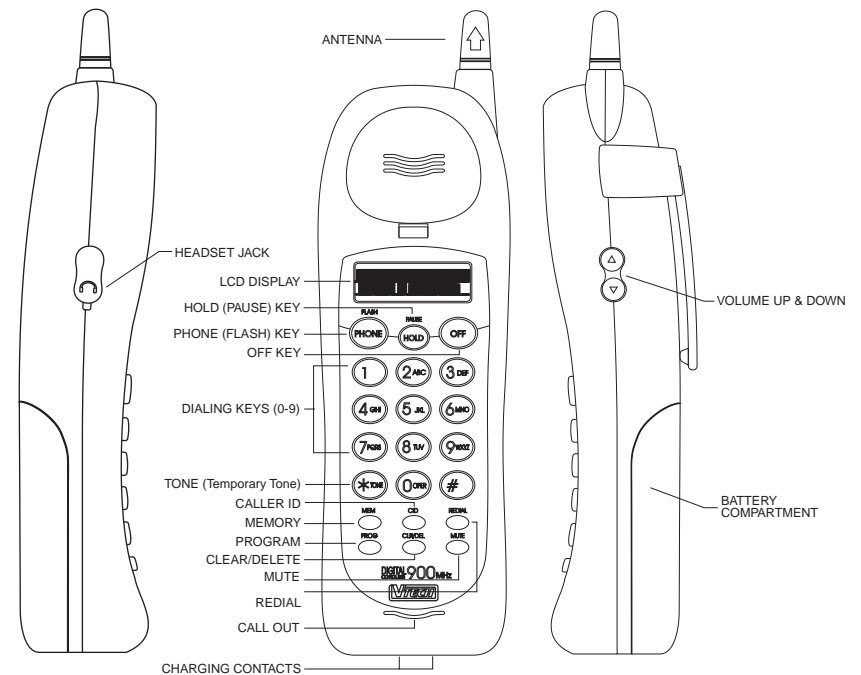

THE BASE UNIT FEATURES

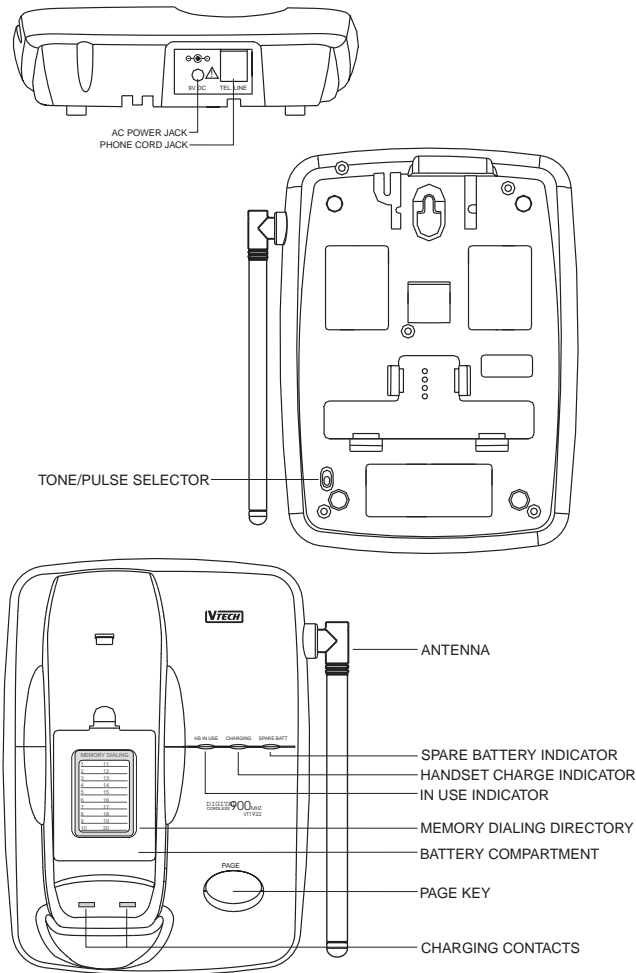

TO MUTE A CALL

- Press **(MUTE)** to disable the handset microphone.
- Press **(MUTE)** again to return to normal two way conversation.

TO PAGE THE HANDSET

- To page from the base, press **(PAGE)**.
- To cancel the **PAGE** either press **(PAGE)** again on the base or press **(OFF)** on the handset.

STORING MEMORY (SPEED) DIAL NUMBERS:

- The phone should be **OFF**.
- Enter the number you wish to store on the LCD up to a maximum of 20 digits.

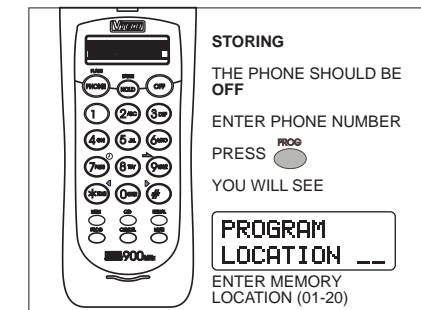

- Press **(PROG)**. The LCD will display "PROGRAM LOCATION..."
- Enter a two digit memory location (01 .. 20), the unit will store the number, emit a happy tone to confirm successful programming and exit program mode.

SET-UP

- Plug AC adapter into a standard electrical outlet and Base Unit
- Set Dial Mode switch to **PULSE** or **TONE**. The unit is factory set to **TONE**.
- Let the handset battery pack charge for 16 hours before first use.
- Connect telephone line cord to base unit and telephone jack.

MAKING CALLS

- Press the **(PHONE)** key. When the "PHONE ON" indicator is displayed and you hear a dial tone, dial the number.
- OR
- Enter the number to be dialed on the **LCD** and then press the **(PHONE)** key.

ANSWERING CALLS

- To answer a call, press any key other than **(OFF)**, **(MUTE)**, or the Volume Keys. The handset will NOT auto-answer when lifted off the base cradle.

HANGING UP

- Press **(OFF)** or place the handset in the cradle to hang up a call.

TO PLACE A CALL ON HOLD

- Press **(HOLD)** on the handset to place an active call on hold. Press **(HOLD)** again to return to the call.

MEMORY DIALING (SPEED DIALING):



- Press the **PHONE** key.
- Press **MEM**.
- Enter the memory location of the phone number you wish to dial (01...20). The number will be displayed on the LCD and will be dialed.

CID - CALLER ID

- To view information stored in CID memory, press **CID** on the handset.



- The display will show the most recent call received.

- To view the time and date of the call press and hold the **7** key. The time and date will be shown along with the phone number. You will see something like:

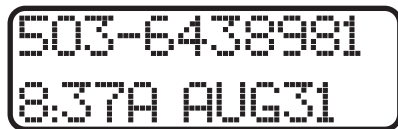

As long as the key is held down.

- To view other calls, scroll backwards and forwards by using the **◀** (*****) and **▶** (**#**) keys.
- To view additional digits not shown on the display, press the **→** (**9**) key
- To exit press **OFF**.

USING REDIAL

- Press the **PHONE** key, then **REDIAL** to automatically redial out the last number you dialed.

Or

- Press **REDIAL** so that the number is shown on the display and then press the **PHONE** key.

HOLD

- Press **HOLD** to put a call on hold.
- To return to the call, press **HOLD** key again

MAKING CALLS

You can make calls directly from the handset whether you are at the base or away from it.

NOTE: There are two different ways to dial a number:

1. Press the **PHONE** key and wait for dial tone. Then dial the number you want.

Or

2. Enter the number onto the display first, then press the **PHONE** key. This will dial the number that is displayed on the LCD after 2 seconds. See "ADVANCED DIALING" on Page 24

If you make a mistake when dialing, press **OFF** to hang up, then press the **PHONE** key to get the dial tone again.

DISCONNECTING

To end a call, either place the handset back in the base, or press **OFF** on the handset.

ANSWERING CALLS

When the Handset rings, press any key other than OFF, MUTE or the VOLUME keys to answer your call.

VOLUME CONTROLS

The volume controls for the handset are located on the side of the unit. Press the (up) or (down) keys to increase or decrease the volume. Holding either key down will continuously change the volume setting. The earpiece volume level indicator on the LCD will change accordingly. There are four volume levels.

FLASH

You can use your VTech VT 1922 cordless phone with services such as Call Waiting. Simply press the **PHONE** key to FLASH the line.

REDIAL

To **REDIAL** the last number you dialed, press the **PHONE** key, then press **REDIAL**. The phone will automatically dial the number. The number will be shown on the display.

CLEARING THE DISPLAY

The display can be cleared by pressing and holding the **CLEAR/DEL** key down until the display clears.

MUTE

- Press **MUTE** during conversation to disable the handset microphone.
- Press **MUTE** again to return to normal operation.

RINGER MUTE

- Press **MUTE** during incoming ringing to disable the ringer for the duration of the call.

HOLD

- Press **HOLD** to place an active call on hold.
- The LCD will display CALL ON HOLD.
- Press **HOLD** again to return to the call.

PAGE/HANDSET LOCATOR

- To page from the Base Unit, press **PAGE**.
- The LCD will display BASE PAGING HANDSET.
- To cancel the page, either press **PAGE** again on the Base Unit, or press **OFF** on the Handset.

ADVANCED FUNCTIONS

CALL WAITING

While you are on a call, you will hear an alert signal, warning that a second caller is trying to reach you. CALL WAITING is a subscription service, available from most local telephone service providers. Contact your provider for details.

If you subscribe to this service linked with CALLER ID (CID), the name and/or phone number of the second caller can be displayed on the LCD immediately after hearing the CALL WAITING alert. For more details, see **CID-CALLER ID**.

Switching calls using FLASH

- To switch over to the new call, press the **PHONE** key; the first call is put on hold.
- To switch back to the first call, press the **PHONE** key again.

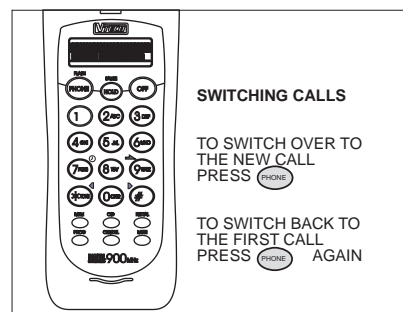

Temporary Tone

If you have rotary (dial-pulse) telephone service (**TONE/PULSE** switch is set to **PULSE**), this feature allows you to temporarily switch to TONE dialing for such purposes as remote access to answering machines, bank-by-phone services, use of calling cards and other special

First, dial the call normally. Then activate the Temporary Tone feature by pressing **TONE** (the ***** key). You can then press the numbers or symbols you need, and your phone will send the proper signals.

To end the call, press **OFF** or place the handset back in the base. The phone will automatically go back to rotary (dial-pulse) service.

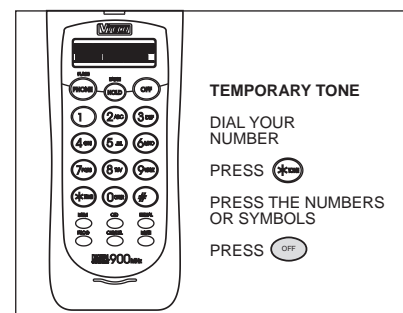

Programming The Ringer

The handset ringer is capable of four different types of ringer tones. The following sections detail how to select different ringer types and how to turn off the handset ringer.

ADVANCED FUNCTIONS

Changing Ringer Types

To program, the handset must be **OFF**.

To select a different ringer type do the following:

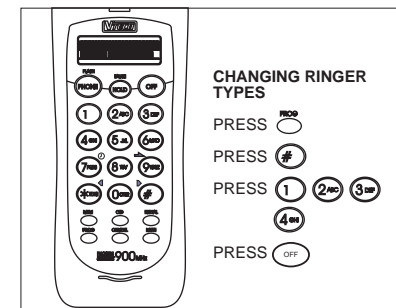

- Press: **PROG**
 Press: **#**
 Press: 1 for ringer type 1
 2 for ringer type 2
 3 for ringer type 3
 4 for ringer type 4

The handset LCD will show the ringer type selected, for example



Press **PROG** or **OFF** to exit.

Turning Off The Ringer

To turn off the ringer do the following:

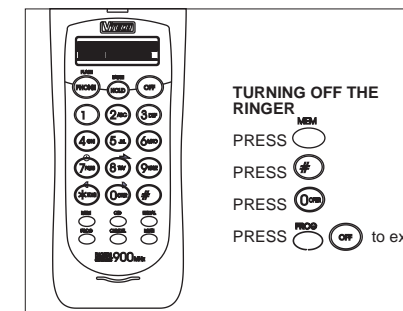

Checking The Ringer Type

To test the present ringer type, do the following:

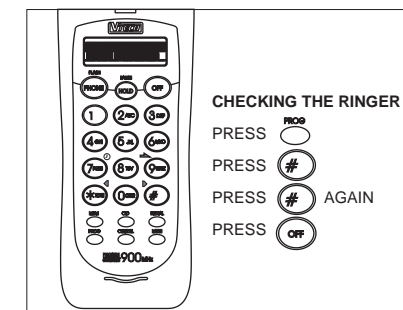

CLR/DEL Key Function

The **CLEAR** and **DELETE** functions can be accessed separately depending on how long the key is held down. For example, to clear the last digit entered on the display, press the **CLR/DEL** key for less than 1 second. Press and hold the **CLR/DEL** key for more than 1 second to completely clear the LCD.

The **DELETE** function is also used to delete CID and memory dial records, see **DELETING STORED NUMBERS**, and **DELETING NUMBERS**.

Advanced Dialing

There are two different ways to dial a number:

1. Press **PHONE** and wait for a dial tone. Then dial the number you want either manually, using **MEMORY** (MEM) dialing, **CID** dialing or **REDIAL**.
2. Enter the number you wish to dial on the display first. Then press **PHONE**. This will dial the number which is displayed on the LCD after 2 seconds.

NOTE:The phone will dial any number which is shown on the display. If you do not want to dial the number shown on the LCD, it can be changed by:

- Press and hold **CLR/DEL** until the display is cleared, then dial normally.
- Press **OFF** or **OFF** and start over.

Storing Memory (Speed) Dial numbers

To program a speed dial location, do the following:

- With the phone **OFF**, enter the telephone number you wish to store. (20 Digits Maximum).
- Enter program mode by pressing **PROG**. The display will show the following:



- Enter the memory location (01..20) you wish to store the number in. As soon as the second memory location digit is entered, the unit will emit a happy tone (a short series of beeps) to confirm successful programming and exit program mode.

If programming is unsuccessful the unit will display:

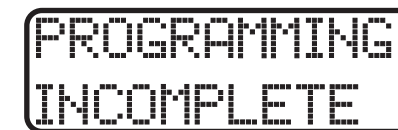

Unsuccessful programming can result from not correctly completing the programming sequence. For example, if after entering a number on the LCD and entering program mode, the **OFF** key were pressed instead of entering a valid memory location, the "PROGRAMMING INCOMPLETE" message would appear. If this message appears, simply repeat the programming sequence.

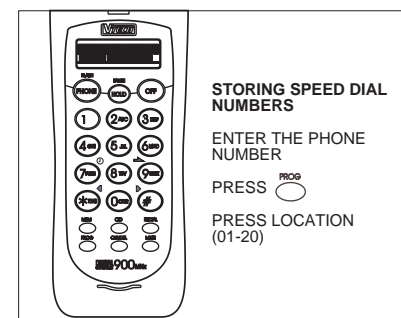

Dialing From Memory

- Press **(PHONE)** to get a line.
- Press **(MEM)**, you're prompted to enter a speed dial location number:

SPEED DIAL
LOCATION_

- Enter a 2 digit location number (01-20)
 - The number stored in that location will be displayed and immediately dialed.
- Or
- Beginning from the OFF mode, press **(MEM)** followed by a 2 digit location number (01-20).
 - Press **(MEM)** again to exit memory dial mode and leave the number on the display.
 - Note that if digits were on the display prior to entering memory dial mode, the contents of the speed dial memory will be appended to those digits. For example, if **1503** was on the LCD and the contents of the memory location is 6438981, then the display would show the following upon exiting memory dial mode:

1503 643898
1

Press **(PHONE)**, the number on the display will be dialed after a 2 second pause.

NOTE:

The ability to temporarily add memory contents to digits already entered on the display operates in the same way for CID and speed dial memories.

In this way, long distance and area codes (for example, **1503**) can be entered on the LCD and can preface numbers recalled from CID memory before dialing. This is important because only the last 7 digits of any number are displayed when dialing from CID memory.

Changing Stored Numbers

To change or replace a stored number simply enter the new number on the display and store it in the memory location you wish to change.

Deleting Stored Numbers

- Press **(MEM)**. The display will change to "SPEED DIAL LOCATION_ _".
- Enter memory location number (01-20).
- Press **(CLEAR/DEL)** key. The display will change to "LOCATION XX DELETED".

LOCATION XX
DELETED

- Press **(OFF)** to exit.

Storing Special Codes

To insert a pause in a phone number, press **(HOLD)** at the appropriate point when entering the number on the LCD.

This inserts a 2 second pause. A " P " appears in the display to show the pause. For longer pauses, press **(HOLD)** two or more times. Each press makes the pause 2 seconds longer and is treated as a stored digit.

If your phone is connected to a PBX, you can store the PBX access number and a pause before the phone number. For example, to store 9-PAUSE-555-1234 in memory location 08, do the following:

1. Press **(9)**
2. Press **(HOLD)**
3. Dial 5551234
4. Press **(PROG)**
5. Enter 08

NOTE:

Stored numbers are retained in memory even if the base loses its power or the handset battery is removed.

CID- CALLER ID

Your VTech VT1922 cordless phone is capable of displaying the name and/or phone number of the person calling, before you answer the phone. Subscription to Caller ID service through your local phone company is required to utilize this feature.

If you subscribe to alphanumeric (name & number) Caller ID service, the calling party's name and phone number (when available) will be displayed on the LCD screen while the phone is ringing.

If you subscribe to numeric (number only) Caller ID service, the calling party's phone number (when available) will be displayed on the LCD screen while the phone is ringing.

CALL WAITING CALLER ID (TYPE II CID)

Your VTech VT 1922 cordless phone is also capable of displaying Caller ID information in connection with a Call Waiting signal. If you are on a call, and receive a Call Waiting alert signal, the LCD will display the name and/or number (when available) of the party trying to reach you. As above, subscription to Call Waiting ID service through your local phone company is required in order to utilize this feature.

A WORD ABOUT CALLER ID - CID

Due to regional incompatibilities, Caller ID information may not be available for every call you receive. In addition, the calling party may intentionally block their name & phone number from being sent.

NOTE:

You must be in an area where CID service is available and you must subscribe to it to use this feature.

If you do not subscribe to the CID service, the phone will still operate normally except that the CID information is not received or displayed.

Receiving and Storing Calls

This unit receives and displays all CID information, the caller's telephone number, the caller's name and the exact date and time of the call.

The phone sequentially numbers these call records and retains them in the unit's CID memory for later review. These call record numbers are displayed as the first two digits in the display. The unit can store up to 50 numbers in its memory.

Once the CID memory is full, any new call forces a deletion of the oldest call record.

DIALING FROM CID MEMORY

NOTE:

Only the last 7 digits of any number are displayed when dialing from CID memory.

For example, when you press and hold the 7 key to view the phone number, you would see the following:

503-6438981
8:37A AUG31

However, when you dial directly from CID memory, only the last 7 digits of the received telephone number will be used. Consequently, you would actually dial this:

6438981

The VTech VT 1922 was designed to accommodate this situation. If you need to temporarily add a long distance prefix and /or area code (such as 1503) before the CID number, do the following:

- Beginning from the standby mode, key in the necessary digits. Your display will look like this:

1503

- Then, to temporarily add the last 7 digits only from a CID memory, press **CID**.
- Using the \square (*) and \square (#) keys, scroll through the received calls to locate the number you wish to dial.
- Once you have located the number you wish to dial, simply press **PHONE**. The last seven digits will be added to the numbers already in the LCD, and the whole number shown below will be automatically dialed.

1503 6438981
1

Special Message Indicators Out of Area Calls

If for any reason the telephone number of the caller is unavailable, or if the caller is outside the CID service area, the message UNAVAILABLE is displayed on the LCD.

UNAVAILABLE

"Private" Calls

If the caller has exercised the option to block his or her number from being sent, then the display will show PRIVATE.

PRIVATE

Transmission Error

If an error is detected, then the CID information is incomplete and will not be displayed. "TRANSMISSION ERROR" will be displayed on the LCD screen.

TRANSMISSION
ERROR

The occasional appearance of "TRANSMISSION ERROR" on your display does not indicate a problem with your unit or your telephone line. However, if this appears frequently, you may want to notify your telephone company.

Reviewing Numbers

Calls stored in memory can be reviewed by pressing **(CID)**. The display will show the number of the most recent (CALL #01). The top line of the display is used to indicate the memory location number and the bottom line of the display shows the name, see below:

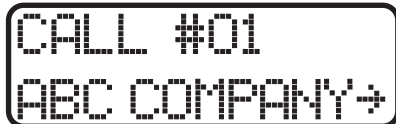

There may be additional characters in the name which can not be shown on the current display. Press the **→ (9)** key. This will overwrite the CID memory location on the top line to show up to a maximum of 15 alpha characters for the duration of the key press. The first 12 alpha characters will be on the top line with up to 3 additional characters on the second line.

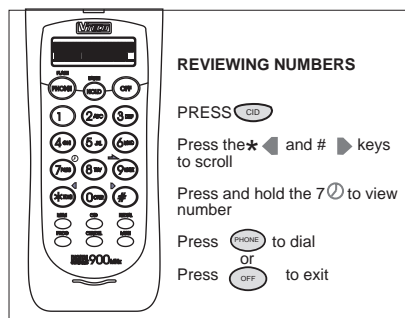
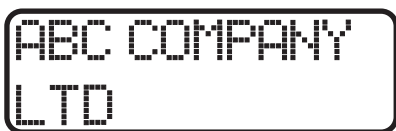

To find out the corresponding phone number as well as the date and time of the call, press and hold the **7 (🕒)** key. The date and time will be shown. Releasing the key will again show the caller's name.

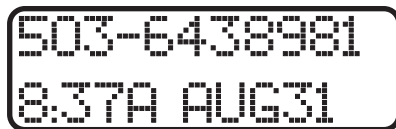

Pressing the **(◀) (*)** key displays the next lower in sequence call record. Likewise, pressing the **(▶) (#)** key displays the next higher in sequence call record. The higher the call number, the older the call.

To save you time in reviewing call records, you can "wrap-around" the call history log. For example, if you press the **(◀) (*)** key enough to scroll back to the first record, pressing it again will force the display to go to the very end of the call record.

DELETING NUMBERS

Pressing the **CLR/DEL** button deletes the CID number displayed.

- While the phone is in CID mode, press the **(CLR/DEL)** key once to delete the current call and the display will show:



- The older CID records will be moved forward by one location .

- Press and hold the **(CLR/DEL)** key for more than 2 seconds to delete the entire contents of CID memory. The display will show the following, for a final confirmation, before the entire CID memory is erased:

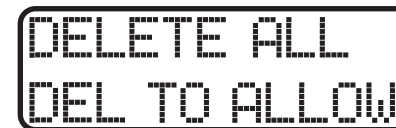

- Pressing any key other than **(CLR/DEL)** will cancel the operation. Pressing **(CLR/DEL)** will confirm the operation and the display will then show:

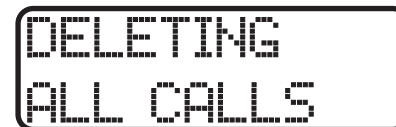

- The message will remain on the display for 2 seconds.

NOISE OR INTERFERENCE

Your VTech VT1922 cordless telephone has auto-channel scan circuitry which will detect excess noise and change the channel of the phone to reduce it. This is done automatically.

Since the VTech VT1922 is a fully digital phone, it does not suffer from noise associated with regular cordless phones. At times you may experience occasional "drop outs", especially at the extreme edges of the phone's range. Simply move closer to the base unit and this will disappear.

AUTOMATIC SECURITY CODING

Your VTech VT1922 phone is factory set with 16.8 million possible security codes. This unique security code allows your handset and base to recognize each other, and minimizes the possibility of another cordless phone using your telephone line.

OUT OF RANGE INDICATION

If the handset is moved to a point where the base and handset can no longer communicate, the handset will make a quick series of beeps to signal Out of Range.

If the handset is active when taken out-of-range, it will beep twice a second and enter standby mode after 25 seconds if the link is not reestablished. If the handset is brought back within range, it will automatically re-link.

For out-of-range in standby mode, the handset will beep once and then at 15 second intervals, will display "CHANNEL SEARCHING" on the



LCD, and scan all channels in an attempt to re-link with the base.

OUT OF RANGE WHEN PHONE IS ON

If you are presently engaged in a phone conversation move closer to the base. If the base unit does not communicate with the handset within 25 seconds of losing contact, it will automatically hang up.

OUT OF RANGE WHEN PHONE IS OFF

If the phone is OFF, the handset and base still monitor each other to make sure that they can communicate. If the handset is moved out of range, the handset will make a series of beeps, and will then display "CHANNEL SEARCHING" on the LCD. At 15 second intervals the handset will scan all channels in an attempt to reestablish communication with the base. This process does not require user intervention; the handset will re-link with the base automatically once it is brought back within range. The unit will then be able to receive and place calls.

When the base unit is unplugged from the power supply, the handset will give the "Out of Range" warning beep. Plug the base in again and this will stop.

Your Vtech cordless phone is equipped with a 2.5mm Headset Jack for use with an optional accessory Headset for hands-free operation.

If you choose to use the Headset option, you must obtain an optional accessory Headset, which is compatible with the Vtech cordless phone.

To purchase a Headset, call VTech at 1-800-595-9511.

Once you have a compatible 2.5mm Headset, locate the Headset Jack on the Vtech cordless phone Handset. Connect the plug on the Headset cord to the jack on the cordless Handset. The plug should fit securely. Do not force the connection.

OPERATION

NOTE: Whenever a compatible Headset is connected to the cordless Handset, the microphone on the Handset will be muted. This is done to limit the effect of background noise.

The following operational characteristics apply to Vtech Headsets. The same may also apply to other, non-Vtech supplied headsets, but Vtech assumes no responsibility for their performance.

The Vtech brand compatible Headset has a reversible, monaural design. You can wear your Headset on either ear, leaving one ear free for room conversation.

The headband can be adjusted to fit the contour of your head. Using

both hands, slide the headband up or down so that it rests comfortably on your head, with the speaker cushion centered against your ear.

For maximum sound quality, the flexible microphone should be positioned at the corner of your mouth, about one inch from your face.

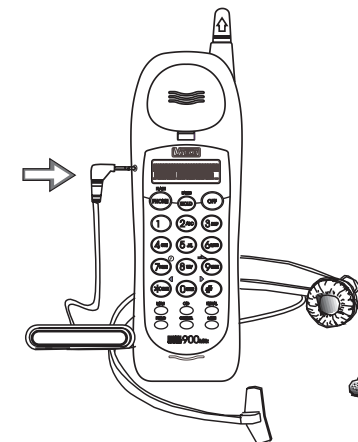

BELT CLIP

The Vtech cordless phone is also equipped with a detachable belt clip. Align the pins on the inside edge of the clip with the notches on the sides of the Vtech cordless phone Handset. The belt clip should snap securely into place. Do not force the connection.

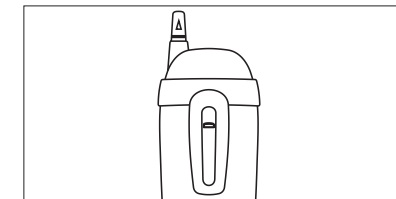

TAKING CARE OF YOUR TELEPHONE.

Your VTech VT1922 cordless telephone contains sophisticated electronic parts, so it must be treated with care.

Avoid rough treatment

Place the handset down gently. Save the original packing materials to protect your telephone if you ever need to ship it.

Avoid water

Your telephone can be damaged if it gets wet. Do not use the handset outdoors in the rain, or handle it with wet hands. Do not install your base unit near a sink, bathtub or shower.

Electrical storms

Electrical storms can sometimes cause power surges harmful to electronic equipment.

For your own safety, use caution when using electric appliances during storms.

If you have difficulty operating your phone, the suggestions below should solve the problem. If you still have difficulty after trying these suggestions, call VTECH Communications at 1-800-595-9511. In Canada, call VTECH Electronics at 1-800-267-7377.

THE PHONE DOESN'T WORK AT ALL.

- Make sure the Power Cord is plugged
- Make sure the telephone line cord is plugged firmly into the base unit and the telephone wall jack.
- Make sure the batteries are properly charged. If the 'LOW BATTERY' message is shown, the battery pack needs charging.

NO DIAL TONE.

- First check all the suggestions above.
- If you still don't hear a dial tone, disconnect the base unit from the telephone jack and connect a different phone. If there is no dial tone on that phone either, the problem is in your wiring or local service. Call your local telephone company.

YOU GET NOISE, STATIC, OR A WEAK SIGNAL EVEN WHEN YOU'RE NEAR THE BASE UNIT.

- Household appliances plugged into the same circuit as the base unit can sometimes cause interference. Try moving the appliance or the base unit to another outlet.

YOU GET NOISE, STATIC, OR A WEAK SIGNAL WHEN YOU'RE AWAY FROM THE BASE UNIT.

- You may be out of range. Either move closer to the base, or relocate the base unit.
- The layout of your home may be limiting the range. Try moving the base unit to another position.

THE HANDSET DOES NOT RING WHEN YOU RECEIVE A CALL.

- Make sure you have the handset ringer activated. To set the ringer, see "**PROGRAMMING THE RINGER**".
- Make sure the telephone line cord is plugged firmly into the base unit and the telephone jack. Make sure the power cord is plugged in.
- You may be too far from the base unit.
- You may have too many extension phones on your telephone line to allow all of them to ring. Try unplugging some of the other phones.

YOU HEAR OTHER CALLS WHILE USING YOUR PHONE.

- Disconnect your base unit from the telephone jack, and plug in a regular telephone. If you still hear other calls, the problem is probably in your wiring or local service. Call your local telephone company.

YOU HEAR NOISE IN THE HANDSET, AND NONE OF THE KEYS OR BUTTONS WORK.

Make sure the power cord is plugged in.

COMMON CURE FOR ELECTRONIC EQUIPMENT

Electronics, like people, can sometimes get confused. If the unit does not seem to be responding normally, then try putting the handset in the cradle. If it does not seem to respond after trying this a few times, do the following (in the order listed):

1. Disconnect the power to the base.
2. Disconnect the handset battery.
3. Remove the base unit spare battery pack, where applicable.
4. Wait a few minutes.
5. Connect power to the base.
6. Re-install the battery pack.
7. Watch for Handset to display:
FOUND CHANNEL_

Cleaning your telephone

Your telephone has a durable plastic casing that should retain its luster for many years. Clean it only with a soft cloth slightly dampened with water or a mild soap. Do not use excess water or cleaning solvents of any kind.

Remember that electrical appliances can cause serious injury if used when you are wet or standing in water. If your base unit should fall into water, **DO NOT RETRIEVE IT UNTIL YOU UNPLUG THE POWER CORD AND TELEPHONE LINE CORDS FROM THE WALL.** Then pull the unit out by the unplugged cords.

WHAT DOES OUR WARRANTY COVER?

- Any defect in material or workmanship.

FOR HOW LONG AFTER THE ORIGINAL PURCHASE?

- To the original purchaser only - ONE YEAR.

WHAT WILL VTECH DO?

- At our option, repair or replace your unit.

HOW DO I SEND MY UNIT, IN OR OUT OF WARRANTY?

- In the U.S. Call VTECH Communications customer service for Return Authorization at 1-800-595-9511
- In Canada call Vtech Electronics at 1-800-267-7377
- Properly pack your unit. Include any cables & accessories which were originally provided with the product. We recommend using the original carton and packing materials.
- Include in the package a copy of the sales receipt or other evidence of date of original purchase (if the unit was purchased within the last twelve months).
- Print your name and address, along with a description of the defect, and include this in the package Or Vtech Electronics.
- Include payment for any service or repair not covered by warranty, as determined by VTECH Communications.
- Ship the unit via UPS Insured, or equivalent to:
- In the U.S.

VTECH COMMUNICATIONS

11035 SW 11th Street
Bldg. B Suite 270
Beaverton, OR 97005

If you bought your phone in Canada, Ship the unit via UPS Insured, or equivalent to:

VTECH ELECTRONICS
SUITE 200-7671 ALDERBRIDGE WAY
RICHMOND, B.C. V6X 1Z9

VTECH Communications assumes no responsibility for units sent without prior Return Authorization.

WARRANTY STATEMENT

WHAT DOES OUR WARRANTY NOT COVER?

- Batteries
- Damage from misuse, neglect, or acts of nature (lightning, floods, power surges, etc.)
- Products which may have been modified or incorporated into other products
- Products purchased and/or operated outside the USA, its territories, or Canada.
- Products serviced by the owner or a service facility not expressly authorized by VTECH Communications
- Products purchased more than 12 months from current date
- Units purchased in "AS IS" condition, or units purchased as "Distressed Merchandise".

HOW DOES STATE LAW OR PROVINCIAL LAW RELATE TO THIS WARRANTY?

- This warranty gives you specific rights. You may also have other rights which vary from state to state as province to province.

TECHNICAL SPECIFICATIONS

FREQUENCY CONTROL

Crystal Controlled Dual PLL Synthesizer

TRANSMIT FREQUENCY

Handset: 925.05 MHz to 927.75 MHz
(All ten channels within this range)

Base : 902.3 MHz to 905.0 MHz
(All ten channels within this range)

RECEIVE FREQUENCY

Handset: 902.3 MHz to 905.0 MHz
(All ten channels within this range)

Base : 925.05 MHz to 927.75MHz
(All ten channels within this range)

NOMINAL EFFECTIVE RANGE

Maximum power allowed by FCC and IC. Actual operating range may vary according to environmental conditions at the time of use.

SIZE

Handset: 17.4 x 5.9 x 4cm (L x W xT)
Maximum (Antenna excluded)

Base : 19.4 x 14 x 6cm (L x W x T) Maximum (Antenna excluded)

WEIGHT

Handset: 180 grams
Base : 360 grams

POWER REQUIREMENTS

Handset: Self-contained nickel-cadmium rechargeable battery supply, 3.6V nominal, 600mAh capacity.

Base: 9VDC @ 300mA

MEMORY

Speed Dial: 20 Memory locations, 20 digits per location.

CID : Alpha Numeric Display 50 Memory locations

SPECIFICATIONS ARE TYPICAL AND MAY CHANGE WITHOUT NOTICE.

TABLE OF CONTENTS

	Page
INTRODUCTION	1
Special Features	2
Parts Checklist	3
FCC AND IC REGULATIONS	4
Fcc Part 15	4
Fcc Part 68	5
IMPORTANT SAFETY INSTRUCTIONS	7
REPLACING THE BATTERY PACK	9
To Charge The Battery Pack	9
Spare Battery	11
GETTING STARTED	13
WALL MOUNTING	15
THE LCD DISPLAY	16
THE HANDSET LAYOUT	17
THE BASE UNIT LAYOUT	18
QUICK REFERENCE GUIDE	19
Set-Up	19
CID-Caller ID	20
BASIC OPERATION	21
ADVANCED FUNCTIONS	22
Call Waiting	22
Switching Calls using FLASH	22
Temporary Tone	22
Programming The Ringer	22
Changing Ringer Types	23
Turning Off The Ringer	23
Checking The Ringer Type	23
CLR/DEL Key Function	23
Advanced Dialing	24
MEMORY DIALING	25
Storing Speed Dial Numbers	25
Dialing From Memory	26
Changing Stored Numbers	26
Deleting Stored Numbers	26
Storing Special Codes	27
CID-CALLER ID	28
Receiving and Storing Calls	29
Dialing From CID Memory	28
Out Of Area Calls	29
"Private" Calls	29
Transmission Error	29
Reviewing Numbers	30
Deleting Numbers	31
ADDITIONAL OPERATING TIPS	32
HEADSET OPERATION	33
MAINTENANCE	34
IN CASE OF DIFFICULTY	35
WARRANTY	37
TECHNICAL SPECIFICATIONS	39



VTECH COMMUNICATIONS LTD.



Is a trademark of VTECH COMMUNICATIONS LTD., a member of THE VTECH GROUP OF COMPANIES.

Distributed in the U.S.A. by VTECH Communications, 11035 SW 11th STREET BDLG .B,SUITE 270 Beaverton, Oregon, 97005.

Distributed in Canada by VTECH Electronics Canada Ltd., Suite 200 - 7671 Alderbridge Way Richmond, B.C. V6X 1Z9.

Copyright 1999 for VTECH COMMUNICATIONS LTD..

Printed in China

91-5076-20-00
ISSUE 0

Free Manuals Download Website

<http://myh66.com>

<http://usermanuals.us>

<http://www.somanuals.com>

<http://www.4manuals.cc>

<http://www.manual-lib.com>

<http://www.404manual.com>

<http://www.luxmanual.com>

<http://aubethermostatmanual.com>

Golf course search by state

<http://golfingnear.com>

Email search by domain

<http://emailbydomain.com>

Auto manuals search

<http://auto.somanuals.com>

TV manuals search

<http://tv.somanuals.com>