

TABLE OF CONTENTS

INTRODUCTION	3
Parts Check List	4
IMPORTANT SAFETY INSTRUCTIONS	5
REPLACING THE HANDSET BATTERIES	6
GETTING STARTED	8
Setting Up Your VTECH VT 9151/VT 9155	8
WALL MOUNTING	9
HANDSET FEATURES	10
IN USE/LOW BATT LED	10
PHONE KEY / FLASH function	10
CHANNEL KEY	10
OFF KEY	10
MEM KEY	10
PROG KEY	10
REDIAL KEY	10
TONE/*KEY	10
VOLUME CONTROL	10
HEADSET JACK	10
BASE UNIT FEATURES	11
POWER LED	11
CHARGE LED	11
IN USE LED	11
SPARE BATTERY LED	11
PAGE KEY	11
BASE UNIT DISPLAY	12
OPERATING INSTRUCTIONS	13
Making Calls	13
Answering Calls	13
Disconnecting	13
Changing Channels	13
TONE / PULSE Setting	13
Temporary Tone	14
Programming The Ringer Type	14
Turning Off The Ringer	14
Checking The Ringer	14
Memory Dialing	15
Programming Speed Dial Numbers	15
Speed Number Dialing	15
To Change or Replace a Speed Dial Number	15
To Clear the Stored Number	15
Storing Special Codes	16
Using Redial	16
Storing a Redial Number into Speed Dial	16
The Page Feature	16
ITAD BASE LEDS	17
MAILBOX LED's	17
ANSWER ON/OFF LED	17
ITAD BASE KEYPAD FUNCTIONS	18
ANSWER ON/OFF KEY	18
MAILBOX X (1,2 or 3) KEY	18
REC/MEMO KEY	18

TABLE OF CONTENTS

MENU KEY	19
SELECT KEY	19
TIME/SET KEY	20
DELETE KEY	20
REPEAT/SLOW KEY	20
SKIP/QUICK KEY	21
VOLUME UP KEY	21
VOLUME DOWN KEY	21
ITAD OPERATION	22
Default ITAD Settings	22
ITAD Programming Overview	22
Selecting Announcement	22
Recording / Playing / Deleting the OGM's	22
Set Security Code	23
Day and Time Setup	23
Set Audible Message Alert	23
Set Announce Only	24
Set Base Ringer ON/OFF	24
Set Number of Rings	24
Leaving a Message (Incoming Message)	25
Listening to Messages / Memos	25
Saving Messages	26
Deleting Messages	26
Turning the ITAD ON/OFF	26
Call Screening	27
Audible Current Day and Time	27
Changing Speaker Volume	27
Changing Playback Speed	28
Auto Disconnect for Extension Phone Pick-up	28
Memory Full	28
Power Failure	28
REMOTE OPERATION OF ITAD	29
To Activate Remote Operation From a Different Telephone Line	29
Playing Messages Remotely	29
Repeat Messages During Playback	29
Skip Messages During Playback	29
Stop Message Playback	29
Deleting Messages	30
Memo Recording	30
Change OGM Remotely	30
Check OGM Remotely	30
Turning ITAD ON or OFF	30
Voice Menu for Remote Operation	30
Exiting Remote Operation	30
OPTIONAL HEADSET INSTALLATION AND OPERATING INSTRUCTIONS	31
MAINTENANCE	32
IN CASE OF DIFFICULTY	33
WARRANTY STATEMENT	34
FCC AND IC REGULATIONS	35
TECHNICAL SPECIFICATIONS	37

INTRODUCTION

Congratulations! You have purchased one of the best performing cordless telephones on the market! The **VTECH VT 9151/VT 9155** is a single line 900 MHz cordless phone.

The **VTECH VT 9151/VT 9155** base unit includes an Integrated Telephone Answering Device (ITAD). The ITAD uses digital memory to record messages, eliminating the need for cassette tapes. You can access your messages from the base unit, or from a remote location. All programming and remote operation functions are guided by a voice menu system.

Other special features are:

- 10 Number Speed Dial Memory
- 30 Channels of operation
- Automatic Search for Available Channel
- Manual Channel Change on Handset
- PAGE from Base to Handset
- REDIAL feature
- Programmable Ringer Types
- Low Battery Detect and Warning indicator
- Hearing Aid Compatible Receiver
- Easy answer - when the phone rings simply press any key on the handset to answer (except OFF)
- Removable battery pack
- Extra Battery Charger in the base unit
- Touch Tone and Pulse Dialing
- Temporary Tone Mode
- 2.5mm Jack on Handset for *optional* Headset use.

ITAD Features:

- Up to 15 minutes recording time.
- Voice menu for local or remote operation.
- 7 segment LED indicator.
- Day and time stamp for incoming messages.
- Auto disconnect stops ITAD from answering call when an extension is picked up.
- Variable speed message playback.
- Selective message delete allows you to keep important messages.
- Message length control; stops recording after 6 seconds of silence.
- Messages and ITAD settings will be retained even after power failure.
- Ring pick-up selection; unit can be set to pick-up after 2 rings, 4 rings, 6 rings or Toll-saver.
- Call screening selection.
- Memo recording capability.
- Programmable security code for remote operation.
- Volume control with 8 levels for the ITAD speaker.
- 3 individual mailboxes for personalized message storage and retrieval.

This manual is designed to familiarize you with the **VTECH VT 9151/VT 9155**. To get the most use out of your **VTECH VT 9151/VT 9155**, we strongly recommend you read the manual before using your phone.

INTRODUCTION

Parts Check List:

1. Base unit
2. Handset
3. AC adapter
4. Telephone line cord
5. Battery pack
6. Wall mounting bracket
7. Belt Clip

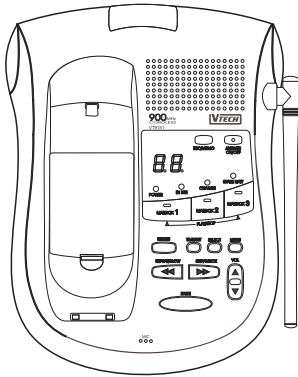

BASE UNIT



HANDSET

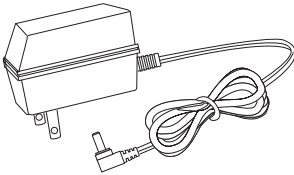

AC ADAPTER

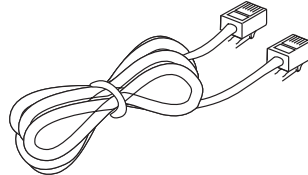

TELEPHONE LINE CORD

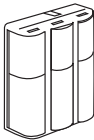

BATTERY PACK

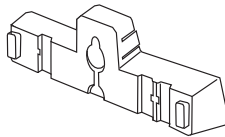

WALL MOUNTING BRACKET

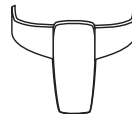

BELT CLIP

IMPORTANT SAFETY INSTRUCTIONS

When using your telephone equipment, basic safety precautions should always be followed to reduce the risk of fire, electric shock and injury to persons, including the following:

1. Read and understand all instructions.
2. Follow all warnings and instructions marked on the product.
3. Unplug this product from the wall outlet before cleaning. Do not use liquid cleaners or aerosol cleaners. Use a damp cloth for cleaning.
4. Do not use this product near water (for example, near a bath tub, kitchen sink, or swimming pool).
5. Do not place this product on an unstable cart, stand, or table. The product may fall, causing serious damage to the product.
6. Slots and openings in the cabinet and the back or bottom are provided for ventilation. To protect it from overheating, these openings must not be blocked by placing the product on the bed, sofa, rug, or other similar surface. This product should never be placed near or over a radiator or heat register. This product should not be placed in a built-in installation where proper ventilation is not provided.
7. This product should be operated only from the type of power source indicated on the marking label. If you are not sure of the type of power supply to your home, consult your dealer or local power company.
8. Do not allow anything to rest on the power cord. Do not locate this product where the cord will be abused by persons walking on it.
9. Never push objects of any kind into this product through cabinet slots as they may touch dangerous voltage points or short out parts that could result in a risk of fire or electric shock. Never spill liquid of any kind on the product.
10. To reduce the risk of electric shock, do not disassemble this product. If service or repair work is required, contact VTech Customer Service at **1-800-595-9511** in the U.S. and at **1-800-267-7377** in Canada. Opening or removing cabinet parts other than specified access doors may expose you to dangerous voltages or other risks. Incorrect reassembling can cause electric shock when the appliance is subsequently used.
11. Do not overload wall outlets and extension cords as this can result in the risk of fire or electric shock.
12. Unplug this product from the wall outlet :
 - A. When the power supply cord or plug is damaged or frayed.
 - B. If liquid has been spilled into the product.
 - C. If the product has been exposed to rain or water.
 - D. If the product does not operate normally by following the operating instructions. Adjust only those controls that are covered by the operating instructions because improper adjustment of other controls may result in damage and will often require extensive work to restore the product to normal operation.
 - E. If the product has been dropped and the cabinet has been damaged.
 - F. If the product exhibits a distinct change in performance.
13. Avoid using a telephone (other than a cordless type) during an electrical storm. There may be a remote risk of electric shock from lighting.
14. Do not use the telephone to report a gas leak in the vicinity of the leak.

SAVE THESE INSTRUCTIONS

REPLACING THE HANDSET BATTERIES

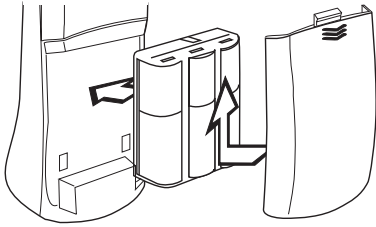
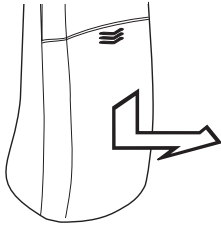

1. Remove the battery case by pressing on the ridged lines and sliding downward.
2. Discard the old battery pack. Don't put the old battery pack in a trash compactor or a fire - it could burst.

IMPORTANT: Do not dispose of this battery in household garbage. For information on recycling or proper disposal, consult your local solid waste collection or disposal organization.

3. Place the new battery pack in the battery compartment. Make sure the metal contacts on the underside of the battery are aligned with charging contacts in battery compartment.
4. The new battery pack must be charged before using your telephone. Place the handset in the cradle of the base unit to allow it to charge for 24 hours. Maximum battery life between charges is 4 hours of continuous talk time or 7 days of standby.

CAUTION: To reduce the Risk of Fire or Injury to Persons, Read and Follow these Instructions:

1. Use only VTECH battery.
2. Do not open or mutilate the battery. Released electrolyte is corrosive and may cause damage to the eyes or skin. It may be toxic if swallowed.
3. Exercise care in handling batteries in order not to short the battery with conducting materials such as rings, bracelets, and keys. The battery or conductor may overheat and cause burns.
4. Do not dispose of the battery in a fire. The cell may explode.

IF THE BATTERY PACK DOESN'T RECHARGE

The battery pack can be recharged many times; but if you get a low-battery signal, or the handset seems completely dead, even after 24 hours of charging, the battery pack should be replaced. To purchase replacement battery packs, use the enclosed order form, or call Vtech Communications at **1-800-595-9511** in the U.S. and at **1-800-267-7377** in Canada.

SPARE BATTERY CHARGER

Your **VTech VT 9151/VT 9155** is equipped with a spare battery charger built-in to the base unit. The spare battery charger allows you to always have a charged battery available, should your handset battery discharge during normal use.

Contact your local VTech dealer, or call VTech Customer Service to purchase a spare battery pack.

REPLACING THE HANDSET BATTERIES

To install the Spare Battery Pack:

1. Open the base unit battery compartment.
2. Place the spare battery pack in the battery compartment. Make sure the metal contacts on the underside of the battery are aligned with charging contacts in battery compartment.
3. Replace the battery compartment cover.
4. When the battery is installed properly, the spare battery LED on the base unit will be illuminated.
5. The spare battery will be fully charged after 24 hrs. Please note that the spare battery LED will always be illuminated when a spare battery is installed.

The RBRC™ Seal



The **RBRC®** Seal on the (easily removable) nickel-cadmium battery (contained in our product) indicates that VTech Communications, Inc. is voluntarily participating in an industry program to collect and recycle these batteries at the end of their useful lives, when taken out of service within the United States and Canada.

The **RBRC®** program provides a convenient alternative to placing used nickel-cadmium batteries into the trash or municipal waste, which may be illegal in your area.

VTech's partnership with **RBRC®** makes it easy for you to drop off the spent battery at local retailers participating in the RBRC program or at authorized VTech product service centers. Please call **1-800-8-BATTERY™** for information on Ni-Cd battery recycling and disposal bans/restrictions in your area. VTech's involvement in this program is part of its commitment to protecting our environment and conserving natural resources.

RBRC® is a registered trademark of Rechargeable Battery Recycling Corporation.

GETTING STARTED

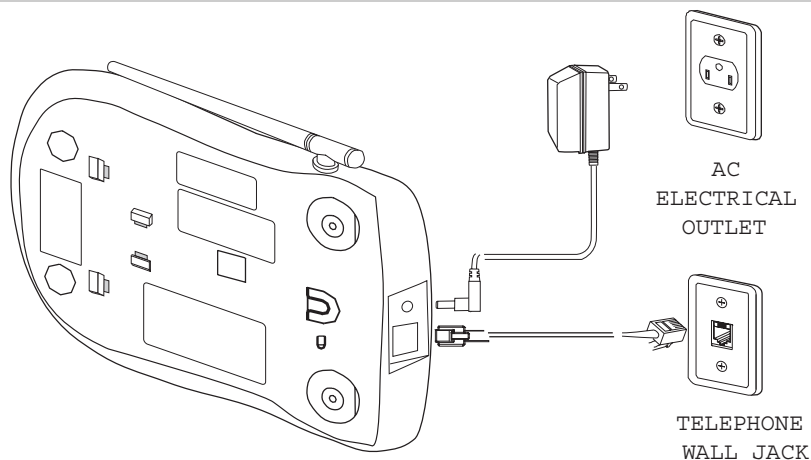

Setting Up Your VTECH VT 9151/VT 9155

1. Choose an area near an electrical outlet and a telephone wall jack.
2. Plug the AC power adapter into an electrical outlet and the DC connector to the back of the base unit.

CAUTION: Use only the AC adapter shipped with your **VTECH VT 9151/VT 9155**. This is a Class 2 AC adapter, specifically designed for use with the **VTECH VT 9151/VT 9155**.

NOTE: Connect power to the base unit before placing the handset in the cradle.

3. The **ANSWER ON/OFF** indicator key will then turn on to indicate the ITAD is initialized. After a while, the display will show "CL" flashing, indicating that the day and time must be set.
4. **CHARGE THE HANDSET BATTERIES BEFORE USE.** The batteries recharge automatically whenever the handset is in the base unit cradle. The batteries must be charged for **24 hours** before using your phone for the first time.

5. Connect the telephone line cord. Insert one end of the telephone line cord into the jack at the rear of the base unit. Plug the other end into a telephone wall jack. Make sure the plugs snap securely into place.
6. **CHECK FOR A DIAL TONE.** After the batteries are charged, pick up the handset and press the **PHONE** key. The PHONE indicator should light up, and you should hear a dial tone. If not, see **IN CASE OF DIFFICULTY**.

CAUTION:

1. Never install telephone wiring during a lightning storm.
2. Never install telephone jacks in wet locations unless the jack is specifically designed for wet locations.
3. Never touch un-insulated telephone wires or terminals unless the telephone line has been disconnected at the network interface.
4. Use caution when installing or modifying telephone lines.

WALL MOUNTING

- 1. Choose a spot near an electrical outlet and a telephone jack.** Your phone requires a modular telephone jack and a standard electrical outlet (120v AC). The power cord is six feet long; make sure there is an electrical outlet within reach of the base. The outlet should not be controlled by a wall switch. If the switch is ever turned off, the phone will not operate.
- 2. Position the wall mount adapter on the base.** Line up the tabs on the wall mount adapter with the holes on the bottom of the base. Snap the wall mount adapter firmly in place.
- 3. Mount the base on the wall.** Position the base so the mounting studs will fit into the holes on the bottom of the base. Position the power cord to extend down the wall the phone is to be mounted on. Slide the base down on the mounting studs until it locks into place.
- 4. Connect the telephone cord.** The telephone line cord has a snap-in plug at each end. Insert one of the plugs into the jack on the bottom of the base. Insert the other end of the plug into the wall jack.
- 5. Connect the power cord.** Plug the DC connector into the DC jack at the rear of the base unit. Plug the AC power adapter into an electrical outlet.

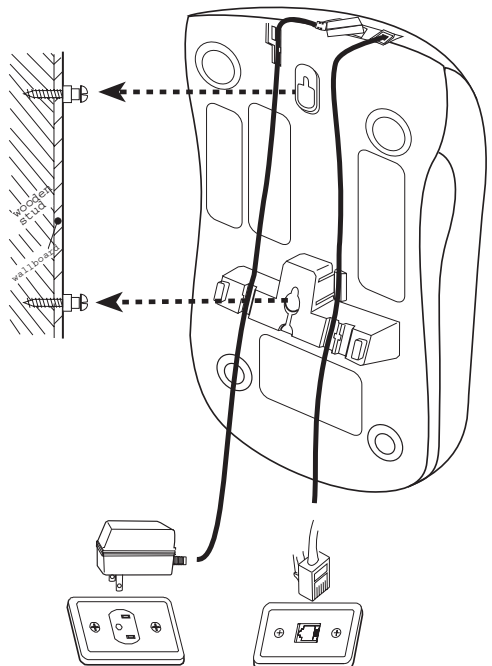

HANDSET FEATURES

IN USE/LOW BATT LED

- The **IN USE LED** lights when the phone line is being used by the handset.
- It flashes in cadence with an incoming ring.
- It flashes quickly during PROG mode.
- The LED will flash slowly when the handset battery is getting low and needs to be recharged.

VOLUME CONTROL

- Set Volume switch on the side of the Handset to high (H), medium (M) or low (L), depending on your preference.

PHONE KEY / FLASH FUNCTION

- Press this key to make a call.
- If you are currently on a call, pressing **PHONE** flashes the line. This would be used with a feature like call waiting to answer your second call.

TONE / * KEY

- In **PULSE** dialing mode, this key is used to switch to Temporary **TONE** dialing mode.

PROG KEY

- Press **PROG** key to enter PROGRAM mode. See page 15 for more details.

MEM KEY

- Press this key to enter MEMORY mode. See page 15 for more details.

HEADSET JACK

- Connect a 2.5mm Headset set to the jack for hands-free operation.

OFF KEY

- Press this key to exit all modes of operation.

CHANNEL KEY

- Pressing this key when the handset is in use will activate a channel change to the next free channel.
- This is used if you are experiencing noise or interference on the current channel.

REDIAL/PAUSE KEY

- To dial the last number that was called on your phone.
- It can also be used to store the last number dialed into the speed dial memory. See page 16 for details.
- During Speed Dial programming, press this key to insert a 2 second PAUSE in dialing sequence.

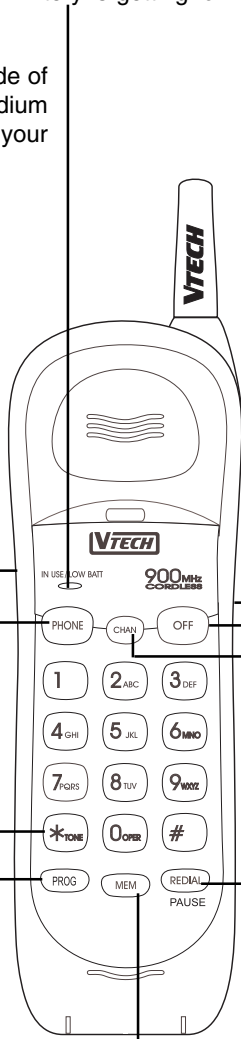

BASE UNIT FEATURES

IN USE LED

- The **IN USE** LED illuminates whenever the handset is being used.
- The **IN USE** LED also flashes with the cadence of the incoming ring.

POWER LED

- This LED illuminates when the base power adapter is plugged in and power is applied to the base unit.

CHARGE LED

- This LED illuminates steadily when the handset is in the base cradle to indicate that the handset battery is being charged.

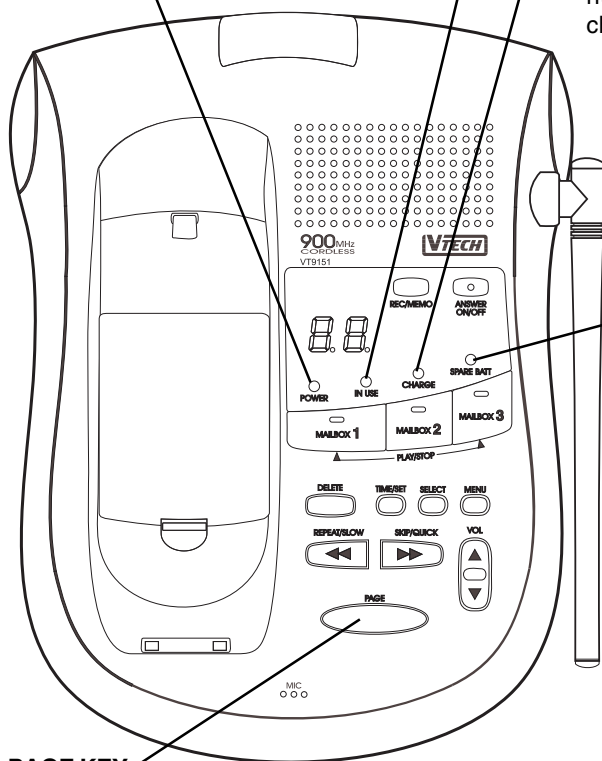

SPARE BATTERY LED

- This LED illuminates steadily when a battery is placed in the base unit charge cradle.

PAGE KEY

- Press this key to page the handset. See page16 for details.
- Press it a second time to cancel a page.
- The base will ring the handset for 60 seconds (STANDBY mode) or one page tone (PHONE mode) before ending the page automatically.
- The handset can also cancel the page by pressing the **OFF** key.

BASE UNIT FEATURES

BASE UNIT DISPLAY

The display provides useful information on the status of your **VTECH VT 9151/VT 9155** answering device. Below are the descriptions of the display.

<i>Message window</i>	<i>LED status</i>	<i>What it means:</i>
0	Steady	No new messages in any mailboxes.
1-98	Flashing	Total number of new messages in all mailboxes.
0-99 & F	Alternating	Memory is full, or total number of messages is 99.
1-99	Counting	During OGM/Memo recording, the message window shows the length of the announcement recording in seconds.
99	Flashing	Recording time exceeds 99 seconds.
1-99	Steady	During message playback, the system shows the current message number in selected mailbox.
1-8	Steady for 1 second	The system shows the current volume level when pressing the ▲ or ▼ keys.
00-99	Steady	During remote access code setting, the system shows the current code.
A	Steady	System is in Announce-Only mode.
On or Off	Steady for 1 second	When any setting is changed to On or Off.
CL	Alternating with the normal display	After power failure, the clock needs to be set.
--	Steady	System is answering a call or in remote operation.
--	Flashing	The system is in program mode when MENU is pressed or during initialization.

OPERATING INSTRUCTIONS

Making Calls-----

1. Pick up the handset and press **PHONE**.
2. When you hear a dial tone, dial the number.
3. The indicator for **IN USE** (on the base unit and handset) will light. If you make a mistake when dialing, press **OFF** to hang up, then press **PHONE** to get the dial tone again.

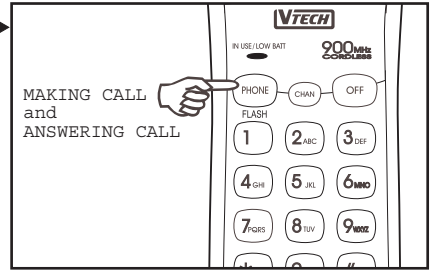

You must always press **PHONE** before you can dial a call on the handset.

Answering Calls

1. When an incoming call is ringing, the **IN USE** LED in the base and the **IN USE** LED in the handset will flash. To make sure your phone rings when the handset is away from the base, please keep the base antenna in the upright position.
2. To answer a call when the handset is in the base, just pick up the handset.
3. To answer a call when the handset is away from the base, just press any key on the handset (EXCEPT OFF). This is very useful in a dark environment; you do not have to fumble around looking for the **PHONE** key to answer the call.

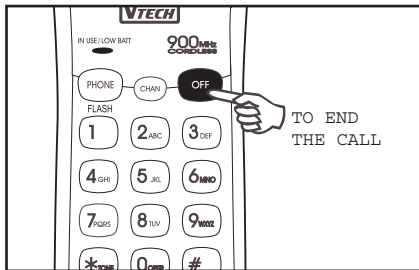

Disconnecting

To end a call, either place the handset back in the base, or press **OFF** on the handset.

Changing Channels-----

If you notice interference when using your handset, press **CHAN** to switch to a clear channel. This function is only available when you are on a call.

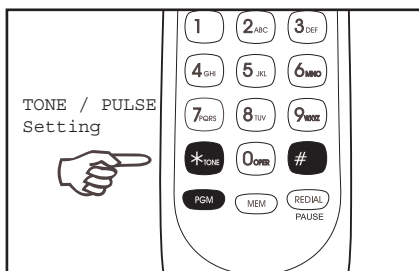
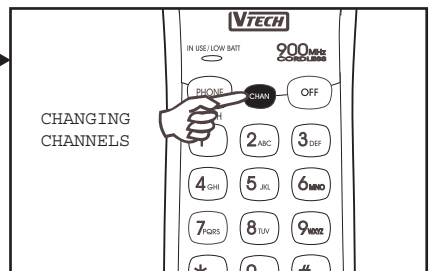

TONE/PULSE Setting

If you have touch tone service on your line, Press **PROG**, *, *, **MEM** to switch to TONE dialing. If you have rotary service, press **PROG**, *, #, **MEM** to switch to PULSE dialing.

NOTE: Your VT9151/VT9155 is preset at the factory for TONE dialing.

OPERATING INSTRUCTIONS

Temporary Tone -----

If you have a rotary (dial-pulse) telephone service, (**TONE/PULSE** setting is set to **PULSE**), this feature allows you to enter special codes and tones to operate answering machines, use electronic banking services, calling cards, or other special services.

Note: If you have touch-tone service, (**TONE/PULSE** setting set to **TONE**), just enter the codes normally.

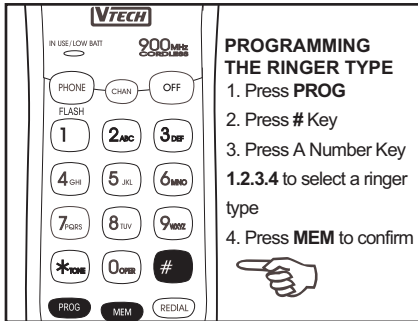
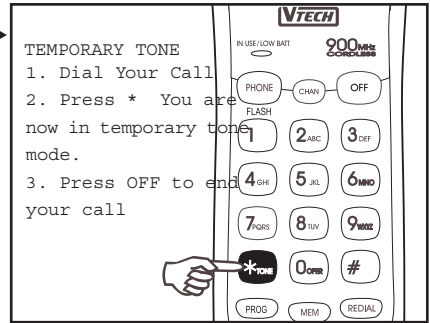

Programming The Ringer Type

The handset ringer is capable of four different types of ringing tones.

To program, the handset must be **OFF**.

Turning Off The Ringer -----

TURNING OFF THE RINGER

1. Press **PROG**
2. Press # Key
3. Press 5
4. Press **MEM** to confirm
5. To turn ringer on again, see **Programming the Ringer Type**.

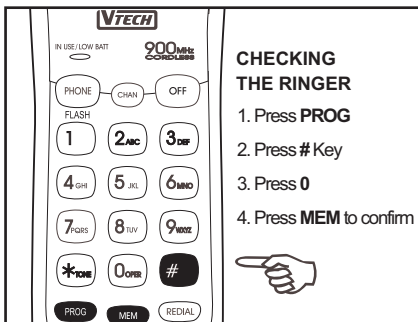
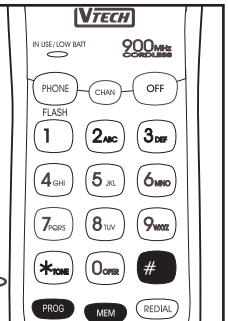

Checking The Ringer

OPERATING INSTRUCTIONS

Memory Dialing

The **VTECH VT 9151/VT 9155** can store up to 10 different phone numbers that you can dial just by pressing **MEM** and one of the number keys (**0-9**).

Programming Speed Dial Numbers

The handset must be **OFF**.

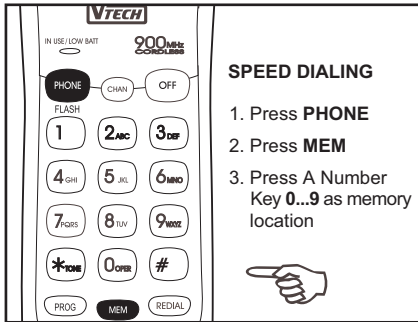
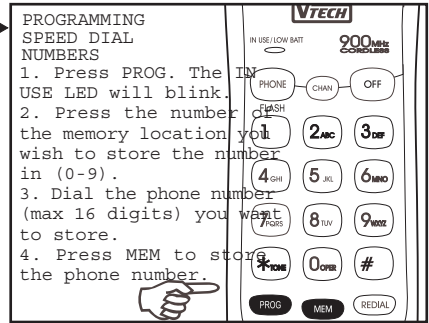

Speed Number Dialing

For example, to dial the number you assigned to key '8', you would press **PHONE, MEM, 8**.

To Change or Replace a Speed Dial Number

To change or replace a stored number in speed dial simply enter the new number and store it in the memory location you wish to change.

For example, to change the number stored in memory position 7 to 555-1111, you would press **PROG, 7, 555-1111, MEM**.

To Clear the Stored Number - - - - -

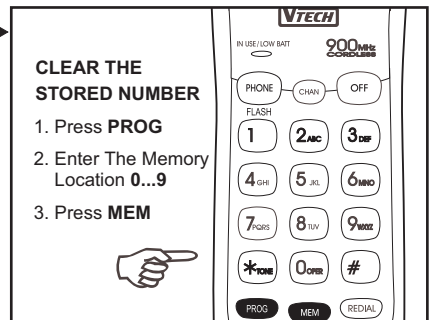

OPERATING INSTRUCTIONS

Storing Special Codes -----

To insert a pause in a phone number, for example, to store **9-PAUSE-555-1234** in memory location **8**, do the following:

STORING PAUSE

1. Press **PROG**
2. Press **8**
3. Press **REDIAL / PAUSE** one time
4. Dial **555-1234**
5. Press **MEM**







TO REDIAL LAST NUMBER

1. Press **PHONE**
2. Press **REDIAL**



Using Redial



Storing a Redial Number into Speed Dial

TO STORE REDIAL NO. INTO MEMORY

1. Press **PROG**
2. Press A Number Key **0...9**
3. Press **REDIAL**
4. Press **MEM**

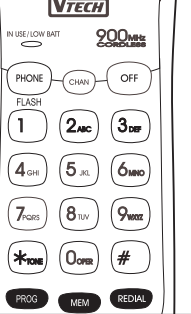





TO PAGE THE HANDSET FROM THE BASE

Press **PAGE**

TO END A PAGE AT THE HANDSET

Press **OFF**

The Page Feature

- This feature is useful if you have misplaced the handset.
- Press it a second time to cancel a page.
- The base will ring the handset for 60 seconds (STANDBY mode) or one page tone (PHONE mode) before ending the page automatically.

ITAD BASE LEDS

MAILBOX LED's

The MAILBOX LED's (1,2,3) indicate the status of messages in each mailbox.

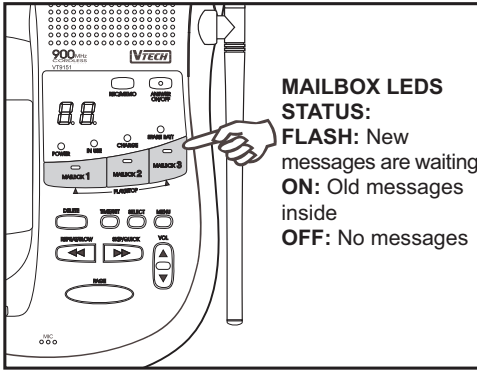

ANSWER ON/OFF LED

ANSWER LED will remain off if ITAD is not in auto-answer mode.

ANSWER LED remains on steadily when ITAD is in auto-answer mode.

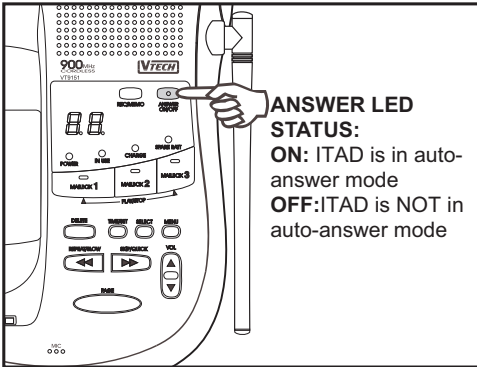

ITAD BASE KEYPAD FUNCTIONS

ITAD BASE KEYPAD

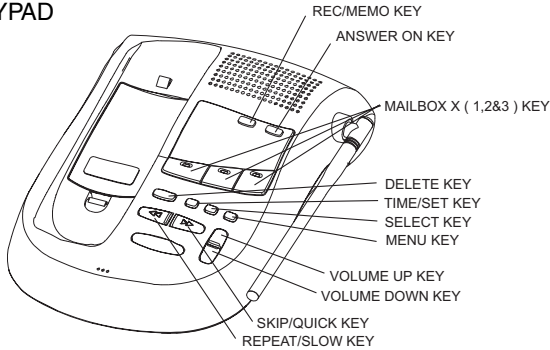

ANSWER ON/OFF KEY-----

This key is used to turn ON and OFF the ITAD.

- While in the OFF mode.
- 1. The cordless phone will still operate normally, but the ITAD will not answer calls.
- 2. The ITAD can be reactivated remotely by 10 successive rings on an incoming call.
- When the ITAD is ON, the ANSWER LED is on.

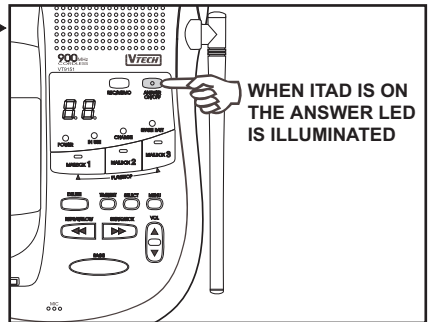

MAILBOX X (1,2 or 3) KEY-----

- The ITAD stores the messages into different mailboxes for retrieval by the corresponding mailbox user. For example, Mailbox 1 is for John, Mailbox 2 is for Jane, etc.
- Press **MAILBOX X** key to playback the incoming message in corresponding mailbox. Press the **MAILBOX X** key again will terminate the playback.
- When in menu mode, press any of the mailbox keys to return to idle mode.

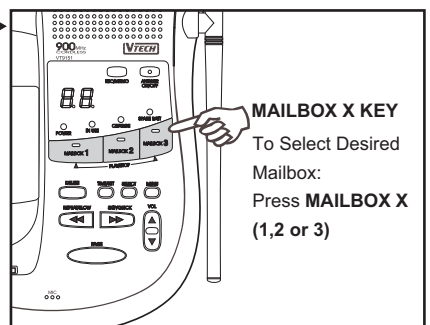

REC / MEMO KEY

The **REC/MEMO** key is used to record memos at the base unit in to the current selection. The maximum record time per memo/message is 4 minutes.

ITAD BASE KEYPAD FUNCTIONS

1. Press the **REC/MEMO** and you will hear "Please select mailbox".
 2. Select the mailbox by pressing the mailbox key and "Now recording" is heard.
 3. Record your memo.
 4. During recording, the 7 segment will count the recording time in seconds. When it exceeds **99** seconds, it will flash "**99**".
 5. Stop recording by pressing **MAILBOX X** key.
- The system will also stop recording automatically if time is expired or memory is full.
 - Maximum number of old & new messages/memos is 99. If total number of old and new messages is 99, "Memory full" will be announced when you press **REC/MEMO**.

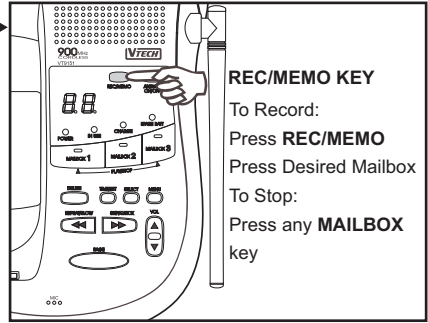

REC/MEMO KEY
 To Record:
 Press **REC/MEMO**
 Press Desired Mailbox
 To Stop:
 Press any **MAILBOX** key

MENU KEY -----

- The **MENU** key is used to program the answering machine. Each time you press **MENU**, the ITAD settings will be announced in the following order:
 - Set Outgoing Message
 - Set Security Code
 - Set Day and Time
 - Set Audible Message Alert
 - Set Announce only
 - Set Base Ringer
 - Set Number of Rings

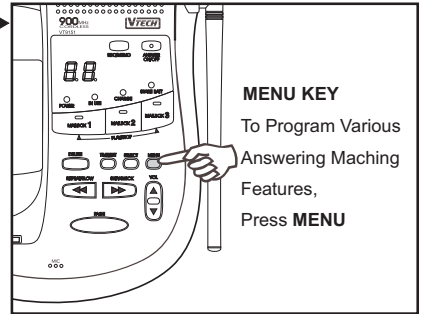

MENU KEY
 To Program Various
 Answering Maching
 Features,
 Press **MENU**

- Program the desired setting when you hear the appropriate voice option. (See **ITAD OPERATION**; page 22-28)

SELECT KEY -----

1. After you enter Program Mode, press **SELECT** until you hear your desired setting.
2. Pressing **TIME/SET** will confirm the current setting.

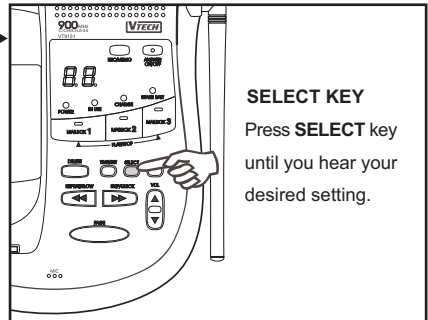

SELECT KEY
 Press **SELECT** key
 until you hear your
 desired setting.

ITAD BASE KEYPAD FUNCTIONS

TIME/SET KEY -----

The **TIME/SET** key is used to check the date and time. In normal operation, the day and time are announced when **TIME/SET** key is pressed.

- The **TIME/SET** key is used to set the current selection in program mode. It is used with the **MENU** and **SELECT** keys. (See **ITAD OPERATION**; page 22-28)

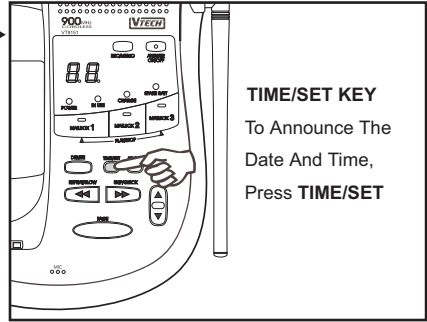

TIME/SET KEY
To Announce The
Date And Time,
Press **TIME/SET**

DELETE KEY -----

- The **DELETE** key is used to delete old messages (previously reviewed) from the ITAD.

1. Press **DELETE** during message playback to delete the current message.
 2. Press and hold **DELETE** key for more than 2 seconds, the system will announce, "please select mailbox". After pressing **MAILBOX X** key, all old (previously reviewed) messages in that selected mailbox will be deleted (this feature works only when the answering machine is idle; it does not work during message playback).
- To prevent accidental deletion of new messages, you are unable to delete a message unless it has been previously reviewed.

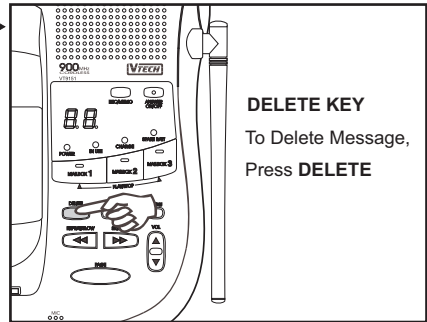

DELETE KEY
To Delete Message,
Press **DELETE**

REPEAT / SLOW KEY -----

- The **REPEAT/SLOW** key is used to return to the beginning of a message during message playback.
- The previous message will also begin if **REPEAT/SLOW** is pressed twice quickly during message playback.

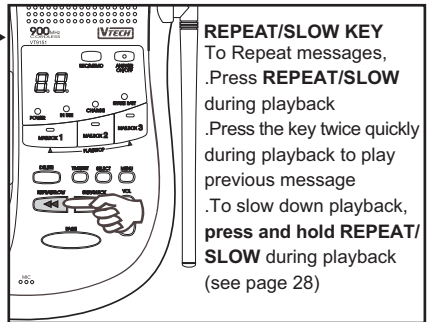

REPEAT/SLOW KEY
To Repeat messages,
.Press **REPEAT/SLOW**
during playback
.Press the key twice quickly
during playback to play
previous message
.To slow down playback,
**press and hold REPEAT/
SLOW** during playback
(see page 28)

ITAD BASE KEYPAD FUNCTIONS

SKIP/QUICK KEY - - - - -

- The ►► key advances the beginning of the next message during playback.

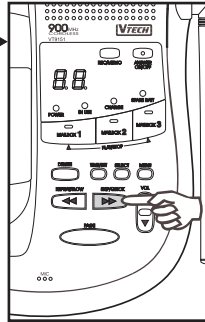

SKIP/QUICK KEY
To Advance To The Beginning Of The Next Message, press **SKIP/QUICK**. To speed up playback, **press and hold SKIP/QUICK** during playback (see page 28)

VOLUME UP KEY - - - - -

- The ▲ key is used to increase the volume level of the base unit speaker.

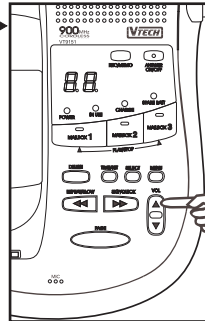

VOLUME UP KEY
To Increase The Volume Level Of Base Unit Speaker, Press ▲

VOLUME DOWN KEY - - - - -

- The ▼ key is used to decrease the volume level of the base unit speaker.

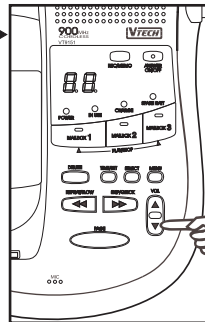

VOLUME DOWN KEY
To Decrease The Volume Level Of Base Unit Speaker, Press ▼

ITAD OPERATION

Default ITAD Settings

The ITAD is preset to have the following default settings:

Security Code: **19**

Audible Message Alert: **OFF**

Date & Time: **Mon 12:00am**

Rings to answer: **4**

ITAD Programming Overview

Setup order for the ITAD is:

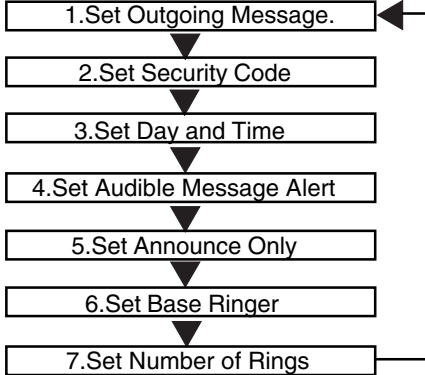

During ITAD setup, the 7 segment “--” LED will flash. If no key is pressed for 20 seconds, the ITAD will beep and exit program mode. You can also exit program mode at any time by pressing any **MAILBOX** key.

Selecting Announcement

There are 2 choices of announcements: Normal outgoing message & Outgoing message for announce only. To record the proper announcement, you should enter to the corresponding answering mode.

1. Normal answering mode.

In this mode, the caller is able to leave his message. If no announcement is recorded, the default announcement “Hello, I’m unable to answer your call right now. Please leave your name, number and message after the tone.” will be used. (see **Recording the OGM**).

2. Announce Only mode

If this mode is set, the caller is not able to leave his message. If no announcement is recorded, the factory default greeting is: “Hello, I’m unable to answer your call right now. Please call again. Thank you.” will be used. (see **Recording the OGM**)

Example for OGM1 (for multi - user application):

“Hi! We can’t come to the phone right now. If you have a message for John press *1 (Star, 1), for Jane press *2 (Star, 2), for Jack press *3 (Star, 3). If you have a message for any one of us, just stay on the line and record after the beep. Thank you.”

Example for OGM2 (announce only):

“Hi! You have reached Jack and Jill. We will be back after 1 p.m. Please call back then. Thank you.”

Recording/Playing/Deleting the Outgoing Messages (OGM)

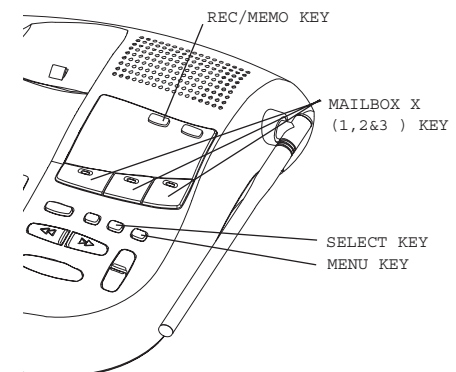

1. Press **MENU** key until the desired item (Set Outgoing Message) is announced.
2. Press **REC/MEMO**. “Now recording”, is announced, followed by a beep. Speak in the direction of the ITAD (max. length: 90 seconds).
3. Press **MAILBOX X** to stop the recording.

ITAD OPERATION

4. The OGM replays the message automatically, followed by a beep.
5. To review a recorded announcement, press **MENU** key until the desired item (Set outgoing message) is announced. Press any **MAILBOX** key. The current greeting is played.
6. To delete a recorded announcement, press **DELETE** during OGM playback.

Note: If your recording time is less than 2 seconds, your OGM will not be recorded, and the default greeting will be used.

Set Security Code

The security code programmed into the ITAD is used to gain access to functions from remote locations.

The security code default setting is **19**.

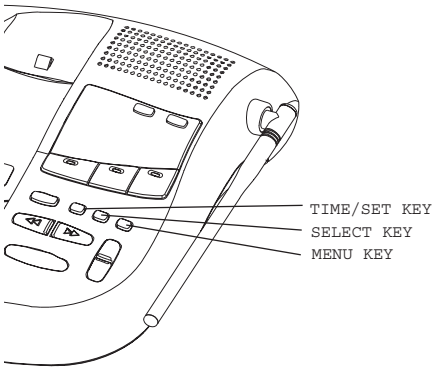

1. Press **MENU** until you hear "Set security code."
2. Press **TIME/SET** to hear the current security code.
3. Press **SELECT** briefly to increase the security code by 1. Or, hold **SELECT** continuously to increase the code by multiples of 10.
4. Press **TIME/SET** to confirm your choice and you will hear the announcement of the security code.

Day and Time Setup

During initial setup, or after a power failure, the day and time default is set to **Monday 12:00am**. The display will flash "CL" to indicate day and time need to be set.

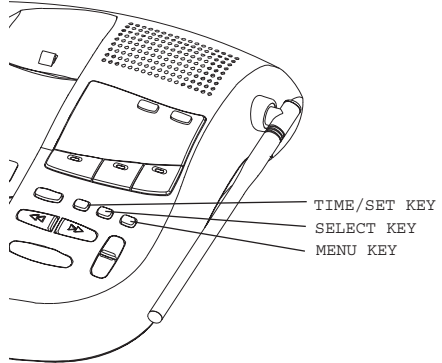

1. Press **MENU** until you hear, "Set day and time."
2. Press **SELECT** until the desired day is announced.
3. Press **TIME/SET** to confirm your choice.
4. Press **SELECT** until the desired hour is announced.
5. Press **TIME/SET** to confirm your choice.
6. Press **SELECT** until the desired minute is announced. Holding the key continuously will increase the minute in 10 minute steps.
7. Press **TIME/SET** to confirm your choice. You will hear the Day and Time.

Set Audible Message Alert

If you want your ITAD to beep once every 10 seconds to notify you when new messages have been received, set the Audible Message Alert to ON. Otherwise, it is preset to OFF.

ITAD OPERATION

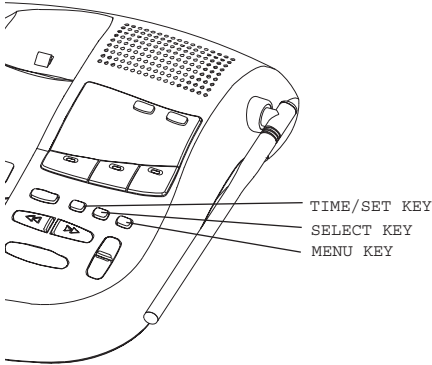

1. Press **MENU** until you hear “Set audible message alert.”
2. Press **SELECT** until the desired setting, (ON or OFF) is announced.
3. Press **TIME/SET** to confirm your choice. The voice prompt of “Audible Message Alert On” or “Audible Message Alert Off” will be produced.

Note: You can press any ITAD function key except PAGE key to stop the audible message alert.

Set Announce Only

Caution: If you turn on the Announce Only option, your callers cannot leave a message. This setting is preset at the factory to **Announce Only OFF**.

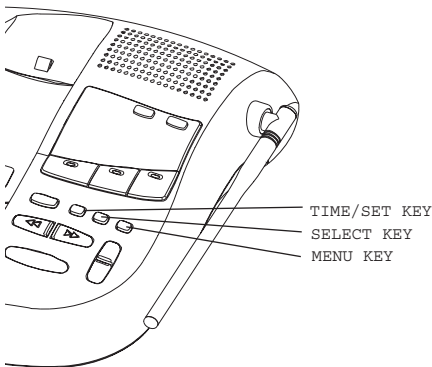

1. Press **MENU** until “Set Announce Only” is announced.
2. Press **TIME/SET** now will announce the current setting.
3. Press **SELECT** until desired setting-“on” or “off” is declared.
4. Press **TIME/SET** to confirm and the setting will be announced.

Note: You can store one Outgoing Message (OGM) for ANNOUNCE ONLY mode, and a separate OGM for NORMAL (accept messages) mode. Depending on the Announce Only Setting, the appropriate OGM will be selected.

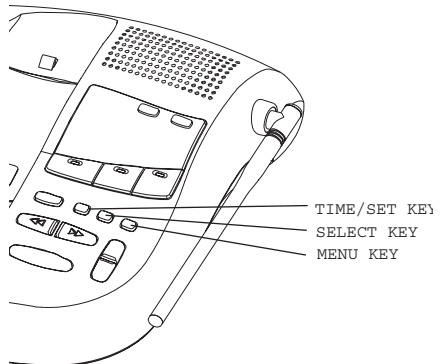

Set Base Ringer On/Off

The Base ringer can be turned on or off.

1. Press **MENU** until you hear “Set Base Ringer”
2. Press **SELECT** to toggle between the choices (on or off)
3. Press **TIME/SET** to confirm your selection. Voice prompt of “Base Ringer is on” or “Base Ringer is off” will be announced to confirm your setting.

Set Number of Rings

The ITAD has 4 ring number settings: 2 rings The incoming call is answered after 2 rings.

ITAD OPERATION

- 4 rings** The incoming call is answered after 4 rings.
- 6 rings** The incoming call is answered after 6 rings.
- Toll Saver** The incoming call is answered after 2 rings only if there are new messages/memos present. Otherwise, the ITAD will answer calls after 4 rings. Thus, if Toll Saver is active and your ITAD rings 3 times when you call, you can hang-up to avoid any long distance charges.

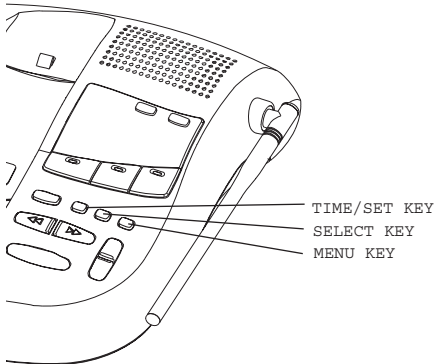

1. Press **MENU** until you hear “Set number of rings.”
2. Press **SELECT** until you hear the desired ring number, “2”, “4”, “6”, or “Toll Saver” announced.
3. Press **TIME/SET** to confirm your choice. The selected setting is then announced.

Leaving a Message (Incoming Message)

The ITAD will answer a call (according to the current ring selection), play the OGM followed by a beep to signal the start of recording.

- Default mailbox is **MAILBOX 1**.
- To record the incoming message in a specific mailbox, the caller should

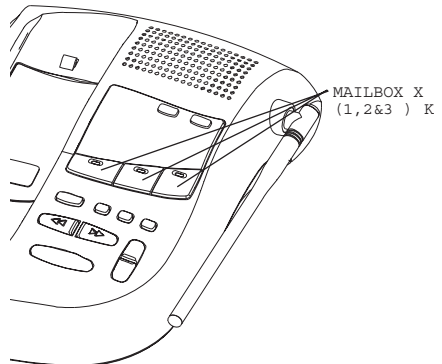

press “*, X(star X)” during OGM playback. X being **Mailbox 1, 2 or 3**.

- After desired mailbox is selected, “Mailbox X, now recording” will be announced, and incoming message recording starts after a beep.
- If incoming message length is less than 2 seconds, message will not be recorded.

Listening to Messages / Memos

When new messages and/or new memos are in the ITAD, the display will flash the total number of new messages in all mailboxes.

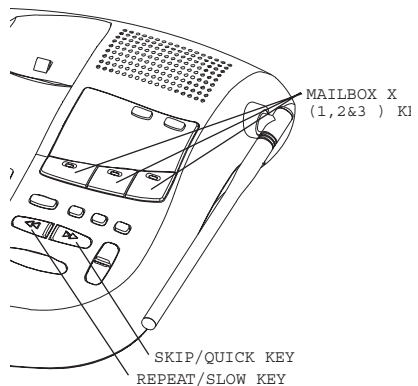

- Press the desired Mailbox key to hear messages.
- The system will announce “Mailbox X, you have X new message(s) and X old message(s)” in the presence of new message in corresponding

ITAD OPERATION

mailbox. Then the system will play only the new messages.

- In the absence of new messages, the system will announce “Mailbox X, You have X old messages” and then playback the old messages.
- The ◀◀ and ▶▶ keys can be used to skip forward and backward during message playback.
- To stop message playback, and return to normal operation mode, press **MAILBOX X** and a long beep is followed.
- The day and time stamp is announced after each message is played.
- After all messages and memos have been played, the final voice prompt will be, “End of messages”, and the ITAD will exit playback mode.
- Note that the system will play the message based on “First-In-First-Out”
- If the system has less than 5 minutes recording time left, it will announce the remaining recording time to alert the user.
- During message playback, the display will be flashing to indicate that the currently playing message is a new message.

Saving Messages

- The ITAD will automatically save your messages if you do not delete them. The messages will be retained even after power failure.
- The system can record up to 15 minutes of messages.

Deleting Messages

- Press **DELETE** key at any time during message playback to delete the current message.
- All reviewed messages for a particular mailbox, can be deleted by pressing and holding the **DELETE** key for more than 2 seconds. The system will announce “Please select mailbox”.

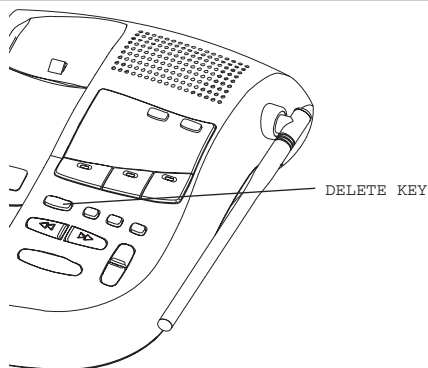

- Press the “Mailbox X” key that you want to delete all the reviewed messages in the selected mailbox.

Note: The DELETE function will only delete old or reviewed messages. New messages CANNOT be deleted until they are reviewed.

Turning the ITAD ON/OFF

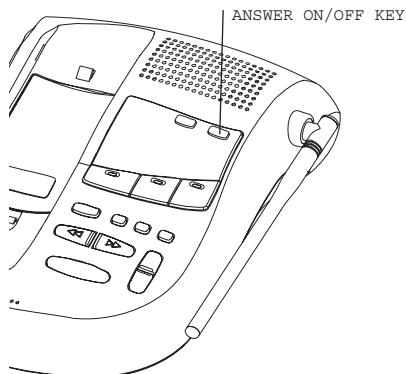

- If you want the ITAD to answer calls, press **ANSWER ON/OFF** key. The ON LED will then be turned on and “Answering machine on” will be announced.
- If you don’t want the ITAD to answer calls, press **ANSWER ON/OFF** key. The ON LED will then be turned off and “Answering machine off” will be announced.

ITAD OPERATION

- The display will still show the number of new messages.
- Even if the ITAD is set to OFF, it will still answer calls after 10 rings. An announcement, "Please enter your security code" is given, and you can enter your security code to use remote operation. (See **Remote Operation of ITAD**)

Call Screening

Call screening level can be changed at any time, even while the ITAD is answering a call.

When the ITAD answers a call, the speaker will monitor the voice on the line. If you want to answer the call at once, just pick-up the handset, or an extension, and the ITAD will automatically stop recording.

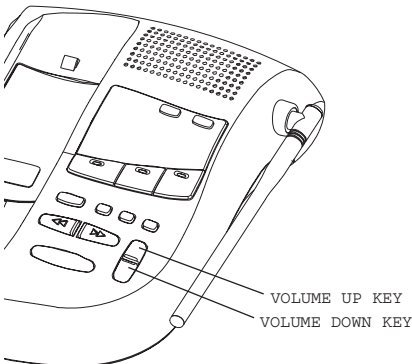

The Call Screening volume is controlled by the ▲ and ▼ keys.

- Call screening is off when volume level "1" is indicated in the display.
- Call-screening level can be changed any time even during ITAD is answering a call.
- Default volume level is 5.

Audible Current Day and Time

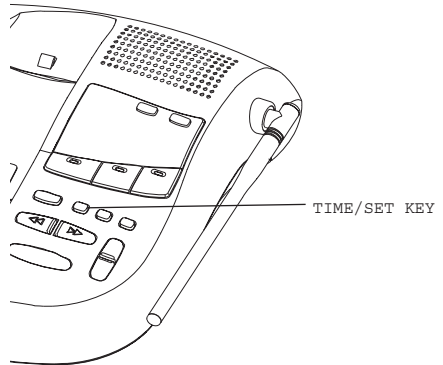

You can check the current day and time by pressing **TIME/SET**. After the announcement the ITAD will generate a beep.

Changing Speaker Volume

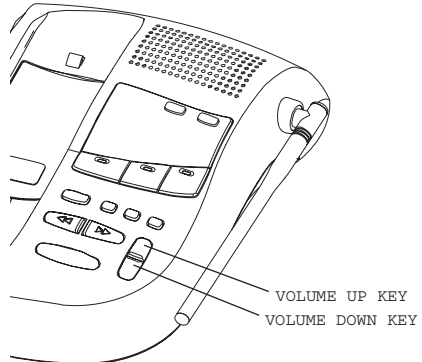

- Press the ▲ and ▼ keys to reach the desired volume level. There are 8 digital volume levels.
- If volume is set at maximum or minimum level, further pressing of the volume keys will give 3 short beep tones.
- Volume change automatically continues if the volume UP/DOWN is held.

ITAD OPERATION

Changing Playback Speed

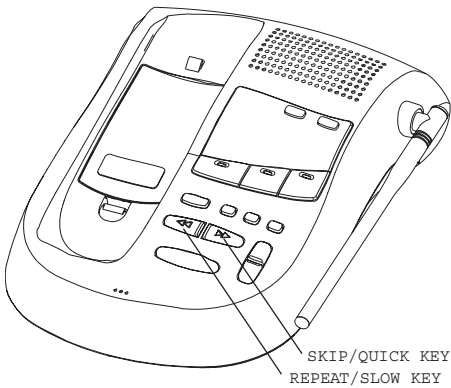

During playback, you can change the playback speed by simply holding down ◀◀ (SLOW) or ▶▶ (QUICK) to the desired speed during playback.

There are 3 playback speeds. The default speed is normal. Playback speed will return to normal once you exit the playback mode.

Auto Disconnect for Extension Phone Pick-up

The ITAD will auto-disconnect the telephone line if an extension phone or the cordless handset accesses the line.

Note: If the ITAD continues to record after an extension phone or the cordless handset accesses the line, either press **MAILBOX X** on the base or press “*, 0” on the extension phone or cordless handset.

Memory Full

- When the ITAD has less than 30 seconds recording time remaining or the total message count is equal to 99, the display shows “F” with the number of new messages to indicate memory full.
- If the ITAD memory is full, it will automatically default to ANSWER OFF mode. The ITAD will answer a call after 10 rings and “Memory full;

Please enter your security code” is announced. You may enter remote operation mode by entering the security code.

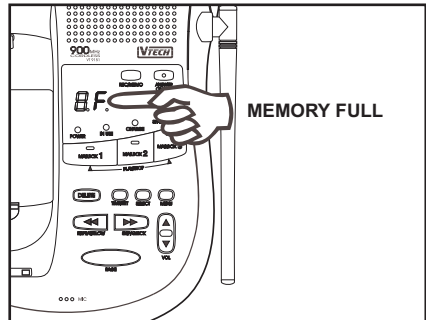

- If memory is full, any attempt to record memos or OGM's will be inhibited.

Power Failure

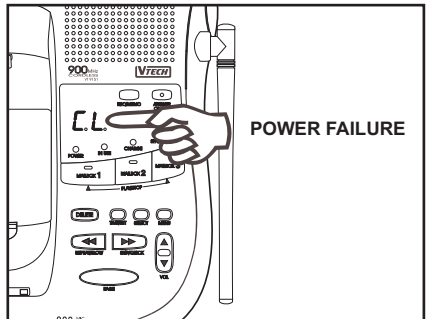

- After a power failure, “CL” will flash to notify you to set the day and time.
- All the messages, OGM's and menu settings (other than day and time) will be retained.
- The ITAD will default to ANSWER ON and Call Screening ON.
- Note that after power up, the ITAD will have an initialization period, during which, the display will flash with “-”. During this period, you can still use the cordless phone.

REMOTE OPERATION OF ITAD

Remote operation allows you to control the functions of the ITAD when you are away from the base, and call from an outside telephone line. The ITAD cannot be accessed from another telephone on the same line. You can access many of the ITAD functions from a remote location such as listening to messages, changing recorded announcements, and recording memos.

Remote operation can only be accessed from a touch tone telephone. If the remote phone is set to pulse dialing, switch it tone. If tone dialing is not available you will not be able to access the ITAD.

Note: All function codes should be entered within 2 seconds in order to activate the Remote Operation.

To Activate Remote Operation From a Different Telephone Line

1. If the ITAD is off, you can dial your telephone number and wait for the ITAD to answer your call after 10 rings. An announcement, *"Please enter your security code"* is given, and you enter your security code to use remote operation.
2. If the ITAD is on, it will answer your call and begin playing the currently selected announcement (as with any incoming call).
3. Enter # followed by your 2 digit security code during the announcement. **The default security code is 19.**
4. Once the security code is received, a double confirmation beep will be given, and you are in Remote Operation mode. You can then control the ITAD functions using the telephone keypad.

5. The user can also enter the Remote Operation mode during message recording. The procedure is the same as step 3. The recording will be stopped after entering #, then the valid security code (2 digits, selected from 00 - 99). The recorded incomplete message will be deleted.
6. If the user enters a wrong security code, the system will release the line.

Playing Messages Remotely

1. Press "#1", "#2" or "#3" on the touch tone keypad to play the messages in the corresponding mailbox.
2. The system will announce *"Mailbox X. You have XX new messages and XX old messages"* and the system will playback the new message only. If there are no new messages, the system will announce *"Mailbox X. You have XX old messages"* and then play back the old messages. On the other hand, in the absence of old messages, the system will announce only the number of new messages.

Repeat Messages During Playback

1. Press "#4" once during message playback to repeat the current message.
2. Press "#4" twice within 2 seconds to skip to the previous message.

Skip Messages During Playback

1. Press "#6" once to skip forward to the next message.

Stop Message Playback

1. Pressing "#5" during message playback will stop playback.

REMOTE OPERATION OF ITAD

Deleting Messages

1. Press “#9” once during message playback to delete the current message.

Note: Playback will pause if “#” or “*” is entered. ITAD will wait for the command in the following 2 seconds. If no further tone is entered, playback will be resumed.

Memo Recording

1. Press “*8”.
2. After selecting the mailbox by entering command “1”, “2”, “3”, You will hear, “Now recording”, followed by a beep.
3. Enter “#5” to stop recording when you have finished.

Change OGM Remotely

1. Enter “*7” to record a new OGM. You will hear, “Now recording”, followed by a beep to signal start of recording.
2. Press “#5” to stop recording. Your new OGM will playback automatically.

Check OGM Remotely

Enter “#7” to review OGM. You will hear playback of OGM followed by a beep.

Turning ITAD ON or OFF

Pressing “#0” toggles the ITAD ON/OFF. “Answer machine on”, or “Answer machine off” will be announced, followed by a beep.

Voice Menu for Remote Operation

The system provides two pre-recorded voice menus to help you during remote operation. Press “*5” to go back to the simple voice menu.

The simple voice menu is as follows:

- Press “#1” to play mailbox 1.
- Press “#2” to play mailbox 2.
- Press “#3” to play mailbox 3.
- Press “#5” to stop.
- Press “#4” to repeat the message.
- Press “#6” to skip the message.
- Press “#9” to erase the message.
- Press “*5” for other functions.

The advanced voice menu is as follows:

- Press “#7” to review outgoing message.
- Press “*7” to record outgoing message.
- Press “*8” to record memo.
- Press “#4” twice to repeat previous message.
- Press “#0” to turn the system on or off.
- Press “*5” to go back to the simple voice menu.

Pressing any function code will stop the voice menu, and perform the corresponding functions.

Exiting Remote Operation

1. Enter “*0” to exit remote operation mode. The ITAD confirms your action with a long beep and then disconnects.
2. The ITAD also automatically disconnects if no key is pressed within 20 seconds during remote operation.

OPTIONAL HEADSET INSTALLATION AND OPERATING INSTRUCTIONS

Your **VTECH VT 9151/VT 9155** cordless telephone is equipped with a 2.5mm Headset Jack for use with an optional accessory Headset for hands-free operation.

If you choose to use the Headset option, you must do the following:

INSTALLATION

- Obtain an optional accessory Headset, which is compatible with the **VTECH VT 9151/VT 9155**.

Please contact **VTech Communications Customer Service**, toll-free at **1-800-595-9511 in US** and **VTech Electronics at 1-800-267-7377 in Canada** for dealer information in your local area. You can also purchase a compatible Headset directly from VTech Communications Customer Service.

- Once you have a compatible 2.5mm Headset, locate the Headset Jack on the Handset of your **VTECH VT 9151/VT 9155**. Connect the plug on the Headset to the jack on the cordless Handset. The plug should fit securely. Do not force the connection. See illustration.

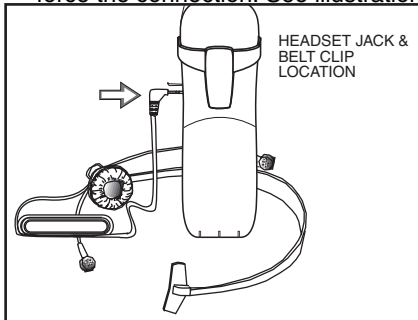

- The **VTECH VT 9151/VT 9155** is also equipped with a detachable belt clip. Align the pins on the inside edge of the belt clip with the notches on the side of the **VTECH VT 9151/VT 9155** handset. The belt clip should snap securely into place. Do not force the connection. See illustration.

OPERATION

NOTE: Whenever a compatible Headset is connected to the cordless Handset, the

microphone on the Handset will be **MUTED**. This is done to limit the effect of background noise.

- The following operational characteristics apply to VTech Headsets. The same may also apply to other (non-VTech) compatible headsets, but VTech assumes no responsibility for their performance.
- The VTech brand compatible Headset has a monaural design which is reversible, so you can wear your Headset on either the left or right ear, leaving one ear free for room conversation.

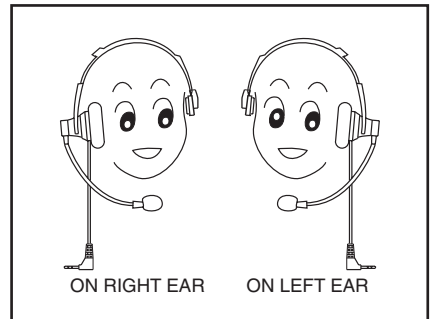

- The head band can be adjusted to fit the contour of your head. Using both hands, slide the head band up or down so that it rests comfortably on your head with the speaker cushion centered against your ear.
- For maximum sound quality, the flexible microphone should be positioned at the corner of your mouth, about one inch from your mouth.

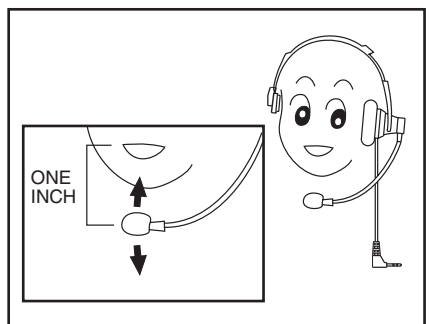

MAINTENANCE

TAKING CARE OF YOUR TELEPHONE.

Your **VTECH VT 9151/VT 9155** cordless telephone contains sophisticated electronic parts so it must be treated with care.

Avoid rough treatment

Place the handset down gently. Save the original packing materials to protect your telephone if you ever need to ship it.

Avoid water

Your telephone can be damaged if it gets wet. Do not use the handset outdoors in the rain, or handle it with wet hands. Do not install your base unit near a sink, bathtub or shower.

Remember that electrical appliances can cause serious injury if used when you are wet or standing in water. If your base unit should fall into water, **DO NOT RETRIEVE IT UNTIL YOU UNPLUG THE POWER CORD AND TELEPHONE LINE CORDS FROM THE WALL.** Then pull the unit out by the unplugged cords.

Electrical storms

Electrical storms can sometimes cause power surges harmful to electronic equipment.

For your own safety, use caution when using electric appliances during storms.

Cleaning your telephone

Your telephone has a durable plastic casing that should retain its luster for many years. Clean it only with a soft cloth slightly dampened with water or a mild soap. Do not use excess water or cleaning solvents of any kind.

IN CASE OF DIFFICULTY

If you have difficulty operating your phone, the suggestions below should solve the problem. If you still have difficulty after trying these suggestions,

In the US call:

**VTECH Communications at
1-800-595-9511.**

In Canada call:

**VTECH Electronics at
1-800-267-7377.**

THE PHONE DOESN'T WORK AT ALL.

- Make sure the power cord is plugged in.
- Make sure the telephone line cord is plugged firmly into the base unit and the telephone wall jack.
- Make sure the batteries are properly charged. If the Low Battery indicator is on, the battery needs charging. If the IN USE indicators do not light when you press **PHONE**, you must charge the batteries.
- If you recently installed a new battery pack, make sure it is installed correctly.

NO DIAL TONE.

- First check all the suggestions above.
- If you still don't hear a dial tone, disconnect the base unit from the telephone jack and connect a different phone. If there is no dial tone on that phone either, the problem is in your wiring or local service. Call your local telephone company.

YOU GET NOISE, STATIC, OR A WEAK SIGNAL EVEN WHEN YOU'RE NEAR THE BASE UNIT.

- Household appliances plugged into the same circuit as the base unit can sometimes cause interference. Try moving the appliance or the base unit to another outlet.

YOU GET NOISE, STATIC, OR A WEAK SIGNAL WHEN YOU'RE AWAY FROM THE BASE UNIT.

- You may be out of range. Either move close to the base, or relocate the base unit.
- The layout of your home may be limiting the range. Try moving the base unit to the second or third floor, or to some other location.

THE HANDSET DOES NOT RING WHEN YOU RECEIVE A CALL.

- Ensure that the ringer is turned on.
- Make sure the telephone line cord is plugged firmly into the base unit and the telephone jack. Make sure the power cord is plugged in.
- You may be too far from the base unit.
- You may have too many extension phones on your telephone line to allow all of them to ring. Try unplugging some of the other phones.

YOUR CALLER FADES IN AND OUT.

- You may be nearly out of range. Move closer, or relocate the base.

YOU HEAR OTHER CALLS WHILE USING YOUR PHONE.

- Replace the handset in the base cradle, wait a few moments and try again.
- Disconnect your base unit from the telephone jack, and plug in a regular telephone. If you still hear other calls, the problem is probably in your wiring or local service. Call your local telephone company.

YOU HEAR NOISE IN THE HANDSET, AND NONE OF THE KEYS OR BUTTONS WORK.

- Make sure the power cord is plugged in.
- Your base unit and handset may not be operating on the same channel. Place the handset in the cradle for a few moments to reset the channel.

COMMON CURE FOR ELECTRONIC EQUIPMENT

Electronics, like people, can sometimes get confused. If the unit does not seem to be responding normally, then try putting the handset in the cradle to re-initialize the unit. If it still does not seem to respond, perform the following steps (in the order listed):

1. Disconnect the power to the base.
2. Disconnect (remove) the handset battery pack.
3. Remove the base unit battery pack, where applicable.
4. Wait a few minutes.
5. Connect power to the base.
6. Install the handset battery pack.
7. Install the base unit battery pack, where applicable.
8. Place the handset in the base unit cradle. If the handset has not been recently charged, allow 8 hours before use.

WARRANTY STATEMENT

WHAT DOES OUR WARRANTY COVER?

- Any defect in material or workmanship.

FOR HOW LONG AFTER THE ORIGINAL PURCHASE?

- One Year.

WHAT WILL VTECH DO?

- At our option, repair or replace your unit.

HOW DO I SEND MY UNIT, IN OR OUT OF WARRANTY?

- Call VTECH Communications customer service for Return Authorization at: **1-800-595-9511**, in Canada call VTech Electronics at **1-800-267-7377**.
- Properly pack your unit. Include any cables & accessories which were originally provided with the product. We recommend using the original carton and packing materials.
- Include in the package a copy of the sales receipt or other evidence of date of original purchase (if the unit was purchased within the last twelve months).
- Print your name and address, along with a description of the defect, and include this in the package.
- Include payment for any service or repair not covered by warranty, as determined by VTECH Communications.
- In the US, ship the unit via UPS Insured, or equivalent to:

**VTECH COMMUNICATIONS
11035 SW 11TH STREET
BLDG. B SUITE 270
BEAVERTON, OR 97005**

In Canada ship the unit via UPS Insured, or equivalent to:

**VTECH ELECTRONICS
Suite 200-7671 Alderbridge Way
Richmond, B.C. V6X 1Z9**

VTECH Communications assumes no responsibility for units sent without prior Return Authorization.

WHAT DOES OUR WARRANTY NOT COVER?

- Batteries
- Damage from misuse, neglect, or acts of nature (lightning, floods, power surges, etc.)
- Products which may have been modified or incorporated into other products
- Products purchased outside the USA or CANADA
- Products serviced by the owner or a service facility not expressly authorized by VTECH Communications
- Products purchased more than 12 months from current date

HOW DOES STATE LAW OR PROVINCIAL LAW RELATE TO THIS WARRANTY?

- This warranty gives you specific rights. You may also have other rights which vary from state to state or province to province.

FCC AND IC REGULATIONS

This equipment complies with Parts 15 and 68 of the Federal Communications Commission (FCC) rules for the United States. It also complies with regulations RSS 210 & CS-03 of industry canada (IC) for Canada.

A label is located on the underside of the base unit containing either the FCC registration number and Ringer Equivalence Number (REN) or the IC registration number and Load Number. You must, upon request, provide this information to your local telephone company.

This equipment is compatible with inductively coupled hearing aids.

Should you experience trouble with this telephone equipment, please contact:

In the United States:
VTECH COMMUNICATIONS
1-800-595-9511
In Canada Call:
VTECH Electronics at
1-800-267-7377.

for repair/warranty information. The telephone company may ask you to disconnect this equipment from the line network until the problem has been corrected.

Your **VT 9151/VT 9155** is designed to operate at the maximum power allowed by the FCC and IC. This means your handset and base unit can communicate only over a certain distance - which will depend on the location of the base unit and handset, weather, and the construction and layout of your home or office.

FCC Part 15

Warning: Changes or modifications to this unit not expressly approved by the party responsible for compliance's could void the user's authority to operate the equipment.

The equipment has been tested and found to comply with part 15 of the FCC

rules. These limits are designed to provide reasonable protection against harmful interference in a residential installation. This equipment generates, uses and can radiate radio frequency energy and, if not installed and used in accordance with the instructions, may cause harmful interference to radio communications. However, there is no guarantee that interference will not occur in a particular installation. If this equipment does cause harmful interference to radio or television reception, which can be determined by turning the equipment off and on, the user is encouraged to try and correct the interference by one or more of the following measures:

- Reorient or relocate the receiving antenna.
- Increase the separation between the equipment and receiver.
- Connect the equipment into an outlet or on a circuit different from that to which the receiver is connected.
- Consult the dealer or an experienced radio/TV technician for help.

FCC Part 68

The FCC requires that you connect your cordless telephone to the nationwide telephone network through a modular telephone jack (USOC RJ11C or RJ11W).

Your telephone company may discontinue your service if your equipment causes harm to the telephone network. They will notify you in advance of disconnection, if possible. During notification, you will be informed of your right to file a complaint with the FCC.

Occasionally, your telephone company may make changes in its facilities, equipment, operation, or procedures that could affect the operation of your equipment. If so, you will be given advance notice of the change to give you an opportunity to maintain uninterrupted service.

FCC AND IC REGULATIONS

The base unit contains no user serviceable parts. The handset contains a user replaceable battery pack.

If it is determined that your telephone equipment is malfunctioning, the FCC requires that it not be used and that it be unplugged from the modular jack until the problem has been corrected. Repairs to this telephone equipment can only be made by the manufacturer or its authorized agents or by others who may be authorized by the FCC. For repair procedures, follow the instructions outlined under the VTECH Limited Warranty.

This equipment may not be used on coin service provided by the phone company or Party Lines.

The REN is useful in determining the number of devices you may connect to your telephone line and still enable the devices to ring when you receive a call. The general rule is that the REN value should not exceed 5.0A total; however, contact your local telephone company for the specific number in your area.

IC (Industry Canada)

This telephone is registered for use in Canada.

Notice: The Industry Canada label identification certified equipment. This certification means that the equipment meets certain telecommunications network, protective, operational and safety requirement. Industry Canada does not guarantee the equipment will operate to the user's satisfaction.

Before installing this equipment, users should ensure that is permissible to be connected to the facilities of the local telecommunications company. The equipment must also be installed

using an acceptable method of connections. The customer should be aware that compliance with the above conditions may not prevent degradation of service in situations.

Repairs to certified equipment should be made by an authorized Canadian maintenance facility designated by the supplier. Any repairs or alterations made by the user to this equipment, of equipment, or equipment malfunctions, may give the telecommunications company cause to request the user to disconnect the equipment.

Users should ensure for their own protection that the electrical ground connections of the power utility, telephone lines and internal metallic water pipe system, if present, are connected together. This precaution may be particularly important in rural areas.

Caution: Users should not attempt to make such connections themselves, but should contact appropriate electric inspection authority, or electrician, as appropriate.

The Load Number (LN) assigned to this device denotes the percentage of the total load to be connected to a telephone loop which is used by the device to prevent overloading. The termination on a loop may consist of any combination of devices subject only to the requirement that the total of the load numbers of all devices does not exceed 100.

This device complies with RSS-210 of Industry Canada. Operation is subject to the following two conditions: (1) this device may not cause interference, and (2) this device must accept any interference, including interference that may cause undesired operation of the device.

TECHNICAL SPECIFICATIONS

FREQUENCY CONTROL

Crystal Controlled Dual PLL Synthesizer

TRANSMIT FREQUENCY

Handset: 923.10 MHz to 927.75 MHz (All 30 channels within this range)

Base: 902.3 MHz to 906.65 MHz (All 30 channels within this range)

RECEIVE FREQUENCY

Handset: 902.3 MHz to 906.65 MHz (All 30 channels within this range)

Base: 923.10 MHz to 927.75 MHz (All 30 channels within this range)

NOMINAL EFFECTIVE RANGE

Maximum power allowed by FCC and IC. Actual operating range may vary according to environmental conditions at the time of use.

SIZE

Handset: 17.5cm x 5.7cm x 4.5cm (L x W x T) maximum (antenna excluded)

Base: 22.0cm x 16.5cm x 6.2cm (L x W x T) maximum (antenna excluded)

WEIGHT

Handset: 150 grams

Base: 470 grams

POWER REQUIREMENTS

Handset: Self-contained nickel-cadmium rechargeable battery supply, 3.6V nominal, 400mAh capacity.

Power Adapter: 9V DC@300mA

**SPECIFICATIONS ARE TYPICAL AND
MAY CHANGE WITHOUT NOTICE**



VTECH COMMUNICATIONS LTD.

Distributed in the U.S.A. by VTECH Communications; Beaverton, OR , 97008

Distributed in Canada by VTECH Electronics Canada Ltd.; Richmond, B.C., V6X 1Z9

Copyright 2000 for VTECH COMMUNICATIONS LTD.

MADE IN CHINA

91-5055-30-00
ISSUE 0

USER'S MANUAL

VT 9151/VT 915

900MHz CORDLESS ANSWERING SYSTEM



VTECH COMMUNICATIONS LTD.

IMPORTANT

BEFORE USING YOUR NEW PHONE, WE STRONGLY RECOMMEND YOU READ THIS MANUAL THOROUGHLY.

Free Manuals Download Website

<http://myh66.com>

<http://usermanuals.us>

<http://www.somanuals.com>

<http://www.4manuals.cc>

<http://www.manual-lib.com>

<http://www.404manual.com>

<http://www.luxmanual.com>

<http://aubethermostatmanual.com>

Golf course search by state

<http://golfingnear.com>

Email search by domain

<http://emailbydomain.com>

Auto manuals search

<http://auto.somanuals.com>

TV manuals search

<http://tv.somanuals.com>