

Important Safety Instructions

When using your telephone equipment, basic safety precautions should always be followed to reduce the risk of fire, electric shock and injury, including the following:

1. Read and understand all instructions.
2. Follow all warnings and instructions marked on the product.
3. Unplug this product from the wall outlet before cleaning. Do not use liquid cleaners or aerosol cleaners. Use a damp cloth for cleaning.
4. Do not use this product near water (for example, near a bath tub, kitchen sink, or swimming pool).
5. Do not place this product on an unstable cart, stand, or table. The product may fall, causing serious damage to the product.
6. Slots and openings in the cabinet and the back or bottom are provided for ventilation. To protect it from overheating, these openings must not be blocked by placing the product on the bed, sofa, rug, or other similar surface. This product should never be placed near or over a radiator or heat register. This product should not be placed in a built-in installation where proper ventilation is not provided.
7. This product should be operated only from the type of power source indicated on the marking label. If you are not sure of the type of power supply to your home, consult your dealer or local power company.
8. Do not allow anything to rest on the power cord. Do not locate this product where the cord will be abused by persons walking on it.
9. Never push objects of any kind into this product through cabinet slots as they may touch dangerous voltage points or short out parts that could result in a risk of fire or electric shock. Never spill liquid of any kind on the product.
10. To reduce the risk of electric shock, do not disassemble this product. Opening or removing cabinet parts other than specified access doors may expose you to dangerous voltages or other risks. Incorrect reassembling can cause electric shock when the appliance is subsequently used.
11. Do not overload wall outlets and extension cords as this can result in the risk of fire or electric shock.

Important Safety Instructions

12. Unplug this product from the wall outlet and contact VTECH under the following conditions:
 - A. When the power supply cord or plug is damaged or frayed.
 - B. If liquid has been spilled into the product.
 - C. If the product has been exposed to rain or water.
 - D. If the product does not operate normally by following the operating instructions. Adjust only those controls that are covered by the operating instructions, because improper adjustment of other controls may result in damage and will often require extensive work to restore the product to normal operation.
 - E. If the product has been dropped and the cabinet has been damaged.
 - F. If the product exhibits a distinct change in performance.
13. Avoid using a telephone (other than a cordless type) during an electrical storm. There may be a remote risk of electric shock from lightning.
14. Do not use this or any cordless telephone to report a gas leak in the vicinity of the leak.

VTECH COMMUNICATIONS INC.

CUSTOMER SERVICE : 1-800-595-9511. In Canada, call VTech Electronics Ltd. at 1-800-267-7377.

BEFORE USING YOUR VT5831 SYSTEM, CAREFULLY PEEL OFF THE PROTECTIVE FILM, COVERING THE DISPLAYS.

SAVE THESE INSTRUCTIONS

The **VT5831** is an advanced cordless telephone that operates in the 5.8GHz frequency range. Your **VT5831** is capable of supporting up to a maximum of **6** Handsets. Using additional Handsets, up to three people can be conferenced on a call (2 Handsets and the Base Speakerphone), or two extensions can be conferenced on a call, while two other extensions can be talking internally, using the Intercom feature.

This manual is designed to familiarize you with the **VT5831** cordless telephone. We strongly recommend you read the manual before using your phone.

To order additional system Handsets (model# **VT 5820**), battery packs, or headsets, call VTech Communications Inc. at 1-800-595- 9511.



**If you have questions about this product, or if you're having difficulty with setup or operation, do not return your phone to the store. Call our Customer Support Center at
1-800-595-9511**

**In Canada, call
1-800-267-7377**

Parts Check List

1. Base Unit
2. Handset
3. Handset Charger
4. Base AC Power Adapter
5. Telephone Line Cord
6. Belt Clip
7. Base Wall Mounting Bracket
8. Charger Wall Mounting Bracket
9. Owner's Manual
10. Battery Pack

To purchase replacement battery packs, call VTech Communications Inc. at 1-800-595-9511. In Canada, call VTech Electronics Ltd. at 1-800-267-7377.

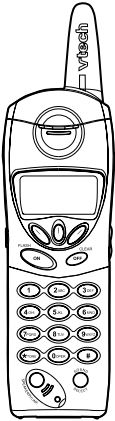

Handset

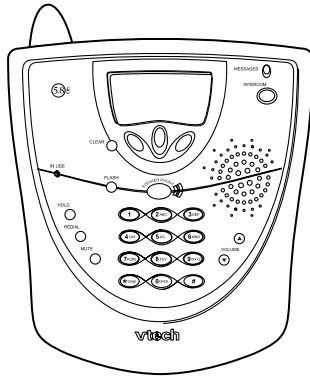

Base Unit

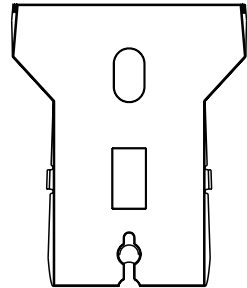

Base Wall Mounting Bracket

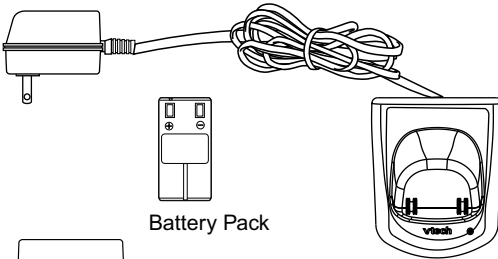

Battery Pack

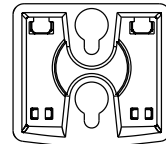

Charger Wall Mounting Bracket

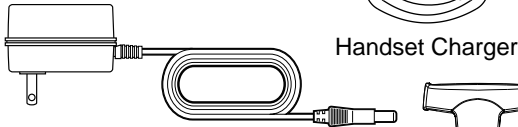

Handset Charger

Base AC Power Adapter

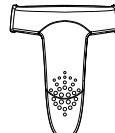

Belt Clip

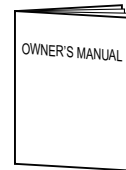

Owner's Manual



Telephone Line Cord

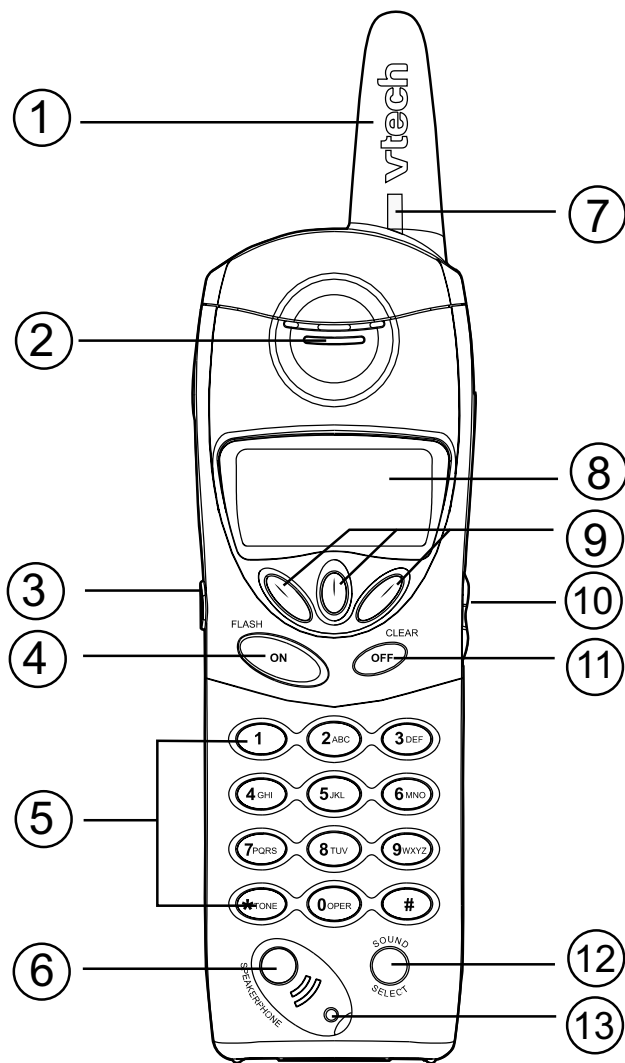

1. Antenna
2. Earpiece
3. Headset Jack (2.5mm)
4. On (Flash)
5. Dialing Keys (0-9, *, #)
6. Speakerphone
7. Message Waiting LED

8. LCD Display
9. Soft Keys
10. Volume
11. Off (Clear)
12. Sound Select
13. Microphone

The Base Unit Layout

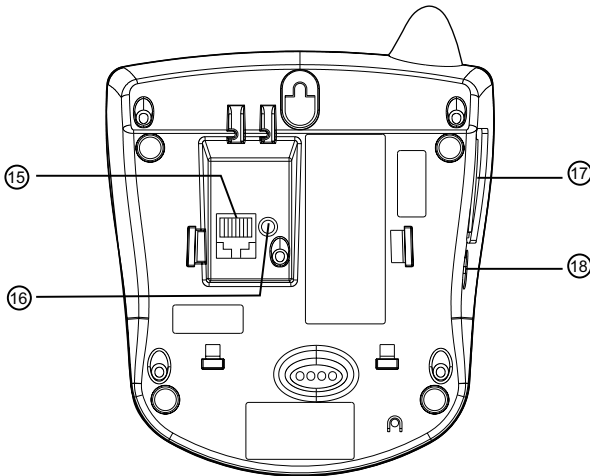
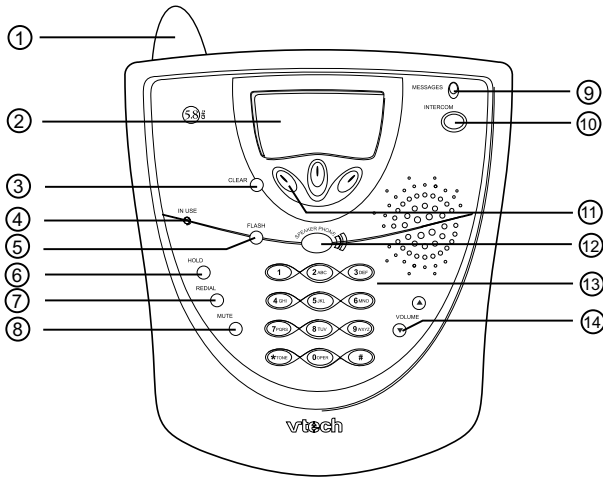

- | | |
|-----------------|------------------------------|
| 1. Antenna | 10. Intercom |
| 2. LCD Display | 11. Soft keys |
| 3. Clear | 12. Speaker Phone |
| 4. In Use | 13. Dialing Keys (0-9, *, #) |
| 5. Flash | 14. Volume Keys |
| 6. Hold | 15. Telephone Jack |
| 7. Redial | 16. DC Connector |
| 8. Mute | 17. Spare Battery Drawer |
| 9. Messages LED | 18. Spare Battery Release |

Connecting power to Base Unit/Handset Charger

1. Plug the AC power adapter into an electrical outlet, and the DC connector into the bottom of the Base Unit.

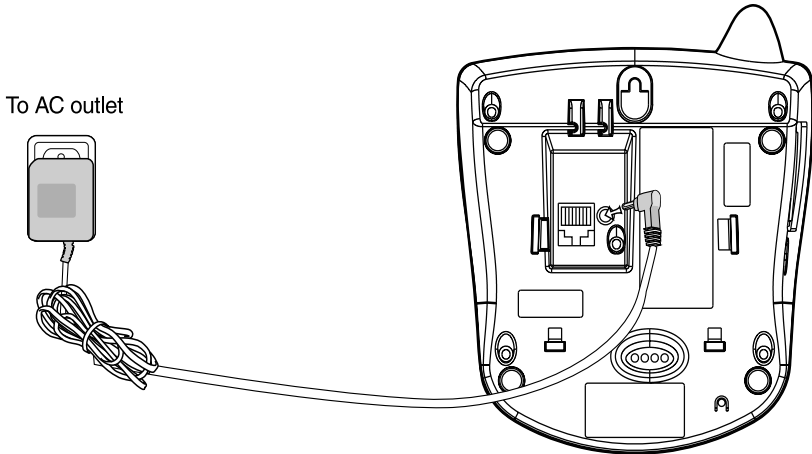

2. Choose the location for your Handset Charger, and plug its power supply into an electrical outlet.

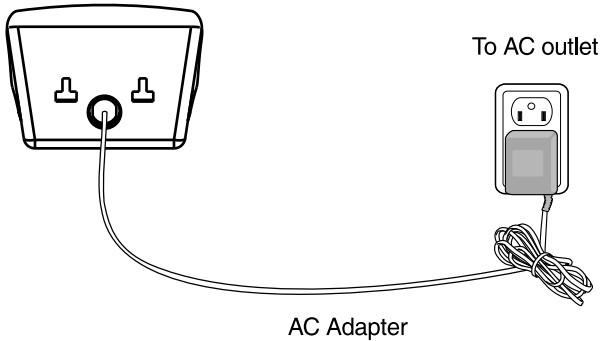

Setup

Installation of Battery Pack in Handset

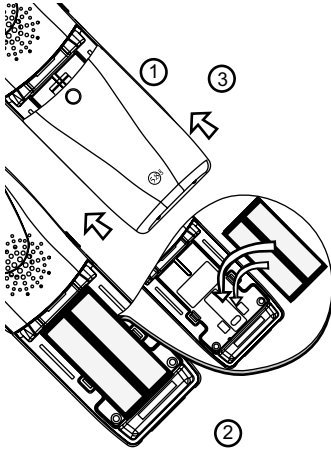

Follow the steps below:

1. Remove the battery cover by pressing on the indent and sliding downward.
2. Place the new battery pack in the Handset with the metal contacts aligned with the charge contacts in the battery compartment.
3. Replace the battery cover by sliding it upwards.
4. If the new battery pack is not already charged, place the Handset in its Charger, and allow it to charge for 12 hours. After initial charge, a maintenance charge of 8 hours should be sufficient.

The original Handset that is shipped with your VT5831 system will be automatically registered to the Base. This Handset is HANDSET 1.

As you register additional Handsets to the system, they will be assigned extension numbers in the following order: **HANDSET 2**, **HANDSET 3**, etc.

Whenever a charged Handset battery pack is installed, the Handset will automatically begin **SEARCHING FOR BASE** (if previously registered), or it will prompt you to **ENTER BASE ID** to register the new Handset.

Charging of the Handset Battery Pack

The Handset of your **VT5831** cordless telephone is powered by a rechargeable battery pack. It charges automatically whenever the Handset is in its charger.

You should charge the battery pack for 12 hours when you first receive your phone. You'll know the battery pack needs charging when:

- The low battery message is displayed :
- The Handset seems completely dead, the LCD is completely clear and does not activate when you press the keys.





IMPORTANT:

1. Do not dispose of a battery pack in a fire, the cell may explode.
2. Do not open or mutilate the battery pack. Toxic substances may be released, causing harm to eyes or skin.
3. Exercise care in handling battery packs in order to prevent an accidental short of the charge contacts, potentially causing the battery pack to overheat.
4. Do not dispose of this battery pack into household garbage. Please refer to the information concerning proper battery recycling.

Connecting to phone line

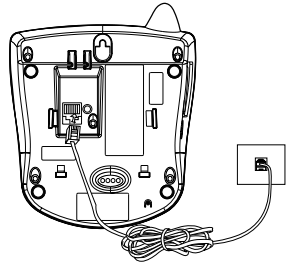
Plug one end of the telephone line cord into the jack on the back of the Base Unit. Plug the other end of this cord into the wall jack.

**Checking for dial tone**

After the battery is charged press **ON** on the Handset. The Phone icon  will appear on the Handset display, and you will hear dial tone. If not, see **In Case of Difficulty**.

Tone/Pulse selection

Your **VT5831** is preset for tone dialing.

See **BASE SETTINGS** for details.

⚠ CAUTION: Use only the Vtech power supply provided with your telephone.

IMPORTANT:**FOR MAXIMUM PERFORMANCE OF YOUR CORDLESS TELEPHONE SYSTEM:**

1. Choose a central location for your Base Unit.
2. Install your Base Unit and Extension Handsets away from electronic equipment, such as personal computers, television sets and microwave ovens.
3. In locations where there are multiple cordless telephones, separate base units as much as possible.
4. Install your telephone equipment away from heat sources and sunlight.
5. Avoid excessive moisture, dust or extreme cold.

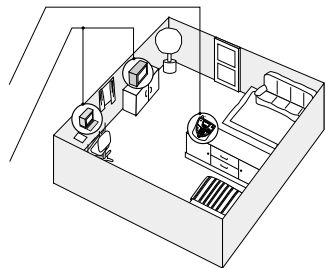

Spare Battery Charger/Power Backup Feature

The **VT5831** uses the spare battery charger in the Base Unit to provide operational backup in the event of a power failure. With a fully charged battery pack in the spare battery charger, you will still be able to place and receive calls from the **Handset only**, for up to **2 1/2** hours.

The spare battery pack can also be used to replace a drained handset battery, ensuring uninterrupted use. The spare battery pack is optional and purchased separately.

NOTE :

When using the **VT5831** during Power Backup mode, audio quality may be compromised due to reduced Power availability.

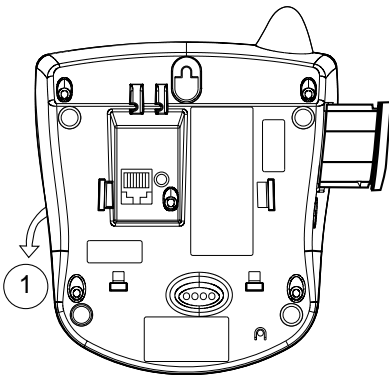

1. Open the spare battery charger by pressing the release button, located on the left-hand side of the Base Unit. A drawer will open to reveal the spare battery compartment.
2. Place a battery pack in the drawer with the charge contacts facing up and to the right.
3. Push the drawer closed.

The spare battery charger takes 24 hours to fully charge a drained battery.

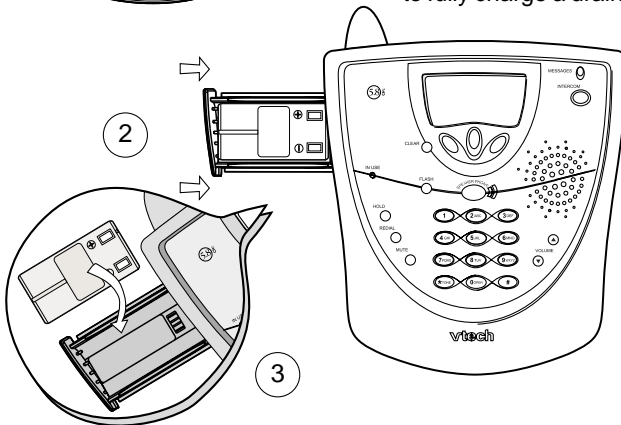

To order battery packs, headsets and additional Handsets (model VT 5820), call Vtech Customer Service at:

1-800-595-9511.

In Canada, call

1-800-267-7377.

The Wall Mount brackets are designed for use on standard wall mount plates only. Wall mounting is optional.

1. Plug the AC adapters into an electrical outlet, and the DC connector to the bottom of the Base Unit.
2. Connect the telephone line cord to the jack on the bottom of the Base Unit, and the other end to the wall jack.
3. Line up the tabs on the wall mount adapters with the holes on the bottom of the Base Unit/back of the Handset Charger. Snap the wall mount bracket firmly in place.
4. Mount the Base Unit/Handset Charger on the wall. Position the Base Unit/Handset Charger so the mounting studs will fit into the holes on the wall mount bracket. Slide Base Unit/Handset Charger down on the mounting studs until it locks into place.

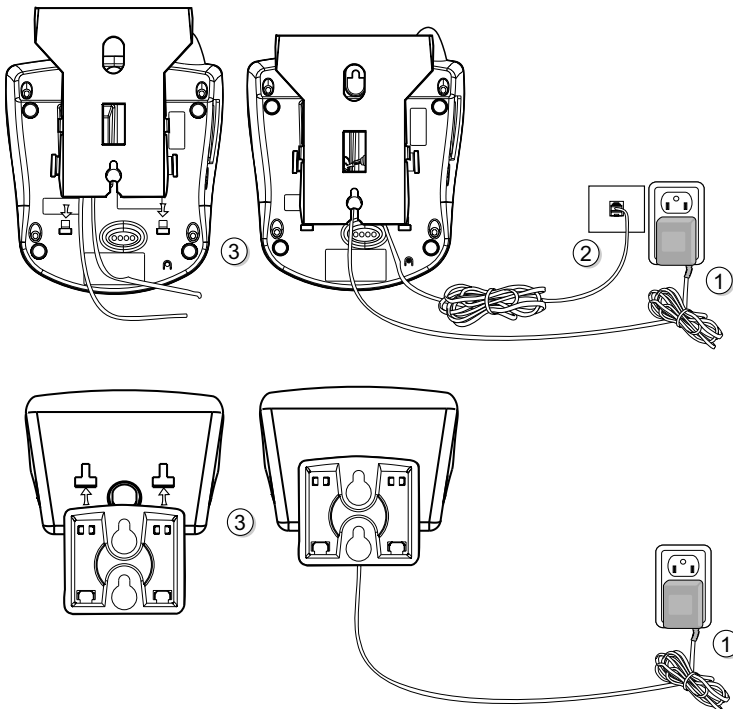

Registration and Operation

Expand your VT5831 system by adding accessory Handsets. Bring telephone service to rooms where a phone jack isn't available!

Registration and Operation Of The VTech VT5820 Accessory Handset

Your VTech VT5831 system can operate up to 6 Handsets.

The VT5820 accessory Handset consists of the following:

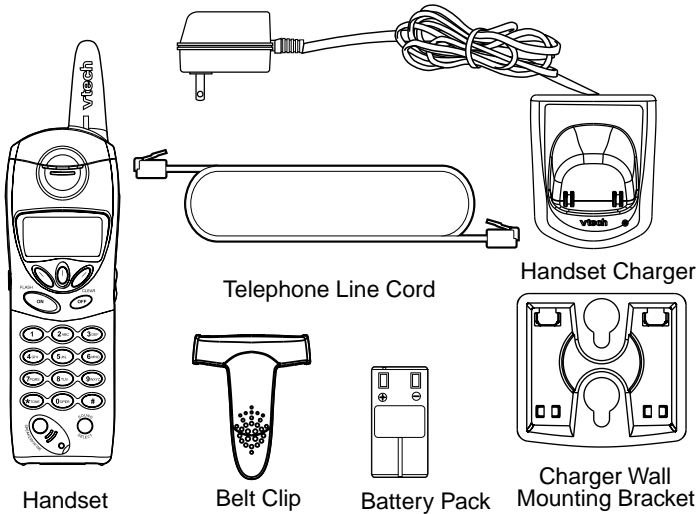

Handset

Telephone Line Cord

Handset Charger

Belt Clip

Battery Pack

Charger Wall Mounting Bracket



Setup Of The VT5820 Accessory Handset

1. Plug the AC power adapter into an electrical outlet.
2. Remove the Handset battery cover by pressing on the indent and sliding downward.
3. Place the new battery pack in the Handset, with the metal contacts aligned with the charge contacts in the battery compartment.
4. Replace the battery cover by sliding it upward.
5. Place the Handset in the Charger, and allow it to charge for 12 hours. After the initial charge, a maintenance charge of 8 hours should be sufficient.

Your **VT5831** Handset comes registered to the Base Unit. To register additional **VT5820** Handsets, follow these steps:

Enter Base ID Code

1. After charging the Handset, remove it from its Charge Cradle; the screen will display:

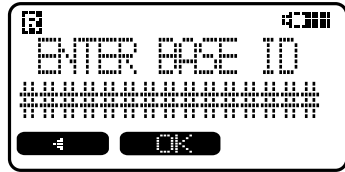

alternating with this screen:

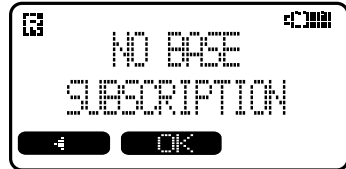

2. If, after charging the Handset, you see:
- The screen displays 'SEARCHING FOR BASE' in the center. At the bottom, there are two buttons: 'MENU' and 'NEW'.
3. Press **NEW**. You will now see the **ENTER BASE ID** screen as described in step 1.
 4. Find the **BASE ID Code** by doing the following: (the Base must be in idle (OFF) mode)
 - A. At the **Base**, press **MENU**
 - B. Scroll down to **DISPLAY BASE-ID**
 - C. Press **OK**. The Base screen will display the 15-digit **ID Code**. Afterwards, it will return to the idle screen.
 5. Enter the 15-digit **Base ID Code** into the **Handset**; then press **OK**.

NOTE: The 15-digit BASE ID Code may contain numbers and characters, such as * . Make sure you enter all 15 digits.











6. Wait approximately 15 to 60 seconds. You will hear confirmation beeps from the Base and Handset. The newly registered Handset will now assign itself the lowest Handset number not previously assigned to a different system Handset (1 through 6).
7. If the Handset displays **REJECTED BY BASE** or continues to display **SEARCHING FOR BASE** for well beyond 60 seconds, try the registration process again by repeating the above steps.



Congratulations! You can now enjoy the benefits of your **VTECH** Multi-Handset system.

Handset and Base Indicators



Handset Icons

Icon	Description
	<p><u>Line In Use indicator</u></p> <p>On steady with no number next to it when a parallel set is in use.</p> <p>On steady with one or more numbers next to it, indicating which extensions are using the line. For example,  12 indicates that Handset 1 and Handset 2 are on an outside call.</p>
	<p><u>Intercom indicator</u></p> <p>On steady with the extension numbers currently on an intercom call. For example,  02 indicates that the Base and Handset 2 are on an intercom call.</p>
	<p><u>Battery indicator</u></p> <p>When the Handset is removed from the charger, this lets you know the level of charge in the battery pack, from FULL () to EMPTY () .</p> <p>Cycles (Low, Medium, and Full) when Handset battery is charging. Flashes when a low battery condition is detected.</p>
	<p><u>Ringer Off indicator</u></p> <p> is displayed when the ringer is turned off.</p>
E	<p><u>Enhanced Mode indicator</u></p> <p>On steady when active Handset is in Enhanced mode. The Handset will enter Enhanced mode automatically when in an area with interference.</p>
M	<p><u>Mute indicator</u></p> <p>On steady when the Handset microphone is muted.</p>
H	<p><u>Hold indicator</u></p> <p>On steady when the line is on hold.</p>
	<p><u>Handset Registration indicator</u></p> <p> is displayed when a Handset is either not registered, or is searching for the Base Unit.</p>

Handset LEDs

LED	Description
Message Waiting	<ul style="list-style-type: none"> • Blinks to indicate that you have new voicemail messages. Service must be subscribed to through your local telephone company.

Base Unit Icons

Icon	Description
	<p><u>Ringer Off indicator</u></p> <p> is displayed when the Base ringer is turned off.</p>
	<p><u>Battery indicator</u></p> <p>Cycles (Low, Medium and Full) when a battery pack is charging in the spare battery compartment.</p>

Base LEDs

LED	Description
Messages	<ul style="list-style-type: none"> • Flashes to indicate that you have new voicemail messages. Service must be subscribed to through your local telephone company
In Use	<ul style="list-style-type: none"> • Lights when line is being used by a Handset of the VT5831 system. • Flashes when another telephone on the same line (parallel extension) is in use.
Speaker Phone	<ul style="list-style-type: none"> • Lights when Base Speakerphone is in use. • Flashes when HOLD function is activated.

Soft Menu Functions

The **VT5831** has an advanced design that uses a menu structure and soft keys to access many of the features.

Example of the idle mode display:

REDIAL

From the Handset:

Press **REDIAL** to display the last **10** telephone numbers dialed from the Handset. The number on the top line represents the last number dialed.

- Use the  scroll keys to highlight the desired number.
- To dial, press **ON/FLASH** or **SPEAKERPHONE**.

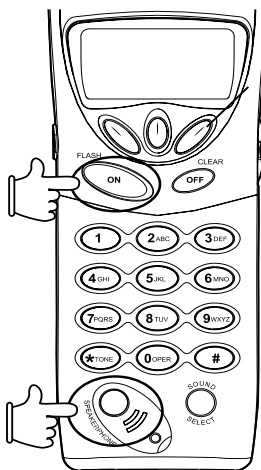
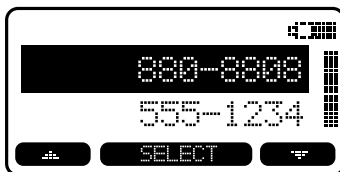

From the Base Unit:

Your **VT5831** Base remembers the last **10** numbers dialed from it. Press **REDIAL**. The number on the top line represents the last number to be dialed.

- Use the  scroll keys to highlight the desired number.



- To dial, press **SPEAKER PHONE**.

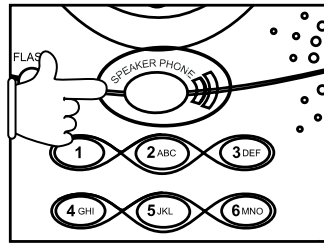

Erasing Numbers in Redial Memory (Handset or Base)

- Press **REDIAL**, then scroll to the desired number.
- Press **SELECT**, then **ERASE**.



Saving Redial Numbers in Phone Book Memory (Handset or Base)

- Press **REDIAL**, then scroll to the desired number.
- Press **SELECT**, then **SAVE**.
- You will be asked to **ENTER NAME**. Use the keypad to enter the desired name (see **To Store a Number/Name** for more information).
- Press **SAVE**. The name and number has been stored in Phone Book memory.

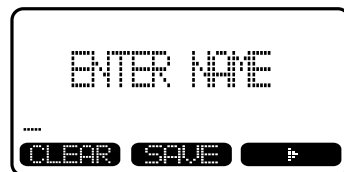



Soft Menu Functions

HANDSET MENU

With the Handset in the idle (OFF) mode, press **MENU** to access the following options:

- **CALLS LOG (Caller ID)**
- **INTERCOM**
- **HANDSET SETTINGS**
- **SET TIME**
- **CLOCK MODE**
- **REGISTER**

Use the   scroll keys to select the desired option, then press **OK**.

Press the **OFF/CLEAR** key to step back through the menu structure. Press and hold the **OFF/CLEAR** key to immediately return to the idle screen.

BASE UNIT MENU

With the Base Unit in the idle (OFF) mode, press **MENU** key to access the following options:

- **CALL LOG (Caller ID)**
- **BASE SETTINGS**

Press the **CLEAR** key to step back through the menu, Press and hold the **CLEAR** to immediately return to the idle screen.

Set Time

To set the time on your **VT5831**:

- At the Handset, press **MENU**, scroll down to **SET TIME**, then press **OK**.
- Using the keypad, enter the current time. A single-digit hour must have a zero before it (**03:56**, for example)
- If you make a mistake, use  to backspace.
- Use the **AM/PM** key to select the correct designation.
- Press **SAVE** to confirm the setting.



NOTE: You can also wait for incoming Caller ID to set the clock, rather than setting it manually.

Clock Mode (preset to ON)

When your **VT5831** is idle (OFF), the LCD displays the time of day, with both a digital and analog (clock face) readout.

If you do not want the time displayed, follow these steps:



- At the Handset, press **MENU**, scroll down to **CLOCK MODE**, then press **OK**.

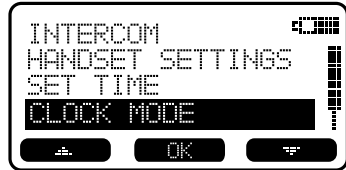

- Press **OFF (or ON)**, then press **OK**.

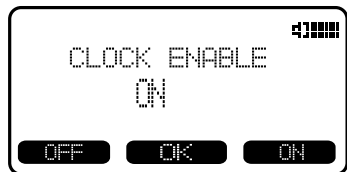

You can activate and deactivate Clock Mode as often as you wish.

Calls Log (Caller ID)

Caller ID - Call Waiting ID

Your **VT5831** is capable of displaying the name and/or number of the party calling before you answer the phone (**Caller ID**). It is also capable of displaying Caller ID information in conjunction with a Call Waiting alert signal (**Call Waiting Caller ID**). With Call Waiting Caller ID, the Caller ID data is displayed so you can decide whether to answer the incoming call, or continue with your current conversation.

NOTES ABOUT CALLER ID & CALL WAITING CALLER ID

These are subscription services, provided by most regional telephone service providers. You must subscribe to these services to get the benefits of these features. If you do not subscribe to Caller ID services, you can still use your **VT5831** and the other features it offers.

Due to regional incompatibilities, Caller ID information may not be available for every call you receive. In addition, the calling party may intentionally block their name and phone number from being sent.

Calls Log (Caller ID)

Reviewing Caller ID from the Handset or Base

As new Caller ID/Call Waiting ID records are received, your Handset and Base displays will alert you to the new Caller ID records, for example:

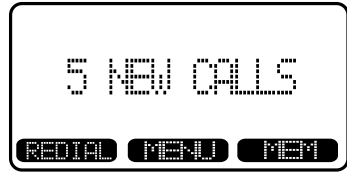

The number of new calls displayed on each system Handset and Base may not be the same. If, for example, you answer a call on **Handset 2**, that Handset will not count the Caller ID information for that call as new. However, the other registered Handset and Base displays will consider it a new call, and add it to the **NEW CALLS** total.

After you review all new Caller ID records, the **NEW CALLS** status will be turned off.

From the idle (OFF) mode, press **MENU**, **CALLS LOG** is highlighted, then press **OK**. The Caller ID information of the most recently received call will be displayed. For example:





To scroll to other records, use the  scroll keys.

Dialing from Caller ID

To dial the number displayed, you can simply press the **ON** or **SPEAKERPHONE** key. You can also press the **CID** key to access the following options (**DEL**, **OPT#**, **SAVE**):



OPT# : Select this option to display up to four possible dialing strings of the number stored in Caller ID memory. If a number is provided in the Caller ID data, the possible options to choose from will be either 7, 8, 10, or 11 digits. For example, if the original number in Caller ID memory was 808-880-8808, then the display options will be:

Use the  and  keys to make selection, and then press **DIAL**, **ON** or **SPEAKERPHONE** to dial the number.

Dialing Tip: With a Caller ID record displayed, press # repeatedly to cycle through the four dialing strings. When the correct dialing option is displayed, press **ON** (or **SPEAKERPHONE**) to dial.

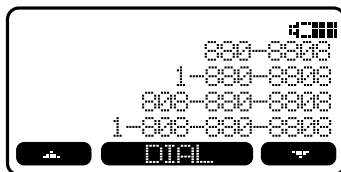

SAVE: Select this option to save the displayed Caller ID record into Speed Dial Memory. Only Caller ID records with telephone numbers can be saved into Speed Dial Memory. If you need to modify the number after saving, see **TO EDIT A NUMBER**.

Deleting CID Records

To delete the displayed Caller ID record, press **CID**, then **DEL**. You will then have the option of deleting the single CID record (press **THIS**) or all stored CID records (press **ALL**).

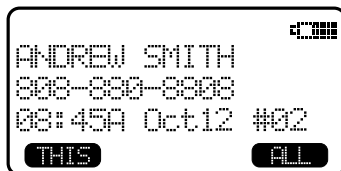

If you press **ALL**, the screen will ask **ARE YOU SURE?** Press **YES** to confirm the deletion of all CID records. Or, press **NO** to return to the CID record previously displayed.



NOTE: You do not have to delete Caller ID records. Your **VT5831** always saves the 50 most current CID records. As new records come in, the oldest records are automatically deleted to make room.

Handset Settings

From the **HANDSET SETTINGS** menu you can select the following options to modify:

- **RINGER VOLUME**

Select this option to adjust the ringer volume. Use the  scroll keys to adjust the volume up or down. You will see a graph on the Handset display indicating the relative volume setting. At the lowest setting (graph is completely clear), the Handset will **not** ring when a call comes in.

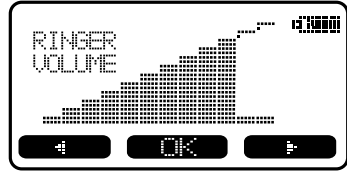

Press **OK** to confirm your setting.

- **RINGER MELODY**

Select this option to adjust the ringer melody or tone. Use the  scroll keys to select from the eight available tones. Press **OK** to confirm your selection and return to the **HANDSET SETTINGS** menu.

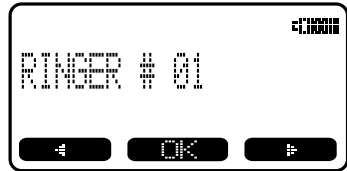

- **VIBRATE CONTROL (preset to OFF)**

Select this option to allow the Handset to vibrate, alerting you to an incoming call. Press the **ON** or **OFF** soft key to make your selection, then press **OK** to confirm.

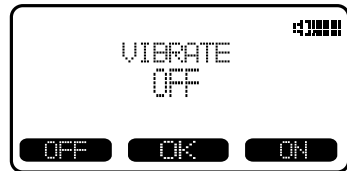

Vibrate and Ringer are independent features. Adjusting one does not affect the other.

- **LOW BATTERY TONE (preset to ON)**

Select this option to turn the Low Battery warning tone on or off. Press the **OFF** or **ON** soft key to make your selection. Press **OK** to confirm your selection and return to the **HANDSET SETTINGS** menu. When set to ON, the Handset will emit a warning tone when a Low Battery condition is detected.



- **RANGE TONE (preset to ON)**

Select this option to turn the Out of Range warning tone on or off. Press the **OFF** or **ON** soft key to make your selection. Press **OK** to confirm your selection and return to the **HANDSET SETTINGS** menu. When set to ON, the Handset will emit a warning tone whenever the Handset is taken out of range of the Base.

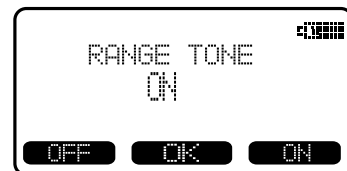



- **KEYPAD TONE (preset to ON)**

Select this option to turn the Keypad tones on or off. Press the **OFF** or **ON** soft key to make your selection. Press **OK** to confirm your selection and return to the **HANDSET SETTINGS** menu. When set to ON, the Handset will emit a beep whenever a key is pressed.



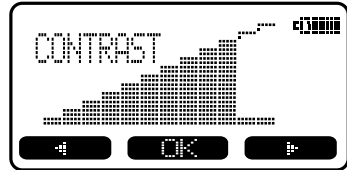

- **CONTRAST**

Select this option to adjust the contrast level of the Handset display. Use the   scroll keys to make your selection. The Handset display will automatically adjust as you make your selection. Press **OK** to confirm your selection and return to the **HANDSET SETTINGS** menu.



- **LANGUAGE (preset to English)**

Select this option to change the display from English to Spanish or French. Use the   scroll keys to select language, then press **OK** to confirm your choice.

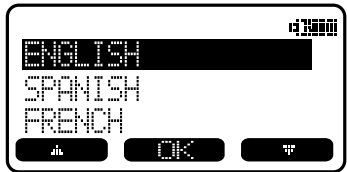

Register

REMINDER: The Handset that comes with your **VT5831** Base is already registered to it. Use this procedure to add additional Handsets (**model VT5820**) to your system.

Use this option to register a Handset to the **VT5831** Base. You can register a total of six Handsets to the Base. This process is activated automatically whenever a new Handset is powered up in range of the **VT5831** Base.

You will be prompted to enter the 15-digit Base ID code. After entering this code, press **OK**. The Handset will display **SEARCHING FOR BASE**, and then **FOUND BASE** when the process is complete.

NOTE: Base ID codes are 15 digits long and can include the following characters: 0, 1, 2, 3, 4, 5, 6, 7, 8, 9, * .

Base Settings

To access Base Settings, with the Base in the idle (OFF) mode, press **MENU**, scroll down to **BASE SETTINGS**, then press **OK**. You can now access the following setting options:

- **RINGER VOLUME**
- **RINGER MELODY**
- **KEYPAD TONE**
- **TONE/PULSE**
- **CONTRAST**
- **LANGUAGE**

Press **CLEAR** at any time to back out of **Base Settings** mode.

RINGER VOLUME

To adjust the Base Unit ringer volume:

- Press **MENU**. Scroll down to **BASE SETTINGS**, then press **OK**. **RINGER VOLUME** will be highlighted. Press **OK** again. You will see a graph on the Base display indicating the relative volume setting.
- Press **←** to lower the ringer volume. At the lowest setting (graph is completely clear), the Base will **not** ring when a call comes in.
- Press **→** to raise the volume. At the loudest setting, the graph is completely shaded in.
- Press **OK** to confirm your setting.

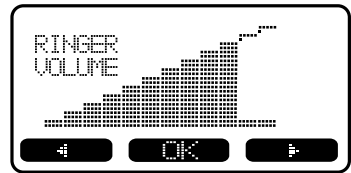

RINGER MELODY

There are **8** Base ringer melody choices. To change the melody:

- Press **MENU**. Scroll down to **BASE SETTINGS**, then press **OK**. Scroll down to **RINGER MELODY**.
- Press **OK**. Use the either scroll key to sample the melodies.
- Press **OK** to confirm your selection.



KEYPAD TONE (preset to ON)

Keypad tones are the 'beeps' you hear each time you press a key on the Base Unit.

To turn this feature ON or OFF:

- Press **MENU**. Scroll down to **BASE SETTINGS**, then press **OK**. Scroll down to **KEYPAD TONE**.
- Press **OK**. Choose **ON** or **OFF**.
- Press **OK** to confirm your selection.



TONE/PULSE (preset to TONE)

If you want to change your dialing mode, follow these steps:

- Press **MENU**. Scroll down to **BASE SETTINGS**, then press **OK**. Scroll down to **TONE/PULSE**.
- Press **OK**. Choose **TONE** or **PULSE**.
- Press **OK** to confirm your selection.



CONTRAST

You can adjust the Base Unit LCD screen's contrast to suit your eyes:

- Press **MENU**. Scroll down to **BASE SETTINGS**, then press **OK**. Scroll down to **CONTRAST**.
- Press **OK**. Use the **←** and **→** scroll keys to raise and lower the screen's contrast.
- Press **OK** to confirm your selection.

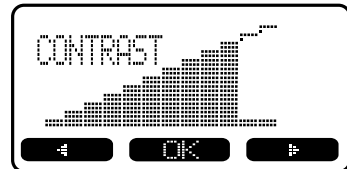

LANGUAGE (preset to ENGLISH)

Your display can be in English, Spanish or French. To adjust:

- Press **MENU**. Scroll down to **BASE SETTINGS**, then press **OK**. Scroll down to **LANGUAGE**.
- Press **OK**. Scroll to the desired language.
- Press **OK** to confirm your selection.



MEM (Memory)

The **VT5831** can store up to 50 names/numbers in memory. Each memory location can hold up to 32 digits and up to 16 characters for the name.

When prompted to **ENTER NAME?**, use the digit keys to 'spell' the name. Each press of a particular key causes characters to be displayed in the following order:

Number Key	Characters (in order)
1	& ' , . 1
2	A B C a b c 2
3	D E F d e f 3
4	G H I g h i 4
5	J K L j k l 5
6	M N O m n o 6
7	P Q R S p q r s 7
8	T U V t u v 8
9	W X Y Z w x y z 9
0	0
*	*
#	#

Each system Handset and the Base Unit can independently store names and numbers in memory. Adding, editing or deleting items stored in one unit does not affect any other system Handset or Base.

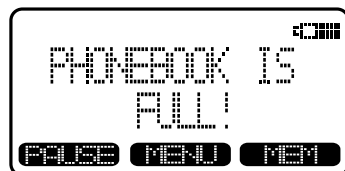
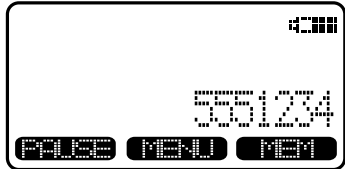
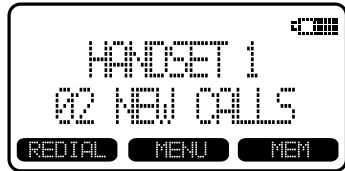

To Store a Number/Name:

- Starting from the idle screen, enter the number you want to store in memory.
- Be sure to include long distance codes and pauses (using the **PAUSE** softkey) if necessary. Press the **MEM** softkey.
- You will then be prompted to **ENTER NAME**. Use the digit keys to 'spell' the name. If you make a mistake, press the **CLR** softkey. To enter a space press **⇧** when finished, press **SAVE**.
- If there is space available in memory, the number/name will be saved and the Handset will return to predial mode.
- If the memory is full, the Handset will display **PHONEBOOK IS FULL** and exit to the idle screen without saving the entry.



Mem (Memory)

To Search For and Dial a Number/Name:

- Starting from the idle screen, press the **MEM** softkey to review memory contents.
- Using the  /  softkeys scroll through the memory contents in alphabetical order.
- Or, you can press the **FIND** softkey, enter the first few characters of the name and then press **FIND** to search. If you make a mistake, press **CLR** softkey. The closest match, in alphabetical order, will be displayed.
- Once you find the entry you want, simply press **ON** or **SPEAKERPHONE** to dial the number.

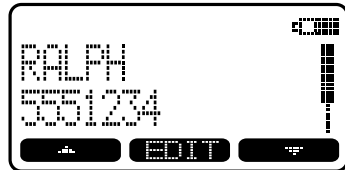
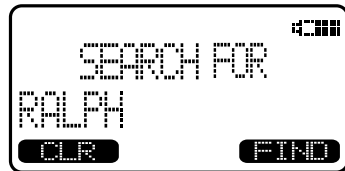
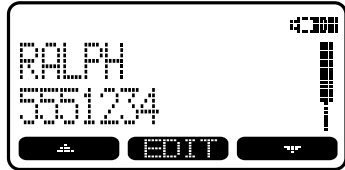

To Delete a Number/Name:

- Using the steps in **To Search For and Dial a Name/Number**, locate the entry you want to delete.
- Press the **EDIT** softkey. The screen will display:

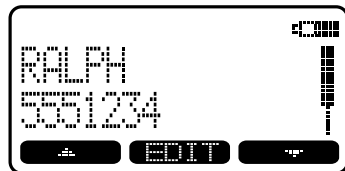

- Press the **DEL** softkey. The screen will display:
- To delete this record, press **THIS**. The record will be deleted, and the next entry in the phonebook will be displayed.
- To delete **all** records in your phonebook memory, press **ALL**. The display will ask **ARE YOU SURE?**
- To confirm the deletion of **ALL** records, press **YES**. To exit without deleting press **NO**.

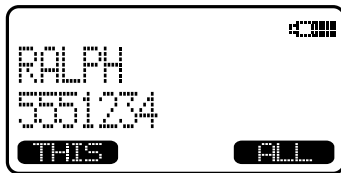

To Edit a Number

- Using the steps in **To Search For and Dial a Name/Number**, locate the entry you want to edit.
- Press the **EDIT** softkey **twice**. The Handset will display:
- Press **NAME** or **NUMBER**, depending on which you want to edit.
- Using the  softkey move the cursor to the character you want to edit and then enter the corrections as needed. Press **MORE** to access **DEL**, **BACK** and **PAUSE/SPACE** function. When finished press the **SAVE** softkey. To exit without saving press **OFF**.
- When finished the screen will display edited entry.

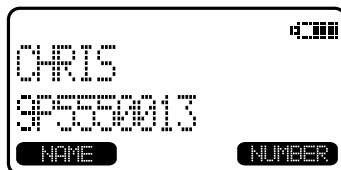
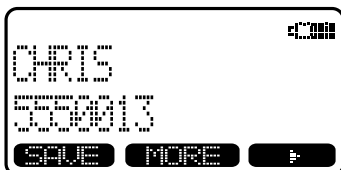
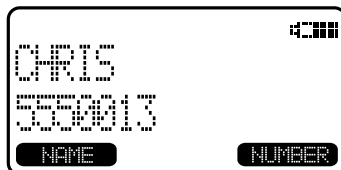
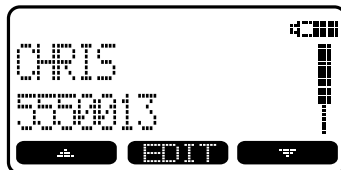

Handset and Base Operation

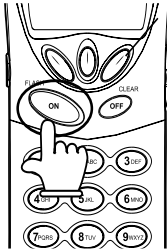

Making Calls

From the Handset

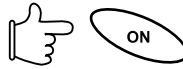

- Press **ON** (or, **SPEAKERPHONE** to use the Handset Speakerphone feature). Dial the phone number.
-OR-
- Dial the phone number first; then press **ON** (or **SPEAKERPHONE**).
- Press **OFF** to end your call.

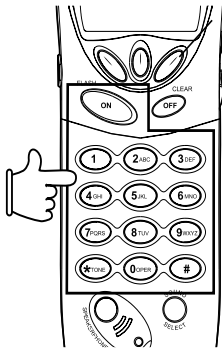

Answering Calls

From the Handset

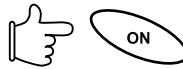

- Press any key except OFF and the softkeys.
- Press **OFF** to end your call.

Making Calls

From the Base Unit

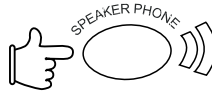

- Press **SPEAKERPHONE**. Dial the phone number.
- Press **SPEAKERPHONE** to end your call.
-OR-
- Dial the phone number first; then press **SPEAKERPHONE**

Answering Calls

From the Base Unit

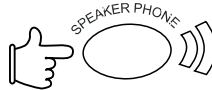

- Press **SPEAKERPHONE** or any of the dialing keys (0-9, *, #).
- Press **SPEAKERPHONE** to end your call.

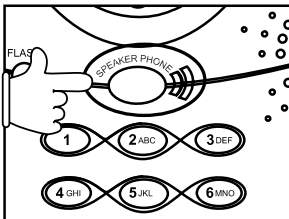

How to Adjust the Handset Volume (also applies to the Handset Speakerphone)

The **volume** control is on the **right** edge of the Handset. During a call, press the **UP** or **DOWN** key to adjust the listening volume to a comfortable level. The procedure is the same for the Handset earpiece and Speakerphone.

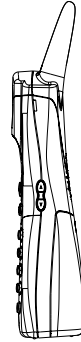

Base Speakerphone Volume

During an active call simply press the Volume **UP** or **DOWN** keys to adjust the speakerphone volume.

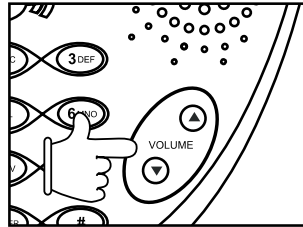

Sound Select

During a call, you can adjust the quality of the sound to best suit your hearing. Pressing **SOUND SELECT** repeatedly will cycle you through four different frequency responses:

BASS - Low Frequency sounds enhanced

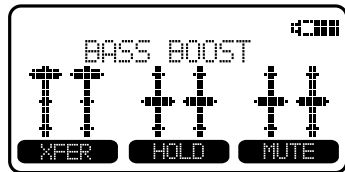

MID - Mid-Range sounds enhanced (This is the recommended setting for hearing aid users)

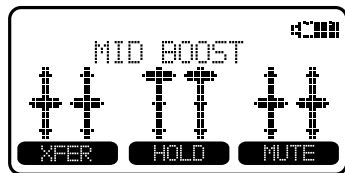

TREBLE - High Frequency sounds enhanced

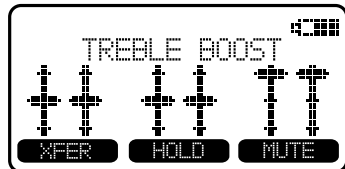

Handset and Base Operation

NATURAL - No frequency enhancement (Your Handset is preset with this selection)

The Handset will graphically display the four modes.

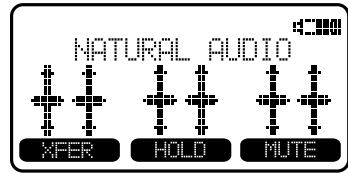

Mute Function



During an active call pressing either the **MUTE** soft key on the Handset or the **MUTE** key on the Base (when in Speakerphone mode), will disable the microphone. Press **MUTE** key again to return to normal 2-way conversation.

Hold Function



From the Handset :

- Press the **HOLD** soft key to place a call on hold. To return to the call, press the **ON** (or **SPEAKERPHONE**) key.

From the Base :

- During an active call, press the **HOLD** key to place a call on hold. The **SPEAKERPHONE LED** will flash to indicate a call is on hold.
- To return to the call, press either **HOLD** or **SPEAKERPHONE**.

Note: Both the Handset and Base will display **CALL ON HOLD** when a call is placed on hold. However, with Clock Mode **enabled**, the **CALL ON HOLD** alert will be displayed on the Handset for only **5** seconds.

If a call remains on Hold for 5 minutes, your **VT5831** will ring to remind you the call is being held. The phone will display **CALL ON HOLD RING BACK!** You have 30 seconds to return to the call before it is dropped.

Flash Function



You can use your **VT5831** with services such as Call Waiting. Simply press the **ON** key on the Handset or the **FLASH** key on the Base (when in speakerphone mode) to flash the line.

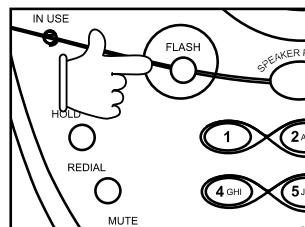
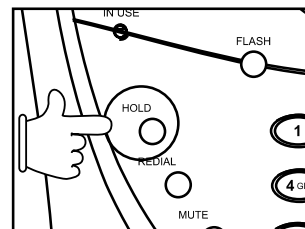
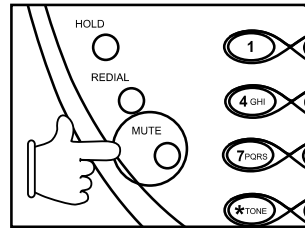

Intercom

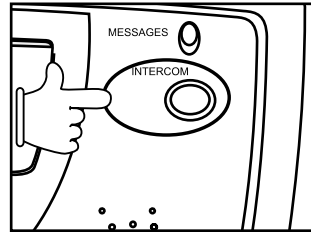

From Base to ALL Handsets :

- To page all Handsets from the Base press the **INTERCOM** key. Scroll to **GLOBAL PAGE**, then press **OK**.
- Each Handset will display **GLOBAL CALL FROM BASE**.
- Any Handset can then answer the **PAGE**, and enter **INTERCOM** mode with the Base by pressing the **ON** or any number key.
- To end an intercom call, press **OFF** on the Handset or **INTERCOM** on the Base.

From Base to a Specific Handset :

- Press the Base **INTERCOM** key, then scroll to the Handset you want to call (e.g. **HANDSET 2**).
- **Handset 2** can then answer the intercom call by pressing any key except **OFF** and the softkeys.
- To end an intercom call press **OFF** on the Handset or **INTERCOM** on the Base.

From Handset to Base :

- Press **MENU**, then scroll down to **INTERCOM**
- Press **OK**. Scroll to **BASE**, then press **OK**.
- The Base will ring, then automatically enter intercom mode.
- To end the intercom call, press **OFF** on the Handset or **INTERCOM** on the Base.



From Handset to Handset :

- Press **MENU**, then scroll down to **INTERCOM**.
- Press **OK**. Scroll to the desired Handset, then press **OK**.
- The ringing Handset can respond by pressing **ON** or any of the number keys.
- To end the intercom call, press **OFF** on either Handset.

Global Page from Handset

- Press **MENU**, then scroll down to **INTERCOM**.
- Press **OK**. Scroll to the **GLOBAL PAGE**, then press **OK**.
- Any registered Handset or Base can answer the global page, thus entering Intercom mode.

Handset and Base Operation

Handsfree Speakerphone Operation

Your **VT5831** Handset has a built-in handsfree speakerphone. This feature allows you to stand the Handset upright on a table or desktop and have handsfree conversations. For more information, refer to **MAKING CALLS in HANDSET AND BASE OPERATION**.

Base Speakerphone Operation

The Base of your **VT5831** is equipped with a full duplex speakerphone. This is a very useful feature for handsfree conversations or conference calls at the Base Unit. For more information, refer to **MAKING CALLS in HANDSET AND BASE OPERATION**.

Line in Use Indication

On the Handset :

When the telephone line is currently being used by a **VT5831** Handset or the Base, a status message similar to this will display on idle Handset(s):



When the telephone line is currently being used by a parallel set (a telephone device other than the **VT5831** on the same line); the phone icon will remain on steadily, and **EXTENSION IN USE** will be displayed.

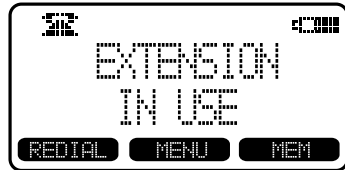

NOTE: With Clock Mode **ENABLED**, the telephone icon moves to the top center section of the screen:



On the Base :

When a **VT5831** Handset is in use, the **IN USE** LED will glow, and **LINE IN USE** will appear on the screen. When a parallel set is in use, the **IN USE** will flash, and **EXTENSION IN USE** will appear on the screen.

Low Battery Indication

When a low battery is detected, the Battery icon will flash and a warning beep is played. The status message **LOW BATTERY** will also be displayed when the Handset is in idle mode. To prevent an unexpected call drop, a drained Handset battery should be replaced by a fully charged spare battery.

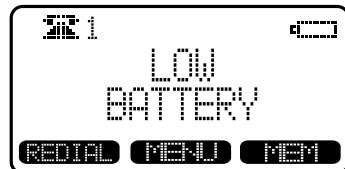

Message Waiting Indication

The **VT5831** is compatible with optional voicemail service provided by some local telephone companies. If you subscribe to this service, and you have new, unplayed messages in your voicemail, a Visual Message Waiting Indication (VMWI) signal is transmitted by your local telephone company.

The **VT5831** will detect a VMWI signal and activate Message Waiting lights on the Base and Handset(s). See **Handset** and **Base Unit Layouts**, pages **5** and **6**, for the location of the Message Waiting lights.

After you play all of your new messages, the Message Waiting indicators will automatically turn off. If the indicators remain on, disconnect the power adapter from the Base Unit and remove the spare battery from the Base Unit charger (if applicable). Wait at least **15 seconds**. Then, connect the power adapter back to the Base and install the spare battery pack in the Base Unit charger (if applicable). The Message Waiting lights will now be off.

Conference Calling

The **VT5831** is capable of supporting conference calls with up to two registered Handsets, and the Base Unit.

To enter a conference call, simply access the line with two or more extensions by pressing **ON** (or **SPEAKERPHONE**) on the Handset or **SPEAKERPHONE** on the Base.

The phone icon  and two or more extension numbers will be displayed in the upper left corner of the Handset.

Transferring Calls

You can transfer calls on the **VT5831** system from the Base to Handset, Handset to Handset, or Handset to Base.

Blind Transfer

You can directly transfer any active call to another **VT5831** extension without notification by doing the following steps:

From the Handset

- Press **XFER**. Scroll to the desired destination, then press **OK**.
- The ringing Handset or Base can pick up the transferred call just like any incoming call.

From the Base

- Press **INTERCOM**. Scroll to the desired destination, then press **OK**.
- The ringing Handset can pick up the transferred call just like any incoming call.

Announced Transfer:

You can perform an announced transfer (call and advise another extension) of an active call by doing the following steps:

- Press **HOLD** to place your call on hold.
- Press **MENU**. Scroll to **INTERCOM**, then press **OK**.
- Scroll to the desired destination, then press **OK**.
- When the ringing Handset or Base answers, announce that there's an active call on hold.
- Press **OFF** (on the Handset) or **INTERCOM** (on the Base)
- Press **ON** (on the 'destination' Handset or **SPEAKER PHONE** (on the Base) to pick up the call on hold.

Headset Operation

Your **VT5831** cordless telephone is equipped with a 2.5mm Headset Jack for use with an optional accessory Headset for hands-free operation. If you choose to use the Headset option, you must obtain an optional accessory Headset, which is compatible with the **VT5831**.

To purchase a Headset, call VTECH Customer Service at 1-800-595-9511.

Once you have a compatible 2.5mm Headset, locate the Headset Jack on the **VT5831** Handset. Connect the plug on the Headset cord to the jack on the cordless Handset. The plug should fit securely. Do not force the connection.

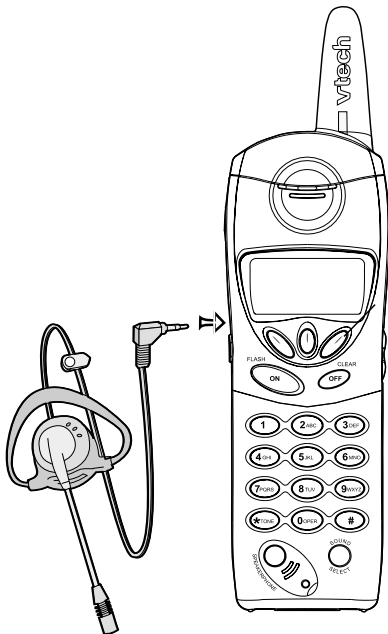

NOTE :

Whenever a compatible Headset is connected to the cordless Handset, the microphone on the Handset will be muted. This is done to limit the effect of background noise.

Many compatible headsets have a reversible, monaural design. You can wear your Headset on either ear, leaving one ear free for room conversation.

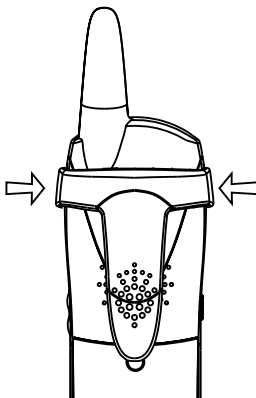

Belt Clip

The **VT5831** is also equipped with a detachable belt clip. Align the pins on the inside edge of the clip with the notches on the sides of the **VT5831** Handset. The belt clip should snap securely into place. Do not force the connection.

Taking Care Of Your Telephone

Your **VT5831** cordless telephone contains sophisticated electronic parts, so it must be treated with care.

Avoid rough treatment

Place the Handset down gently. Save the original packing materials to protect your telephone if you ever need to ship it.

Avoid water

Your telephone can be damaged if it gets wet. Do not use the Handset outdoors in the rain, or handle it with wet hands. Do not install your Base Unit near a sink, bathtub or shower.

Electrical storms

Electrical storms can sometimes cause power surges harmful to electronic equipment.

For your own safety, use caution when using electric appliances during storms.

Cleaning your telephone

Your telephone has a durable plastic casing that should retain its luster for many years. Clean it only with a soft cloth slightly dampened with water or a mild soap. Do not use excess water or cleaning solvents of any kind.

Remember that electrical appliances can cause serious injury if used when you are wet or standing in water. If your Base Unit should fall into water, **DO NOT RETRIEVE IT UNTIL YOU UNPLUG THE POWER CORD AND TELEPHONE LINE CORDS FROM THE WALL.** Then pull the unit out by the unplugged cords.

In Case Of Difficulty

If you have difficulty operating your phone, the suggestions below should solve the problem. If you still have difficulty after trying these suggestions, call VTECH Communications at 1-800-595-9511. In Canada, call VTECH Electronics at 1-800-267-7377.

The Phone Doesn't Work At All

- Make sure the Power Cord is plugged in.
- Make sure the telephone line cord is plugged firmly into the Base Unit and the telephone wall jack.
- Make sure the batteries are properly charged. If the 'LOW BATTERY' message is shown, the battery pack needs charging.

No Dial Tone

- First check all the suggestions above.
- If you still don't hear a dial tone, disconnect the Base Unit from the telephone jack and connect a different phone. If there is no dial tone on that phone either, the problem is in your wiring or local service. Contact your local telephone company.

You Get Noise, Static, Or A Weak Signal Even When You're Near

The Base Unit

- Household appliances plugged into the same circuit as the Base Unit can sometimes cause interference. Try moving the appliance or the Base Unit to another outlet.

You Get Noise, Static, Or A Weak Signal When You're Away From

The Base Unit

- You may be out of range. Either move closer to the Base, or relocate the Base Unit.
- The layout of your home may be limiting the range. Try moving the Base Unit to another position.

The Handset Does Not Ring When You Receive A Call

- Make sure you have the ringers activated. To set the ringer, see **HANDSET SETTINGS** and **BASE SETTINGS**.
- Make sure the telephone line cord is plugged firmly into the Base Unit and the telephone jack. Make sure the power cord is plugged in.
- You may be too far from the Base Unit.
- You may have too many extension phones on your telephone line to allow all of them to ring. Try unplugging some of the other phones.

Your Handset vibrates or shakes when a call comes in

- It is likely that your Vibrating Handset Ringer option has been set to **ON**. If you'd like to turn it off, see **Handset Settings-VIBRATE CONTROL**, on page 22.

You Hear Other Calls While Using Your Phone

- Disconnect your Base Unit from the telephone jack, and plug in a regular telephone. If you still hear other calls, the problem is probably in your wiring or local service. Call your local telephone company.

You Hear Noise In The Handset, And None Of The Keys Or Buttons Work

- Make sure the power cord is plugged in.

Common Cure For Electronic Equipment

If the unit does not seem to be responding normally, then try putting the Handset in the cradle. If it does not seem to respond, do the following (in the order listed) :

1. Disconnect the power to the Base.
2. Disconnect the Handset battery, and spare battery pack, if applicable.
3. Wait a few minutes.
4. Connect power to the Base.
5. Re-install the battery pack (s)
6. Watch for Handset to display :



then



Warranty Statement

What does this limited warranty cover?

- The manufacturer of this VTECH product, VTECH Communications, warrants to the holder of a valid proof of purchase (“Consumer” or “you”) that the product and all accessories provided by VTECH in the sales package (“Product”) are free from material defects in material and workmanship, pursuant to the following terms and conditions, when installed and used normally and in accordance with operation instructions, This limited warranty extends only to the Consumer for Products purchased and used in the United States of America.

What will VTECH Communications do if the Product is not free from material defects in materials and workmanship during the limited warranty period (“Materially Defective Product”)?

- During the limited warranty period, VTECH’s authorized service representative will repair or replace at VTECH’s option, without charge, a Materially Defective Product. If we repair this product, we may use new or refurbished replacement parts. If we choose to replace this product, we may replace it with a new or refurbished product of the same or similar design. VTECH will return repaired or replacement products to you in working condition. VTECH will retain defective parts, modules, or equipment. Repair or replacement of Product, at VTECH’s option, is your exclusive remedy. You should expect the repair or replacement to take approximately 30 days.

How long is the limited warranty period?

- The limited warranty period for the product extends for ONE(1) YEAR from the date of purchase if we repair or replace a Materially Defective Product under the terms of this limited warranty. This limited warranty also applies to repaired or replacement Products for a period of either (a) 90 days from the date the repaired or replacement Product is shipped to you or (b) the time remaining on the original one-year warranty; whichever is longer.

What is not covered by this limited warranty?

This limited warranty does not cover

1. Product that has been subjected to misuse, accident, shipping or other physical damage, improper installation, abnormal operation or handling, neglect, inundation, fire, water or other liquid intrusion; or
2. Product that has been damaged due to repair, alteration or modification by anyone other than an authorized service representative of VTECH; or
3. Product to the extent that the problem experienced is caused by signal conditions, network reliability or cable or antenna systems; or
4. Product to the extent that the problem is caused by use with non-VTECH electrical accessories; or
5. Product whose warranty/quality stickers, Product serial numbers plates or electronic serial numbers have been removed, altered or rendered illegible; or
6. Product purchased, used, serviced, or shipped for repair from outside the United States, or used for commercial or institutional purposes (including but not limited to Products used for rental purposes); or
7. Product returned without valid proof of purchase (see 2 below); or

- Charges for installation or set up, adjustment of customer controls, and installation or repair of systems outside the unit.

How do you get warranty service?

- To obtain warranty service in the United States of America, call 1 800-595- 9511 for instructions regarding where to return the Product. Before calling for service, please check the user's manual. A check of the Product controls and features may save you a service call.
- Except as provided by applicable law, you assume the risk of loss or damage during transit and transportation and are responsible for delivery or handling charges incurred in the transport of Product(s) to the service location. VTECH will return repaired or replaced product under this limited warranty to you, transportation, delivery or handling charges prepaid. VTECH assumes no risk for damage or loss of the Product in transit.
- If the Product failure is not covered by this limited warranty, or proof of purchase does not meet the terms of this limited warranty, VTECH will notify you and will request that you authorize the cost of repair and return shipping costs for the repair of Products that are not covered by this limited warranty.

What must you return with the Product to get warranty service?

- Return the entire original package and contents including the Product to the VTECH service location along with a description of the malfunction or difficulty;
- Include "valid proof of purchase" (sales receipt) identifying the Product purchased (Product model) and the date of purchase or receipt; and
- Provide your name, complete and correct mailing address, and telephone number.

Other Limitations

- This warranty is the complete and exclusive agreement between you and VTECH. It supersedes all other written or oral communications related to this Product. VTECH provides no other warranties for this product. The warranty exclusively describes all of VTECH's responsibilities regarding the product.

There are no other express warranties. No one is authorized to make modifications to this limited warranty and you should not rely on any such modification.

State Law Rights: This warranty gives you specific legal rights, and you may also have other rights which vary from state to state.

Limitations: Implied warranties, including those of fitness for a particular purpose and merchantability (an unwritten warranty that the product is fit for ordinary use) are limited to one year from date of purchase. Some states do not allow limitations on how long an implied warranty lasts, so the above limitation may not apply to you.

- In to event shall VTECH be liable for any indirect, special, incidental, consequential, or similar damages(including, but not limited to lost profits or revenue, inability to use the product, or other associated equipment, the cost of substitute equipment, and claims by third parties) resulting from the use of this product, some states do not allow the exclusion or limitation of incidental or consequential damages, so the above limitation or exclusion may not apply to you.

FCC, ACTA and IC Regulations

This equipment complies with Parts 15 of the Federal Communications Commission (FCC) rules for the United States. It also complies with regulations RSS210 and CS-03 of Industry and Science Canada. Operation is subject to the following two conditions: (1) this device may not cause interference, and (2) this device must accept any interference, including interference that may cause undesired operation of the device.

A label is located on the underside of the Base Unit containing either the FCC registration number and Ringer Equivalence Number (REN) or the IC registration number and Load Number. You must, upon request, provide this information to your local telephone company.

This equipment is compatible with inductively coupled hearing aids.

Should you experience trouble with this telephone equipment, please contact:

VTech Communications Inc

CUSTOMER SERVICE. at 1-800-595-9511. In Canada, call VTECH Electronics at 1-800-267-7377.

For repair/warranty information. The telephone company may ask you to disconnect this equipment from the line network until the problem has been corrected.

FCC Part 15

Warning: Changes or modifications to this unit not expressly approved by the party responsible for compliance could void the user's authority to operate the equipment.

The equipment has been tested and found to comply with part 15 of the FCC rules. These limits are designed to provide reasonable protection against harmful interference in a residential installation. This equipment generates, uses and can radiate radio frequency energy and, if not installed and used in accordance with the instructions, may cause harmful interference to radio communications. However, there is no guarantee that interference will not occur in a particular installation. If this equipment does cause harmful interference to radio or television reception, which can be determined by turning the equipment off and on, the user is encouraged to try and correct the interference by one or more of the following measures:

- Reorient or relocate the receiving antenna.
- Increase the separation between the equipment and receiver.
- Connect the equipment into an outlet or on a circuit different from that to which the receiver is connected.
- Consult the dealer or an experienced radio/TV technician for help.

FCC Part 68 and ACTA

If this equipment was approved for connection to the telephone network prior to July 23, 2001, it complies with Part 68 of the Federal Communications Commission (FCC) rules. If the equipment was approved after that date, it complies with the Part 68 rules and with Technical Requirements for Connection of Equipment to the Telephone Network adopted by the Administrative Council for Terminal Attachments (ACTA). We are required to provide you with the following information.

1. Product identifier and REN information

The label on the back or bottom of this equipment contains, among other things, an identifier indicating product approval and the Ringer Equivalence Number (REN). This information must be provided to your local telephone company upon request. For equipment approved prior to July 23, 2001, the product identifier is preceded by the phrase "FCC Reg No." and the REN is listed separately. For equipment approved after that date, the product identifier is preceded by "US" and a colon (:), and the REN is encoded in the product identifier without a decimal point as the sixth and seventh characters following the colon. For example, the product identifier US:AAAEQ03T123XYZ would indicate an REN of 0.3. The REN is used to determine how many devices you may connect to your telephone line and still have them ring when you are called. In most, but not all areas, the sum of all RENs should be five (5.0) or less. You may want to contact your local telephone company for more information.

2. Connection and use with the nationwide telephone network

The plug and jack used to connect this equipment to the premises wiring and the telephone network must comply with the applicable Part 68 rules and technical requirements adopted by ACTA. A compliant telephone cord and modular plug is provided with this product. It is designed to be connected to a compatible modular jack that is also compliant. An RJ11 jack should normally be used for connecting to a single line and an RJ14 jack for two lines. See Installation Instructions in the user's manual. This equipment may not be used with Coin Telephone Lines or with Party Lines. If you have specially wired alarm dialing equipment connected to your telephone line, ensure the connection of this equipment does not disable your alarm equipment. If you have questions about what will disable alarm equipment, consult your telephone company or a qualified installer.

3. Repair instructions

If this equipment is malfunctioning, it must be unplugged from the modular jack until the problem has been corrected. Repairs to this telephone equipment can only be made by the manufacturer or its authorized agents. For repair procedures, follow the instructions outlined under the Limited Warranty.

4. Rights of the telephone company

If this equipment is causing harm to the telephone network, the telephone company may temporarily discontinue your telephone service. The telephone company is required to notify you before interrupting service. If advance notice is not practical, you will be notified as soon as possible. You will be given the opportunity to correct the problem and the telephone company is required to inform you of your right to file a complaint with the FCC. Your telephone company

FCC, ACTA and IC Regulations

may make changes in its facilities, equipment, operation, or procedures that could affect the proper functioning of this product. The telephone company is required to notify you if such changes are planned.

5. Hearing aid compatibility

If this product is equipped with a corded or cordless handset, it is hearing aid compatible.

6. Programming/testing of emergency numbers

If this product has memory dialing locations, you may choose to store police, fire department and emergency medical service telephone numbers in these locations. If you do, please keep three things in mind:

- a We recommend that you also write the telephone number on the directory card, so that you can still dial the emergency number manually if the memory dialing feature doesn't work.
- b This feature is provided only as a convenience, and the manufacturer assumes no responsibility for customer reliance upon the memory feature.
- c Testing the emergency telephone numbers you have stored is not recommended. However, if you do make a call to an emergency number:
 - You must remain on the line and briefly explain the reason for the call before hanging up.
 - Programming/testing of emergency numbers should be performed during off-peak hours, such as in the early morning or late evening, when the emergency services tend to be less busy.

IC (Industry Canada)

This telephone is registered for use in Canada.

The term "IC:" before the radio certification number only signifies that Industry Canada technical specifications were met.

Notice:

This equipment meets the applicable Industry Canada Terminal Equipment Technical Specifications. This is confirmed by the registration number. The abbreviation, IC, before the registration number signifies that registration was performed based on a Declaration of Conformity indicating that Industry Canada technical specifications were met. It does not imply that Industry Canada approved the equipment.

Notice:

The Ringer Equivalence Number (REN) for this terminal equipment is 0.1. The REN assigned to each terminal equipment provides an indication of the maximum number of terminals allowed to be connected to a telephone interface. The termination on an interface may consist of any combination of devices subject only to the requirement that the sum of the Ringer Equivalence Numbers of all the devices does not exceed five.

Before installing this equipment, users should ensure that it is permissible to be connected to the facilities of the local telecommunications company. The equipment must also be installed using an acceptable method of connection. The customer should be aware that compliance with the above conditions may not prevent degradation of services in some situations.

Repairs to certified equipment should be made by an authorized Canadian maintenance facility designated by the supplier. Any repairs or alterations made by the user to this equipment, or equipment malfunctions, may give the telecommunications company cause to request the user to disconnect the equipment.

Users should ensure for their own protection that the electrical ground connections of the power utility, telephone lines and internal metallic water pipe system, if present, are connected together. This precaution may be particularly important in rural areas.

Caution :

Users should not attempt to make such connections themselves, but should contact the appropriate electrical inspection authority, or electrician, as appropriate.

Your **VT5831** is designed to operate at the maximum power allowed by the FCC and IC. This means your Handset and Base Unit can communicate only over a certain distance - which will depend on the location of the Base Unit and Handset, weather, and the construction and layout of your home or office.

The RBRC[®] Seal

The RBRC[®] Seal on the nickel-metal-hydride battery indicates that VTech Communications, Inc. is voluntarily participating in an industry program to collect and recycle these batteries at the end of their useful lives, when taken out of service within the United States and Canada.

The RBRC[®] program provides a convenient alternative to placing used nickel-metal-hydride batteries into the trash or municipal waste, which may be illegal in your area.

VTech's participation in RBRC[®] makes it easy for you to drop off the spent battery at local retailers participating in the RBRC[®] program or at authorized VTech product service centers. Please call **1-800-8-BATTERY[™]** for information on Ni-MH battery recycling and disposal bans/restrictions in your area. VTech's involvement in this program is part of its commitment to protecting our environment and conserving natural resources.



RBRC[®] is a registered trademark of Rechargeable Battery Recycling Corporation.

Technical Specifications

FREQUENCY CONTROL

Crystal controlled
PLL synthesizer

TRANSMIT FREQUENCY

Base : 5744.736 - 5825.952 MHz
Handset: 2401.056 - 2482.272 MHz

RECEIVE FREQUENCY

Base: 2401.056 - 2482.272 MHz
Handset : 5744.736 - 5825.952 MHz

CHANNELS

95 Channels

NOMINAL EFFECTIVE RANGE

Maximum power allowed by FCC and IC. Actual operating range may vary according to environmental conditions at the time of use.

SIZE

Handset : 193mm x 52mm x 40mm
(including antenna)
Base : 192mm x 143mm x 91mm
Charger: 77mm x 69mm x 54mm

WEIGHT

Handset : 138 grams
(excluding Battery Pack)
Base : 396 grams
Charger : 216 grams

POWER REQUIREMENTS

Handset : 2.4V 1400mAh NiMH
Battery Pack
Base : 7 VDC @ 900mA
Charger : 6 VDC @ 300mA

MEMORY

Speed Dial: 50 Memory locations; up to 32 digits per location
CID : Alphanumeric Display
50 Memory locations

**SPECIFICATIONS ARE TYPICAL
AND MAY CHANGE WITHOUT
NOTICE.**

1. Important Safety Instructions	23. Register
	24. Base Settings
3. Introduction	24. Ringer Volume
4. Parts Check List	24. Ringer Melody
5. The Handset Layout	25. Keypad Tone
6. The Base Unit Layout	25. Tone/Pulse
	25. Contrast
7. Getting Started	25. Language
7. Setup	26. MEM (Memory)
7. Connecting power to Base Unit/Handset Charger	27. To Store a Number/Name
8. Installation of Battery Pack in Handset	28. To Search For and Dial a Number/Name
8. Charging of Handset Pack	28. To Delete a Number/Name
9. Connecting to phone line	29. To Edit a Number
9. Checking for dial tone	
9. Tone/Pulse selection	30. Advanced Operations
10. Spare Battery Charger/ Power Backup Feature	30. Handset and Base Operation
11. Wall Mounting	30. Making Calls
12. Registration and Operation	30. Answering Calls
	31. How to Adjust The Handset Volume
	31. Base Speakerphone Volume
	31. Sound Select
	32. Mute Function
	32. Hold Function
	32. Flash Function
	33. Intercom
	34. H a n d s f r e e and Base Speakerphone Operation
	34. Line in Use Indication
	34. Low Battery Indication
	34. Message Waiting Indication
	35. Conference Calling
	35. Transferring Calls
14. Basic Operation	36. Additional Information
14. Handset and Base Indicators	36. Headset Operation
14. Handset Icons	36. Belt Clip
15. Handset LEDs	37. Maintenance
15. Base Unit Icons	38. In Case Of Difficulty
15. Base LEDs	40. Warranty Statement
16. Soft Menu Functions	42. FCC, ACTA and IC Regulations
16. REDIAL	45. The RBRC® Seal
18. Handset Menu	46. Technical Specifications
18. Base Unit Menu	
18. Set Time	
19. Clock Mode	
19. Calls Log (Caller ID)	
22. Handset Settings	
22. Ringer Volume	
22. Ringer Melody	
22. Vibrate Control	
22. Low Batt Tone	
22. Range Tone	
23. Keypad Tone	
23. Contrast	
23. Language	

Index

Answering Calls	30	Range Tone	22
Base Unit		Redial	16
Layout	6	Registration	12, 23
Indicators	15	Ringer	
Settings	24	Volume	22, 24
Menu	18	Melody	22, 24
Battery Pack		Saving Redial Numbers in Memory	17
Installation	8	Setup	
Charging.....	8	Base and Handset	7
Recycling (RBRC)	45	VT5820 Accessory Handset ...	12
Calls Log (Caller ID)	19	Soft Menu Functions	16
Deleting CID	21	Sound Select	31
Dialing from CID	20	Speakerphone	
Save to Memory	21	Handset (Handsfree)	34
Clock Mode	19	Base	34
Setting the Time	18	Store a Name/Number in Memory	27
Conference Calling	35	Transferring Calls	35
Contrast	23, 25	Technical Specifications	46
Deleting Names/Numbers		Tone/Pulse Selection	25
from Memory	28	Vibrate Control	22
Dialing from Memory	28	Wall Mounting	11
Edit a Number	29	Warranty Statement	40
Erasing Numbers in Redial	17		
FCC/IC/ACTA Regulations	42		
Flash	32		
Handset			
Layout	5		
Indicators and Icons	14		
Menu	18		
Settings	22		
Headset Operation	36		
Hold	32		
In Case of Difficulty	38		
Intercom/Page	33		
Keypad Tone	23, 25		
Language	23, 25		
Line in Use Indication	34		
Low Battery Tone	22		
Maintenance	37		
Making Calls	30		
Memory	26		
Message Waiting	34		
Mute	32		
Parts Check List	4		
Power Backup	10		

vtech

VTECH TELECOMMUNICATIONS LTD.

vtech

A member of THE VTECH GROUP OF COMPANIES.

Distributed in the U.S.A. by VTech Communications Inc. Beaverton, Oregon,
97008

Distributed in Canada by VTech Electronics Canada Ltd. 7671 Alderbridge
Way, Richmond, B.C. V6X 1Z9.

Copyright 2002 for VTECH TELECOMMUNICATIONS LTD.
Printed in China

91-5826-30-00
ISSUE 0

Free Manuals Download Website

<http://myh66.com>

<http://usermanuals.us>

<http://www.somanuals.com>

<http://www.4manuals.cc>

<http://www.manual-lib.com>

<http://www.404manual.com>

<http://www.luxmanual.com>

<http://aubethermostatmanual.com>

Golf course search by state

<http://golfingnear.com>

Email search by domain

<http://emailbydomain.com>

Auto manuals search

<http://auto.somanuals.com>

TV manuals search

<http://tv.somanuals.com>