



# User's Manual

[www.vtechphones.com](http://www.vtechphones.com)



Model: VT5875

Download from [www.Somanuals.com](http://www.Somanuals.com). All Manuals Search And Download.

**5.8**  
GHz  
Digital Spread  
Spectrum

# Table of contents

<b>Getting started</b> . . . . .	<b>3</b>	Mute . . . . .	15
Before you begin . . . . .	3	Conference call . . . . .	15
Parts checklist . . . . .	3	Volume control . . . . .	16
Installation . . . . .	4	Transferring calls. . . . .	16
Choose location . . . . .	4	Intercom call . . . . .	17
Install handset battery . . . . .	4	Call forward . . . . .	18
Power guard/spare battery charger feature . . . . .	5	Handset locator . . . . .	18
Connect power to telephone base/handset chargers .	6	Headset . . . . .	19
Connect to phone line . . . . .	6	Operating range . . . . .	19
Wall mounting . . . . .	7	Handset display screen messages . . . . .	20
Charge the handset battery . . . . .	8	Base display screen messages . . . . .	22
Check for dial tone . . . . .	8	Telephone settings . . . . .	23
Belt clip . . . . .	8	Ringer volume . . . . .	23
To register your accessory handsets . . . . .	9	Ringer tone. . . . .	23
Re-register existing handsets to a new base . . . . .	9	Key tone . . . . .	24
De-register all system handsets . . . . .	9	Language . . . . .	24
Registration . . . . .	9	Dial type . . . . .	24
<b>Basic operation</b> . . . . .	<b>10</b>	Telephone directory . . . . .	25
Handset and base indicators. . . . .	10	Storing a new entry . . . . .	25
Handset display . . . . .	10	Review/dial from the phonebook. . . . .	26
Base display . . . . .	11	Edit a phonebook entry . . . . .	27
Handset layout . . . . .	12	Delete a phonebook entry . . . . .	27
Base unit layout. . . . .	13	Caller ID . . . . .	28
Telephone operation . . . . .	14	Shared call log . . . . .	28
Making calls . . . . .	14	About call history (caller ID) . . . . .	29
Answering calls . . . . .	14	Review call history. . . . .	29
Flash . . . . .	15	Delete records from call history . . . . .	29
Redial . . . . .	15	Delete a specific call . . . . .	29

# Table of contents

Delete all calls . . . . .	29	Important safety instructions . . . . .	47
Dial a displayed number . . . . .	29	FCC, ACTA and IC regulations . . . . .	48
Store a call history record in the directory . . . . .	30	The RBRC® seal . . . . .	49
Voice mail . . . . .	31	Technical specifications . . . . .	50
Access voicemail . . . . .	31	Index . . . . .	51
Clear voicemail . . . . .	31		
Program the voicemail access keys . . . . .	31		
Program password . . . . .	32		
Program the VOICEMAIL key . . . . .	32		
Program the PLAY key . . . . .	32		
Program the SKIP key . . . . .	33		
Program the ERASE key . . . . .	33		
Reset all codes . . . . .	33		
Custom pay-per-use (PPU) features . . . . .	34		
PPU keys on base . . . . .	34		
PPU keys on handset . . . . .	34		
Change PPU key setting . . . . .	35		
Change auto call back number . . . . .	35		
Change three-way calling number . . . . .	36		
Change repeat dialing number . . . . .	36		
Reset all codes . . . . .	36		
Batteries . . . . .	37		
Battery care and maintenance . . . . .	37		
Replacing the handset battery . . . . .	37		
<b>Additional information . . . . .</b>	<b>38</b>		
Troubleshooting . . . . .	38		
Maintenance . . . . .	45		
Warranty . . . . .	45		

## Before you begin

### Parts checklist

1. Handset
2. Base unit
3. Charger
4. Battery
5. Telephone line cord
6. Belt clip
7. Base wall mounting bracket
8. AC power adapter
9. Charger power adapter
10. User's manual

To purchase replacement batteries, visit us on the web at [www.vtechphones.com](http://www.vtechphones.com) or call VTech Communications, Inc. at 1-800-595-9511. In Canada, contact VTech Telecommunications Canada Ltd. at [www.vtechcanada.com](http://www.vtechcanada.com) or 1-800-267-7377.



Handset

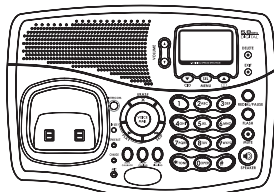

Base unit



Charger

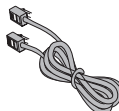

Battery

Telephone  
line cord

Belt clip

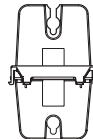
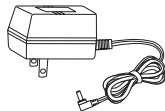
Base wall mounting  
bracket

Ac power adapter

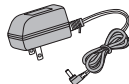
Charger  
power adapter

User's manual

### note

- Important!  
Before using this telephone, you must read the important safety instructions on page 47.

## note

- Use only the VTech battery pack supplied with your phone.
- Place the handset in its telephone base when not in use to ensure optimum performance.

**CAUTION:** To reduce the risk of fire or injury, read and follow these instructions:

1. Use only the battery supplied, or equivalent
2. Do not open or mutilate the battery. Released electrolyte is corrosive and may cause damage to the eyes or skin. It may be toxic if swallowed.
3. Exercise care in handling battery in order not to short the battery with conducting materials such as rings, bracelets, and keys. The battery or conductor may overheat and cause burns.

## Installation

### Choose location

For maximum performance of your cordless telephone system:

1. Choose a central location for your base unit.
2. Install your phone(s) as far away as possible from any other cordless (wireless) devices such as cordless telephones, 802.11 wireless routers (for example, WiFi), etc.
3. Install your phone(s) as far away as possible from other electronic equipment such as microwave ovens, televisions, computers, etc.
4. Install your telephone equipment away from heat sources and sunlight.
5. Avoid excessive moisture, dust or extreme cold.

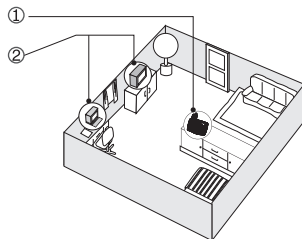

### Install handset battery

- a) Align the two holes in the plug with the socket pins, then snap the plug into place.
- b) Place the battery in the compartment.
- c) Replace cover by sliding it up into place.
- d) Place the handset in its base when not in use to ensure maximum daily performance.
- e) Be sure to charge the battery for a minimum of 16 hours before using your phone.

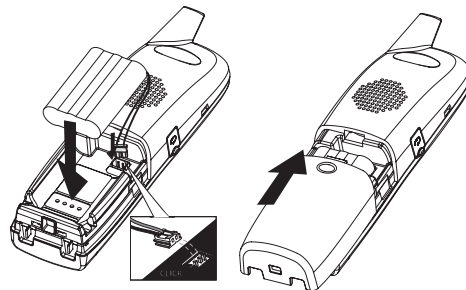

## Installation

### Power guard/spare battery charger feature

Your phone can use the spare battery in the base unit to provide operational backup in the event of a power failure. With a fully charged battery in the spare battery charger, you will still be able to place and receive calls from the handset for up to 1.5 hours.

The spare battery can also be used to replace a drained handset battery, ensuring uninterrupted use. A spare battery can be purchased from most retail stores that carry electronic equipment.

1. Open the spare battery compartment by pressing the lever on the cover as shown in diagram one. Then pull the compartment cover up, as shown in diagram two.
2. Align the two holes in the plug with the socket pins, then snap the plug into place. Place the battery in the charger as shown in the diagram below.
3. Replace the spare battery compartment cover. The spare battery takes 16 hours to fully charge a drained battery.

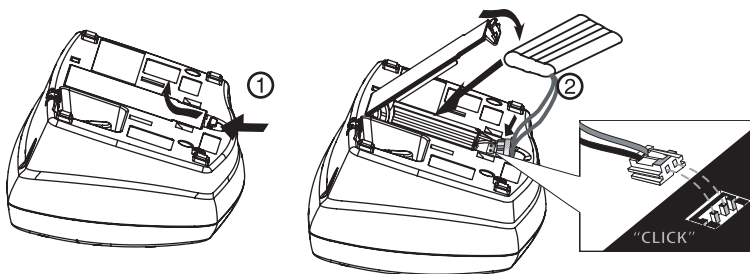

[www.vtechphones.com](http://www.vtechphones.com)

### note

- When using the phone during power backup mode, audio quality may be compromised due to reduced power availability.

## note

**Caution:** Use only the VTech power supply provided with your phone.

## Installation

### Connect power to telephone base/handset chargers

1. Plug the power adapter into an electrical outlet not controlled by a wall switch, and the connector into the bottom of the telephone base.
2. Choose the location for your charger, and plug its power supply into an electrical outlet.

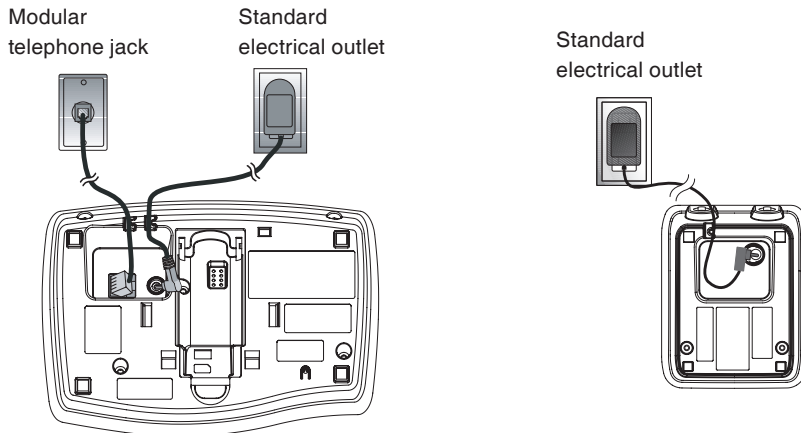

### Connect to phone line

Plug one end of the telephone line cord into the jack at the bottom of the telephone base, Then plug the other end of the cord into the wall outlet.

# Installation

## Wall mounting

Your phone base unit is designed to mount on a standard telephone wall plate. Wall mounting is optional.

1. Run the power and telephone line cords through the slots in the bracket, connecting them to the jacks located on the underside of the base.
2. Plug the adapter into an electrical outlet, and the connector to the bottom of the base unit.
3. Connect the telephone line cord to the jack at the bottom of the base unit, and the other end to the wall jack.
4. Line up the tabs on the wall mount adapters with the holes at the bottom of the base unit. Snap the wall mount bracket firmly in place.
5. Mount the base unit on the wall. Position the base unit so the mounting studs will fit into the holes on the wall mount bracket. Slide base unit down on the mounting studs until it locks into place.

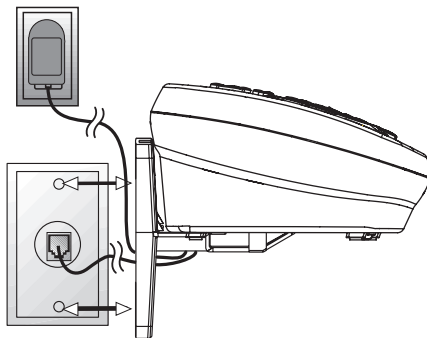

[www.vtechphones.com](http://www.vtechphones.com)



## note

- Your phone contains an internal noise filter (for DSL subscribers). This means, if you subscribe to DSL service, you shouldn't experience interference or noise when using your phone due to your DSL service.

## Installation

### Charge the handset battery

Place the handset in the base. Be sure to charge the battery for at least 16 hours before using your phone.

### Check for dial tone

After the batteries are charged, pick up the handset and press **ON**; you should hear a dial tone. If you do not, try this phone in another phone jack.

### Belt clip (optional)

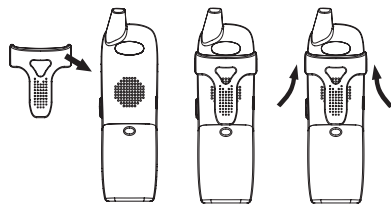

To attach

To remove

## Registration

Your phone can operate up to four handsets. To order additional handsets call the supplier.

### To register your accessory handsets

1. After charging the battery, the screen will display:
2. On the base unit, press **MENU/SEL**, then scroll to **DISPLAY BASE ID**, press **MENU/SEL**.
3. Enter the 15 digit base unit ID code, If you make a mistake, press the **DELETE/MUTE** key to backspace (delete characters), then enter the correct information.
4. Press **MENU/SELECT** to complete the registration process.
5. Once a valid base ID code has been entered, the display will blank for a second or two, and then show:
6. If the base accepts the new handset, after several seconds the new handset will show:

Where **X** is the new handset number assigned, sequentially, by the base.

### Re-register existing handsets to a new base

1. Install your new base unit, the handset(s) will display **SEARCHING...**, press and hold the **MENU/SELECT** button for two seconds.
2. The handset will display:
3. Follow steps 2 through 6 in **To register your accessory handsets** above.

### De-register all system handsets

1. With the phone in idle, press **\*883244#** on the base.
2. Then press **MENU/SEL**, **IN USE** and **CHARGE**, the **POWER LED** will illuminate briefly before returning to idle.
3. This will erase all handsets registered to the base. The handsets will now prompt you to:
4. Re-register the handset(s) to base by following steps 2 through 6 in **To register your accessory handsets** above.



ENTER BASE ID  
#####



SEARCHING...



HANDSET X



ENTER BASE ID  
#####



ENTER BASE ID  
#####



## note

- The 15-digit base ID code may contain numbers and characters, including 0 through 9 and \*. Make sure you enter all 15 digits.
- If you do not enter the correct digit sequence, you will hear an error tone. Press **DELETE/MUTE** key to backspace to erase a character(s) and carefully re-enter the base ID code.
- De-registering all system handsets will prevent any handset from placing calls until the handset is re-register to the base.

[www.vtechphones.com](http://www.vtechphones.com)



## Handset and base indicators

### Handset display

Icon	Description
<b>MUTE</b>	Turns on when the microphone is muted.
<b>NEW</b>	Turns on when there are new call log entries.
	Turns on when the ringer is muted.
	Low battery indicator and charging indicator.
	LED is on when in handsfree mode.
<b>VOICEMAIL</b>	On when new voicemail is detected. Service must be subscribed through your local telephone company.

## Handset and base indicators

### Base display

Icon	Description
MUTE	<ul style="list-style-type: none"><li>• MUTE turns on when the microphone is muted.</li><li>• LED is on when microphone is muted</li></ul>
NEW	Turns on when there are new call log entries.
	Turns on when the ringer is muted.
	Displays when spare battery is charging in the base unit.
IN USE	On when the phone is off hook.
CHARGE	On when the handset is charging in the base.
VOICEMAIL	On when new voicemail is detected. Service must be subscribed through your local telephone company.
	LED is on when base speakerphone is in use.
SPARE BATT	<ul style="list-style-type: none"><li>• LED flashes when the base is operating on spare battery power.</li><li>• LED is on when a spare battery is charging and the power adapter is plugged into the base.</li></ul>

### note

- In the event of a power failure, if a spare battery is charging in the base, the base will go into backup mode and use the spare battery for power.

## Handset layout

1. Antenna
2. CID ▼
3. Redial/pause
4. On/flash
5. Dialing key (0 - 9, \*, #)
6. Voicemail
7. Play ▶
8. Skip ▶▶
9. Menu/select
10. ◻◻ ▲
11. Speaker
12. Mute/delete
13. Off/clear
14. Billed services
15. Intercom
16. Erase X

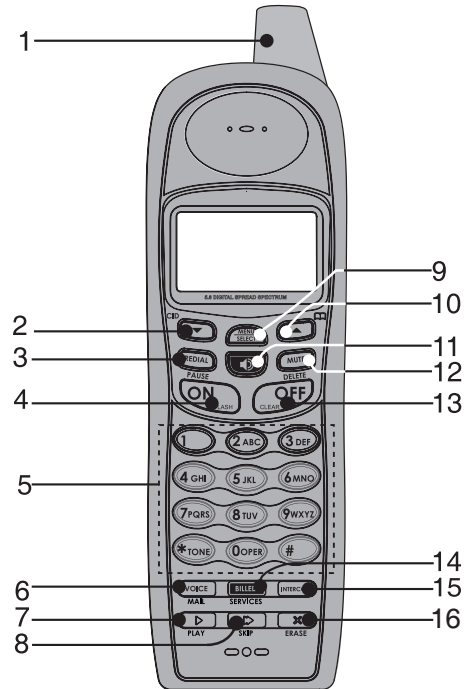

## Base unit layout

1. Intercom
2. In use
3. Spare battery
4. Charge
5. Microphone
6. Auto call back
7. Three-way calling
8. Repeat dialing
9. Number keys
10. Speaker
11. Mute
12. Flash
13. Redial/pause
14. CID ▼
15. EXIT
16. Delete
17.  ▲
18. Menu/select
19. Skip ►
20. Volume
21. Erase
22. Voicemail
23. Play ►

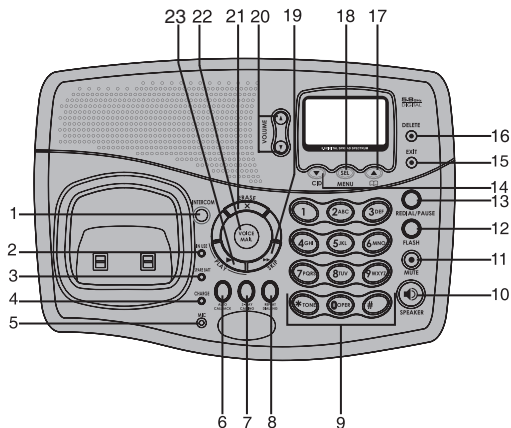

## Telephone operation

### Making calls

#### From the handset:

Press **ON** (or, **SPEAKER** (  )) to use the handset speakerphone feature). Dial the phone number.

**-OR-**

Dial the phone number first; then press **ON** or **SPEAKER** (  ).

As you are entering numbers, press **DELETE/MUTE** or **OFF/CLEAR** to backspace and make corrections, or press and hold **PAUSE** to enter a three second dialing pause. Press **OFF** to end your call.

#### From the base unit

- Press **SPEAKER** (  ). Dial the phone number.

**-OR-**

Enter the phone number first; then press **SPEAKER** (  )

As you are entering numbers, press **DELETE** or **EXIT** to backspace and make corrections, or press and hold **PAUSE** to enter a three second dialing pause.



- Press **SPEAKER** (  ) to end your call.

### Answering calls

#### From the handset

- Press **ON**, **SPEAKER** or any of the number keys.
- Press **OFF** to end your call.

#### From the base unit

- Press **SPEAKER** (  ) or any of the dialing keys (0-9, \*, #).
- Press **SPEAKER** (  ) to end your call.

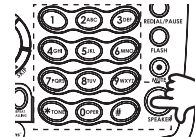
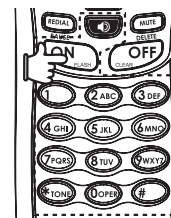
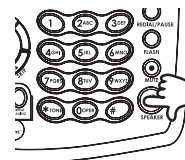
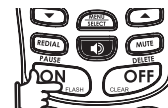

## Telephone operation

### Flash function

You can use your phone with services such as call waiting. When you receive a call waiting signal, simply press the **FLASH** key to switch to the new call. Press **FLASH** again to switch back to the original call.

### Redial function

- Press **REDIAL** to display the last telephone number dialed from the handset or base unit (up to 32 digits). Use **▲** or **▼** to scroll through the five previously dialed numbers.  
When the beginning or the end of the redial list is reached, a double beep will sound.
- When the desired number is reached, press **ON** or **SPEAKER** (🔊) to dial.
- Press **DELETE/MUTE** on the handset (or **DELETE** on the base) to delete the number from the redial memory.
- Press **OFF/CLEAR** on the handset (or **EXIT** on the base) to exit the redial review list.

### Mute function

- During an active call, press the **MUTE** key on handset or base unit to disable the microphone. The screen will display:
- Press **MUTE** again to return to normal two way conversation.  
**MICROPHONE ON** will display briefly.

```
PHONE 00:00:25
MICROPHONE MUTED
MUTE
```

### Conference call

Your phone is capable of supporting conference calls between system handsets or base. It is possible to establish a conference between any two handsets (or a handset and the base) and the external line.

If a handset or base already has a connection to the external line, and any other handset or base goes off-hook, a conference is immediately established. The handsets will show:

```
PHONE 00:00:25
```

### note

- Use **FLASH** to access other phone company subscriber services, as described by your provider.
- To end a conference call, press **OFF** at the handset or **🔊** on the base. The conference call will not be terminated until all handsets or base unit have disconnected from the call.





## note

- If the returned call is not answered within 30 seconds, the external call will end automatically.
- While in transfer mode (before releasing the call) you may toggle back and forth between the external call (the display will show **OUTSIDE**) and the intercom call (the display will show **INTERCOM**) by pressing the **INTERCOM** key.

## Telephone operation

### Volume control

Press the **VOLUME** button  on the handset or press the **VOLUME** button  on the base to adjust listening volume. Each button press raises or lowers volume by one level. When you change the volume level, the new setting is saved. The new volume level will be applied each time you use the handset, speakerphone or headset.

### Transferring calls

You can transfer calls between the base and any handsets registered to it.

While you are on an external call, using transfer allows you to speak to the person who answers at the base or handset you are calling before releasing the external call to them.

- Press **INTERCOM** key on the handset or base, it will display:
- Select the number of the handset to which the call is to be transferred 1-4 or 0 for base. For example if you intercom handset 2 the display will show:
- Press **ON**, **SPEAKER** or **INTERCOM** on the handset or base being called to answer the intercom call. You may now discuss the external call with the person who answered the other handset or base.
- On the handset, press the **OFF** key to transfer the external call to the other handset or base. (If transferring from the base, press **SPEAKER** to transfer.)

TRANSFER TO:

CALLING  
HANDSET 2

HANDSET 1  
IS CALLING

CALL TRANSFERRED

# Telephone operation

## Intercom call

You can intercom between the base and any handsets registered to it.

- From the idle (off) mode, press **INTERCOM**. The handset will display:
- Select a number of the handset to be called (1-4 or 0 for base). For example if you intercom the base the display will show:
- Press **INTERCOM, ON** or **SPEAKER** (  ) on the handset (or base) to answer the intercom call. The screens will display:
- Press **INTERCOM, OFF/CLEAR** on the handset (or **EXIT** on the base) to end the call

If the handset/base you are attempting to intercom is out of range, or on an external call, the display will show:

INTERCOM TO:

CALLING  
BASE

INTERCOM

UNABLE TO CALL  
TRY AGAIN

## Telephone operation

### Call forward

You can forward calls between the base and any handsets registered to it.

- A handset on an external call can forward it to any other handset or base.

- Press and hold the **INTERCOM** key on the handset, it will display:

FORWARD TO:

- Enter the handset number you wish to forward to or 0 for base.  
The handset will display:

CALL FORWARD

- At the handset or base press **ON**, **SPEAKER** or any of the dialing keys (0-9, \*, #) to answer the call.

If the handset or base being called does not respond in about one minute, the external call will be returned to originating handset or base and the display will show:

CALL BACK

### Handset locator

- From the idle (off) mode, press **MENU/SEL** on the base unit, then use **▲** or **▼** key to scroll to **HANDSET LOCATOR**.

> HANDSET LOCATOR  
DISPLAY BASE ID

- Press **MENU/SEL**, display will show:

PAGING  
ALL HANDSETS

- To end the page, press **ON**, **SPEAKER**, or any dial pad key (0-9,\*,#) on the handset, or press **MENU/SEL** or **EXIT** on the base.



# Telephone operation

## Handset display screen messages

Screen displays:	When:
PHONE	The handset is in use.
ENDED	The handset is on hook.
NO ENTRIES	You are accessing an empty directory or call log.
LIST FULL	You are saving to a full directory.
MICROPHONE MUTED	The call is on mute.
SPEAKER	The handset speakerphone is in use.
LOW BATTERY	The battery needs to be recharged.
INCOMING CALL	There is a call coming in.
NEW VOICE MAIL	There are new voicemail messages.
X NEW CALLS	There are new calls in the call log.
SEARCHING...	The handset has lost communication with the base.
BASE IS PAGING	The base is paging handset(s).
BASE IS CALLING	The base is calling.
CALLING HANDSET X	Calling another handset.

# Telephone operation

## Handset display screen messages

Screen displays:	When:
CALLING BASE	Calling the base.
HANDSET X IS CALLING	Other handset is calling.
LINE IN USE	An extension phone is in use.
NO LINE	There is no telephone line connected.
ALREADY SAVED	The telephone number you have entered is already stored in the directory.
SAVED	Your operation is successful.
WARNING CHECK BATTERY!	<ul style="list-style-type: none"><li>• The battery is not installed properly in the handset.</li><li>-OR-</li><li>• The battery needs to be replaced.</li><li>-OR-</li><li>• An incorrect battery has been installed by mistake.</li></ul>
PLACE IN CHARGER	The battery is very low. The handset should be placed in the base unit or charger.
CHARGING	A handset with a low battery has been placed in the base unit or charger.

## Telephone operation

### Base display screen messages

Screen displays:	When:
SPEAKER	The speakerphone is in use.
ENDED	The speakerphone is on hook.
NO ENTRIES	You are accessing an empty directory or call log.
LIST FULL	The directory is full, no new data can be saved.
MICROPHONE MUTED	The call is on mute.
INCOMING CALL	There is a call come in.
PAGING ALL HANDSETS	The base is paging handset(s)
CALLING HANDSET X	Calling a handset.
LINE IN USE	An extension phone is in use.
NO LINE	There is no telephone line connected
ALREADY SAVED	The telephone number you have entered is already stored in the directory.
NEW VOICE MAIL	There are new voicemail messages.
X NEW CALLS	There are new calls in the call log
HANDSET X CALLING	One of the cordless handsets is calling.
SAVED	Your operation is successful.

## Telephone settings

### Ringer volume

- From the idle (off) mode, press **MENU/SELECT** on the handset (or **MENU/SEL** on the base) then the **▲** or **▼** key to **RINGER VOLUME**.

```
> RINGER VOLUME
  RINGER TONE
```

- Press **MENU/SELECT** on the handset (or **MENU/SEL** on the base). The current ringer volume will be shown:

```
RINGER VOLUME
|||||
```

- Press the **▲** or **▼** keys or enter a digit (0 through 6) to the desired volume. The current ring tone is played. At the lowest setting, display will show:

The handset or base will not ring when a call comes in if ringer volume is set to the lowest setting.

```
RINGER VOLUME
                                     🔔
```

- Press **MENU/SELECT** on the handset (or **MENU/SEL** on the base).

### Ringer tone

- From the idle (off) mode, press **MENU/SELECT** on the handset (or **MENU/SEL** on the base) then the **▲** or **▼** keys to **RINGER TONE**.
- Press **MENU/SELECT** on the handset (or **MENU/SEL** on the base).
- Press the **▲** or **▼** keys (or enter a digit 0 through 9) to sample the ring tones. The screen will show:
- Press **MENU/SELECT** on the handset (or **MENU/SEL** on the base).

```
> RINGER TONE
  KEY TONE
```

```
RINGER TONE
1
```

### note

- Settings for the handset and the base must be programmed separately. For example, when you set the ringer volume for the handset, it will not automatically set in the base.



## note

- When the phone is set for pulse dial mode, it is possible to switch to temporary tone mode during an ongoing call by pressing \*. Once pressed, tone will be used for rest of the call. After you hang up, the phone will return to pulse dialing for the next call.

## Telephone settings

### Key tone (preset to on)

- From the idle (off) mode, press **MENU/SELECT** on the handset (or **MENU/SEL** on the base) then the **▲** or **▼** keys to select **KEY TONE**.
- Press **MENU/SELECT** on the handset (or **MENU/SEL** on the base). The current setting will be shown. Use the **▲** or **▼** keys to scroll to **ON** or **OFF**. When set to on, the handset will emit a beep whenever a key is pressed.
- When the desired option is shown, press **MENU/SELECT** on the handset (or **MENU/SEL** on the base).

```
> KEY TONE  
LANGUAGE
```

```
KEY TONE  
ON
```

### Language (preset to English)

- From the idle (off) mode, press **MENU/SELECT** on the handset (or **MENU/SEL** on the base) then the **▲** or **▼** keys to **LANGUAGE**.
- Press **MENU/SELECT** on the handset (or **MENU/SEL** on the base). Press the **▲** or **▼** keys to scroll from English to French or Spanish.
- Press **MENU/SELECT** on the handset (or **MENU/SEL** on the base).

```
> LANGUAGE  
CLR VOICE MAIL
```

```
LANGUAGE  
ENGLISH
```

### Dial type (preset to tone)

- From the idle (off) mode, press **MENU/SELECT** on the handset (or **MENU/SEL** on the base) then **▲** or **▼** keys to **DIAL TYPE**.
- Press **MENU/SELECT** on the handset (or **MENU/SEL** on the base) then use **▲** or **▼** keys to scroll from **TONE** to **PULSE**.
- Press **MENU/SELECT** on the handset (or **MENU/SEL** on the base).

```
> DIAL TYPE  
PHONEBOOK
```

```
DIAL TYPE  
TONE
```

## note

- If you register additional handsets to your base, the handsets share a common phonebook, which is stored in the base. This means that entries inserted by a handset or base unit are available for all handsets and the base unit, and if one deletes a phonebook entry, it will disappear from all handsets and base unit.

## Telephone directory

Your phone can store up to 50 numbers with names in memory. Each memory location can hold up to 32 digits for the number and 16 characters for the name.

### Storing a new entry

- Press **MENU/SELECT** on the handset (or **MENU/SEL** on the base).
- With **PHONEBOOK** highlighted, press **MENU/SELECT** on the handset (or **MENU/SEL** on the base).
- Press **▲** or **▼** to select **STORE**. Press **MENU/SELECT** on the handset (or **MENU/SEL** on the base).
- You will be prompted to **ENTER NUMBER**.

Use the dialing keys to enter the number you wish to store in the phonebook. Press the **DELETE/MUTE** on the handset (or **DELETE** on the base) to backspace and make corrections. Press **MENU/SELECT** on the handset (or **MENU/SEL** on the base).

- You will then be prompted to **ENTER NAME**. Use the dialing keys to spell the name. Use the **▲** and **▼** keys to move the cursor. Press **DELETE/MUTE** on the handset (or **DELETE** on the base) to backspace and make corrections. Press **MENU/SELECT** on the handset (or **MENU/SEL** on the base).
- You'll hear a confirmation tone, and the new phonebook entry will be displayed.
- If the phonebook is full, the handset or base unit will display:
- You can also press **REDIAL** then **▲** or **▼** keys to scroll to the previously dialed number from the redial list you want to store in the phonebook. Press **MENU/SELECT** on the handset (or **MENU/SEL** on the base).
- While entering numbers, press and hold **PAUSE** to add pauses if necessary.
- If there is a duplicate number in the phonebook, the display will show:

```
> STORE
REVIEW
```

```
ENTER NUMBER
555-123-4567_
```

```
ENTER NAME
_
```

```
LIST FULL
```

```
ALREADY SAVED
```

## Telephone directory

Each press of a particular key causes characters to be displayed in the following order:

Key	Character versus # of key presses								
	1	2	3	4	5	6	7	8	9
1	1	#	'	,	-	.	&		
2	A	B	C	2	a	b	c		
3	D	E	F	3	d	e	f		
4	G	H	I	4	g	h	i		
5	J	K	L	5	j	k	l		
6	M	N	O	6	m	n	o		
7	P	Q	R	S	7	p	q	r	s
8	T	U	V	8	t	u	v		
9	W	X	Y	Z	9	w	x	y	z
0	0								
*	*	?	!	/	(	)	@		
#	space								

### Review/dial from the phonebook

- Press **MENU/SELECT** on the handset (or **MENU/SEL** on the base). With **PHONEBOOK** highlighted, press **MENU/SELECT** on the handset (or **MENU/SEL** on the base). With the **REVIEW** highlighted, press **MENU/SELECT** on the handset (or **MENU/SEL** on the base).

- OR -

With the handset or base unit in idle, press ▲, the handset or base unit goes directly into phonebook review mode.

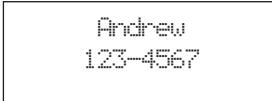

Andrew  
123-4567

## Telephone directory

- Scroll through the phonebook entries using the ▲ and ▼ keys or enter first character of the name to be searched (using the digit keys) and continue navigating using the ▲ or ▼ keys as scroll keys, until you reach the entry to be dialed.
- Press **ON** or **SPEAKER** (  ), to dial the number.

```
Andrew Smith
555-123-4567
```

```
PHONE 00:00:10
Andrew Smith
```

### Edit a phonebook entry

- Follow the first two steps in **Review/dial from the phonebook** (page 26) to reach the entry to be edited.
- Press **MENU/SELECT** on the handset (or **MENU/SEL** on the base).
- Press **DELETE/MUTE** on the handset (or **DELETE** on the base) to backspace then enter the correct number. Press and hold **PAUSE** to add pauses if necessary. You can also press **REDIAL**, then the ▲ or ▼ keys to scroll to the previously dialed number from redial list you want to store in the phonebook. Press **MENU/SELECT** on the handset (or **MENU/SEL** on the base).
- Press **MENU/SELECT** on the handset (or **MENU/SEL** on the base).
- You are now prompted to **EDIT NAME**. Press **DELETE/MUTE** on the handset (or **DELETE** on the base) to backspace, then use the dialing keys to enter the correct name (see page 26). Use the ▲ and ▼ keys to move the cursor.
- Press **MENU/SELECT** on the handset (or **MENU/SEL** on the base). A confirmation tone will sound.

```
Andrew Smith
555-123-4567
```

```
EDIT NAME
Andrew
```

```
Andrew Smith
555-123-4567
```

### Delete a phonebook entry

- Follow the first two steps in **Review/dial from the phonebook**.
- Press **DELETE/MUTE** on the handset (or **DELETE** on the base). A confirmation tone will sound.
- The handset or base will then move to the next entry if any.

## note

- When reviewing the phonebook, the second line of the display will show the phone number, up to 16 digits. For numbers longer than 16 digits, only the first 13 digits will be shown. Press \* or # to scroll the phone number to see the additional digits.
- If there are no entries in the phonebook, when it is accessed, **NO ENTRIES** will display.

## Caller ID

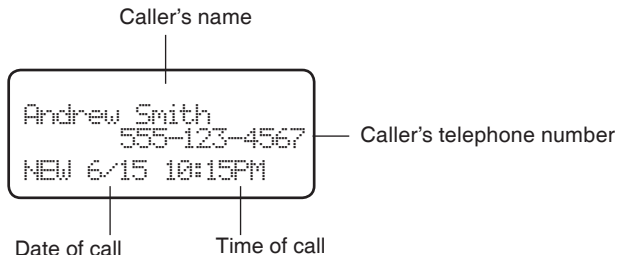

### Shared call log

The caller ID log is stored in the base, and is shared by the system handsets. Changes made at the base or a handset will be reflected in all handsets and the base.

If the number of an incoming call matches an entry in your directory, the name will display exactly how you've entered it in the phonebook. For example, if Christine Smith calls, her name will appear as Chris if that is how you entered it into the phonebook.

Your phone has a caller ID (CID) with call waiting feature that works with service from your local phone service provider. Caller ID with call waiting lets you see who's calling before you answer the phone, even when you're on another call.

You may need to change your phone service to use this feature. Contact your service provider if:

- You have both caller ID and call waiting, but as separate services (you may need combined service).
- You have only caller ID service, or only caller waiting service.
- You don't subscribe to any caller ID or call waiting services.

You can use this product with regular caller ID service, and you can use this product's other features without subscribing to either caller ID or combined caller ID with call waiting service.

There are fees for caller ID services, and they may not be available in all areas.

This product can provide information only if both you and the caller are in areas offering caller ID service, and if both telephone companies use compatible equipment.

## Caller ID

### About call history (caller ID)

Your phone can store up to 50 calls in its caller ID memory. When the memory is full, the oldest call will be deleted to make room for new incoming call information. For each call that comes in, the screen displays the following information between the first and second rings:

- Your caller's name (15 letters are sent by your telephone company).
- The caller's area code and telephone number.
- The time and date of the call.

```
Andrew Smith
555-123-4567
NEW 6/15 10:15PM
```

### Review call history

1. Press ▼ (CID) to view call history.
2. Use ▲ and ▼ to scroll through records in call history.

### Delete records from call history

#### Delete a specific call:

1. Locate the record you want to delete from call history.
2. Press **DELETE/MUTE** on the handset (or **DELETE** on the base). You'll hear a confirmation beep.

#### Delete all calls:

1. With the handset in call log mode, press and hold **DELETE/MUTE** on the handset (or **DELETE** on the base). The screen displays:
2. Press **MENU/SELECT** on the handset (or **MENU/SEL** on the base). You'll hear a confirmation beep.

```
DELETE ALL
CALLS?
```

### Dial a displayed number

1. Locate the record in call history that you want to dial.
2. If you wish to change how the number is dialed, press #. The screen displays alternate dialing sequences available for this call.

When the number is correctly displayed for dialing, press **ON** or **SPEAKER**.

## note

- If you answer a call before the caller ID information appears on the screen, it will not be in the call history.

## note

- Press **OFF/CLEAR** on the handset(s) (or **EXIT** on the base) at any time to exit call history.
- If both the name and number are not provided, **UNABLE TO SAVE** will be displayed.

## Caller ID

### Store a call history record in the directory

1. Locate the record in the call history you want to store in the directory.
2. If you wish to change how the number is stored, press **#**. The screen displays alternate dialing sequences available for this call.
3. Press **MENU/SELECT** on the handset (or **MENU/SEL** on the base), You'll hear a confirmation beep.

Screen Displays:	When:
PRIVATE NUMBER	The other party is blocking name and/or number information.
UNKNOWN NUMBER	Your phone company is unable to receive information about this caller's name and/or number.

## VoiceMail

### Access voicemail

When a voicemail is detected, **VOICEMAIL** key will be illuminated and **NEW VOICEMAIL** will display on the handset and base.

Once your voicemail access number and password are programmed into your phone, you can quickly retrieve voicemail messages by pressing the **VOICEMAIL** key on the handset or base.

When retrieving voicemail messages, you can use the dedicated **PLAY**, **SKIP** and **ERASE** keys on the handset or base to access play, skip and erase messages functions.

### Clear voicemail

If you wish to manually turn off the voicemail indications on the handset and base, follow the below steps:

From the idle mode, press **MENU/SELECT** on the handset (or **MENU/SEL** on the base), then the **▲** or **▼** keys to **CLR VOICEMAIL**. Press **MENU/SELECT** on the handset (or **MENU/SEL** on the base), the screen will display **TURN INDICATOR OFF?** Press **MENU/SELECT** on the handset (or **MENU/SEL** on the base).

### Program the voicemail access keys

Your phone is factory programmed with the appropriate key sequences for **PLAY**, **SKIP**, **ERASE** and **VOICEMAIL** keys. If the default programming for these or password do not work with your voicemail system, you can reprogram them.

From the idle mode, press **MENU/SELECT** on the handset (or **MENU/SEL** on the base), use **▲** or **▼** to scroll to **FEATURE CODES**, then press **MENU/SELECT** on the handset (or **MENU/SEL** on the base). With **VOICEMAIL SETUP** displayed, press **MENU/SELECT** on the handset (or **MENU/SEL** on the base). Use **▲** or **▼** to scroll to your desired option, then press **MENU/SELECT** on the handset (or **MENU/SEL** on the base).

You can access the following options:

**ACCESS NUMBER    PASSWORD    PLAY    SKIP    ERASE    RESET ALL CODES**

[www.vtechphones.com](http://www.vtechphones.com)

### note

- In order to use these features, you must subscribe to and activate voicemail service through your local telephone company.
- When one handset is accessing the voicemail setup, the other handset(s) cannot access it at the same time. If this is attempted, **NOT AVAILABLE AT THIS TIME** will be displayed.



## Voicemail

### Program password

You need to program a password to access your voicemail. First, you must activate and define your voicemail password with the voicemail service provided by your local telephone company. Once you have defined your password, you can then program it into the phone.

Use ▲ or ▼ to scroll to **PASSWORD**, then press **MENU/SELECT** on the handset (or **MENU/SEL** on the base) to choose it. You will see the following display:

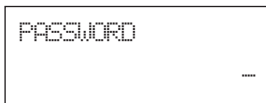

Use the number keys to enter the password number provided by your local telephone company. To enter pauses, press and hold **PAUSE**. Press **DELETE/MUTE** on the handset (or **DELETE** on the base) to erase numbers if you make a mistake. When finished press **MENU/SELECT** on the handset (or **MENU/SEL** on the base).

### Program the VOICEMAIL key

The default voicemail access number is \*98. If this does not match the number provided by your local telephone company, you will need to edit the number.

Use ▲ or ▼ to scroll to **ACCESS NUMBER**, then press **MENU/SELECT** on the handset (or **MENU/SEL** on the base). You see the following display:

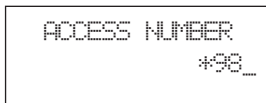

Press **DELETE/MUTE** on the handset (or **DELETE** on the base). Enter the new voicemail access number provided by your local telephone company. To enter pauses, press and hold **PAUSE**. When finished press **MENU/SELECT** on the handset (or **MENU/SEL** on the base).

### Program the PLAY key

The default **PLAY** key number is 1. If this does not match the number provided by your local telephone company, you will need to edit the number.

Use ▲ or ▼ to scroll to **PLAY**, then press **MENU/SELECT** on the handset (or **MENU/SEL** on the base). The display will show:



## Voice mail

Press **DELETE/MUTE** on the handset (or **DELETE** on the base). Enter the new number provided by your local telephone company. To enter pauses, press and hold **PAUSE**. When finished press **MENU/SELECT** on the handset (or **MENU/SEL** on the base).

### Program the SKIP key

The default **SKIP** key number is #. If this does not match the number provided by your local telephone company, you will need to edit the number.

Use **▲** or **▼** to scroll to **SKIP**, then press **MENU/SELECT** on the handset (or **MENU/SEL** on the base). You see the following display:

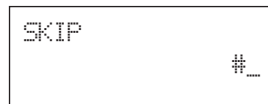

```
SKIP
#_
```

Press **DELETE/MUTE** on the handset (or **DELETE** on the base). Enter the new number provided by your local telephone company. To enter pauses, press and hold **PAUSE**. When finished press **MENU/SELECT** on the handset (or **MENU/SEL** on the base).

### Program the ERASE key

The default **ERASE** key number is 3. If this does not match the number provided by your local telephone company, you will need to edit the number.

Use **▲** or **▼** to scroll to **ERASE**, then press **MENU/SELECT** on the handset (or **MENU/SEL** on the base). You see the following display:

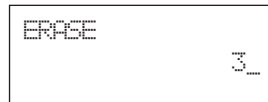

```
ERASE
3_
```

Press **DELETE/MUTE** on the handset (or **DELETE** on the base). Enter the new number provided by your local telephone company. To enter pauses, press and hold **PAUSE**. When finished press **MENU/SELECT** on the handset (or **MENU/SEL** on the base).

### Reset all codes

You can reset all voicemail codes to their default values.

Use to scroll to **RESET ALL CODES**, then press **MENU/SELECT** on the handset (or **MENU/SEL** on the base). You see the following display:

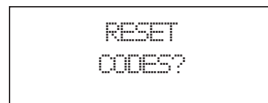

```
RESET
ALL
CODES?
```

Press **MENU/SELECT** on the handset (or **MENU/SEL** on the base).

## note

- Your local telephone company may provide a monthly subscription to an individual service or a package of services which gives you unlimited usage for a small monthly fee.

## Custom pay-per-use (PPU) features

### PPU keys on base

You can use the dedicated keys on the base unit to access below functions.

**Auto call back** dials the last party who called you, whether or not you answered the call. A charge is added to your phone bill each time you use this feature.

**Three-way calling** allows you to talk with two separate parties from a single line. To use this feature, follow these steps:

1. Call your first party, after the party answers,
2. Press **Three-way calling**. Wait for dial tone.
3. Call your second party, after the call is answered,
4. Press **Three-way calling** again.

A charge is added to your phone bill each time this service is used.

**Repeat dialing** repeatedly dials the last number you called, over a time interval determined by your local phone company. This is useful in reaching a party whose line is busy. A charge is added to your phone bill each time this service is used.

### PPU keys on handset

To access PPU features on the handsets:

- Press **ON**.
- Press **BILLED SERVICES** key, then use the ▲ or ▼ keys to scroll to your desired option.
- Press **MENU/SELECT** on the handset (or **MENU/SEL** on the base).

## Custom pay-per-use (PPU) features

### Change PPU key setting

Your phone is factory programmed with the PPU keys, you can reprogram the codes to the numbers provided by your local telephone company.

From the idle mode, press **MENU/SELECT** on the handset (or **MENU/SEL** on the base), use **▲** or **▼** to scroll to **FEATURE CODES**, then press **MENU/SELECT** on the handset (or **MENU/SEL** on the base). Press **▲** or **▼** to scroll to **BILLED SERVICES**, then press **MENU/SELECT** on the handset (or **MENU/SEL** on the base). Use **▲** or **▼** to scroll to your desired option, then press **MENU/SELECT** on the handset (or **MENU/SEL** on the base).

You can access the following options:

**Auto callback**

**Three-way calling**

**Repeat dialing**

**Reset all codes**

### Change auto call back number

The default **AUTO CALLBACK** number is \*69. If this does not match the number provided by your local telephone company, you will need to edit the number.

Use **▲** or **▼** to scroll to **AUTO CALLBACK**, then press **MENU/SELECT** on the handset (or **MENU/SEL** on the base). The display will show:



```
AUTO CALLBACK
*69 _
```

Press **DELETE/MUTE** on the handset (or **DELETE** on the base). Enter the new number provided by your local telephone company. To enter pauses, press and hold **PAUSE**. When finished press **MENU/SELECT** on the handset (or **MENU/SEL** on the base).

## Custom pay-per-use (PPU) features

### Change three-way calling number

The default three-way calling code is **F** (flash). If this does not match the number provided by your local telephone company, you will need to edit the number.

Use **▲** or **▼** to scroll to three-way calling, then press **MENU/SELECT** on the handset (or **MENU/SEL** on the base). You see the following display:

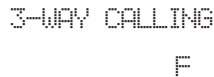

3-WAY CALLING  
F \_

Press **DELETE/MUTE** on the handset (or **DELETE** on the base). Enter the new number provided by your local telephone company. To enter pauses, press and hold **PAUSE**. When finished press **MENU/SELECT** on the handset (or **MENU/SEL** on the base).

### Change repeat dialing number

The default repeat dialing number is **\*66**. If this does not match the number provided by your local telephone company, you will need to edit the number.

Use **▲** or **▼** to scroll to **REPEAT DIALING**, then press **MENU/SELECT** on the handset (or **MENU/SEL** on the base). The display will show:

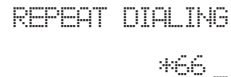

REPEAT DIALING  
\*66 \_

Press **DELETE/MUTE** on the handset (or **DELETE** on the base). Enter the new number provided by your local telephone company. To enter pauses, press and hold **PAUSE**. When finished press **MENU/SELECT** on the handset (or **MENU/SEL** on the base).

### Reset all codes

You can reset all PPU codes to their default values.

Use **▲** or **▼** to scroll to **RESET ALL CODES**, then press **MENU/SELECT** on the handset (or **MENU/SEL** on the base). You see the following display:



RESET  
CODES?

Press **MENU/SELECT** on the handset (or **MENU/SEL** on the base).

## Batteries

### Battery care and maintenance

After your battery is fully charged, you can expect the following performance:

Operation	Operating time
While in use (talking)	up to 8 hours
While not in use (standby*)	up to 4 days

\* Handset is off the base unit or charger but not in use.

- The battery needs charging when:
  - A new battery is installed in the handset.
  - The phone beeps twice every five seconds.
  - The screen displays **LOW BATTERY** and the low battery icon.
- Place the handset in the base so the **CHARGE** light turns on. The battery is typically fully charged in 16 hours.
- You can keep the battery fully charged by returning the handset to the base after each use

### Replacing the handset battery

1. Remove the battery compartment cover on the handset by pressing on the indentation and sliding the cover downward.
2. Lift out the old battery and disconnect.
3. Align the two holes in the new battery's plug with the socket pins, and snap the plug into place. Snap the battery in the compartment, as described in **Installation**, on page 4.
4. Replace the cover by sliding it up into place.
5. The new battery must be charged before using the phone. Place the handset in the base and allow it to charge for at least 16 hours the first charge. The telephone might operate before that, but for best performance, let the battery charge fully.

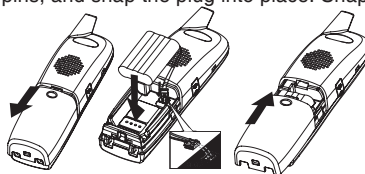

### note

- If you repeatedly get a low battery indicator, even after charging overnight, the battery should be replaced.
- To reduce the risk of fire or injury to persons or damage to the telephone, charge the battery provided with this phone (or equivalent) in accordance with the instructions and limitations specified in this user's manual (see page 5).

## Troubleshooting

If you have difficulty operating your phone, the suggestions below should solve the problem. If you still have difficulty after trying these suggestions, call the Supplier.

Problem	Suggestion
My phone doesn't work at all.	<ul style="list-style-type: none"><li>• Make sure the power cord is plugged in.</li><li>• Make sure the telephone line cord is plugged firmly into the base unit and the telephone wall jack.</li><li>• Charge the battery in the handset for 16 hours. For optimum daily performance, return the handset to its base when not in use.</li><li>• Reset the base. Unplug the unit's electrical power. Wait for 15 seconds then plug it back in. Allow up to one minute for the handset and base to reset.</li><li>• You may need to purchase a new battery, please refer to the <b>Batteries</b> section (see page 37) of this user's manual.</li></ul>
I cannot get a dial tone.	<ul style="list-style-type: none"><li>• First try all the suggestions above.</li><li>• Move the handset closer to the base. You might have moved out of range.</li><li>• Your line cord might be malfunctioning. Try installing a new line cord.</li><li>• If the previous suggestions don't work, disconnect the base unit from the telephone jack and connect a different phone. If there is no dial tone on that phone either, the problem is in your wiring or local service. Contact your local telephone company.</li></ul>

# Troubleshooting

Problem	Suggestion
I cannot dial out.	<ul style="list-style-type: none"><li>• Make sure you have a dial tone before dialing. The handset may take a second or two to find the base and produce a dial tone. This is normal. Wait an extra second before dialing.</li><li>• Make sure your phone is set to the correct dial mode for the type of service that you have (pulse or touch tone). Refer to the Installation section of this user's manual to set the dial mode.</li><li>• If the other phones in your home are having the issue, the problem is in your wiring or local service. Contact your local telephone company (charges may apply).</li><li>• Eliminate any background noise. Noise from a television, radio or other appliance may cause the phone to not dial out properly. If you cannot eliminate the background noise, first try muting the handset before dialing, or dialing from another room in your home with less background noise.</li></ul>
My handset beeps four times and isn't performing normally.	<ul style="list-style-type: none"><li>• Make sure the power cord is securely plugged into the base. Plug the unit into a different, working outlet not controlled by a wall switch.</li><li>• Move the handset closer to the base. You might have moved out of range.</li><li>• If the handset is in its base and the charging light does not come on, refer to <b>The charge light is off</b> (see page 43) in this troubleshooting guide.</li><li>• Reset the base. Unplug the unit's electrical power. Wait for 15 seconds then plug it back in. Allow up to one minute for the handset and base to reset.</li><li>• Other electronic products can cause interference with your cordless phone. Try installing your phone as far away from these types of electronic devices as possible: wireless routers, radios, radio towers, pager towers, cell phones, intercoms, room monitors, televisions, personal computers, kitchen appliances and other cordless phones.</li></ul>



# Troubleshooting

Problem	Suggestion
<b>CAN'T CONNECT</b> displays on my handset.	<ul style="list-style-type: none"><li>• Move the handset closer to the base. You might have moved out of range.</li><li>• If the handset is in its base and the charging light does not come on, refer to <b>The charge light is off</b> (see page 43) in this troubleshooting guide.</li><li>• Reset the base. Unplug the unit's electrical power. Wait for 15 seconds then plug it back in. Allow up to one minute for the handset and base to reset.</li><li>• Other electronic products can cause interference with your cordless phone. Try installing your phone as far away from these types of electronic devices as possible: wireless routers, radios, radio towers, pager towers, cell phones, intercoms, room monitors, televisions, personal computers, kitchen appliances and other cordless phones.</li></ul>
The batteries will not hold a charge.	<ul style="list-style-type: none"><li>• Charge the battery in the handset for 16 hours. For optimum daily performance, return the handset to its base when not in use.</li><li>• You may need to purchase a new battery, please refer to the <b>Batteries</b> (see page 37) section of this user's manual.</li><li>• Your phone might be malfunctioning. Please refer to the Warranty section of this user's manual for further instruction.</li></ul>
I hear other calls while using my phone.	<ul style="list-style-type: none"><li>• Disconnect your base unit from the telephone jack, and plug in a regular telephone. If you still hear other calls, the problem is probably in your wiring or local service. Call your local telephone company.</li></ul>
I hear noise in the handset, and none of the keys or buttons work.	<ul style="list-style-type: none"><li>• Make sure the power cord is plugged in.</li></ul>

## Troubleshooting

Problem	Suggestion
<p>I get noise, static, or weak signal even when I'm near the base.</p>	<ul style="list-style-type: none"><li>• Other cordless phones and 802.11 wireless routers that are used for home computer networks both use internal radios to communicate. The radios may interfere with one another. You can improve the performance of your cordless phones and your router by:<ol style="list-style-type: none"><li>a. positioning your new phone as far away as possible from any other existing cordless telephone system that is already installed in your home to avoid the two systems interfering with each other.</li><li>b. positioning your telephone base as far as possible from your router, computer or any other computer devices.</li><li>c. selecting channels four through 10 for your router (refer to your router's user manual for more information).</li></ol></li><li>• Other electronic products can cause interference with your cordless phone. Try installing your phone as far away from these types of electronic devices as possible: wireless routers, radios, radio towers, pager towers, cell phones, intercoms, room monitors, televisions, personal computers, kitchen appliances and other cordless phones.</li><li>• Microwaves operate on the same frequency as your phone. It is normal to experience static on your phone while the microwave is running. Do not install this phone in the same outlet or near the microwave.</li><li>• If your phone is plugged in with a modem or surge protector, plug the phone (or modem/surge protector) into a different location. If this solves the problem, re-locate your phone or modem farther apart from one another, or use a different surge protector.</li><li>• Relocate your phone to a higher location. The phone will likely get better reception not installed in a low area.</li><li>• If the other phones in your home are having the issue, the problem is in your wiring or local service. Contact your local telephone company (charges may apply).</li></ul>

# Troubleshooting

Problem	Suggestion
<p>My handset does not ring when I receive a call.</p>	<ul style="list-style-type: none"><li>• Make sure you have the ringer activated. Refer to the section(s) on ringer selection in this user's manual.</li><li>• Make sure the telephone line cord is plugged firmly into the base unit and the telephone jack. Make sure the power cord is plugged in.</li><li>• You may be too far from the base unit.</li><li>• Charge the battery in the handset for 16 hours. For optimum daily performance, return the handset to its base when not in use.</li><li>• You may have too many extension phones on your telephone line to allow all of them to ring. Try unplugging some of the other phones.</li><li>• The layout of your home or office might be limiting the operating range. Try moving the base to another location, preferably on an upper floor.</li><li>• If the other phones in your home are having the issue, the problem is in your wiring or local service. Contact your local telephone company (charges may apply).</li><li>• Test a working phone at the phone jack. If another phone has the same problem, the problem is the phone jack. Contact your local telephone company (charges may apply).</li><li>• Other electronic products can cause interference with your cordless phone. Try installing your phone as far away from these types of electronic devices as possible: wireless routers, radios, radio towers, pager towers, cell phones, intercoms, room monitors, televisions, personal computers, kitchen appliances and other cordless phones</li><li>• Your line cord might be malfunctioning. Try installing a new line cord.</li></ul>

## Troubleshooting

Problem	Suggestion
My calls fade or cut in and out while I'm using my handset.	<ul style="list-style-type: none"><li>• Other electronic products can cause interference with your cordless phone. Try installing your phone as far away from these types of electronic devices as possible: wireless routers, radios, radio towers, pager towers, cell phones, intercoms, room monitors, televisions, personal computers, kitchen appliances and other cordless phones</li><li>• Microwaves operate on the same frequency as your phone. It is normal to experience static on your phone while the microwave is running. Do not install this phone in the same outlet or near the microwave.</li><li>• If your phone is plugged in with a modem or surge protector, plug the phone (or modem/surge protector) into a different location. If this solves the problem, re-locate your phone or modem farther apart from one another, or use a different surge protector.</li><li>• Relocate your phone to a higher location. The phone will get better reception not installed in a low area.</li><li>• If the other phones in your home are having the issue, the problem is in your wiring or local service. Contact your local telephone company (charges may apply).</li></ul>
The charge light is off.	<ul style="list-style-type: none"><li>• Clean the handset and base charging contact each month using a pencil eraser or cloth.</li><li>• Make sure the power and line cords are plugged in correctly and firmly.</li><li>• Reset the base. Unplug the unit's electrical power. Wait for 15 seconds then plug it back in. Allow up to one minute for the handset and base to reset.</li><li>• Your phone might be malfunctioning. Please refer to the Limited Warranty (see page 45) section of this user's manual for further instruction.</li></ul>

# Troubleshooting

Problem	Suggestion
My caller ID isn't working.	<ul style="list-style-type: none"><li>• Caller ID is a subscription service. You must subscribe to this service for this feature to work on your phone.</li><li>• Your caller must be calling from an area that supports caller ID.</li><li>• Both you and your caller's telephone companies must use caller ID compatible equipment.</li></ul>
Common cure for electronic equipment.	<p>If the unit does not seem to be responding normally, then try putting the handset in its base. If it does not seem to respond, do the following (in the order listed):</p> <ol style="list-style-type: none"><li>1. Disconnect the power to the base.</li><li>2. Disconnect the handset battery, and spare battery, if applicable.</li><li>3. Wait a few minutes.</li><li>4. Connect power to the base.</li><li>5. Re-install the battery(ies).</li><li>6. Wait for the handset to re-establish its link with the base. To be safe, allow up to one minute for this to take place.</li></ol>

# Maintenance

## Taking care of your telephone

Your cordless telephone contains sophisticated electronic parts, so it must be treated with care.

**Avoid rough treatment**

Place the handset down gently. Save the original packing materials to protect your telephone if you ever need to ship it.

**Avoid water**

Your telephone can be damaged if it gets wet. Do not use the handset outdoors in the rain, or handle it with wet hands. Do not install your telephone base near a sink, bathtub or shower.

**Electrical storms**

Electrical storms can sometimes cause power surges harmful to electronic equipment. For your own safety, use caution when using electric appliances during storms.

**Cleaning your telephone**

Your telephone has a durable plastic casing that should retain its luster for many years. Clean it only with a soft cloth slightly dampened with water or a mild soap. Do not use excess water or cleaning solvents of any kind.

Remember that electrical appliances can cause serious injury if used when you are wet or standing in water. If your telephone base should fall into water, DO NOT RETRIEVE IT UNTIL YOU UNPLUG THE POWER CORD AND TELEPHONE LINE CORDS FROM THE WALL. Then pull the unit out by the unplugged cords.

# Warranty

## What does this limited warranty cover?

- The manufacturer of this VTech product, VTech Communications, warrants to the holder of a valid proof of purchase ("Consumer" or "you") that the product and all accessories provided by VTech in the sales package ("Product") are free from material defects in material and workmanship, pursuant to the following terms and conditions, when installed and used normally and in accordance with operation instructions. This limited warranty extends only to the Consumer for Products purchased and used in the United States of America.

## What will VTech Communications do if the Product is not free from material defects in materials and workmanship during the limited warranty period ("Materially Defective Product")?

- During the limited warranty period, VTech's authorized service representative will repair or replace at VTech's option, without charge, a Materially Defective Product. If we repair this product, we may use new or refurbished replacement parts. If we choose to replace this product, we may replace it with a new or refurbished product of the same or similar design. VTech will return repaired or replacement products to you in working condition. VTech will retain defective parts, modules, or equipment. Repair or replacement of Product, at VTech's option, is your exclusive remedy. You should expect the repair or replacement to take approximately 30 days.

## How long is the limited warranty period?

- The limited warranty period for the product extends for ONE (1) YEAR from the date of purchase if we repair or replace a Materially Defective Product under the terms of this limited warranty. This limited warranty also applies to repaired or replacement Products for a period of either (a) 90 days from the date the repaired or replacement Product is shipped to you or (b) the time remaining on the original one-year warranty; whichever is longer.

## What is not covered by this limited warranty?

This limited warranty does not cover

1. Product that has been subjected to misuse, accident, shipping or other physical damage, improper installation, abnormal operation or handling, neglect, inundation, fire, water or other liquid intrusion; or
2. Product that has been damaged due to repair, alteration or modification by anyone other than an authorized service representative of VTech; or
3. Product to the extent that the problem experienced is caused by signal conditions, network reliability or cable or antenna systems; or

[www.vtechphones.com](http://www.vtechphones.com)

# Warranty

4. Product to the extent that the problem is caused by use with non-VTech electrical accessories; or
5. Product whose warranty/quality stickers, Product serial numbers plates or electronic serial numbers have been removed, altered or rendered illegible; or
6. Product purchased, used, serviced, or shipped for repair from outside the United States, or used for commercial or institutional purposes (including but not limited to Products used for rental purposes ); or
7. Product returned without valid proof of purchase (see 2 below); or
8. Charges for installation or set up, adjustment of customer controls, and installation or repair of systems outside the unit.

## How do you get warranty service?

- To obtain warranty service in the United States of America, call 1-800-595-9511 for instructions regarding where to return the Product. Before calling for service, please check the user's manual. A check of the Product controls and features may save you a service call.
- Except as provided by applicable law, you assume the risk of loss or damage during transit and transportation and are responsible for delivery or handling charges incurred in the transport of Product (s) to the service location. VTech will return repaired or replaced product under this limited warranty to you, transportation, delivery or handling charges prepaid. VTech assumes no risk for damage or loss of the Product in transit.
- If the Product failure is not covered by this limited warranty, or proof of purchase does not meet the terms of this limited warranty, VTech will notify you and will request that you authorize the cost of repair prior to any further repair activity. You must pay for the cost of repair and return shipping costs for the repair of Products that are not covered by this limited warranty.

What must you return with the Product to get warranty service?

1. Return the entire original package and contents including the Product to the VTech service location along with a description of the malfunction or difficulty;
2. Include "valid proof of purchase" (sales receipt) identifying the Product purchased (Product model) and the date of purchase or receipt; and
3. Provide your name, complete and correct mailing address, and telephone number.

## Other Limitations

- This warranty is the complete and exclusive agreement between you and VTech. It supersedes all other written or oral communications related to this Product. VTech provides no other warranties for this product. The warranty exclusively describes all of VTech's responsibilities regarding the product. There are no other express warranties. No one is authorized to make modifications to this limited warranty and you should not rely on any such modification.

State Law Rights: This warranty gives you specific legal rights, and you may also have other rights which vary from state to state.

Limitations: Implied warranties, including those of fitness for a particular purpose and merchantability (an unwritten warranty that the product is fit for ordinary use) are limited to one year from date of purchase. Some states do not allow limitations on how long an implied warranty lasts, so the above limitation may not apply to you.

- In no event shall VTech be liable for any indirect, special, incidental, consequential, or similar damages (including, but not limited to lost profits or revenue, inability to use the product, or other associated equipment, the cost of substitute equipment, and claims by third parties) resulting from the use of this product. Some states do not allow the exclusion or limitation of incidental or consequential damages, so the above limitation or exclusion may not apply to you.

# Important safety instructions

When using your telephone equipment, basic safety precautions should always be followed to reduce the risk of fire, electric shock and injury, including the following:

1. Read and understand all instructions.
2. Follow all warnings and instructions marked on the product.
3. Unplug this product from the wall outlet before cleaning. Do not use liquid or aerosol cleaners. Use a damp cloth for cleaning.
4. Do not use this product near water (for example, near a bath tub, kitchen sink or swimming pool).
5. Do not place this product on an unstable surface, such as a table, shelf or stand. The product may fall, causing serious damage.
6. Slots and openings in the back or bottom of the telephone base and handset are provided for ventilation. To protect them from overheating, these openings must not be blocked by placing the product on a soft surface such as a bed, sofa or rug. This product should never be placed near or over a radiator or heat register. This product should not be placed in any area where proper ventilation is not provided.
7. This product should be operated only from the type of power source indicated on the marking label. If you are not sure of the type of power supply in your home, consult your dealer or local power company.
8. Do not allow anything to rest on the power cord. Do not install this product where the cord may have anyone walking on it.
9. Never push objects of any kind into this product through slots in the telephone base or handset as they may touch dangerous voltage points or short out parts that could result in a risk of fire or electric shock. Never spill liquid of any kind on the product.
10. To reduce the risk of electric shock, do not disassemble this product, but take it to an authorized service facility. Opening or removing parts of the telephone base or handset other than specified access doors may expose you to dangerous voltages or other risks. Incorrect reassembling can cause electric shock when the product is subsequently used.
11. Do not overload wall outlets and extension cords as this can result in the risk of fire or electric shock.
12. Unplug this product from the wall outlet and refer servicing to an authorized service facility under the following conditions:
  - A. When the power supply cord or plug is damaged or frayed.
  - B. If liquid has been spilled onto the product.
  - C. If the product has been exposed to rain or water.
  - D. If the product does not operate normally by following the operating instructions. Adjust only those controls that are covered by the operating instructions, as improper adjustment of other controls may result in damage and often requires extensive work by an authorized technician to restore the product to normal operation.
  - E. If the product has been dropped and the telephone base and/or handset has been damaged.
  - F. If the product exhibits a distinct change in performance.
13. Avoid using a telephone (other than cordless) during an electrical storm. There is a remote risk of electric shock from lightning.
14. Do not use the telephone to report a gas leak in the vicinity of the leak.
15. Only put the handset of your telephone next to your ear when it is in normal talk.

**SAVE THESE INSTRUCTIONS**

[www.vtechphones.com](http://www.vtechphones.com)

Download from [Www.Somanuals.com](http://Www.Somanuals.com). All Manuals Search And Download.



# FCC, ACTA and IC regulations

## FCC Part 15

This equipment has been tested and found to comply with the requirements for a Class B digital device under Part 15 of the Federal Communications Commission (FCC) rules. These requirements are intended to provide reasonable protection against harmful interference in a residential installation. This equipment generates, uses and can radiate radio frequency energy and, if not installed and used in accordance with the instructions, may cause harmful interference to radio communications. However, there is no guarantee that interference will not occur in a particular installation. If this equipment does cause harmful interference to radio or television reception, which can be determined by turning the equipment off and on, the user is encouraged to try to correct the interference by one or more of the following measures:

- \* Reorient or relocate the receiving antenna.
- \* Increase the separation between the equipment and receiver.
- \* Connect the equipment into an outlet on a circuit different from that to which the receiver is connected.
- \* Consult the dealer or an experienced radio/TV technician for help.

Changes or modifications to this equipment not expressly approved by the party responsible for compliance could void the user's authority to operate the equipment.

To ensure safety of users, the FCC has established criteria for the amount of radio frequency energy that can be safely absorbed by a user or bystander according to the intended usage of the product. This product has been tested and found to comply with the FCC criteria. The handset may be safely held against the ear of the user. The telephone base shall be installed and used such that parts of the user's body other than the hands are maintained at a distance of approximately 20 cm (8 inches) or more. If you choose to use a clipping device, please make sure to only use the supplied VTech belt clip.

## FCC Part 68 and ACTA

This equipment complies with Part 68 of the FCC rules and with technical requirements adopted by the Administrative Council for Terminal Attachments (ACTA). The label on the back or bottom of this equipment contains, among other things, a product identifier in the format US:AAAEQ##TXXXX. This identifier must be provided to your local telephone company upon request.

The plug and jack used to connect this equipment to premises wiring and the telephone network must comply with applicable Part 68 rules and technical requirements adopted by ACTA. A compliant telephone cord and modular plug is provided with this product. It is designed to be connected to a compatible modular jack that is also compliant. An RJ11 jack should normally be used for connecting to a single line and an RJ14 jack for two lines. See Installation Instructions in the user's manual.

The Ringer Equivalence Number (REN) is used to determine how many devices you may connect to your telephone line and still have them ring when you are called. The REN for this product is encoded as the 6th and 7th characters following the US: in the product identifier (e.g., if ## is 03, the REN is 0.3). In most, but not all areas, the sum of all RENs should be five (5.0) or less. For more information, please contact your local telephone company.

This equipment may not be used with Party Lines. If you have specially wired alarm dialing equipment connected to your telephone line, ensure the connection of this equipment does not disable your alarm equipment. If you have questions about what will disable alarm equipment, consult your telephone company or a qualified installer.

If this equipment is malfunctioning, it must be unplugged from the modular jack until the problem has been corrected. Repairs to this telephone equipment can only be made by the manufacturer or its authorized agents. For repair procedures, follow the instructions outlined under the Limited Warranty.

If this equipment is causing harm to the telephone network, the telephone company may temporarily discontinue your telephone service. The telephone company is required to notify you before interrupting service. If advance notice is not practical, you will be notified as soon as possible. You will be given the opportunity to correct the problem and the telephone company is required to inform you of your right to file a complaint with the FCC. Your telephone company may make changes in its facilities, equipment, operation, or procedures that could affect the proper functioning of this product. The telephone company is required to notify you if such changes are planned.

If this product is equipped with a corded or cordless handset, it is hearing aid compatible.

If this product has memory dialing locations, you may choose to store emergency telephone numbers (e.g., police, fire, medical) in these locations. If you do store or test emergency numbers, please:

# FCC, ACTA and IC regulations

- \* Remain on the line and briefly explain the reason for the call before hanging up.
- \* Perform such activities in off-peak hours, such as early morning or late evening.

## Industry Canada

This equipment complies with regulations RSS210 and CS-03 of Industry Canada. Operation is subject to the following two conditions: (1) this device may not cause interference, and (2) this device must accept any interference, including interference that may cause undesired operation of the device.

The term "IC:" before the certification/registration number only signifies that the Industry Canada technical specifications were met.

The Ringer Equivalence Number (REN) for this terminal equipment is 0.1. The REN is an indication of the maximum number of devices allowed to be connected to a telephone interface. The termination on an interface may consist of any combination of devices subject only to the requirement that the sum of the RENs of all the devices does not exceed five.

## The RBRC® seal

The RBRC® Seal on the nickel-metal-hydride battery indicates that VTech Communications, Inc. is voluntarily participating in an industry program to collect and recycle these batteries at the end of their useful lives, when taken out of service within the United States and Canada.

The RBRC® program provides a convenient alternative to placing used nickel-metal-hydride batteries into the trash or municipal waste, which may be illegal in your area.

VTech's participation in RBRC® makes it easy for you to drop off the spent battery at local retailers participating in the RBRC® program or at authorized VTech product service centers. Please call 1-800-8-BATTERY™ for information on Ni-MH battery recycling and disposal bans/restrictions in your area. VTech's involvement in this program is part of its commitment to protecting our environment and conserving natural resources.

**RBRC® is a registered trademark of Rechargeable Battery Recycling Corporation.**

[www.vtechphones.com](http://www.vtechphones.com)

## Technical specifications

Enhanced 5.8GHz technology—your phone operates on a dual band transmission that combines the best of 5.8GHz and 2.4GHz technologies, providing enhanced performance over standard cordless telephones.

Frequency control	Crystal controlled PLL synthesizer
Transmit frequency	Base: 5725–5850 MHz Handset: 2400–2483.5 MHz
Receive frequency	Base: 2400–2483.5 MHz Handset: 5725–5850 MHz
Channels	95
Nominal effective range	Maximum power allowed by FCC and IC. Actual operating range may vary according to environmental conditions at the time of use.
Size	Handset: 42mm X 52mm X 163mm Base: 177mm X 127mm X 169mm
Weight	Handset: 124 grams Base: 359 grams
Power requirements	Handset: 600mAh NiMH battery Base: 9V DC @ 800mA
Memory	Phonebook: 50 Memory locations, 16 characters for name, 32 digits for number per location. Call log: 50 Memory locations.

# Index

## A

About call history (caller ID) 29  
Access voicemail 31  
Additional information 38  
Answering calls 14

## B

Base display 11  
Base display screen messages 22  
Base unit layout 13  
Basic operation 10  
Batteries 37  
Battery care and maintenance 37  
Before you begin 3  
Belt clip 8

## C

Call forward 18  
Caller ID 28  
Change auto call back number 35  
Change PPU key setting 35  
Change repeat dialing number 36  
Change three-way calling number 36  
Charge the handset battery 8  
Check for dial tone 8  
Choose location 4  
Clear voicemail 31  
Conference call 5  
Connect power to telephone base/handset chargers 6  
Connect to phone line 6  
Custom pay-per-use (PPU) features 34

## D

Delete a phonebook entry 27  
Delete a specific call 29  
Delete all calls 29  
Delete records from call history 29  
De-register all system handsets 9  
Dial a displayed number 29  
Dial type 24

## E

Edit a phonebook entry 27

## F

FCC, ACTA and IC regulations 48  
Flash 15

## H

Handset and base indicators 10  
Handset display 10  
Handset display screen messages 20  
Handset Layout 12  
Handset locator 18  
Headset 19

## I

Important safety instructions 47  
Install handset battery 4  
Installation 4  
Intercom call 17

## K

Key tone 24

# Index

## L

Language 24

## M

Maintenance 45

Making calls 14

Mute 15

## O

Operating range 19

## P

Parts checklist 3

Power guard/spare battery charger feature 5

PPU keys on base 34

PPU keys on handset 34

Program password 32

Program the ERASE key 33

Program the PLAY key 32

Program the SKIP key 33

Program the voicemail access keys 31

Program the VOICEMAIL key 32

## R

Redial 15

Registration 9

Replacing the handset battery 37

Re-register existing handsets to a new base 9

Reset all codes 33

Reset all codes 36

Review call history 29

Reviewing/dialing from the phonebook 26

Ringer tone 23

Ringer volume 23

## S

Shared call log 28

Store a call history record in the directory 30

Storing a new entry 25

## T

Technical specifications 50

Telephone directory 25

Telephone operation 14

Telephone settings 23

The RBRC® seal 49

To register your accessory handsets 9

Transferring calls 16

Troubleshooting 38

## V

Voicemail 31

Volume control 16

## W

Wall mounting 7

Warranty 45

VTECH TELECOMMUNICATIONS LTD.

A member of THE VTECH GROUP OF COMPANIES.

Distributed in the U.S.A. by VTech Communications, Inc. Beaverton, Oregon

Distributed in Canada by VTech Telecommunications Canada Ltd., Richmond, B.C.

Copyright ©2006 for VTECH TELECOMMUNICATIONS LTD.

Printed in China.

91-000xxx-010-000



## Free Manuals Download Website

<http://myh66.com>

<http://usermanuals.us>

<http://www.somanuals.com>

<http://www.4manuals.cc>

<http://www.manual-lib.com>

<http://www.404manual.com>

<http://www.luxmanual.com>

<http://aubethermostatmanual.com>

Golf course search by state

<http://golfingnear.com>

Email search by domain

<http://emailbydomain.com>

Auto manuals search

<http://auto.somanuals.com>

TV manuals search

<http://tv.somanuals.com>