

Table Of Contents

Important Safety Instructions	1
Introduction	3
Parts Check List	4
The Handset Layout	5
The Base Unit Layout	6
Getting Started	7
Setup	7
Connecting Power to Base Unit/Handset Charger	7
Installation of Battery Pack in Handset	8
Charging of the Handset Battery Pack	8
Connecting to Phone Line	9
Checking for Dial Tone	9
Tone/Pulse selection	9
Spare Battery Charger/ Power Backup Feature	10
Wall Mounting	11
Installation and Registration of Accessory Handset	12
Basic Operations	16
Handset and Base Indicators	16
Handset Icons	16
Handset LEDs	17
Base Unit Icons	17
Base LEDs	17
Joystick Operation	18
Menu Shortcuts	18
Main Menu	18
Intercom	19
Phonebook	20
Calls Log	24
Settings	25
Sounds & Alerts	26
Pictures	26
Recordable Ringer	28
Create a Ringer	28
Picture Download	29
One-Time Software Installation	29
Image Download	29
Base Soft Menu Functions	31
Redial	31
Base Unit Menu	32
Calls Log	33
Base Settings	35
Ringer Volume	35
Ringer Melody	35
Keypad Tone	36
Tone/Pulse	36
Contrast	36
Language	36
Phonebook Memory	37
To Store a Number/Name	38
To Search For and Dial a Number/Name	39

To Delete a Number/Name	39
To Edit a Number/Name	40
Advanced Operations	41
Handset and Base Operation	41
Making Calls	41
Answering Calls	41
Handset Volume	42
Base Speakerphone Volume	42
Sound Select	42
Mute Function	43
Hold Function	43
Flash Function	43
Intercom	44
Handset Speakerphone Operation	44
Base Speakerphone Operation	44
Line in Use Indication	45
Conference Calling	45
Transferring Calls	46
Additional Information	47
Handset Accessories	47
In Case of Difficulty	48
Maintenance	50
Warranty Statement	51
FCC, ACTA, and IC Regulations	53
Technical Specifications	57

When using your telephone equipment, basic safety precautions should always be followed to reduce the risk of fire, electric shock and injury, including the following:

1. Read and understand all instructions.
2. Follow all warnings and instructions marked on the product.
3. Unplug this product from the wall outlet before cleaning. Do not use liquid or aerosol cleaners. Use a damp cloth for cleaning.
4. Do not use this product near water (for example, near a bath tub, kitchen sink or swimming pool).
5. Do not place this product on an unstable surface such as a table, shelf or stand. The product may fall, causing serious damage.
6. Slots and openings in the back or bottom of the Base Unit and Handset are provided for ventilation. To protect them from overheating, these openings must not be blocked by placing the product on a soft surface such as a bed, sofa or rug. This product should never be placed near or over a radiator or heat register. Nor should this product should not be placed in any area where proper ventilation is not provided.
7. This product should be operated only from the type of power source indicated on the packaging. If you are not sure of the type of power supply in your home, consult your dealer or local power company.
8. Do not allow anything to rest on the power cord. Do not install this product where the cord may have anyone walking on it.
9. Never push objects of any kind into this product through slots in the Base or Handset as they may touch dangerous voltage points or short out parts that could result in a risk of fire or electric shock. Avoid spilling liquid of any kind on the product.
10. To reduce the risk of electric shock, do not disassemble this product, but take it to an authorized service facility. Opening or removing parts of the Base or Handset other than specified access doors may expose you to dangerous voltages or other risks. Incorrect reassembling can cause electric shock when the product is subsequently used.
11. Do not overload wall outlets and extension cords as this can result in the risk of fire or electric shock.
12. Unplug this product from the wall outlet and refer servicing to an authorized service facility under the following conditions:
 - A. When the power supply cord or plug is damaged or frayed.

- B. If liquid has been spilled onto the product.
 - C. If the product has been exposed to rain or water.
 - D. If the product does not operate normally by following the operating instructions. Adjust only those controls that are covered by the operating instructions, as improper adjustment of other controls may result in damage and often requires extensive work by an authorized technician to restore the product to normal operation.
 - E. If the product has been dropped and the Base and/or Handset has been damaged.
 - F. If the product exhibits a distinct change in performance.
13. Avoid using a telephone (other than cordless) during an electrical storm. There is a remote risk of electric shock from lightning.
 14. Do not use the telephone to report a gas leak in the vicinity of the leak.
 15. Only put the Handset of your telephone next to your ear when it is in normal talk mode.

WARNING: To insure your safety from possible electric shock, only use the enclosed VTech Audio Patch Cable to record custom ring tones. Do NOT leave the Audio Patch Cable attached to the Handset while charging in its cradle.

Your i 5836 is an advanced cordless telephone that operates in the 5.8GHz frequency range. Your i 5836 is capable of supporting up to a maximum of 6 Handsets. Using additional Handsets, up to 2 people can be conferenced on a call or two extensions can be conferenced on a call, while two other extensions can be talking internally, using the Intercom feature.

This manual is designed to familiarize you with the i 5836 cordless telephone. We strongly recommend you read the manual before using your phone.

To order additional system Handsets (model number VT5820 or i 5801), batteries or headsets, call VTech Communications, Inc. at 1-800-595-9511. In Canada, call 1-800-267-7377.

1. Base Unit
2. Handset
3. Handset Charger
4. Base AC Power Adapter
5. Telephone Line Cord
6. Belt Clip
7. Base Wall Mounting Bracket

8. Charger Wall Mounting Bracket
9. Use's Manual
10. Battery Pack
11. USB Cable
12. Audio Patch Cable
13. Image Edit Tool CD-ROM



Handset



Base Unit

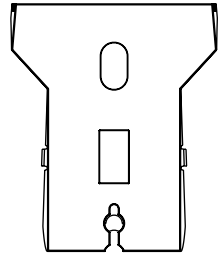

Base Wall Mounting Bracket

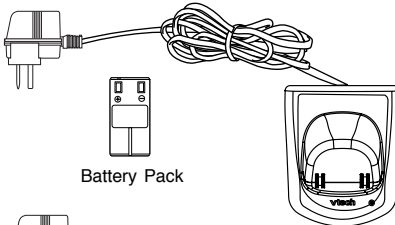

Battery Pack

Handset Charger



Charger Wall Mounting Bracket



Base AC Power Adapter

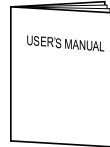

User's Manual



Telephone Line Cord

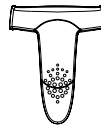

Belt Clip

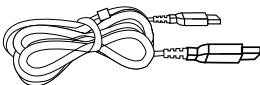

USB Cable

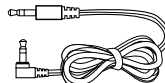

Audio Patch Cable

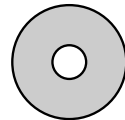
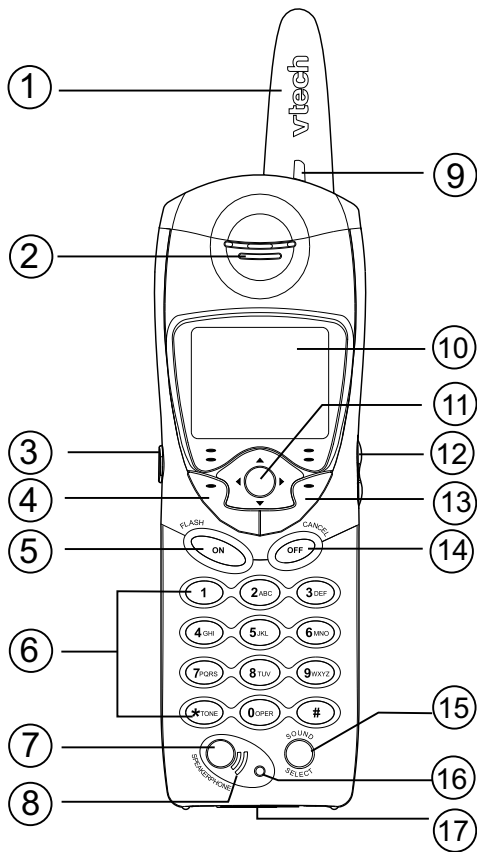
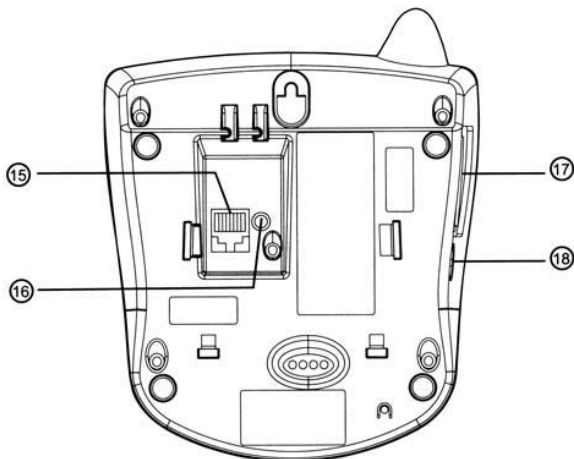
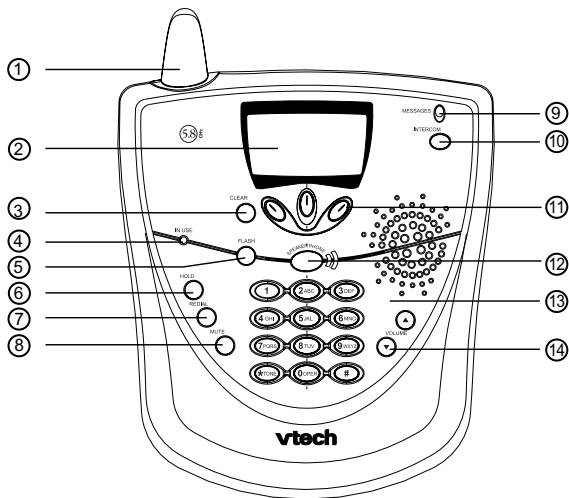

Image Edit Tool CD-ROM

The Handset Layout



- | | |
|--|------------------------|
| 1. Antenna | 10. Colour LCD Display |
| 2. Earpiece | 11. 5-Way Joystick |
| 3. Headset Jack and Audio Patch Cable Jack (2.5mm) | 12. Volume Keys |
| 4. Soft/Select Key | 13. Softkey |
| 5. On/Flash Key | 14. Off/Cancel Key |
| 6. Dialing Keys (0-9, *, #) | 15. Sound Select Key |
| 7. Speakerphone Key | 16. Microphone |
| 8. Speakerphone LED | 17. USB Cable Jack |
| 9. Message LED | |



1. Antenna
2. LCD Display
3. Clear
4. In Use
5. Flash
6. Hold
7. Redial
8. Mute
9. Message LED

10. Intercom
11. Softkeys
12. Speaker Phone
13. Dialing Keys (0-9, * , #)
14. Volume Keys
15. Telephone Jack
16. DC Connector
17. Spare Battery Drawer
18. Spare Battery Release Button

Connecting Power to Base Unit/Handset Charger

1. Plug the AC power adapter into an electrical outlet, and the DC connector into the bottom of the Base Unit.

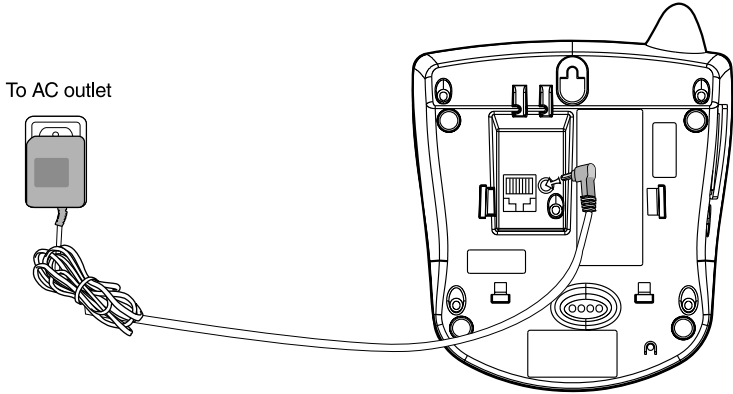

2. Choose the location for your Handset Charger, and plug its power supply into an electrical outlet.

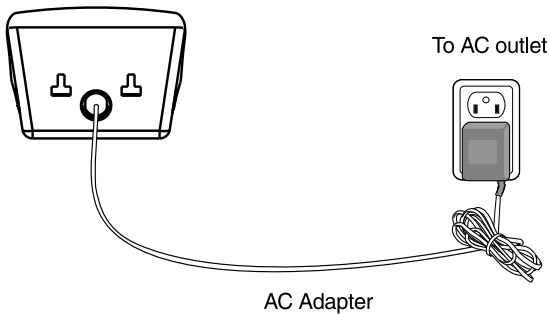

Installation of Battery Pack in Handset

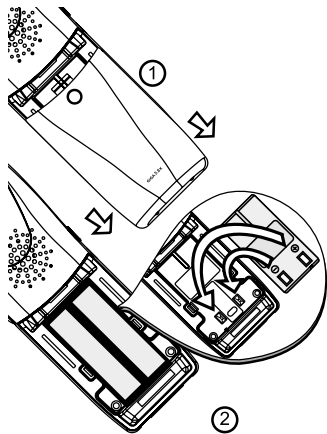

Follow the steps below:

1. Remove the battery compartment cover by pressing on the indent and sliding downward.
2. Place the new battery pack in the Handset with the metal contacts aligned with the charge contacts in the battery compartment.
3. Replace the battery compartment cover by sliding it upward.
4. If the new battery pack is not already charged, place the Handset in its Charger, and allow it to charge for 12 hours. After initial charge, a maintenance charge of 8 hours should be sufficient.

The original Handset that is shipped with your i 5836 system will be automatically registered to the Base. This Handset is HANDSET 1.

As you register additional Handsets to the system, they will be assigned extension numbers in the following order: **HANDSET 2, HANDSET 3**, etc.

Whenever a charged Handset battery pack is installed, the Handset will automatically begin **Searching for Base** (if previously registered), or it will prompt you to **Enter Base ID** to register the new Handset.

Charging of the Handset Battery Pack

The Handset of your **i 5836** cordless telephone is powered by a rechargeable battery pack. It charges automatically whenever the Handset is in its charger. Maximum talk time on a full charge is 8 hours, and maximum standby time is 5 days.

You should charge the battery pack for 12 hours when you first receive your phone. You'll know the battery pack needs charging when:

- The low battery message is displayed:
- The Handset seems completely dead, the LCD is completely clear and does not activate when you press the keys.



IMPORTANT:

1. Do not dispose of a battery pack in a fire, the cell may explode.
2. Do not open or mutilate the battery pack. Toxic substances may be released, causing harm to eyes or skin.
3. Exercise care in handling battery packs in order to prevent an accidental short of the charge contacts, potentially causing the battery pack to overheat.
4. Do not dispose of this battery pack into household garbage.

Connecting to Phone Line

Plug one end of the telephone line cord into the jack on the bottom of the Base Unit. Plug the other end of this cord into the wall jack.

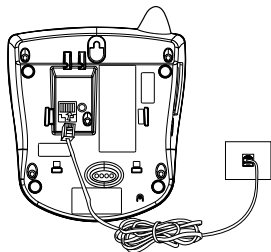

Checking for Dial Tone

After the battery is charged press **ON** on the Handset. The Phone icon  will appear on the Handset display, and you will hear dial tone. If not, see **In Case of Difficulty**.

Tone/Pulse Selection

Your i 5836 is preset for tone dialing. If you want to change your dialing mode, see the **Tone/Pulse** section for details.

⚠ CAUTION: Use only the VTech power supply provided with your telephone.

IMPORTANT:

FOR MAXIMUM PERFORMANCE OF YOUR CORDLESS TELEPHONE SYSTEM:

1. Choose a central location for your Base Unit.
2. Install your Base Unit and Extension Handsets away from electronic equipment, such as personal computers, television sets and microwave ovens.
3. In locations where there are multiple cordless telephones, separate Base Units as much as possible.
4. Install your telephone equipment away from heat sources and sunlight.
5. Avoid excessive moisture, dust or extreme cold.

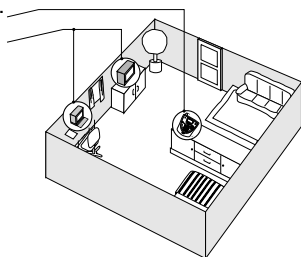

Spare Battery Charger/Power Backup Feature

The **i 5836** uses the spare battery charger in the Base Unit to provide operational backup in the event of a power failure. With a fully charged battery pack in the spare battery charger, you will still be able to place and receive calls from the Handset only, for up to 2 1/2 hours.

The spare battery pack can also be used to replace a drained Handset battery, ensuring uninterrupted use. The spare battery pack is optional and purchased separately.

NOTE: When using the **i 5836** during Power Backup mode, audio quality may be compromised due to reduced power availability.

Installation

1. Open the spare battery charger by pressing the release button, located on the left-hand side of the Base Unit. A drawer will open to reveal the spare battery compartment.
2. Place a battery pack in the drawer with the charge contacts facing up and to the right.
3. Push the drawer closed.

The spare battery charger takes 24 hours to fully charge a drained battery.

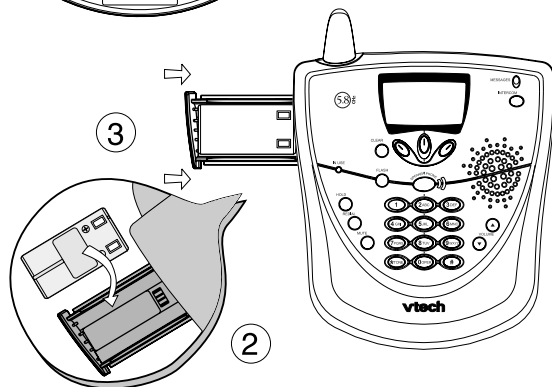
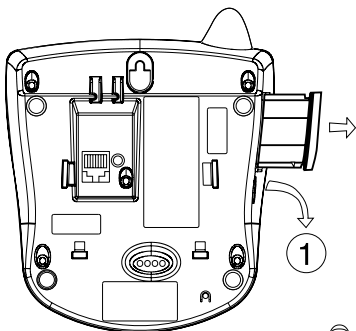

To order battery packs, headsets and additional Handsets (model i 5801 or VT 5820), call VTech Customer Service at:

1-800-595-9511.

In Canada, call

1-800-267-7377.

Wall Mounting

The Wall Mount brackets are designed for use on standard wall mount plates only. Wall mounting is optional.

1. Plug the AC adapters into electrical outlets, and the DC connector to the bottom of the Base Unit.
2. Connect the telephone line cord to the jack on the bottom of the Base Unit, and the other end to the wall jack.
3. Line up the tabs on the wall mount adapters with the holes on the bottom of the Base Unit/back of the Handset Charger. Snap the wall mount bracket firmly in place.
4. Mount the Base Unit/Handset Charger on the wall. Position the Base Unit/Handset Charger so the mounting studs will fit into the holes on the wall mount bracket. Slide Base Unit/Handset Charger down on the mounting studs until it locks into place.

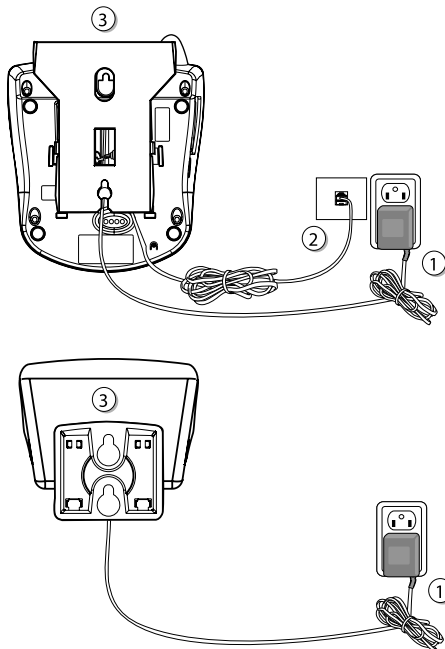

Installation and Registration of Accessory Handset

Expand your i 5836 system by adding accessory Handsets. Bring telephone service to rooms where a phone jack isn't available!

Your i 5836 system can operate up to 6 Handsets (VT 5820 or i 5801).

The VT 5820 accessory Handset consists of the following:

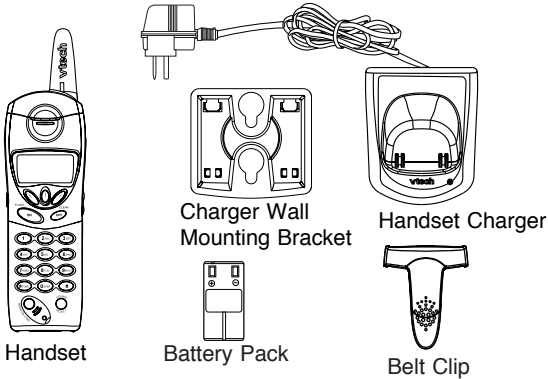

The i 5801 accessory Handset consists of the following:

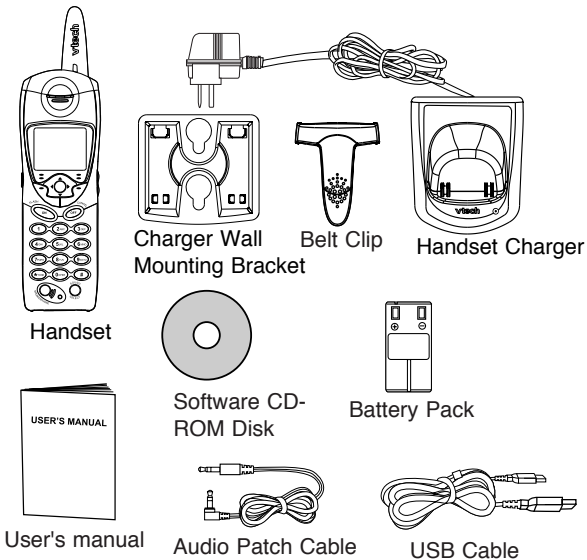

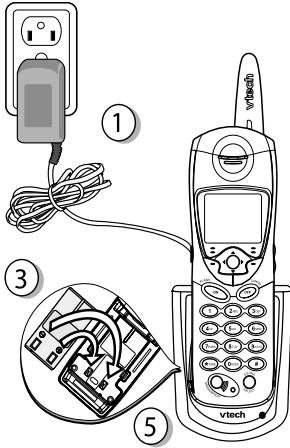

Setup Of The VT 5820/ i 5801 Accessory Handset

1. Plug the AC power adapter into an electrical outlet.
2. Remove the Handset battery compartment cover by pressing on the indent and sliding downward.
3. Place the new battery pack in the Handset, with the metal contacts aligned with the charge contacts in the battery compartment.
4. Replace the battery compartment cover by sliding it upward.
5. Place the Handset in the Charger, and allow it to charge for 12 hours. After the initial charge, a maintenance charge of 8 hours should be sufficient.

Registration

Registration

Your **i 5836** Handset comes registered to the Base Unit. To register additional **VT 5820/i 5801** Handsets, follow these steps:

Register Additional VT 5820 Handsets

1. After charging the Handset, remove it from its Charge Cradle; the screen will display:

alternating with this screen:



2. If, after charging the Handset, you see:



3. Press **NEW**. You will now see the **ENTER BASE ID** screen as described in step 1.
4. Find the **BASE ID Code** by doing the following: (the Base must be in idle (OFF) mode)
 - A. At the Base, press **MENU**
 - B. Scroll down to **DISPLAY BASE-ID**
 - C. Press **OK**. The Base screen will display the 15-digit ID Code.
5. Enter the 15-digit **Base ID Code** into the Handset. If you make a mistake, press **◀** to erase a character. Then press **OK**.

NOTE: The 15-digit BASE ID Code may contain numbers and characters, including 0 through 9 and *. Make sure you enter all 15 digits.

6. Wait approximately 15 to 60 seconds. You will hear confirmation beeps from the Base and Handset. The newly registered Handset will now assign itself the lowest Handset number not previously assigned to a different system Handset (1 - 6).
7. If the Handset displays **REJECTED BY BASE** or continues to display **SEARCHING FOR BASE** for well beyond 60 seconds, try the registration process again by repeating the above steps.

Register Additional i 5801 Handsets

After charging, the screen will display:

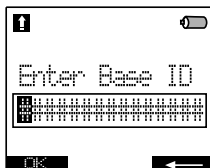

Find the **BASE ID Code** by doing the following (Base must be OFF):

1. At the Base, press **MENU**.
2. Scroll down to **DISPLAY BASE-ID**, then press **OK**.
3. Enter the 15-digit Base ID Code into the Handset. If you make a mistake, move the joystick to the left (◀) to backspace or press the right softkey **←** to erase a character.
4. Press **OK** to complete the registration process.

NOTE: If the Handset, after charging, **Display Searching for Base...**, press the **NEW** soft key. **Enter Base ID** will now be displayed. Follow the steps above.













Wait approximately 15 - 60 seconds. You will hear confirmation beeps from the Base and Handset. The newly registered Handset will now be assigned the lowest extension number not previously assigned to a different system Handset (1 - 6).

If you do not enter the correct digit sequence, you will see **Invalid Base ID!** and hear an **error** tone. move the joystick to the left (◀) to backspace or press the right softkey **←** to erase a character, and carefully re-enter the **Base ID Code**.

NOTE: The 15-digit **BASE ID Code** may contain numbers and characters, including 0 through 9 and **. Make sure you enter all 15 digits.

Congratulations! You can now enjoy the benefits of your **VTech** Multi-Handset system.



Handset Icons

Icon	Description
 	<p>Line In Use Indicator</p> <ul style="list-style-type: none"> • On steady with one or more numbers next to it, indicating which extensions are using the line. For example,  12 indicates that Handset 1 and Handset 2 are on an outside call. • Appears in idle or phone on modes to indicate a parallel set in use. It replaces phone on icon during phone on mode and parallel set is detected.
	<p>Handset Number Indicator</p> <ul style="list-style-type: none"> • Indicates the Handset number. It's permanently displayed at the top left corner after the Handset has found the Base.
	<p>Searching for Base Indicator</p> <ul style="list-style-type: none"> • Indicates that the Handset is still searching for the Base.
	<p>Intercom Indicator</p> <ul style="list-style-type: none"> • On steady with the extension numbers currently on an intercom call. For example,  02 indicates that the Base and Handset 2 are on intercom call.
<p>H</p>	<p>Hold Indicator</p> <ul style="list-style-type: none"> • On steady when the line is on hold.
<p>M</p>	<p>Mute Indicator</p> <ul style="list-style-type: none"> • On steady when the Handset microphone is muted.
	<p>Ringer Off Indicator</p> <ul style="list-style-type: none"> •  is displayed when the ringer is turned off.
	<p>Battery Indicator</p> <ul style="list-style-type: none"> • When the Handset is removed from the charger, this lets you know the level of charge in the battery pack, from FULL () to EMPTY () • Cycles (Low, Medium, and Full) when Handset battery is charging. • Flashes when a low battery condition is detected.

Handset LEDs

LED	Description
Message Waiting	<ul style="list-style-type: none">• Lights to indicate that you have new voicemail messages. Service must be subscribed to through your local telephone company.
Speakerphone	<ul style="list-style-type: none">• Lights when Handset Speakerphone is in use.

Base Unit Icons

Icon	Description
	Ringer Off Indicator  is displayed when the Base ringer is turned off.
	Battery indicator Cycles (Low, Medium and Full) when a battery pack is charging in the spare battery compartment.

Base LEDs

LED	Description
Messages	<ul style="list-style-type: none">• Flashes to indicate that you have new voicemail messages. Service must be subscribed to through your local telephone company.
In Use	<ul style="list-style-type: none">• Light when line is being used by a Handset or Base of the i 5836 system.• Flashes when another telephone on the same line (parallel extension) is in use.
Speaker Phone	<ul style="list-style-type: none">• Lights when Base Speakerphone is in use.• Flashes when HOLD function is activated.

Joystick Operation

- This Handset is equipped with a 5-way navigation joystick: **Left** (◀), **Right** (▶), **Up** (▲), **Down** (▼), and **In** (●).
- The joystick allows you to access the Handset's advanced features and settings.
- Press the joystick in **any direction** to access the Main Menu when in idle or screen saver mode.
- Press joystick **Left** (◀), **Right** (▶), **Up** (▲), or **Down** (▼), to navigate through the menu screen.
- Press joystick **In** (●) to make a selection. Alternatively, pressing the left softkey in some screens will also allow you to select the highlighted option.

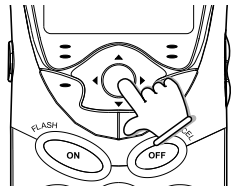

Menu Shortcuts

- When viewing menu options, pressing the corresponding number on the dialing keypad will automatically go to and select that item.
- For example, in the Main Menu screen, pressing the 1 key will automatically take you to the Intercom menu screen, pressing the 6 key will automatically take you to the Settings menu screen.
- Similarly, when viewing a list menu, pressing the corresponding number will automatically select that option and save it, if necessary. For example, pressing the 2 key when in the Appearance screen will select and save the Green option.

Screen Saver

After 30 seconds of inactivity in idle mode, your handset will go into screen saver mode. While in screen saver, your handset will display a digital clock and the new calls count (if you have new calls). To illuminate the screen and read the clock and the new calls count (if you have new calls), simply press the volume button on the right edge of the handset.

Main Menu

Press the joystick in **any direction** to display the 6 menu options. Then use the joystick to navigate to the desired menu option for selection. You can also press the dialing key assigned for each icon (see information below for the assigned keys), to activate the menu option.

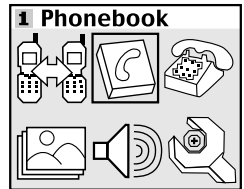



Intercom  (dialing key 1) - Talk between

Handsets(s) and Base Unit, or use to page the cordless Handset(s).

Phonebook  (dialing key 2) - Enter and retrieve up to 50 phone numbers with name, along with a distinctive ring and image for each.

Calls Log  (dialing key 3) - Review Caller ID data; select and dial from the Caller ID data or from the Redial list that accounts for the last 10 dialed phone numbers.

Pictures  (dialing key 4) - Choose from the many preset images or download new images into the Handset to be used as your idle screen (wall paper) or assign an image to a specific phonebook directory.

Sounds & Alerts  (dialing key 5) - Record custom sound clips, turn ringer and vibrate feature on and off, select main ringer tone, turn tones (low battery, keypad, and out-of-range) on and off

Settings  (dialing key 6) - Set the time, adjust screen contrast, reset to default settings, change color of the text, register new Handsets, change screen language.

Press the joystick ◀, ▶, ▲ or ▼ to navigate to the desired menu option. You can also press the dialing key assigned to each menu item. The top menu is assigned to dialing key 1 and so forth on the menu.

Intercom

From Handset to Base:

- With the **Intercom** icon highlighted, press the joystick **in** or assigned dialing key to reveal your intercom options, for example:
- With the **Base** option highlighted, press the joystick in, the left softkey or the assigned dialing key 0 for confirmation. The screen will display:
- The Base will ring, then automatically enter intercom mode.
- To end the intercom call, press **OFF** on the Handset or **INTERCOM** on the Base.

From Handset to Handset:

- With the **Intercom** icon highlighted, press the joystick **in** or press the left softkey.
- Press the joystick ▲ or ▼ to navigate to the desired Handset.
Press the joystick **in** or press the left softkey for confirmation.
Or press the assigned dialing key (1 - 6) directly.
- The ringing Handset can respond by pressing **ON** or any of the number keys.
- To end an intercom call, press **OFF** on either Handset.

NOTE: To access this feature, you must have an additional Handset. To order accessory Handsets, please refer to page 12 for details.

Global Page from Handset:

- With the **Intercom** icon highlighted, press the joystick **in** or press the left softkey.
- Press the joystick ▲ or ▼ to navigate to **GLOBAL PAGE**. Press the joystick **in** or press the left softkey for confirmation.

1 Intercom Call
Base
Handset 2
GLOBAL PAGE

Calling Base



1 Intercom Call
Base
Handset 2
GLOBAL PAGE

Calling Handset 2



1 Intercom Call
Base
Handset 2
GLOBAL PAGE

- Any registered Handset or Base can answer the global page, thus entering Intercom mode.
- To end the intercom call, press **OFF** on the Handset or **INTERCOM** on the Base.



Phonebook



With this icon highlighted, press the joystick **in** or press the left softkey to reveal the contents of your phonebook. If there are no entries, the screen will display **Phonebook is empty**. The i 5836 Handset can store up to 50 numbers with names in the phonebook directory, along with a distinctive ring and image for each. Each memory location can hold up to 32 digits and up to 16 characters, including spaces.

When prompted to **Enter Name**, use the digit keys to spell the name. Each press of a particular key causes characters to be displayed in the following order:

Number Key	Characters (in order)
1	& ' , . 1
2	A B C a b c 2
3	D E F d e f 3
4	G H I g h i 4
5	J K L j k l 5
6	M N O m n o 6
7	P Q R S p q r s 7
8	T U V t u v 8
9	W X Y Z w x y z 9
0	0
*	*
#	#

Adding Phonebook Entries

- From the Handset idle (**OFF**) mode, press the joystick **in any direction**. The **Phonebook** icon should be highlighted. Press the joystick **in** or left softkey again.
- Press **NEW**.

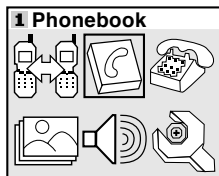

NOTE: When phone book is full, pressing **NEW**, **Phonebook is Full** displays and an error tone sounds.

- You will then be prompted to **Enter Name**. Use the digit keys to spell the name. If you make a mistake, press the **←** softkey. You can add a space between characters by pressing the **1** key or press the joystick **▶** twice. When finished, press **OK**.
- Enter the number you want to store in Phonebook. Press and hold the **#** key to insert a pause. When finished, press **OK**.

- The screen will display:

NOTE: If you do not wish to assign a distinctive ring tone or image, press **SAVE** now.

- If you wish the phone to alert you to calls from this number by changing to a distinctive ringing pattern press the joystick **▲** or **▼** to scroll to: **RINGER Default ▶**.
- Press the joystick **◀** or **▶** to sample the ringer options.

— OR —

- Press the joystick **in** then press the joystick **▲** or **▼** to sample the ringer options.
- Press **OK** to confirm.

In order for your distinctive ring feature to function, you must subscribe to Caller ID service.

NOTE:

- There are 8 traditional ring tones and 12 musical ringers. For Recordable Ringer, please refer to page 28 for details.
- If you do not wish to assign a distinctive image, press **SAVE** now.

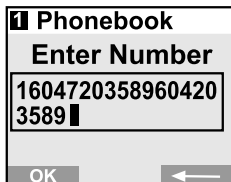
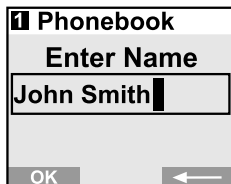
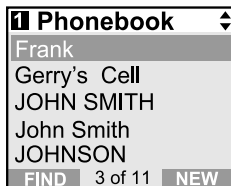

- If you wish to be visually alerted to calls from this number by changing to a distinctive image, press the joystick ▲ or ▼ to scroll to **PICTURE : ◀ (none) ▶**.
 - Press the joystick ◀ or ▶ to sample the pictures and images options.
 - OR —
 - Press the joystick **in** then press the joystick ▲ or ▼ to sample the pictures and images options.
 - Press **OK** to confirm.
- In order for your distinctive image feature to function, you must subscribe to Caller ID service.



NOTE: To create your own pictures, please refer to **Picture Download** on page 29 for details.

- Once you've selected a picture, press **SAVE**.
- Your phonebook entry has been saved and the screen will display:

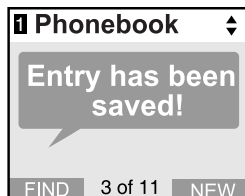

Searching for and Dialing Phonebook Entries

- From the Handset idle (**OFF**) mode, press the joystick **in any direction**. The **Phonebook** icon should be highlighted. Press the joystick **in** or left softkey again.
- Press the joystick ▲ or ▼ to scroll through the contents in alphabetical order.

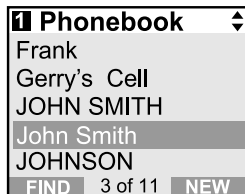

— OR —

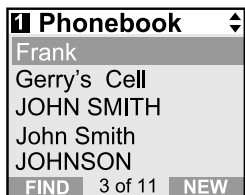

You can enter the first characters of the name directly. The closest match, alphabetically, will be displayed:

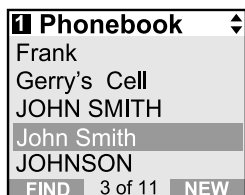

— OR —

You can press **FIND** softkey, enter the first few characters of the name and then press **OK** to search. If you make a mistake, press **←** softkey. The closest match, alphabetically, will be displayed. You can enter Search For directly by pressing * at any time when reviewing the phonebook.

- Once you can find the entry you want, simply press **ON** or **SPEAKERPHONE** to dial the number.

Editing Phonebook Entries

- Following the first two steps in **Searching for and Dialing Phonebook Entries**, locate the entry you want to edit.

- Press the joystick **in**. The screen will display:
- Press the **EDIT** softkey.

- Press the joystick **▲** or **▼** to the option you want to edit then enter the corrections as needed. Press the softkey **←** to delete.

- When finished, press the **SAVE** softkey. The screen will display the edited entry.

Deleting Phonebook Entries

- Following the first two steps in **Searching for and Dialing Phonebook Entries**, locate the entry you want to delete.

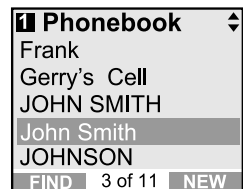
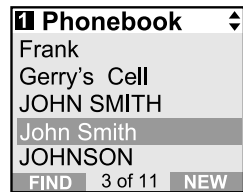
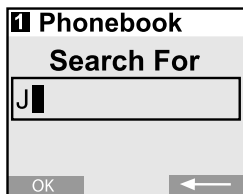

- Press the joystick **in**. The screen will display:
- Press **DELETE** softkey. The screen will display:
- To confirm the deletion, press **YES**. To exit without deleting, press **NO**.



Calls Log



With this icon highlighted, press the joystick **in** or left softkey to view your Caller ID and Redial options:

Review CID Log
Clear CID Log
Review Redial
Clear Redial

Move the joystick **▲** or **▼** to highlight the desired option, then press the joystick **in** or press the left softkey. You can also press the dialing key assigned to each menu item. The top menu is assigned to dialing key 1 and so forth on down the menu.

NOTE: you can also view your Caller ID and Redial options from the Idle Menu by selecting the **REDIAL** and **CID LOG** using the soft keys.

Review CID Log (dialing key 1) - Allows you to scroll through the 50 current Caller ID and Call Waiting records received. With a CID record displayed, you can press **SAVE** to save it in the phonebook. Press **ON** or **SPEAKERPHONE** to dial the number, or **DELETE** the entry from the log. Alternatively, you can dial out by pressing the joystick **in** while reviewing CID Log.

Clear CID Log (dialing key 2) - Choose this option if you want to delete all CID records at once. You will be asked **Are you sure?** Choosing **YES** clears all records. Choosing **NO** returns you to the previous screen.

Review Redial (dialing key 3) - Select this option to display the last 10 numbers you dialed. Use the joystick **▲** or **▼** to highlight the desired number, press and hold joystick **in** to view numbers that are longer than 11 digits, then press **ON** or **SPEAKERPHONE** to dial. You can press **SAVE** to store it in the phonebook, or press **DELETE** to erase.

Clear Redial (dialing key 4) - Select this option to delete all phone numbers stored in redial memory. You will be asked Are you sure? Choosing YES clears all records. Choosing NO returns you to the previous screen.

Settings



With this icon highlighted, press the joystick in or left softkey to reveal the following menu options:



Appearance (dialing key 1) - This option allows you to change the color of the text at the top and bottom of the Handset screen. Your color choices are:

- Blue
- Green
- Tan
- Rose



Set Time (dialing key 2) - This option allows you to set the time to be displayed on the bottom of the idle screen. If you subscribe to Caller ID, this feature will set and update the clock.

NOTE: Press the number keys to change the time.



Contrast (dialing key 3) - This option allows you to adjust the Handset screen contrast.



Register (dialing key 4) - This option will allow you to return the Handset to the Enter Base ID screen.



Language (dialing key 5, preset to English) - This option allows you to change the screen prompts to English, Spanish or French.



Reset Settings (dialing key 6) - This option allows you to return the Handset to factory-preset settings. There are 4 options that can be reset:

- Clear My Clips
- Clear My Pictures
- Clear Phonebook
- Default Settings

Choose the option that you want to reset. You will be asked Are you sure? Choose **YES** to reset. Choosing **NO** returns you to the previous screen.

Press the joystick  to navigate to the desired option and to make the change, or press the dialing key that is assigned to the icon.

For confirmation, press the joystick in or press the **SAVE** softkey.

Sounds & Alerts



With this icon highlighted, press the joystick in or left softkey to reveal the following options:



Sound Clips (dialing key 1) - This option allows you to record and access your personal melodies. See the **Recordable Ringer** section on page 28 for details.



Ringer Control (dialing key 2) - This option allows you to change the Ringer Volume, turn the Ringer On/Off and control the Vibrating Ringer.



Ringers (dialing key 3) - This option allows you to assign a new Ring Tone. You can choose from 8 traditional ringers and 12 musical ringers. Please refer to the **Recordable Ringer** section on page 28 for details on how to record your own personalized ringer.



Low Battery Tone (dialing key 4) - This option allows you to turn the Low Battery Tone On/Off.



Keypad Tone (dialing key 5) - This option allows you to turn the Keypad Tone On/Off.



Range Tone (dialing key 6) - This option allows you to turn the Range Tone On/Off.

Press the joystick  to navigate to the desired option and make the change, or press the dialing key that is assigned to the icon.

For confirmation, press the joystick in or the **SAVE** softkey.

Pictures



Your **i 5836** Handset is preset with the following number of images:

My Pictures — 10 images

Images — 9 images

Emotions — 10 images

CD ROM — 44 images

You can assign one image as your background for the idle screen (wallpaper) or assign a specific image to a phonebook directory in the available 50 directories.

Set a Wallpaper image

To set a wallpaper image, select the icon **Pictures**  in the main menu. Then choose an image in one of the three (**My Pictures**, **Images** or **Emotions**) menu options. Once you have selected the image, press the **SET** softkey to set the image as your wallpaper. You will receive a message on the screen confirming **Wallpaper Set!** and an audio confirmation.

To assign a personal image into your Handset, see the **Picture Download** section in page 29 for instructions.

NOTE: After 30 seconds of inactivity, your Handset will go into idle mode. While in idle mode, your handset will display a digital clock. To illuminate the idle screen and read the clock, simply press the volume button.

Clear a Wallpaper image



To clear a wallpaper image, select the icon **Pictures**  in the main menu. Press the joystick up or down until **Clear Wallpaper** is highlighted. Then press the joystick in or left softkey.

Create a Ringer

You can easily record a unique ringer to be used as either your Default Ringer or for a Distinctive Ringer for assigning to a individual phonebook directory. You can either record using the provided Audio Patch Cord (not the USB cord), or simply use the Handset microphone. You may record 9 unique ringers for a maximum of 10 seconds each.

NOTE: Your **i 5836** Handset is preset with many musical (i.e. Jazz, R&B, Reggae, Rock, etc) ringer options for you to use as your default ringer or a distinctive ringer for a phonebook directory. Three of them are protected, you cannot replace them. You can replace the other 6 preset ringers with your own. Or you can record your own ringers in another 3 blank locations in **My Clips**. You may find 10 additional sound clips on the accompanying CD-ROM.

To record a ringer, follow these steps.

- Select the **Sounds & Alerts** icon  in the Main Menu.
- Select the **Sound Clips** icon. 
- If you are using the Audio Patch Cord, insert the 3.5mm plug (larger plug) into the headset jack of your PC or audio source. Insert the 2.5mm plug (smaller plug) into the Headset jack on the side of the **i 5836** Handset.
- You can listen to the playing music through your Handset speaker after connecting the Audio Patch Cord when selecting the Record Preview menu option. Adjust the recording volume at the audio source. When hear what you desire to record, press **RECORD**.
- If you want to use the Handset microphone to record ringers, select **Record Clip** menu option. Start recording your tone after you hear a beep.

NOTE: If the memory is full, it will prompt **Clip memory full!**

- Hit the **STOP** softkey if you want to stop the recording.
- After the recording is finished, you have the choice to **PLAY** or **SAVE** the recording. If you press **SAVE** to store your recording, it will prompt **Enter Clip Name** Enter a name up to 8 characters for the recorded melody. If you make a mistake, press the  softkey to backspace. Press **SAVE** for confirmation. Clip has been saved will display. The melody will be stored in the **My Clips** section. You can listen to all of your recorded musical ringers in **My Clips**. If you want, when in **My Clips**, you can press **DELETE** then **YES** to erase one of them **My Clips**.

NOTE: When you want to use the Handset microphone to record ringers, do not insert the Audio Patch Cord into the headset jack.

Download Your Own Image

Do you have a favorite image stored in your personal computer that you would like to use as your **i 5836** Handset wallpaper or to assign to one of your 50 available phonebook directories? Using the provided **Image Editor Software**, you can view and convert your image. Once you have selected your file and viewed your image in the software, use the included USB cord to send the converted directly into the Handset. You'll start by downloading the software into your computer:

ONE-TIME SOFTWARE INSTALLATION

1. Insert the enclosed **Image Editor Tool CD** into your personal computer.
2. You will immediately see a pop-up window giving you three options:
 - a. Install/Uninstall the VTech Image Editor Software.
 - b. Browse the installation CD.
 - c. Visit VTech on the web.

To install the software, click on the **Install/Uninstall the VTech Image Editor** icon  and follow the download instructions.



3. After the installation process is complete, you will find a **VTech Image Editor** icon  on your PC desktop. Click on this icon to run the Image Editor software.

Image Download

Once you have installed the software, follow these steps to view and convert your selected image.

- Click on the **OPEN**  icon. Then the pictures on the accompanying CD-ROM be found automatically. Or navigate to the directory where your desired image file is stored, and open the file.
- You will see your image displayed in the middle of the screen and inside the telephone display on the right. You can select the following options to edit your image:



-Zoom In and Zoom Out



-Rotate Left and Rotate Right



-Adjust Brightness and Contrast



-Adjust Color

- Before downloading your image, make sure that the provided USB cord is correctly installed into your computer (using the large connector) and Handset (using the small connector). After you have completed the image editing process, press **Send to Phone**  and your image will be downloaded into the Handset. Within a few seconds, you will see the new image displayed on your Handset and it will be saved in your **My Pictures** directory. You have the option to either **SET** (set the picture to be wallpaper) or **DELETE** the downloaded image. You are able to have a total of 14 images stored in the **My Pictures** directory. You can delete the preset images in this directory. Additional image samples can be found on the accompanying CD-ROM.

NOTE:

1. Do not leave the USB cord connected to the Handset for an extended period of time. This will drain the battery.
2. All preset images in **My Pictures** can be deleted and replaced by new ones. You can record 14 total images in **My Pictures**.

The **i 5836** has an advanced design that uses a menu structure and softkeys to access many of the features.

Example of the idle mode display:

REDIAL

Your **i 5836** Base remembers the last **10** numbers dialed from it. Press **REDIAL**. The number on the top line represents the last number to be dialed.

- Use the  scroll keys to highlight the desired number.
- To dial, press **SPEAKERPHONE**.

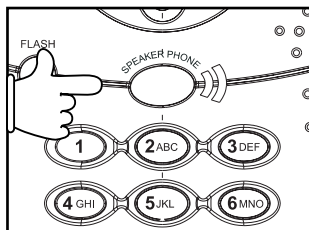

Erasing Numbers in Redial Memory

- Press **REDIAL**, then scroll to the desired number.
- Press **SELECT**, then **ERASE**.



Saving Redial Numbers in Phonebook Memory

- Press **REDIAL**, then scroll to the desired number.



- Press **SELECT**, then **SAVE**.



- You will be asked to **ENTER NAME**. Use the keypad to enter the desired name (see a **To Store a Number/Name** on page 38 for more information).



- Press **SAVE**. The name and number have been stored in Phonebook memory.

Base Unit Menu

With the Base Unit in the idle (**OFF**) mode, press the **MENU** key to access the following options:

- **CALLS LOG (Caller ID)**
- **BASE SETTINGS**
- **DISPLAY BASE-ID**

Press the **CLEAR** key to step back through the menu. Press and hold **CLEAR** to immediately return to the idle screen.

Calls Log

Caller ID - Call Waiting ID

Your **i 5836** is capable of displaying the name and/or number of the party calling before you answer the phone (**Caller ID**). It is also capable of displaying Caller ID information in conjunction with a Call Waiting alert signal (**Call Waiting Caller ID**). With Call Waiting Caller ID, the Caller ID data is displayed so you can decide whether to answer the incoming call, or continue with your current conversation.

NOTES ABOUT CALLER ID & CALL WAITING CALLER ID

These are subscription services, provided by most telephone service providers. You must subscribe to these services to get the benefits of these features. If you do not subscribe to Caller ID services, you can still use your **i 5836** and the other features it offers.

Due to regional incompatibilities, Caller ID information may not be available for every call you receive. In addition, the calling party may intentionally block their name and/or phone number from being sent.

Reviewing Caller ID from the Base

As new Caller ID/Call Waiting ID records are received, your Base displays will alert you to the new Caller ID records, for example:



The number of new calls displayed on each system Handset and Base may not be the same. If, for example, you answer a call on Handset 2, that Handset will not count the Caller ID information for that call as new. However, the other registered Handset and Base displays will consider it a new call, and add it to the **NEW CALLS** total.

After you review all new Caller ID records, the **NEW CALLS** status will be turned off.

From the idle (**OFF**) mode, press **MENU, CALLS LOG** is highlighted, press **OK**. The Caller ID information of the most recently received call will be displayed. For example:



To scroll to other records, use the  scroll keys.



Dialing from Caller ID

To dial the number displayed, you can simply press the **ON** or **SPEAKERPHONE** key.

Dialing Tip: Press the **CID** key, then **OPT#**.

Up to four possible dialing strings of the number stored in Caller ID memory will display. If a number is provided in the Caller ID data, the possible options to choose from will be either 7, 8, 10, or 11 digits. For example, if the original number in Caller ID memory was 808-880-8808, then the display options will be:



Use the  and  keys to make your selection, and then press **DIAL** or **SPEAKERPHONE** to dial the number.

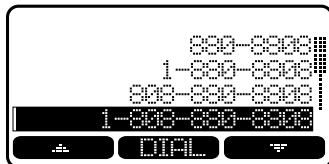

Use the **SAVE** option to store the displayed Caller ID record into the Phonebook. Only caller ID records with telephone numbers can be saved into Speed Dial Memory. If you need to modify the number after saving, see **To Edit a Number/Name** on page 38.

Deleting CID Records

To delete the displayed Caller ID record, press **CID**, then **DEL**. You will then have the option of deleting the single CID record (press **THIS**) or all stored CID records (press **ALL**).

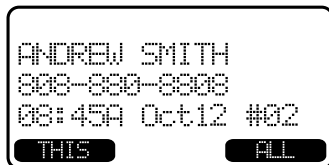

If you press **ALL**, the screen will ask **ARE YOU SURE?** Press **YES** to confirm the deletion of all CID records. Or, press **NO** to return to the CID record previously displayed.

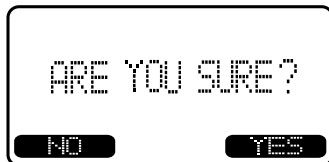

NOTE: You do not have to delete Caller ID records. Your i 5836 always saves the 50 most current CID records. As new records come in, the oldest records are automatically deleted.

Base Settings

To access Base Settings, with the Base in the idle (**OFF**) mode, press **MENU**, scroll down to **BASE SETTINGS**, then press **OK**. You can now access the following setting options:

RINGER VOLUME
RINGER MELODY
KEYPAD TONE
TONE/PULSE
CONTRAST
LANGUAGE

Press **CLEAR** at any time to back out of **Base Settings** mode.

Ringer Volume

To adjust the Base Unit ringer volume:

- Press **MENU**. Scroll down to **BASE SETTINGS**, then press **OK**. **RINGER VOLUME** will be highlighted. Press **OK** again. You will see a graph on the Base display indicating the relative volume setting.
- Press **←** to lower the ringer volume. At the lowest setting (graph is completely clear), the Base will **not** ring when a call comes in.
- Press **→** to raise the volume. At the loudest setting, the graph is completely shaded in.
- Press **OK** to confirm your setting.

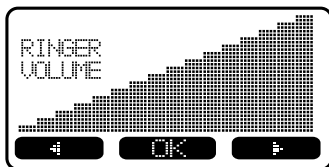

Ringer Melody

There are eight Base ringer melody choices. To change the melody:

- Press **MENU**. Scroll down to **BASE SETTINGS**, then press **OK**. Scroll down to **RINGER MELODY**.
- Press **OK**. Use either scroll key to sample the melodies.
- Press **OK** to confirm your selection.



Keypad Tone (preset to ON)

Keypad tones are the beeps you hear each time you press a key on the Base Unit.

To turn this feature **ON** or **OFF**:

- Press **MENU**. Scroll down to **BASE SETTINGS**, then press **OK**. Scroll down to **KEYPAD TONE**.
- Press **OK**. Choose **ON** or **OFF**.
- Press **OK** to confirm your selection.



Tone/Pulse (preset to TONE)

If you want to change your dialing mode, follow these steps:

- Press **MENU**. Scroll down to **BASE SETTINGS**, then press **OK**. Scroll down to **TONE/PULSE**.
- Press **OK**. Choose **TONE** or **PULSE**.
- Press **OK** to confirm your selection.



Contrast

You can adjust the Base Unit LCD screen's contrast to your liking:

- Press **MENU**. Scroll down to **BASE SETTINGS**, then press **OK**. Scroll down to **CONTRAST**.
- Press **OK**. Use the **←** and **→** scroll keys to lower and raise the screen's contrast.
- Press **OK** to confirm your selection.

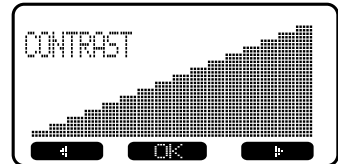

Language (preset to ENGLISH)

Your display can be in English, Spanish or French. To adjust:

- Press **MENU**. Scroll down to **BASE SETTINGS**, then press **OK**. Scroll down to **LANGUAGE**.
- Press **OK**. Scroll to the desired language.
- Press **OK** to confirm your selection.



Phonebook Memory:

The **i 5836** Base can store up to 50 numbers with names in memory. Each memory location can hold up to 32 digits for the number and 16 characters for the name.

When prompted to **ENTER NAME**, use the digit keys to spell the name. Each press of a particular key causes characters to be displayed in the following order:

Number Key	Characters (in order)
1	& ' , . 1
2	A B C a b c 2
3	D E F d e f 3
4	G H I g h i 4
5	J K L j k l 5
6	M N O m n o 6
7	P Q R S p q r s 7
8	T U V t u v 8
9	W X Y Z w x y z 9
0	0
*	✕
#	#

NOTE: Each system Handset and the Base Unit can independently store names and numbers in memory. Adding, editing or deleting items stored in one unit does not affect any other system Handset or the Base.

To Store a Number/Name

- Starting from the idle screen, enter the number you want to store in memory.

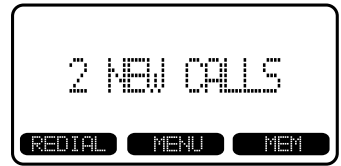

- Be sure to include long distance codes and pauses (using the **PAUSE** softkey) if necessary. Press the **MEM** softkey.



- You will then be prompted to **ENTER NAME**. Use the digit keys to spell the name. If you make a mistake, press the **CLEAR** softkey. To enter a space press **↵**. When finished, press **SAVE**.



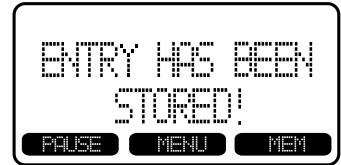

- If there is space available in memory, the entry will be saved and the Base will return to pre-dial mode.



- If the memory is full, the Base will display **PHONEBOOK IS FULL** and exit to pre-dial mode without saving the entry.



To Search For and Dial a Number/Name

- Starting from the idle screen, press the **MEM** softkey to review memory contents.
- Using the  /  softkeys scroll through the memory contents in alphabetical order.

Or, you can press the **FIND** softkey, enter the first few characters of the name and then press **FIND** to search. If you make a mistake, press the **CLEAR** softkey. The closest match alphabetically will be displayed.

- Once you find the entry you want, simply press **SPEAKERPHONE** to dial the number.

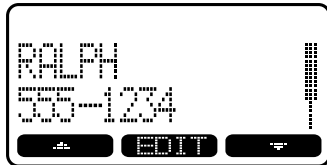
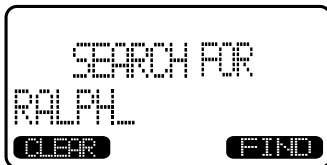
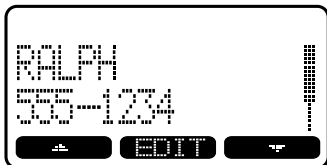

To Delete a Number/Name

- Following the first two steps in **To Search For and Dial a Number/Name**, locate the entry you want to delete.
- Press the **EDIT** softkey. The screen will display:

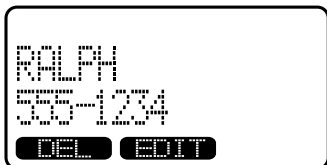
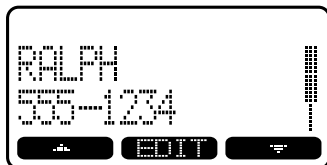

- Press the **DEL** softkey. The screen will display:
- To delete this record, press **THIS**. The record will be deleted, and the next entry in the phonebook will be displayed.
- To delete all records in your phonebook memory, press **ALL**. The display will ask **ARE YOU SURE?**
- To confirm the deletion of all records, press **YES**. To exit without deleting press **NO**.

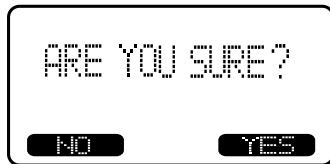
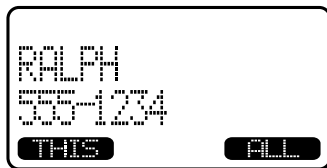

To Edit a Number/Name

- Following the first 2 steps in **To Search For and Dial a Number/Name**, locate the entry you want to edit.
- Press the **EDIT** softkey **twice**. The Handset will display:
- Press **NAME** or **NUMBER**, depending on which you want to edit.
- Using the  softkey move the cursor to the character you want to edit and then enter the corrections as needed. Press **MORE** to access **DEL**, **BACK** and **PAUSE/SPACE** function. When finished press the **SAVE** softkey. To exit without saving press **CLEAR**.
- When finished, the screen will display the edited entry.

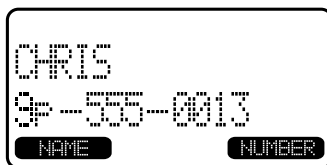
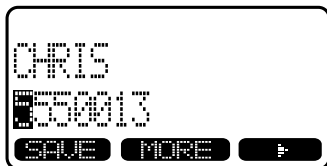
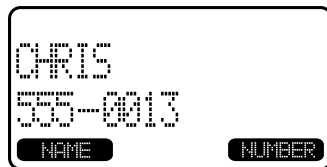
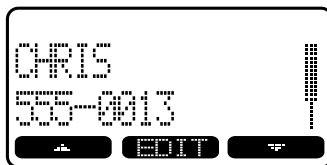

Making Calls

From the Handset

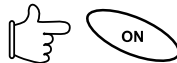
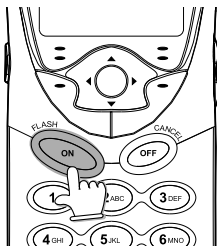

- Press **ON** (or, **SPEAKERPHONE** to use the Handset Speakerphone feature). Dial the phone number.
- OR-
- Dial the phone number first; then press **ON** (or **SPEAKERPHONE**).
- Press **OFF** or place the Handset in charger cradle to end your call.

From the Base Unit

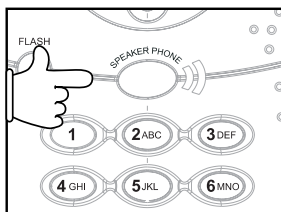

- Press **SPEAKERPHONE**. Dial the phone number.
- OR-
- Dial the phone number first; then press **SPEAKERPHONE**.
- Press **SPEAKERPHONE** to end your call.

Answering Calls

From the Handset

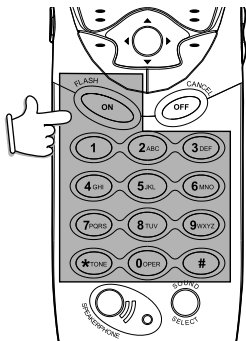

- Pressing any key except **OFF**, the 5-way joystick and the two softkeys can answer calls.
- Press **OFF**

-OR-

Place the Handset in charger cradle to end your call.

From the Base Unit



- Press **SPEAKERPHONE** or any of the dialing keys (0-9, *, #).
- Press **SPEAKERPHONE** to end your call.

Handset Volume

The volume control is on the **right** edge of the Handset. During a call, press the ▲ or ▼ key to adjust the listening volume to a comfortable level. The procedure is the same for the Handset earpiece, Headset and Speakerphone.

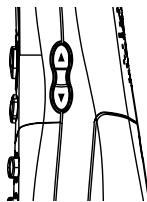

Base Speakerphone Volume

During an active call simply press the Volume ▲ or ▼ keys to adjust the speakerphone volume.

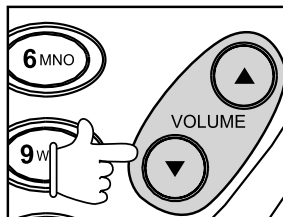

Sound Select (Handset Only)

During a call, you can adjust the quality of the sound to best suit your hearing. Pressing **SOUND SELECT** repeatedly will cycle you through four different frequency responses:

BASS - Low Frequency sounds enhanced.

MID - Mid-Range sounds enhanced (This is the recommended setting for hearing aid users).

TREBLE - High Frequency sounds enhanced.

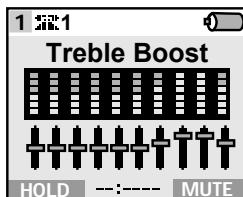
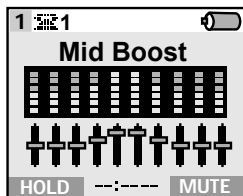
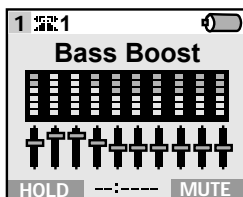

NATURAL - No frequency enhancement (Your Handset is preset with this selection).

The Handset will graphically display the four modes.

NOTE: The Sound Select feature can't be used when in Speakerphone or Headset talk mode.

Mute Function

During an active call pressing either the **MUTE** softkey on the Handset or the **MUTE** softkey on the Base (when in Speakerphone mode), will disable the microphone. Press **MUTE** again to return to normal two-way conversation.

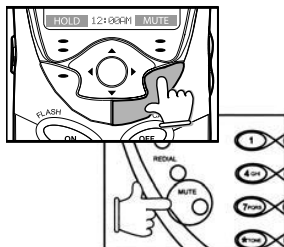
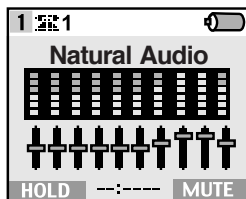

Hold Function

From the Handset:

- Press the **HOLD** softkey to place a call on hold. To return to the call, press the **ON** (or **SPEAKERPHONE**) key.

NOTE: The Handset will display **CALL ON HOLD** when a call is placed on hold. If you have new calls in call log, **CALL ON HOLD** will display alternately. An **H** will be displayed to remind you a call is on hold.

If a call remains on Hold for 5 minutes, your **i 5836 Handset** will ring to remind you the call is being held. The phone will display **Call On Hold Ring Back!** You have 30 seconds to return to the call before it is dropped.

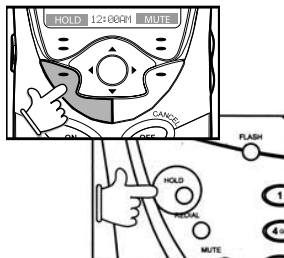

From the Base:

- During an active call, press the **HOLD** softkey to place a call on hold. The **SPEAKERPHONE LED** will flash to indicate a call is on hold.
- To return to the call, press either **HOLD** or **SPEAKERPHONE**.

NOTE: Base will display **CALL ON HOLD** when a call is placed on hold.

If a call remains on hold for 5 minutes, your **i 5836 Base** will ring to remind you the call is being held. The phone will display **CALL ON HOLD RING BACK!** You have 30 seconds to return to the call before it is dropped.

Flash Function

You can use your **i 5836** with services such as Call Waiting. Simply press the **ON/FLASH** key on the Handset or the **FLASH** key on the Base (when in speakerphone mode) to flash the line.

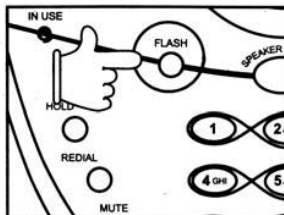

Intercom

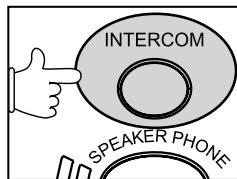

From Base to ALL Handsets:

- To page all Handsets from the Base press the **INTERCOM** key, scroll to **GLOBAL PAGE**, then press OK or press the intercom key, then press *.
- Each Handset will display **Global Call From Base**.
- Any Handset can then answer the page, and enter intercom mode with the Base by pressing any key except **OFF**, the 5-way joystick and the two softkeys can answer intercom calls.
- To end an intercom call, press **OFF** on the Handset or **INTERCOM** on the Base.

From Base to a Specific Handset

- Press the Base **INTERCOM** key, then scroll to the Handset you want to call (e.g. **HANDSET 2**). Then press **OK**.
- Handset 2 can answer the intercom call by pressing any key except **OFF**, the 5-way joystick and the two softkeys can answer.
- To end an intercom call press **OFF** on the Handset or **INTERCOM** on the Base.

Handset Speakerphone Operation

Your i 5836 Handset has a built-in handsfree speakerphone. This feature allows you to stand the Handset upright on a table or desktop and have handsfree conversations. For more information, refer to **Making Calls** in the **Handset and Base Operation** section .

Base Speakerphone Operation

The Base of your i 5836 is equipped with a full duplex speakerphone. This is a very useful feature for handsfree conversations or conference calls at the Base Unit. For more information, refer to **Making Calls** in the **Handset and Base Operation** section.

Line in Use Indication

On the Handset:

When the telephone line is currently being used by a **i 5836** Handset or the Base, a status message similar to this will display on idle Handset(s):

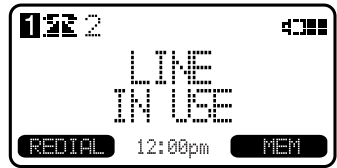

When the telephone line is currently being used by another phone (other than the **i 5836**), the phone icon will remain on steadily, and **EXTENSION IN USE** will be displayed.



On the Base:

When a **i 5836** Handset is in use, the **IN USE** LED will glow, and **LINE IN USE** will appear on the screen. When a parallel set is in use, the **IN USE** will flash, and **EXTENSION IN USE** will appear on the screen.

Message Waiting Indication

The **i 5836** is compatible with optional voicemail service provided by some local telephone companies. If you subscribe to this service, and you have new, unplayed messages in your voicemail, a Visual Message Waiting Indication (VMWI) signal is transmitted by your local telephone company.

The **i 5836** will detect a VMWI signal and activate Message Waiting lights on the Base and Handset(s). See the **Handset** and **Base Unit Layout** Diagrams at the beginning of this User's Manual. for the location of the Message Waiting lights.

Conference Calling

The **i 5836** is capable of supporting conference calls with up to two registered Handsets and the Base Unit.

To enter a conference call, simply access the line with two or three extensions by pressing **ON** (or **SPEAKERPHONE**) on the Handset or **SPEAKERPHONE** on the Base.

The phone icon  and two or three extension numbers will be displayed in the upper left corner of the Handset display.

Transferring Calls

You can transfer calls on the i 5836 system from the Base to Handset, Handset to Handset, or Handset to Base.

Blind Transfer

You can directly transfer any active call to another i 5836 extension without notification by doing the following steps:

From the Handset:

- Press the joystick **in** then press joystick ▲ or ▼ to the desired destination.
- Press the joystick **in** again for confirmation.
- The ringing Handset or Base can pick up the transferred call just like any incoming call.

From the Base:

- Press **INTERCOM** or **XFER** softkey. Scroll to the desired destination, then press **OK**.
- The ringing Handset can pick up the transferred call just like any incoming call.

Announced Transfer

You can perform an announced transfer (call and advise another extension) of an active call by doing the following steps:

From the Handset:

- Press **HOLD** to place your call on hold.
- Press the joystick in any direction then press joystick ◀ to **Intercom**, press the joystick **in** again to confirm.

-OR-

Press the joystick in any direction then press the dialing key **1**.

- Press joystick ▲ or ▼ to the desired destination.
- To confirm, press the joystick **in** again.
- When the ringing Handset or Base answers, announce that there's an active call on hold.
- Press **OFF** (on the Handset) or **INTERCOM** (on the Base).
- Press **ON** (on the destination Handset) or **SPEAKERPHONE** (on the destination Base) to pick up the call on hold.

From the Base:

- Press **HOLD** to place your call on hold.
- Press **INTERCOM**.
- Scroll to the desired destination, then press **OK**.
- When the ringing Handset answers, announce that there's an active call on hold.
- Press **INTERCOM** (on the Base) or press **OFF** (on the Handset).
- Press **ON** (on the destination Handset) to pick up the call on hold.

Your **i 5836** cordless Handset is equipped with a 2.5mm Headset Jack for use with an optional accessory Headset for hands-free operation. If you choose to use the Headset option, you must obtain an optional accessory Headset that is compatible with the **i 5836**.

To purchase a Headset, call VTECH Customer Service at 852-2776-3223.

Once you have a compatible 2.5mm Headset, locate the Headset Jack on the Handset. Connect the plug on the Headset cord to the jack (covered with a small rubber flap) on the cordless Handset. The plug should fit securely. Do not force the connection.

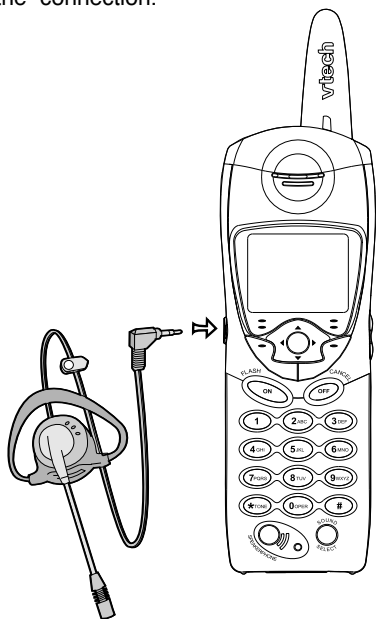

NOTE:

Whenever a compatible Headset is connected to the cordless Handset, the microphone on the Handset will be muted. This is done to limit the effect of background noise.

Many compatible Headsets have a reversible, monaural design. This means you can wear your Headset on either ear, leaving one ear free for on either ear, leaving one ear free for other conversation.

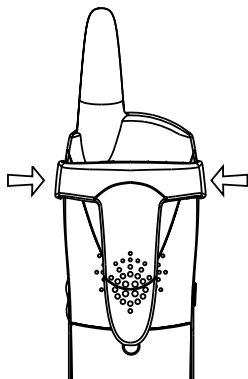

Belt Clip

The **i 5836** is also equipped with a detachable belt clip. Align the pins on the inside edge of the clip with the notches on the sides of the Handset. The belt clip should snap securely into place. Do not force the connection.

If you have difficulty operating your phone, the suggestions below should solve the problem. If you still have difficulty after trying these suggestions, call VTech Communications at 1-800-595-9511. In Canada, call VTech Telecommunications Canada Ltd. at 1-800-267-7377.

The phone doesn't work at all:

- Make sure the Power Cord is plugged in.
- Make sure the telephone line cord is plugged firmly into the Base Unit and the telephone wall jack.
- Make sure the batteries are properly charged. If you get a **LOW BATTERY** message or indication, the battery cells need charging.

No dial tone:

- First try all the suggestions above.
- If you still don't hear a dial tone, disconnect the Base Unit from the telephone jack and connect a different phone. If there is no dial tone on that phone either, the problem is in your wiring or local service. Contact your local telephone company.

You get noise, static, or a weak signal even when you're near the Base Unit:

- Household appliances plugged into the same circuit as the Base Unit can sometimes cause interference. Try moving the appliance or the Base Unit to another outlet.

You get noise, static, or a weak signal when you're away from the Base Unit:

- You may be out of range. Either move closer to the Base, or relocate the Base Unit.
- The layout of your home may be limiting the range. Try moving the Base Unit to another position.

The Handset does not ring when you receive a call:

- Make sure you have the ringer activated. Refer to the section(s) on **Sounds & Alerts - Ringer Control** in this User's Manual.
- Make sure the telephone line cord is plugged firmly into the Base Unit and the telephone jack. Make sure the power cord is plugged in.
- You may be too far from the Base Unit.
- You may have too many extension phones on your telephone line to allow all of them to ring. Try unplugging some of the other phones.

Your Handset vibrates or shakes when a call comes in:

- It is likely that your Vibrating Handset Ringer option has been set to **ON**. If you'd like to turn it off, see the section on **Sounds & Alerts - Ringer Control** in this User's manual.

You hear other calls while using your phone:

- Disconnect your Base Unit from the telephone jack, and plug in a regular telephone. If you still hear other calls, the problem is probably in your wiring or local service. Call your local telephone company.

You hear noise in the Handset, and none of the keys or buttons work:

- Make sure the power cord is plugged in.

Common cure for electronic equipment:

If the unit does not seem to be responding normally, then try putting the Handset in the cradle. If it does not seem to respond, do the following (in the order listed):

1. Disconnect the power to the Base.
2. Disconnect the Handset battery cells and spare battery compartment's battery cells, if applicable.
3. Wait a few minutes.
4. Connect power to the Base.
5. Re-install the battery cells.
6. Wait for the Handset to re-establish its link with the Base. To be safe, allow up to one minute for this to take place.

Your answering system is not recording messages:

- Make sure system is turned ON (the **ON/OFF** key is illuminated).
- Make sure **Announce Only** feature is set to **OFF**.

You cannot hear recorded messages:

- Using the Base volume control, raise the volume to a comfortable listening level.

CL is flashing in the Base Message Window Display:

- You need to set the day and time. Refer to the section(s) on **Setting the Clock** in this User's Manual.

Taking care of your telephone

Your cordless telephone contains sophisticated electronic parts, so it must be treated with care.

Avoid rough treatment

Place the Handset down gently. Save the original packing materials to protect your telephone if you ever need to ship it.

Avoid water

Your telephone can be damaged if it gets wet. Do not use the Handset outdoors in the rain, or handle it with wet hands. Do not install your Base Unit near a sink, bathtub, or shower.

Electrical storms

Electrical storms can sometimes cause power surges harmful to electronic equipment.

For your own safety, use caution when using electric appliances during storms.

Cleaning your telephone

Your telephone has a durable plastic casing that should retain its luster for many years. Clean it only with a soft cloth slightly dampened with water or a mild soap. Do not use excess water or cleaning solvents of any kind.

Remember that electrical appliances can cause serious injury if used when you are wet or standing in water. If your Base Unit should fall into water, **DO NOT RETRIEVE IT UNTIL YOU UNPLUG THE POWER CORD AND TELEPHONE LINE CORDS FROM THE WALL.** Then pull the unit out by the unplugged cords.

What does this limited warranty cover?

The manufacturer of this VTech product, VTech Communications, warrants to the holder of a valid proof of purchase ("Consumer" or "you") that the product and all accessories provided by VTech in the sales package ("Product") are free from material defects in material and workmanship, pursuant to the following terms and conditions, when installed and used normally and in accordance with operation instructions. This limited warranty extends only to the Consumer for Products purchased and used in the United States of America.

What will VTech Communications do if the Product is not free from material defects in materials and workmanship during the limited warranty period ("Materially Defective Product")?

During the limited warranty period, VTech's authorized service representative will repair or replace at VTech's option, without charge, a Materially Defective Product. If we repair this product, we may use new or refurbished replacement parts. If we choose to replace this product, we may replace it with a new or refurbished product of the same or similar design. VTech will return repaired or replacement products to you in working condition. VTech will retain defective parts, modules, or equipment. Repair or replacement of Product, at VTech's option, is your exclusive remedy. You should expect the repair or replacement to take approximately 30 days.

How long is the limited warranty period?

The limited warranty period for the product extends for ONE (1) YEAR from the date of purchase if we repair or replace a Materially Defective Product under the terms of this limited warranty. This limited warranty also applies to repaired or replacement Products for a period of either (a) 90 days from the date the repaired or replacement Product is shipped to you or (b) the time remaining on the original one-year warranty; whichever is longer.

What is not covered by this limited warranty?

This limited warranty does not cover:

1. Product that has been subjected to misuse, accident, shipping or other physical damage, improper installation, abnormal operation or handling, neglect, inundation, fire, water or other liquid intrusion; or
2. Product that has been damaged due to repair, alteration or modification by anyone other than an authorized service representative of VTech; or
3. Product to the extent that the problem experienced is caused by signal conditions, network reliability or cable or antenna systems; or
4. Product to the extent that the problem is caused by use with non-VTech electrical accessories; or
5. Product whose warranty/quality stickers, Product serial numbers plates or electronic serial numbers have been removed, altered or rendered illegible; or
6. Product purchased, used, serviced or shipped for repair from outside the United States, or used for commercial or institutional purposes (including but not limited to Products used for rental purposes); or
7. Product returned without valid proof of purchase (see 2 below); or
8. Charges for installation or set up, adjustment of customer controls and installation or repair of systems outside the unit.

How do you get warranty service?

- To obtain warranty service in the United States of America, call 1-800-595-9511 for instructions regarding where to return the Product. Before calling for service, please check the user's manual. A check of the Product controls and features may save you a service call.
- Except as provided by applicable law, you assume the risk of loss or damage during transit and transportation and are responsible for delivery or handling charges incurred in the transport of Product(s) to the service location. VTech will return repaired or replaced product under this limited warranty to you, transportation, delivery or handling charges prepaid. VTech assumes no risk for damage or loss of the Product in transit.
- If the Product failure is not covered by this limited warranty, or proof of purchase does not meet the terms of this limited warranty, VTech will notify you and will request that you authorize the cost of repair prior to any further repair activity. You must pay for the cost of repair and return shipping costs for the repair of Products that are not covered by this limited warranty.

What must you return with the Product to get warranty service?

1. Return the entire original package and contents including the Product to the VTech service location along with a description of the malfunction or difficulty;
2. Include "valid proof of purchase" (sales receipt) identifying the Product purchased (Product model) and the date of purchase or receipt; and
3. Provide your name, complete and correct mailing address, and telephone number.

Other Limitations

- This warranty is the complete and exclusive agreement between you and VTech. It supersedes all other written or oral communications related to this Product. VTech provides no other warranties for this product. The warranty exclusively describes all of VTech's responsibilities regarding the product.

There are no other express warranties. No one is authorized to make modifications to this limited warranty and you should not rely on any such modification.

State Law Rights: This warranty gives you specific legal rights, and you may also have other rights which vary from state to state.

Limitations: Implied warranties, including those of fitness for a particular purpose and merchantability (an unwritten warranty that the product is fit for ordinary use) are limited to one year from date of purchase. Some states do not allow limitations on how long an implied warranty lasts, so the above limitation may not apply to you.

- In **no** event shall VTech be liable for any indirect, special, incidental, consequential, or similar damages (including, but not limited to lost profits or revenue, inability to use the product, or other associated equipment, the cost of substitute equipment, and claims by third parties) resulting from the use of this product. Some states do not allow the exclusion or limitation of incidental or consequential damages, so the above limitation or exclusion may not apply to you.

This equipment complies with Parts 15 of the Federal Communications Commission (FCC) rules for the United States. It also complies with regulations RSS210 and CS-03 of Industry and Science Canada. Operation is subject to the following two conditions: (1) this device may not cause interference, and (2) this device must accept any interference, including interference that may cause undesired operation of the device.

A label is located on the underside of the Base Unit containing either the FCC registration number and Ringer Equivalence Number (REN) or the IC registration number and Load Number. You must, upon request, provide this information to your local telephone company.

This equipment is compatible with inductively coupled hearing aids.

Should you experience trouble with this telephone equipment, please contact: **VTech Communications Inc. CUSTOMER SERVICE at 1-800-595-9511. In Canada, call VTech Telecommunications Canada Ltd. at 1-800-267-7377** for repair/warranty information. The telephone company may ask you to disconnect this equipment from the line network until the problem has been corrected.

FCC Part 15

Warning: Changes or modifications to this unit not expressly approved by the party responsible for compliance could void the user's authority to operate the equipment.

The equipment has been tested and found to comply with part 15 of the FCC rules. These limits are designed to provide reasonable protection against harmful interference in a residential installation. This equipment generates, uses and can radiate radio frequency energy and, if not installed and used in accordance with the instructions, may cause harmful interference to radio communications. However, there is no guarantee that interference will not occur in a particular installation. If this equipment does cause harmful interference to radio or television reception, which can be determined by turning the equipment off and on, the user is encouraged to try and correct the interference by one or more of the following measures:

- Reorient or relocate the receiving antenna.
- Increase the separation between the equipment and receiver.
- Connect the equipment into an outlet or on a circuit different from that to which the receiver is connected.
- Consult the dealer or an experienced radio/TV technician for help.

To ensure safety of users, the FCC has established criteria for the amount of radio frequency energy that can be safely absorbed by a user or bystander according to the intended usage of the product. This product has been tested and found to comply with the FCC criteria. The handset has such a low power that it does not require testing. It may be safely held against the ear of the user. The base unit shall be installed & used such that parts of the user's body other than the hands should be maintained at a comfortable distance of approximately 20 cm or more.

FCC and ACTA Information

If this equipment was approved for connection to the telephone network prior to July 23, 2001, it complies with Part 68 of the Federal Communications Commission (FCC) rules. If the equipment was approved after that date, it complies with the Part 68 rules and with Technical Requirements for Connection

of Equipment to the Telephone Network adopted by the Administrative Council for Terminal Attachments (ACTA). We are required to provide you with the following information.

1. Product identifier and REN information

The label on the back or bottom of this equipment contains, among other things, an identifier indicating product approval and the Ringer Equivalence Number (REN). This information must be provided to your local telephone company upon request. For equipment approved prior to July 23, 2001, the product identifier is preceded by the phrase "FCC Reg No." and the REN is listed separately. For equipment approved after that date, the product identifier is preceded by "US" and a colon (:), and the REN is encoded in the product identifier without a decimal point as the sixth and seventh characters following the colon. For example, the product identifier US:AAAEQ03T123XYZ would indicate an REN of 0.3.

The REN is used to determine how many devices you may connect to your telephone line and still have them ring when you are called. In most, but not all areas, the sum of all RENs should be five (5.0) or less. For more information, please contact your local telephone company.

2. Connection and use with the nationwide telephone network

The plug and jack used to connect this equipment to the premises wiring and the telephone network must comply with the applicable Part 68 rules and technical requirements adopted by ACTA. A compliant telephone cord and modular plug is provided with this product. It is designed to be connected to a compatible modular jack that is also compliant. An RJ11 jack should normally be used for connecting to a single line and an RJ14 jack for two lines. See Installation Instructions in this user's manual. This equipment may not be used with Coin Telephone Lines or with Party Lines. If you have specially wired alarm dialing equipment connected to your telephone line, ensure the connection of this equipment does not disable your alarm equipment. If you have questions about what will disable alarm equipment, consult your telephone company or a qualified installer.

3. Repair instructions

If this equipment is malfunctioning, it must be unplugged from the modular jack until the problem has been corrected. Repairs to this telephone equipment can only be made by the manufacturer or its authorized agents. For repair procedures, follow the instructions outlined under the Limited Warranty.

4. Rights of the telephone company

If this equipment is causing harm to the telephone network, the telephone company may temporarily discontinue your telephone service. The telephone company is required to notify you before interrupting service. If advance notice is not practical, you will be notified as soon as possible. You will be given the opportunity to correct the problem and the telephone company is required to inform you of your right to file a complaint with the FCC. Your telephone company may make changes in its facilities, equipment, operation, or procedures that could affect the proper functioning of this product. The telephone company is required to notify you if such changes are planned.

5. Hearing aid compatibility

If this product is equipped with a corded or cordless handset, it is hearing aid compatible.

6. Programming/testing of emergency numbers

If this product has memory dialing locations, you may choose to store police, fire department and emergency medical service telephone numbers in these locations. If you do, please keep three things in mind:

- a. We recommend that you also write the telephone number on the directory card, so that you can still dial the emergency number manually if the memory dialing feature doesn't work.
- b. This feature is provided only as a convenience, and the manufacturer assumes no responsibility for customer reliance upon the memory feature.
- c. Testing the emergency telephone numbers you have stored is not recommended.

However, if you do make a call to an emergency number:

- You must remain on the line and briefly explain the reason for the call before hanging up.
- Programming/testing of emergency numbers should be performed during off-peak hours, such as in the early morning or late evening, when the emergency services tend to be less busy.

IC (Industry Canada)

This telephone is registered for use in Canada.

The term "IC:" before the radio certification number only signifies that Industry Canada technical specifications were met.

Notice: This equipment meets the applicable Industry Canada Terminal Equipment Technical Specifications. This is confirmed by the registration number. The abbreviation, IC, before the registration number signifies that registration was performed based on a Declaration of Conformity indicating that Industry Canada technical specifications were met. It does not imply that Industry Canada approved the equipment.

Notice:

The Ringer Equivalence Number (REN) for this terminal equipment is 0.1. The REN assigned to each terminal equipment provides an indication of the maximum number of terminals allowed to be connected to a telephone interface. The termination on an interface may consist of any combination of devices subject only to the requirement that the sum of the Ringer Equivalence Numbers of all the devices does not exceed five.

Before installing this equipment, users should ensure that it is permissible to be connected to the facilities of the local telecommunications company. The equipment must also be installed using an acceptable method of connection. The customer should be aware that compliance with the above conditions may not prevent degradation of services in some situations.

Repairs to certified equipment should be made by an authorized Canadian maintenance facility designated by the Supplier. Any repairs or alterations made by the user to this equipment, or equipment malfunctions, may give the telecommunications company cause to request the user to disconnect the equipment.

Users should ensure for their own protection that the electrical ground connections of the power utility, telephone lines and internal metallic water pipe system, if present, are connected together. This precaution may be particularly important in rural areas.

Caution:

Users should not attempt to make such connections themselves, but should contact the appropriate electrical inspection authority or electrician as appropriate.

Your Cordless Phone is designed to operate at the maximum power allowed by the FCC and IC. This means your Handset and Base Unit can communicate only over a certain distance - which will depend on the location of the Base Unit and Handset, weather, and the construction and layout of your home or office.

FREQUENCY CONTROL

Crystal controlled
PLL synthesizer

TRANSMIT FREQUENCY

Base: 5744.736 - 5825.952 MHz
Handset: 2401.056-2482.272 MHz

RECEIVE FREQUENCY

Base: 2401.056 - 2482.272 MHz
Handset: 5744.736 - 5825.952 MHz

CHANNELS

95 Channels

SIZE

Handset: 193mm x 52mm x 40mm
(including antenna)
Base: 192mm x 143mm x 91mm
Charger : 77mm x 69mm x 54mm

WEIGHT

Handset: 148.5 grams
(excluding Battery Pack)
Charger: 292 grams
Base: 396 grams

POWER REQUIREMENTS

Handset: 2.4V 1400mAh NiMH Battery
Pack
Base: 7 VDC @ 900mA
Charger: 6 VDC @ 300mA

MEMORY

Phone Book: 50 Memory locations;
up to 32 digits per location
CID: 50 Memory locations

SPECIFICATIONS ARE TYPICAL AND MAY CHANGE WITHOUT NOTICE.

vtech

VTECH TELECOMMUNICATIONS LTD.

vtech A member of THE VTECH GROUP OF COMPANIES.

Distributed in the U.S.A. by VTech Communications, Inc. Beaverton,
Oregon, 97008

Distributed in Canada by VTech Telecommunications Canada Ltd.
7671 Alderbridge Way, Richmond, B.C. V6X 1Z9.

Printed in China

91-5734-10-00
ISSUE 0

Free Manuals Download Website

<http://myh66.com>

<http://usermanuals.us>

<http://www.somanuals.com>

<http://www.4manuals.cc>

<http://www.manual-lib.com>

<http://www.404manual.com>

<http://www.luxmanual.com>

<http://aubethermostatmanual.com>

Golf course search by state

<http://golfingnear.com>

Email search by domain

<http://emailbydomain.com>

Auto manuals search

<http://auto.somanuals.com>

TV manuals search

<http://tv.somanuals.com>