

vtech®

USER'S MANUAL ia 5829



Model: ia5829

5.8
GHz
Technology

Cordless Phone System

FEATURING: Caller ID / Call Waiting* • 45 Name & Number
Caller ID Memory • Headset Compatible (2.5mm)

Table of Contents

Important Safety Instructions	1
Before You Begin	3
Parts Check List	3
The Handset Layout.....	4
The Base Unit Layout.....	5
Getting Started	6
Setup	6
Connecting Power to Base Unit	6
Installation and Charge of Battery.....	6
Low Battery Indication	7
Battery Care and Maintenance	7
Connecting to Phone Line	7
Check for Dial Tone.....	8
Set Date and Time.....	8
Wall Mounting.....	8
Basic Operation	9
Telephone Operation	9
Handset Operation.....	9
Base Operation	10
Handset Ringer Style/Battery Save.....	11
Set the Dail Mode.....	11
Temporary Tone Dialing.....	11
Message Waiting.....	11
Clear Message Waiting Alert.....	12
Display Screen Messages	12
Speed Dial Memory	13
Store a Number/Name in Speed Dial Memory	13
Edit a Number/Name Stored in Memory	14
Delete a Number/Name Stored in Memory	14
Dial a Memory Number	15
Reassign Locations in Memory	15
Telephone Directory	16
Store a Number/Name in the Directory	16
Edit a Number/Name Stored in the Directory	17
Delete a Number/Name Stored in the Directory	17
Dial a Number from the Directory.....	18
Move a Number/Name to the Memory.....	18
Caller ID Operation	19

Table of Contents

About Call History	19
Review Call History	19
Delete Records from Call History.....	19
Dial a Displayed Number.....	20
Store a Call History Record in the Directory.....	20
Display Screen Messages.....	20
Additional Information.....	21
Headset Operation.....	21
Maintenance.....	22
In Case of Difficulty.....	23
Warranty Statement.....	25
FCC, ACTA and IC Regulations.....	27
Technical Specifications.....	30

Important Safety Instructions

When using your telephone equipment, basic safety precautions should always be followed to reduce the risk of fire, electric shock and injury, including the following:

1. Read and understand all instructions.
2. Follow all warnings and instructions marked on the product.
3. Unplug this product from the wall outlet before cleaning. Do not use liquid or aerosol cleaners. Use a damp cloth for cleaning.
4. Do not use this product near water (for example, near a bath tub, kitchen sink or swimming pool).
5. Do not place this product on an unstable surface, such as a table, shelf, or stand. The product may fall, causing serious damage.
6. Slots and openings in the back or bottom of the base unit and handset are provided for ventilation. To protect them from overheating, these openings must not be blocked by placing the product on a soft surface such as a bed, sofa or rug. This product should never be placed near or over a radiator or heat register. This product should not be placed in any area where proper ventilation is not provided.
7. This product should be operated only from the type of power source indicated on the marking label. If you are not sure of the type of power supply in your home, consult your dealer or local power company.
8. Do not allow anything to rest on the power cord. Do not install this product where the cord may have anyone walking on it.
9. Never push objects of any kind into this product through slots in the base or handset as they may touch dangerous voltage points or short out parts that could result in a risk of fire or electric shock. Never spill liquid of any kind on the product.
10. To reduce the risk of electric shock, do not disassemble this product, but take it to an authorized service facility. Opening or removing parts of the base or handset other than specified access doors may expose you to dangerous voltages or other risks. Incorrect reassembling can cause electric shock when the product is subsequently used.
11. Do not overload wall outlets and extension cords as this can result in the risk of fire or electric shock.
12. Unplug this product from the wall outlet and refer servicing to an authorized service facility under the following conditions:

Important Safety Instructions

- A. When the power supply cord or plug is damaged or frayed.
 - B. If liquid has been spilled onto the product.
 - C. If the product has been exposed to rain or water.
 - D. If the product does not operate normally by following the operating instructions. Adjust only those controls that are covered by the operating instructions, as improper adjustment of other controls may result in damage and often requires extensive work by an authorized technician to restore the product to normal operation.
 - E. If the product has been dropped and the base and/or handset has been damaged.
 - F. If the product exhibits a distinct change in performance.
13. Avoid using a telephone (other than cordless) during an electrical storm.
There is a remote risk of electric shock from lightning.
14. Do not use the telephone to report a gas leak in the vicinity of the leak.
15. Only put the handset of your telephone next to your ear when it is in normal talk mode.

Before You Begin

Enhanced 5.8GHz Technology - Dual band transmission combines the best of 5.8GHz and 900MHz technologies, providing enhanced performance over standard cordless telephones.

Parts Check List

1. Base Unit
2. Handset
3. Base Power Adaptor
4. Telephone Line Cord
5. Battery
6. Belt Clip
7. User's Manual
8. Wall Mount Bracket

To purchase replacement batteries, visit us on the web at www.vtechphones.com or call VTech Communications, Inc. at 1-800-595-9511. In Canada, call VTech Telecommunications Canada Ltd. at 1-800-267-7377.



Handset

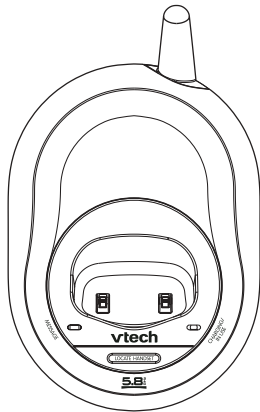

Base Unit

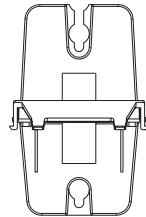

Wall Mount Bracket

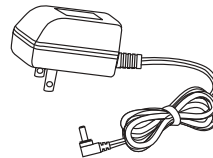

Base Power Adaptor



Battery

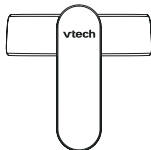

Belt Clip

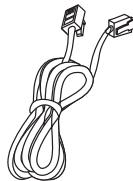

**Telephone
Line Cord**

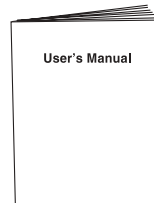

**User's Manual
(English and Spanish)**

The Handset Layout

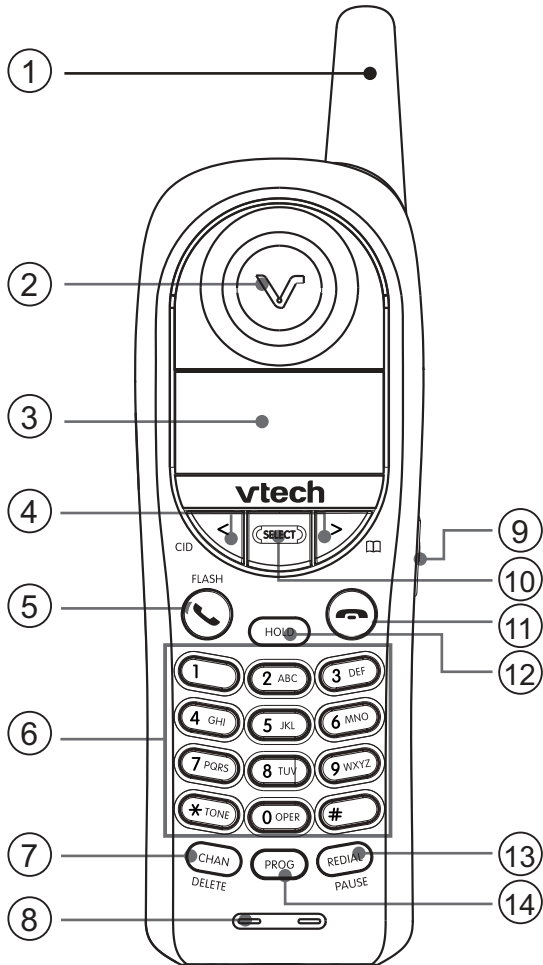

- | | |
|------------------------------|----------------------|
| 1. Antenna | 9. Headset Jack |
| 2. Earpiece | 10. Select Key |
| 3. LCD | 11. Off Key |
| 4. Left and Right Arrow Keys | 12. Hold Key |
| 5. Phone/Flash Key | 13. Redial/Pause Key |
| 6. Dialing Keys (0-9,*,#) | 14. Prog Key |
| 7. Chan/Delete Key | |
| 8. Microphone | |

The Base Unit Layout

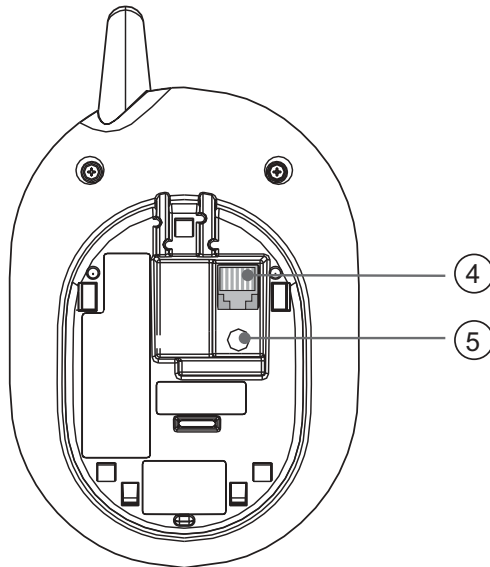
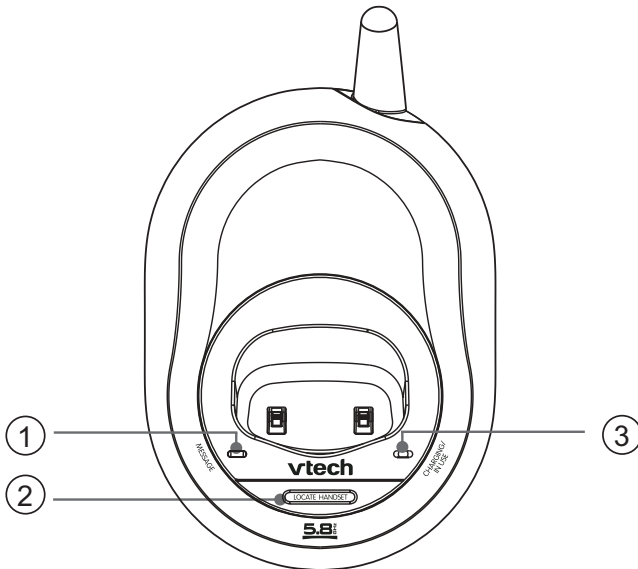

1. Message Light
2. Locate Handset Key
3. Charging/In use Light

4. Telephone Line Jack
5. DC Connector Jack

Setup

Connecting Power to Base Unit

1. Choose a location for the base near an electrical outlet and a telephone jack. This phone requires a modular telephone jack and a standard electrical outlet (110V AC) not controlled by a wall switch.
2. Plug the DC connector to the base. Plug the AC adaptor into an electrical outlet.

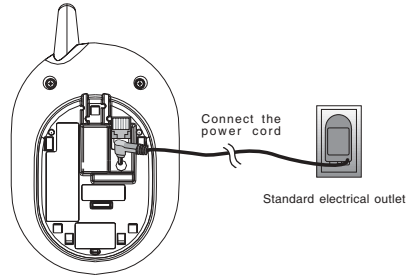

Installation and Charge of Battery

1. **Install the battery.** Use only VTech batteries.



- a) Remove battery compartment cover by pressing on the indentation and sliding downward.

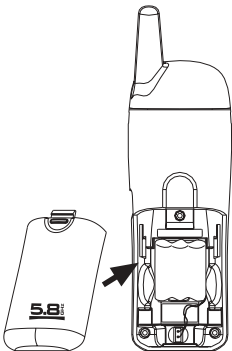
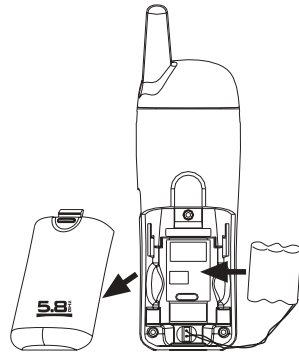

- b) Align the two holes in the plug with the socket pins, then snap the plug into place.
- c) Place the battery in the compartment with the wires in the lower right corner.
- d) Replace the battery compartment cover.
- e) If the battery is not already charged, place the handset in its base and allow to charge for 10 - 12 hours (or overnight). After that, be sure to place the handset in its base when not in use to ensure maximum daily performance.

Setup

2. If the phone will not be used for long periods of time, remove the battery to prevent possible leakage.

NOTE: Install the base unit away from electronic equipment, such as personal computers, television sets or microwave ovens. Avoid excessive heat, cold, dust or moisture.

Low Battery Indication: If the battery power becomes low, a low-battery icon will be shown at the lower left corner of handset display. The handset will beep until you place the handset in the charger. When in standby mode, the low-battery display is shown:

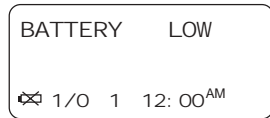

Battery Care and Maintenance

- The maximum standby time on a fully charged battery is six days. Average talk time on a fully charged battery is five hours.
- The battery needs charging when:
 - A new battery is installed in the handset.
 - The phone beeps twice every five seconds.
 - The screen displays **BATTERY LOW** and the low battery icon.
- Place the handset in its base so the **CHARGING** light turns on. The battery is typically fully charged in 12 hours.
- You can keep the battery fully charged by returning the handset to its base after each use.
- If you repeatedly get a low battery indicator, even after charging overnight, the battery should be replaced. Use only VTech batteries.



CAUTION! To reduce the risk of fire or injury to persons or damage to the telephone, read and follow these instructions carefully: Charge the battery provided with or identified for use with this product only in accordance with the instructions and limitations specified in the user's manual.

Connecting to Phone Line

Before connecting to the phone, make sure to properly charge the battery for at least 10 - 12 hours.

Plug one end of the telephone line cord into the jack on the bottom of the base unit. Plug the other end of this cord into the wall jack.

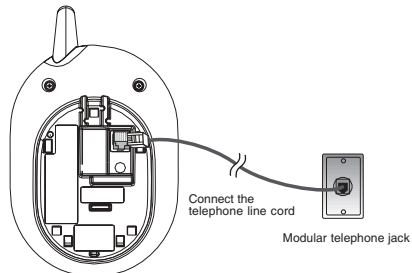

Setup

Check for Dial Tone

After the battery is charged, pick up the handset and press **PHONE/FLASH**. You should hear a dial tone.

Set Date and Time

If you subscribe to caller ID service, the date and time will be set automatically with the first incoming call. If you do not have caller ID service, you can set the date and time manually:

- Press **PROG** on the handset.
- Press **<** or **>** until **DATE/TIME** is displayed. Press **SELECT**.
- The month is flashing. Press **<** or **>** until the screen displays the correct month. Press **SELECT**.
- The day is flashing. Press **<** or **>** until the screen displays the correct day. Press **SELECT**.
- The hour is flashing. Press **<** or **>** until the screen displays the correct hour. Press **SELECT**.
- The minute is flashing. Press **<** or **>** until the screen displays the correct minute. Press **SELECT**.
- **AM** or **PM** is flashing. Press **<** or **>** to choose between **AM** or **PM**. Press **SELECT**.

Wall Mounting

The wall mount bracket is designed for use on standard wall mount plates only.

1. Run the power and telephone line cords through the slots in the bracket, connecting them to the jacks located on the underside of the base.
2. Plug the AC adapter into an electrical outlet. If the battery has not been previously charged, place the handset in the base, and allow it to charge for 10-12 hours (or overnight).
3. Connect the telephone line cord to the wall jack.

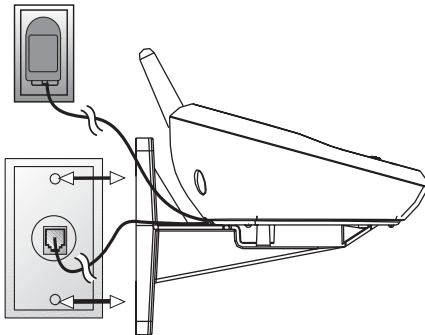

4. Line up the tabs on the wall mount bracket with the slots on the bottom of the base unit. Snap the bracket firmly in place.

5. Mount the base on the wall. Position the base unit so the mounting studs will fit into the holes on the wall mount bracket. Slide the base unit down on the mounting studs until it locks into place.

Telephone Operation

Handset Operation

</CID

- While on a call, press to decrease the volume. A double beep will sound when you reach the minimum setting.
- While phone is not in use, press to display caller ID information.
- While entering number or letters, press to delete last character entered.

☎ (phone) / FLASH

- To make a call, press then dial the number. or dial the number (use < to back-space and correct digits), then press ☎ (phone) / FLASH.
- During a call, press to receive an incoming call, if call waiting is activated.
- To answer a call, press this or any key except ☐ (off).

HOLD

- Press to put a call on hold.
- To release hold, press it again or press phone or lift the handset of an extension.

CHAN/DELETE

- Press to switch to a clear channel while on a call.
- When viewing the all log, press to delete the current record displayed.
- Press and hold to delete all calls log while handset is idle.

SELECT

- Use **SELECT** in conjunction with **PROG** during handset programming.

>/☐

- While on a call, press to increase the volume. A double beep will sound when you reach the maximum setting.
- While phone is not in use, press to display phonebook entries.
- While entering letters, press to advance cursor.

☐ (off)

- To end a call, press this key or place handset in base.
- While programming, press ☐ to exit.
- While paging, press ☐ to cancel.

REDIAL/PAUSE

- To call last number dialed, press **REDIAL/PAUSE**, then press ☎ (phone)/FLASH -OR-
- Press ☎ (phone)/FLASH then press **REDIAL/PAUSE**.
- To delete the last number dialed record, press twice while handset is idle.
- While entering numbers, press **REDIAL/PAUSE** to insert a dialing pause.

PROG

- Press to enter programming mode with handset idle (on hook).

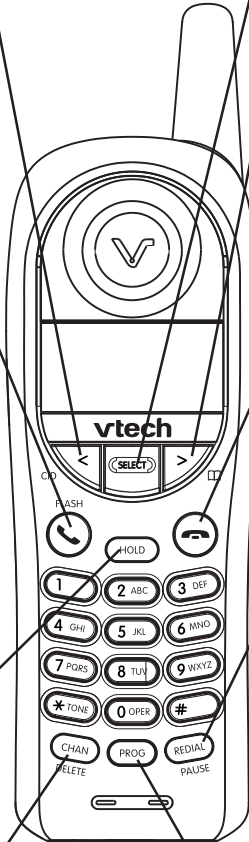

Telephone Operation

Base Operation

Message Waiting Indicator

- If you subscribe to telephone company voice mail with a visual message waiting signal, this light flashes, and **MESSAGES WAITING** displays on the handset screen when you have voice mail waiting.

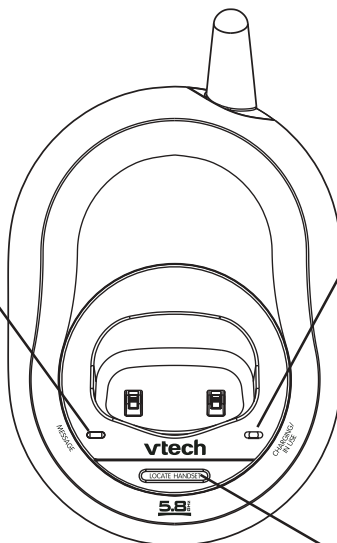

In Use/Charging Indicator

- Flashes slowly when the handset is in use.
- Flashes rapidly when a call is on hold.
- Glows steadily when the handset is charging in its base.

Page/Handset Locator

- Press to page the handsets. Press again, press  (off) on handset, or place handset in the base to cancel the page.

Telephone Operation

Handset Ringer Style/Battery Save

You can select from four different handset ringer styles, or turn the ringer off and extend the battery life.

1. Make sure the handset is off.
2. Press **PROG**.
3. Press **>** until the screen displays **RINGER:** and the current selection.
4. Press **SELECT**. The current setting blinks, and you will hear a sample of the ring.
5. Press **<** or **>** to select **RINGER: 1, 2, 3, 4** or **(off)**. You will hear a sample of each ring.
6. Press **SELECT** to choose the displayed ringer setting.

Set the Dial Mode

If you have touch tone service, the phone is ready to use as soon as the battery is charged. If you have pulse (rotary) service, you'll need to change the dial mode.

- Press **PROG** on the handset.
- Press **<** or **>** until the screen displays **DIAL MODE:** and the current selection.
- Press **SELECT**. The current setting blinks.
- Press **<** to select **TONE** or **PULSE**.
- Press **SELECT** to save the displayed mode.

Temporary Tone Dialing

If you have pulse (rotary) service only, you can change from pulse to touch tone dialing during a call by pressing * (TONE). This is useful if you need to send touch tone signals for access to telephone banking or long distance services.

1. Dial the number.
2. Press * (TONE). Buttons pressed after this send touch tone signals.
3. After you hang up, the phone automatically returns to pulse service.

Message Waiting

Your **ia 5829** is designed to work with most local and regional telephone service provider's voice messaging systems, providing alerts on both the handset and base unit when new messages come in.

Voice messaging is subscription service, available through most service providers, for a monthly fee. Contact your local telephone company for more information.

When a caller leaves a message in your voice mailbox, the **MESSAGE** light on the base unit will flash. In addition, the handset will display:

Telephone Operation

MESSAGES WAITING

5/01 5:40PM

Clear Message Waiting Alert

If you wish to manually turn off the message waiting light:

1. Press **PROG.**
2. Press **<** or **>** until screen displays **MESSAGES WAITING.**
3. Press **SELECT**, the screen displays:

LIGHT OFF: YES

4. Press **<** or **>** to change from **YES** or **NO.**
5. Press **SELECT** to choose the desired setting. You'll hear a confirmation tone.

Display Screen Messages

Screen Displays:	When:
** RINGING **	There is a call coming in.
CONNECTING. . .	The handset is waiting for a dial tone.
PHONE ON	The handset is in use.
SCANNING. . .	The handset is changing to another of the 30 channels available.
** PAGING **	The base is paging the handset.
HOLD	There is a call on hold.
BATTERY LOW	The battery needs to be recharged.
NO CONNECT	Displays and a sad tone sounds when the base power is off and ☹ (phone) / FLASH is pressed.
MESSAGES WAITING	You have been alerted by the telephone company that you have received new voice mail.
RINGER OFF	The ringer is turned off.

Speed Dial Memory

You can store up to nine telephone numbers with names (up to 15 characters and 24 digits in each location) into the speed dial memory locations you assign (1 through 9). You can also store telephone numbers with names alphabetically in the directory. See **Telephone Directory** for instructions.

NOTES:

- The entries you store in speed dial memory will be marked with 01 through 09 in the telephone directory.
- Press  (off) at any time to exit memory mode.

Store a Number/Name in Speed Dial Memory

1. Press **PROG** on the handset.
2. Press **<** or **>** until the screen displays **SPEED DIAL**.
3. Press **SELECT**. The screen displays **ENTER 1-9**.

NOTE: When memory is full the screen displays **MEMORY FULL**, an error tone sounds, and you cannot store a new number until you delete a record in speed dial memory or telephone directory.

4. Press the key (1 through 9) for the memory location where you're storing this entry. The screen displays **ENTER NAME**.

NOTE: If the location is not empty, your new entry will be stored in place of the old and the first entry will be deleted. Take caution to not save over entries you do not wish to delete from memory.

5. Using the chart below, enter up to 15 characters for the name you're storing with the number. Use **<** to backspace and make corrections; use **>** to advance and add a space.

Dial Key	Presses					
	1	2	3	4	5	6
1:	1					
2:	A	B	C	2		
3:	D	E	F	3		
4:	G	H	I	4		
5:	J	K	L	5		
6:	M	N	O	6		
7:	P	Q	R	S	7	
8:	T	U	V	8		
9:	W	X	Y	Z	9	
0:	0					
*:	*					
#:	&	'	,	-	.	#

Telephone Memory

- When you finish entering the name, press **SELECT** or **PROG**. The screen displays **ENTER NUMBER**.
- Enter the telephone number. Use **<** to backspace and make corrections. Press **REDIAL/PAUSE** to store a pause in the dialing sequence.
-OR-
Press **REDIAL/PAUSE** to display the last number dialed from this phone.
- Press **SELECT** or **PROG** to store your entry. The screen displays **DISTINCT RING?** and the current setting.
- Press **<** or **>** to change the setting. Choose **Y** (for yes) if you wish the phone to alert you to calls from this number by changing to a distinctive ringing pattern after the first ring. Choose **N** for a normal ringing pattern.
- Press **SELECT** or **PROG** to confirm your selection. If you chose **Y**, a **D** will be displayed with the memory entry.

Edit a Number/Name Stored in Memory

- Press and hold the memory location key (1 through 9) of the entry you wish to edit.
- When the screen displays the entry you want to edit, press **SELECT**. Then press **<** or **>** until **EDIT** flashes.

SPEED EDIT ERASE
8005959511
01

- Press **SELECT**. The screen displays the name and number. The cursor appears at the end of the name. Use **<**, **>** and the dial pad keys to edit the name. Press **SELECT** to move on to edit the number. Use **<** to backspace and make corrections. Press **SELECT** to move to edit the distinctive ring setting.
- Press **SELECT** to save the edited information

Delete a Number/Name Stored in Memory

- Press and hold the memory location key (1 through 9) of the entry you wish to delete.
- When the screen displays the entry you want to delete, press **SELECT**. Then press **<** or **>** until **ERASE** flashes.

SPEED EDIT ERASE
8005959511
01

- Press **SELECT**. The screen displays **ERASE NO YES** and the number.
- Press **<** or **>** until **YES** flashes.
- Press **SELECT**. You'll hear a confirmation beep.

Telephone Memory

Dial a Memory Number

1. Press and hold the memory location key (1 through 9) of the entry you wish to dial.
2. Press ☎ (**phone**) / **FLASH** to dial the displayed memory number.

Reassign Locations in Memory

1. Press and hold the memory location key (1 through 9) of the entry you wish to reassign.
2. When the screen displays the entry you want to reassign, press **SELECT**. Then press > until **SPEED** flashes.



3. Press **SELECT**. The screen displays **ENTER 1-9**.
4. Press the keys (1 through 9) to re-assign this entry into another memory location. You will hear a confirmation beep.

Telephone Directory

Your **ia 5829** can store 20 (including nine speed dial entries) telephone numbers with names (up to 15 characters for the name and 24 digits for the number in each location).

NOTE: Press  (**off**) at any time to exit directory.

Store a Number/Name in the Directory

1. Press **PROG**. The screen displays **DIRECTORY**.
2. Press **SELECT**. The screen displays **ENTER NAME**.
3. Using the chart below, enter up to 15 characters for the name you're storing with the number. Use **<** to backspace and make corrections; use **>** to advance and add a space.

Dial Key	Presses					
	1	2	3	4	5	6
1:	1					
2:	A	B	C	2		
3:	D	E	F	3		
4:	G	H	I	4		
5:	J	K	L	5		
6:	M	N	O	6		
7:	P	Q	R	S	7	
8:	T	U	V	8		
9:	W	X	Y	Z	9	
0:	0					
*:	*					
#:	&	'	,	-	.	#

4. When you finish entering the name, press **SELECT** or **PROG**. The screen displays **ENTER NUMBER**.
5. Enter the telephone number. Use **<** to backspace and make corrections. Press **REDIAL/PAUSE** to store a pause in the dialing sequence.
-OR-
Press **REDIAL/PAUSE** to display the last number dialed from this phone.
6. Press **SELECT** or **PROG**. The screen displays **DISTINCT RING?** and the current setting.
7. Press **<** or **>** to change the setting. Choose **Y** (for yes) if you wish the phone to alert you to calls from this number by changing to a distinctive ringing pattern after the

Telephone Directory

first ring. Choose **N** for a normal ringing pattern.

- Press **SELECT** or **PROG** to confirm your selection. If you chose **Y**, a **D** will be displayed with the directory entry.

NOTE: When memory is full the screen displays **MEMORY FULL**, an error tone sounds, and you will not be able to store a new number until you delete a stored number.

Edit a Number/Name Stored in the Directory

- Press **>**. The screen displays **DIRECTORY**.
- Press **<** or **>** to scroll alphabetically through the entries stored in the directory.
-OR-
Press the dial pad key for the first letter of the entry you want to edit.
- When the screen displays the entry you want to edit, press **SELECT**. Then press **<** or **>** until **EDIT** flashes.



SPEED EDIT ERASE
8005959511

- Press **SELECT**. The screen displays the name and number. The cursor appears at the end of the name. Use **<**, **>** and the dial pad keys to edit the name. Press **SELECT** to move on to edit the number. Use **<** to backspace and make corrections. Press **SELECT** to move on to edit the distinctive ring setting.
- Press **SELECT** to save the edited information.

Delete a Number/Name Stored in the Directory

- Press **>**. The screen displays **DIRECTORY**.
- Press **<** or **>** to scroll alphabetically through entries in the directory.
-OR-
Press the dial pad key for the first letter of the entry you want to delete.
- When the screen displays the entry you want to delete, press **SELECT**. Then press **<** or **>** until **ERASE** flashes.



SPEED EDIT ERASE
8005959511

- Press **SELECT**. The screen displays **ERASE NO YES** and the number. The current choice flashes.
- Press **<** or **>** until **YES** flashes.
- Press **SELECT**. You'll hear a confirmation beep.

Telephone Directory

Dial a Number from the Directory

1. Press **>**. The screen displays **DIRECTORY**.
2. Press **<** or **>** to scroll alphabetically through entries stored in directory.
-OR-
Press the dial pad key for the first letter of the entry you want to dial.
3. When the number you want to dial is displayed, press **☎ (phone)/FLASH**.

Move a Number/Name to the Memory

1. Press **>**. The screen displays **DIRECTORY**.
2. Press **<** or **>** to scroll alphabetically through directory.
— OR —
Press the dial pad key for the first letter of the entry you want to move.
3. When the screen displays the entry you want to move, press **SELECT**. Then press **>** until **SPEED** flashes.

SPEED EDIT ERASE
8005959511

4. Press **SELECT**. The screen displays **ENTER 1-9**.
5. Press the key (1 through 9) to move this entry from the normal directory to the speed dial memory and assign the memory location. You'll hear a confirmation beep. A memory location number (01 through 09) will be displayed with this entry.

Caller ID Operation

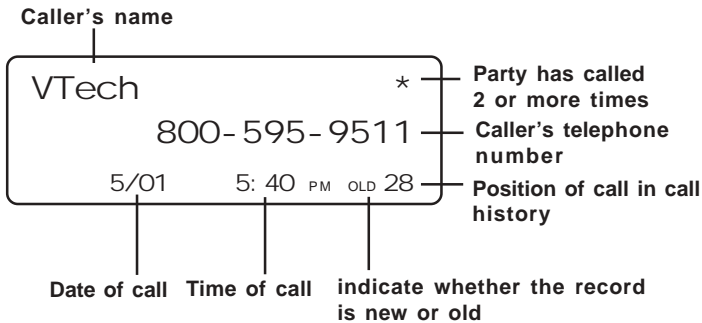

About Call History (Caller ID)

Your **ia 5829** can store up to 45 calls in its caller ID (CID) memory. The most recent call will have the highest number. When the memory is full, the oldest call will be deleted to make room for new incoming call information. For each call that comes in, the screen displays the following information between the first and second rings:

- Your caller's name (up to 15 letters are sent by your telephone company).
- The caller's area code and telephone number.
- The time and date of the call.
- The repeat tag (*) in the upper right corner, indicating the party has called more than once.

If you answer a call before the information appears on the screen, it will not be in the call history.

Review Call History

1. Press **<** (**CID**) to view call history.
2. Use **<** and **>** to scroll through records in call history.

NOTE: Press **⏻** (off) at any time to exit call history.

Delete Records from Call History

Delete a Specific Call:

1. Locate the record you want to delete from call history.
2. Press **DELETE** to delete. You'll hear a confirmation beep.

Delete All Calls:

1. With the handset in idle (off) mode, press and hold **DELETE** to delete. The screen displays **ERASE ALL NO YES**. The current choice flashes.
2. Press **>** until **YES** flashes.
3. Press **SELECT**. You'll hear a confirmation beep.

Caller ID Operation

Dial a Displayed Number

1. Locate the record in call history that you want to dial.
2. If you wish to change how the number is dialed, press **#**. The screen displays alternate dialing sequences available for this call (area code + number; 1 + area code + number; number only; 1+ number).
3. Press **SELECT**. Press **>** until **DIAL** flashes.

DI AL PROGRAM
800-595-9511
5/01 5:40PM OLD 28

4. Press **SELECT** again. The number is automatically dialed.
— OR —

When the number is correctly displayed for dialing, press **(phone)/FLASH**.

Store a Call History Record in the Directory

1. Locate the record in the call history you want to store in the directory.
2. If you wish to change how the number is stored, press **#**. The screen displays alternate dialing sequences available for this call (area code + number; 1 + area code + number; number only; 1+ number).
3. Press **SELECT**, then press **>** until **PROGRAM** flashes.

DI AL PROGRAM
800-595-9511
5/01 5:40PM OLD 28

4. Press **SELECT** three times. The screen displays:

DI STI NCT RI NG? N
8005959511
5/01 5:40PM OLD 28

5. Press **<** or **>** to select **Y** or **N** for distinctive ringer.
6. Press **SELECT**. You'll hear a confirmation beep. If you choose **Y** in step 5 a **D** will be displayed with the directory entry.

Display Screen Messages

Screen Displays: When:

PRIVATE	The other party is blocking name and/or number information.
UNKNOWN	Your phone company is unable to receive information about this caller's name and/or number.
*(after the name)	This caller has called you more than once.

Headset Operation

Your **ia 5829** handset is equipped with a 2.5mm headset jack for use with an optional accessory headset for handsfree operation. If you choose to use the headset option, you must obtain an optional accessory headset, which is compatible with the **ia 5829**.

To purchase a headset, visit us on the web at www.vtechphones.com or call VTech Customer Service at 1-800-595-9511.

Once you have a compatible 2.5mm headset, locate the headset jack on the **ia 5829** handset. Connect the plug on the headset cord to the jack (under a small rubber flap) on the cordless handset. The plug should fit securely. Do not force the connection.



NOTE:

Whenever a compatible headset is connected to the cordless handset, the microphone on the handset will be muted. This is done to limit the effect of background noise.

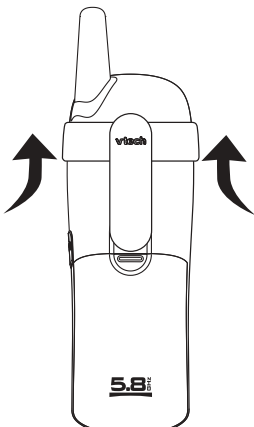

Belt Clip

The **ia 5829** is also equipped with a detachable belt clip. Align the pins on the inside edge of the clip with the notches on the sides of the handset. The belt clip should snap securely into place. Do not force the connection.

Maintenance

Taking care of your telephone

Your cordless telephone contains sophisticated electronic parts, so it must be treated with care.

Avoid rough treatment

Place the handset down gently. Save the original packing materials to protect your telephone if you ever need to ship it.

Avoid water

Your telephone can be damaged if it gets wet. Do not use the handset outdoors in the rain, or handle it with wet hands. Do not install your base unit near a sink, bathtub, or shower.

Electrical storms

Electrical storms can sometimes cause power surges harmful to electronic equipment. For your own safety, use caution when using electric appliances during storms.

Cleaning your telephone

Your telephone has a durable plastic casing that should retain its luster for many years. Clean it only with a soft cloth slightly dampened with water or a mild soap. Do not use excess water or cleaning solvents of any kind.

Remember that electrical appliances can cause serious injury if used when you are wet or standing in water. If your base unit should fall into water, **DO NOT RETRIEVE IT UNTIL YOU UNPLUG THE POWER CORD AND TELEPHONE LINE CORDS FROM THE WALL.** Then pull the unit out by the unplugged cords.

In Case of Difficulty

If you have difficulty operating your phone, the suggestions below should solve the problem. If you still have difficulty after trying these suggestions, visit us on the web at www.vtechphones.com or call VTech Communications at 1-800-595-9511. In Canada, call VTech Telecommunications Canada Ltd. at 1-800-267-7377.

The phone doesn't work at all

- Make sure the power cord is plugged in.
- Make sure the telephone line cord is plugged firmly into the base unit and the telephone wall jack.
- Make sure the batteries are properly charged. If you get a **BATTERY LOW** message or indication, the battery needs charging.

No dial tone

- First try all the suggestions above.
- If you still don't hear a dial tone, disconnect the base unit from the telephone jack and connect a different phone. If there is no dial tone on that phone either, the problem is in your wiring or local service. Contact your local telephone company.

You get noise, static, or a weak signal even when you're near the base unit

- Household appliances plugged into the same circuit as the base unit can sometimes cause interference. Try moving the appliance or the base unit to another outlet.

You get noise, static, or a weak signal when you're away from the base unit

- You may be out of range. Either move closer to the base, or relocate the base unit.
- The layout of your home may be limiting the range. Try moving the base unit to another position.

The handset does not ring when you receive a call

- Make sure you have the ringer activated. Refer to the section on **Handset Ringer Style/Battery Save** in this user's manual.
- Make sure the telephone line cord is plugged firmly into the base unit and the telephone jack. Make sure the power cord is plugged in.
- You may be too far from the base unit.
- You may have too many extension phones on your telephone line to allow all of them to ring. Try unplugging some of the other phones.

You hear other calls while using your phone

- Disconnect your base unit from the telephone jack, and plug in a regular telephone. If you still hear other calls, the problem is probably in your wiring or local service. Call your local telephone company.

In Case of Difficulty

You hear noise in the Handset, and none of the keys or buttons work

- Make sure the power cord is plugged in.

Common cure for electronic equipment

If the unit does not seem to be responding normally, then try putting the handset in the base. If it does not seem to respond, do the following (in the order listed):

1. Disconnect the power to the base.
2. Disconnect the handset battery, and spare battery, if applicable.
3. Wait a few minutes.
4. Connect power to the base.
5. Reinstall the battery(ies).
6. Wait for the handset to re-establish its link with the base. To be safe, allow up to one minute for this to take place.

Warranty Statement

What does this limited warranty cover?

- The manufacturer of this VTech product, VTech Communications, warrants to the holder of a valid proof of purchase (“Consumer” or “you”) that the product and all accessories provided by VTech in the sales package (“Product”) are free from material defects in material and workmanship, pursuant to the following terms and conditions, when installed and used normally and in accordance with operation instructions. This limited warranty extends only to the Consumer for Products purchased and used in the United States of America.

What will VTech Communications do if the Product is not free from material defects in materials and workmanship during the limited warranty period (“Materially Defective Product”)?

- During the limited warranty period, VTech’s authorized service representative will repair or replace at VTech’s option, without charge, a Materially Defective Product. If we repair this product, we may use new or refurbished replacement parts. If we choose to replace this product, we may replace it with a new or refurbished product of the same or similar design. VTech will return repaired or replacement products to you in working condition. VTech will retain defective parts, modules, or equipment. Repair or replacement of Product, at VTech’s option, is your exclusive remedy. You should expect the repair or replacement to take approximately 30 days.

How long is the limited warranty period?

- The limited warranty period for the product extends for ONE (1) YEAR from the date of purchase if we repair or replace a Materially Defective Product under the terms of this limited warranty. This limited warranty also applies to repaired or replacement Products for a period of either (a) 90 days from the date the repaired or replacement Product is shipped to you or (b) the time remaining on the original one-year warranty; whichever is longer.

What is not covered by this limited warranty?

This limited warranty does not cover:

1. Product that has been subjected to misuse, accident, shipping or other physical damage, improper installation, abnormal operation or handling, neglect, inundation, fire, water or other liquid intrusion; or
2. Product that has been damaged due to repair, alteration or modification by anyone other than an authorized service representative of VTech; or
3. Product to the extent that the problem experienced is caused by signal conditions, network reliability or cable or antenna systems; or
4. Product to the extent that the problem is caused by use with non-VTech electrical accessories; or
5. Product whose warranty/quality stickers, Product serial numbers plates or electronic serial numbers have been removed, altered or rendered illegible; or
6. Product purchased, used, serviced or shipped for repair from outside the United States, or used for commercial or institutional purposes (including but not limited to Products used for rental purposes); or
7. Product returned without valid proof of purchase (see 2 below); or
8. Charges for installation or set up, adjustment of customer controls and installation or repair of systems outside the unit.

Warranty Statement

How do you get warranty service?

- To obtain warranty service in the United States of America, call 1-800-595-9511 for instructions regarding where to return the Product. Before calling for service, please check the user's manual. A check of the Product controls and features may save you a service call.
- Except as provided by applicable law, you assume the risk of loss or damage during transit and transportation and are responsible for delivery or handling charges incurred in the transport of Product(s) to the service location. VTech will return repaired or replaced product under this limited warranty to you, transportation, delivery or handling charges prepaid. VTech assumes no risk for damage or loss of the Product in transit.
- If the Product failure is not covered by this limited warranty, or proof of purchase does not meet the terms of this limited warranty, VTech will notify you and will request that you authorize the cost of repair prior to any further repair activity. You must pay for the cost of repair and return shipping costs for the repair of Products that are not covered by this limited warranty.

What must you return with the Product to get warranty service?

1. Return the entire original package and contents including the Product to the VTech service location along with a description of the malfunction or difficulty;
2. Include "valid proof of purchase" (sales receipt) identifying the Product purchased (Product model) and the date of purchase or receipt; and
3. Provide your name, complete and correct mailing address, and telephone number.

Other Limitations

- This warranty is the complete and exclusive agreement between you and VTech. It supersedes all other written or oral communications related to this Product. VTech provides no other warranties for this product. The warranty exclusively describes all of VTech's responsibilities regarding the product.

There are no other express warranties. No one is authorized to make modifications to this limited warranty and you should not rely on any such modification.

State Law Rights: This warranty gives you specific legal rights, and you may also have other rights which vary from state to state.

Limitations: Implied warranties, including those of fitness for a particular purpose and merchantability (an unwritten warranty that the product is fit for ordinary use) are limited to one year from date of purchase. Some states do not allow limitations on how long an implied warranty lasts, so the above limitation may not apply to you.

- In **no** event shall VTech be liable for any indirect, special, incidental, consequential, or similar damages (including, but not limited to lost profits or revenue, inability to use the product, or other associated equipment, the cost of substitute equipment, and claims by third parties) resulting from the use of this product. Some states do not allow the exclusion or limitation of incidental or consequential damages, so the above limitation or exclusion may not apply to you.

FCC, ACTA and IC Regulations

This equipment complies with Parts 15 of the Federal Communications Commission (FCC) rules for the United States. It also complies with regulations RSS210 and CS-03 of Industry and Science Canada. Operation is subject to the following two conditions: (1) this device may not cause interference, and (2) this device must accept any interference, including interference that may cause undesired operation of the device.

A label is located on the underside of the Base Unit containing either the FCC registration number and Ringer Equivalence Number (REN) or the IC registration number and Load Number. You must, upon request, provide this information to your local telephone company.

This equipment is compatible with inductively coupled hearing aids.

Should you experience trouble with this telephone equipment, please contact: **VTech Communications Inc. CUSTOMER SERVICE at 1-800-595-9511. In Canada, call VTech Telecommunications Canada Ltd. at 1-800-267-7377** for repair/warranty information. The telephone company may ask you to disconnect this equipment from the line network until the problem has been corrected.

FCC Part 15

Warning: Changes or modifications to this unit not expressly approved by the party responsible for compliance could void the user's authority to operate the equipment. The equipment has been tested and found to comply with part 15 of the FCC rules. These limits are designed to provide reasonable protection against harmful interference in a residential installation. This equipment generates, uses and can radiate radio frequency energy and, if not installed and used in accordance with the instructions, may cause harmful interference to radio communications. However, there is no guarantee that interference will not occur in a particular installation. If this equipment does cause harmful interference to radio or television reception, which can be determined by turning the equipment off and on, the user is encouraged to try and correct the interference by one or more of the following measures:

- Reorient or relocate the receiving antenna.
- Increase the separation between the equipment and receiver.
- Connect the equipment into an outlet or on a circuit different from that to which the receiver is connected.
- Consult the dealer or an experienced radio/TV technician for help.

To ensure safety of users, the FCC has established criteria for the amount of radio frequency energy that can be safely absorbed by a user or bystander according to the intended usage of the product. This product has been tested and found to comply with the FCC criteria. The handset has such a low power that it does not require testing. It may be safely held against the ear of the user. The base unit shall be installed & used such that parts of the user's body other than the hands should be maintained at a comfortable distance of approximately 20 cm or more.

FCC and ACTA Information

If this equipment was approved for connection to the telephone network prior to July 23, 2001, it complies with Part 68 of the Federal Communications Commission (FCC) rules. If the equipment was approved after that date, it complies with the Part 68 rules and with Technical Requirements for Connection of Equipment to the Telephone Network adopted by the Administrative Council for Terminal Attachments (ACTA). We are required to provide you with the following information.

FCC, ACTA and IC Regulations

1. Product identifier and REN information

The label on the back or bottom of this equipment contains, among other things, an identifier indicating product approval and the Ringer Equivalence Number (REN). This information must be provided to your local telephone company upon request. For equipment approved prior to July 23, 2001, the product identifier is preceded by the phrase "FCC Reg No." and the REN is listed separately. For equipment approved after that date, the product identifier is preceded by "US" and a colon (:), and the REN is encoded in the product identifier without a decimal point as the sixth and seventh characters following the colon. For example, the product identifier US:AAAEQ03T123XYZ would indicate an REN of 0.3.

The REN is used to determine how many devices you may connect to your telephone line and still have them ring when you are called. In most, but not all areas, the sum of all RENs should be five (5.0) or less. For more information, please contact your local telephone company.

2. Connection and use with the nationwide telephone network

The plug and jack used to connect this equipment to the premises wiring and the telephone network must comply with the applicable Part 68 rules and technical requirements adopted by ACTA. A compliant telephone cord and modular plug is provided with this product. It is designed to be connected to a compatible modular jack that is also compliant. An RJ11 jack should normally be used for connecting to a single line and an RJ14 jack for two lines. See Installation Instructions in this user's manual. This equipment may not be used with Coin Telephone Lines or with Party Lines. If you have specially wired alarm dialing equipment connected to your telephone line, ensure the connection of this equipment does not disable your alarm equipment. If you have questions about what will disable alarm equipment, consult your telephone company or a qualified installer.

3. Repair instructions

If this equipment is malfunctioning, it must be unplugged from the modular jack until the problem has been corrected. Repairs to this telephone equipment can only be made by the manufacturer or its authorized agents. For repair procedures, follow the instructions outlined under the Limited Warranty.

4. Rights of the telephone company

If this equipment is causing harm to the telephone network, the telephone company may temporarily discontinue your telephone service. The telephone company is required to notify you before interrupting service. If advance notice is not practical, you will be notified as soon as possible. You will be given the opportunity to correct the problem and the telephone company is required to inform you of your right to file a complaint with the FCC. Your telephone company may make changes in its facilities, equipment, operation, or procedures that could affect the proper functioning of this product. The telephone company is required to notify you if such changes are planned.

5. Hearing aid compatibility

If this product is equipped with a corded or cordless handset, it is hearing aid compatible.

6. Programming/testing of emergency numbers

If this product has memory dialing locations, you may choose to store police, fire department and emergency medical service telephone numbers in these locations. If you do, please keep three things in mind:

- a. We recommend that you also write the telephone number on the directory card, so that you can still dial the emergency number manually if the memory dialing

FCC, ACTA and IC Regulations

feature doesn't work.

- b. This feature is provided only as a convenience, and the manufacturer assumes no responsibility for customer reliance upon the memory feature.
- c. Testing the emergency telephone numbers you have stored is not recommended. However, if you do make a call to an emergency number:
 - You must remain on the line and briefly explain the reason for the call before hanging up.
 - Programming/testing of emergency numbers should be performed during off-peak hours, such as in the early morning or late evening, when the emergency services tend to be less busy.

IC (Industry Canada)

This telephone is registered for use in Canada.

The term "IC:" before the radio certification number only signifies that Industry Canada technical specifications were met.

Notice: This equipment meets the applicable Industry Canada Terminal Equipment Technical Specifications. This is confirmed by the registration number. The abbreviation, IC, before the registration number signifies that registration was performed based on a Declaration of Conformity indicating that Industry Canada technical specifications were met. It does not imply that Industry Canada approved the equipment.

Notice: The Ringer Equivalence Number (REN) for this terminal equipment is 0.1. The REN assigned to each terminal equipment provides an indication of the maximum number of terminals allowed to be connected to a telephone interface. The termination on an interface may consist of any combination of devices subject only to the requirement that the sum of the Ringer Equivalence Numbers of all the devices does not exceed five.

Before installing this equipment, users should ensure that it is permissible to be connected to the facilities of the local telecommunications company. The equipment must also be installed using an acceptable method of connection. The customer should be aware that compliance with the above conditions may not prevent degradation of services in some situations.

Repairs to certified equipment should be made by an authorized Canadian maintenance facility designated by the Supplier. Any repairs or alterations made by the user to this equipment, or equipment malfunctions, may give the telecommunications company cause to request the user to disconnect the equipment.

Users should ensure for their own protection that the electrical ground connections of the power utility, telephone lines and internal metallic water pipe system, if present, are connected together. This precaution may be particularly important in rural areas.

Caution: Users should not attempt to make such connections themselves, but should contact the appropriate electrical inspection authority or electrician as appropriate.

Your Cordless Phone is designed to operate at the maximum power allowed by the FCC and IC. This means your Handset and Base Unit can communicate only over a certain distance - which will depend on the location of the Base Unit and Handset, weather, and the construction and layout of your home or office.

Technical Specifications

FREQUENCY CONTROL

Crystal controlled
PLL synthesizer

TRANSMIT FREQUENCY

Base: 912.75 - 917.10 MHz
Handset: 5863.80 - 5872.50 MHz

RECEIVE FREQUENCY

Base: 5863.80 - 5872.50 MHz
Handset: 912.75 - 917.10 MHz

CHANNELS

30 Channels

NOMINAL EFFECTIVE RANGE

Maximum power allowed by FCC and IC. Actual operating range may vary according to environmental conditions at the time of use.

SIZE

Handset: 193mm x 58mm x 36.7mm

Base: 182mm x 113mm x 88.3mm

WEIGHT

Handset: 159g (without battery pack)

Base: 205 gram (without adaptor and wallmount)

POWER REQUIREMENTS

Handset: 3.6V 600mAh Ni-MH Battery

Base: 9V DC @ 300mA

MEMORY

Speed Dial: 9 Memory locations; up to 24 digits, 15 characters per location

Directory: 20 Memory locations; up to 24 digits, 15 characters per location

CID: 45 Memory locations

SPECIFICATIONS ARE TYPICAL AND MAY CHANGE WITHOUT NOTICE.

vtech

VTECH TELECOMMUNICATIONS LTD.

vtech

A member of THE VTECH GROUP OF COMPANIES.

Distributed in the U.S.A. by VTech Communications, Inc. Beaverton,
Oregon, 97008

Distributed in Canada by VTech Telecommunications Canada Ltd. 200-7671
Alderbridge Way, Richmond, B.C. V6X 1Z9.

Copyright 2004 for VTECH TELECOMMUNICATIONS LTD.
Printed in China

91-000175-010-000
ISSUED 0

Congratulations on your purchase
of this VTech product

NEED HELP?

Our representatives are here
to help you with any questions
concerning the operation of this
product, available accessories,
or any other related issues.

Call Toll Free:

1-800-595-9511

In Canada, Call:

1-800-267-7377

or visit our website at
www.vtechphones.com

CORDLESS Troubleshooting TAGS

250 De-register and register

De-register handset from the E2525, E2600B and E2555

Please take the Handset out of the Base before de-registering. Using the [SOFT] Keys on the Base, press MENU, then press the Down arrow twice until BASE SETTINGS is highlighted. Press OK, then press MUTE 3 times and FLASH twice. This will deregister the unit, please see more info to re-register.

Adding Handsets / Registering Handsets

Your telephone can accommodate up to 8 cordless Handsets. You can add new Handsets (Model E250, sold separately) at any time, but each must be registered with the Base before use.

Before using a new Handset, you must register it with the Base. There will be an R in the upper left hand corner of the display. The Display will read "ENTER BASE ID". Use the keypad on the Handset to enter Base ID. (To find this number, go to the Base, press [MENU], scroll down to select DISPLAY BASE ID, then press OK.) Once you have entered the Base ID number, press OK (middle key under the display). The unit will display "SEARCHING FOR BASE" and then "FOUND BASE". Your Handset will then be ready to use.

The Handset provided with your telephone is automatically registered as Handset 1. Additional Handsets will be assigned numbers in the order they are registered (2, 3, 4, etc.) up to a maximum of eight.

De-register 250 from the E2520 Base

Take the Handset out of the Base, press [*] [*] [3] [3] [5] [7] [8] [2] on the Base. This will de-register all of the Handsets at one time. See more information to register them again.

NOTE: The Base ID code is located on the bottom of the Base.

Adding new Handsets / registering the Handset

Your telephone can accommodate up to 8 cordless Handsets. You can add new Handsets (Model E250, sold separately) at any time, but each must be registered with the Base before use.

Before using a new Handset, you must register it with the Base. There will be an R in the upper left hand corner of the Display. The Display will read "ENTER BASE ID". Use the keypad on the Handset to enter the Base ID. (To find this number, go to the Base, on the bottom of the Base will be a white sticker that reads BS ID CODE. The code will start with a 36. Once you have entered the Base ID number, press OK (middle key under the display). The unit will display "SEARCHING FOR BASE" and then "FOUND BASE". Your Handset will then be ready to use.

The Handset provided with your telephone is automatically registered as Handset 1. Additional Handsets will be assigned numbers in the order they are registered (2, 3, 4, etc.) up to a maximum of eight.

Keypad Tone Feature - Vtech Telephones

When the Keypad Tone Feature is ON but the handset is OFF (i.e. in standby):

You will hear loud tones being emitted through the external speaker on the back of the handset when you press any handset button except for the volume key.

When the Keypad Tone Feature is ON and the handset is ON (i.e. you pressed the [PHONE] button to make a call, you have dial tone and you are NOT on the Speakerphone):

1. You will hear the tones from the number buttons ([0] - [9]), the asterisk ([*]), the pound ([#]), and the [SOUND SELECT] button ONLY through the earpiece on the handset (the receiver / internal speaker).

a) The earpiece on the handset (the receiver / internal speaker) is where you hear the dial tone. The above key tones will have the same approximate volume as the dial tone.

b) You WILL NOT hear these tones loudly through the external speaker on the back of the handset.

2. You will hear the loud tones from the [PHONE/FLASH] button, the [OFF] button, the [SOFTKEY] buttons (the 2 unnamed buttons under the display), and the [SPEAKER] button being emitted through the external speaker located on the back of the handset.

When the Keypad Tone Feature is OFF and the handset is OFF (i.e. in standby):

You will not hear any key tones from any handset buttons.

When the Keypad Tone Feature is OFF and the handset is ON (i.e. you have pressed the [PHONE] button to make a call, you have dial tone and you are NOT on the Speakerphone):

1. You WILL hear the tones from the number buttons ([0] - [9]), the asterisk ([*]), the pound ([#]), and the [SOUND SELECT] button through the earpiece on the handset (the receiver/internal speaker). This is NORMAL operation.

a) The above key tones will have the same approximate volume as the dial tone.

b) You WILL NOT hear these tones being emitted through the external speaker located on the back of the handset.

c) You will not hear any tones from the [SOFTKEY] buttons (the two unnamed buttons under the display), or the [SPEAKER] button.

When the Keypad Tone Feature is OFF and the Speakerphone on the handset is ON:

1. You WILL hear the tones from the number buttons ([0] - [9]) emitted through the external speaker on the back of the handset.

a) When the speakerphone is on, this is also where you hear the dial tone emitted.

b) The above key tones will have the same approximate sound and volume as the dial tone.

2. You will not hear any tones from the [SOUND SELECT] button, the [SOFTKEY] buttons (the two unnamed buttons under the display), or the [SPEAKER] button.

When the Keypad Tone Feature is ON and the Speakerphone on the handset is ON:

1. You will hear the tones from the number buttons ([0] - [9]), the [SOFTKEY] buttons (the two unnamed buttons under the display), the [SPEAKER] button, the [PHONE]

button, and the [OFF] button emitted through the external speaker on the back of the handset.

2. You will not hear any tone when you press the [SOUND SELECT] button.

Keypad Tone Feature

When the Keypad Tone Feature is ON but the handset is OFF (i.e. in standby):

You will hear loud tones being emitted through the external speaker on the back of the handset when you press any handset button except for the volume key.

When the Keypad Tone Feature is ON and the handset is ON (i.e. you pressed the [PHONE] button to make a call, you have dial tone and you are NOT on the Speakerphone):

1. You will hear the tones from the number buttons ([0] - [9]), the asterisk ([*]), the pound ([#]), and the [SOUND SELECT] button ONLY through the earpiece on the handset (the receiver / internal speaker).

a) The earpiece on the handset (the receiver / internal speaker) is where you hear the dial tone. The above key tones will have the same approximate volume as the dial tone.

b) You WILL NOT hear these tones loudly through the external speaker on the back of the handset.

2. You will hear the loud tones from the [PHONE/FLASH] button, the [OFF] button, the [SOFTKEY] buttons (the 3 unnamed buttons under the display), the [XFER/INTERCOM] button and the [SPEAKER] button being emitted through the external speaker located on the back of the handset.

When the Keypad Tone Feature is OFF and the handset is OFF (i.e. in standby):

You will not hear any key tones from any handset buttons.

When the Keypad Tone Feature is OFF and the handset is ON (i.e. you have pressed the [PHONE] button to make a call, you have dial tone and you are NOT on the Speakerphone):

1. You WILL hear the tones from the number buttons ([0] - [9]), the asterisk ([*]), the pound ([#]), and the [SOUND SELECT] button through the earpiece on the handset (the receiver/internal speaker). This is NORMAL operation.

a) The above key tones will have the same approximate volume as the dial tone.

b) You WILL NOT hear these tones being emitted through the external speaker located on the back of the handset.

c) You will not hear any tones from the [SOFTKEY] buttons (the three unnamed buttons under the display), the [XFER/INTERCOM] button or the [SPEAKER] button.

When the Keypad Tone Feature is OFF and the Speakerphone on the handset is ON:

1. You WILL hear the tones from the number buttons ([0] - [9]) emitted through the external speaker on the back of the handset.

a) When the speakerphone is on, this is also where you hear the dial tone emitted.

b) The above key tones will have the same approximate sound and volume as the dial tone.

2. You will not hear any tones from the [SOUND SELECT] button, the [SOFTKEY] buttons (the three unnamed buttons under the display), the [XFER/INTERCOM] button, or the [SPEAKER] button.

When the Keypad Tone Feature is ON and the Speakerphone on the handset is ON:

1. You will hear the tones from the number buttons ([0] - [9]), the [SOFTKEY] buttons (the three unnamed buttons under the display), the [XFER/INTERCOM] button, the [SPEAKER] button, the [PHONE] button, and the [OFF] button emitted through the external speaker on the back of the handset.
2. You will not hear any tone when you press the [SOUND SELECT] button.

5860 Ringer On/Melody Selection

Turn Ringer On

1. Press any [NavKey] button to get to the Handset Menu.
2. Press the left, right, up or down [NavKey] button to highlight Sounds and Alerts (handset with musical note icon), then press the center [NavKey] button to select.
3. Press the left, right, up or down [NavKey] to highlight Ringer Control (the bell icon), then press the center NavKey button to select.
4. Press the down [NavKey] button to highlight RINGER.
5. Press the left or right [NavKey] button to change the ringer status from Off to On.
6. Press the [SOFT] Key under SAVE.

Choose Ringer Melodies

1. Press any [NavKey] button to get to the Handset Menu.
2. Press the left, right, up or down [NavKey] button to highlight Sounds and Alerts (handset with musical note icon), then press the center [NavKey] button to select.
3. Press the left, right, up or down [NavKey] to highlight Ringers (the musical note icon), then press the center [NavKey] button to select.
4. Press the up or down [NavKey] button to highlight the different melodies. You will hear a sample of the melody you have highlighted.
5. Press the [SOFT] Key under SAVE when you have chosen the melody you want.

Adjust Ringer Volume

1. Press any [NavKey] button to get to the Handset Menu.
2. Press the left, right, up or down [NavKey] button to highlight Sounds and Alerts (handset with musical note icon), then press the center [NavKey] button to select.
3. Press the left, right, up or down [NavKey] button to highlight RINGER CONTROL (the bell icon), then press the center button of the [NavKey] to select.
4. Press the left or right [NavKey] button to select the volume level. With each press of the button a sample of the volume is played.
5. Press the [SOFT] Key under SAVE.

To access the complete owner's manual. Click on the Red Top icon (located in the upper right hand corner of this page).

2256/1256 - 2325/2365 Replace

This process is only to be used for the models 2256/1256, 2325, 2365 on the symptoms below:

- Every call customer hears pause in conversation, other end hears beeps.

·Every call conversation cuts in and out, other end hears beeps.

1. Advise the customer that you (the rep) will place a no charge replacement order that will be shipped via UPS service, which should arrive within 14 days. Advise the customer that they will also receive a prepaid ARS label sent via US Mail to return their original unit (no charge will be incurred by the customer).

2. The rep will be responsible for placing the order for the unit using the EXCHANGE-IW promo code in COPS and changing the shipping method to Free Shipping.

3. After placing the order, send an internal referral commitment to the [AAT ARS LABEL] team.

If you have any questions regarding this information, please see your supervisor. It is very important that every one understands this process and begins using it immediately.

NOTE: THE CUSTOMER MAY RECEIVE A 2256 FOR A 1256. THE TWO MODELS ARE IDENTICAL.

NOTE: THE CUSTOMER MAY RECEIVE A 2325 FOR A 2365. THE TWO MODELS ARE IDENTICAL.

T-Switch

A standard hearing aid consists of a high gain amplifier between a microphone and receiver. If you put a cup over the ear such as a telephone handset, there is serious feedback and squealing. The remedy is to add a "T-Switch" in the hearing aid that disconnects the microphone and replaces it with a coil of wire. The phone receiver also has a coil of wire (HAC coil), and so these two coils form a transformer when they are in close proximity. Transformers transmit the signal magnetically rather than acoustically. The T-Coil in the hearing aid picks up any magnetic energy in close proximity. Spread spectrum phones produce a magnetic field when the RF transmitter turns on and off repeatedly. This magnetic energy can be picked up as static or hum in a hearing aid, but is usually a much lower level than the intended audio transmitted from the HAC coil. Generally, non-spread spectrum phones will perform better with hearing aids.

process for T2406 calls

If the customer has had his or her unit longer than 45 days:

1. Advise the customer to mail his or her entire product to the San Antonio Returns Center using the normal in warranty repair shipping and return process.

2. Advise the customer that upon receiving his or her telephone product at our San Antonio Returns Center, he or she will receive a similar or upgraded replacement model within 3 business days.

If the customer has had his or her unit less than 45 days or refuses to pay shipping costs to return their product for in warranty service:

Do not send the customer back to the retailer. Offer to issue a replacement order and send a prepaid ARS label via US Mail for him or her to ship their original product back at no charge to them.

· If this is the case, it will be necessary for you to place an order for the VTech T2406 using the EXCHANGE-IW promo code in COPS and use regular standard shipping. (The customer will receive the replacement within 3-Business days.)

· After placing the order, send an internal referral commitment to the [VTECH ARS LABEL] team for a prepaid UPS ARS Label to be sent to the customer.

NOTE: DO NOT SEND THESE CUSTOMERS BACK TO THE RETAILER FOR REPLACEMENT (EVEN IF THEY ARE WITHIN THE FIRST 30 DAYS OF PURCHASE). IT IS IMPORTANT THAT YOU FOLLOW THIS PROCESS.

Process for gz2434 Calls

If customers call with the one or more of the following symptoms: Static/Noise; Five Beeps; Call is Fading or Cutting In and Out; No Connect and the final resolution is repair, follow the below steps:

1. Advise the customer that you will place a no charge replacement order that will be shipped via express service, which should arrive within 1-3 business days. Advise the customer that they will also receive a prepaid UPS ARS label sent via US Mail to return their original unit (no charges will be incurred by the customer).

2. You will need to place a no charge replacement order for the VTech GZ2434 using the CSAT promotion code in COPS and change the shipping method to Free Shipping-Overnight (manager use only) \$0.

3. After placing the order, it will be necessary to send an internal referral commitment to the [VTECH ARS LABEL] team requesting an ARS label be sent to the customer.

If the customer is not satisfied with the express shipped replacement, offer to extend their manufacture's warranty for 6 months (this is different than a Protection Plan; Protection Plans should never be given out as a negotiation method).

Turning Message Light Off

If the Message Light on the Base does not go off even after you've listened to voice mail messages:

1. Press [PROG/CHAN].

2. Press [>] until the screen displays: MESSAGES WAITING.

3. Press [SELECT]. The screen displays: LIGHTS OFF: YES.

4. Press [SELECT] again to turn off the Message Waiting Light on Base.

2600 De-Register

2600 registered to a 2651

· In the idle mode, at the Base Unit keypad, press [*] [*] [3] [3] [5] [7] [8] [2].

2600 registered to a 2656 or 2670

· Unplug power from the Base.

· Hold down [PAGE] while reconnecting power. When the In Use Light blinks, release the [PAGE] key.

· Hold down [PAGE] for 5 seconds. When the In Use Light begins to flash, release the [PAGE] key.

· The Handset Charging Light will blink 5 times. Within 5 seconds from when it stops blinking, press [PAGE] once

Registration of the 2600

· After charging the Handset, remove it from its Charge Cradle. If the screen displays SEARCHING FOR BASE, Press NEW. If the screen displays ENTER BASE ID, go to step 2.

·Enter the 15 digit Base ID Code, located on the underside of the Base Unit. The ID Code can include numbers (0-9) and characters (*,#).

·Press OK. The Handset will display: PLEASE WAIT!

·Wait approximately 15 seconds. The Handset will display FOUND BASE.

NOTE: Occasionally, it will take longer than 15 seconds for the Handset to find the Base Unit. This is normal.

If the Handset displays: BASE BUSY TRY LATER, this indicates that the system is in use. Wait until the Base Unit is in the idle (on hook) mode, and repeat steps 2 to 4.

Explanation of Why the TeleZapper Should Be Set On 'BASIC' to avoid interference with an Answering System

Once the Answering System picks up the line, the TeleZapper also seizes the line and generates the tones which 'zap' telemarketers. When the TeleZapper is in 'advanced' mode, the tones can stay on the line long enough that the Answering System may think that an extension phone has been picked up (depending on the Answering System). If this happens, the Answering System's Call Intercept/Interrupt feature will stop the recording of the message, and since no extension has actually been picked up, the call will be disconnected.

Twisted Pair Cords

Twisted pair cords are a type of phone cord wires used to reduce interference/crosstalk between lines. Twisted pair cords consist of two insulated copper wires which are twisted around each other to reduce interference from one wire to the other. The twisting of the wire pairs is what reduces the interference.

Dual-Band Frequency

Our unit does utilize both the 5.8 and 2.4 GHz frequency bands simultaneously. The dual-band technology provides a clear advantage over existing cordless phones in its ability to avoid interference and provide optimal clarity in both received and transmitted audio.

Since transmitting in the 5.8 GHz frequency requires more power, the Base station transmits with the 5.8 GHz band (since it remains plugged to a power outlet all the time), while the battery-operated Handset transmits in the 2.4 GHz band, so it can yield optimum talk-time performance between battery charges.

Language Conversion

VT5831 LANGUAGE CONVERSION OF HANDSET MENUS

ENGLISH

SPANISH

FRENCH

CALLS LOG

GUIA DE LLAMADAS

REGISTRE D'APPEL

INTERCOM

INTERCOMUNICADOR

INTERPHONE

HANDSET SETTINGS

CONFIG AURICULAR

REGLAGES COMBINE

SET TIME
PONER TIEMPO
REGLER L'HEURE
CLOCK MODE
MODO RELOJ
MODE HORLOGE
REGISTER
REGISTRAR
REGISTRE
RINGER VOLUME
TIMBRE VOLUMEN
SONNERIE VOLUME
RINGER MELODY
TIPO DE TIMBRE
SONNERIE MELODIE
VIBRATE CONTROL
CTRL VIBRACION
MODE VIBRATION
LOW BATT TONE
TONO DE BAT BAJA
SON PILE FAIBLE
RANGE TONE
TONO DE RANGO
SON DE PORTEE
KEYPAD TONE
TONO DE DECLADO
SON DU CLAVIER
CONTRAST
CONTRASTE
CONTRASTE
LANGUAGE
IDIOMA
LANGUE
TO CHANGE HANDSET MENU FROM SPANISH:
Press MENU.
Scroll down to CONFIG AURICULAR. Press OK.
Scroll down to IDIOMA. Press OK.
Scroll up to INGLES (English) or scroll down to FRANCES (French). Press OK.
TO CHANGE HANDSET MENU FROM FRENCH:
Press MENU.
Scroll down to REGLAGES COMBINE. Press OK.
Scroll down to LANGUE. Press OK.
Scroll up to ANGLAIS (English) or ESPAGNOLE (Spanish). Press OK.
LANGUAGE CONVERSION OF BASE MENUS
ENGLISH
SPANISH

FRENCH
CALLS LOG
GUEA DE LLAMADAS
REGISTRE D'APPEL
BASE SETTINGS
CONFIG BASE
REGLAGES BASE
DISPLAY BASE-ID
NUMERO DE BASE
NUMERO DE BASE
RINGER VOLUME
TIMBRE VOLUMEN
SONNERIE VOLUME
RINGER MELODY
TIPO DE TIMBRE
SONNERIE MELODIE
KEYPAD TONE
TONO DE DECLADO
SON DU CLAVIER
TONE/PULSE
TONOS/PULSOS
TONALITE/IMPUL
CONTRAST
CONTRASTE
CONTRASTE
LANGUAGE
IDIOMA
LANGUE

TO CHANGE BASE MENU FROM SPANISH:

Press MENU.

Scroll down to CONFIG BASE. Press OK.

Scroll down to IDIOMA. Press OK.

Scroll up to INGLES (English) or scroll down to FRANCES (French). Press OK.

TO CHANGE BASE MENU FROM FRENCH:

Press MENU.

Scroll down to REGLAGES BASE. Press OK.

Scroll down to LANGUE. Press OK.

Scroll up to ANGLAIS (English) or ESPAGNOL (Spanish). Press OK.

2461 De-register

There are 2 different versions of this unit. If the customer has a tone/pulse switch on the bottom of the Base, please use one of the procedures for Mk1. If they do not have a tone/pulse switch on the bottom of the set, please use the procedure for Mk2a.

VT2461 Mk1 DEREGISTER ALL HANDSETS

1. Unplug power from the Base. Remove spare battery pack.
2. Hold down [PAGE] while reconnecting power. When the POWER light begins to blink, release the [PAGE] key.

3. Hold down [PAGE] key for 5 seconds. When the LINE IN USE light begins to flash, release the [PAGE] key.
4. The HANDSET CHARGING light will blink 5 times. Within 5 seconds from when it stops blinking, press [PAGE] once.

VT2461 Mk1 DEREGISTER A SINGLE HANDSET

1. Unplug power from the Base. Remove spare battery pack.
2. Hold down [PAGE] while reconnecting power. When the POWER light begins to blink, release the [PAGE] key.
3. Press [PAGE] 1 to 4 times, corresponding to the Handset you wish to deregister.
4. Once you complete step #3, the HANDSET CHARGING light will blink back to you the number of times corresponding to the Handset you wish to deregister. Within 5 seconds from when it stops blinking, press [PAGE] once.

VT2461 Mk2a

1. Unplug power from the Base. Remove spare battery pack.
 2. Hold down [PAGE] while reconnecting power. When the Base Display says 'Pr', release [PAGE].
 3. Press [MENU]. The Display will say 'rh'.
 4. Press [SELECT] to choose h1, h2, h3, h4 or AL (all).
 5. Press [TIME/SET] to confirm.
- Unplug power from the Base, then reconnect power to complete deregistration.

2455 De-register

DEREGISTER ALL HANDSETS

1. Unplug power from the Base. Remove spare battery pack.
2. Hold down [PAGE] while reconnecting power. When the POWER light begins to blink, release the [PAGE] key.
3. Hold down [PAGE] for 5 seconds. When the LINE IN USE light begins to flash, release the [PAGE] key.
4. The HANDSET CHARGING light will blink 5 times. Within 5 seconds from when it stops blinking, press [PAGE] once.

DEREGISTER A SINGLE HANDSET

1. Unplug power from the Base. Remove spare battery pack.
2. Hold down [PAGE] while reconnecting power. When the POWER light begins to blink, release the [PAGE] key.
3. Press [PAGE] 1 to 4 times, corresponding to the Handset you wish to deregister.
4. Once you complete step #3, the HANDSET CHARGING light will blink back to you the number of times corresponding to the Handset you wish to deregister. Within 5 seconds from when it stops blinking, press [PAGE] once.

8 inch 4 conductor line cord

Perform the following:

- Advise the customer that we will send him a replacement 8 inch 4 conductor line cord.
- Inform the customer that he or she will receive the new replacement cord in U.S. Mail.
- Verify and update the customer's profile with all address and telephone information.
- Place an internal referral request via CRSS to Research Advisor to place an order for the replacement line cord.

Perform the following:

- Advise the customer that you are sending him or her a brand new replacement set (Cordless 2230 or 2255 whichever the customer has). If the customer does not want the replacement, advise him or her to return their unit to the place of purchase. Stop! If the customer accepts the replacement 2230/2255 continue....
- Inform the customer that he or she will receive the new replacement set(s) within 14 business days. Explain that you will also send an ARS label (via US Mail) for him or her to return his or her original unit.
- Verify and update the customer's profile with all address and telephone information.
- Access DES and enter a replacement order for the customer.
- You will then need to place another commitment (via the internal referral team [OSG-to place an SAP order]) requesting an ARS Label be sent to the customer.

Deregistration process for V2421

- 1.If base is plugged in, disconnect the DC connector from it and wait at least 10 seconds before proceeding.
- 2.Hold down the [PAGE] button while reconnecting the DC cord to the base. Continue to hold down the [PAGE] button for 5 seconds after reconnecting power.
- 3.Release the [PAGE] button.
- 4.Press the [PAGE] button from 1 to 5 times, depending on the handsets you wish to deregister:
 - 1 press deletes HS1: 2 presses deletes HS2; etc. 5 presses deletes all.
 The Base LED will flash with each key press.
- 5.After entering the handset(s) to delete, the base will flash back the number of key presses entered.
- 6.Once the LED stops flashing, press [PAGE] once. Your mission is complete.

Access to SoundCard

Access to SoundCard

- 1.Press start
 - 2.Programs
 - 3.Accessories
 - 4.Entertainment/multimedia
 - 5.Volume control (this will open the master volume control)
 - 6.Go to Options and select Properties
- Select Line In
- 1.Press start
 - 2.Programs
 - 3.Accessories
 - 4.Entertainment/multimedia
 - 5.Volume control (this will open the master volume control)
 - 6.Go to Options and select Properties
 - 7.There will be an option to adjust Recording or playback volume control. Choose Recording.
 - 8.There is another section under recording where you pick which volume controls you want to show on the bar. Make sure there is a check next to "line". If there is not, please check it

- 9.Hit "Ok". Now "line or Line In" should show up in the master volume control for Recording. Please make sure that there is a check mark in the Select box under the "Line or Line IN
- 10.Go to Options and Select Properties.
- 11.There should be an option to adjust Recording or playback volume control. Choose Playback.
- 12.There is another section under playback where you pick which volume controls you want to show on the bar. Make sure there is a check next to "line or Line in". If there is not, please check it.
- 13.Hit "Ok". Now "line or Line in " should show up in the master volume control for Playback. Please make sure that there is a check mark in the MUTE box under the "line or line in". (it is possible that you may not have a MUTE option, it might be "SELECT". If you have a choice to SELECT then do not check SELECT under LINE")
- 14.Now close the Master Volume Control.

Operating Range General

This cordless telephone operates within the maximum power allowed by the Federal Communications Commission (FCC). Even so, this handset and base can communicate over only a certain distance --- which can vary with the locations of the base and handset, the weather, and the construction of your home or office. For best performance, keep the base antenna fully upright.

If you receive a call while you are out of range, the handset might not ring --- or if it does ring, the call might not connect when you press [PHONE]. Move closer to the base, then press [PHONE] to answer the call.

If you move out of range during a phone conversation, you might hear noise or interference. To improve reception, move closer to the base.

If you move out range without pressing[OFF], your phone will be left "off the hook." To hang up properly, walk back into range, periodically pressing [OFF].

Handset De-Registration (2455/2461)

- 1.Disconnect power to the Base (either unplug the DC connector from the bottom of the Base or unplug the power supply from the outlet). Remove spare battery, if applicable.
 - 2.Hold down the base PAGE key while applying power back to the Base. When the POWER LED begins to blink, release the PAGE key.
THE USER HAS 15 SECONDS TO BEGIN THE NEXT STEP;OTHERWISE, THE BASE WILL EXIT PROGRAM MODE.
 - 3.Hold down the PAGE key for 5 seconds. The HANDSET CHARGING LED will be lit, and after 5 seconds, the LINE IN USE LED will start to flash. Now release the PAGE key.
 - 4.The HANDSET CHARGING LED will blink 5 times and then go out. Within 5 seconds from when it stops blinking, press and release the PAGE key.
- All handsets should now be deregistered.

Conference calls

When call is conferenced, two lines are being bridged through one telephone. The normal loss that occurs between a station to station call is doubled when using the conference call feature. The quality of transmission depends on many variables including the amount

of line voltage available at the phone and the distance of miles between the two other parties. Customer may consider 3-way calling service (if available through local telco) as alternative. Customer is less likely to experience volume loss due to more direct routing of conference.

Caller Id after 2nd ring

Most Telco's send out the Caller ID information between the 1st and 2nd ring. Some Telco's send out this information later. If the machine answers the call before the information is received, the Caller ID information will be lost. Please set the number of rings to a number higher than 2. The customer may want to turn the machine off and then let a call come in to see when the information arrives. You need to set the answering system to answer the ring after the caller ID information arrives. Do not set it for the same ring. If you have voice mail service, set it to answer at 6 rings.

Operating Range 2.4

This cordless operates in the 2.4 Gigahertz frequency band. Radio signals in this band can penetrate small openings and reflect around obstructions more efficiently than those of conventional cordless telephones. This allows the unit to operate in areas that are typically difficult for cordless phones.

Your cordless telephone operates at the maximum power allowed by the Federal Communications Commission (FCC). Even so, your handset and base can communicate only over a certain distance which can vary with the locations of the base and handset, the weather, and the construction of your home or office.

Spread Spectrum Echo

This unit employs state-of-the-art frequency hopping spread spectrum (FHSS) technology to achieve one of the longest ranges in the consumer cordless telephone industry. FHSS is a digital technology that is also found in much more expensive cellular telephones. Just as it is common to experience echo in some cellular telephone systems, some users will experience occasional echo while using this phone. The presence and/or level of echo will depend on the electrical characteristics of the connection between the phone and user's local central office. This is normal operation. The customer can lower the volume on the handset and this will decrease the echo.

Caller ID/Call Waiting Services

It may not be enough that the users subscribe to both services, they may also need to ask the local phone company to combine Caller ID with Call Waiting, so that their Caller ID product will be able to recognize names and numbers for a Call Waiting call, as well as, for regular calls. There may be an additional charge for this combined feature. Their phone company may use names for this combined feature that are not on this list, but listed below are some of the more generally used names for this combined Caller ID with Call Waiting service:

- Call Waiting ID, Caller ID/Call Waiting ID - Bell Atlantic
- Wait and See - Ameritech
- Call Waiting ID - PacBell, SW Bell
- Caller ID with Name on Call Waiting - SNET

in.

Operating Range 900

This cordless operates in the 900 megahertz frequency band. Radio signals in this band can penetrate small openings and reflect around obstructions more efficiently than those of conventional cordless telephones. This allows the unit to operate in areas that are typically difficult for cordless phones.

Your cordless telephone operates at the maximum power allowed by the Federal Communications Commission (FCC). Even so, your handset and base can communicate only over a certain distance which can vary with the locations of the base and handset, the weather, and the construction of your home or office.

Cardiac Pacemakers

THE FOLLOWING INFORMATION IS LOCATED AT THE BEGINNING OF THE CIB

Cardiac Pacemakers (applies only to 900 MHz Digital Cordless Telephones):

Preliminary studies performed at the U.S. Food and Drug Administration (FDA) and elsewhere have shown that when digital wireless telephones using technology similar to 900 MHz Cordless Telephones are placed very close to implanted cardiac pacemakers, interference with the operation of the pacemaker can occur. These preliminary studies show that interference is not likely to occur when there is a reasonable distance between the telephone and the implanted pacemaker and stops when the phone is set in the "battery save mode" or moved so that it is more than 3 inches from the pacemaker.

Based on these preliminary studies, the FDA has concluded that digital wireless telephones "do not seem to pose a significant problem for pacemaker wearers.

Until more is known, the FDA suggests that people with pacemakers may want to take some simple precautions when using or carrying digital wireless telephones to ensure that there is ample distance between the digital cellular telephone and the pacemaker -- by not placing the phone next to the pacemaker implant (for example, in a shirt or coat pocket directly over the pacemaker implant) when the phone is turned on ready to receive a call and holding it to the ear opposite the side of the body where the pacemaker is implanted when using the phone. Consult your physician or medical device manufacturer to determine if additional precautions are necessary.

Volume Controls

Both the base unit and the handset have digital volume controls. The volume controls for the speakerphone are located on the front face of the base unit. Press the volume up side to increase the speaker volume and the volume down side to decrease the volume.

Holding either side down will continuously change the volume setting.

The volume controls for the handset are located on the side of the unit. Press the [^] (up) or [v] (down) keys to increase or decrease the volume.

Date Code Sticker

The date code sticker can be found inside the handset battery compartment, on the bottom of the base, or on the pretty box. It specifically indicates where and when the product was manufactured.

Following is an example of what is shown on the sticker:

940101 B

2/7

CPS 2A

Note: If inputting the date code in the FCC field, use the following format:

940101B2-7CPS2A (CRS will not accept a slash.)

The battery save feature will deactivate the ring approximately 60 seconds after being set. After 60 seconds, the phone will enter "sleep mode". The phone will not ring or display "incoming call" when the extension phones are ringing. If any button on the phone is pressed, this will "wake up" the phone. If there is an incoming call within 60 seconds of a button being pressed, the phone will ring. Once nothing has been pressed for another 60 seconds, the phone will go back into "sleep mode" and will not ring.

ToneLength

Tone length for most cordless telephones is 80-100 milliseconds.

Some services may require longer tones. You need to look for a phone that will continue to produce a tone signal for as long as a digit is held down. We have many phones with long tones.

Handset Warmth

It is normal to feel heat near the battery compartment on the cordless handset once the battery has been fully charged. There is a component in the battery known as a "separator" which converts excess energy to heat.

Relocate Phone In Home EMI + Sep/Phns

Interference generated by some radio equipment and electrical appliances and machinery may travel through the air, affecting other types of equipment in close proximity.

Filters cannot help in this situation. Separating the objects may be the only solution.

Split Line w/Triplex + Verify 2 cond cord on line 1

If single line telephone equipment is also experiencing crosstalk, the customer may try the following remedies:

1. Use shortest line cords possible.
2. Use 2 conductor line cords to connect all single line equipment.
3. Disconnect line 2 wires on any jack where not needed.

Crosstalk

If crosstalk occurs while phones are plugged into the network interface, inside wiring is NOT the problem. Plug separate phones into the individual interfaces for each line.

Both lines will need to be in use at the same time to get valid test results.

TWO SINGLE LINE JACKS

Verify that 2 conductor line cord is connected to L1/L2 port on telephone. 4 conductor cord may be used at L2 port.

SINGLE LINE TELEPHONE EQUIPMENT

If single line telephone equipment is also experiencing crosstalk, customer may try the following remedies:

1. Use shortest line cords possible.
2. Use 2 conductor line cords to connect all single line equipment.
3. Disconnect line 2 wires on any jack where not needed.

TWO-LINE JACKS

·Use triplex adapter and 2 line cords at each affected two-line set.

·Connect cords to L1 and L2 on adapter (not L1+L2) cannot use wall phones with triplex adapter.

Suggestions for reducing local telephone line recordings:

- If possible advise your callers to leave a message.
- Check with the local telephone company and advise them 7-10 seconds of silence is required for the answering system to disconnect.

NOTE: Charges may apply

Call Waiting disconnects answering system

Answering System senses a fluctuation in line voltage caused by the Call Waiting signal and disconnects.

Contact Local Telephone Company for possible solutions.

External Antennas

Additional external antennas are not recommended for the following reasons:

- AT&T cordless telephones are designed to ensure that the power output of the set does not exceed standards set by the FCC. The maximum power output allowed is .1 watt (or 100 milliwatts).
- Any attachment to a cordless telephone which increases the power output is in violation of FCC regulations.
- Once the product is opened in order to connect the external antenna, the warranty is voided.

Hearing Aid Compatibility

This product is compatible with inductively coupled hearing aids.

Use of any other amplification devices near or on the cordless product may produce squealing, whistling, or feedback.

- If you use a hearing aid in only one ear, cradle the handset to the other ear to try to avoid microphone feedback.
- Remove or turn off the hearing aid when using the handset.
- Use a different extension telephone if you are unable to use the product without assistance of a hearing aid.

Information regarding inductively coupled hearing aids:

- This type of hearing aid is usually equipped with a T (telephone) switch, specifically installed for improved amplification with telephone use.
- Flip the T switch to the telephone position to turn off the hearing aid microphone and turn on the inductive pickup coil that receives voice signals through a magnetic field generated by some telephone handset.
- Not all telephones generate a sufficiently strong magnetic field to couple to these hearing aids.
- Those that do are labelled Hearing Aid Compatible by AT&T.

Hearing Aid Compatibility

This product is compatible with inductively coupled hearing aids.

Clean Charging Contacts

- Each month clean handset and base charging contacts using a pencil eraser or a cloth to eliminate deposit accumulation.
- Charge light should come on when handset is cradled in base.
- Charge handset for 10 hours.

Calling in same Area Code

Many LTCO's are changing their dialing sequence to 0 +, or 1 +, 10-digit dialing (0 + 0r 1 + area code + seven-digit phone number) for all long distance calls that are made within the same area code. All 0 +, or 1 +, 7-digit dialing within the same area code will be eliminated. This also means that local credit card and operator assistance calls that traditionally have been 0 + 7 dialed calls will now require 0 + 10 dialing. You will continue 0 + or 1 + 10 digit dialing for long distance calls into other area codes as you do today.

Recradle unplug AC

- 1.Unplug the AC adapter from the wall outlet.
- 2.Remove battery cover on handset.
- 3.Unplug batteries from back of handset.
- 4.Wait 15 seconds and reinstall batteries securely.
- 5.Replace battery cover.
- 6.Recradle handset in base, replug AC adapter and wait 15 seconds.
- 7.Pick up handset and press phone.

NOTE: Be sure batteries have been charged recently.

Recradle unplug AC

- 1.Unplug the AC adapter from the wall outlet.
- 2.Remove battery cover on handset.
- 3.Unplug batteries from back of handset.
- 4.Wait 15 seconds and reinstall batteries securely.
- 5.Replace battery cover.
- 6.Recradle handset in base, replug AC adapter and wait 15 seconds.
- 7.Pick up handset and press phone.

NOTE: Be sure batteries have been charged recently. If not, charge batteries fully for 16 Hours.

Handset Locked Up (Battery) :

- 1.Remove battery cover on handset.
 - 2.Unplug battery from back of handset.
 - 3.Wait 15 seconds.
 - 4.Reinstall battery securely.
 - 5.Replace battery cover.
 - 6.Recradle handset in base for 15 seconds.
 - 7.Pick up handset and press phone.
- NOTE: Be sure batteries have been charged recently.

Handset Locked Up (Battery) :

- 1.Remove battery cover on handset.
- 2.Unplug battery from back of handset.
- 3.Wait 15 seconds.
- 4.Reinstall battery securely.

5. Replace battery cover.
6. Recradle handset in base for 15 seconds.
7. Pick up handset and press phone.

NOTE: Be sure batteries have been charged recently. If not, charge batteries fully for 16 hours.

Common Cure

If the unit does not seem to be responding normally, then try putting the handset in the base to reinitialize the unit. If it still does not seem to respond after doing this a few times, do the following (in the order listed):

1. Unplug the power cord.
2. Remove the handset battery.
3. Wait a few minutes.
4. Plug the power cord into an electrical outlet.
5. Install the handset battery.
6. Put the handset in the base to reinitialize.

Base Unit Locked Up:

1. Recradle handset in base.
2. Unplug AC adapter from wall outlet.
3. Wait 15 seconds.
4. Reconnect AC adapter.
5. Wait 15 seconds.
6. Pick up handset and press PHONE button.

Single Audio Path Mutes

Ringling from another line may briefly mute a conversation since this product is designed with a single audio path. This is a normal occurrence.

Chirping Sounds

If chirping sounds are detected from the handset or base, check the following possible causes:

- Smoke detectors
- Other cordless telephones
- Alarm clocks

To enable the unit to work with business systems:

- Install the unit at the control box, or
- Wire a jack around the system.

NOTE: Unit will not have business system features if installed in this manner.

Check with the local telephone company to inquire as to possible low line voltage.

NOTE: The recommended voltage is 24 to 48 on hook.

Due to reduced line voltage, avoid having additional extension telephones "off the hook" during a call.

Wet Handset

A handset dropped in water may still operate if left out to dry.

1. Empty any residual water.
2. Leave handset face down on a towel to dry for 72 hours.
3. If handset does not operate after 72 hours, send it in for repair.

To determine if telephones ring separately or together:

- 1.Remove telephones from line.
 - 2.Replace one at a time.
- Line 1 has a higher pitched ring that helps differentiate it from the ring of Line 2.
 - Have someone call on each line.
 - Let the telephone ring approximately five times and listen to the difference.
 - Try using 2 two conductor cords or purchase a 267C adapter.
 - Try a Triplex adapter and use a two cord connection.

Ringer Volume Not Adjustable

Ringer volume cannot be adjusted.

If the volume is too loud, the ringer switch may be shut off.

NOTE: This will turn the ringer off completely and you will lose line lights.

4 Conductor Line Cord

To determine if the unit's cord is four pin or two pin:

- Take another telephone "off the hook."
- Remove and inspect the telephone line cord.

Low Battery indicator

The Low Battery indicator does not appear if:

- The unit is completely charged.
- The handset has completely discharged.

If the handset is normally kept in the base, the light should not appear.

Unplug excessive telephones or adjuncts or disconnect the telephones needed to bring ringer equivalence below total ringer equivalence.

Check with the local telephone company to inquire as to possible low line voltage.

NOTE: The recommended voltage is 24 to 48 on hook.

- Unplug both ends of the line cord.
- Plug in both ends of the line cord.
- Replace the line cord if the connections are loose.

Explain Call Waiting

Explanation to Call Waiting customers:

- The unit picks up the first call after the preset number of rings.
- The second caller hears the telephone ring until the unit resets and is ready to answer the next call.
- There is no reset time.

More Than One Cordless

If more than 1 cordless installed, have customer check to see if handsets are cradled on the correct base unit.

Ringer Equivalence

On the bottom of each telephone or adjunct is a Ringer Equivalence.

1. Find this number for everything connected to your telephone line.
2. Add up all the numbers to get the total Ringer Equivalence.

Julian Date

NOTE: Contact the telephone company, if required.

The Julian date for this unit is found on the bottom of the unit.

TAS units are manufactured in:

- Mexico (M)
- Taiwan (H)
- China (G)
- Thailand (L)

The Julian date (XX XXX X) is read as follows:

- The first two numbers (XX XXX X) represent the year (00 - 99) of manufacture.
- The next three numbers (XX XXX X) represent the day of the year (1 - 365) of manufacture.
- The last letter (XX XXX X) represent the place (M, H, G, L) of manufacture.

So, for example, 92291G was built in 1992, on the 291st day, in China.

When asked if a Julian date is after 92291G, 922209H, or 92168M, compare the Julian date the customer gives you with the Julian date above for the same manufacturing site.

For example, if the customer said, "93005G," you would compare it to 92291G and answer, "Yes."

Digital Voice

The difference between the electronic and human voice:

The electronic voice is a digital reproduction of a human voice which is analog.

Free Manuals Download Website

<http://myh66.com>

<http://usermanuals.us>

<http://www.somanuals.com>

<http://www.4manuals.cc>

<http://www.manual-lib.com>

<http://www.404manual.com>

<http://www.luxmanual.com>

<http://aubethermostatmanual.com>

Golf course search by state

<http://golfingnear.com>

Email search by domain

<http://emailbydomain.com>

Auto manuals search

<http://auto.somanuals.com>

TV manuals search

<http://tv.somanuals.com>