

ANY KEY ANSWER
30 CHANNEL OPERATION

2151

UNIQUE STAND UP DESIGN

USER'S MANUAL



Introduction

Parts Check List:

1. Handset
2. Base Unit
3. Telephone line cord
4. Battery
5. Power Adapter
6. User's Manual

To purchase replacement batteries, call VTech Communications at 1-800-595-9511. In Canada, call VTech Telecommunications Canada Ltd. at 1-800-267-7377.



HANDSET

BASE UNIT

TELEPHONE LINE CORD

BATTERY

POWER ADAPTER

USER'S MANUAL (ENGLISH AND SPANISH)



To help protect the environment, this product may contain recycled or reconditioned parts and materials.

vtech

VTECH TELECOMMUNICATIONS LTD.

www.vtechphones.com

Printed in China

ISSUED 0

1

Important Safety Instructions

When using your telephone equipment, basic safety precautions should always be followed to reduce the risk of fire, electric shock and injury, including the following:

1. Read and understand all instructions.
2. Follow all warnings and instructions marked on the product.
3. Unplug this product from the wall outlet before cleaning. Do not use liquid or aerosol cleaners. Use a damp cloth for cleaning.
4. Do not use this product near water (for example, near a bath tub, kitchen sink or swimming pool).
5. Do not place this product on an unstable surface, such as a table, shelf or stand. The product may fall, causing serious damage.
6. Slots and openings in the back or bottom of the base unit and handset are provided for ventilation. To protect them from overheating, these openings must not be blocked by placing the product on a soft surface such as a bed, sofa or rug. This product should never be placed near or over a radiator or heat register. This product should not be placed in any area where proper ventilation is not provided.
7. This product should be operated only from the type of power source indicated on the marking label. If you are not sure of the type of power supply in your home, consult your dealer or local power company.
8. Do not allow anything to rest on the power cord. Do not install this product where the cord may have anyone walking on it.
9. Never push objects of any kind into this product through slots in the base or handset as they may touch dangerous voltage points or short out parts that could result in a risk of fire or electric shock. Never spill liquid of any kind on the product.
10. To reduce the risk of electric shock, do not disassemble this product, but take it to an authorized service facility. Opening or removing parts of the base or handset other than specified access doors may expose you to dangerous voltages or other risks. Incorrect reassembling can cause electric shock when the product is subsequently used.
11. Do not overload wall outlets and extension cords as this can result in the risk of fire or electric shock.
12. Unplug this product from the wall outlet and refer servicing to an authorized service facility under the following conditions:
 - A. When the power supply cord or plug is damaged or frayed.
 - B. If liquid has been spilled into the product.
 - C. If the product has been exposed to rain or water.
 - D. If the product does not operate normally by following the operating instructions. Adjust only those controls that are covered by the operating instructions, as improper adjustment of other controls may result in damage and often requires extensive work by an authorized technician to restore the product to normal operation.
 - E. If the product has been dropped and the base and/or handset has been damaged.
 - F. If the product exhibits a distinct change in performance.
13. Avoid using a telephone (other than cordless) during an electrical storm. There is a remote risk of electric shock from lightning.
14. Do not use the telephone to report a gas leak in the vicinity of the leak.
15. Only put the handset of your telephone next to your ear when it is in normal talk mode.

SAVE THESE INSTRUCTIONS

2

Installing/Replacing the Battery

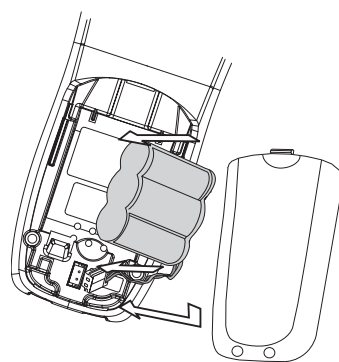

1. Slide the battery cover off by gently pressing on the recessed area with a downward motion.
2. Unplug and remove the old battery.
3. With the red and black wires at the bottom of the battery, angle the top of the battery into the compartment, under the claws. Next, press the lower end of the battery down, so it is held in place by the lower claw. Now, plug the connector into the socket, located below and to the left of the socket.
4. Replace the battery cover by sliding it into place.
5. The new battery must be charged before using your telephone. Place the handset in the base unit to allow it to charge for 15 hours. Maximum

battery life between charges is approximately 3.75 hours of talk time or 3.75 days of standby.

CAUTION: To reduce the risk of fire or injury, read and follow these instructions:

1. Use only the VTech battery supplied, or equivalent.
2. Do not open or mutilate the battery. Released electrolyte is corrosive and may cause damage to the eyes or skin. It may be toxic if swallowed.
3. Exercise care in handling battery in order not to short the battery with conducting materials such as rings, bracelets, and keys. The battery or conductor may overheat and cause burns.
4. Do not dispose of the battery in a fire. The cell may explode.

3

Getting Started

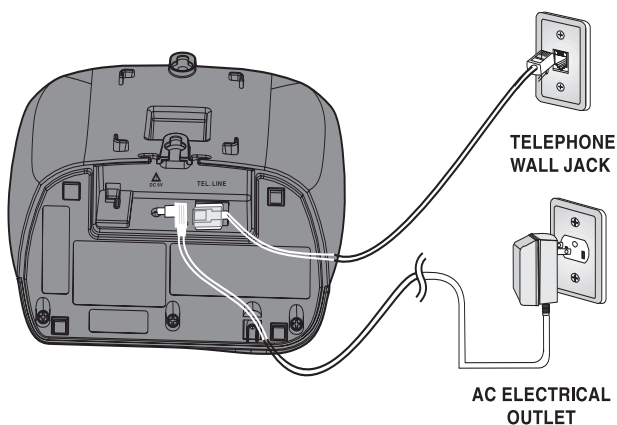

Setting Up Your 2151

1. Choose an area near an electrical outlet and a telephone wall jack.
 2. Plug the AC power adapter into an electrical outlet and the DC connector to the power jack on the bottom of the base unit. Insert the cord in the channel guide.
- CAUTION:** Use only the AC adapter shipped with your 2151. It is specifically designed for this product.
- NOTE:** Connect power to the base unit before placing the handset in the cradle.
3. **CHARGE THE HANDSET BATTERY BEFORE USE.** The battery recharges automatically whenever the handset is in the base unit. The battery must be charged for 15 hours before using your phone for the first time.
 4. Connect the telephone line cord. Insert one end of the telephone line cord into the phone jack on the bottom of the base unit. Plug the other end into a telephone wall jack. Make sure the plugs snap securely into place. Insert the cord in the channel guide.
 5. **CHECK FOR A DIAL TONE.** After the battery is charged, pick up the handset and press the **ON** key. You should hear a dial tone. If not, see **IN CASE OF DIFFICULTY.**

4

Handset Features

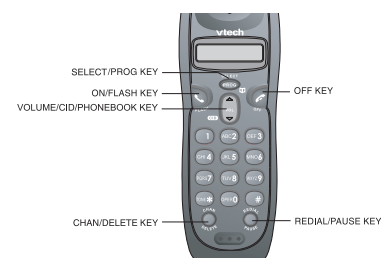

REDIAL / PAUSE KEY

- You can store pauses into your speed dial numbers. See **Storing Pauses in Memory** for details.

CHAN/DELETE KEY

- Pressing the **CHAN** key when the handset is in use will activate a channel change to the next free channel. This is used if you are experiencing noise or interference on the current channel.
- When viewing the call log, press to delete the current record displayed.
- While handset in idle mode, press and hold to delete all records in the call log.

PROG/SELECT KEY

- Press **PROG**.
- Press **SELECT** to store a directory entry.

TONE / * KEY

- In **PULSE** dialing mode, this key is used to switch to temporary **TONE** dialing mode.

PAGE

Press to page the handset for up to 60 seconds. Press again, or press **OFF** on handset, or place handset in base to cancel the page.

ON / FLASH KEY

- Press the **/PHONE** key to make a call.
- If you are currently on a call, and hear a call waiting tone, press **FLASH** to switch to the second call. Press **FLASH** again to return to the original call.

VOLUME CONTROL

- While on a call, press the **▲** or **▼** keys to adjust the listening volume. The handset will emit a double beep when the maximum or minimum volume level has been reached.

VOLUME/CID/PHONEBOOK KEY

- When phone is not in use, press **(CID)** to display Caller ID information.
- When phone is not in use, press **▲(L)** to display directory entries.

OFF KEY

- Press the **OFF** key to end a call or exit all modes of operation.

5

Operating Instructions

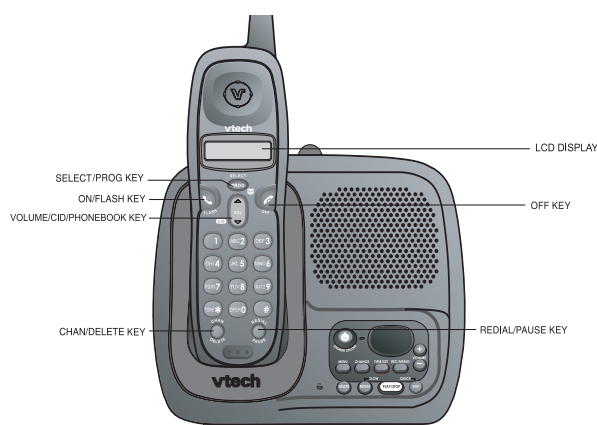

Making Calls

Pick up the handset and press **ON**. When you hear a dial tone, dial the number. While the handset is in use, the LCD will display:

PHONE ON

If you make a mistake when dialing, press **OFF** to hang up, then press **ON** to get the dial tone again.

Answering Calls

When an incoming call is ringing, answer the call by pressing any key on the handset (except **OFF**).

Disconnecting

To end a call, either place the handset in the base, or press **OFF** on the handset.

Changing Channels

If you notice interference when you are on a call, press **CHAN** to switch

to a clear channel.

TONE/PULSE Setting

To switch between tone and pulse settings, press **PROG/SELECT**. Use the **▲** or **▼** keys to scroll to **DIAL MODE**.

DIAL MODE: TONE

Press **PROG/SELECT** to confirm. To exit without making a change, press **OFF**.

NOTE: Your 2151 is preset at the factory for **TONE** dialing.

6

Operating Instruction

- Press **PROG/SELECT** to store your entry. The screen displays **DISTINCT RING?** and the current setting.
- Press **▼** or **▲** to change the setting. Choose **Y** (for yes) if you wish the phone to alert you to calls from this number by changing to a distinctive ringing pattern after the first ring. Choose **N** for a normal ringing pattern.
- Press **PROG/SELECT** to confirm your selection. If you chose **Y**, a **D** will be displayed with the directory entry.

Edit a Number/Name Stored in Memory

- Press and hold the memory location key (1 through 9) of the entry you wish to edit.
- When the screen displays the entry you want to edit, press **SELECT**. Then press **▼** or **▲** until **EDIT** flashes.
- Press **SELECT**. The screen displays the name and number. The cursor appears at the end of the name. Use **▼**, **▲** and the dial pad keys to edit the name. Press **SELECT** to move on to edit the number. Use **▼** to backspace and make corrections. Press **SELECT** to move to edit the distinctive ring setting.
- Press **SELECT** to save.

Delete a Number/Name Stored in Memory

- Press and hold the memory location key (1 through 9) of the entry you wish to delete.
- When the screen displays the entry you want to delete, press **SELECT**. Then press **▼** or **▲** until **ERASE** flashes.
- Press **SELECT**. The screen displays **ERASE NO YES** and the number.
- Press **▼** or **▲** until **YES** flashes.
- Press **SELECT**. You'll hear a confirmation beep.

Dial a Memory Number

- Press and hold the memory location key (1 through 9) of the entry you wish to dial.
- Press **PHONE** to dial the displayed memory number.

Reassign Locations in Memory

- Press and hold the memory location key (1 through 9) of the entry you wish to reassign.
- When the screen displays the entry you want to reassign, press **SELECT**. Then press **▼** or **▲** until **SPEED** flashes.
- Press **SELECT**. The screen displays **ENTER 1-9**.
- Press the keys (1 through 9) to reassign this entry into another memory location. You'll hear a confirmation beep.

8

Caller ID/Call Waiting ID

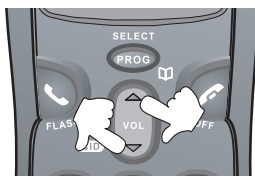

NOTE: Caller ID and call waiting ID are subscription services, provided by your regional phone company. You must subscribe to these services in order to benefit from the caller ID features of your 2151. Contact your regional phone service provider for details.

Receiving and Storing Calls

As new caller ID/call waiting ID records are received, **NEW** followed by the number of new caller ID records received will be displayed on the handset.

NEW 01 OLD 01

Your 2151 will store the most current 60 caller ID and call waiting ID records. When caller ID information comes in with the inbound ring, it is displayed until the call is answered. When call waiting ID information comes in, it is displayed for approximately 15 seconds.

VTech
800-595-9511

About Caller ID

This phone assigns each incoming call a number from 1 to 60. The most recent call will have the highest number. When the memory is full, the oldest call information is deleted to make room for new incoming call information. Therefore, you do not have to delete caller ID records manually.

For each call that comes in, the screen displays the following information between the first and second rings:

- The caller's name (15 letters are sent by your telephone company);
- The caller's area code and telephone number;
- The time and date of the call. If you answer a call before the information appears on the screen, it will not be in the call history.

NOTE: Press **OFF** at any time to exit caller ID review mode.

Review Caller ID

- Press **(CID)** to view caller ID.
- Use **▲** and **▼** to scroll through records in call history.

Delete a Specific Call

- Press **(CID)** to view caller ID.
- Use **▲** or **▼** to locate the records you want to delete.
- Press **DELETE**. You'll hear a confirmation beep.

VTech
800-595-9511

Delete All Calls

- With the handset in idle (off) mode, press and hold **CHAN/DELETE**. The screen displays **ERASE ALL NO YES**. The current choice flashes.
- Press **▲** until **YES** flashes.
- Press **SELECT**. You'll hear a confirmation beep.

ERASE ALL NO YES

10

Operating Instructions

Temporary Tone Dialing

If you have a rotary (pulse) telephone service, (**TONE/PULSE** setting is set to **PULSE**), this feature allows you to enter special codes and tones to operate answering machines, electronic banking services, or other special services.

First, dial the call normally. Then activate the temporary tone feature by pressing **TONE** (the * key). You can then press the numbers or symbols you need, and your phone will send the proper signals.

To end the call, press **OFF** or place the handset in the base. The phone will automatically go back to rotary (pulse) service.

Programming The Ringer Type

The handset ringer is capable of four different types of ring tones. Your 2151 has four ringer options plus ringer off. To change the ringer setting:

- Press **PROG/SELECT**.
- Press **▲** or **▼** to scroll to **RINGER:** current setting. Press **PROG/SELECT** to select **RINGER: 1, 2, 3, 4** or **OFF**. You will hear a sample of each ring.
- Press **PROG/SELECT** to confirm.

Speed Dial Memory

You can store up to nine numbers with names (up to 15 characters and 24 digits in each location) you dial frequently into the speed dial memory locations you assign (1 through 9) in each handset. You can also store telephone numbers with names alphabetically in the directory.

NOTES:

- The entries you stored in speed dial memory will be marked with 01 through 09 in the telephone directory.
- Press **OFF** at any time to exit memory dial mode.

Store a Number/Name in Memory:

- Press **PROG/SELECT** on the handset.
 - Press **▲** or **▼** until the screen displays **SPEED DIAL**.
 - Press **SELECT**. The screen displays **ENTER 1-9**.
- NOTE:** When memory is full the screen displays **MEMORY FULL**, an error tone sounds, and you cannot store a new number until you delete a record in speed dial memory or telephone directory.
- Press the key (1 through 9) for the memory location where you want to store this entry. If the selected location is empty, the screen displays **ENTER NAME**.

NOTE: If the location is not empty, your new entry will be stored in place of the old entry. Take caution to not save over entries you do not wish to erase.

- Enter up to 15 characters for the name you're storing with the number. Use **▼** to backspace and make corrections; use **▲** to advance and add a space.
 - When you finish entering the name, press **PROG/SELECT**. The screen displays **ENTER NUMBER**.
 - Enter the telephone number. Use **▼** to backspace and make corrections. Press **REDIAL/PAUSE** to store a pause in the dialing sequence.
- OR-**
Press **REDIAL/PAUSE** to display the last number dialed from this phone.

7

Telephone Directory

Your 2151 can store 12 (including the nine speed dial entries) numbers with names (up to 15 characters for the name and 24 digits for the number) in each handset.

NOTE: Press **OFF** at any time to exit directory.

Store a Number/Name in the Directory

- Press **PROG**. The screen displays **DIRECTORY**.
- Press **SELECT**. The screen displays **ENTER NAME**.
- Using the chart below, enter up to 15 characters for the name you're storing with the number. Use **▼** to backspace and make corrections; use **▲** to advance and add a space.

Dial Key	Presses					
	1	2	3	4	5	6
1:	1					
2:	A B C	2				
3:	D E F	3				
4:	G H I	4				
5:	J K L	5				
6:	M N O	6				
7:	P Q R S	7				
8:	T U V	8				
9:	W X Y Z	9				
0:	0					
*:	*					
#:	& ' - . #					

- When you finish entering the name, press **PROG/SELECT**. The screen displays **ENTER NUMBER**.
 - Enter the telephone number. Use **▼** to backspace and make corrections. Press **REDIAL/PAUSE** to store a pause in the dialing sequence.
- OR-**
Press **REDIAL/PAUSE** to display the last number dialed from this phone.
- Press **PROG/SELECT**. The screen displays **DISTINCT RING?** and the current setting.
 - Press **▼** or **▲** to change the setting. Choose **Y** (for yes) if you wish the phone to alert you to calls from this number by changing to a distinctive ringing pattern after the first ring. Choose **N** for a normal ringing pattern.
 - Press **PROG/SELECT** to confirm your selection. If you chose **Y**, a **D** will be displayed with the directory entry.

9

Caller ID/Call Waiting ID

Dial a Displayed Number

- Locate the record in call history that you want to dial.
- If you wish to change how the number is dialed, press **#**. The screen displays any alternate dialing sequences available for this call (area code + number; 1+ area code + number; number only; 1+ number).
- Press **SELECT**. **DIAL** will be flashing.
- Press **SELECT** again to dial. **-OR-** After completing step 2, press **ON** to dial.

VTech
800-595-9511

Store a Caller ID Record in Phonebook Memory

- Use **(CID)** to locate the desired CID record.
- If you wish to change how the number is stored, press **#**. The screen displays any alternate dialing sequence available for this call (area code + number; 1+ area code + number; number only; 1+ number).
- Press **SELECT**, then press **▼** until **PROGRAM** flashes.
- Press **SELECT**. You can now edit the **NAME** if you wish. Press **▼** to backspace and edit the name. Use **▲** to advance and add a space.
- Press **SELECT**. You can now edit the **PHONE NUMBER**. Press **(CID)** to backspace in order to edit the phone number.
- Press **PROG/SELECT** to store your entry, the screen displays **DISTINCT RING?** and the current setting. Press **▲** or **▼** to change the setting. Choose **Y** (for yes) if you wish the phone to alert you to calls from this number by changing to a distinctive ring tone after the first ring. Choose **N** for a normal ringing pattern.
- Press **PROG/SELECT** to save.

VTech
800-595-9511

Display Screen Messages

Screen Display:	When:
PRIVATE NAME	The other party is blocking name information.
PRIVATE CALLER	The other party is blocking name and number information.
UNKNOWN NAME	Your phone company is unable to receive information about this caller name.
UNKNOWN CALLER	Your phone company is unable to receive information about this caller name and number.

11

Answering System Operation

Audible Indicators

Your 2151 telephone system gives you voice prompts for feature operations and voice confirmations when you press a button or complete an operation.

Setting the clock

1. Make sure the answering system is on.
2. Press **TIME/SET**. The system announces the clock setting, then announces: "To begin setting the clock, press **TIME/SET**, then press **CHANGE** to change the setting or press **TIME/SET** to continue."
3. Press **TIME/SET**.
4. Press **CHANGE** until the system announces the correct day, then press **TIME/SET**.
5. Press **CHANGE** until the system announces the correct hour, then press **TIME/SET**.
6. Press **CHANGE** until the system announces the correct minute, then press **TIME/SET**. The system announces the current year, press **CHANGE** until the system announces the correct year, press **TIME/SET**. The system announces the current clock setting.

NOTES:

1. The time will be set automatically with incoming caller ID data. You can however choose to set the time manually, caller ID is a subscription service provided by most telephone companies.
2. To advance the minute or year by increments of 10, press and hold **CHANGE**.

About Announcements

- You can record two different announcements — one for normal answering and one for when you've set the system to play the announcement only.
- Use normal answering when you want the system to record callers' messages. Use announcement only when you want to give information to callers without accepting messages.
- If you choose not to record an announcement, the system answers with a pre-recorded announcement.
- The normal answering pre-recorded announcement says: "Hello. Please leave a message after the tone." The announcement only pre-recorded announcement says: "We're sorry, messages to this number cannot be accepted."
- By setting announcement only to on or off, you decide which announcement your callers will hear when the system answers a call (the system comes set for normal answering, with announce only turned off). See **Set announce only**, located in the **Feature Summary** chart later in this section, to change your announcement selection.

12

Answering System Operation

Setting Up Your Answering System

You can set up one feature at a time, or you can set up the first feature and then move on to set up the other features in sequence.

1. Make sure the answering system is on.
2. Press **MENU** until the system announces the feature you want to set. Refer to the **Feature Summary** below for a description of the features and your choices.
3. Press **CHANGE** until the system announces the desired setting.
4. Press **TIME/SET** to confirm your selection.
5. Press **MENU** to move on to the next feature, or press **PLAY/STOP** to exit feature setup.

Feature Summary

Default settings indicated by *

System announces:	Description/directions:
"Remote access code. To change the setting press CHANGE " 19*	Set the remote access code you will use to access features and functions of the answering system from a touch tone phone. You can select any two digit code, from 10 to 99. NOTE: To advance the remote access code by increments of 10, press and hold CHANGE .
"Message alert. To change the setting press CHANGE " Off* On	When message alert is turned on, the base beeps once every 10 seconds when new messages have been received.
"Announcement only, record no messages. To change the setting press CHANGE " Off* On	When you turn announce only on, callers hear your announcement, but cannot leave a message.
"Base ringer. To change the setting press CHANGE " Off* On	Turn the base ringer on or off.
"Number of Rings. To change the setting press CHANGE ." 2 4* 6	Choose how many times the phone will ring before the system answers a call.
Toll Saver	With toll saver active, the system answers after two rings when you have new messages and after four rings when you have no new messages.

NOTE: You can exit feature setup at any time by pressing a **PLAY/STOP**.

14

Answering System Operation

Call Screening/Intercept

1. Make sure the answering system is on, and set the message playback volume control above level 1 so you can hear the caller's message.
2. If you decide to take the call, press **FLASH** on the handset.
3. If you pick up an extension phone during the announcement and the announcement does not stop right away, press and release the telephone switchhook.

Record a Memo

You can record a memo up to four minutes long, which is stored as an incoming message.

1. Press and release **REC/MEMO**.
2. The system announces "Record after the tone. Press **STOP** when you are done". After the beep, speak toward the microphone. The message window displays the length of your memo up to 99 seconds, if you record a memo longer than 99 seconds, 99 continues to flash until you finish.
3. To stop recording, press the **PLAY/STOP** again.

Message Window Display

Window Display: when:

0	No messages.
1 - 99	Total number of messages, or message number during message playback.
0 - 99 <--> F	Memory is full, or total number of messages is "99."
1 to 99 (counting)	Duration of announcement or memo recording (maximum length of announcement is 90 seconds).
99 (flashing)	Length of recording is more than 99 seconds.
1 - 8 (on steady for one second)	Indicates volume level selected when VOL- or VOL+ is pressed.
10 - 99	Current remote access code while setting.
A	Announce only mode.
On or Off (steady for one second)	Displayed when any setting is changed from on or off.
CL<-->(normal display)	Clock needs to be set.
-- (steady)	System is answering a call or is in remote operation.
-- (flashing)	System is in programming mode or initializing.

16

Answering System Operation

Turn answering system on or off

Review/change clock setting; confirm feature settings

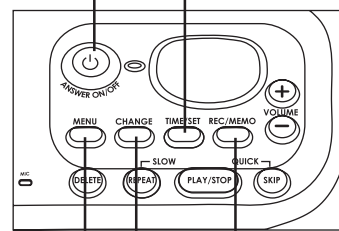

Select a feature setting

Record outgoing announcements, and memos

Enter answering system feature setup and choose a feature to set

Record Your Announcement

1. Press **MENU** until you hear "Announcement. Press **PLAY** or press **RECORD**. To continue setup, press **MENU**"
2. Press **REC/MEMO**. After you hear "Record after the tone. Press **STOP** when you are done" followed by a beep, speak toward the base to record an announcement up to 90 seconds long.
3. Press **PLAY/STOP**. The system plays back your recorded message.

To review your announcement at any time:

1. Press **MENU** until you hear "Announcement. Press **PLAY** or press **RECORD**. To continue setup, press **MENU**."
2. Press **PLAY/STOP**.

To delete your announcement:

Press **DELETE** during announcement playback. The system will use the pre-recorded announcement until you record a new one.

13

Answering System Operation

Listen to, Save & Delete Messages

The system automatically saves your messages until you delete them, and can store approximately 15 minutes of messages, memos, and announcements (up to a maximum of 99 messages). A message or memo can be up to four minutes long.

The message window will flash to alert you to new, unplayed messages. If all messages have been reviewed, the number displayed in the window will glow steadily. If the system contains both old and new messages, it will play only the new messages first. After all new messages are played, press the **PLAY/STOP** to hear all messages.

NOTE: If the system has less than 30 seconds of record time left, the answering system turns off. The system will answer after 10 rings and announce "Memory full, please enter your security code" and wait for the caller to enter the remote access code.

Before playing a message, the system announces the day and time it was received. While the message plays, the message window displays the number of the message. After playing the last message in a mailbox, the system announces "End of messages." If the system has less than five minutes of recording time left, it announces remaining time.

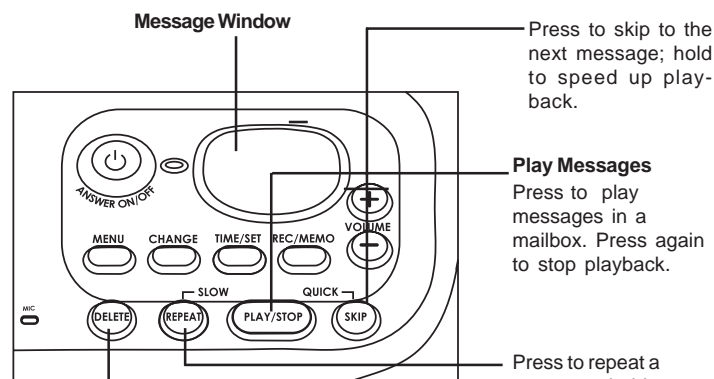

Press to skip to the next message; hold to speed up playback.

Play Messages

Press to play messages in a mailbox. Press again to stop playback.

Press to repeat a message; hold to slow down playback

Delete Messages

- To delete a message, press **DELETE** while the message is playing.
- Press and hold **DELETE** button to delete all old messages in that mailbox.
- You cannot delete a message until it's been reviewed; deleted messages cannot be recovered.

15

Answering System - Remote Access

Remote Access

You can access many features of this system remotely from a touch tone phone.

1. Dial your telephone number.
2. When the system answers, enter your remote access code (preset to 19). The system beeps once and then announces the number of new messages.
3. Enter a remote command (see **Remote Access Commands**).
4. Press * 0 to exit remote operation.

Voice Menu

The system has voice prompts to help you with remote operation. Press # 1 to hear the menu while remotely connected to the answering system.

Remote Access Commands

Function:	Command:
Play messages in a mailbox	Press #2. The system will play new messages. If there are no new messages, the system plays old messages.
Repeat a message	Press #4 while message is playing; press #4#4 to back up previous message.
Skip a message	Press #6 while message is playing; each press advances up another message.
Stop	Press #5.
Save messages	Hang up.
Delete message	Press #9 while message is playing.
Review announcement	Press #7; system plays announcement, then beeps.
Record announcement	Press *7; after beep, record announcement, press #5 to stop. System plays back announcement.

17

Remote Access Commands (continued)

Function:	Command:
Record memo	Press *8, speak after beep; press #5 when finished.
End remote access call	Press *0.
Turn system off	Press #0; the system announces, "Answering machine off." Press #0 again to turn the system back on.
Turn system on	When system is off, it answers after 10 rings and announces, "Please enter your security code." Enter your remote access code.

NOTE: If no key is pressed within 10 seconds of entering remote access, the voice menu will be announced. After the voice menu announcement, if no key is pressed within 20 seconds, the remote access call will automatically end.

In Case of Difficulty

You Hear Other Calls While Using Your Phone.

- Disconnect your base unit from the telephone jack, and plug in a regular telephone. If you still hear other calls, the problem is probably in your wiring or local service. Call your local telephone company.

You Hear Noise in the Handset, and None of the Keys or Buttons Work.

- Make sure the power cord is plugged in.

Common Cure for Electronic Equipment

If the unit does not seem to be responding normally, then try putting the handset in the cradle to re-initialize the unit. If it still does not seem to respond, perform the following steps (in the order listed):

1. Disconnect the power to the base.
2. Disconnect the handset battery.
3. Wait a few minutes.
4. Connect power to the base.
5. Re-install the handset battery.
6. Wait for the handset to re-establish its link with the base. To be safe, allow up to one minute for this to take place.

You cannot hear recorded messages

- Using the base volume control, raise the volume to a comfortable listening level.

CL is flashing in the base Message Window Display:

- You need to set the day and time. Refer to the section(s) on **setting day and time** in this user's manual
- Make sure **Announce Only** feature is set to OFF.

Warranty Statement

4. Product to the extent that the problem is caused by use with non-VTech electrical accessories; or
5. Product whose warranty/quality stickers, Product serial numbers plates or electronic serial numbers have been removed, altered or rendered illegible; or
6. Product purchased, used, serviced, or shipped for repair from outside the United States, or used for commercial or institutional purposes (including but not limited to Products used for rental purposes); or
7. Product returned without valid proof of purchase (see 2 below); or
8. Charges for installation or set up, adjustment of customer controls and installation or repair of systems outside the unit.

How do you get warranty service?

- To obtain warranty service in the United States of America, call 1-800-595-9511 for instructions regarding where to return the Product. Before calling for service, please check the user's manual. A check of the Product controls and features may save you a service call.
- Except as provided by applicable law, you assume the risk of loss or damage during transit and transportation and are responsible for delivery or handling charges incurred in the transport of Product(s) to the

service location. VTech will return repaired or replaced product under this limited warranty to you, transportation, delivery or handling charges prepaid. VTech assumes no risk for damage or loss of the Product in transit.

- If the Product failure is not covered by this limited warranty, or proof of purchase does not meet the terms of this limited warranty, VTech will notify you and will request that you authorize the cost of repair prior to any further repair activity. You must pay for the cost of repair and return shipping costs for the repair of Products that are not covered by this limited warranty.

What must you return with the Product to get warranty service?

1. Return the entire original package and contents including the Product to the VTech service location along with a description of the malfunction or difficulty;
2. Include valid proof of purchase (sales receipt) identifying the Product purchased (Product model) and the date of purchase or receipt; and
3. Provide your name, complete and correct mailing address, and telephone number.

Other Limitations

- This warranty is the complete and exclusive agreement between you and VTech. It supersedes all other written or oral communications related to

If you have difficulty operating your phone, the suggestions below should solve the problem. If you still have difficulty after trying these suggestions,

In the **US** call:

VTech Communications at **1-800-595-9511**.

In **Canada** Call:

VTech Telecommunications Canada Ltd. at **1-800-267-7377**.

The Phone Doesn't Work at All.

- Make sure the power cord is plugged in.
- Make sure the telephone line cord is plugged firmly into the base unit and the telephone wall jack.
- Make sure the battery are properly charged. If the handset makes two beeps, the battery need charging.

No Dial Tone.

- First check all the suggestions above.
- If you still don't hear a dial tone, disconnect the base unit from the telephone jack and connect a different phone. If there is no dial tone on that phone either, the problem is in your wiring or local service. Call your local telephone company.

You Get Noise, Static, or a Weak Signal Even When You're Near the Base Unit.

Household appliances plugged into the same circuit as the base unit can sometimes cause interference. Try moving the appliance or the base unit to another outlet.

You Get Noise, Static, or a Weak Signal When You're Away From the Base Unit.

- You may be out of range. Either move closer to the base, or relocate the base unit.
- The layout of your home may be limiting the range. Try moving the base unit to the second or third floor, or to some other location.

The Handset Does Not Ring When You Receive a Call.

- Make sure the ringer is turned on.
- Make sure the telephone line cord is plugged firmly into the base unit and the telephone jack. Make sure the power cord is plugged in.
- You may be too far from the base unit.
- You may have too many extension phones on your telephone line to allow all of them to ring. Try unplugging some of the other phones.

Warranty Statement

What does this limited warranty cover?

- The manufacturer of this **VTech** product, **VTech Communications**, warrants to the holder of a valid proof of purchase ("Consumer" or "you") that the product and all accessories provided by **VTech** in the sales package ("Product") are free from material defects in material and workmanship, pursuant to the following terms and conditions, when installed and used normally and in accordance with operation instructions. This limited warranty extends only to the Consumer for Products purchased and used in the United States of America.

What will VTech Communications do if the Product is not free from material defects in materials and workmanship during the limited warranty period ("Materially Defective Product")?

- During the limited warranty period, VTech authorized service representative will repair or replace at VTech's option, without charge, a Materially Defective Product. If we repair this product, we may use new or refurbished replacement parts. If we choose to replace this product, we may replace it with a new or refurbished product of the same or similar design. VTech will return repaired or replacement products to you in working condition. VTech will retain defective parts,

modules, or equipment. Repair or replacement of Product, at VTech option, is your exclusive remedy. You should expect the repair or replacement to take approximately 30 days.

How long is the limited warranty period ?

- The limited warranty period for the product extends for ONE(1)YEAR from the date of purchase if we repair or replace a Materially Defective Product under the terms of this limited warranty. This limited warranty also applies to repaired or replacement Products for a period of either (a) 90 days from the date the repaired or replacement Product is shipped to you or (b) the time remaining on the original one-year warranty; whichever is longer.

What is not covered by this limited warranty ?

This limited warranty does not cover.

1. Product that has been subjected to misuse, accident, shipping or other physical damage, improper installation, abnormal operation or handling, neglect, inundation, fire, water or other liquid intrusion; or
2. Product that has been damaged due to repair, alteration or modification by anyone other than an authorized service representative of VTech; or
3. Product to the extent that the problem experienced is caused by signal conditions, network reliability or cable or antenna systems; or

Warranty Statement

this Product. VTech provides no other warranties for this product. The warranty exclusively describes all of VTech responsibilities regarding the product. There are no other express warranties. No one is authorized to make modifications to this limited warranty and you should not rely on any such modification.

State Law Rights: This warranty gives you specific legal rights, and you may also have other rights which vary from state to state.

Limitations: Implied warranties, including those of fitness for a particular purpose and merchantability (an unwritten warranty that the product is fit for ordinary use) are limited to one year from date of purchase. Some states do not allow limitations on how long an implied warranty lasts, so the above limitation may not apply to you.

- In no event shall VTech be liable for any indirect, special, incidental, consequential, or similar damages (including, but not limited to lost profits or revenue, inability to use the product, or other associated equipment, the cost of substitute equipment, and claims by third parties) resulting from the use of this product. Some states do not

allow the exclusion or limitation of incidental or consequential damages, so the above limitation or exclusion may not apply to you.

Taking care of your telephone

Your **2151** cordless telephone contains sophisticated electronic parts, so it must be treated with care.

Avoid rough treatment

Place the handset down gently. Save the original packing materials to protect your telephone if you ever need to ship it.

Avoid water

Your telephone can be damaged if it gets wet. Do not use the handset outdoors in the rain, or handle it with wet hands. Do not install your base unit near a sink, bathtub or shower.

Electrical storms

Electrical storms can sometimes cause power surges harmful to electronic equipment. For your own safety, use caution when using electric appliances during storms.

Cleaning your telephone

Your telephone has a durable plastic casing that should retain its luster for many years. Clean it only with a soft cloth slightly dampened with water or a mild soap. Do not use excess water or cleaning solvents of any kind.

Remember that electrical appliances can cause serious injury if used when you are wet or standing in water. If your base unit should fall into water, **DO NOT RETRIEVE IT UNTIL YOU UNPLUG THE POWER CORD AND TELEPHONE LINE CORDS FROM THE WALL.** Then pull the unit out by the unplugged cords.

FREQUENCY CONTROL

Crystal Controlled Dual PLL Synthesizer

TRANSMIT FREQUENCY

Handset: 923.40-927.75MHz
Base: 902.40-907.05 MHz

RECEIVE FREQUENCY

Handset: 902.40- 907.05 MHz
Base: 923.40- 927.75 MHz

NOMINAL EFFECTIVE RANGE

Maximum power allowed by FCC and IC. Actual operating range may vary according to environmental conditions at the time of use.

SIZE

Handset: 16.1cm x 5.3cm x 3.9cm
Base: 16.3cm x 11.2cm x 9.7cm

WEIGHT

Handset: 166 grams
Base: 296 grams

POWER REQUIREMENTS

Handset: Self-contained nickel-cadmium rechargeable battery supply, 3.6V nominal, 300mAh capacity.
Base: 9V DC @ 300mA

MEMORY

PHONEBOOK: 12 Memory locations, up to 15 characters for name, 24 digits for number (including the nine speed dial locations)

CID: 60 Memory locations.

SPECIFICATIONS ARE TYPICAL AND MAY CHANGE WITHOUT NOTICE.

FCC, ACTA and IC Regulations

FCC Part 68 and ACTA

If this equipment was approved for connection to the telephone network prior to July 23, 2001, it complies with Part 68 of the Federal Communications Commission (FCC) rules. If the equipment was approved after that date, it complies with the Part 68 rules and with Technical Requirements for Connection of Equipment to the Telephone Network adopted by the Administrative Council for Terminal Attachments (ACTA). We are required to provide you with the following information.

1. Product identifier and REN information

The label on the back or bottom of this equipment contains, among other things, an identifier indicating product approval and the Ringer Equivalence Number (REN). This information must be provided to your local telephone company upon request. For equipment approved prior to July 23, 2001, the product identifier is preceded by the phrase "FCC Reg No." and the REN is listed separately. For equipment approved after that date, the product identifier is preceded by "US" and a colon (:), and the REN is encoded in the product identifier without a decimal point as the sixth and seventh characters following the colon. For example, the product identifier US:AAEQ03T123XYZ would

indicate an REN of 0.3. The REN is used to determine how many devices you may connect to your telephone line and still have them ring when you are called. In most, but not all areas, the sum of all RENs should be five (5.0) or less. You may want to contact your local telephone company for more information.

2. Connection and use with the nationwide telephone network

The plug and jack used to connect this equipment to the premises wiring and the telephone network must comply with the applicable Part 68 rules and technical requirements adopted by ACTA. A compliant telephone cord and modular plug is provided with this product. It is designed to be connected to a compatible modular jack that is also compliant. An RJ11 jack should normally be used for connecting to a single line and an RJ14 jack for two lines. See Installation Instructions in the user's manual. This equipment may not be used with Coin Telephone Lines or with Party Lines. If you have specially wired alarm dialing equipment connected to your telephone line, ensure the connection of this equipment does not disable your alarm equipment. If you have questions about what will disable alarm equipment, consult

FCC, ACTA and IC Regulations

Notice: This equipment meets the applicable Industry Canada Terminal Equipment Technical Specifications. This is confirmed by the registration number. The abbreviation, IC, before the registration number signifies that registration was performed based on a Declaration of Conformity indicating that Industry Canada technical specifications were met. It does not imply that Industry Canada approved the equipment.

Notice: The Ringer Equivalence Number (REN) for this terminal equipment is 0.1. The REN assigned to each terminal equipment provides an indication of the maximum number of terminals allowed to be connected to a telephone interface. The termination on an interface may consist of any combination of devices subject only to the requirement that the sum of the Ringer Equivalence Numbers of all the devices does not exceed five.

Before installing this equipment, users should ensure that it is permissible to be connected to the facilities of the local telecommunications company. The equipment must also be installed using an acceptable method of connection. The customer should be aware that compliance with the above conditions may not prevent degradation of services in some situations.

Repairs to certified equipment

should be made by an authorized Canadian maintenance facility designated by the supplier. Any repairs or alterations made by the user to this equipment, or equipment malfunctions, may give the telecommunications company cause to request the user to disconnect the equipment.

Users should ensure for their own protection that the electrical ground connections of the power utility, telephone lines and internal metallic water pipe system, if present, are connected together. This precaution may be particularly important in rural areas.

Caution:

Users should not attempt to make such connections themselves, but should contact the appropriate electrical inspection authority, or electrician, as appropriate.

Your **2151** is designed to operate at the maximum power allowed by the FCC and IC. This means your Handset and Base Unit can communicate only over a certain distance - which will depend on the location of the Base Unit and Handset, weather, and the construction and layout of your home or office.

This equipment complies with Parts 15 of the Federal Communications Commission (FCC) rules for the United States. It also complies with regulations RSS210 and CS-03 of Industry and Science Canada. Operation is subject to the following two conditions: (1) this device may not cause interference, and (2) this device must accept any interference, including interference that may cause undesired operation of the device.

A label is located on the underside of the Base Unit containing either the FCC registration number and Ringer Equivalence Number (REN) or the IC registration number and Load Number. You must, upon request, provide this information to your local telephone company.

This equipment is compatible with inductively coupled hearing aids.

Should you experience trouble with this telephone equipment, please contact:

VTech Communications Inc.

CUSTOMER SERVICE at 1-800-595-9511. In Canada, call VTech Telecommunications Canada Ltd. at 1-800-267-7377.

For repair/warranty information. The telephone company may ask you to disconnect this equipment from the line network until the problem has been corrected.

FCC Part 15

Warning: Changes or modifications to this unit not expressly approved by the party responsible for compliance could void the user's authority to operate the equipment.

The equipment has been tested and found to comply with part 15 of the FCC rules. These limits are designed to provide reasonable protection against harmful interference in a residential installation. This equipment generates, uses and can radiate radio frequency energy and, if not installed and used in accordance with the instructions, may cause harmful interference to radio communications. However, there is no guarantee that interference will not occur in a particular installation. If this equipment does cause harmful interference to radio or television reception, which can be determined by turning the equipment off and on, the user is encouraged to try and correct the interference by one or more of the following measures:

- Reorient or relocate the receiving antenna.
- Increase the separation between the equipment and receiver.
- Connect the equipment into an outlet or on a circuit different from that to which the receiver is connected.
- Consult the dealer or an experienced radio/TV technician for help.

FCC, ACTA and IC Regulations

your telephone company or a qualified installer.

3. Repair instructions

If this equipment is malfunctioning, it must be unplugged from the modular jack until the problem has been corrected. Repairs to this telephone equipment can only be made by the manufacturer or its authorized agents. For repair procedures, follow the instructions outlined under the Limited Warranty.

4. Rights of the telephone company

If this equipment is causing harm to the telephone network, the telephone company may temporarily discontinue your telephone service. The telephone company is required to notify you before interrupting service. If advance notice is not practical, you will be notified as soon as possible. You will be given the opportunity to correct the problem and the telephone company is required to inform you of your right to file a complaint with the FCC. Your telephone company may make changes in its facilities, equipment, operation, or procedures that could affect the proper functioning of this product. The telephone company is required to notify you if such changes are planned.

5. Hearing aid compatibility

If this product is equipped with a corded or cordless handset, it is hearing aid compatible.

6. Programming/testing of emergency numbers

If this product has memory dialing locations, you may choose to store police, fire department and emergency medical service telephone numbers in these locations. If you do, please keep three things in mind:

- a We recommend that you also write the telephone number on the directory card, so that you can still dial the emergency number manually if the memory dialing feature doesn't work.
- b This feature is provided only as a convenience, and the manufacturer assumes no responsibility for customer reliance upon the memory feature.
- c Testing the emergency telephone numbers you have stored is not recommended. However, if you do make a call to an emergency number:
 - You must remain on the line and briefly explain the reason for the call before hanging up.
 - Programming/testing of emergency numbers should be performed during off-peak hours, such as in the early morning or late evening, when the emergency services tend to be less busy.

IC (Industry Canada)

This telephone is registered for use in Canada.

The term "IC:" before the radio certification number only signifies that Industry Canada technical specifications were met.

The RBRC® Seal



The **RBRC**® seal on the nickel-cadmium battery indicates that VTech Communications, Inc. is voluntarily participating in an industry program to collect and recycle these batteries at the end of their useful lives, when taken out of service within the United States and Canada.

The **RBRC**® program provides a convenient alternative to placing used nickel-cadmium batteries into the trash or municipal waste, which may be illegal in your area.

VTech participation with **RBRC**® makes it easy for you to drop off the spent battery at local retailers participating in the **RBRC**® program or at authorized VTech product service centers. Please call **1-800-8-BATTERY**™ for information on Ni-Cd battery recycling and disposal bans / restrictions in your area. VTech's involvement in this program is part of its commitment to protecting our environment and conserving natural resources.

RBRC® is a registered trademark of Rechargeable Battery Recycling Corporation.

Congratulations on your purchase
of this VTech product

NEED HELP?

Our representatives are here
to help you with any questions
concerning the operation of this
product, available accessories,
or any other related issues.

Call Toll Free:

1-800-595-9511

In Canada, Call:

1-800-267-7377

or visit our website at
www.vtechphones.com

Free Manuals Download Website

<http://myh66.com>

<http://usermanuals.us>

<http://www.somanuals.com>

<http://www.4manuals.cc>

<http://www.manual-lib.com>

<http://www.404manual.com>

<http://www.luxmanual.com>

<http://aubethermostatmanual.com>

Golf course search by state

<http://golfingnear.com>

Email search by domain

<http://emailbydomain.com>

Auto manuals search

<http://auto.somanuals.com>

TV manuals search

<http://tv.somanuals.com>