

vtech

Cordless Telephone System With Caller ID

User's Manual

t 2415



Caller ID/call waiting*

90 Name and number
caller ID memory

Voice mail waiting indicator**

CALLER ID

Important Safety Instructions

When using your telephone equipment, basic safety precautions should always be followed to reduce the risk of fire, electric shock and injury, including the following:

1. Read and understand all instructions.
2. Follow all warnings and instructions marked on the product.
3. Unplug this product from the wall outlet before cleaning. Do not use liquid or aerosol cleaners. Use a damp cloth for cleaning.
4. Do not use this product near water (for example, near a bath tub, kitchen sink or swimming pool).
5. Do not place this product on an unstable surface, such as a table, shelf, or stand. The product may fall, causing serious damage.
6. Slots and openings in the back or bottom of the Base Unit and Handset are provided for ventilation. To protect them from overheating, these openings must not be blocked by placing the product on a soft surface such as a bed, sofa or rug. This product should never be placed near or over a radiator or heat register. This product should not be placed in any area where proper ventilation is not provided.
7. This product should be operated only from the type of power source indicated on the marking label. If you are not sure of the type of power supply in your home, consult your dealer or local power company.
8. Do not allow anything to rest on the power cord. Do not install this product where the cord may have anyone walking on it.
9. Never push objects of any kind into this product through slots in the Base or Handset as they may touch dangerous voltage points or short out parts that could result in a risk of fire or electric shock. Never spill liquid of any kind on the product.
10. To reduce the risk of electric shock, do not disassemble this product, but take it to an authorized service facility. Opening or removing parts of the Base or Handset other than specified access doors may expose you to dangerous voltages or other risks. Incorrect reassembling can cause electric shock when the product is subsequently used.
11. Do not overload wall outlets and extension cords as this can result in the risk of fire or electric shock.
12. Unplug this product from the wall outlet and refer servicing to an authorized service facility under the following conditions:
 - A. When the power supply cord or plug is damaged or frayed.

Important Safety Instructions

- B. If liquid has been spilled onto the product.
 - C. If the product has been exposed to rain or water.
 - D. If the product does not operate normally by following the operating instructions. Adjust only those controls that are covered by the operating instructions, as improper adjustment of other controls may result in damage and often requires extensive work by an authorized technician to restore the product to normal operation.
 - E. If the product has been dropped and the Base and/or Handset has been damaged.
 - F. If the product exhibits a distinct change in performance.
13. Avoid using a telephone (other than cordless) during an electrical storm.
There is a remote risk of electric shock from lightning.
14. Do not use the telephone to report a gas leak in the vicinity of the leak.
15. Only put the Handset of your telephone next to your ear when it is in normal talk mode.

Before You Begin

Enhanced 2.4GHz Technology - Dual Band transmission combines the best of 2.4GHz and 900MHz technologies, providing enhanced performance over standard cordless telephones.

Parts Check List

1. Base Unit
2. Handset
3. Base AC Power Adaptor
4. Telephone Line Cord
5. Battery
6. Belt Clip
7. User's Manual
8. Base Wall Mounting Bracket

To purchase replacement batteries, call VTech Communications, Inc. at 1-800-595-9511. In Canada, call VTech Telecommunications Canada Ltd. at 1-800-267-7377.



Handset

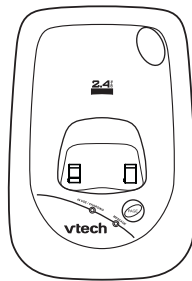

Base Unit

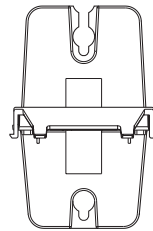

Base Wall Mounting Bracket



Battery Pack



Belt Clip

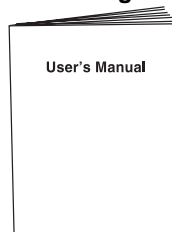

User's Manual

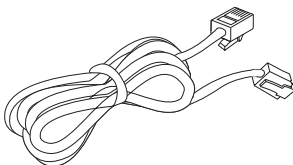

Telephone Line Cord

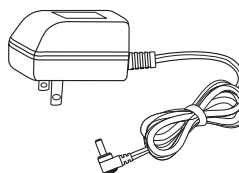

Base AC Power Adaptor

Installation

Before You Install

1. **Choose a location for the Base near an electrical outlet and a telephone jack.** This phone requires a modular telephone jack and a standard electrical outlet (110V AC) not controlled by a wall switch.
2. **Install the Handset battery.** Use only VTech batteries.

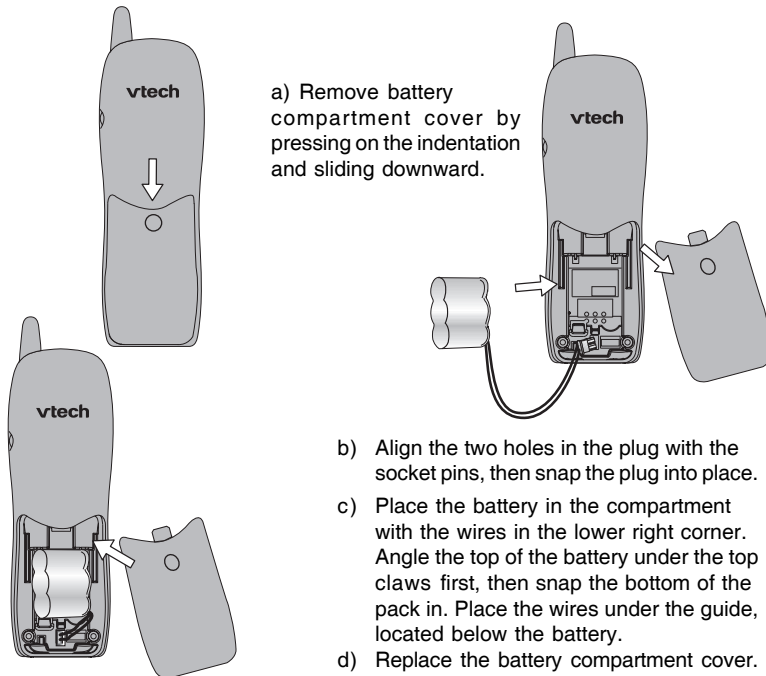

3. Attach the Belt Clip to the Handset (optional).

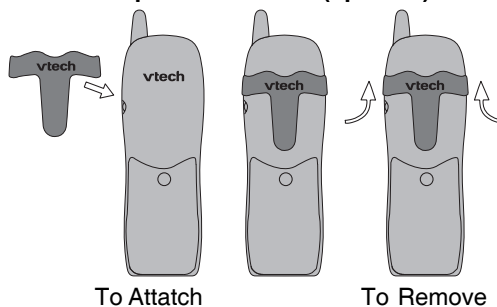

NOTE: Install the Base Unit away from electronic equipment, such as personal computers, television sets or microwave ovens. Avoid excessive heat, cold, dust or moisture.

Installation

Table/Desk Installation

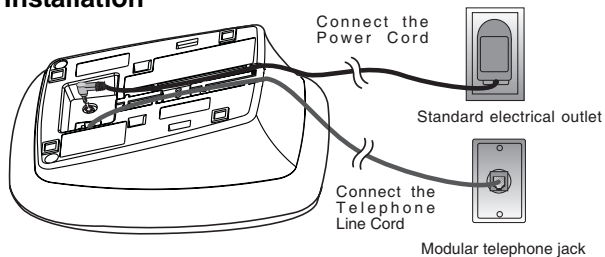

4. Charge the Handset Battery

Place the Handset in its Base. Charge the battery at least for 12 hours before using your telephone for the first time.

5. Check for Dial Tone

After the battery is charged, pick up the Handset and press **PHONE**. You should hear a dial tone.

6. Set the Dial Mode

If you have touch tone service, the phone is ready to use as soon as the battery is charged. If you have pulse (rotary) service, you'll need to change the dial mode.

- Make sure the Handset is off. Press **PROG**.
- Press ◀ or ▶ until the screen displays **DIAL MODE:** and the current selection.
- Press **SEL**. The current setting blinks.
- Press ◀ or ▶ to select **TONE** or **PULSE**.
- Press **SEL** or **PROG** to save the displayed mode.

7. Set Date and Time

If you subscribe to Caller ID service, the date and time will be set automatically with the first incoming call. If you do not have Caller ID service, you can set the date and time manually:

- Make sure the Handset is off. Press **PROG**.
- Press ◀ or ▶ until **DATE/TIME** is displayed. Press **SEL**.
- The month is flashing. Press ◀ or ▶ until the screen displays the correct month. Press **SEL**.
- The day is flashing. Press ◀ or ▶ until the screen displays the correct day. Press **SEL**.
- The hour is flashing. Press ◀ or ▶ until the screen displays the correct hour. Press **SEL**.
- The minute is flashing. Press ◀ or ▶ until the screen displays the correct minute. Press **SEL**.
- **AM** or **PM** is flashing. Press ◀ or ▶ to choose between **AM** or **PM**. Press **SEL**.

8. Set Language

- Press **PROG**.
- Press ◀ or ▶ until **LANGUAGE** is displayed.
- Press **SEL**. The current setting blinks. Press ◀ or ▶ to displays **ENGLISH**, **ESPAÑOL** or **FRENCH**.
- Press **SEL** to select displayed language and exit.

Installation

Wall Installation

The wall mount bracket is designed for use on standard wall mount plates only.

1. Run the power and telephone line cords through the slots in the bracket, then connect them to the jacks located on the underside of the Base.
2. Plug the AC adapter into an electrical outlet. If the battery pack has not been previously charged, place the Handset in its Base, and allow it to charge for 12 hours.
3. Connect the telephone line cord to the wall jack.
4. Line up the tabs on the wall mount bracket with the slots on the bottom of the Base Unit. Snap the bracket firmly in place.
5. Mount the Base on the wall. Position the Base Unit so the mounting studs will fit into the holes on the wall mount bracket. Slide the Base Unit down on the mounting studs until it locks into place.

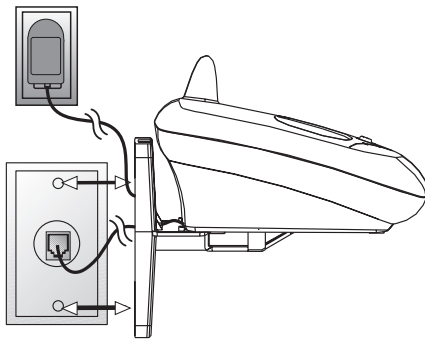

Telephone Operation

Handset Operation

Answer a Call

Press any key except **OFF**.

Hold

Press to put a call on hold. Press again to release hold.

-OR-

Lift the Handset of an extension.

Make a Call

Press **PHONE**, then dial the number.

-OR-

Dial the number (use ◀ to backspace and correct digits), then press **PHONE** to call.

Flash/Call Waiting

If you have Call Waiting service, a beep will sound when someone calls while you're on a call. Press **PHONE/FLASH** to put the current call on hold and take the new call. Press this button at any time to switch back and forth between calls.

Channel

Switch to a clear channel while on a call.

Delete

While Handset is in idle mode, press and hold to delete all records in the Call Log. When viewing the Call Log, press to delete the current record displayed.

Program

Enter programming mode with Handset idle (on hook).

Handset Volume

Adjust the volume while on a call. A double beep will sound when you reach the maximum or minimum setting.

Select

Use **SEL** in conjunction with **PROG** during Handset programming.

End a Call

Press **OFF**.

-OR-

Place Handset in its Base.

Exit

programming
Cancel a Page

Redial

Press **PHONE**, then press **REDIAL/PAUSE** to call the last number dialed.

-OR-

Press **REDIAL/PAUSE**, then press **PHONE** to call the last number dialed.

Press **REDIAL/PAUSE** twice to delete the last number dialed.

Pause

Press **REDIAL/PAUSE** to inset a pause when entering numbers.

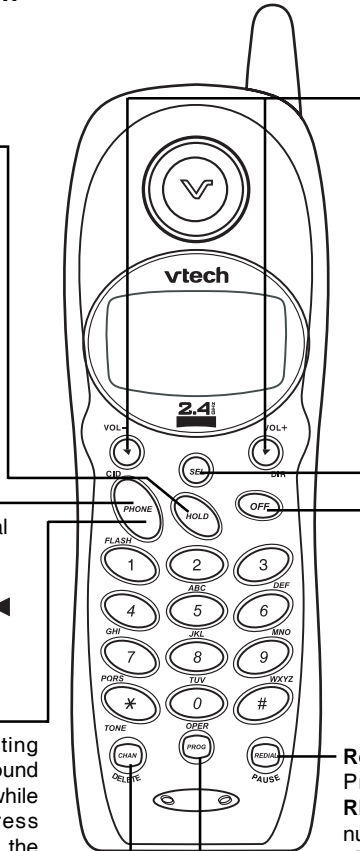

Telephone Operation

Base Operation

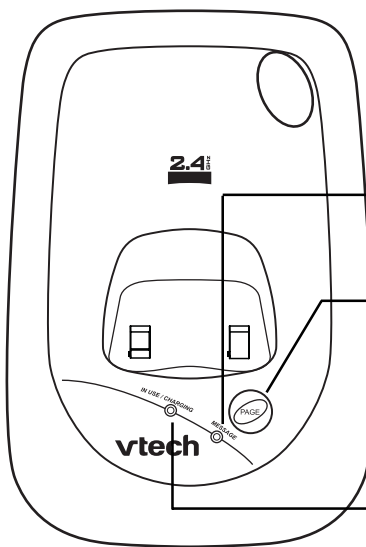

Message Waiting Indicator

If you subscribe to telephone company voicemail with a visual message waiting signal, this light flashes, and **MESSAGES WAITING** displays on the Handset screen, when you have voicemail waiting.

Page/Handset Locator

Press to page the Handset. Press again, press **OFF** on Handset, or place Handset in it's Base to cancel the page.

In Use/Charging Indicator

- Flashes in unison with the ring of an incoming call.
- Flashes slowly when the Handset is in use.
- Flashes rapidly when a call is on hold.
- Glows steadily when the Handset is charging.

Handset Ringer Style/Battery Save

You can select from four different Handset ringer styles, or turn the ringer off and extend the battery life.

1. Make sure the Handset is **OFF**.
2. Press **PROG**.
3. Press **◀** or **▶** until the screen displays **RINGER:** and the current selection.
4. Press **SEL**. The current setting blinks, and you will hear a sample of the ring.
5. Press **◀** or **▶** to select **RINGER: 1, 2, 3, 4** or **OFF**. You will hear a sample of each ring.
6. Press **SEL** to choose the displayed ringer setting.

Telephone Operation

Temporary Tone Dialing

If you have pulse (rotary) service only, you can change from pulse to touch tone dialing during a call by pressing ***TONE**. This is useful if you need to send touch tone signals for access to telephone banking or long distance services.

1. Dial the number.
2. Press ***TONE**. Buttons pressed after this send touch tone signals.
3. After you hang up, the phone automatically returns to pulse (rotary) service.

Message Waiting

Your **t 2415** is designed to work with most local and regional telephone service provider's voice messaging systems, providing alerts on both the Handset and Base Unit when new messages come in.

Voice messaging is subscription service, available through most service providers, for a monthly fee. Contact your local telephone company for more information.

When a caller leaves a message in your voice mailbox, the **MESSAGE** light on the Base Unit will flash. In addition, the Handset will display:

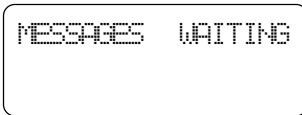

Clear Message Waiting Alert

1. Press **PROG**.
2. Press **◀** or **▶** until screen displays **MESSAGES WAITING**.
3. Press **SEL**, the screen displays:

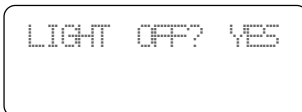

4. Press **◀** or **▶** to change from **YES** or **NO**.
5. Press **SEL** to choose the desired setting. You'll hear a confirmation one.

Display Screen Messages

Screen Displays:	When:
** RINGING **	There is a call coming in.
CONNECTING...	The Handset is waiting for a dial tone.
PHONE ON	The Handset is in use.
SCANNING...	The Handset is changing to another of the 30 channels available.
** PAGING **	The Base is paging the Handset.
HOLD	There is a call on hold.
BATTERY LOW	The Battery needs to be recharged.
NO CONNECT	Displays and a sad tone sounds when the Base power is off and PHONE is pressed. Displays and a sad tone sounds when Handset is out of range and an attempt to dial is failed.
MESSAGES WAITING	You have been alerted by the telephone company that you have received new voicemail.

Speed Dial

You can store up to 9 telephone numbers with names (up to 15 characters and 24 digits in each location) you dial frequently into the Speed Dial memory locations you assign (1 through 9). You can also store telephone numbers with names alphabetically in the directory. See **Telephone Directory** (on page 13) for instructions.

NOTES:

- The entries you store in Speed Dial memory will be marked with 01 through 09 in the telephone directory.
- Press **OFF** at any time to exit memory dial mode.

Store a Number/Name in Speed Dial

1. Press **PROG** on the Handset.
2. Press ◀ or ▶ until the screen displays **SPEED DIAL**.
3. Press **SEL**. The screen displays **ENTER 1-9**.

NOTE: When memory is full the screen displays **MEMORY FULL**, an error tone sounds, and you cannot store a new number until you delete a record in speed dial memory or telephone directory.

4. Press the key (1 through 9) for the memory location you wish to store this entry. The screen displays **ENTER NAME**.

NOTE: If the location is not empty, your new entry will be stored in place of the old and the first entry will be deleted. Take caution to not save over entries you do not wish to delete from speed dial memory.

5. Using the chart below, enter up to 15 characters for the name you're storing with the number. Use ◀ to backspace and make corrections; use ▶ to advance and add a space.

		Presses					
Dial Key		1	2	3	4	5	6
1:		1					
2:		A	B	C	2		
3:		D	E	F	3		
4:		G	H	I	4		
5:		J	K	L	5		
6:		M	N	O	6		
7:		P	Q	R	S	7	
8:		T	U	V	8		
9:		W	X	Y	Z	9	
0:		0					
*:		*					
#:		&	'	,	-	.	#

Speed Dial

- When you finish entering the name, press **SEL** or **PROG**. The screen displays **ENTER NUMBER**.
- Enter the telephone number. Use **◀** to backspace and make corrections. Press **REDIAL/PAUSE** to store a pause in the dialing sequence.
-OR-
Press **REDIAL/PAUSE** to display the last number dialed from this phone.
- Press **SEL** or **PROG** to store your entry. The screen displays **DISTINCT RING?** and the current setting.
- Press **◀** or **▶** to change the setting. Choose **Y** (for yes) if you wish the phone to alert you to calls from this number by changing to a distinctive ringing pattern after the first ring. Choose **N** (for no) for a normal ringing pattern.
- Press **SEL** or **PROG** to confirm your selection. If you chose **Y**, a **D** will be displayed with the entry.

Edit a Number/Name Stored in Speed Dial

- Press and hold the memory location key (1 through 9) of the entry you wish to edit.
- When the screen displays the entry you want to edit, press **SEL**. **EDIT** will be flashing.

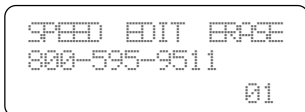

SPEED EDIT ERASE
800-595-9511
01

- Press **SEL**. The screen displays the name and number. The cursor appears at the end of the name. Use **◀**, **▶** and the dial pad keys to edit the name. Press **SEL** to move on to edit the number. Use **◀** to backspace and make corrections. Press **SEL** to move to edit the distinctive ring setting.
- Press **SEL** to save the edited information

Delete a Number/Name Stored in Speed Dial

- Press and hold the memory location key (1 through 9) of the entry you wish to delete.
- When the screen displays the entry you want to delete, press **SEL**. Then press **▶** until **ERASE** flashes.

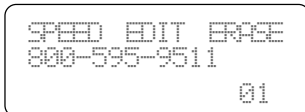

SPEED EDIT ERASE
800-595-9511
01

- Press **SEL**. The screen displays **ERASE NO YES** and the number.
- Press **▶** until **YES** flashes.
- Press **SEL**. You will hear a confirmation beep.

Speed Dial

Dial a Speed Dial Number

1. Press and hold the memory location key (1 through 9) of the entry you wish to dial.
2. Press **PHONE** to dial the displayed speed dial number.

Reassign Locations in Speed Dial

1. Press and hold the memory location key (1 through 9) of the entry you wish to reassign.
2. When the screen displays the entry you want to reassign, press **SEL**. Then press ◀ until **SPEED** flashes.

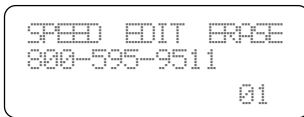

3. Press **SEL**. The screen displays **ENTER 1-9**.
4. Press the keys (1 through 9) to reassign this entry into another speed dial memory location. You will hear a confirmation beep.

Telephone Directory

Your t 2415 can store 50 (including the nine Speed Dial entries) telephone numbers with names (up to 15 characters for the name and 24 digits for the number in each location).

NOTE: Press **OFF** at any time to exit directory.

Store a Number/Name in the Directory

1. Press **PROG**. The screen displays **DIRECTORY**.
2. Press **SEL**. The screen displays **ENTER NAME**.
3. Using the chart below, enter up to 15 characters for the name you're storing with the number. Use ◀ to backspace and make corrections; use ▶ to advance and add a space.

Dial Key	Presses					
	1	2	3	4	5	6
1:	1					
2:	A	B	C	2		
3:	D	E	F	3		
4:	G	H	I	4		
5:	J	K	L	5		
6:	M	N	O	6		
7:	P	Q	R	S	7	
8:	T	U	V	8		
9:	W	X	Y	Z	9	
0:	0					
*:	*					
#:	&	'	,	-	.	#

4. When you finish entering the name, press **SEL** or **PROG**. The screen displays **ENTER NUMBER**.
5. Enter the telephone number. Use ◀ to backspace and make corrections. Press **REDIAL/PAUSE** to store a pause in the dialing sequence.
-OR-
Press **REDIAL/PAUSE** to display the last number dialed from this phone.
6. Press **SEL** or **PROG**. The screen displays **DISTINCT RING?** and the current setting.
7. Press ◀ or ▶ to change the setting. Choose **Y** (for yes) if you wish the phone to alert you to calls from this number by changing to a distinctive ringing pattern after the first ring. Choose **N** (for no) for a normal ringing pattern.

Telephone Directory

- Press **SEL** or **PROG** to confirm your selection. If you chose **Y**, a **D** will be displayed with the directory entry.

NOTE: When memory is full the screen displays **MEMORY FULL**, an error tone sounds, and you will not be able to store a new number until you delete a stored entry.

Edit a Number/Name Stored in the Directory

- Press **▶** (**DIR**). The screen displays **DIRECTORY**.
- Press **◀** or **▶** to scroll alphabetically through the entries stored in the directory.
-OR-
Press the dial pad key for the first letter of the entry you want to edit.
- When the screen displays the entry you want to edit, press **SEL**. **EDIT** flashes on the screen.

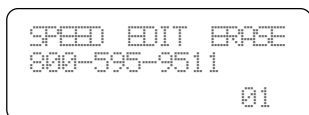

```
SPEED EDIT ERASE
800-595-9511
01
```

- Press **SEL**. The screen displays the name and number. The cursor appears at the end of the name. Use **◀**, **▶** and the dial pad keys to edit the name. Press **SEL** to move on to edit the number. Use **◀** to backspace and make corrections. Press **SEL** to move on to edit the distinctive ring setting.
- Press **SEL** to save the edited information.

Delete a Number/Name Stored in the Directory

- Press **▶** (**DIR**). The screen displays **DIRECTORY**.
- Press **◀** or **▶** to scroll alphabetically through entries in the directory.
-OR-
Press the dial pad key for the first letter of the entry you want to delete.
- When the screen displays the entry you want to delete, press **SEL**. Then press **◀** until **ERASE** flashes.

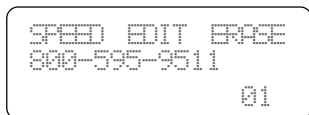

```
SPEED EDIT ERASE
800-595-9511
01
```

- Press **SEL**. The screen displays **ERASE NO YES** and the number. The current choice flashes.
- Press **▶** until **YES** flashes.
- Press **SEL**. You'll hear a confirmation beep.

Telephone Directory

Dial a Number from the Directory

1. Press **►** (**DIR**). The screen displays **DIRECTORY**.
2. Press **◀** or **►** to scroll alphabetically through entries stored in directory.
-OR-
Press the dial pad key for the first letter of the entry you want to dial.
3. When the number you want to dial is displayed, press **PHONE**.

Move a Number/Name to the Speed Dial Memory

1. Press **►** (**DIR**). The screen displays **DIRECTORY**.
2. Press **◀** or **►** to scroll alphabetically through directory.
- OR -
Press the dial pad key for the first letter of the entry you want to move.
3. When the screen displays the entry you want to move, press **SEL**. Then press **►** until **SPEED** flashes.

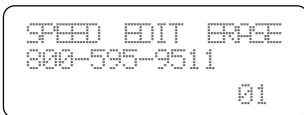

```
SPEED EDIT ERASE
800-595-9511
01
```

4. Press **SEL**. The screen displays **ENTER 1-9**.
5. Press the key (1 through 9) to move this entry from the normal directory to the Speed Dial memory and assign the memory location. You will hear a confirmation beep. A memory location number (01 through 09) will be displayed with this entry.

Caller ID Operation

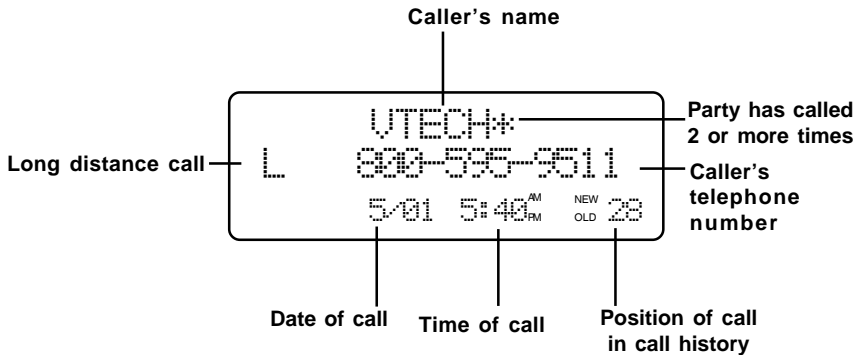

About Call History (Caller ID)

Your t 2415 can store up to 90 calls in its Caller ID memory. The most recent call will have the highest number. When the memory is full, the oldest call will be deleted to make room for new incoming call information.

If you answer a call before the information appears on the screen, it will not be in the call history.

Review Call History

1. Press ◀ (CID) to view call history.
2. Use ◀ or ▶ to scroll through records in call history.

NOTE: Press OFF at any time to exit call history.

Delete Records from Call History

Delete a Specific Call:

1. Locate the record you want to delete from call history.
2. Press **DELETE**. You'll hear a confirmation beep.

Delete All Calls:

1. With the Handset in idle (OFF) mode, press and hold **CHAN/DELETE**. The screen displays **ERASE ALL NO YES**. The current choice flashes.
2. Press ▶ until **YES** flashes.
3. Press **SEL**. You'll hear a confirmation beep.

Caller ID Operation

Dial a Displayed Number

1. Locate the record in call history that you want to dial.
2. If you wish to change how the number is dialed, press **#**. The screen displays alternate dialing sequences available for this call (area code + number; 1 + area code + number; number only; 1+ number).
3. Press **SEL**. **DIAL** flashes on the screen.

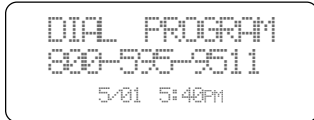

4. Press **SEL** again. The number is automatically dialed.
- OR -
When the number is correctly displayed for dialing, press **PHONE**.

Store a Call History Record in the Directory

1. Locate the record in the call history you want to store in the directory.
2. If you wish to change how the number is stored, press **#**. The screen displays alternate dialing sequences available for this call (area code + number; 1 + area code + number; number only; 1+ number).
3. Press **SEL**, then press **▶** until **PROGRAM** flashes.

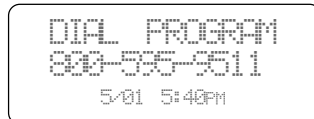

4. Press **SEL** three times. The screen displays:

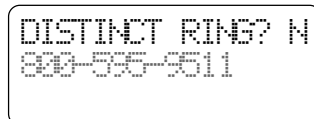

5. Press **◀** or **▶** to select **Y** or **N** for distinctive ringer.
6. Press **SEL**. You will hear a confirmation beep. If you choose **Y** in step five a **D** will be displayed with the directory entry.

Caller ID Operation

Display Screen Messages

Screen Displays: When:

PRIVATE	The other party is blocking name and/or number information.
UNKNOWN	Your phone company is unable to receive information about this caller's name and/or number.
* (after the name)	This caller has called you more than once.

Batteries

Battery Care and Maintenance

- Maximum talk time on a fully charged battery is approximately 6 hours. Maximum standby time is 7 days.
- The Battery needs charging when:
 - A new battery is installed in the Handset.
 - The phone beeps twice every five seconds.
 - The screen displays **BATTERY LOW** and the low battery icon.
- Place the Handset in its Base so the **CHARGING** light turns on. The Battery is typically fully charged in 12 hours.
- You can keep the battery fully charged by returning the Handset to its Base after each use.
- If you repeatedly get a low battery indicator, even after charging overnight, the battery should be replaced. Use only VTech batteries.

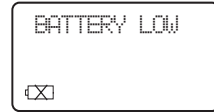

CAUTION: To reduce the risk of fire or injury to persons or damage to the telephone, read and follow these instructions carefully:
Charge the battery provided with or identified for use with this product only in accordance with the instructions and limitations specified in the User's Manual.

Replacing the Handset Battery

1. Remove the battery compartment cover on the Handset by pressing on the indentation and sliding the cover downward.
2. Lift out the old battery and disconnect.
3. Align the two holes in the new battery's plug with the socket pins, and snap the plug into place. Place the battery in the compartment with the wires in the over right corner, along the bottom of the battery.
4. Replace the cover by sliding it up into place.
5. The new battery must be charged before using the phone. Place the Handset in its Base and allow it to charge for at least 12 hours the first charge. The telephone might operate before that, but for best performance, let the battery charge fully.

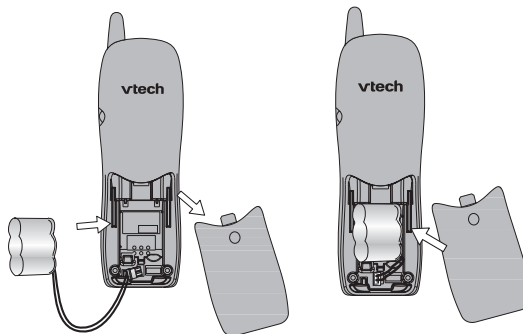

Headset Operation

Your **t 2415** Handset is equipped with a 2.5mm Headset Jack for use with an optional accessory Headset for handsfree operation. If you choose to use the Headset option, you must obtain an optional accessory Headset, which is compatible with the **t 2415**. For best results, use a VTech 2.5mm headset.

To purchase a Headset, call VTech Customer Service at 1-800-595-9511.

Once you have a compatible 2.5mm Headset, locate the Headset Jack on the **t 2415** Handset. Connect the plug on the Headset cord to the jack (under a small rubber flap) on the cordless Handset. The plug should fit securely. Do not force the connection.

NOTE: Whenever a compatible Headset is connected to the cordless Handset, the microphone on the Handset will be muted. This is done to limit the effect of background noise.

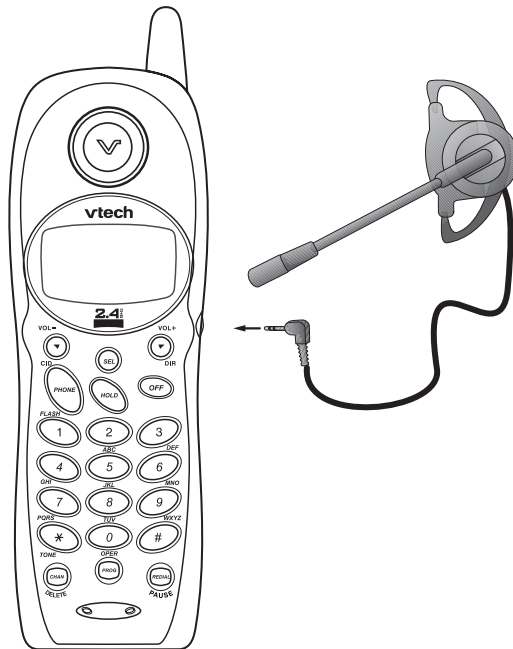

In Case of Difficulty

If you have difficulty operating your phone, the suggestions below should solve the problem. If you still have difficulty after trying these suggestions, call VTech Communications at 1-800-595-9511. In Canada, call VTech Telecommunications Canada Ltd. at 1-800-267-7377.

The phone doesn't work at all

- Make sure the Power Cord is plugged in.
- Make sure the telephone line cord is plugged firmly into the Base Unit and the telephone wall jack.
- Make sure the battery is properly charged. If you get a **BATTERY LOW** message or icon, the battery needs charging.

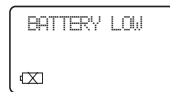

No dial tone

- First try all the suggestions above.
- If you still don't hear a dial tone, disconnect the Base Unit from the telephone jack and connect a different phone. If there is no dial tone on that phone either, the problem is in your wiring or local service. Contact your local telephone company.

You get noise, static, or a weak signal even when you're near the Base Unit

- Household appliances plugged into the same circuit as the Base Unit can sometimes cause interference. Try moving the appliance or the Base Unit to another outlet.

You get noise, static, or a weak signal when you're away from the Base Unit

- You may be out of range. Either move closer to the Base, or relocate the Base Unit.
- The layout of your home may be limiting the range. Try moving the Base Unit to another position.

The Handset does not ring when you receive a call

- Make sure you have the ringer activated. Refer to the section on **Handset Ringer Style/Battery Save** (see page 8) in this User's Manual.
- Make sure the telephone line cord is plugged firmly into the Base Unit and the telephone jack. Make sure the power cord is plugged in.
- You may be too far from the Base Unit.
- You may have too many extension phones on your telephone line to allow all of them to ring. Try unplugging some of the other phones.

In Case of Difficulty

You hear other calls while using your phone

- Disconnect your Base Unit from the telephone jack, and plug in a regular telephone. If you still hear other calls, the problem is probably in your wiring or local service. Call your local telephone company.

You hear noise in the Handset, and none of the keys or buttons work

- Make sure the power cord is plugged in.

Common cure for electronic equipment

If the unit does not seem to be responding normally, then try putting the Handset in the cradle. If it does not seem to respond, do the following (in the order listed):

1. Disconnect the power to the Base.
2. Disconnect the Handset battery, and spare battery pack, if applicable.
3. Wait a few minutes.
4. Connect power to the Base.
5. Re-install the battery.
6. Wait for the Handset to re-establish its link with the Base. To be safe, allow up to one minute for this to take place.

Maintenance

Taking care of your telephone

Your cordless telephone contains sophisticated electronic parts, so it must be treated with care.

Avoid rough treatment

Place the Handset down gently. Save the original packing materials to protect your telephone if you ever need to ship it.

Avoid water

Your telephone can be damaged if it gets wet. Do not use the Handset outdoors in the rain, or handle it with wet hands. Do not install your Base Unit near a sink, bathtub, or shower.

Electrical storms

Electrical storms can sometimes cause power surges harmful to electronic equipment.

For your own safety, use caution when using electric appliances during storms.

Cleaning your telephone

Your telephone has a durable plastic casing that should retain its luster for many years. Clean it only with a soft cloth slightly dampened with water or a mild soap. Do not use excess water or cleaning solvents of any kind.

Remember that electrical appliances can cause serious injury if used when you are wet or standing in water. If your Base Unit should fall into water, **DO NOT RETRIEVE IT UNTIL YOU UNPLUG THE POWER CORD AND TELEPHONE LINE CORDS FROM THE WALL.** Then pull the unit out by the unplugged cords.

Warranty Statement

What does this limited warranty cover?

- The manufacturer of this VTech product, VTech Communications, warrants to the holder of a valid proof of purchase (“Consumer” or “you”) that the product and all accessories provided by VTech in the sales package (“Product”) are free from material defects in material and workmanship, pursuant to the following terms and conditions, when installed and used normally and in accordance with operation instructions. This limited warranty extends only to the Consumer for Products purchased and used in the United States of America.

What will VTech Communications do if the Product is not free from material defects in materials and workmanship during the limited warranty period (“Materially Defective Product”)?

- During the limited warranty period, VTech’s authorized service representative will repair or replace at VTech’s option, without charge, a Materially Defective Product. If we repair this product, we may use new or refurbished replacement parts. If we choose to replace this product, we may replace it with a new or refurbished product of the same or similar design. VTech will return repaired or replacement products to you in working condition. VTech will retain defective parts, modules, or equipment. Repair or replacement of Product, at VTech’s option, is your exclusive remedy. You should expect the repair or replacement to take approximately 30 days.

How long is the limited warranty period?

- The limited warranty period for the product extends for ONE (1) YEAR from the date of purchase if we repair or replace a Materially Defective Product under the terms of this limited warranty. This limited warranty also applies to repaired or replacement Products for a period of either (a) 90 days from the date the repaired or replacement Product is shipped to you or (b) the time remaining on the original one-year warranty; whichever is longer.

What is not covered by this limited warranty?

This limited warranty does not cover:

1. Product that has been subjected to misuse, accident, shipping or other physical damage, improper installation, abnormal operation or handling, neglect, inundation, fire, water or other liquid intrusion; or
2. Product that has been damaged due to repair, alteration or modification by anyone other than an authorized service representative of VTech; or
3. Product to the extent that the problem experienced is caused by signal conditions, network reliability or cable or antenna systems; or
4. Product to the extent that the problem is caused by use with non-VTech electrical accessories; or
5. Product whose warranty/quality stickers, Product serial numbers plates or electronic serial numbers have been removed, altered or rendered illegible; or
6. Product purchased, used, serviced or shipped for repair from outside the United States, or used for commercial or institutional purposes (including but not limited to Products used for rental purposes); or
7. Product returned without valid proof of purchase (see 2 below); or

Warranty Statement

8. Charges for installation or set up, adjustment of customer controls and installation or repair of systems outside the unit.

How do you get warranty service?

- To obtain warranty service in the United States of America, call 1-800-595-9511 for instructions regarding where to return the Product. Before calling for service, please check the user's manual. A check of the Product controls and features may save you a service call.
- Except as provided by applicable law, you assume the risk of loss or damage during transit and transportation and are responsible for delivery or handling charges incurred in the transport of Product(s) to the service location. VTech will return repaired or replaced product under this limited warranty to you, transportation, delivery or handling charges prepaid. VTech assumes no risk for damage or loss of the Product in transit.
- If the Product failure is not covered by this limited warranty, or proof of purchase does not meet the terms of this limited warranty, VTech will notify you and will request that you authorize the cost of repair prior to any further repair activity. You must pay for the cost of repair and return shipping costs for the repair of Products that are not covered by this limited warranty.

What must you return with the Product to get warranty service?

1. Return the entire original package and contents including the Product to the VTech service location along with a description of the malfunction or difficulty;
2. Include "valid proof of purchase" (sales receipt) identifying the Product purchased (Product model) and the date of purchase or receipt; and
3. Provide your name, complete and correct mailing address, and telephone number.

Other Limitations

- This warranty is the complete and exclusive agreement between you and VTech. It supersedes all other written or oral communications related to this Product. VTech provides no other warranties for this product. The warranty exclusively describes all of VTech's responsibilities regarding the product.

There are no other express warranties. No one is authorized to make modifications to this limited warranty and you should not rely on any such modification.

State Law Rights: This warranty gives you specific legal rights, and you may also have other rights which vary from state to state.

Limitations: Implied warranties, including those of fitness for a particular purpose and merchantability (an unwritten warranty that the product is fit for ordinary use) are limited to one year from date of purchase. Some states do not allow limitations on how long an implied warranty lasts, so the above limitation may not apply to you.

- In no event shall VTech be liable for any indirect, special, incidental, consequential, or similar damages (including, but not limited to lost profits or revenue, inability to use the product, or other associated equipment, the cost of substitute equipment, and claims by third parties) resulting from the use of this product. Some states do not allow the exclusion or limitation of incidental or consequential damages, so the above limitation or exclusion may not apply to you.

FCC, ACTA and IC Regulations

This equipment complies with Parts 15 of the Federal Communications Commission (FCC) rules for the United States. It also complies with regulations RSS210 and CS-03 of Industry and Science Canada. Operation is subject to the following two conditions: (1) this device may not cause interference, and (2) this device must accept any interference, including interference that may cause undesired operation of the device.

A label is located on the underside of the Base Unit containing either the FCC registration number and Ringer Equivalence Number (REN) or the IC registration number and Load Number. You must, upon request, provide this information to your local telephone company.

This equipment is compatible with inductively coupled hearing aids.

Should you experience trouble with this telephone equipment, please contact:

VTech Communications Inc. CUSTOMER SERVICE at 1-800-595-9511. In Canada, call VTech Telecommunications Canada Ltd. at 1-800-267-7377.

for repair/warranty information. The telephone company may ask you to disconnect this equipment from the line network until the problem has been corrected.

FCC Part 15

Warning: Changes or modifications to this unit not expressly approved by the party responsible for compliance could void the user's authority to operate the equipment. The equipment has been tested and found to comply with part 15 of the FCC rules. These limits are designed to provide reasonable protection against harmful interference in a residential installation. This equipment generates, uses and can radiate radio frequency energy and, if not installed and used in accordance with the instructions, may cause harmful interference to radio communications. However, there is no guarantee that interference will not occur in a particular installation. If this equipment does cause harmful interference to radio or television reception, which can be determined by turning the equipment off and on, the user is encouraged to try and correct the interference by one or more of the following measures:

- Reorient or relocate the receiving antenna.
- Increase the separation between the equipment and receiver.
- Connect the equipment into an outlet or on a circuit different from that to which the receiver is connected.
- Consult the dealer or an experienced radio/TV technician for help.

FCC Part 68 and ACTA

If this equipment was approved for connection to the telephone network prior to July 23, 2001, it complies with Part 68 of the Federal Communications Commission (FCC) rules. If the equipment was approved after that date, it complies with the Part 68 rules and with Technical Requirements for Connection of Equipment to the Telephone Network adopted by the Administrative Council for Terminal Attachments (ACTA). We are required to provide you with the following information.

FCC, ACTA and IC Regulations

1. Product identifier and REN information

The label on the back or bottom of this equipment contains, among other things, an identifier indicating product approval and the Ringer Equivalence Number (REN). This information must be provided to your local telephone company upon request. For equipment approved prior to July 23, 2001, the product identifier is preceded by the phrase "FCC Reg No." and the REN is listed separately. For equipment approved after that date, the product identifier is preceded by "US" and a colon (:), and the REN is encoded in the product identifier without a decimal point as the sixth and seventh characters following the colon. For example, the product identifier US:AAAEQ03T123XYZ would indicate an REN of 0.3.

The REN is used to determine how many devices you may connect to your telephone line and still have them ring when you are called. In most, but not all areas, the sum of all RENs should be five (5.0) or less. For more information, please contact your local telephone company.

2. Connection and use with the nationwide telephone network

The plug and jack used to connect this equipment to the premises wiring and the telephone network must comply with the applicable Part 68 rules and technical requirements adopted by ACTA. A compliant telephone cord and modular plug is provided with this product. It is designed to be connected to a compatible modular jack that is also compliant. An RJ11 jack should normally be used for connecting to a single line and an RJ14 jack for two lines. See Installation Instructions in this user's manual. This equipment may not be used with Coin Telephone Lines or with Party Lines. If you have specially wired alarm dialing equipment connected to your telephone line, ensure the connection of this equipment does not disable your alarm equipment. If you have questions about what will disable alarm equipment, consult your telephone company or a qualified installer.

3. Repair instructions

If this equipment is malfunctioning, it must be unplugged from the modular jack until the problem has been corrected. Repairs to this telephone equipment can only be made by the manufacturer or its authorized agents. For repair procedures, follow the instructions outlined under the Limited Warranty.

4. Rights of the telephone company

If this equipment is causing harm to the telephone network, the telephone company may temporarily discontinue your telephone service. The telephone company is required to notify you before interrupting service. If advance notice is not practical, you will be notified as soon as possible. You will be given the opportunity to correct the problem and the telephone company is required to inform you of your right to file a complaint with the FCC. Your telephone company may make changes in its facilities, equipment, operation, or procedures that could affect the proper functioning of this product. The telephone company is required to notify you if such changes are planned.

5. Hearing aid compatibility

If this product is equipped with a corded or cordless handset, it is hearing aid compatible.

6. Programming/testing of emergency numbers

FCC, ACTA and IC Regulations

If this product has memory dialing locations, you may choose to store police, fire department and emergency medical service telephone numbers in these locations. If you do, please keep three things in mind:

- a. We recommend that you also write the telephone number on the directory card, so that you can still dial the emergency number manually if the memory dialing feature doesn't work.
- b. This feature is provided only as a convenience, and the manufacturer assumes no responsibility for customer reliance upon the memory feature.
- c. Testing the emergency telephone numbers you have stored is not recommended. However, if you do make a call to an emergency number:
 - You must remain on the line and briefly explain the reason for the call before hanging up.
 - Programming/testing of emergency numbers should be performed during off-peak hours, such as in the early morning or late evening, when the emergency services tend to be less busy.

IC (Industry Canada)

This telephone is registered for use in Canada.

The term "IC:" before the radio certification number only signifies that Industry Canada technical specifications were met.

Notice: This equipment meets the applicable Industry Canada Terminal Equipment Technical Specifications. This is confirmed by the registration number. The abbreviation, IC, before the registration number signifies that registration was performed based on a Declaration of Conformity indicating that Industry Canada technical specifications were met. It does not imply that Industry Canada approved the equipment.

Notice: The Ringer Equivalence Number (REN) for this terminal equipment is 0.1. The REN assigned to each terminal equipment provides an indication of the maximum number of terminals allowed to be connected to a telephone interface. The termination on an interface may consist of any combination of devices subject only to the requirement that the sum of the Ringer Equivalence Numbers of all the devices does not exceed five.

Before installing this equipment, users should ensure that it is permissible to be connected to the facilities of the local telecommunications company. The equipment must also be installed using an acceptable method of connection. The customer should be aware that compliance with the above conditions may not prevent degradation of services in some situations.

Repairs to certified equipment should be made by an authorized Canadian maintenance facility designated by the Supplier. Any repairs or alterations made by the user to this equipment, or equipment malfunctions, may give the telecommunications company cause to request the user to disconnect the equipment.

FCC, ACTA and IC Regulations

Users should ensure for their own protection that the electrical ground connections of the power utility, telephone lines and internal metallic water pipe system, if present, are connected together. This precaution may be particularly important in rural areas.

Caution:

Users should not attempt to make such connections themselves, but should contact the appropriate electrical inspection authority or electrician as appropriate.

Your Cordless Phone is designed to operate at the maximum power allowed by the FCC and IC. This means your Handset and Base Unit can communicate only over a certain distance - which will depend on the location of the Base Unit and Handset, weather, and the construction and layout of your home or office.

The RBRC® Seal

The **RBRC®** Seal on the nickel-cadmium battery indicates that VTech Communications, Inc. is voluntarily participating in an industry program to collect and recycle these batteries at the end of their useful lives, when taken out of service within the United States and Canada.

The **RBRC®** program provides a convenient alternative to placing used nickel-cadmium batteries into the trash or municipal waste, which may be illegal in your area.

VTech's participation in **RBRC®** makes it easy for you to drop off the used battery at local retailers participating in the **RBRC®** program or at authorized VTech product service centers. Please call **1-800-8-BATTERY™** for information on Ni-Cd battery recycling and disposal bans/restrictions in your area. VTech's involvement in this program is part of its commitment to protecting our environment and conserving natural resources.



RBRC® is a registered trademark of Rechargeable Battery Recycling Corporation.

Technical Specifications

FREQUENCY CONTROL

Crystal controlled
PLL synthesizer

TRANSMIT FREQUENCY

Base: 2410.2 - 2417.4 MHz
Handset: 912.75 - 916.35 MHz

RECEIVE FREQUENCY

Base: 912.75 - 916.35 MHz
Handset: 2410.2 - 2417.4 MHz

CHANNELS

30 Channels

NOMINAL EFFECTIVE RANGE

Maximum power allowed by FCC and IC. Actual operating range may vary according to environmental conditions at the time of use.

SIZE

Handset: 187mm x 58mm x 36mm
Base: 158mm x 112mm x 97mm

WEIGHT

Handset: 142.6 grams
Base: 208.6 grams
(excluding battery pack)

POWER REQUIREMENTS

Handset: 3.6V 400mAh Ni-Cd Battery
Base: 9V DC @ 300mA

MEMORY

Speed Dial: 9 Memory locations;
up to 24 digits, 15 characters per location
Directory: 50 Memory locations;
up to 24 digits, 15 characters per location
CID: 90 Memory locations

SPECIFICATIONS ARE TYPICAL AND MAY CHANGE WITHOUT NOTICE.



vtech

VTECH TELECOMMUNICATIONS LTD.

vtech A member of THE VTECH GROUP OF COMPANIES.

Distributed in the U.S.A. by VTech Communications, Inc. Beaverton,
Oregon, 97008

Distributed in Canada by VTech Telecommunications Canada Ltd. 7671
Alderbridge Way, Richmond, B.C. V6X 1Z9.

Copyright 2004 for VTECH TELECOMMUNICATIONS LTD.
Printed in China

91-005900-010-000
ISSUED 0

Replacement Battery Order Form

Part Number (Description)	QTY	X	Price	=	Subtotal
---------------------------	-----	---	-------	---	----------

80-5074-01-00
(SBA Series Battery, 3.6V 400mAh Ni-Cd) _____ x \$14.95 = _____

For orders up to \$80, add \$6.95 Shipping _____

For orders over \$80, add \$9.95 Shipping _____

+ Sales Tax (if applicable) _____

TOTAL _____

SHIPPING INFORMATION

NAME _____

ADDRESS _____

CITY _____ STATE _____ ZIP _____

DAY TIME PHONE () _____

DELIVERY IS LIMITED TO THE CONTINENTAL US, ALASKA, HAWAII, PUERTO RICO, AND THE US VIRGIN ISLANDS. NO DELIVERY TO PO BOXES OR APO ADDRESSES.

METHOD OF PAYMENT: DO NOT SEND CASH

- CHECK MONEY ORDER VISA
 MASTERCARD AMERICAN EXPRESS DISCOVER

Checks and Money Orders should be made payable to VTech Communications, Inc.

BILLING INFORMATION

CREDIT CARD # _____

EXPIRATION DATE _____ SECURITY CODE* _____

CARDHOLDER'S SIGNATURE _____

BILLING ADDRESS IF PAYING BY CREDIT CARD (as it appears on your credit card statement)

NAME _____

ADDRESS _____

CITY _____ STATE _____ ZIP _____

*The last three or four digits on the signature strip (back side) of your credit card.

Place order form and payment in envelope and send to:

VTech Communications, Inc.
PO Box 178
Valley Park, MO 63088-0178

You may also order online at
www.vtechphones.com
or by calling 1-800-595-9511



Table of Contents

Important Safety Instructions	1
Before You Begin	3
Parts Check List	3
Getting Started	4
Installation	4
Before You Install	4
Table/Desk Installation	5
Wall Installation.....	6
Basic Operation	7
Telephone Operation	7
Handset Operation.....	7
Base Operation	8
Handset Ringer Style/Battery Save.....	8
Temporary Tone Dialing.....	9
Message Waiting.....	9
Display Screen Messages	10
Speed Dial	11
Store a Number/Name in Speed Dial Memory	11
Edit a Number/Name Stored in Speed Dial Memory	12
Delete a Number/Name Stored in Speed Dial Memory	12
Dial a Speed Dial Memory Number	13
Reassign Locations in Speed Dial Memory	13
Telephone Directory	14
Store a Number/Name in the Directory	14
Edit a Number/Name Stored in the Directory	15
Delete a Number/Name Stored in the Directory	15
Dial a Number from the Directory.....	16
Move a Number/Name to the Speed Dial Memory.....	16
Caller ID Operation	17
About Call History	17
Review Call History	17
Delete Records from Call History	17
Dial a Displayed Number.....	18
Store a Call History Record in the Directory.....	18
Display Screen Messages.....	19
Batteries	20
Battery Care and Maintenance	20
Replacing the Handset Battery.....	20
Additional Information	21
Headset Operation	21
In Case of Difficulty	22
Maintenance	24
Warranty Statement	25
FCC, ACTA and IC Regulations	27
The RBRC® Seal	30
Technical Specifications	31

Free Manuals Download Website

<http://myh66.com>

<http://usermanuals.us>

<http://www.somanuals.com>

<http://www.4manuals.cc>

<http://www.manual-lib.com>

<http://www.404manual.com>

<http://www.luxmanual.com>

<http://aubethermostatmanual.com>

Golf course search by state

<http://golfingnear.com>

Email search by domain

<http://emailbydomain.com>

Auto manuals search

<http://auto.somanuals.com>

TV manuals search

<http://tv.somanuals.com>