

Important! Before using this telephone, you must read the **Important safety instructions** on page 68 of this manual.

NEED HELP?

This manual has all the feature operations and troubleshooting you need to install and operate your new VTech telephone. Please take the time to review thoroughly to ensure proper installation of this VTech innovative and feature rich product.

You can also visit our website at www.vtechphones.com for support, shopping, and everything new at VTech.

In Canada, please visit www.vtechcanada.com.

VTech toll free 1 (800) 595-9511. In Canada, dial 1 (800) 267-7377

Add new handsets to make your telephone more versatile (see page 63)

Your VTech i5871/i5873 telephone system can operate up to eight handsets. You can add new handsets (model number i5808, sold separately) at any time, but each must be registered with the base unit before use.

The handset provided with your telephone is automatically registered as Handset 1. Additional handsets will be assigned numbers in the order they are registered (2, 3, 4, 5, 6, 7 and 8). A maximum of eight handsets can be registered to each base unit.

To order additional handsets (model i5808), visit us on the web at www.vtechphones.com or call VTech Customer Service at 1 (800) 595-9511. In Canada, call 1 (800) 267-7377.

Table of contents

Installation

Parts checklist	3
Base unit installation	6
Install handset battery	7
Belt clip & headset	8
Dial mode	9
Caller ID information	9
If you subscribe to DSL service	10

Telephone settings

Handset layout	11
Base unit layout	12
Handset screen images	13
Handset sounds	14
Handset messages	16
Handset settings	18
Base settings	22

Basic operation

Make, answer and end calls	25
Options while on calls	26
Intercom call	27

Advanced operation

Phonebook	32
Store an entry in the phonebook	32
Chart of characters	33
Customize entries	34
Search the phonebook	34

Dial a phonebook entry	35
Edit a phonebook entry	35
Delete a phonebook entry	35
Call log	36
Review the call log	37
Dial a call log entry	37
Save an entry to the handset phonebook	38
Delete an entry	38
Redial list	39
Dial an entry from the redial list	39
Save a redial entry to the handset phonebook	40
Delete a redial entry	40

Answering system operation

About answering system operation	41
Setting answering system	42
Outgoing greeting	45
Message playback	47
Recording and playing memos	48
Remote access	49

Special features

Recordable ringer	50
Picture download	52
Phonebook tab functions	55

Appendix

Handset and base indicators	60
Add additional handsets	63

Table of contents

Charge spare battery pack	66
Batteries	67
Important safety instructions	68
Troubleshooting	69
Operating range	75
Maintenance	75
About cordless telephones	76
Warranty	76
FCC, ACTA and IC regulations	77
Technical specifications	80
Index	81

Installation

Parts checklist for i5871:

Remember to save your sales receipt and original packaging in case it is necessary to ship your telephone for warranty service. Check to make sure the telephone package includes the following:

1. Base unit
2. Handset
3. Base power adapter
4. Belt clip
5. Battery
6. VTech phonebook manager CD
7. USB cable
8. Audio patch cable
9. Telephone line cord
10. User's manual
11. Quick start guide
12. Special features guide

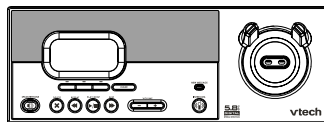

1. Base unit

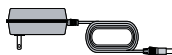

3. Base power adapter



4. Belt clip



2. Handset



5. Battery



6. VTech phonebook manager CD



7. USB cable



8. Audio patch cable



9. Telephone line cord



10. User's manual



11. Quick start guide



12. Special features guide

note

- To purchase replacement batteries, visit us on the web at www.vtechphones.com or call VTech Communications, Inc. at 1 (800) 595-9511 in the United States. In Canada, call 1 (800) 267-7377.

note

- To purchase replacement batteries, visit us on the web at www.vtechphones.com or call VTech Communications, Inc. at 1 (800) 595-9511 in the United States. In Canada, call 1 (800) 267-7377.

Installation Parts checklist for i5873:

Remember to save your sales receipt and original packaging in case it is necessary to ship your telephone for warranty service. Check to make sure the telephone package includes the following:

1. Base unit
2. Handsets (2)
3. Charger
4. Charger adapter
5. Belt clips (2)
6. Audio patch cable
7. Batteries (2)
8. VTech phonebook manager CD
9. Base power adapter
10. USB cable
11. Telephone line cord
12. User's manual
13. Quick start guide
14. Special features guide

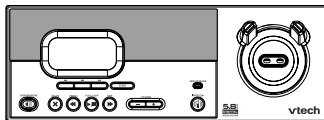

1. Base unit



2. Handsets (2)



3. Charger

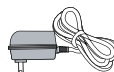

4. Charger adapter



5. Belt clips (2)



6. Audio patch cable



7. Batteries (2)



8. VTech phonebook manager CD



9. Base power adapter



10. USB cable



11. Telephone line cord



12. User's manual



13. Quick start guide



14. Special features guide

Installation

Parts checklist for i5808:

1. Handset
2. Charger
3. Charger adapter
4. Belt clip
5. Battery
6. Audio patch cable
7. USB cable
8. VTech phonebook manager CD
9. User's manual
10. Quick start guide
11. Special features guide



1. Handset



2. Charger

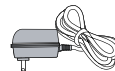

3. Charger adapter



4. Belt clip



5. Battery



6. Audio patch cable



7. USB cable



8. VTech phonebook manager CD

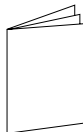

9. User's manual



10. Quick start guide



11. Special features guide

note

- To purchase replacement batteries, visit us on the web at www.vtechphones.com or call VTech Communications, Inc. at 1 (800) 595-9511) in the United States. In Canada, call 1 (800) 267-7377.

note

- Use only the VTech battery and AC power adaptor supplied with this telephone.
- If the handset will not be used for a long period of time, remove the battery to prevent possible leakage.

Installation

Base unit installation

Install the base unit and the charger as shown below. Choose a central location within the home, away from any electronic equipment and appliances such as personal computers, computer routers, television sets, microwave ovens, and refrigerators. Avoid excessive heat, cold, dust or moisture.

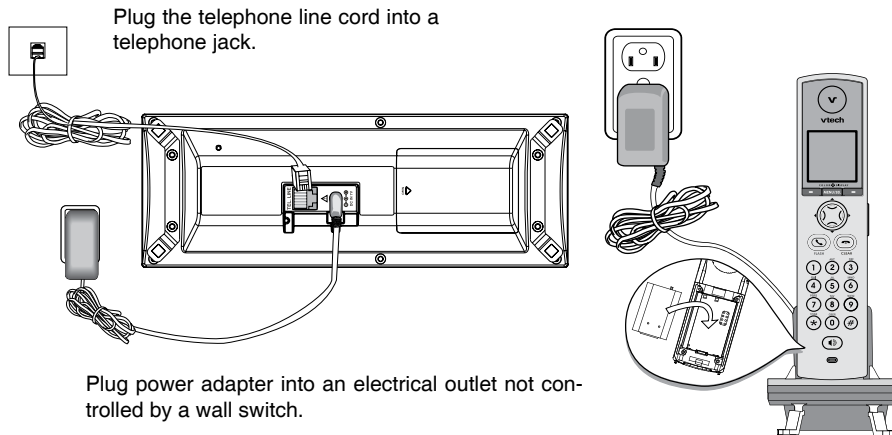

Installation

Install handset battery

- Press the tab and slide cover away from the battery compartment.
- Place the battery in the compartment with the metal contacts aligned, as shown in the diagram.
- Position the battery compartment cover and slide it towards the unit until it clicks into place.
- Put the handset in the base unit to start charging the new battery for at least 12 hours.

You can keep the battery charged by returning the handset to the base unit after each use. When the battery power is fully depleted, a full recharge takes about 12 hours.

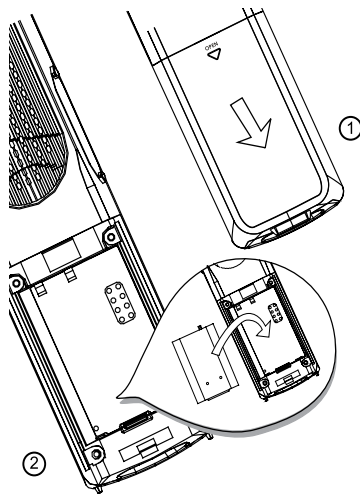

note

- Use only the VTech battery and AC power adapter supplied with this telephone.
- If the handset will not be used for a long period of time, remove the battery to prevent possible leakage.
- To purchase replacement batteries, visit us on the web at www.vtechphones.com or call VTech Communications, Inc. at 1 (800) 595-9511 in the United States. In Canada, call 1 (800) 267-7377.

note

- To purchase a headset, visit us on the web at www.vtechphones.com or call VTech Customer Service at 1 (800) 595-9511. In Canada, call 1 (800) 267-7377.
- Whenever a compatible headset is connected to the cordless handset, the microphone on the handset will be muted. This is done to limit the effect of background noise.

Installation

Belt clip & headset (optional)

Install belt clip and headset as shown below if desired.

For hands-free telephone conversations, use any industry standard 2.5 mm headset (purchased separately). For best result, use a VTech 2.5 mm headset.

Plug the 2.5 mm headset into the jack on the side of the handset (beneath the small rubber cap).

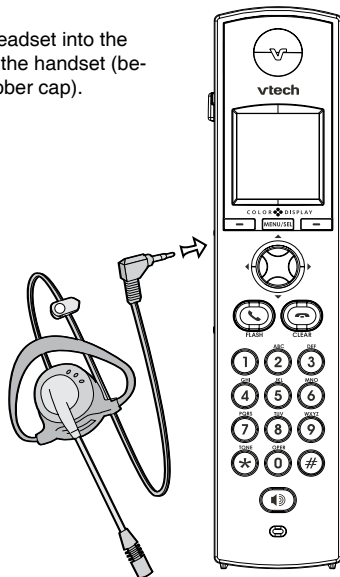

Belt clip

Align the pins on the inside edge of the clip with the notches on the sides of the handset.

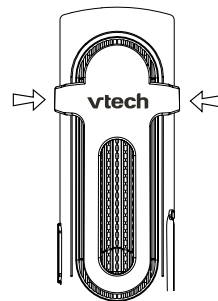

Installation

Dial mode

If you have touch-tone service, your telephone is ready to use as soon as the battery is charged. If you have pulse (rotary) service, the dial mode must be changed. Press /FLASH and there should be a dial tone. If not, refer to the **Set dial mode** section on page 20.

About caller ID information

The caller ID with call waiting features in this telephone let you see who is calling before answering the call, even when on another call. These features require services provided by your local telephone company.

Contact your telephone service provider if:

- you have both caller ID and call waiting, but as separate services (you may need combined service),
- you have only caller ID service, or only call waiting service, or
- you do not subscribe to any caller ID or call waiting services but wish to try them now.

You can use this telephone with regular caller ID service, and you can use its other features without subscribing to either caller ID or combined caller ID with call waiting service. There may be fees for these services, and these services may not be available in all areas.

The caller ID features will work only if both you and the caller are in areas offering caller ID service, and if both telephone companies use compatible equipment.

Installation

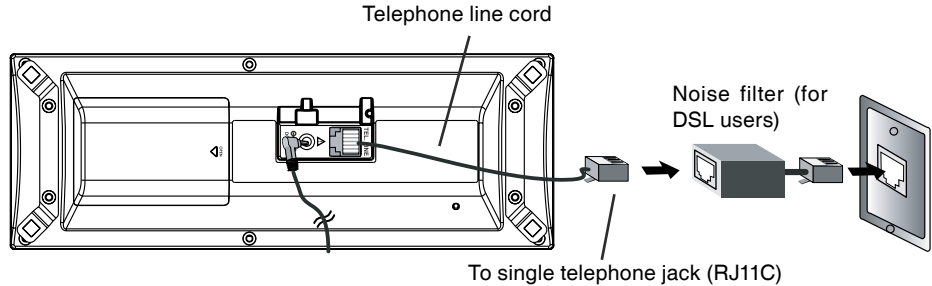

If you subscribe to DSL service

If there is interference during telephone conversations and/or your caller ID features are not functioning properly, install a noise filter to the telephone line between the base unit and the telephone wall jack. Contact your DSL provider for a noise filter.



Telephone settings

Handset layout

1. Earpiece
2. USB cable jack
3. Headset jack/audio patch cable jack (2.5mm)
4.  /FLASH
5. Dialing pad (0-9, *, #)
6. Speakerphone
7. LCD display
8. MENU/SEL
9. Softkeys
10. NavKeys (navigation keys)
11. Volume keys
12.  /CLEAR
13. Microphone

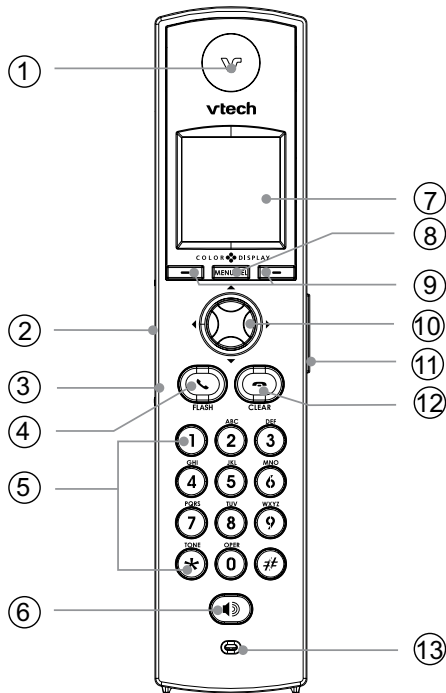

Telephone settings

Base unit layout

1. LCD display
2. Softkeys
3. SPEAKERPHONE
4. DELETE
5. REPEAT
6. PLAY/STOP
7. SKIP
8. CLEAR
9. VOLUME
10. INTERCOM
11. New message LED
12. Antenna
13. Charging LED
14. Speaker
15. Microphone
16. Telephone jack
17. DC connector jack
18. Spare battery compartment

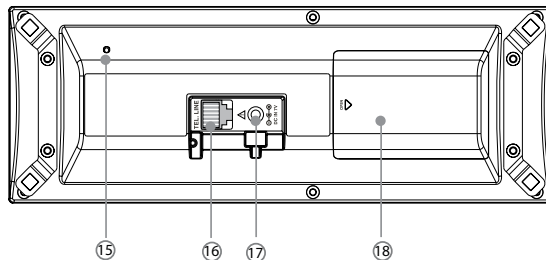
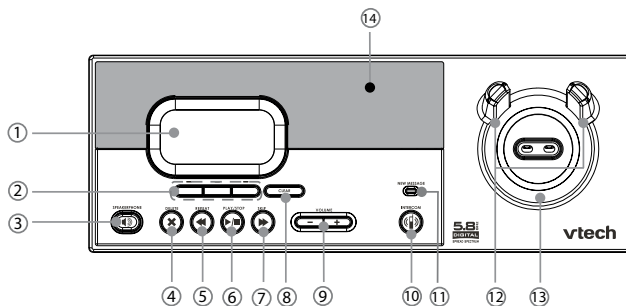

Telephone settings

Handset screen images

Screensaver

After 30 seconds of inactivity, the handset will go into screen saver mode and will display a digital clock. To illuminate the screen and read the clock, press any key on the dial pad.

Pictures & animations

The handset is preset with six animations and 23 pictures which can be used as the background for your idle screen (wallpaper), or a specific animation or picture can be assigned to a phonebook entry. You can also download your own pictures for use as a wallpaper or with the phonebook entry (see **Picture download** on page 52).

Set a wallpaper image

- Make sure the handset is in idle mode.
- Press **MENU/SEL** to display menu.
- Press the **UP** NavKey ▲ once to reach **Animations** or twice to reach **Pictures**, and press **MENU/SEL** to select.
- Use the **UP** or **DOWN** NavKey ▼ or ▲ to view the available animations or pictures.
- Press the softkey **SET** when finished setting the desired animation picture.
- The screen will display **Wallpaper set** and there will be a confirmation tone.

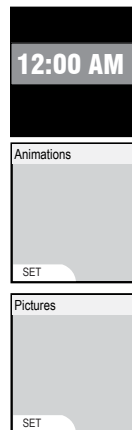

Telephone settings

Handset sounds

- Press **MENU/SEL** in idle mode to enter the main menu, and press the **UP** NavKey **▲** three times to reach the **Sound** menu. Use the **UP** or **DOWN** NavKey **▼** or **▲** to scroll through the menu, then press **MENU/SEL** to enter the desired menu, i.e. **Play Sound Clips**, **Record Sound Clip**, **Ringer Melody**, **Ringer Volume**, and **Ringer Vibrate**.

After selecting any option, press the softkey **SET** to confirm your choice. The screen will display **Choice saved** and there will be a confirmation tone.

Ringer melody

This feature allows you to assign various ringer melodies for incoming calls. You can choose from eight preset traditional ringers or 17 preset musical ringers or the ring tones you have recorded. There will be a sample of each ringer when you scroll through the choices.

- When in **Ringer Melody** menu, use the **UP** or **DOWN** NavKey **▼** or **▲** to scroll through the choices.
- The current selection is highlighted and there will be a sample of each ringer melody when scrolling through the choices.
- Press the softkey **SET** to confirm your setting. The screen displays **Choice saved** and there will be a confirmation tone.

Ringer volume

There are options for five levels of volume. There will be a sample of each ringer volume when scrolling through the choices.

- When in **Ringer Volume** menu, use the **LEFT** or **RIGHT** NavKey **◀** or **▶** to adjust the ringer volume. The current level is shaded in green and a sample of the ringer will be played.

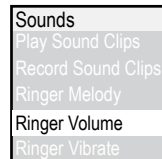
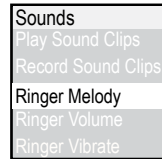
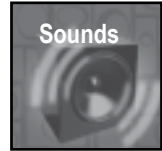

Telephone settings

Handset sounds

- Press the softkey **SET** to confirm your setting. The screen will display **Choice saved** and there will be a confirmation tone.

Ringer vibrate

This feature allows you to set the handset to vibrate when there is an incoming call.

- When in **Ringer Vibrate** menu, use the **UP** or **DOWN** NavKey ▼ or ▲ to choose **On** or **Off**. The current choice is highlighted.
- Press the softkey **SET** to confirm. The screen will display **Choice saved** and there will be a confirmation tone.

Sounds
Play Sound Clips
Record Sound Clips
Ringer Melody
Ringer Volume
Ringer Vibrate

Telephone settings

Handset messages

This feature allows you to listen to messages on the answering system using the handset.

When there are new messages on the answering system, **New Message** will be displayed on the handset screen, and the answering system icon will flash on the handset screen in idle mode.

- The day and time the message was recorded will be announced before playback.
- The screen on the handset will show the day and time the memo and incoming messages are recorded, the length of the message, and a diagram of the NavKey illustrating how to repeat or skip a message.
- If it is a memo recorded at the answering machine, the screen displays **Memo**.

Play the message

From screensaver mode (if there are new messages):

- Press **☎** /**CLEAR**, and the screen will display **New Message**. Press **MENU/SEL** and the screen displays the number of new and old messages.
- Press the softkey **PLAY** to play the message.

From idle mode (if there are new messages):

- Press the softkey **MESSAGE** to access the message menu. The screen displays the number of new and old messages.
- Press the softkey **PLAY** to play the message (s).

From the main menu:

- Press **MENU/SEL** when in idle mode.
- Press the **DOWN** NavKey ▼ twice to reach **Messages**. Press **MENU/SEL**



Telephone settings

Handset messages

to select.

- The screen displays number of new and old messages. Press the softkey **PLAY** to play the message.

Options during playback

- Press  / **VOLUME** to adjust the speaker volume.
- Press the softkey **STOP** to stop the message currently playing.
- Press the **LEFT** NavKey ◀ to skip to the next message.
- Press the **LEFT** NavKey ◀ to repeat the currently playing message.
- Press the **LEFT** NavKey ◀ twice (quickly) to go back to the previous message.
- Press the softkey **DELETE** to delete the message currently playing.

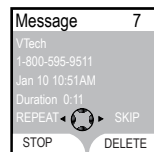

Delete all messages

- Press **MENU/SEL** when in idle mode.
- Press the **DOWN** NavKey ▼ twice to reach **Messages**. Press **MENU/SEL** to select.
- The screen displays the number of new and old messages. Press the softkey **DELETE** to delete all messages.
- The screen displays **Delete all Messages Are you sure?** Press the softkey **YES** to confirm. Press the softkey **NO** if you decide to keep the messages.



note

- When the telephone is ringing, press the softkey **SILENCE** to temporarily mute the ringer.

note

- The time is automatically set and updated with incoming caller ID information if you subscribe this service.

Telephone settings

Handset settings

Clock setting

- Make sure the handset is in idle mode.
- Press **MENU/SEL** to display menu.
- Press the **UP NavKey ▲** four times to reach **Settings**. Press **MENU/SEL** to select.
- Press **MENU/SEL** to select **Clock Setting**.
- Use the dial pad to enter the time digit by digit. Use the **LEFT** or **RIGHT NavKey ◀▶** to move to the digit you need to change.
- Use the **UP** or **DOWN NavKey ▼▲** to choose **AM** or **PM**.
- Press the softkey **SET** to confirm your selection. The screen will display **Choice saved** and there will be a confirmation tone.

Tone settings

In this menu, you can set keypad tone, low battery tone, and set the out of range tone on or off.

- Make sure the handset is in idle mode.
- Press the **UP NavKey ▲** four times to reach **Settings**. Press **MENU/SEL** to select.
- Press the **DOWN NavKey ▼** once to reach **Tone Settings** and press **MENU/SEL** to select.
- Use the **UP** and **DOWN NavKey ▼▲** to choose **Keypad Tone**, **Low Battery Tone**, or **Out of Range Tone**. Press **MENU/SEL** to select.
- Use the **UP** or **DOWN NavKey ▼▲** to choose **On** or **Off**.
- Press the softkey **SET** to confirm your selection. The screen will display **Choice saved** and there will be a confirmation tone.

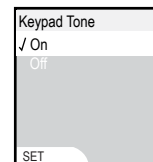
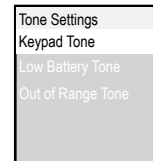
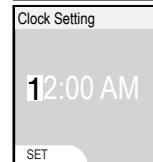
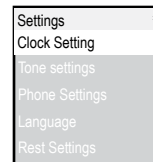

Telephone settings

Handset settings

Phone settings

In this menu, you can change the contrast setting, edit handset name, show handset name, and select dial type. To enter this menu:

- Make sure the handset is in idle mode.
- Press **MENU/SEL** to display menu.
- Press the **UP** NavKey **▲** four times to reach **Settings**. Press **MENU/SEL** to select.
- Press the **DOWN** NavKey **▼** twice to reach **Phone Settings** and press **MENU/SEL** to select.
- Use the **UP** or **DOWN** NavKey **▼** or **▲** to scroll through the setting to be changed. Press **MENU/SEL** to select the menu to enter.

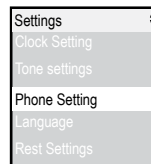

Set contrast

- When in the **Contrast** menu, use the **LEFT** or **RIGHT** NavKey **◀** or **▶** to adjust the level of contrast on the LCD screen.
- Press the softkey **SET** to confirm your setting. The screen will display **Choice saved**, and there will be a confirmation tone.

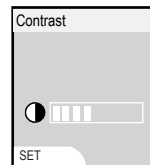

Edit handset name

- When in the **Edit Handset Name** menu, use the dial pad (see page 33) to enter the handset name.
- Press the softkey **BACK** to backspace and press the softkey **SET** to confirm the changes. The screen will display **Choice saved** and there will be a confirmation tone.



Telephone settings

Handset settings

Show handset name

- When in the **Show Handset Name** menu, use the **UP** or **DOWN** NavKey ▼ or ▲ to toggle between **On** or **Off**. The current selection is highlighted.
- Press the softkey **SET** to confirm your setting. The screen will display **Choice saved** and there will be a confirmation tone.

Set dial mode

The dial mode is preset to touch tone. If you would like to change the setting to pulse:

- When the **Dial Type** menu is displayed, use the **UP** or **DOWN** NavKey ▼ or ▲ to toggle between **Tone** or **Pulse**. The current selection is highlighted.
- Press the softkey **SET** to confirm your setting. The screen will display **Choice saved** and there will be a confirmation tone.

Language

At this menu, you can select the language used in all menus and screen displays. Choices are English, French and Spanish.

- Make sure the handset is in idle mode.
- Press **MENU/SEL** to display menu.
- Press the **UP** NavKey ▲ four times to reach **Settings**, then press **MENU/SEL** to select.
- Press the **UP** NavKey ▲ twice to reach **Language**. Press **MENU/SEL** to select.
- Use the **UP** or **DOWN** NavKey ▼ or ▲ to choose the language. The current choice is highlighted.

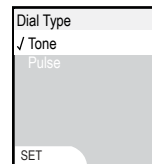
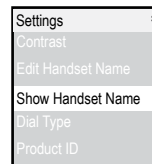

Telephone settings

Handset settings

- Press the softkey **SET** to confirm. The screen will display **Choice saved** and there will be a confirmation tone.

Reset settings

In this menu, you can clear current settings and restore the factory settings. You can clear the phonebook, call log, redial list, wallpaper, and registration. To enter this menu:

- Make sure the handset is in idle mode.
- Press **MENU/SEL** to display the menu.
- Press the **UP** NavKey ▲ four times to reach **Settings**, then press **MENU/SEL** to select.
- Press the **UP** NavKey ▲ once to reach **Reset Settings**. Press **MENU/SEL** to select.
- Use the **UP** or **DOWN** NavKey ▼ or ▲ to scroll through the settings to be changed. Press **MENU/SEL** to select the menu to enter.

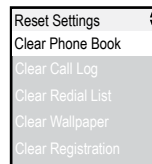

Reset settings

- When in the selected menu, use the softkey **YES** or **NO** to confirm your change.
- The screen will display **Phonebook cleared, Call Log cleared, Redial List cleared, Wallpaper cleared, Registration cleared, Default loaded**, in accordance with the setting you change. There will be a confirmation tone.

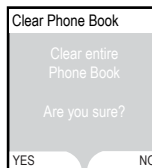

note

- The **Factory Settings** option will reset settings such as ringer volume and language to the factory defaults.

note

- The time is automatically set and updated with incoming caller ID information if you subscribe this service.

Telephone settings

Base settings

In this menu, you can change the setting of the clock, days of the week, ringer volume, ringer melody, keypad tone, contrast, dial type, and factory settings on the base unit. To enter this menu:

- Make sure the base unit is in idle mode.
- Press the softkey **MENU** to display the menu.
- Press the softkey **▼** once to reach the **BASE SETTINGS**, then press **SELECT** to select.
- Use the softkey **▼** or **▲** to scroll through the settings to be changed and press the softkey **SELECT** to select the menu to enter.

Clock setting

- When in the **CLOCK SETTING** menu, the current clock is displayed.
- Press the softkey **CHANGE** to change the digit and the AM/PM. Press the softkey **NEXT** to move to the next digit.
- Press the **SET** softkey when finished setting the time, and there will be a confirmation tone.

Weekday setting

- When in the **WEEKDAY SETTING** menu, the current weekday is displayed.
- Use the softkey **◀** or **▶** to change the weekday.
- Press the softkey **SET** when finished setting the weekday, and there will be a confirmation tone.



Telephone settings

Base settings

Ringer volume

There are options for five levels of volume. There will be a sample of each ringer volume when scrolling through the choices.

- When in the **RINGER VOLUME** menu, the current ringer volume is displayed by the shaded bar.
- Press the softkey ◀ or ▶ to change the ringer volume. A sample of that volume level will be played.
- Press the **SET** softkey when finished setting, and there will be a confirmation tone.

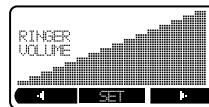

Ringer melody

There are options for five ringer melodies. There will be a sample of each ringer melody when scrolling through the choices.

- When in the **RINGER MELODY** menu, a sample of the current ringer melody is played.
- Press the softkey ◀ or ▶ to change the ringer melody. A sample of that ringer melody will be played.
- Press the **SET** softkey when finished setting, and there will be a confirmation tone.



Keypad tone

- When in the **KEYPAD TONE** menu, the current choice is highlighted.
- Press the softkey ▼ or ▲ to toggle between **ON** or **OFF**.
- Press the **SET** softkey when finished setting, and there will be a confirmation tone.



note

- When the telephone is ringing, pressing the softkey **QUIET** can mute the ringer temporarily.

Telephone settings

Base settings

Contrast

- When in the **CONTRAST** menu, the current contrast level is displayed by the shaded bar.
- Use the softkey ◀ or ▶ to adjust the contrast level.
- Press the **SET** softkey when finished setting, and there will be a confirmation tone.

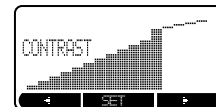

Dial type

The dial type is preset to touch tone.

- When in the **DIAL TYPE** menu, the current choice is highlighted.
- Use the softkey ▼ or ▲ to toggle between **TONE** or **PULSE**.
- Press the **SET** softkey when you are done setting, and there will be a confirmation tone.



Factory settings









You can choose to reset to factory settings in this menu. All the changes made will be cancelled and restored to the factory setting.

- When in the **FACTORY SETTINGS** menu, the screen displays **RESTORE FACTORY SETTINGS, ARE YOU SURE?**
- Use the softkey **YES** or **NO** to confirm your change, there will be a confirmation tone.



Basic operation

Make, answer, and end calls with the handset

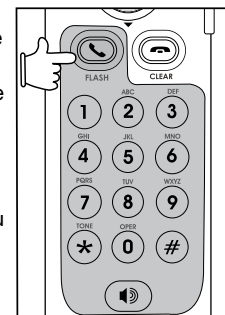
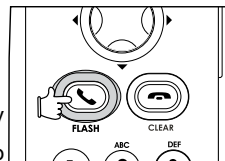

- Press  /FLASH or , then dial the number.
-OR-
- Dial the number (use the **LEFT** NavKey  to backspace; use the softkey **PAUSE** to insert a pause), then press  /FLASH or,  if you want to use speakerphone.
- To answer a call, press  /FLASH or,  if you want to use speakerphone.
- To end a call, press  /CLEAR, or put the handset back to the base unit.





Make, answer, and end calls at the base unit

You can make calls from the redial list and call log at the base unit, but you cannot dial a number directly.

From the redial list:

- Press the softkey **REDIAL** to display the redial list.
- Use the softkey  or  to scroll through the redial list to choose the number to be dialed.
- Press  to dial the number.

From the call log list:

- Press the softkey **MENU** to display the **MENU**.
- Press the softkey **SELECT** to select **CALL LOG**. Use the softkey  or  to scroll through the redial list to choose the number to be dialed.

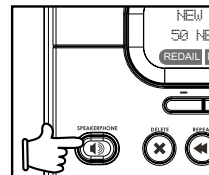

note

- The handset will display Call on Hold when a call is placed on hold. A  will flash and the base unit will ring as a reminder that a call is on hold.
- If a call remains on hold for one minute, the handset and the base unit will ring to remind you the call is on hold. The screen will display **Call on Hold Ringback!** You have 30 seconds to return to the call before it is disconnected.

Basic operation

Make, answer, and end calls at the base unit

- Press  /**SPEAKERPHONE** to dial the number.
- To answer a call, press  /**SPEAKERPHONE**.
- To end a call, press  /**SPEAKERPHONE**.



Options while on calls

There are a few options while on a call, including speakerphone on the handset, hold, mute, volume control, ringer silencing and call waiting on both the handset and the base unit.

Speakerphone on the handset

- During a call, press  to toggle between speakerphone and normal handset use.

Hold

- During a call, press the softkey **HOLD** on the handset or at the base unit to put a call on hold.
- To return to the call, press  /**FLASH** or  at the handset, or  /**SPEAKERPHONE** at the base unit.

Mute

Using the mute function allows you to mute the microphone and the other party cannot hear you, while you can still hear the other party.

- During a call, press the softkey **MUTE** on the handset or at the base unit to mute the microphone.

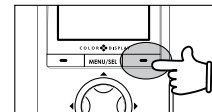
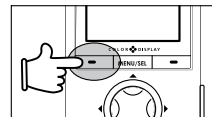
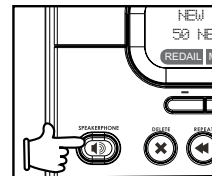

Basic operation

Options while on calls

- Press the softkey **UNMUTE** to return to normal conversation.

Volume control

- During a call, use the volume control on the right side of the handset, or the volume control on the base unit, to adjust the listening volume.
- Press **+** or **-** on the volume control key to adjust the volume to a comfortable level.

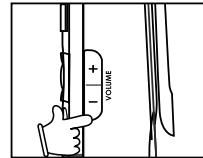
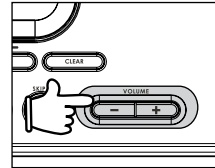

Ringer silencing

This feature allows you to silence the ringer temporarily when the telephone is ringing.

- Press the softkey **SILENCING** on the handset or the softkey **QUIET** on the base unit to temporarily silence the ringer.

Call waiting

If you subscribe to the call waiting service, press the softkey **FLASH** on the handset or at the base unit to answer the new incoming call.

Intercom call

The intercom feature allows a conversation between the handset and the base unit, or between handsets if additional handsets are registered for use with the system.

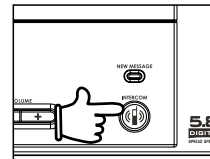

From base unit to all handsets

- Press **INTERCOM** at the base unit, and press the softkey **SELECT** to choose **GLOBAL PAGE**.
- All handsets will ring and the screen will display **Global Page from BASE**.

note

- You must have at least one additional handset to intercom call from one handset to another handset.

Basic operation

Intercom call

- Any handset can then answer the page, and enter intercom mode by pressing /FLASH, , or any keys on the dialing pad.
- To end an intercom call, press /CLEAR on the handset, or press **INTERCOM** at the base unit.

From the base unit to a specific handset

- Press **INTERCOM** at the base unit, and use the softkey ▼ or ▲ to scroll to the desired handset (e.g., HANDSET 2), and press the softkey **SELECT** to confirm.
- When the destination handset rings, press /FLASH, , or any keys on the dialing pad.
- To end an intercom call, press /CLEAR on the handset or **INTERCOM** at the base unit.



From one handset to all handsets and base unit:

- Press **MENU/SEL** to display menu when in idle mode.
- Press the **DOWN** NavKey ▼ three times to reach **Intercom** and press **MENU/SEL** to enter the menu.
- Press **MENU/SEL** and select **Global Page**.
- The base unit and all handsets will ring, and the screen displays **Global Page from Handset 1** (if the global page is from handset 1).
- To answer the page on any handset, press /FLASH, or any keys on the dialing pad. To answer the page at the base unit, press **INTERCOM** or /SPEAKERPHONE.





Basic operation

Intercom call



- To end an intercom call on any handsets, press  /CLEAR. To end it at the base unit, press **INTERCOM** or  /SPEAKERPHONE at the base unit.



From one handset to a specific handset or base unit

- Press **MENU/SEL** to display menu when in idle mode.
- Press the **DOWN** NavKey ▼ three times to reach **Intercom** and press **MENU/SEL** to enter the menu.
- Use the **UP** or **DOWN** NavKey ▼ or ▲ to scroll to the destination handset or base unit, and press **MENU/SEL** to confirm.
- The destination handset or base unit will ring, and the screen displays **INTERCOM from Handset 1** (if the page is from handset 1).
- To answer the page on any handset, press  /FLASH,  or any keys on the dialing pad. To answer the page at the base unit, press **INTERCOM** or  /SPEAKERPHONE.

Conference call

This feature allows you to have conference calls with up to three registered handsets and the base unit. To enter a conference call, simply access the line with up to three handsets and the base unit by pressing  /FLASH or  on the handset or at the base unit. The icon  will be displayed.



note

- You must have at least one additional handset to intercom a call from one handset to another handset.







Basic operation

Intercom call

Transfer an external call

This telephone allows you to transfer an external call from the base unit to any handset, from handset to handset, or from handset to the base unit.

From one handset to the base unit or to another handset



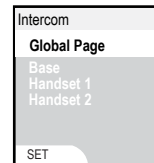

- During a call, press **HOLD** to put the call on hold on the originating handset.
- Press **MENU/SEL**, then use the **DOWN** NavKey ▼ to scroll to **Intercom**, and press **MENU/SEL** to confirm.
- Use the **UP** or **DOWN** NavKey ▼ or ▲ to scroll to the base unit, or destination handset. Press **MENU/SEL** to confirm.
- The destination handset or the base unit will ring, press /FLASH or  on the destination handset to answer, or press **INTERCOM** or /SPEAKERPHONE to answer at the base unit.
- Press /CLEAR on the originating handset to transfer the call.
- Press /FLASH on the destination handset or press /SPEAKERPHONE at the base unit to pick up the call on hold.



Basic operation





Intercom call

From the base unit to the handset

- During a call, press **HOLD** to put the call on hold.
- Press **INTERCOM**, and use the softkey ▼ or ▲ to scroll to the desired handset and press the softkey **SELECT** to confirm.
- When the target handset rings, press /FLASH or  on the handset to answer.
- Press **INTERCOM** on the base unit to transfer the call.
- Press /FLASH or press  on the destination handset to pick up the call on hold.



Answer an incoming call during an intercom call

- During an intercom call, there will be an alert tone which signals an incoming call.
- To terminate the intercom call without answering the incoming call, press /CLEAR on the handset, or press **INTERCOM** at the base unit. The base unit will ring and the incoming call can be answered normally.
- To connect the incoming call with the intercom call, press /FLASH or  on the handset, or press /SPEAKERPHONE at the base unit to answer the incoming call.

Advanced operation

Phonebook

The phonebook on the handset can store up to 100 entries, each consisting of entry up to 32 digits and 16 characters, along with a distinctive ring and picture for each entry.

- The phonebook menu can be assessed in idle mode by pressing the **UP** or **DOWN** NavKey ▼ or ▲ , or pressing **MENU/SEL** twice.
- Press **☎** /**CLEAR** to quit the menu without saving the change.
- **Phonebook is empty** is displayed on screen when there is no entry in the phonebook.
- When the phonebook is full and the softkey **NEW** is pressed, **Phonebook is full** will display and there will be an error tone.

Store an entry in the phonebook

- When in the **Phonebook** menu, press the softkey **NEW**.
- Use the dial pad (see the **Chart of character** on page 33 for instruction) to enter the name and telephone number for the entry, and press the softkey **SET** when done.
- Press the softkey **SAVE** if you do not wish to assign any distinctive ringer and picture to this entry (if you wish to assign distinctive ringer and picture, refer to **Customize entries** on page 34).

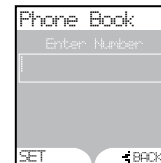

Advanced operation

Phonebook

Chart of characters

Use the dial pad and the chart below to enter a name (up to 16 characters). Each press of a particular key causes characters to be displayed in the following order:

Number Key	Characters by number of key presses								
	1	2	3	4	5	6	7	8	9
1	&	'	,	.	1	Space			
2	A	B	C	a	b	c	2		
3	D	E	F	d	e	f	3		
4	G	H	I	g	h	i	4		
5	J	K	L	j	k	l	5		
6	M	N	O	m	n	o	6		
7	P	Q	R	S	p	q	r	s	7
8	T	U	V	t	u	v	8		
9	W	X	Y	Z	w	x	y	z	9
0	0								
*	*								
#	#								

- When editing characters, press the softkey **BACK** to backspace. Press the **LEFT** or **RIGHT** NavKey ◀ or ▶ to move the cursor. Press the **RIGHT** NavKey ▶ again to add a space.
- Press and hold the # key to insert a dialing pause.

note

- There are eight traditional ring tones and 17 musical ringers. For **Recordable ringers**, see page 50.
- There are 29 preset pictures and animations to choose from. For **Picture download**, see page 52.

Advanced operation

Phonebook

Customize entries

This feature allows you to assign a distinctive ringer and picture/animation to a specific entry. The distinctive ringer and picture/animation will alert you when this person calls. You can customize the entries before saving it, either in the phonebook, call log list, or redial list.

- When in the screen display as shown on the top right, use the **UP** or **DOWN** NavKey ▼ or ▲ to highlight **Ringer: <Default>**, or **Picture: <Default>**.
- Use the **LEFT** or **RIGHT** NavKey ◀ or ▶ to choose the desired ringer, or picture/animation.
- When scrolling through the selection, a sample of the ringer will be played, and a sample of the picture/animation will be displayed.
- Press the softkey **SAVE** when done. The screen displays **Entry has been saved** and there will be a confirmation tone.

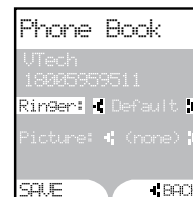

Search the phonebook

Entries are sorted alphabetically, and names beginning with numbers are presented first. An alphabetical search can be done after entering the phonebook.

For example, press 5 (JKL) once to find Jenny, twice to find Kristen, or three times to find Linda.



- When in the **Phonebook** menu, press the softkey **FIND**.
- Use the dial pad to enter the alphabet and press the softkey **SET** to confirm.



Advanced operation

Phonebook

Dial a phonebook entry

- When in the **Phonebook** menu, use the **UP** or **DOWN** NavKey ▼ or ▲ to scroll to the desired entry, or use the softkey **FIND** to search for it.
- Press /FLASH or press  to dial the entry.

Edit a phonebook entry

- When in the **Phonebook** menu, use the **UP** or **DOWN** NavKey ▼ or ▲ to scroll to the entry to be edited, or use the softkey **FIND** to search the entry. Press **MENU/SEL** to select the entry.
- Press the softkey **EDIT** and use the **UP** or **DOWN** NavKey ▼ or ▲ to highlight the item (name, number, distinctive ringer, distinctive picture/animation) to be edited.
- Use the dial pad and the softkey **BACK** to edit the name and number, and use the **LEFT** or **RIGHT** NavKey ◀ or ▶ to choose the desired ringer and picture/animation.
- Press the softkey **SAVE** to save the changes. The screen displays **Entry has been saved** and there will be a confirmation tone.

Delete a phonebook entry

- When in the **Phonebook** menu, use the **UP** or **DOWN** NavKey ▼ or ▲ to scroll to the entry to be deleted, or use the softkey **FIND** to search for it. Press **MENU/SEL** to select the entry.
- Press the softkey **DELETE**, and there will be a confirmation tone.

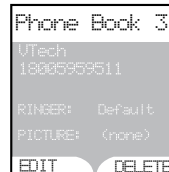
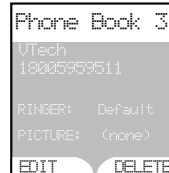

note

- Due to regional service difference, the CID information may not be available for every incoming call. In addition, the caller may intentionally block their name and/or telephone number.

Advanced operation

Call log

If you subscribe to the caller ID service, information about each caller will be displayed after the first or second ring.

- The handset call log can store up to 100 entries, and the call log in the base unit can store up to 50 entries.
- You can review, redial, and copy the entry into your phonebook.
- Entries are displayed in reverse chronological order, i.e. from the latest entry to the earliest entry.
- When the call log is full, the earliest entry is deleted to make room for new incoming call information.
- **New Call** will be displayed on both the handset and the base unit if there are new call log entries, i.e. missed call (including missed call waiting record) and unreviewed calls.
- You can also listen to messages (if the callers left messages) when reviewing the call log.

The call log can be accessed on the handset by pressing the softkey **CALL LOG**, or pressing **MENU/SEL** and **DOWN** NavKey ▼ once, and then press **MENU/SEL** again. You can also access the call log at the base unit by:

- pressing the softkey **MENU** to enter the menu, then
- pressing the softkey **SELECT** to select **CALL LOG**.

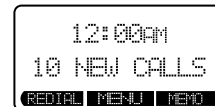

Advanced operation





Call log

Review the call log



- When in the call log, use the **UP** or **DOWN** NavKey ▼ or ▲ to scroll through the call log on the handset. Use the softkey ▼ or ▲ to scroll through the call log on the base unit.
- The name, number, date and time of receiving call, and message (if the caller left a message) are displayed on the screen.
- Press the **RIGHT** NavKey ► to play the message on the handset. Press the softkey **SELECT** on the base unit twice to play the message at the base unit.

Dial a call log entry

On the handset:

- When in the call log, use the **UP** or **DOWN** NavKey ▼ or ▲ to scroll to the desired entry. Press  /FLASH or  to dial the number.
- Press # or **MENU/SEL** to display the possible dialing options.
- Use the **UP** or **DOWN** NavKey ▼ or ▲ to scroll through the choices, and press the softkey **DIAL** or  /FLASH or  to dial the number.

At the base unit:

- When in the call log, use the softkey ▼ or ▲ to scroll to the desired entry. Press  /SPEAKERPHONE to dial the entry.
- To see the dial options, press the softkey **SELECT**, use the softkey ▼ or ▲ to scroll to **DIAL OPTIONS** and press **SELECT**.
- Use the softkey ▼ or ▲ to scroll through the choice, and press the softkey **DIAL** or  /SPEAKERPHONE to dial.



note

- While reviewing the call log, press # repeatedly to display the alternate dialing options. The available options are: (1 + area code + number, area code + number, 1 + number, number only).

note

- The time is automatically set and updated with incoming caller ID information if you subscribe to this service.
- If you have more than one handset, setting the date and time on one handset will automatically update all other handsets.

Advanced operation

Call log

Save an entry to the handset phonebook

- When in the call log, use the **UP** or **DOWN** NavKey ▼ or ▲ to scroll through the call log and highlight the entry to be saved. Press the softkey **SAVE** to save the entry to the phonebook.
- Use the dial pad to enter the name, and press the softkey **SET** when done.
- If you do not wish to customize the entry, press the softkey **SAVE** to confirm. The screen displays **Entry has been saved** and there will be a confirmation tone.
- If you wish to customize the entry, see the section **Customize entries** on page 34.

Delete an entry

From the handset:

- When in the call log, press the **UP** or **DOWN** NavKey ▼ or ▲ to scroll to the entry to be deleted. Press the softkey **DELETE** to confirm, and there will be a confirmation tone.

From the base unit:

- When in the call log, use the softkey ▼ or ▲ to scroll to the entry to be deleted. Press the softkey **SELECT** to select.
- Use the softkey ▼ or ▲ to scroll to **DELETE CALL LOG**, and press the softkey **SELECT** to confirm.
- Press the softkey **THIS** if only deleting this entry. Press the softkey **ALL** if deleting all entries. Press the softkey **YES** to confirm, and there will be a confirmation tone.

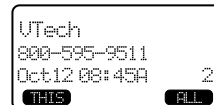

Advanced operation

Redial list

The handset and the base unit can store the ten most recently dialed numbers in the redial list. You can review, redial, or save the number into the phonebook.

- When there are already ten entries on the redial list, the earliest entry is deleted to make room for the new entry.
- Entries are displayed in reverse chronological order, i.e. from the latest entry to the earliest entry.
- **Redial list is empty** is displayed on screen if there is no dialed number on the list.

The redial list can be accessed on the handset and the base unit by pressing the softkey **REDIAL** in idle mode.

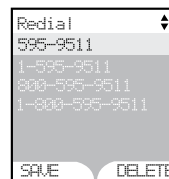

Dial an entry from the redial list

From the handset:

- When in the redial list, use the **UP** or **DOWN** NavKey ▼ or ▲ to scroll to the desired number.
- Press /FLASH or to dial.
- To add a pause to the number, press **MENU/SEL** to select the number, and press the softkey **PAUSE** before dialing.

From the base unit:

- When in the redial list, use the softkey ▼ or ▲ to scroll to the desired number.
- Press /SPEAKERPHONE to dial.



Advanced operation

Redial list

Save a redial entry to the phonebook on the handset

- When in the redial list, press the **UP** or **DOWN** NavKey ▼ or ▲ to scroll to the number to be saved.
- Press the softkey **SAVE**.
- Use the dial pad to enter the name for the entry. Press the softkey **SET** when finished.
- If you do not wish to assign a distinctive ringer and picture/animation to the entry, press the softkey **SAVE** to confirm. The screen displays **Entry has been saved** and there will be a confirmation tone.
- If you wish to assign a distinctive ringer and picture/animation to the entry, see the section **Customize entries** on page 34.

Delete a redial entry

From the handset:

- When in the redial list, use the **UP** or **DOWN** NavKey ▼ or ▲ to scroll to the number to be deleted.
- Press the softkey **DELETE**, and there will be a confirmation tone.

From the base unit:

- When in the redial list, use the softkey ▼ or ▲ to scroll to the number to be deleted. Press the softkey **SELECT** to select.
- Press the softkey **DELETE** to confirm, and there will be a confirmation tone.



Answering system operation

Message capacity

The answering system can record up to 99 messages, depending on the length of each message. Individual messages can be up to 4 minutes in length, but the total maximum recording time is 15 minutes. Message will remain available for replay until they are deleted.

Handset access

In addition to the features described in this section, the handset can also be used to review or delete messages (see **Handset messages** section on page 16).

Shows there are new messages on the answering system.

Press to delete current message playing. When idle, press to bring up menu to delete all messages (see page 47).

Press to repeat a message or press twice to play back previous messages (see page 47).

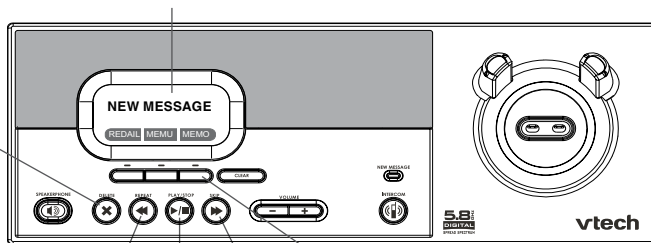

Press to play or stop playing messages (see page 47).

Press to skip to next message (see page 47).

Press to record a memo on the answering system (see page 48).

note

- When in GREETING ONLY mode, **REC OFF** will display on the base unit screen.

Answering system operation

Setting answering system

Activate the answering system

The answering system must be turned on to function. If the answering system is turned off, the base unit displays **ANS. OFF** on the screen.

To turn on/off the answering system:

- Press the softkey **MENU** in idle mode.
- Press the softkey **▼** twice to reach **ANSWERING SYSTEM**. Press the softkey **SELECT** to confirm.
- Press the softkey **SELECT** to select **ANSWER OPTIONS**.
- Use the softkey **▼** or **▲** to scroll between **ON** and **OFF**. The current setting is highlighted. Press the softkey **SELECT** to confirm, and there will be a confirmation tone.

Set record options

This feature allows you to set the answering system to announce the greeting only, or allow the callers to leave messages.

- Press the softkey **MENU** in idle mode.
- Press the softkey **▼** twice to reach **ANSWERING SYSTEM**. Press the softkey **SELECT** to confirm.
- Press the softkey **▼** twice to reach **RECORD OPTIONS** and press **SELECT** to select.
- Use the softkey **▼** or **▲** to toggle between **RECORD MESSAGE** and **GREETING ONLY**. The current setting is highlighted. Press the softkey **SELECT** to confirm, and there will be a confirmation tone.

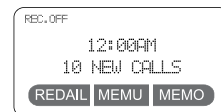

Answering system operation

Setting answering system

Set number of rings

This feature allows you to select how many times the telephone will ring before the answering system answers. You can choose from two, four, six rings or toll saver. With toll saver active, the answering system answers after two rings when there are new messages, and after four rings when there are no new messages.

- Press the softkey **MENU** in idle mode.
- Press the softkey **▼** twice to reach **ANSWERING SYSTEM**. Press the softkey **SELECT** to confirm.
- Press the softkey **▼** three times to reach **RINGS TO ANSWER**, and press the softkey **SELECT** to confirm.
- Use the softkey **◀** or **▶** to scroll through the options. Press the softkey **SELECT** to confirm, and there will be a confirmation tone.



Set call screening

This feature allows you to listen to the caller's messages while they are being recorded. If you wish to take the call, press **FLASH** or **☎** on the handset or **☎**/**SPEAKERPHONE** at the base unit when the message is being recorded.

- Press the softkey **MENU** when in idle mode.
- Press the softkey **▼** twice to reach **ANSWERING SYSTEM**. Press the softkey **SELECT** to confirm.
- Press the softkey **▲** three times to reach **CALL SCREENING** and press the softkey **SELECT** to confirm.



Answering system operation

Setting answering system

- Use the softkey ▼ or ▲ to toggle between **ON** and **OFF**. Press the softkey **SET** to confirm, and there will be a confirmation tone.

Set new message tone

This feature programs the system to beep every 10 seconds to alert you of new messages. The beep will stop when all new messages have been reviewed.

- Press the softkey **MENU** when in idle mode.
- Press the softkey ▼ twice to reach **ANSWERING SYSTEM**. Press the softkey **SELECT** to confirm.
- Press the softkey ▲ once to reach **NEW MESSAGE TONE**, and press the softkey **SELECT** to confirm.
- Use the softkey ▼ or ▲ to toggle between **ON** and **OFF**. Press the softkey **SET** to confirm, and there will be a confirmation tone.



Set security code

A four-digit security code is required to access the answering system from any touch tone telephone. The factory default code is 4321.

- Press the softkey **MENU** in idle mode.
- Press the softkey ▼ twice to reach **ANSWERING SYSTEM**. Press the softkey **SELECT** to confirm.
- Press the softkey ▲ twice to reach **SECURITY CODE**, and press the softkey **SELECT** to confirm.
- Press the softkey **CHANGE** to change the digit. Press the softkey **NEXT** to move the cursor to the next digit.
- Press the softkey **SET** when finished, and there will be a confirmation tone.



Answering system operation

Outgoing greeting

Outgoing greeting is the message callers hear when calls are answered by the answering system.

The telephone is preset with a greeting that answers calls with “*Hello. I'm unable to answer your call right now. Please leave you name, number and the message after the tone.*” You can use this factory greeting, or replace it with your own recording.

Record your greeting

- Press the softkey **MENU** when in idle mode.
- Press the softkey ▼ twice to reach **ANSWERING SYSTEM**. Press the softkey **SELECT** to confirm.
- Press the softkey ▼ once to reach **GREETING OPTION**, and press the softkey **SELECT** to confirm.
- Press the softkey ▼ once to reach **RECORD GREETING**, and press the softkey **SELECT** to confirm.
- The screen displays **RECORDING GREETING FOR RECORD MESSAGE MODE**. After the tone, speak towards the microphone at the bottom front of the base unit from about nine inches away.
- Press the softkey **STOP** when finished.
- The answering system will automatically playback the newly recorded greeting. Press the softkey **STOP** to stop the playback anytime.

Play your greeting

- Follow the instructions in **Record your greeting** to access the **GREETING OPTION** menu.
- Press the softkey **SELECT** to select **PLAY OPTION**. Press the softkey **STOP** to stop the playback anytime.

note

- Your greeting can be up to 4 minutes in length.



note

- When factory greeting is restored, the greeting recorded by you will be deleted.

Answering system operation

Outgoing greeting

Restore to factory greeting

- Follow the instruction in the section **Record your greeting** on page 45 to access the **GREETING OPTION** menu.
- Press the softkey **▲** once to reach **FACTORY SETTING**, and press the softkey **SELECT** to confirm.
- The screen displays **RESTORE FACTORY GREETING, ARE YOU SURE?**
- Press the softkey **YES** to confirm, and there will be a confirmation tone. Press the softkey **NO** if you decide not to restore the factory greeting.



RESTORE FACTORY
GREETING
ARE YOU SURE?
YES NO

Answering system operation

Message playback

New message indication

- The base unit screen displays **NEW MESSAGE**.
- The **NEW MESSAGE** indicator light on the base unit flashes.
- If the new message alert tone is turned on, the base unit will beep every ten seconds when there are unreviewed messages.

Before playback begins, the total number of messages will be announced, allow with the day and time when the message was received.

Message playback on the base unit

- Press ►/■ /**PLAY/STOP** to play the message.
- Press ►/■ /**PLAY/STOP** to stop the playback.

Options during playback

- Press  /**VOLUME** to adjust the speaker volume.
- Press ► /**SKIP** to skip to the next message.
- Press ◀ /**REPEAT** to repeat the message currently playing. Press twice to listen to the previous message.
- Press the softkey **PAUSE** to pause the playback, and press the softkey **PLAY** to resume playback.
- Press ✕ /**DELETE** to delete the current message. The system will advance to the next message.

Delete all messages

- Press ✕ /**DELETE** when in idle mode.
- Press the softkey **YES** to confirm, and there will be a confirmation tone. Press the softkey **NO** if you decide not to delete any messages.



note

- When the answering system is done playing back messages, it will briefly display **END OF MESSAGES**.

note

- Your memo can be up to 4 minutes in length.

Answering system operation

Recording and playing memos

Memos are your own recorded messages used as a reminder for yourself or for others in the household using the same answering system. They are saved, played back and deleted exactly the same way as incoming messages.

Record a memo

- Press the softkey **MEMO** at the base unit. The screen displays **RECORD MEMO AFTER TONE**. After the tone, speak towards the microphone at the bottom front of the base unit from about nine inches away.
- Press the softkey **STOP** when you have finished recording.



Memo playback

- Press **▶/■/PLAY/STOP** to play the memo.
- See the section **Options during playback** on page 47 for other options.

Answering system operation

Remote access

You can access many features of your answering system remotely from any touch tone telephone. A four-digit security code is required to access the system and the factory default code is 4321; see page 44 to change it. To access remote access:

- Dial your telephone number from any touch tone telephone.
- When the system answers and announces the greeting, enter the four-digit security code.
- After hearing a double beep, enter one of the remote commands in the following table.
- Hang up or press * to end the call.

Commands in remote standby mode:

Hang up	Saves all messages
1	Plays all messages
2	Plays new messages only
5	Plays help menu
7	Reviews the greeting
8	Records the greeting
9	Turns greeting only on or off
0	Turns answering system on or off

Commands during playback mode:

3	Deletes the message currently playing and announces "Message deleted"
4	Repeats the message currently playing
4 (twice quickly)	Plays the previous message
6	Skips to the next message
#	Stops playing or recording

note

- If no key is pressed within 10 seconds of entering remote access, any new messages will be played automatically.
- Once the new messages have been played, the system will announce the help menu options. If no key is pressed within 20 seconds, the remote access call is automatically disconnected.

note

- The handset can store a maximum of 50 sound clips, and the maximum recording time per sound clip is 15 seconds.
- The handset is preset with 17 musical ringer options as your default ringer or a distinctive ringer. Four of the ringers are protected and cannot be deleted. You can replace the other ringers with your own recordings.
- If the memory is full, the handset will show **Sound Clip memory full**.

Special features

Recordable ringer

You can record a unique ringer as either your default ringer or as a distinctive ringer assigned to a specific phonebook entry. You can record with either the provided audio patch cord (not the USB cord), or with the handset microphone.

Cued-up music typically produces the best sounding recorded ringer. It is recommended to begin recording your ringer at the beginning of a song for optimal audibility rather than clipping a portion from the middle.

Record a sound clip by using the audio patch cord

- Insert the 3.5mm plug (the larger end) into the headset jack of your PC or audio source. Then insert the 2.5mm plug (the smaller end) into the headset jack on the side of the handset.
- Press **MENU/SEL** when in idle mode.
- Press the **UP NavKey ▲** three times to reach **Sounds**, and press **MENU/SEL** to select.
- Press the **DOWN NavKey ▼** once to reach **Record Sound Clips**, and press **MENU/SEL** to select.
- Press the **DOWN NavKey ▼** once to reach **Using Audio Cable**, and press **MENU/SEL** to select.
- Listen to the music through your handset speaker. Adjust the recording volume at the audio source to the desired volume level.
- Press the softkey **RECORD** to start recording, and press the softkey **STOP** when finished.
- Press the softkey **STOP** when finished.
- Press the softkey **PLAY** to play the sound clip recorded. Press the softkey **STOP** to stop playing anytime.
- Press the softkey **SAVE** if you want to save this sound clip.
- Use the dial pad to enter the **Sound Clip Name**.

Special features

- Press the softkey **SET** when finished. The screen displays **Sound Clip saved**, and there will be a confirmation tone.

Record a sound clip by using the microphone

- Press **MENU/SEL** when in idle mode.
- Press the **UP** NavKey ▲ three times to reach **Sounds**, and press **MENU/SEL** to select.
- Press the **DOWN** NavKey ▼ once to reach **Record Sound Clips**, and press **MENU/SEL** to select.
- Press **MENU/SEL** to select **Using Microphone**, and the screen displays **Record after tone**.
- Position your audio source facing the handset microphone and the handset will start recording after the beep.
- Press the softkey **STOP** when finished.
- Press the softkey **PLAY** to listen to the sound clip you just recorded. Press the softkey **STOP** to stop playing anytime.
- Press the softkey **SAVE** to save this sound clip.
- Use the dial pad to enter the **Sound Clip Name** (up to ten characters).
- Press the softkey **SET** when finished. The screen displays **Sound Clip saved**, and there will be a confirmation tone.

note

- When you want to use the microphone on the handset to record ringers, do not insert the audio patch cord into the headset jack.



Special features

Picture download

Getting started

The VTech Phonebook Manager allows you to download pictures and edit your handset phonebook from your PC. It also allows you to import and export contacts to and from comma separated text files. This feature allows you to get contacts from your existing PC applications such as Microsoft Outlook® or Palm® programs.

One-time software installation

- Insert the enclosed VTech Phonebook Manager CD into your personal computer.
- An installation window will open on the monitor giving you three options:
 1. Install/Uninstall the Phonebook Manager software.
 2. Browse the Installation CD.
 3. Visit VTech on the web.
- To install the software, click on the **Install/Uninstall the VTech Phonebook Manager** icon  and follow the instructions for downloading.
- After the installation is complete, you will find a VTech Phonebook Manager icon  on your PC desktop.

Graphics tab functions

The VTech Phonebook Manager allows you to open graphic files on your PC and transfer them to your telephone. Once the graphics are transferred, they can be used for your wallpaper image or to be assigned to a particular phonebook entry, quickly alerting you to your caller's identification.

With the phonebook manager, you can also modify the graphic prior to sending it to the handset. Common graphic editing functions such as zoom, rotate, brightness/contrast adjustment and red/green color balance adjustments can be adjusted from the VTech phonebook manager.

Special features

Picture download



Open a graphic file

- Open the phonebook manager by double-clicking on the desktop icon: 
- Click on the Graphics tab.
- Click on the **OPEN IMAGE** button.
- A window will open for you to browse through the graphic file on your computer.
- Find the folder containing your graphic file and double-click to open it.

Picture download

Once a graphic file is opened, it can be transferred from your PC to your handset. There are many images in the phonebook manager software for downloading into your handset, or you can transfer your own pictures onto the handset. The phonebook manager supports the following graphic formats: GIF, JPEG, BMP, TIFF and PNG.

To transfer images from the software to the handset:

- Connect one end of the enclosed USB cable to the handset and the other end to your PC.
- If you have the phonebook manager program open, you should see from the status bar in the bottom right corner update that the PC has detected the telephone. You are now ready to transfer a graphic to the telephone. 
- Following the steps in **Open a Graphic File**.
- Once you have opened the desired image, click on the **Transfer to Handset button**. 
- The graphic transfer will now begin and complete in approximately four seconds.
- When the graphic transfer is complete, follow the instructions given on the handset display to save the graphic to your telephone.

note

- None of the graphic editing functions will alter the actual graphic file – they will only modify how the graphic will look once it has been downloaded to the handset.

Special features

Picture download

Graphic editing

The VTech Phonebook Manager allows you to perform basic graphic editing functions such as zoom, rotate, brightness/contrast and color balance. When using these tools to edit your pictures, you can see them on the preview panel on the left side of the phonebook manager application.

While in graphic edit mode, there is a red preview box over the center of the main graphic panel. This preview box contains the image shown in the preview panel on the left side of the application. You can move the preview box by:

1. Move the mouse pointer inside the red preview box.
2. Press and hold the left mouse button.
3. Use the mouse to move the red preview box to a new location on the graphic.
4. Once the preview box is on the desired graphic, release the mouse button.

Special features



Phonebook tab functions

The VTech Phonebook Manager can be used to create, modify and backup phonebook files from your handset. The phonebook manager has many useful functions:

- Export existing contacts from any contact manager (such as Microsoft Outlook®, Palm®, etc.) to a comma separated text file. Import those contacts into the phonebook manager and transfer the entire phonebook to your handset.
- Transfer the phonebook from your handset to your PC and save it to disk. Connect a different handset and transfer the phonebook from your PC to the new handset. This allows you to store a copy of the phonebook on your PC and transfer it to different handsets.
- Use the phonebook manager to backup your handset phonebook onto your PC. If you need to restore the phonebook on your handset, there is already a copy stored on your PC.
- Use the phonebook manager to create a phonebook offline on your PC. When finished editing, connect your handset and transfer it from the PC to your handset.

Creating an empty phonebook

To create an empty phonebook to input data:

- Double-click on the VTech Phonebook Manager icon on your PC.
 - Click on the Phonebook tab.
 - Select the **CREATE PHONEBOOK**  button.
 - Using the Phonebook Manager application, make any necessary changes to the phonebook. You can add entries or import contacts from other PC applications such as Microsoft Outlook® or Palm®.
 - When finished editing the phonebook, you must either save the data to your hard drive or transfer it to your handset:
 - Select the **SAVE PHONEBOOK**  button to save the data to your PC's hard drive.
- OR-

note

- The phonebook manager application does not perform any synchronization of the phonebook between the PC and the handset. When the **Transfer to Handset** button is pressed, the entire phonebook is transferred to the handset replacing the existing phonebook on the handset.
- This operation will replace the phonebook on your handset with the new one currently transferred from the phonebook manager.



Special features

Phonebook tab functions

- Click on Transfer

Edit a phonebook

You can either open an existing phonebook stored in your PC's hard drive by pressing the **OPEN PHONEBOOK**  button using the phonebook manager software, or by transferring the phonebook from your handset to the phonebook manager software using the supplied USB cable. To accomplish this:



- Connect your handset to your PC using the USB cable.
- Start the phonebook manager application on your PC.
- Verify the connection by ensuring the green icon on the status bar. (If it is not, re-connect the handset to the PC with the USB cable.)
- Press the **Phonebook** tab.
- Press the **Transfer**  button.
- Using the phonebook manager software, edit the phonebook entries. At this time you can also add new entries or import contacts from other programs such as Microsoft Outlook® or Palm®, etc.
- When finished editing the phonebook, save it to your PC's hard drive by pressing the **SAVE PHONEBOOK**  button. To transfer the newly edited phonebook to your handset, use the transfer phonebook  button.

Special features

Phonebook tab functions

Import contacts into phonebook manager from other PC applications

Use this feature to import contacts from a comma separated text file into the VTech phonebook manager software. The contacts will be merged into the currently loaded phonebook.

1. Create a comma separated text file containing the contacts for importing into your handset. This is accomplished by using the export function from your other contact management application (such as Microsoft Outlook®, Outlook Express® or Palm® applications). The export function in these programs is normally located under the file menu. Be sure to specify the export file as a text file or comma separated file (CSV). An example of exporting contacts from Microsoft Outlook® is as follows:
 - a. Start Microsoft Outlook® on your PC.
 - b. Select **import/export** from the file menu.
 - c. Select **export** to file and press **next**.
 - d. Select a file type of comma separated values (in Windows).
 - e. Select the folder containing the contacts for export.
 - f. Once a contact folder has been selected, press **next**.
 - g. Enter a file name to save as a contact. This will be the file importing into the phonebook manager program. Be sure to make note of where on your PC you save the file for later reference.
2. Start the VTech phonebook manager program on your PC. Load the newly created phonebook into the phonebook manager software using these steps:
 - Press the Transfer  button.
 - Press the **CREATE PHONEBOOK**  button to create an empty phonebook.
 - Press the **OPEN PHONEBOOK**  button to load the previously saved phonebook from your PC's hard drive.

note

- For first time users, try the import operation on an empty phonebook until you have mastered the process.

Special features

Phonebook tab functions

- Press the **Import/Export**  button.
- Select **Import Contacts** and press the **next** button.
- Use the browse button to locate the comma separated text file saved in step one. Press **next**.
- The next screen displays how the fields from the comma separated text file will be mapped to the handset phonebook entries. There are two fields in the VTech phonebook: name and number. However, most PC contact managers separate names into the first and last name fields. To allow import of this type of file, the mapping dialog allows you to decide how the name fields from your import file will be placed in the VTech phonebook name field. For example, the following mappings will import the field's first name and last name into the VTech name field. The home phone field will be imported into the VTech phone number field.

If the mapping displayed is not what is desired, select one of the rows and press the **Change Map** button to correct it. You can only use each of the three fields (VTech name first, VTech name last and VTech phone number) once. If you want to change one that has already been mapped, you must first select that row and use the **Change Map** button to remove the association.

- When finished editing the mapping, press the **Finish** button. The contacts will now be imported and merged into the currently loaded phonebook.

Exporting contacts to a comma separated text file

This feature allows you to export some or all of your VTech phonebook entries into a comma separated text file. This comma separated text file can then be imported into a contact manager software such as Microsoft Outlook® or Palm® applications.

- Load a phonebook into the phonebook manager.
- If you wish to export only some of your contacts, select the desired contacts on the list of contacts loaded. You can use your mouse to select to a single row or hold down the CTRL key while using your mouse to click on the rows to be selected.
- Press the **Import/Export**  button.

Special features

Phonebook tab functions

- Select **Export Contacts** and press the **next** button.
- Select whether you want to **Export All Contacts** or **Selected Contacts**.
- Enter the name of the file to be exported to. You can use the **browse** button to locate the folder and enter a file name.
- Press the **Finish** button to complete the export operation.

Deleting phonebook records from the currently loaded phonebook

- Start the phonebook manager software on your PC.
- Press the Phonebook tab.
- Load a phonebook into the phonebook manager.
- Select the rows of the phonebook entries to be deleted. Use your mouse to select a single row or hold down the CTRL key while using your mouse to click on the rows to be selected.
- Press the **Delete Selected Contacts**  button.
- Save the file to disk and/or transfer it to the handset.

Handset and base indicators

Handset icons



Line in use indicator

- On when an extension handset or parallel set is in use.

Hold indicator

- Flashes when a call is on hold.



Mute indicator

- Flashes when the handset microphone is muted.





Ringer off indicator

-  displays when the ringer is turned off.



Battery indicator

- When the handset is removed from the charger, this lets you know the level of charge in the battery, from **FULL** () to **EMPTY** ()
- Cycles (low, medium, and full) when handset battery is charging.
- Flashes when a low battery condition is detected.



New message indicator

- Flashes when there is a new message in the answer system.

Handset LEDs



- On when the handset speakerphone is in use.

Handset and base indicators

Base icons



Ringer off indicator

-  displays when the base ringer is turned off.



Line in use indicator

- On when an extension handset or parallel set is in use.



Hold indicator

- Flashes when a call is on hold.



Battery indicator

- Cycles (low, medium, and full) when battery is charging in the spare battery compartment.
- Flashes when the base unit is under power backup mode (No AC power is detected).

MUTE

Mute indicator

- Flashes when the microphone is muted.

ANS. OFF

Answering machine indicator

- Displays when the answer system is turned off.

REC. OFF

Record message indicator

- Displays when the Record Message function is turned off. In this mode, the answering system will only answer the call but not record any message.

Handset and base indicators

Base LEDs

- New Message**
- Flashes when there is a new message in the answer machine.
- Speakerphone**
- Flashes when a call is on hold.
 - Lights when the base speakerphone is in use.
- Charging**
- On when the handset is in the base unit.

Add additional handsets

Your telephone can accommodate up to eight cordless handsets. You can add new handsets (VTech i5808, purchased separately) anytime. Up to three handsets can be on a call at the same time.

The handset provided with your telephone system is automatically registered as Handset 1 (i5871), or Handset 1 and Handset 2 (for i5873). Additional handsets will be assigned in numerical order (2, 3, 4, etc.) when they are registered.

Before using a separately purchased handset, it must be registered with the base unit.

The maximum number of handsets for use at any time is three, and the possible combinations include:

- Three handsets and the base unit on an external call.
- Two handsets and the base unit on an external call, and one handset accessing the answering system.
- One handset and the base unit are on an external call, and two handsets are on intercom.

Registration of handsets

- Make sure the additional handset is fully charged before registration.
- On the base unit, press the softkey **MENU** in idle mode.
- Press the softkey **▼** three times to reach **REGISTER HANDSET**, and press the softkey **SELECT** to select.
- The base unit screen displays **READY TO REGISTER NEW HANDSET**, press the softkey **REGISTER** on the handset.
- The handset screen displays **Registration in Progress**. Within 15-60 seconds, the screen displays **Found Base**, and the base unit and handset will beep.

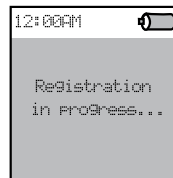

Add additional handsets

- The newly registered handset will be assigned the lowest extension number which has not been previously assigned to another system handset (2 through 8 for model i5871, 3 through 8 for model i5873).

Replace a handset

If you are replacing a handset on a system that has the maximum number of registered handsets (eight) or wish to change the assigned handset number of your registered handsets, you must first de-register the handsets, and then register all handsets again.

De-register a handset

- On the handset to be de-registered, press **MENU/SEL** when in idle mode.
- Press the **DOWN** NavKey ▼ four times to reach **Settings**, and press **MENU/SEL** to select.
- Press the **UP** NavKey ▲ once to reach **Reset Settings**, and press **MENU/SEL** to select.
- Press the **UP** NavKey ▲ twice to reach **Clear Registration**, and press **MENU/SEL** to select.
- The screen displays **Clear Handset Registration Are you sure?** Press the softkey **YES** to confirm, or press the softkey **NO** if you decide to keep the registration.
- The screen will then display the instructions for registering a handset.

Add additional handsets

De-register all handsets

- On the base unit, press the softkey **MENU**.
- Press the softkey ▼ once to reach **BASE SETTINGS**, then press the softkey **SELECT** to select.
- Press the softkey ▲ twice to reach **DELETE HANDSETS**, and press the softkey **SELECT** to select.
- The screen displays **DELETE REGISTRATION FOR ALL HANDSETS ARE YOU SURE?** Press the softkey **YES** to confirm, or press the softkey **NO** if you decide to keep the registration.

To re-register a handset, see **Registration of handsets** on page 63.

note

- When using your phone during power backup mode, audio quality may be compromised due to reduced power availability.

Charge spare battery pack

Power guard feature

Your phone uses a spare battery charger in the base unit to provide power backup in the event of a power failure or outage. With a fully charged battery in the spare battery charger, you will be able to make and receive calls for up to 2.5 hours during a power outage.

The spare battery can also be used to replace a depleted handset battery to ensure uninterrupted use. The spare battery is optional and can be purchased separately.

Installation

1. Open the spare battery compartment by pressing the release button located on the bottom of the base unit.
2. Remove the battery cover and place the battery in the compartment with the metal contacts aligned, as shown in the diagram.
3. Replace the compartment cover. The spare battery charger takes 20 hours to fully charge a depleted battery.

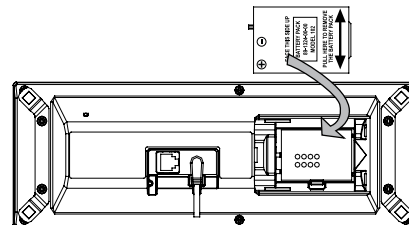
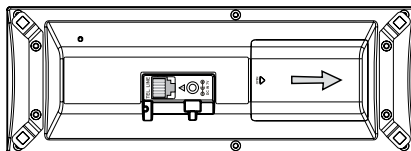

Batteries

After the battery is fully charged, you can expect the following performance:

Operation	Operating time
While in use (talking)	6 hours
While not in use (standby*)	96 hours (approximately 4 days)

*Handset is off the base unit but not in use.

The battery needs charging when:

- A new battery is installed in the handset.
- The telephone beeps twice once taken off the base unit.
- Battery indicator on screen is empty.

CAUTION:

To reduce the risk of fire or injury to persons, read and follow these instructions:

1. Use only the battery(ies) specified.
2. Do not dispose of the battery(ies) in a fire. They may explode. Check with local waste management codes for special disposal instructions.
3. Do not open or mutilate the battery(ies). Released electrolyte is corrosive and may cause burns or injury to the eyes or skin. The electrolyte may be toxic if swallowed.
4. Exercise care in handling batteries in order not to short the battery to conductive materials such as rings, bracelets, and keys. The battery and/or conductor may overheat and cause burns.
5. Charge the battery(ies) provided with or identified for use with this product only in accordance with the instructions and limitations specified in this manual.

WARNING:

TO PREVENT FIRE OR SHOCK HAZARD, DO NOT EXPOSE THIS PRODUCT TO RAIN OR ANY TYPE OF MOISTURE.

The AC adapter is used as the main disconnect device, ensure that the AC outlet is located/installed near the unit and is easily accessible.

Important safety instructions

When using your telephone equipment, basic safety precautions should always be followed to reduce the risk of fire, electric shock and injury, including the following:

1. Read and understand all instructions.
2. Follow all warnings and instructions marked on the product.
3. Unplug this product from the wall outlet before cleaning. Do not use liquid or aerosol cleaners. Use a damp cloth for cleaning.
4. Do not use this product near water (for example, near a bathtub, kitchen sink, or swimming pool).
5. Do not place this product on an unstable surface, such as a table, shelf or stand. This product may fall, causing serious damage.
6. Slots and openings in the back or bottom of the base unit and handset are provided for ventilation. To protect them from overheating, these openings must not be blocked by placing the product on a soft surface such as a bed, sofa or rug. This product should never be placed near or over a radiator or heat register. This product should not be placed in any area where proper ventilation is not provided.
7. This product should be operated only from the type of power source indicated on the marking label. If you are not sure of the type of power supply in your home, consult your dealer or local power company.
8. Do not allow anything to rest on the power cord. Do not install this product where the cord may be walked on.
9. Never push objects of any kind into this product through slots in the base or handset as they may touch dangerous voltage points or short out parts that could result in a risk of fire or electric shock. Never spill liquid of any kind on the product.
10. To reduce the risk of electric shock, do not disassemble this product, but take it to an authorized service facility. Opening or removing parts of the base or handset other than specified access doors may expose you to dangerous voltages or other risks. Incorrect reassembling can cause electric shock when the product is subsequently used.
11. Do not overload wall outlets and extension cords as this can result in the risk of fire or electric shock.
12. Unplug this product from the wall outlet and refer servicing to an authorized service facility under the following conditions:
 - A. When the power supply cord or plug is damaged or frayed.
 - B. If liquid has been spilled onto the product.
 - C. If the product has been exposed to rain or water.
 - D. If the product does not operate normally by following the operating instructions. Adjust only those controls that are covered by the operation instructions, as improper adjustment of other controls may result in damage and often requires extensive work by an authorized technician to restore the product to normal operation.
 - E. If the product has been dropped and the base and/or handset has been damaged.
 - F. If the product exhibits a distinct change in performance.
13. Avoid using a telephone (other than cordless) during an electrical storm. There is a remote risk of electric shock from lightning.
14. Do not use the telephone to report a gas leak in the vicinity of the leak.
15. Only put the handset of your telephone next to your ear when it is in normal talk.

CAUTION: Use only the power adapter provided with this product. To obtain a replacement, call 1(800)222-3111. In Canada, call 1(866)288-4268.

SAVE THESE INSTRUCTIONS

Troubleshooting

If you have difficulty operating your telephone, the suggestions below should solve the problem. If you still have difficulty after trying these suggestions, call VTech Communications at 1(800)595-9511. In Canada, call VTech Telecommunications Canada Ltd. at 1(800)267-7377.

Problem	Suggestion
My telephone doesn't work at all.	<ul style="list-style-type: none">• Make sure the power adaptor is plugged in.• Make sure the telephone line cord is plugged firmly into the base unit and the telephone wall jack.• Disconnect the power adaptor for a few minutes, and then reconnect it.• Charge the battery in the handset for 16 hours. For optimum daily performance, return the handset to its base unit when not in use.• Reset the base unit. Unplug the electrical power. Wait for 15 seconds then plug it back in. Allow up to one minute for the handset and base unit to reset.• You may need to purchase a new battery, please refer to the Batteries sections in this user's manual.
I cannot get a dial tone.	<ul style="list-style-type: none">• Try all the suggestions above.• Move the handset closer to the base unit. You might have moved out of range.• Make sure the telephone is set to the correct dial mode for the type of service that you have (pulse or touchtone). Refer to the Installation section of this user's manual to set the dial mode.• Your line cord might be malfunctioning. Try installing a new line cord.• If the previous suggestions do not work, disconnect the telephone base from the telephone jack and connect a different telephone. If there is no dial tone on that telephone either, the problem is in the wiring or local service. Contact your local telephone company.

Troubleshooting

Problem	Suggestion
I cannot dial out.	<ul style="list-style-type: none">• Make sure there is a dial tone before dialing. It is normal for handset to take a second or two to find the base unit and produce a dial tone. Wait an extra second before dialing.• Make sure the telephone is set to the correct dial mode for the type of service that you have (pulse or touchtone). Refer to the Set dial mode (page 20) of this user's manual to set the dial mode.• If the other telephones in your home are having the same problem, the problem is in your wiring or local service. Contact your local telephone company.• Eliminate any background noise. Noise from a television, radio or other appliance may cause the telephone not to dial out properly. If you cannot eliminate the background noise, first try muting the handset before dialing, or dialing from another room in your home with less background noise.
The batteries do not hold a charge.	<ul style="list-style-type: none">• Charge the battery in the handset for 16 hours. For optimum daily performance, return the handset to its base unit when not in use.• You may need to purchase a new battery, please refer to the Batteries section in this user's manual.• Your telephone might be malfunctioning. Please refer to the Warranty section of this user's manual for further instruction.

Troubleshooting

Problem	Suggestion
I get noise, static, or weak signal even when I'm near the telephone base.	<ul style="list-style-type: none">• Other electronic products can cause interference with your cordless telephone. Try installing your telephone away from these types of electronic devices: wireless routers, radios, radio towers, pager towers, cell phones, intercoms, room monitors, televisions, personal computers, kitchen appliances and other cordless telephones.• Microwave oven operates on the same frequency as your telephone. It is normal to experience static on your telephone while the microwave oven is running. Do not install this telephone in the same outlet or near the microwave oven.• If your telephone is plugged in with a modem or surge protector, plug the telephone (or modem/surge protector) into a different location. If this solves the problem, re-locate your telephone or modem farther apart from one another, or use a different surge protector.• Relocate your base unit to a higher location. The telephone will likely get better reception if not installed in a lower area.• If the other telephones in your home are having the same problem, the problem is in your wiring or local service. Contact your local telephone company (charges may apply).
I hear noise in the handset, and none of the keys or buttons work.	<ul style="list-style-type: none">• Make sure the power cord is plugged in.
I hear other calls while using my telephone.	<ul style="list-style-type: none">• Disconnect your base unit from the telephone jack, and plug in a regular telephone. If you still hear other calls, the problem is probably in your wiring or local service. Call your local telephone company.

Troubleshooting

Problem	Suggestion
My handset does not ring when I receive a call.	<ul style="list-style-type: none">• Make sure you have the ringer activated. Refer to the section(s) on ringer selection in this user's manual.• Make sure the telephone line cord is plugged firmly into the base unit and the telephone jack. Make sure the power cord is plugged in.• The handset may be too far from the base unit.• Charge the battery in the handset for 16 hours. For optimum daily performance, return the handset to its base unit when not in use.• You may have too many extension telephones on your telephone line to allow all of them to ring. Try unplugging some of the other telephones.• The layout of your home or office might be limiting the operating range. Try moving the telephone base to another location, preferably on an upper floor.• If the other telephones in your home are having the issue, the problem is in your wiring or local service. Contact your local telephone company (charges may apply).• Test a working telephone at the telephone jack. If another telephone has the same problem, the problem is the telephone jack. Contact your local telephone company (charges may apply).• Other electronic products can cause interference with your cordless telephone. Try installing your telephone as far away from these types of electronic devices as possible: wireless routers, radios, radio towers, pager towers, cell phones, intercoms, room monitors, televisions, personal computers, kitchen appliances and other cordless telephones• Your line cord might be malfunctioning. Try installing a new line cord.

Troubleshooting

Problem	Suggestion
My calls fade or cut in and out while I'm using my handset.	<ul style="list-style-type: none">• Other electronic products can cause interference with your cordless telephone. Try installing your telephone as far away from these types of electronic devices as possible: wireless routers, radios, radio towers, pager towers, cell phones, intercoms, room monitors, televisions, personal computers, kitchen appliances and other cordless telephones.• Microwave oven operates on the same frequency as your telephone. It is normal to experience static on your telephone while the microwave oven is running. Do not install this telephone in the same outlet or near the microwave oven.• If your telephone is plugged in with a modem or surge protector, plug the telephone (or modem/surge protector) into a different location. If this solves the problem, re-locate your telephone or modem farther apart from one another, or use a different surge protector.• Relocate your telephone base to a higher location. The telephone will get better reception if not installed in a lower area.• If the other telephones in your home are having the issue, the problem is in your wiring or local service.
My caller ID isn't working.	<ul style="list-style-type: none">• Caller ID is a subscription service. You must subscribe to this service for this feature to work on your telephone.• Your caller must be calling from an area that supports caller ID.• Both you and your caller's telephone companies must use caller ID compatible equipment.

Troubleshooting

Problem	Suggestion
Common cure for electronic equipment	<p>If the unit does not seem to be responding normally, then try putting the handset in its telephone base. If it does not seem to respond, do the following (in the order listed):</p> <ol style="list-style-type: none"><li data-bbox="358 275 839 298">1. Disconnect the power to the telephone base.<li data-bbox="358 306 1033 329">2. Disconnect the handset battery, and spare battery, if applicable.<li data-bbox="358 337 582 360">3. Wait a few minutes.<li data-bbox="358 368 772 391">4. Connect power to the telephone base.<li data-bbox="358 399 646 422">5. Re-install the battery(ies).<li data-bbox="358 430 1325 482">6. Wait for the handset to re-establish its link with the telephone base. To be safe, allow up to one minute for this to take place.

Operating range

This cordless telephone operates with the maximum power allowed by the Federal Communications Commission (FCC). Even so, this handset and telephone base can communicate over only a certain distance ----which can vary with the locations of the telephone base and handset, the weather, and the layout of your home or office.

When the handset is out of range, the handset will display **Searching**. The user can access the handset phonebook, and certain parts of the menu system, i.e. handset setting and registration, but not the time setting and base setting. **Not possible** will be displayed if access is tried.

If there is a call while the handset is out of range, it might not ring, or if it does ring, the call might not connect well when you press TALK/FLASH. Move closer to the telephone base, then press TALK/FLASH to answer the call.

If the handset moves out of range during a telephone conversation, there might be interference.

To improve reception, move closer to the base.

Maintenance

Taking care of your telephone

Your cordless telephone contains sophisticated electronic parts, so it must be treated with care.

Avoid rough treatment

Place the handset down gently. Save the original packing materials to protect your telephone if you ever need to ship it.

Avoid water

Your telephone can be damaged if it gets wet. Do not use the handset outdoors in the rain, or handle it with wet hands. Do not install your base unit near a sink, bathtub or shower.

Electrical storms

Electrical storms can sometimes cause power surges harmful to electronic equipment. For your own safety, use caution when using electric appliances during storms.

Cleaning your telephone

Your telephone has a durable plastic casing that should retain its luster for many years. Clean it only with a soft cloth slightly dampened with water or a mild soap. Do not use excess water or cleaning solvents of any kind.

Remember that electrical appliances can cause serious injury if used when you are wet or standing in water. If your base unit should fall into water, DO NOT RETRIEVE IT UNTIL YOU UNPLUG THE POWER CORD AND TELEPHONE LINE CORDS FROM THE WALL. Then pull the unit out by the unplugged cords.

About cordless telephones

- **Privacy:** the same features that make a cordless phone convenient create some limitations. Telephone calls are transmitted between the base and the cordless handset by radio waves, so there is a possibility that your cordless phone conversations could be intercepted by radio receiving equipment within range of the cordless handset. For this reason, you should not think of cordless phone conversations as being as private as those on corded phones.
- **Electrical Power:** The base unit of this cordless telephone must be connected to a working electrical outlet. The electrical outlet should not be controlled by a wall switch. Calls cannot be made from the cordless handset if the base unit is unplugged or switched off, or if the electrical power is interrupted.
- **Potential TV Interference:** Some cordless telephones operate at frequencies that may cause interference to televisions and VCRs. To minimize or prevent such interference, do not place the base unit of the cordless telephone near or on top of a TV or VCR. If interference is experienced, moving the cordless telephone farther away from the TV or VCR will often reduce or eliminate the interference. (Applies to 25 channel cordless phones only).
- **Rechargeable Batteries:** This product contains either Nickel-Cadmium or Nickel-Metal Hydride rechargeable batteries. Exercise care in handling batteries in order not to short the battery with conducting material such as rings, bracelets, and keys. The battery or conductor may overheat and cause harm. Observe proper polarity between the battery and the battery charger.
- **Nickel-Metal Hydride Rechargeable Batteries:** Dispose of these batteries in a safe manner. Do not burn or puncture. Like other batteries of this type, if burned or punctured, they could release caustic material which could cause injury.

Warranty

What does this limited warranty cover?

The manufacturer of this Vtech product, Vtech Communications, warrants to the holder of a valid proof of purchase ("Consumer" or "you") that the product and all accessories provided by Vtech in the sales package ("Product") are free from material defects in material and workmanship, pursuant to the following terms and conditions, when installed and used normally and in accordance with operation instructions. This limited warranty extends only to the Consumer for Products purchased and used in the United States of America.

What will Vtech Communications do if the Product is not free from material defects in materials and workmanship during the limited warranty period ("Materially Defective Product")?

During the limited warranty period, Vtech's authorized service representative will repair or replace at Vtech's option, without charge, a Materially Defective Product. If we repair this product, we may use new or refurbished replacement parts. If we choose to replace this product, we may replace it with a new or refurbished product of the same or similar design. Vtech will return repaired or replacement products to you in working condition. Vtech will retain defective parts, modules, or equipment. Repair or replacement of Product, at Vtech's option, is your exclusive remedy. You should expect the repair or replacement to take approximately 30 days.

How long is the limited warranty period?

The limited warranty period for the product extends for ONE (1) YEAR from the date of purchase if we repair or replace a Materially Defective Product under the terms of this limited warranty. This limited warranty also applies to repaired or replacement Products for a period of either (a) 90 days from the date the repaired or replacement Product is shipped to you or (b) the time remaining on the original one-year warranty; whichever is longer.

What is not covered by this limited warranty?

This limited warranty does not cover

1. Product that has been subjected to misuse, accident, shipping or other physical damage, improper installation, abnormal operation or handling, negligent, inundation, fire, water or other liquid intrusion; or
2. Product that has been damaged due to repair, alteration or modification by anyone other than an authorized service representative of Vtech; or
3. Product to the extent that the problem experienced is cause by signal conditions, network reliability or cable or antenna systems; or
4. Product to the extent that the problem is caused by use with non-Vtech electrical accessories; or
5. Product whose warranty/quality stickers, Product serial numbers plates or electronic serial numbers have been removed, altered or rendered illegible; or
6. Product purchased, used serviced, or shipped for repair from outside the United States, or used for commercial or institutional purposes (including but not limited to Products used for rental purposes); or

Warranty

7. Product returned without valid proof of purchase (see 2 below); or
8. Charges for installation or set up, adjustment of customer controls, and installation or repair of systems outside the unit.

How do you get warranty service?

- To obtain warranty service in the United States of America, call 1(800)595-9511 for instructions regarding where to return the Product. Before calling for service, please check the user's manual. A check of the Product controls and features may save you a service call.
- Except as provided by applicable law, you assume the risk of loss or damage during transit and transportation and are responsible for delivery or handling charges incurred in the transport of Product(s) to the service location. VTech will return repaired or replaced product under this limited warranty to you, transportation, delivery or handling charges prepaid. VTech assumes no risk for damage or loss of the Product in transit.
- If the Product failure is not covered by this limited warranty, or proof of purchase does not meet the terms of this limited warranty, VTech will notify you and will request that you authorize the cost of repair and return shipping costs for the repair of Products that are not covered by this limited warranty.

What must you return with the Product to get warranty service?

1. Return the entire original package and contents including the Product to the VTech service location along with a description of the malfunction or difficulty;
2. Include "valid proof or purchase" (sales receipt) identifying the Product purchased (Product model) and the date of purchase or receipt; and
3. Provide your name, complete and correct mailing address, and telephone number.

Other Limitations

- This warranty is the complete and exclusive agreement between you and VTech. It supersedes all other written or oral communications related to this Product. VTech provides no other warranties for this product. The warranty exclusively describes all of VTech's responsibilities regarding the product.

There are no other express warranties. No one is authorized to make modifications to this limited warranty and you should not rely on any such modification.

State Law Rights: This warranty gives you specific legal rights, and you may also have other rights, which vary from state to state.

Limitations: Implied warranties, including those of fitness for a particular purpose and merchantability (an written warranty that the product is fit for ordinary use) are limited to one year from date of purchase. Some states do not allow limitations on how long an implied warranty lasts, so the above limitation may not apply to you.

- In no event shall VTech be liable for any indirect, special, incidental, consequential, or similar damages (including, but not limited to lost profits or revenue, inability to use the product, or other associated equipment, the cost of substitute equipment, and claims by third parties) resulting from the use of this product, some states do not allow exclusion or limitation of incidental or consequential damages, so the above limitation or exclusion may not apply to you.

FCC, ACTA and IC regulations

This equipment complies with Parts 15 of the Federal Communications Commission (FCC) rules for the United States. It also complies with regulations RSS210 and CS-03 of Industry and Science Canada. Operation is subject to the following two conditions: (1) this device may not cause interference, and (2) this device must accept any interference, including interference that may cause undesired operation of the device.

A label is located on the underside of the base unit containing either the FCC registration number and Ringer Equivalence Number (REN) or the IC registration number and Load Number. You must, upon request, provide this information to your local telephone company.

This equipment is compatible with inductively coupled hearing aids.

Should you experience trouble with this telephone equipment, please contact:

VTech Communications Inc.

CUSTOMER SERVICE at 1(800)595-9511. In Canada, call VTech Telecommunications Canada Ltd. at 1(800)267-7377.

For repair/warranty information. The telephone company may ask you to disconnect this equipment from the line network until the problem has been corrected.

www.vtechphones.com

Download from Www.Somanuals.com. All Manuals Search And Download.

FCC, ACTA and IC regulations

FCC Part 15

Warning: Changes or modifications to this unit not expressly approved by the party responsible for compliance could void the user's authority to operate the equipment. The equipment has been tested and found to comply with part 15 of the FCC rules. These limits are designed to provide reasonable protection against harmful interference in a residential installation. This equipment generates, uses and can radiate radio frequency energy and, if not installed and used in accordance with the instructions, may cause harmful interference to radio communications. However, there is no guarantee that interference will not occur in a particular installation. If this equipment does cause harmful interference to radio or television reception, which can be determined by turning the equipment off and on, the user is encouraged to try and correct the interference by one or more of the following measures:

- Reorient or relocate the receiving antenna.
- Increase the separation between the equipment and receiver.
- Connect the equipment into an outlet or on a circuit different from that to which the receiver is connected.
- Consult the dealer or an experienced radio/TV technician for help.

To ensure safety of users, the FCC has established criteria for the amount of radio frequency energy that can be safely absorbed by a user or bystander according to the intended usage of the product. This product has been tested and found to comply with the criteria. The handset has such a low power that it does not require testing. It may be safely held against the ear of the user. The base unit shall be installed & used such that parts of the user's body other than the hands should be maintained at a comfortable distance of approximately 20cm or more.

FCC Part 68 and ACTA

If this equipment was approved for connection to the telephone network prior to July 23, 2001, it complies with Part 68 of the Federal Communications Commission (FCC) rules. If the equipment was approved after that date, it complies with the Part 68 rules and with Technical Requirements for Connection of Equipment to the Telephone Network adopted by the Administrative Council for Terminal Attachments (ACTA). We are required to provide you with the following information.

1. Product identifier and REN information

The label on the back or bottom of this equipment contains, among other things, an identifier indicating product approval and the Ringer Equivalence Number (REN). This information must be provided to your local telephone company upon request. For equipment approved prior to July 23, 2001, the product identifier is preceded by the phrase "FCC Reg No." and the REN is listed separately. For equipment approved after that date, the product identifier is preceded by "US" and a colon (:), and the REN is encoded in the product identifier without a decimal point as the sixth and seventh characters following the colon. For example, the product identifier US:AAAEQ3T123XYZ would indicate an REN of 0.3. The REN is used to determine how many devices you may connect to your telephone line and still have them ring when you are called. In most, but not all areas, the sum of all RENs should be five (5.0) or less. You may want to contact your local telephone company for more information.

2. Connection and use with the nationwide telephone network

The plug and jack used to connect this equipment to the premises wiring and the telephone network must comply with the applicable Part 68 rules and technical requirements adopted by ACTA. A compliant telephone cord and modular plug is provided with this product. It is designed to be connected to a compatible modular jack that is also compliant. An RJ11 jack should normally be used for connecting to a single line and an RJ14 jack for two lines. See Installation Instructions in the user's manual. This equipment may not be used with Coin Telephone Lines or with Party Lines. If you have specially wired alarm dialing equipment connected to your telephone line, ensure the connection of this equipment does not disable your alarm equipment. If you have questions about what will disable alarm equipment, consult your telephone company or a qualified installer.

3. Repair instructions

If this equipment is malfunctioning, it must be unplugged from the modular jack until the problem has been corrected. Repairs to this telephone equipment can only be made by the manufacturer or its authorized agents. For repair procedures, follow the instructions outlined under the Limited Warranty.

4. Rights of the telephone company

If this equipment is causing harm to the telephone network, the telephone company may temporarily discontinue your telephone service. The telephone company is required to notify you before interrupting service. If advance notice is not practical, you will be notified as soon as possible. You will be given the opportunity to correct the problem and the telephone company is required to inform you of your right to file a complaint with the FCC. Your telephone company may make changes in its facilities, equipment, operation, or procedures that could affect the proper functioning of this product. The telephone company is required to notify you if such changes are planned.

FCC, ACTA and IC regulations

5. Hearing aid compatibility

If this product is equipped with a corded or cordless handset, it is hearing aid compatible.

6. Programming/testing of emergency numbers

If this product has memory dialing locations, you may choose to store police, fire department and emergency medical service telephone numbers in these locations. If you do, please keep three things in mind:

- a. We recommend that you also write the telephone number on the directory card, so that you can still dial the emergency number manually if the memory dialing feature doesn't work.
 - b. This feature is provided only as a convenience, and the manufacturer assumes no responsibility for customer reliance upon the memory feature.
 - c. Testing the emergency telephone numbers you have stored is not recommended. However, if you do make a call to an emergency number:
- You must remain on the line and briefly explain the reason for the call before hanging up.
 - Programming/testing of emergency numbers should be performed during off-peak hours, such as in the early morning or late evening, when the emergency services tend to be less busy.

IC (Industry Canada)

This telephone is registered for use in Canada.

The term "IC" before the radio certification number only signifies that Industry Canada technical specifications were met.

Notice:

This equipment meets the applicable Industry Canada Terminal Equipment Technical Specifications. This is confirmed by the registration number. The abbreviation, IC, before the registration number signifies that registration was performed based on a Declaration of Conformity indicating that Industry Canada technical specifications were met. It does not imply that Industry Canada approved the equipment.

Notice:

The Ringer Equivalence Number (REN) for this terminal equipment is 0.1. The REN assigned to each terminal equipment provides an indication of the maximum number of terminal allowed to be connected to a telephone interface. The termination on an interface may consist of any combination of devices subject only to the requirement that the sum of the Ringer Equivalence Numbers of all the devices does not exceed five.

Before installing this equipment, user should ensure that it is permissible to be connected to the facilities of the local telecommunications company. The equipment must also be installed using an acceptable method of connection. The customer should be aware that compliance with the above conditions may not prevent degradation of services in some situations.

Repairs to certified equipment should be made by an authorized Canadian maintenance facility designated by the supplier. Any repairs or alterations made by the user to this equipment, or equipment malfunctions, may give the telecommunications company cause to require the user to disconnect the equipment.

Users should ensure for their own protection that the electrical ground connections of the power utility, telephone lines and internal metallic water pipe system, if present, are connected together. This precaution may be particularly important in rural areas.

Caution:

Users should not attempt to make sue connections themselves, but should contact the appropriate electrical inspection authority, or electrician, as appropriate.

Your Cordless Phone is designed to operate at the maximum power allowed by the FCC and IC. This means your handset and base unit can communicate only over a certain distance – which will depend on the location of the base unit and handset, weather, and the construction and layout of your home or office.

Technical specifications

Frequency control	Crystal controlled PLL synthesizer
Frequency	Base: 5725-5850 MHz Handset: 5725-5850 MHz
Channels	95
Nominal effective range	Maximum power allowed by FCC and IC. Actual operating range may vary according to environmental conditions at the time of use.
Size	Handset: 190.0mm X 42.0mm X 31.0mm Base: 250.0mm X 90.0mm X 84.0mm
Weight	Handset: 145.0 grams (including battery) Base: 423.8 grams
Power requirements	Handset: 3 cells AAA 3.6V 800mAh NiMH battery Base: 7V DC @ 1100mA
Memory	Handset phonebook: 100 memory locations; up to 32 digits, 16 characters per location Handset call log: 100 memory locations Base call log: 50 memory locations

Index

A

- About caller ID information 9
- About cordless telephones 76
- Activate the answering system 42
- Add additional handsets 63-65
- Answering system operation 41-49

B

- Base icons 61
- Base LEDs 62
- Base settings 22-24
- Batteries 67
- Belt clip 8

C

- Call log 36-38
- Call waiting 17
- Charge spare battery pack 66
- Chart of characters 33
- Choose a location 6
- Clock setting 18, 22
- Conference call 29
- Contrast 24
- Creating an empty phonebook 55
- Customize entries 34

D

- De-register a handset 64

- De-register all handsets 65
- Delete all messages 17, 47
- Delete an entry 38
- Delete a phonebook entry 35
- Delete a redial entry 40
- Deleting phonebook records from the currently loaded phonebook 59
- Dial a call log entry 37
- Dial an entry from the redial list 39
- Dial a phonebook entry 35
- Dial type 24

E

- Edit a phonebook 56
- Edit a phonebook entry 35
- Edit handset name 19
- Exporting contacts to a comma separated text file 58

F

- Factory settings 24
- FCC, ACTA and IC regulations 77-79
- FLASH 27

G

- Graphic editing 54
- Graphics tab functions 52

H

- Handset and base indicators 60-62
- Handset icons 60
- Handset layout 11
- Handset LEDs 60
- Handset messages 16-17
- Handset screen images 13
- Handset settings 18-21
- Handset sounds 14-15
- Hold 26

I

- If you subscribe to DSL service 10
- Important safety instructions 68
- Import contacts into phonebook manager from other PC applications 57
- Index 81-83
- Install handset battery 7
- Intercom call 27-31

K

- Keypad tone 23

L

- Language 20

Index

M

- Maintenance 75
- Make, answer and end calls on the base unit 25-26
- Make, answer and end calls on the handset 25
- Memo playback 48
- Message capacity 41
- Message playback 47
- Message playback on the base unit 47
- Mute 26

N

- New message indication 47

O

- One-time software installation 52
- Open a graphic file 53
- Operating range 75
- Options during playback 17, 47
- Options while on calls 26-27
- Outgoing greeting 45-46

P

- Parts checklist 3-5

- Phonebook 32-35
- Phonebook tab functions 55-59
- Picture download 52-54
- Pictures & animations 13
- Play the message 16
- Play your greeting 45
- Power guard feature 66

R

- Recordable ringer 50
- Record a memo 48
- Record a sound clip by using the audio patch cord 50
- Record a sound clip by using the microphone 51
- Recording and playing memos 48
- Record your greeting 45
- Redial list 39-40
- Registration of handset 63
- Remote access 53
- Replace a handset 64
- Reset settings 21
- Restore to factory greeting 46
- Review the call log 37
- Ringer melody 14, 23
- Ringer silencing 27
- Ringer vibrate 15

- Ringer volume 14, 23

S

- Save an entry to the handset phonebook 38, 40
- Screen saver 13
- Search the phonebook 34
- Set a wallpaper image 13
- Set call screening 42
- Set contrast 19
- Set dial mode 20
- Set new message tone 44
- Set number of rings 43
- Set record options 42
- Set security code 44
- Setting answering system 42-44
- Show handset name 20
- Speakerphone at the handset 26
- Store an entry in the phonebook 32

T

- Technical specifications 80
- To access remote access 49
- Tone settings 18
- To transfer images from the software to the handset 53
- Transfer an external call 30

Index

Troubleshooting 69-74

V

Volume control 27

W

Warranty 76-77

Weekday setting 22

VTECH TELECOMMUNICATIONS LTD.

A member of THE VTECH GROUP OF COMPANIES.

Distributed in the U.S.A. by VTech Communications, Inc. Beaverton, Oregon

Distributed in Canada by VTech Telecommunications Canada, Ltd., Richmond, B.C.

Copyright ©2006 for VTECH TELECOMMUNICATIONS LTD.

Printed in China.

91-000865-010-000



User's Manual

www.vtechphones.com



Model: i5871/5873

Download from [Www.Somanuals.com](http://www.Somanuals.com). All Manuals Search And Download.

5.8
GHz
DIGITAL

Free Manuals Download Website

<http://myh66.com>

<http://usermanuals.us>

<http://www.somanuals.com>

<http://www.4manuals.cc>

<http://www.manual-lib.com>

<http://www.404manual.com>

<http://www.luxmanual.com>

<http://aubethermostatmanual.com>

Golf course search by state

<http://golfingnear.com>

Email search by domain

<http://emailbydomain.com>

Auto manuals search

<http://auto.somanuals.com>

TV manuals search

<http://tv.somanuals.com>