

TABLE OF CONTENTS

IMPORTANT SAFETY INSTRUCTIONS.....	2
PARTS CHECK LIST.....	3
HANDSET LAYOUT.....	4
BASE LAYOUT.....	5
GETTING STARTED.....	6
Installation of Battery Pack in Handset.....	6
Setting up your 9127.....	7
Ringer Selection.....	8
Tone / Pulse Selection.....	8
The Handset Display.....	9
BASIC OPERATION.....	10
Making Calls.....	10
Volume Control.....	10
Channel Changing.....	10
Using Redial.....	11
Answering Calls.....	11
Flash.....	11
Hold.....	12
Page.....	12
ADVANCED OPERATION.....	13
CALLER ID/CALL WAITING ID.....	13
Receiving and Storing Calls.....	13
About Caller ID	13
Review Caller ID	13
Deleting Records From Call History.....	14
Delete A Specific Call.....	14
Delete All Calls.....	14
Dial A Displayed Number.....	14
Store A Caller ID Record In Phone Book Memory.....	14
Display Screen Messages.....	15
PHONE BOOK.....	16
Store Memory Numbers.....	16
Edit Numbers Stored In Memory.....	17
Delete Numbers Stored in Memory.....	17
Dial Memory Numbers.....	17
MESSAGE WAITING.....	18
OPTIONAL HEADSET INSTALLATION	19
ADDITIONAL INFORMATION.....	20
Maintenance.....	20
In Case of Difficulty.....	21
Limited Warranty.....	23
FCC, ACTA AND IC REGULATIONS.....	25
RBRC™ Seal.....	27
Technical Specifications.....	28

IMPORTANT SAFETY INSTRUCTIONS

When using your telephone equipment, basic safety precautions should always be followed to reduce the risk of fire, electric shock and injury, including the following:

1. Read and understand all instructions.
2. Follow all warnings and instructions marked on the product.
3. Unplug this product from the wall outlet before cleaning. Do not use liquid cleaners or aerosol cleaners. Use a damp cloth for cleaning.
4. Do not use this product near water (for example, near a bath tub, kitchen sink, or swimming pool).
5. Do not place this product on an unstable cart, stand, or table. The product may fall, causing serious damage to the product.
6. Slots and openings in the cabinet and the back or bottom are provided for ventilation. To protect it from overheating, these openings must not be blocked by placing the product on the bed, sofa, rug, or other similar surface. This product should never be placed near or over a radiator or heat register. This product should not be placed in a built-in installation where proper ventilation is not provided.
7. This product should be operated only from the type of power source indicated on the marking label. If you are not sure of the type of power supply to your home, consult your dealer or local power company.
8. Do not allow anything to rest on the power cord. Do not locate this product where the cord will be abused by persons walking on it.
9. Never push objects of any kind into this product through cabinet slots as they may touch dangerous voltage points or short out parts that could result in a risk of fire or electric shock. Never spill liquid of any kind on the product.
10. To reduce the risk of electric shock, do not disassemble this product, but take it to an authorized service facility. Opening or removing cabinet parts other than specified access doors may expose you to dangerous voltages or other risks. Incorrect reassembling can cause electric shock when the appliance is subsequently used.
11. Do not overload wall outlets and extension cords as this can result in the risk of fire or electric shock.
12. Unplug this product from the wall outlet and refer servicing to an authorized service facility under the following conditions:
 - A. When the power supply cord or plug is damaged or frayed.
 - B. If liquid has been spilled into the product.
 - C. If the product has been exposed to rain or water.
 - D. If the product does not operate normally by following the operating instructions. Adjust only those controls that are covered by the operating instructions, because improper adjustment of other controls may result in damage and will often require extensive work by an authorized technician to restore the product to normal operation.
 - E. If the product has been dropped and the cabinet has been damaged.
 - F. If the product exhibits a distinct change in performance.
13. Avoid using a telephone (other than a cordless type) during an electrical storm. There may be a remote risk of electric shock from lightning.
14. Do not use the telephone to report a gas leak in the vicinity of the leak.



If you have questions about this product, or if you're having difficulty with setup or operation, do not return your phone to the store. Call our Customer Support Center at:

1-800-595-9511

In Canada, call

1-800-267-7377

PARTS CHECK LIST

1. Base Unit
2. Handset
3. User's Manual
4. Power Adaptor
5. Telephone Line Cord
6. Battery Pack
7. Belt Clip

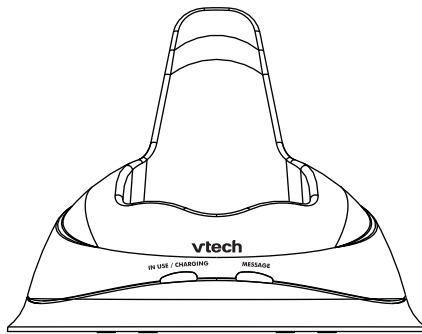

Base Unit



Handset

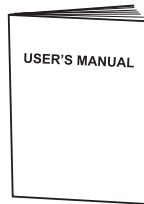

User's Manual

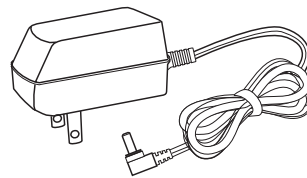

Power Adaptor

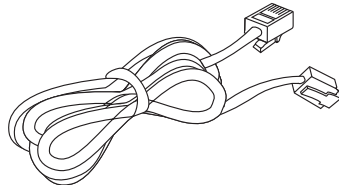

Telephone Line Cord



Battery Pack



Belt Clip

HANDSET LAYOUT

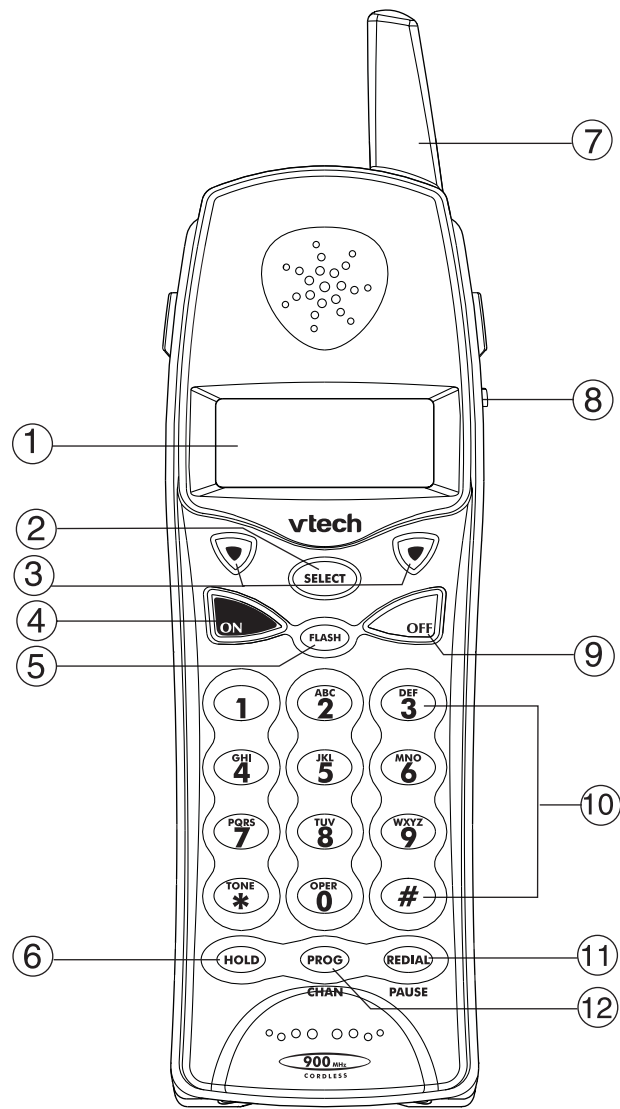

1. LCD Display
2. SELECT
3. Navigation/Volume Keys
4. ON
5. FLASH
6. HOLD

7. Antenna
8. Headset Jack
9. OFF
10. Dialing Keys
11. REDIAL/PAUSE
12. PROGRAM/CHANNEL

BASE LAYOUT

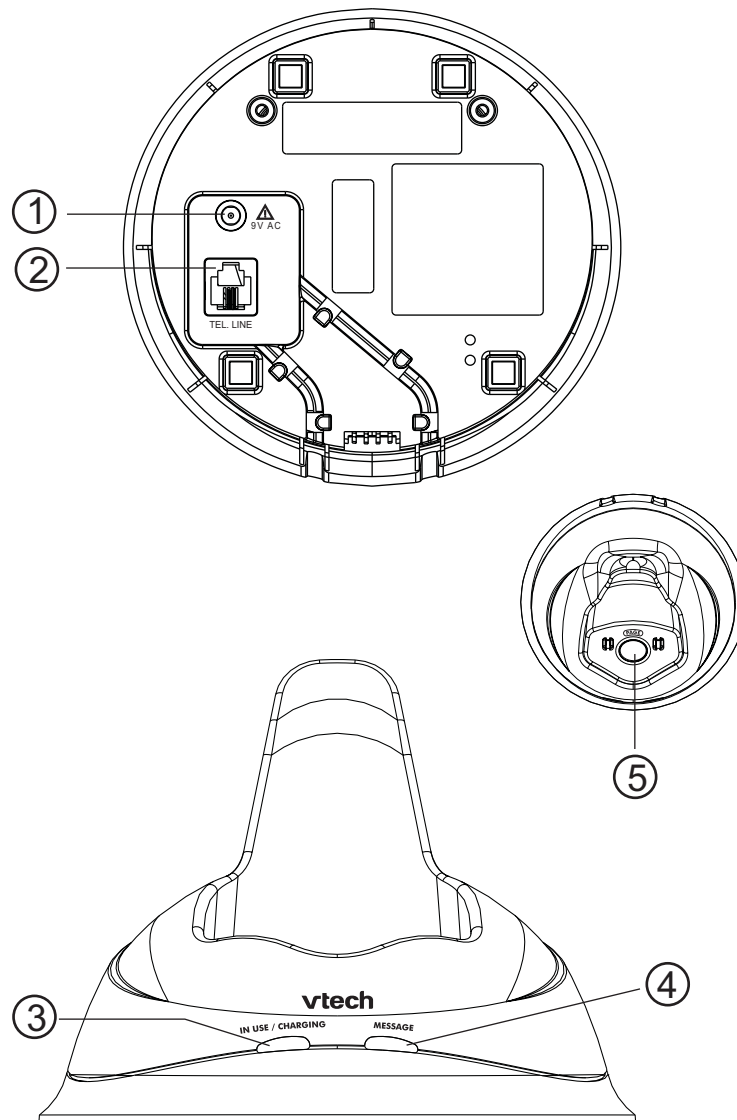

- 1. Power Jack
- 2. Telephone Line Jack
- 3. IN USE/CHARGING LED
- 4. MESSAGE Indicator
- 5. PAGE

INSTALLATION OF BATTERY PACK IN HANDSET

The Handset of your **9127** is powered by a rechargeable battery pack. It charges automatically whenever the Handset is in the Base Unit. The battery pack needs charging when:

- The low battery icon and message are displayed:
- A double beep is generated.

BATTERY LOW



To charge the battery pack, place the Handset in the Base Unit. The **IN USE/CHARGING** indicator will light to show the Handset is seated properly and the battery pack is charging. It is recommended that the battery pack should be charged for at least 16 hours initially. Afterwards, 8 hours of maintenance charging should be sufficient.

To install (or replace) the battery pack, follow the steps below:

1. Remove the battery case cover by pressing on the ridged lines and sliding downward.
2. Discard the old battery pack by pulling firmly on the battery cords. Don't put the old battery pack in a trash compactor or a fire - it could burst. Please recycle.
3. Snap in the new battery pack, with the wires in one of the lower corners. Insert the battery plug into the socket, aligning the two holes in the plug with the socket pins.

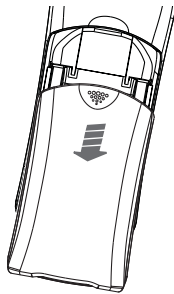

4. Replace the battery case cover by sliding the cover upwards.
5. Place the Handset in the cradle of the Base Unit to allow it to charge for 16 hours.

CAUTION: To Reduce the Risk of Fire or Injury, Read and Follow these Instructions:

IMPORTANT:

Do not dispose of this battery pack into household garbage. For information on recycling or proper disposal, consult your local solid waste collection or disposal organization.

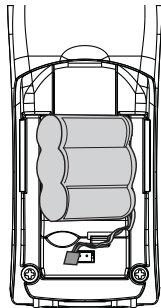

1. Use only VTech rechargeable battery pack, or equivalent.
2. Do not dispose of the battery pack in a fire. The cell may explode.
3. Do not open or mutilate the battery pack. Released electrolyte is corrosive and may cause damage to the eyes or skin. It may be toxic if swallowed.
4. Exercise care in handling batteries in order not to short the battery with conducting materials such as rings, bracelets, and keys. The battery pack or conductor may overheat and cause burns.

To purchase replacement battery packs, call VTech at 1-800-595-9511. In Canada, call 1-800-267-7377.

SETTING UP YOUR 9127

1. Plug the AC adaptor into an electrical outlet, and the AC connector to the bottom of the Base Unit. If the Handset battery pack has not been charged previously, place the Handset in the Base Unit cradle, and allow it to charge for 16 hours.
2. Connect the telephone line cord to the jack on the bottom of the Base Unit, and the other end to the wall jack.

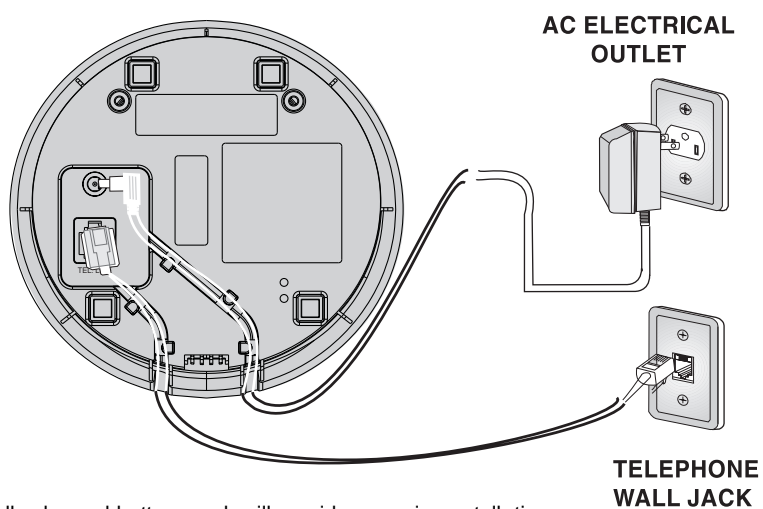

A fully charged battery pack will provide a maximum talk time of 4.5 hours, with a maximum standby (off cradle) time of 6 days.

SETTING UP YOUR 9127

RINGER SELECTION

1. Press **PROG/CHAN**.
2. Press **▲** or **▼** until the screen displays **RINGER:** and the current setting.
3. Press **SELECT**. The current selection will flash, and you will hear a sample of the selected ring.
4. Press **▲** or **▼** to select a different ring style (there are 4), or turn the ringer **OFF**.
5. Press **SELECT** to confirm your choice.



RINGER: 1

NOTE: If the ringer is set to OFF, the display will show "RINGER OFF" in idle mode.

TONE/PULSE SELECTION

NOTE: Your 9127 is factory-preset for **TONE** dialing.

1. To change dialing mode, press **PROG/CHAN**.
2. Press **▲** or **▼** until the screen displays **DIAL MODE:** and the current setting.
3. Press **SELECT**. The current setting is flashing.
4. Press **▲** or **▼** to change the setting.
5. Press **SELECT** to confirm your choice.



DIAL MODE: TONE

THE HANDSET DISPLAY

If the display says:

NEW 01 OLD 03

It means:

The Handset is in idle mode

*** RINGING ***

Indicates incoming call

CONNECTING...

Waiting for dial tone

PHONE

Handset is in use

MESSAGES WAITING

New messages have been received in your Voicemail service

BASIC OPERATION

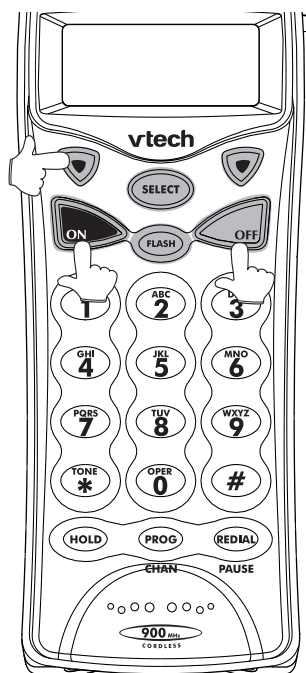

MAKING CALLS

Method 1-----Live Dialing

Press **ON**. Dial the phone number.



Press **OFF** to end your call.



Method 2-----Pre-dialing



Dial the phone number. Use the  key to backspace if you make a dialing mistake. Then press **ON**.

Press **OFF** to end your call.

When the Handset is in use, the **IN USE/CHARGING** light on the Base Unit will flash. When the Handset is in the Base Unit cradle, the **IN USE/CHARGING** light glows steadily.

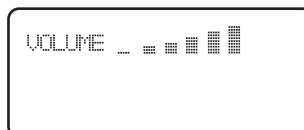
VOLUME CONTROL



While you are on a call, press  to raise the inbound volume and  to lower it. The Handset will display the relative volume setting as you adjust it. When you reach the maximum or minimum volume setting, you will hear a double beep.

CHANNEL CHANGING



If you experience noise or interference while on a call, you may be too far from the Base Unit, or in an obstructed area. Try moving to a different location. If this does not improve the transmission, press **PROG/CHAN**. You can press this key more than once, if necessary.

NOTE: This feature only operates while you are on an active call.

BASIC OPERATION

USING REDIAL

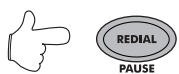

1. Press **ON**. Listen for dial tone.
2. Press **REDIAL/PAUSE**. The last number you called will automatically be redialed.

OR

1. Press **REDIAL**. The number will appear on the display.
2. Press **ON**.

NOTE: If you press **REDIAL** twice, the redial number will be deleted.

ANSWERING CALLS

To answer a call, press **any** key other than the **OFF** key.

During an incoming call, to temporarily mute the ringing, press **OFF**.
(Note: This feature is not available when the Handset is in its cradle.)

FLASH



When you receive a *Call Waiting* alert, press **FLASH** to switch to the incoming call.

Press **FLASH** again to return to the first call.

BASIC OPERATION

HOLD



To place your call on hold, press **HOLD**. Press **HOLD** again to return to your call.



HOLD

NOTE: If you have a call on hold, and then pick up an extension connected to the same line, your **9127** will automatically drop the call and return to idle mode.

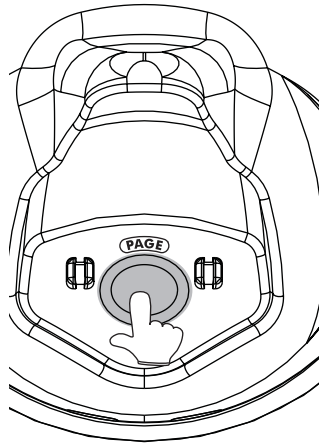

PAGE

The Base can signal the Handset by means of the PAGE key. This is helpful in locating a misplaced Handset. Press **PAGE** at the Base. The Handset will generate a series of tones (different than inbound call ringing) for a maximum of **60** seconds, and will display:



** PAGING **

Press **PAGE** at the Base or **OFF** key on the Handset to end the Page.

CALLER ID/CALL WAITING ID

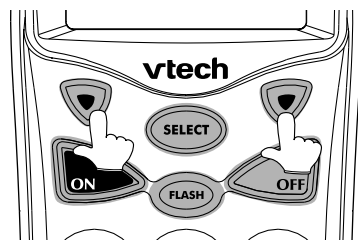

NOTE: Caller ID and Call Waiting ID are subscription services, provided by your regional phone company. You must subscribe to these services in order to benefit from the Caller ID features of your **9127**. Contact your regional phone service provider for details.

RECEIVING AND STORING CALLS

As new Caller ID/Call Waiting ID records are received, **NEW** followed by the number of new Caller ID records received will be displayed on the Handset.



NEW 01 OLD 01

Your **9127** will store the most current **50** Caller ID and Call Waiting ID records. When Caller ID information comes in with the inbound ring, it is displayed until the call is answered. When Call Waiting ID information comes in, it is displayed for approximately 15 seconds.

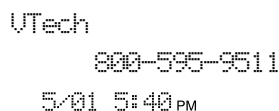

UTech
800-595-9511
5/01 5:40 PM

ABOUT CALLER ID

This phone assigns each incoming call a number from 1 to 50. The most recent call will have the highest number. When the memory is full, the oldest call information is deleted to make room for new incoming call information. Therefore, you do not have to delete Caller ID records manually.



For each call that comes in, the screen displays the following information between the first and second rings:

- Your caller's name (15 letters are sent by your telephone company);
- The caller's area code and telephone number;
- The time and date of the call.

If you answer a call before the information appears on the screen, it will not be in the call history.

NOTE: Press **OFF** at any time to exit Caller ID review mode.

REVIEW CALLER ID

1. Press  to view Caller ID.
2. Use  and  to scroll through records in call history.

CALLER ID/CALL WAITING ID

DELETING RECORDS FROM CALL HISTORY

NOTE: You can only delete all calls if all caller ID records have been previously viewed.

DELETE A SPECIFIC CALL

1. Locate the record you want to delete from call history.
2. Press **SELECT**, then press **▼** until **ERASE** flashes.
3. Press **SELECT**. The screen displays **ERASE NO YES ALL** and the phone number. The current choice flashes.
4. Press **▼** until **YES** flashes.
5. Press **SELECT**. You'll hear a series of beeps confirming the deletion.

```
DIAL PGM ERASE
800-595-9511
5/01 5:40PM OLD.28
```

DELETE ALL CALLS

1. While viewing call history, press **SELECT**, then press **▼** until **ERASE** flashes.
2. Press **SELECT**. The screen displays **ERASE NO YES ALL** and the phone number. The current choice flashes.
3. Press **▼** until **ALL** flashes, then press **SELECT**. The screen displays **ERASE ALL NO YES**. The current choice flashes.
4. Press **▼** until **YES** flashes.
5. Press **SELECT**. You will hear a series of beeps confirming the deletion.

```
DIAL PGM ERASE
800-595-9511
5/01 5:40PM OLD.28
```

DIAL A DISPLAYED NUMBER

1. Locate the record in call history that you want to dial.
2. If you wish to change how the number is dialed, press **#**. The screen displays any alternate dialing sequences available for this call (area code + number; 1+ area code + number; number only; 1+ number).
3. Press **SELECT**. **DIAL** will be flashing.
4. Press **SELECT** again to dial. -OR- After completing step 2, press **ON** to dial.

```
DIAL PGM ERASE
800-595-9511
5/01 5:40PM OLD.28
```

STORE A CALLER ID RECORD IN PHONE BOOK MEMORY

1. Use the **▼** key to locate the desired CID record.
2. If you wish to change how the number is stored, press **#**. The screen displays any alternate dialing sequence available for this call (area code + number; 1+ area code + number; number only; 1+ number).
3. Press **SELECT**, then press **▼** until **PGM** flashes.
4. Press **SELECT**. You can now edit the **NAME** if you wish. Press **▼** to backspace in order to edit the name. Use **▶** to advance and add a space.

```
DIAL PGM ERASE
800-595-9511
5/01 5:40PM OLD.28
```

CALLER ID/CALL WAITING ID

5. Press **SELECT**. You can now edit the PHONE NUMBER. Press **▼** to backspace in order to edit the phone number.
6. Press **SELECT**. Your CID record is now in your Phone Book directory.

DISPLAY SCREEN MESSAGES



Screen Display:	When:
BLOCKED NAME	The other party is blocking name information.
BLOCKED CALLER	The other party is blocking name and number information.
UNKNOWN NAME	Your phone company is unable to receive information about this caller's name.
UNKNOWN CALLER	Your phone company is unable to receive information about this caller's name and number.
Err	There is a problem with Caller ID transmission from the telephone company.

PHONE BOOK

This cordless phone can store 20 telephone numbers with names, each up to 16 digits long. Entries are stored alphabetically. For consistency with Caller ID entries, you may wish to enter last names first.

Note: Press **OFF** at any time to exit memory.

STORE MEMORY NUMBERS

1. Press **PROG/CHAN**. The screen displays **DIRECTORY**.
2. Press **SELECT**. The screen displays **ENTER NAME**.
3. Using the chart below, enter up to 15 characters for the name you're storing with the number. Use  to backspace and make corrections; use  to advance and add a space.

Dial Key	Presses					
	1	2	3	4	5	6
1	1					
2	A	B	C	2		
3	D	E	F	3		
4	G	H	I	4		
5	J	K	L	5		
6	M	N	O	6		
7	P	Q	R	S	7	
8	T	U	V	8		
9	W	X	Y	Z	9	
0	0					
*	*					
#	&	'	,	-	.	#

4. When you finish entering the name, press **SELECT**. The screen displays **ENTER NUMBER**.
5. Enter the telephone number. Use  to backspace and make a correction. Press **REDIAL/PAUSE** to store a pause in the dialing sequence.
6. Press **SELECT** to store your entry. The screen displays **SAVING...** and you'll hear a series of beeps confirming the entry.

Note: When memory is full the screen displays **MEMORY FULL**, an error tone sounds, and you will not be able to store a new number until you delete a stored number.

PHONE BOOK

EDIT NUMBERS STORED IN MEMORY

1. Press **▼**. The screen displays **DIRECTORY**.
2. Press **▲** or **▼** to scroll alphabetically through numbers stored in memory
-OR-
Press the dial pad key for the first letter of the entry you want to edit.
3. When the screen displays the number you want to edit, press **SELECT**. Then press **▼** until **EDIT** flashes.
4. Press **SELECT**. The screen displays the name and number. The flashing cursor appears at the end of the name. Use **▲**, **▼** and the dial pad keys to edit the name. Press **SELECT** to move on to edit the number.
5. Press **SELECT** to save the edited information. You'll hear a series of beeps confirming the change.



DIAL EDIT ERASE
8005959511

DELETE NUMBERS STORED IN MEMORY

1. Press **▼**. The screen displays **DIRECTORY**.
2. Press **▲** or **▼** to scroll alphabetically through numbers stored in memory
-OR-
Press the dial pad key for the first letter of the entry you want to delete.
3. When the screen displays the number you want to delete, press **SELECT**. Then press **▼** until **ERASE** flashes.
4. Press **SELECT**. The screen displays **ERASE NO YES** and the number. The current choice flashes.
5. Press **▼** until **YES** flashes.
6. Press **SELECT**. You'll hear a series of beeps confirming the deletion.



DIAL EDIT ERASE
8005959511

DIAL MEMORY NUMBERS

1. Press **▼**. The screen displays **DIRECTORY**.
2. Press **▲** or **▼** to scroll alphabetically through numbers stored in memory
-OR-
Press the dial pad key for the first letter of the entry you want to dial.
3. When the screen displays the number you want to dial, press **ON**. **-OR-**
When the screen displays the number you want to dial, press **SELECT**, then press **▲** or **▼** until **DIAL** flashes. Press **SELECT** to dial.



DIAL EDIT ERASE
8005959511

MESSAGE WAITING

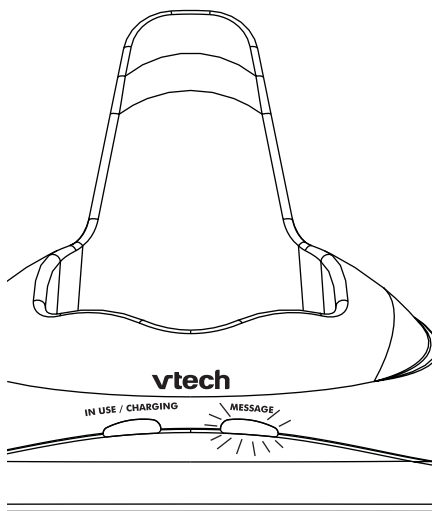

Your **9127** is capable of detecting a Visual Message Waiting signal, generated by many phone service providers. If you subscribe to VoiceMail service from your local telephone company, and a Visual Message Waiting Signal is provided, the Handset will display **MESSAGES WAITING** and the Base Unit **MESSAGE** light will glow to alert you to new, unplayed messages.

MESSAGES WAITING

Once you have reviewed all of your new messages the indicators will go out.

However, if necessary, it is possible to turn the Message Waiting indicators OFF manually:

1. Press **PROG/CHAN**.
2. Press **▼** or **▲** until **MESSAGES WAITING** is displayed.
3. Press **SELECT**. The Handset will display:
4. Press **▼** or **▲** to toggle between **NO** and **YES**.
5. With **YES** flashing, press **SELECT**. You will hear a tone confirming your choice.

LIGHT OFF: YES

OPTIONAL HEADSET INSTALLATION

Your **9127** cordless telephone is equipped with a 2.5mm Headset Jack for use with an **optional** accessory Headset for hands-free operation.

If you choose to use the Headset option, you must do the following:



INSTALLATION

- * Obtain an optional accessory Headset, which is compatible with the **9127**.

Please contact **VTECH Communications Customer Service**, in the U.S. toll-free at **1-800-595-9511**. In Canada, call **1-800-267-7377** for dealer information in your local area. You can also purchase a compatible Headset directly from VTECH Communications Customer Service.

- * Once you have a compatible 2.5mm Headset, locate the Headset Jack on the Handset of your **9127**. Connect the plug on the Headset to the jack on the cordless Handset (under a small rubber flap). The plug should fit securely. Do not force the connection. See illustration.

OPERATION

NOTE: Whenever a compatible Headset is connected to the cordless Handset, the microphone on the Handset will be **MUTED**. This is done to limit the effect of background noise.



BELT CLIP

- * The **9127** is also equipped with a detachable belt clip. Align the pins on the inside edge of the belt clip with the notches on the side of the **9127** Handset. The belt clip should snap securely into place. Do not force the connection. See illustration.
- * To remove the belt clip, pry it away from either side, where the pins are secured in the Handset notches. **Do NOT pull up from the bottom of the clip!!!**

MAINTENANCE

TAKING CARE OF YOUR TELEPHONE

Your cordless telephone contains sophisticated electronic parts, so it must be treated with care.

AVOID ROUGH TREATMENT

Place the Handset down gently. Save the original packing materials to protect your telephone if you ever need to ship it.

AVOID WATER

Your telephone can be damaged if it gets wet. Do not use the Handset outdoors in the rain, or handle it with wet hands. Do not install your Base Unit near a sink, bathtub or shower.

ELECTRICAL STORMS

Electrical storms can sometimes cause power surges harmful to electronic equipment. For your own safety, use caution when using electric appliances during storms.

CLEANING YOUR TELEPHONE

Your telephone has a durable plastic casing that should retain its luster for many years. Clean it only with a soft cloth slightly dampened with water or a mild soap. Do not use excess water or cleaning solvents of any kind.

Remember that electrical appliances can cause serious injury if used when you are wet or standing in water. If your Base Unit should fall into water, **DO NOT RETRIEVE IT UNTIL YOU UNPLUG THE POWER CORD AND TELEPHONE LINE CORDS FROM THE WALL.** Then pull the unit out by the unplugged cords.

IN CASE OF DIFFICULTY

If you have difficulty operating your phone, the suggestions below should solve the problem. If you still have difficulty after trying these suggestions,

In the US call:

VTECH COMMUNICATIONS at 1-800-595-9511.

In Canada call:

VTECH ELECTRONICS at 1-800-267-7377.

THE PHONE DOESN'T WORK AT ALL.

- Make sure the power cord is plugged in.
- Make sure the telephone line cord is plugged firmly into the base unit and the telephone wall jack.
- Make sure the batteries are properly charged. If the Battery Low indicator is on, the battery needs charging. If the LCD display shows "**NEEDS RECHARGING**", you must charge the batteries.
- If you recently installed a new battery pack, make sure it is installed correctly.



NEEDS RECHARGING

NO DIAL TONE.

- First check all the suggestions above.
- If you still don't hear a dial tone, disconnect the Base Unit from the telephone jack and connect a different phone. If there is no dial tone on that phone either, the problem is in your wiring or local service. Call your local telephone company.

YOU GET NOISE, STATIC, OR A WEAK SIGNAL EVEN WHEN YOU'RE NEAR THE BASE UNIT.

- Place the Handset in the Base momentarily to re-set the unit. Then press **ON** to get a line.
- Household appliances plugged into the same circuit as the Base Unit can sometimes cause interference. Try moving the appliance or the base unit to another outlet.

YOU GET NOISE, STATIC, OR A WEAK SIGNAL WHEN YOU'RE AWAY FROM THE BASE UNIT.

- You may be out of range. Either move close to the Base, or relocate the Base Unit.
- The layout of your home may be limiting the range. Try moving the Base Unit to the second or third floor, or to some other location.

IN CASE OF DIFFICULTY

THE HANDSET DOES NOT RING WHEN YOU RECEIVE A CALL.

- Ensure that the ringer is turned on.
- Make sure the telephone line cord is plugged firmly into the Base Unit and the telephone jack. Make sure the power cord is plugged in.
- You may be too far from the Base Unit.
- You may have too many extension phones on your telephone line to allow all of them to ring. Try unplugging some of the other phones.

YOUR CALLER FADES IN AND OUT.

- You may be nearly out of range. Move closer, or relocate the Base.

YOU HEAR OTHER CALLS WHILE USING YOUR PHONE.

- Press **PROG/CHAN** key to switch to another channel.
- Disconnect your Base unit from the telephone jack, and plug in a regular telephone. If you still hear other calls, the problem is probably in your wiring or local service. Call your local telephone company.

YOU HEAR NOISE IN THE HANDSET, AND NONE OF THE KEYS OR BUTTONS WORK.

- Make sure the power cord is plugged in.
- Your Base Unit and Handset may not be operating on the same channel. Place the Handset in the cradle for a few moments to reset the channel.

COMMON CURE FOR ELECTRONIC EQUIPMENT

Electronics, like people, can sometimes get confused. If the unit does not seem to be responding normally, then try putting the Handset in the cradle to re-initialize the unit. If it still does not seem to respond, perform the following steps (in the order listed):

1. Disconnect the power to the Base.
2. Disconnect (remove) the Handset battery.
3. Wait a few minutes.
4. Connect power to the Base.
5. Install the Handset battery pack.
6. Put the Handset in the Base to re-initialize. If the Handset has not been recently charged, allow 16 hours before use.

LIMITED WARRANTY

What does this limited warranty cover?

- The manufacturer of this **VTECH** product, **VTECH Communications**, warrants to the holder of a valid proof of purchase (“Consumer” or “you”) that the product and all accessories provided by **VTECH** in the sales package (“Product”) are free from material defects in material and workmanship, pursuant to the following terms and conditions, when installed and used normally and in accordance with operation instructions. This limited warranty extends only to the Consumer for Products purchased and used in the United States of America.

What will VTECH Communications do if the Product is not free from material defects in materials and workmanship during the limited warranty period (“Materially Defective Product”)?

- During the limited warranty period, **VTECH’s** authorized service representative will repair or replace, at **VTECH’s** option, without charge, a Materially Defective Product. If we repair this product, we may use new or refurbished replacement parts. If we choose to replace this product, we may replace it with a new or refurbished product of the same or similar design. **VTECH** will return repaired or replacement products to you in working condition. **VTECH** will retain defective parts, modules, or equipment. Repair or replacement of Product, at **VTECH’s** option, is your exclusive remedy. You should expect the repair or replacement to take approximately 30 days.

How long is the limited warranty period?

- The limited warranty period for the product extends for ONE (1) YEAR from the date of purchase.
If we repair or replace a Materially Defective Product under the terms of this limited warranty, this limited warranty also applies to repaired or replacement Products for a period of either (a) 90 days from the date the repaired or replacement Product is shipped to you or (b) the time remaining on the original one-year limited warranty, whichever is longer.

What is not covered by this limited warranty?

This limited warranty does not cover:

1. Product that has been subjected to misuse, accident, shipping or other physical damage, improper installation, abnormal operation or handling, neglect, inundation, fire, water, or other liquid intrusion; or
2. Product that has been damaged due to repair, alteration, or modification by anyone other than an authorized service representative of VTECH; or
3. Product to the extent that the problem experienced is caused by signal conditions, network reliability or cable or antenna systems; or
4. Product to the extent that the problem is caused by use with non- VTECH electrical accessories; or
5. Product whose warranty/quality stickers, Product serial numbers plates or electronic serial numbers have been removed, altered or rendered illegible; or
6. Product purchased, used, serviced, or shipped for repair from outside the United States, or used for commercial or institutional purposes (including but not limited to Products used for rental purposes); or
7. Product returned without valid proof of purchase (see 2 below); or
8. Charges for installation or set up, adjustment of customer controls, and installation or repair of systems outside the unit.

LIMITED WARRANTY

How do you get warranty service?

- To obtain warranty service in the United States of America, call 1-800-595-9511 for instructions regarding where to return the Product. Before calling for service, please check the user's manual. A check of the Product controls and features may save you a service call.
- Except as provided by applicable law, you assume the risk of loss or damage during transit and transportation and are responsible for delivery or handling charges incurred in the transport of Product(s) to the service location. **VTECH** will return repaired or replaced Product under this limited warranty to you, transportation, delivery or handling charges prepaid. **VTECH** assumes no risk for damage or loss of the Product in transit.
- If the Product failure is not covered by this limited warranty, or proof of purchase does not meet the terms of this limited warranty, **VTECH** will notify you and will request that you authorize the cost of repair prior to any further repair activity. You must pay for the cost of repair and return shipping costs for the repair of Products that are not covered by this limited warranty.

What must you return with the Product to get warranty service?

You must:

1. Return the entire original package and contents including the Product to the **VTECH** service location along with a description of the malfunction or difficulty;
2. Include "valid proof of purchase" (sales receipt) identifying the Product purchased (Product model) and the date of purchase or receipt; and
3. Provide your name, complete and correct mailing address, and telephone number.

Other limitations

- This warranty is the complete and exclusive agreement between you and **VTECH**. It supersedes all other written or oral communications related to this Product. **VTECH** provides no other warranties for this product. The warranty exclusively describes all of **VTECH's** responsibilities regarding the product. There are no other express warranties. No one is authorized to make modifications to this limited warranty and you should not rely on any such modification.

State Law Rights: This warranty gives you specific legal rights, and you may also have other rights which vary from state to state.

Limitations:

Implied warranties, including those of fitness for a particular purpose and merchantability (an unwritten warranty that the product is fit for ordinary use) are limited to one year from date of purchase.

Some states do not allow limitations on how long an implied warranty lasts, so the above limitation may not apply to you.

- In no event shall **VTECH** be liable for any indirect, special, incidental, consequential, or similar damages (including, but not limited to lost profits or revenue, inability to use the product, or other associated equipment, the cost of substitute equipment, and claims by third parties) resulting from the use of this product.

Some states do not allow the exclusion or limitation of incidental or consequential damages, so the above limitation or exclusion may not apply to you.

FCC, ACTA AND IC REGULATIONS

This equipment complies with Parts 15 of the Federal Communications Commission (FCC) rules for the United States. It also complies with regulations RSS210 and CS-03 of Industry and Science Canada. Operation is subject to the following two conditions: (1) this device may not cause interference, and (2) this device must accept any interference, including interference that may cause undesired operation of the device.

A label is located on the underside of the Base Unit containing either the FCC registration number and Ringer Equivalence Number (REN) or the IC registration number and Load Number. You must, upon request, provide this information to your local telephone company.

This equipment is compatible with inductively coupled hearing aids.

Should you experience trouble with this telephone equipment, please contact:

VTech Communications Inc

CUSTOMER SERVICE, at 1-800-595-9511. In Canada, call VTECH Telecommunications at 1-800-267-7377.

For repair/warranty information, the telephone company may ask you to disconnect this equipment from the line network until the problem has been corrected.

FCC Part 15

Warning: Changes or modifications to this unit not expressly approved by the party responsible for compliance could void the user's authority to operate the equipment.

The equipment has been tested and found to comply with part 15 of the FCC rules. These limits are designed to provide reasonable protection against harmful interference in a residential installation. This equipment generates, uses and can radiate radio frequency energy and, if not installed and used in accordance with the instructions, may cause harmful interference to radio communications. However, there is no guarantee that interference will not occur in a particular installation. If this equipment does cause harmful interference to radio or television reception, which can be determined by turning the equipment off and on, the user is encouraged to try and correct the interference by one or more of the following measures:

- Reorient or relocate the receiving antenna.
- Increase the separation between the equipment and receiver.
- Connect the equipment into an outlet or on a circuit different from that to which the receiver is connected.
- Consult the dealer or an experienced radio/TV technician for help.

FCC Part 68 and ACTA

If this equipment was approved for connection to the telephone network prior to July 23, 2001, it complies with Part 68 of the Federal Communications Commission (FCC) rules. If the equipment was approved after that date, it complies with the Part 68 rules and with Technical Requirements for Connection of Equipment to the Telephone Network adopted by the Administrative Council for Terminal Attachments (ACTA). We are required to provide you with the following information.

1. Product identifier and REN information

The label on the back or bottom of this equipment contains, among other things, an identifier indicating product approval and the Ringer Equivalence Number (REN). This information must be provided to your local telephone company upon request. For equipment approved prior to July 23, 2001, the product identifier is preceded by the phrase "FCC Reg No." and the REN is listed separately. For equipment approved after that date, the product identifier is preceded by "US" and a colon (:), and the REN is encoded in the product identifier without a decimal point as the sixth and seventh characters following the colon. For example, the product identifier US:AAAEQ03T123XYZ would indicate an REN of 0.3.

The REN is used to determine how many devices you may connect to your telephone line and still have them ring when you are called. In most, but not all areas, the sum of all RENs

FCC, ACTA AND IC REGULATIONS

should be five (5.0) or less. You may want to contact your local telephone company for more information.

2. Connection and use with the nationwide telephone network

The plug and jack used to connect this equipment to the premises wiring and the telephone network must comply with the applicable Part 68 rules and technical requirements adopted by ACTA. A compliant telephone cord and modular plug is provided with this product. It is designed to be connected to a compatible modular jack that is also compliant. An RJ11 jack should normally be used for connecting to a single line and an RJ14 jack for two lines. See Installation Instructions in the user's manual. This equipment may not be used with Coin Telephone Lines or with Party Lines. If you have specially wired alarm dialing equipment connected to your telephone line, ensure the connection of this equipment does not disable your alarm equipment. If you have questions about what will disable alarm equipment, consult your telephone company or a qualified installer.

3. Repair instructions

If this equipment is malfunctioning, it must be unplugged from the modular jack until the problem has been corrected. Repairs to this telephone equipment can only be made by the manufacturer or its authorized agents. For repair procedures, follow the instructions outlined under the Limited Warranty.

4. Rights of the telephone company

If this equipment is causing harm to the telephone network, the telephone company may temporarily discontinue your telephone service. The telephone company is required to notify you before interrupting service. If advance notice is not practical, you will be notified as soon as possible. You will be given the opportunity to correct the problem and the telephone company is required to inform you of your right to file a complaint with the FCC. Your telephone company may make changes in its facilities, equipment, operation, or procedures that could affect the proper functioning of this product. The telephone company is required to notify you if such changes are planned.

5. Hearing aid compatibility

If this product is equipped with a corded or cordless Handset, it is hearing aid compatible.

6. Programming/testing of emergency numbers

If this product has memory dialing locations, you may choose to store police, fire department and emergency medical service telephone numbers in these locations. If you do, please keep three things in mind:

- a We recommend that you also write the telephone number on the directory card, so that you can still dial the emergency number manually if the memory dialing feature doesn't work.
- b This feature is provided only as a convenience, and the manufacturer assumes no responsibility for customer reliance upon the memory feature.
- c Testing the emergency telephone numbers you have stored is not recommended. However, if you do make a call to an emergency number:
 - You must remain on the line and briefly explain the reason for the call before hanging up.
 - Programming/testing of emergency numbers should be performed during off-peak hours, such as in the early morning or late evening, when the emergency services tend to be less busy.

IC (Industry Canada)

This telephone is registered for use in Canada.

The term "IC:" before the radio certification number only signifies that Industry Canada technical specifications were met.

Notice:

FCC, ACTA AND IC REGULATIONS

This equipment meets the applicable Industry Canada Terminal Equipment Technical Specifications. This is confirmed by the registration number. The abbreviation, IC, before the registration number signifies that registration was performed based on a Declaration of Conformity indicating that Industry Canada technical specifications were met. It does not imply that Industry Canada approved the equipment.

Notice:

The Ringer Equivalence Number (REN) for this terminal equipment is 0.1. The REN assigned to each terminal equipment provides an indication of the maximum number of terminals allowed to be connected to a telephone interface. The termination on an interface may consist of any combination of devices subject only to the requirement that the sum of the Ringer Equivalence Numbers of all the devices does not exceed five.

Before installing this equipment, users should ensure that it is permissible to be connected to the facilities of the local telecommunications company. The equipment must also be installed using an acceptable method of connection. The customer should be aware that compliance with the above conditions may not prevent degradation of services in some situations.

Repairs to certified equipment should be made by an authorized Canadian maintenance facility designated by the supplier. Any repairs or alterations made by the user to this equipment, or equipment malfunctions, may give the telecommunications company cause to request the user to disconnect the equipment.

Users should ensure for their own protection that the electrical ground connections of the power utility, telephone lines and internal metallic water pipe system, if present, are connected together. This precaution may be particularly important in rural areas.

Caution :

Users should not attempt to make such connections themselves, but should contact the appropriate electrical inspection authority, or electrician, as appropriate.

Your 9127 is designed to operate at the maximum power allowed by the FCC and IC. This means your Handset and Base Unit can communicate only over a certain distance - which will depend on the location of the Base Unit and Handset, weather, and the construction and layout of your home or office.

RBRC™ Seal



The **RBRC**® Seal on the nickel-cadmium battery contained in our product indicates that VTECH Communications, Inc. is voluntarily participating in an industry program to collect and recycle these batteries at the end of their useful lives, when taken out of service within the United States and Canada. The **RBRC**® program provides a convenient alternative to placing used nickel-cadmium batteries into the trash or municipal waste, which may be illegal in your area.

VTECH's partnership with **RBRC**® makes it easy for you to drop off the spent battery at local retailers participating in the **RBRC**® program or at authorized VTECH product service centers. Please call **1-800-8-BATTERY** for information on Ni-Cd battery recycling and disposal bans/restrictions in your area. VTECH's involvement in this program is part of its commitment to protecting our environment and conserving natural resources.

RBRC® is a registered trademark of Rechargeable Battery Recycling Corporation.

TECHNICAL SPECIFICATIONS

FREQUENCY CONTROL

Crystal Controlled Dual PLL Synthesizer

TRANSMIT FREQUENCY

Handset:

923.10 MHz to 927.75 MHz
(All 30 channels within this range)

Base Unit:

902.30 MHz to 906.65 MHz
(All 30 channels within this range)

RECEIVE FREQUENCY

Handset:

902.30 MHz to 906.65 MHz
(All 30 channels within this range)

Base Unit:

923.10 MHz to 927.75 MHz
(All 30 channels within this range)

NOMINAL EFFECTIVE RANGE

Maximum power allowed by FCC and IC.
Actual operating range may vary according to environmental conditions at the time of use.

SIZE

Handset:

191(L) x 55.5(W) x 39.5(H)mm
Maximum (Antenna included)

Base Unit:

125(L) x 120(W) x 97.5(H)mm
Maximum (Antenna included)

WEIGHT

Handset:

141 grams

Base Unit:

151 grams

POWER REQUIREMENTS

Handset:

Self-contained nickel-cadmium rechargeable battery pack, 3.6V nominal, 300mAh capacity.

Base Unit:

9VAC @ 250mA

MEMORY

Phone Book:

20 Memory locations
16 digits and 15 characters per location.

CID:

Alphanumeric Display
50 Memory locations

**SPECIFICATIONS ARE TYPICAL AND
MAY CHANGE WITHOUT NOTICE.**



vtech

VTECH TELECOMMUNICATIONS LTD.

vtech A member of THE VTECH GROUP OF COMPANIES.

Distributed in the U.S.A. by VTech Communications Inc, Beaverton, Oregon, 97008

Distributed in the Canada by VTech Electronics Canada Ltd., Suite 200-7671 Alderbridge Way Richmond, B.C. V6X 1Z9.

Copyright 2003 for VTECH TELECOMMUNICATIONS LTD.
Printed in China

91-005384-040-000
ISSUED 0

Free Manuals Download Website

<http://myh66.com>

<http://usermanuals.us>

<http://www.somanuals.com>

<http://www.4manuals.cc>

<http://www.manual-lib.com>

<http://www.404manual.com>

<http://www.luxmanual.com>

<http://aubethermostatmanual.com>

Golf course search by state

<http://golfingnear.com>

Email search by domain

<http://emailbydomain.com>

Auto manuals search

<http://auto.somanuals.com>

TV manuals search

<http://tv.somanuals.com>