

**900MHz
ANALOG CORDLESS PHONE
WITH SPEAKERPHONE AND DUAL KEYPAD
MODEL VTECH 917ADX**

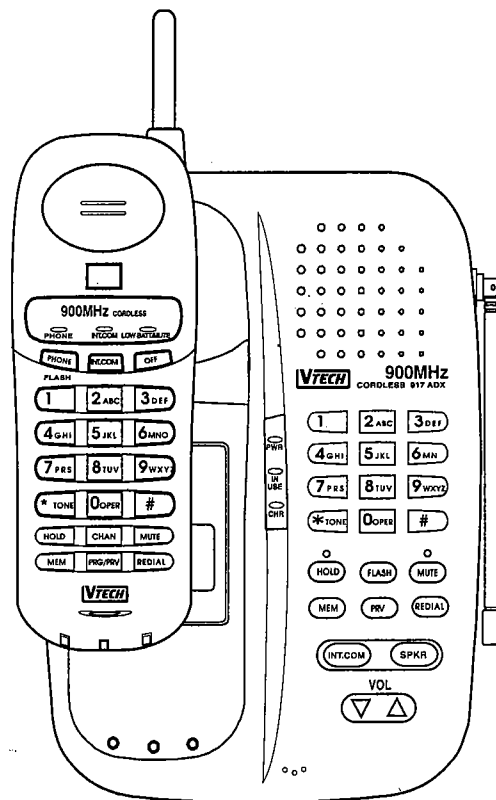

917 ADX

INSTRUCTION
Manual



VTECH COMMUNICATIONS LTD.

Distributed in the **U.S.A** by
VTECH Communications,
8770 SW Nimbus Avenue/Beaverton, Oregon, 97008

Distributed in **Canada** by
VTECH Electronics Canada Ltd.,
200-7671 Alderbridge Way, Richmond, B.C., V6X1Z9

Copyright 1997 for
VTECH COMMUNICATIONS LTD.

IMPORTANT:
*BEFORE USING YOUR NEW PHONE
WE STRONGLY RECOMMEND YOU
READ THIS MANUAL THOROUGHLY*



VTECH COMMUNICATIONS LTD.

Table Of Contents

INTRODUCTION	3
PARTS CHECK LIST	4
IMPORTANT SAFETY INSTRUCTIONS	5
THE HANDSET BATTERY PACK	7
GETTING STARTED	9
SETTING UP YOUR VTech 917 ADX	9
WALL MOUNTING	10
HANDSET FEATURES	12
PHONE LED	12
INT.COM LED	12
LOW BATT/MUTE LED	12
PHONE (FLASH) Key	12
INT.COM Key	12
OFF Key	12
HOLD Key	12
CHANNEL (CHAN) Key	13
MUTE Key	13
MEMORY (MEM) Key	13
PROGRAM/PRIVACY (PRG/PRV) Key	13
REDIAL Key	13
*TONE Key	13
VOLUME CONTROL SWITCH.....	13
HEADSET JACK (2.5 mm)	13
BASE UNIT FEATURES	14
POWER (PWR) LED	14
IN USE LED	14
CHARGE (CHR) LED	14
HOLD LED	14
MUTE LED	14
INTERCOM (INT.COM) LED	15
SPEAKERPHONE (SPKR) LED	15
RINGER SWITCH	15
TONE/PULSE SWITCH	15
HOLD Key	15
FLASH Key	15
MUTE Key	15
MEMORY (MEM) Key	15
PRIVACY (PRV) Key	15
REDIAL Key	16
INTERCOM (INT.COM) Key	16
SPEAKERPHONE (SPKR) Key	16
VOLUME UP Key	16
VOLUME DOWN Key	16
*TONE Key	16

Table Of Contents

OPERATING INSTRUCTIONS	17
MAKING CALLS	17
ANSWERING CALLS	18
TO PUT A CALL ON HOLD	17
THE MUTE FEATURE	17
SWITCHING TO THE HANDSET	17
SWITCHING TO THE SPEAKERPHONE	19
JOINING A HANDSET CONVERSATION	19
THE PRIVACY FEATURE	19
USING THE INTERCOM / HANDSET LOCATOR	20
IF YOUR PHONE RINGS DURING AN INTERCOM CONVERSATION	21
USING THE INTERCOM DURING A PHONE CALL	21
TEMPORARY TONE FEATURE	21
PROGRAMMING THE RINGER TYPE	21
TURNING OFF THE HANDSET RINGER	22
BASE RINGER CONTROL	22
CHECKING THE HANDSET RINGER	22
MEMORY DIALING	22
TO STORE A NUMBER INTO MEMORY	22
TO DIAL A NUMBER FROM MEMORY	22
TO CHANGE OR REPLACE A STORED NUMBER	23
STORING PAUSES IN MEMORY.....	23
USING REDIAL	24
STORING A REDIAL NUMBER IN MEMORY DIAL	24
CHANGING CHANNELS	24
OPTIONAL HEADSET INSTALLATION AND OPERATING INSTRUCTIONS	25
INSTALLATION	25
OPERATION	25
MAINTENANCE	27
IN CASE OF DIFFICULTY	28
WARRANTY STATEMENT	30
FCC & IC REGULATIONS	32
TECHNICAL SPECIFICATIONS	35

INTRODUCTION

Thank you for purchasing a **VTech** cordless telephone. This manual is designed to familiarize you with your **917 ADX**. To get the maximum use from your new phone, we suggest that you read this **Instruction Manual** before operating it.

Your **VTech 917 ADX** is a single line, 900 MHz, analog cordless phone with a Speakerphone and second keypad on the Base Unit. Each time the Handset is placed in the Base Unit, one of more than 65,000 Digital Security Codes is randomly selected. The Handset and Base Unit recognize each other based upon this security code. This minimizes the chance of another cordless phone accessing your telephone line. The Base Unit retains the current security code and channel in memory, even if it is unplugged.

Other special features are:

- 10 Number Speed Dial Memory
- 10 Channels of operation
- Automatic Channel Select
- Manual Channel Change on Handset
- Intercom between the Base Unit and Handset
- 2.5mm Jack on Handset for *optional* Headset use
- Belt Clip for Handset
- REDIAL feature
- Automatic release of line from HOLD when extension is picked up
- Programmable Ringer Types
- Low Battery Detect and Warning indication
- Hearing-Aid Compatible Handset
- Easy Answer - Press any key on the Handset to answer (other than OFF)
- Removable Battery Pack
- Tone and Pulse dialing
- Temporary Tone feature
- Handset & Speakerphone HOLD and MUTE

- Volume Control for Handset and Speakerphone
- FLASH feature
- Base Unit Ringer control (HIGH, LOW, OFF)
- Three-way conferencing between Caller, Handset and Speakerphone
- Privacy feature
- Long battery life (7 hours talk time/6 days standby)

INTRODUCTION

Parts Check List:

- Handset
- Base unit and AC adaptor
- Telephone line cord
- Battery pack
- Wall mounting bracket
- Belt clip

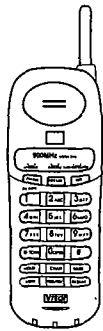

HANDSET

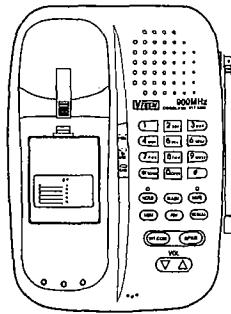

BASE UNIT

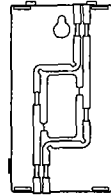

WALL MOUNTING BRACKET



BATTERY PACK

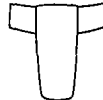

BELT CLIP

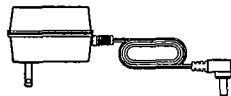

AC ADAPTOR



TELEPHONE LINE CORD

IMPORTANT SAFETY INSTRUCTIONS

When using your telephone, please follow these basic safety precautions to reduce the risk of fire, electric shock or injury to persons:

- Read and understand all instructions.
- Follow all warnings and instructions marked on the product.
- Unplug this product from the wall outlet before cleaning. Do not use liquid cleaners or aerosol cleaners. Use a damp cloth for cleaning.
- Do not use this product near water (for example, near a bath tub, kitchen sink, or swimming pool).
- Do not place this product on an unstable cart, stand, or table. The product may fall, causing serious damage to the product.
- Slots and openings in the cabinet and the back or bottom are provided for ventilation. To protect it from overheating, these openings must not be blocked by placing the product on a bed, sofa, rug, or other similar surface. This product should never be placed near or over a radiator or heat register. This product should not be placed in a built-in installation where proper ventilation is not provided.
- This product should be operated only from the type of power source indicated on the marking label. If you are not sure of the type of power supply to your home, consult your dealer or local power company.
- Do not allow anything to rest on the power cord. Do not locate this product where the cord will be abused by persons walking on it.
- Never push objects of any kind into this product through cabinet slots as they may touch dangerous voltage points or short out parts that could result in a risk of fire or electric shock. Never spill liquid of any kind on the product.
- To reduce the risk of electric shock, do not disassemble this product. If service or repair work is required, contact VTech Customer Service at 1-800-595-9511 in the U.S. and at 1-800-267-7377 in Canada. Opening or removing cabinet parts other than specified access doors may expose you to dangerous voltages or other risks. Incorrect reassembling can cause electric shock when the appliance is subsequently used.
- Do not overload wall outlets and extension cords as this can result in the risk of fire or electric shock.
- Unplug this product from the wall outlet :
 - When the power supply cord or plug is damaged or frayed.
 - If liquid has been spilled into the product.
 - If the product has been exposed to rain or water.
 - If the product does not operate normally by following the operating instructions. Adjust only those controls that are covered by the operating instructions, because improper adjustment of other controls may result in damage and will often require extensive work to restore the product to normal operation.
 - If the product has been dropped and the cabinet has been damaged.
 - If the product exhibits a distinct change in performance.
- Avoid using a telephone (other than a cordless type) during an electrical storm. There may be a remote risk of electric

IMPORTANT SAFETY INSTRUCTIONS

shock from lightning.

- Do not use the telephone to report a gas leak in the vicinity of the leak.

SAVE THESE INSTRUCTIONS

THE HANDSET BATTERY PACK

Charging the handset batteries :

■ The handset of your 917ADX cordless telephone is powered by a rechargeable battery pack. It charges automatically whenever the handset is in the base. You should charge the battery pack for 16 hours when you first receive your phone. You'll know the battery pack needs charging when:

- The phone emits a warning tone when you press the PHONE key.
- The LOW BATT/MUTE LED is slowly flashing.
- The handset seems completely dead, no lights are evident, and pressing keys does not generate a beep.

■ To charge the battery pack, place the handset in the base unit. The charge CHR indicator will light to show the handset is seated properly and the battery pack is charging. It is recommended that the battery pack be charged for at least 16 hours initially and 8 hours for maintenance charging. You can use your telephone before that with diminished capacity, but it is best to charge the battery pack fully. It will take several recharge cycles to maximize the charge capacity of your battery pack. The maximum battery life between charges is 7 hours of continuous talk time or 6 days of standby.

It's impossible to overcharge the battery pack

■ The battery pack can be recharged many times, but if you get a low-battery signal even after 8 hours of maintenance charging in the base cradle, the battery pack should be replaced.

To purchase replacement battery packs, call VTECH Communications at:
1-800-595-9511.
In Canada, call VTECH Electronics at:
1-800-267-7377.

THE HANDSET BATTERY PACK

- Remove the battery cover by pressing on the ridged lines and sliding downward.

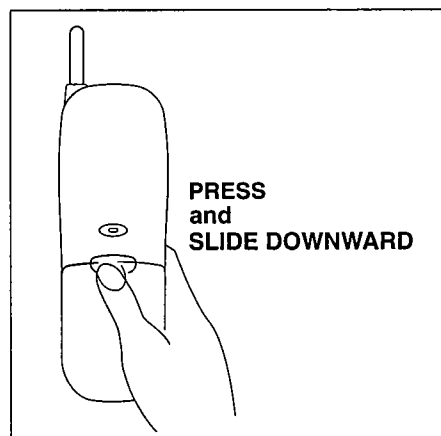

- Discard the old battery pack. Don't put the old battery pack in a trash compactor or a fire - it could burst.

IMPORTANT: Do not dispose of this battery in household garbage. For information on recycling or proper disposal, consult your local solid waste collection or disposal organization.

- Place the new battery pack in the battery compartment. Make sure the metal contacts on the underside of the battery are aligned with charging contacts in battery

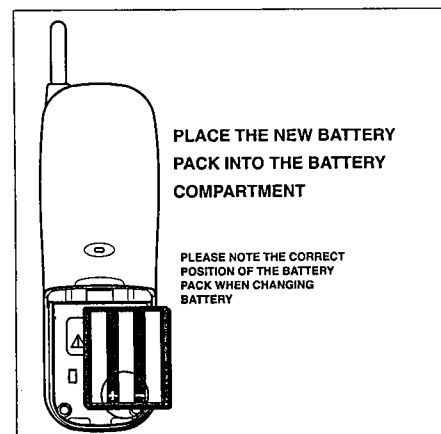

compartment.

- The new battery pack must be charged before using your telephone. Place the Handset in the cradle of the Base Unit to allow it to charge for 16 hours.

A Word About Rechargeable Batteries

Your Nicad battery pack recharges whenever the Handset is returned to the Base Unit.

To maximize the life of your battery pack, do not return your **917 ADX** Handset to the Base Unit cradle for recharging until the LOW BATT LED begins to flash.

CAUTION: To reduce the Risk of Fire or Injury to Persons, Read and Follow these Instructions:

- Use only VTECH battery.
- Do not open or mutilate the battery. Released electrolyte is corrosive and may cause damage to the eyes or skin. It may be toxic if swallowed.
- Exercise care in handling the battery pack in order not to short the battery with conducting materials such as rings, bracelets, and keys. The battery or conductor may overheat and cause burns.
- Do not dispose of the battery in a fire. The cell may explode.

To order replacement batteries, contact **VTech Customer Service at 1-800-595-9511** in the U.S. and contact **VTECH Electronics at 1-800-267-7377** in Canada.

GETTING STARTED

Setting Up Your VTech 917 ADX

- Choose an area near an electrical outlet and a telephone wall jack.

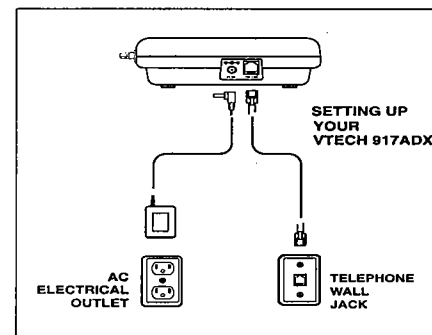

- Plug the AC power adaptor into an electrical outlet and the DC connector to the back of the Base Unit.

CAUTION: Use only the AC adaptor shipped with your **917 ADX**. This is a Class 2 AC adaptor, specifically designed for use with the **917 ADX**.

NOTE: Connect power to the Base Unit before placing the Handset in the cradle.

- Set the **TONE/PULSE** switch on the Base Unit. If you have touch tone service on your phone line, set the switch to **TONE**. If you have rotary service, set the switch to **PULSE**.
- Set the **RINGER** switch to HIGH, LOW or OFF on the side of the Base Unit.
- CHARGE THE HANDSET BATTERY PACK BEFORE USE.** The battery pack recharges automatically whenever the Handset is in the Base Unit cradle. The battery pack should be charged for 16

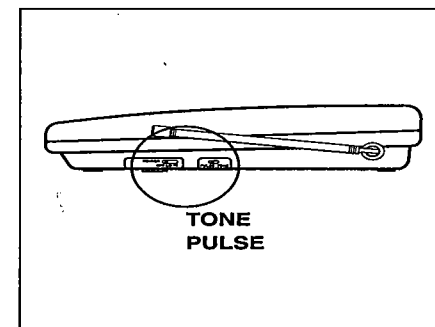

hours before using your phone for the first time.

- Connect the telephone line cord. Insert one end of the telephone line cord into the jack at the rear of the Base Unit. Plug the other end into a telephone wall jack. Make sure the plugs snap securely into place.
- CHECK FOR A DIAL TONE.** After the battery pack is charged, raise the Base Unit Antenna to an upright position. Then, pick up the Handset and press the **PHONE** key. The IN USE LED (on the Base Unit) and the PHONE LED (on the Handset) should light up, and you should hear a dial tone. If not, see **IN CASE OF DIFFICULTY**.

CAUTION:

- Never install telephone wiring during a lightning storm.
- Never install telephone jacks in wet locations unless the jack is specifically designed for wet locations.
- Never touch uninsulated telephone wires or terminals unless the telephone line has been disconnected at the network interface.
- Use caution when installing or modifying telephone lines.

WALL MOUNTING

The Wall Mount adaptor is designed to fit on standard Wall Mount plates.

- **Choose a spot near an electrical outlet and a telephone jack.** Your phone requires a modular telephone jack and a standard electrical outlet (120v AC). The power cord is six feet long; make sure there is an electrical outlet within reach of the base. The outlet should not be controlled by a wall switch. If the switch is ever turned off, the phone will not operate.

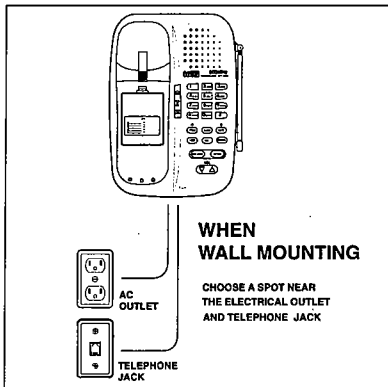

- **Position the wall mount adaptor on the base.** Line up the tabs on the wall mount adaptor with the holes on the bottom of the base. Snap the wall mount adaptor firmly in place.
- **Mount the base on the wall.** Position the base so the mounting studs will fit into the holes on the bottom of the base. Position the power cord to extend down the wall the phone is to be mounted on. Slide the base down on the mounting studs until it locks into place.

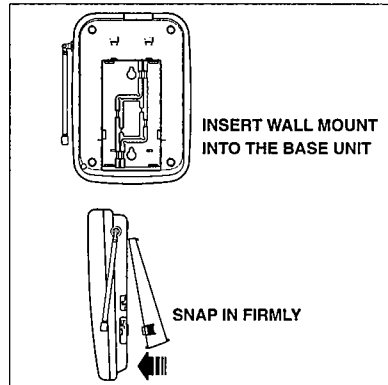

- **Connect the telephone cord.** The telephone line cord has a snap-in plug at each end. Insert one of the plugs into the jack on the bottom of the base. Insert the other end of the plug into the wall jack.
- **Plug the AC adaptor into an electrical outlet, and the DC connector on the back of the Base Unit.**

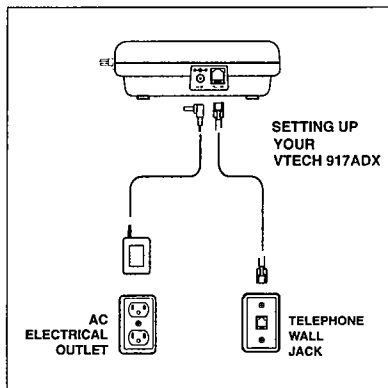

WALL MOUNTING

IMPORTANT:

When wall mounting your 917ADX, you must reverse the handset hook, located in the charging cradle. Otherwise your handset may fall from the Base Unit when cradled.

HANDSET FEATURES

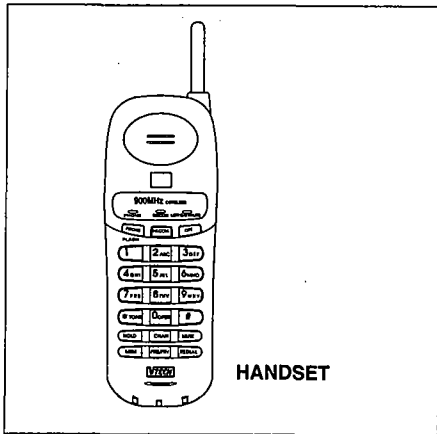

PHONE LED

- Glows steadily when Handset is in use.
- Flashes slowly when a call is on HOLD.
- Flashes rapidly when Handset is in Program (PRG) mode.
- Flashes in cadence with an incoming ring.

INT.COM LED

- Glows steadily when the INT.COM key is pressed on the Handset

LOW BATT/MUTE LED

- Flashes to signify that the Handset battery pack needs recharging.
- Glows steadily when the MUTE key is pressed during a call.

PHONE (FLASH) Key

- Press this key to get a dial tone or answer an incoming call.
- During a call, press PHONE to FLASH the line. This feature is used in conjunction with services such as Call Waiting.

INT.COM Key

- Press this key to initiate two-way, internal communication between the Handset and Base Unit. The Base Unit will emit two beeps, and will then automatically enter Intercom mode. The party at the Base Unit does not need to press any key to activate this feature, when it is initiated from the Handset.

OFF Key

- Press this key to end a call, exit from Intercom (INT.COM) mode or Program (PRG) mode.

HOLD Key

- Press this key to temporarily suspend conversation without terminating the call. With a call on HOLD, you can:
Intercom the Base Unit
Transfer the call to the Base Unit
Return to the call by pressing PHONE.
- NOTE:
If you have placed a call on HOLD and want to hang up: Press PHONE to return to the call, then press OFF, or place the Handset in the Base Unit.

HANDSET FEATURES

CHANNEL (CHAN) Key

- If you are experiencing noise or interference during a call, press the CHAN key to change to the next free channel.
- NOTE: You may need to press CHAN more than once to find an interference-free channel.

MUTE Key

- Press this key to mute the Handset microphone during a conversation. You will still be able to hear the other party, but they cannot hear you.
- Press MUTE again to resume two-way conversation.

MEMORY (MEM) Key

- Press this key to enter MEMORY DIALING mode.
- The sequence for dialing a phone number stored in memory is: Press PHONE, MEM, Memory Location (0-9).

PROGRAM/PRIVACY (PRG/PRV) Key

- With the Handset OFF, press this key to store phone numbers into MEMORY, as well as programming the Handset RINGER.
- See PROGRAMMING THE RINGER TYPE, and TO STORE A NUMBER INTO MEMORY, for details.
- During a call, press PRG/PRV to prevent the Base Unit from joining the conversation.

REDIAL Key

- When you hear a dial tone, press this key to redial the last phone number dialed on your 917 ADX.
- The phone number stored in REDIAL can be placed in a MEMORY dial location.

*TONE Key

- From the PULSE (Rotary) dialing mode, press this key to switch to TEMPORARY TONE dialing mode.
- When the call is ended, the phone will return to PULSE dialing mode.

VOLUME CONTROL SWITCH

- Located on the Left edge of the Handset.
- Two Settings: H (High) and L (Low).

HEADSET JACK (2.5 mm)

- Located on Right edge of the Handset.
- Plug (optional) Headset into this jack for hands-free operation.
- See OPTIONAL HEADSET INSTALLATION AND OPERATING INSTRUCTIONS for more information.

BASE UNIT FEATURES

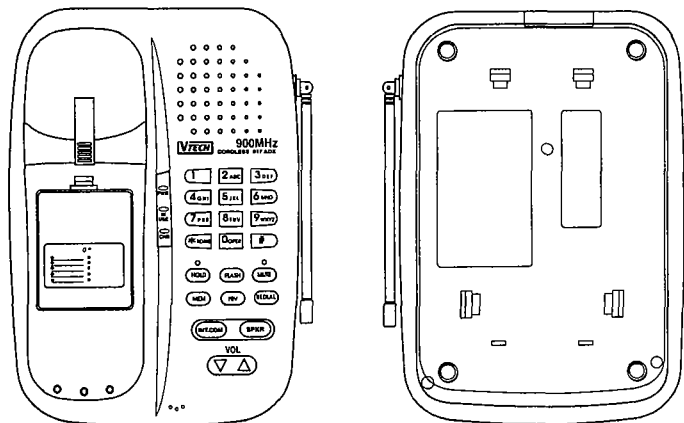

BASE UNIT

POWER (PWR) LED

- Glows steadily when the AC adaptor is supplying power to the Base Unit.

IN USE LED

- Glows steadily when the Handset is on a call.
- Flashes in cadence with an incoming ring.

CHARGE (CHR) LED

- Blinks twice after placing the Handset in the Base Unit to indicate that initialization (assigning a new security code) has occurred.

- After initialization, the **CHR** LED will glow steadily to indicate that the Handset battery is being charged.
- If the Handset is placed in the Base Unit without a battery, the **CHR** LED will flash rapidly.

HOLD LED

- During a phone call, whether using Base or Handset, this LED will flash if the call is placed on HOLD.

MUTE LED

- During a SPEAKERPHONE call, this LED will glow if the MUTE key is pressed.

BASE UNIT FEATURES

INTERCOM (INT.COM) LED

- Flashes rapidly when the **INT.COM** key is pressed.
- NOTE: The Handset must be away from the Base Unit to use the **INTERCOM** feature.
- Blinks twice, accompanied by two beeps, when the Handset initiates the **INTERCOM** call to the Base Unit.
- Glows steadily while the Handset and Base Unit are in **INTERCOM** mode.

SPEAKER (SPKR) LED

- Glows when Base Unit is in **SPEAKERPHONE** mode.

RINGER SWITCH

- Located on the right edge of the Base Unit (antenna side)
- 3 selections: HIGH, LOW, OFF

TONE/PULSE SWITCH

- Located next to RINGER switch
- Select mode compatible with your local telephone service (for most areas, TONE is the preferred dialing mode).

HOLD KEY

- Press this key to temporarily suspend conversation without terminating the call. With a call on HOLD, you can:
 - Intercom the Handset

- Transfer the call to the Handset
- Return to the call by pressing **SPKR**.
- NOTE: If you have placed a call on HOLD and want to hang up:
- Press **SPKR** to return to the call, then press **SPKR** again.

FLASH KEY

- This key is used in conjunction with services such as **CALL WAITING**.

MUTE KEY

- Press this key to mute the Handset microphone during a conversation. You will still be able to hear the other party, but they cannot hear you.
- Press **MUTE** again to resume two-way conversation.

MEMORY (MEM) KEY

- Press this key to enter **MEMORY DIALING** mode.
- The sequence for dialing a phone number stored in memory is: Press **SPKR, MEM, Memory Location (0-9)**.

PRIVACY (PRV) KEY

- During a call, press **PRV** to prevent the Handset from joining the conversation.

BASE UNIT FEATURES

REDIAL KEY

- When you hear a dial tone, press this key to redial the last phone number you dialed on your **917 ADX**.

INTERCOM (INT.COM) KEY

- Press this key to initiate two-way, internal communication between the Base Unit and Handset.
- If the Handset is in the OFF mode, it will ring a maximum of 4 times. The Handset user can respond to the INTERCOM ring by pressing INT.COM. The Handset user can also choose to ignore the INTERCOM ring, in which case, the ringing will stop after 4 rings. Otherwise, the Handset user can press OFF, which will terminate the ringing.
- Press INT.COM to terminate INTERCOM mode.

SPEAKERPHONE (SPKR) KEY

- Press this key to use the SPEAKERPHONE for making or answering calls. Press SPKR to end the call.

VOLUME UP KEY

- Press this key to increase the Base Unit speaker volume. A series of rapid beeps tell you that maximum volume level has been reached.
- The volume level will continue to increment up if this key is held down. There are a total of 8 volume settings.

VOLUME DOWN KEY

- Press this key to decrease the Base Unit speaker volume. A series of rapid beeps tell you that minimum volume level has been reached.
- The volume level will continue to increment down if this key is held down. There are a total of 8 volume settings.

*TONE KEY

- From the PULSE (Rotary) dialing mode, press this key to switch to TEMPORARY TONE dialing mode.
- When the call is ended, the phone will return to PULSE dialing mode.

OPERATING INSTRUCTIONS

IMPORTANT: Whenever the Handset battery pack is removed and then replaced, the Handset must be reinitialized on the Base Unit cradle. The **Charge (CHR)** LED on the Base Unit will flash during the initialization.

MAKING CALLS

From the Handset

- Pick up the Handset and press **PHONE**. When you hear a dial tone, dial the number. The **IN USE** LED (on the Base Unit) and **PHONE** LED (on the Handset) will light.

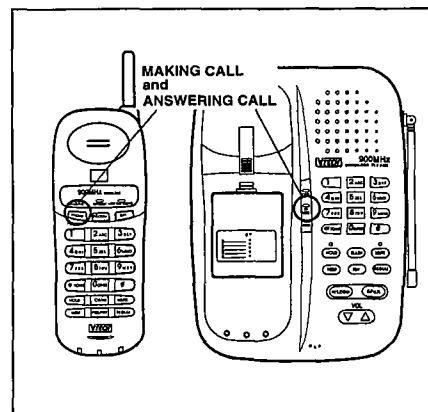

- If you make a mistake when dialing, press **OFF** to hang up, then press **PHONE** to get a dial tone again.

- You must always press **PHONE** before you can dial a call on the Handset.

Disconnecting

- To end a call, either place the Handset back in the Base Unit, or press **OFF** on the Handset.

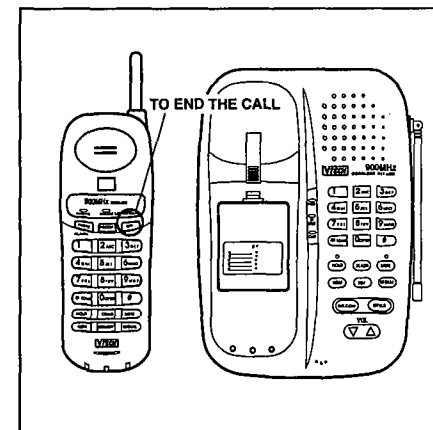

From the Speakerphone

- The Base Unit also works as a Speakerphone. It allows you to make and receive calls without using the Handset. You can use the Speakerphone while the Handset is in or out of the base.

- Press **SPKR** on the Base Unit. You will hear the dial tone over the speaker. Use the Volume Control keys to adjust the speaker to a comfortable listening level. Dial the number on the keypad of the Base Unit. When the party answers, speak toward the microphone, located at the lower front edge of the Base Unit.

- To hang up, press **SPKR** again on the Base Unit.

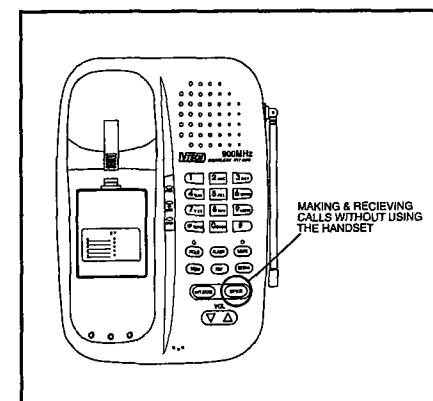

OPERATING INSTRUCTIONS

ANSWERING CALLS

From the Handset

■ The Handset will ring when you have an incoming call. You can answer calls on the Handset whether it is in the base or away from it. If your phone rings when the Handset is in the base, just pick up the Handset. The call will be connected automatically, and you'll see that the **PHONE LED** on the Handset and the **IN USE LED** on the Base Unit are lit. If the Handset rings when it is away from the base, press any key, except **OFF** to answer the call.

From the Speakerphone

■ The Speakerphone will also ring to signify an incoming call. To answer from the Speakerphone, press **SPKR**. You can now talk to your party hands-free. Use the Volume Control keys to adjust the speaker to a comfortable listening level.

■ **NOTE:** If you are using your Speakerphone in a noisy environment, the conversation coming from your party may suffer from dropout. In this case, press **MUTE** on the Speakerphone while your party talks. Press **MUTE** again to deactivate before you begin talking.

TO PUT A CALL ON HOLD

■ While using the Speakerphone or the Handset, you can put a call on hold by pressing **HOLD**. The **HOLD LED** on the Base Unit and the **PHONE LED** on the Handset will blink to indicate a call is on hold.

■ To return to the call, press **PHONE** (on the Handset) or **SPKR** (on the Base Unit).

■ If your **917 ADX** has a call on **HOLD**, and a user picks up an extension phone on the

same line, the **917 ADX** will take itself off **HOLD** and turn **OFF**.

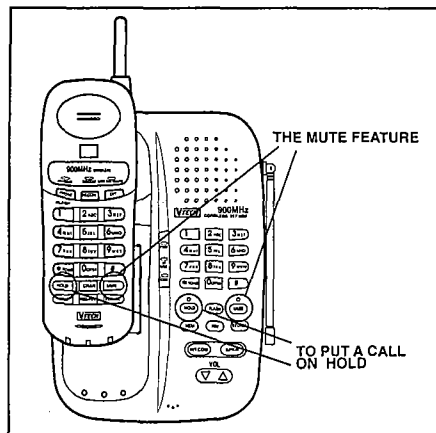

THE MUTE FEATURE

■ When you press **MUTE** (on the Handset or Base Unit), you can hear the caller's voice, but they can't hear you. While a call is muted, the **LOW BATT/MUTE LED** (on the Handset) or the **MUTE LED** (on the Base Unit) glows steadily. To go back to the two-way conversation, press **MUTE** again.

■ This feature is useful when the Speakerphone is used in a noisy room. Loud background noise can prevent your caller's voice from coming over the speaker. Press **MUTE** while your caller is speaking. Press **MUTE** again when you are ready to speak.

SWITCHING TO THE HANDSET

■ During a Speakerphone call, if the Handset is in the Base Unit, you can automatically switch from the Speakerphone to the Handset by picking up the Handset.

OPERATING INSTRUCTIONS

SWITCHING TO THE SPEAKERPHONE

■ Press **HOLD** on the Handset

■ Press **SPKR** on the Base Unit to take the

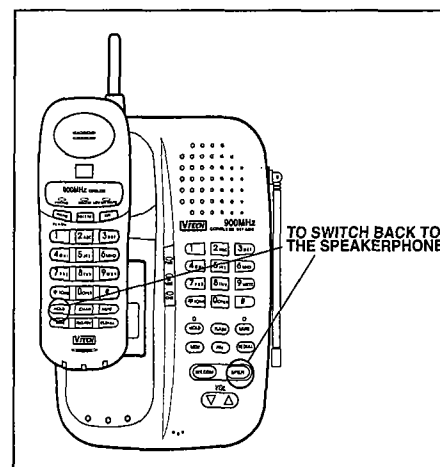

call off **HOLD** and continue a Speakerphone conversation.

■ You cannot switch back to the Speakerphone just by returning the Handset to the Base Unit cradle - that will disconnect the call.

■ **NOTE:** Placing the call on **HOLD** prior to switching to or from the Speakerphone minimizes the risk of annoying feedback.

JOINING A HANDSET CONVERSATION

■ If someone is speaking on the Handset, you can join the conversation on the Speakerphone. Just press **SPKR** on the Base Unit. The Handset will emit a short tone to alert that the Speakerphone has been activated. Either party can then leave the conversation by pressing **OFF** (on the Handset) or **SPKR** (on the Base Unit)

■ Likewise, if you are using the Speakerphone, someone at the Handset can join the conversation by pressing **PHONE**. The Base

Unit will emit a short tone to alert the user that the Handset has been activated.

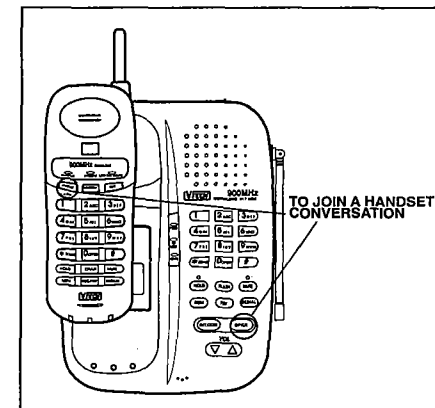

■ The call will remain connected as long as either the Handset or the Speakerphone remains on the line. (To disconnect the call, both the Handset and the Base Unit must hang up.)

THE PRIVACY FEATURE

■ While using the Handset, you can prevent someone from joining the conversation at the Speakerphone by pressing **PRG/PRV**. The Handset must be **ON** to utilize this feature.

■ Pressing **PRG/PRV** a second time will terminate **PRIVACY** mode and anyone at the speakerphone can join in.

■ When someone at the speakerphone has already joined in, pressing **PRG/PRV** on handset will turn off the speakerphone.

■ Likewise, you can prevent the Handset from joining the conversation while using the Speakerphone. While the Speakerphone is **ON**, press **PRV**.

■ Pressing **PRV** a second time will terminate **PRIVACY** mode, and anyone at the Hand-

OPERATING INSTRUCTIONS

set can join in.

- When someone at the handset has already joined the conversation, pressing PRV on the Speakerphone will turn off the handset.

mode.

Intercom from Base Unit to Handset

- Press **INT.COM** on the Base Unit.
- If the Handset is in the OFF mode, it will ring a maximum of 4 times. The Handset user can respond to the INTERCOM ring by pressing **INT.COM**. The Handset user can also choose to ignore the INTERCOM ring, in which case, the ringing will stop after 4 rings. Otherwise, the Handset user can press OFF, which will terminate the ringing.
- Press **INT.COM** to terminate INTERCOM mode.

NOTE: If the Handset is ON when **INT.COM** is pressed on the Base Unit, the Handset will emit only one ringer tone, and then return to the original call.

Handset Locator

- Occasionally you may misplace your **917 ADX** Handset. Use the Intercom feature on the Base Unit to help locate the missing Handset. When the **INT.COM** key is pressed, the Handset will ring four times.

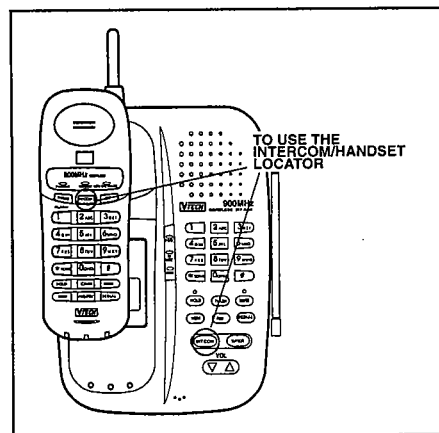

OPERATING INSTRUCTIONS

IF YOUR PHONE RINGS DURING AN INTERCOM CONVERSATION

- If you receive a call while using the Intercom, your phone will ring normally. You can answer the incoming call by pressing **PHONE** (on the Handset) or **SPKR** (on the Base Unit). However, by answering the incoming call, you will automatically disconnect the Intercom.

USING THE INTERCOM DURING A PHONE CALL

- Press **HOLD** to put the call on hold, then use the Intercom normally.
- To end the Intercom conversation, press **OFF** (on the Handset) or **INT.COM** (on the Base Unit).
- To return to the call, press **PHONE** (on the Handset) or **SPKR** (on the Base Unit).

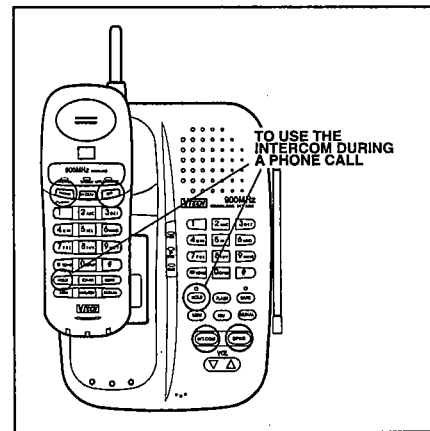

TEMPORARY TONE FEATURE

- If you have rotary (dial-pulse) telephone service, (TONE/PULSE switch is set to PULSE), Temporary Tone allows you to enter special codes and tones to access answering machines, electronic banking services,

calling cards, or other special services.

- First, dial the call normally. Then activate the Temporary Tone feature by pressing ***TONE** key. You can then press the numbers or symbols you need, and your phone will send the proper tone signals. This feature is available on the Handset and the Speakerphone.

- To end the call, press **OFF** (on the Handset), or place the Handset back in the Base Unit cradle. From Base Unit press **SPKR** to end a call. The phone will automatically go

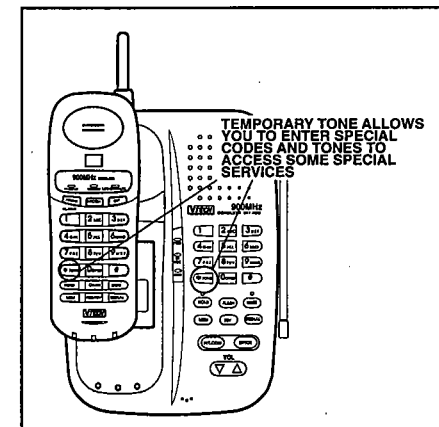

back to rotary (dial-pulse) service.

- The Temporary Tone feature is for use with PULSE dialing service only.

PROGRAMMING THE RINGER TYPE

- The **917 ADX** cordless phone has four different ringing tones available for the Handset.

- To program the Handset ringer tone:
 - Handset must be OFF
 - Press **PRG/PRV** key on Handset
 - Press **#** or ***** key on the Handset

OPERATING INSTRUCTIONS

■ Press **1, 2, 3, or 4** on the Handset to select a ringer type. The Handset will emit the corresponding ringer tone.

■ Press **OFF** on the Handset to exit programming.

TURNING OFF THE HANDSET RINGER

■ The Handset must be OFF

■ Press **PRG/PRV** on the Handset

■ Press **#** or ***** key on the Handset

■ Press **5** to turn off the ringer

■ Press **OFF** key to exit

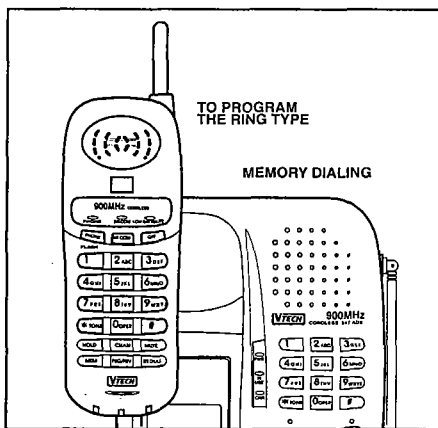

BASE RINGER CONTROL

■ This control switch is located on the right and edge of Base Unit.

■ Select **HIGH, LOW** or **OFF** setting.

CHECKING THE HANDSET RINGER

■ To check the ringer type which is currently programmed, do the following:

■ Handset must be **OFF**

■ Press **PRG/PRV** on the Handset

■ Press **#** key on the Handset

■ Press **0** on the Handset. The phone will ring once to show ringer selected.

■ Press **OFF** key to exit

MEMORY DIALING

■ The **917 ADX** cordless phone can store up to 10 frequently dialed numbers in memory.

■ Memory Dial numbers must be stored using the Handset, but can be recalled from either the Base Unit or the Handset.

TO STORE A NUMBER INTO MEMORY

■ The Handset must be **OFF**

■ Press **PRG/PRV** on the Handset

■ Press the Memory Location key where the phone number will be stored (**0-9**)

■ Dial the number you want to store. The number can be up to 16 digits long

■ Press **MEM** on the Handset to complete programming

■ If programming has been successful, a happy tone will be generated.

■ If programming was unsuccessful, a sad tone is generated.

■ If the phone is left unattended in program mode for longer than 30 seconds, it will generate a sad tone and automatically exit program mode.

■ Write down the phone number you assigned to each Memory Location key on the directory card in the Base Unit cradle.

TO DIAL A NUMBER FROM MEMORY

■ You can Memory Dial from either the Handset or the Base Unit.

OPERATING INSTRUCTIONS

■ Press **PHONE** (on the Handset) or **SPKR** (on the Base Unit) to get a dial tone

■ Press **MEM** and the Memory Location key (**0-9**)

■ For example, to dial the number you assigned to key '8', you would press **PHONE, MEM, 8** (on the Handset), or **SPKR, MEM, 8** (on the Base Unit).

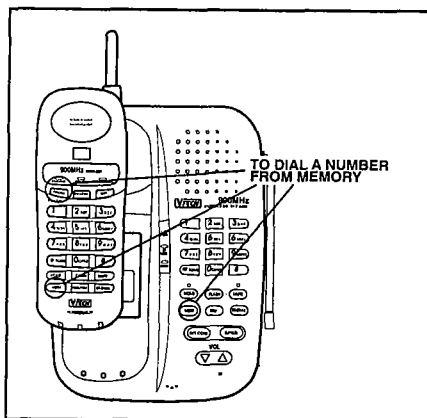

TO CHANGE OR REPLACE A STORED NUMBER

■ You can change or replace a stored phone number by storing a new number in its place. See **TO STORE A NUMBER INTO MEMORY**.

TO ERASE STORED NUMBER FROM MEMORY

■ The Handset must be **OFF**.

■ Press **PRG/PRV** on the Handset.

■ Press the Memory Location of the phone number to be erased.

■ Press **MEM** on the handset to complete programming.

STORING PAUSES IN MEMORY

■ To insert a pause while programming a Memory Dial number, do the following on the Handset:

■ Press **PRG/PRV** on the Handset

■ Press the Memory Location key where the phone number will be stored (**0-9**)

■ Dial the number you want to store, pressing **HOLD** at the appropriate point (to insert a 2 second pause). The number can be up to 16 digits long. Each press of **HOLD** is treated as stored digit.

■ For longer pauses, press **HOLD** two or more times. Each press makes the pause 2 seconds longer and is treated as a stored digit.

■ Press **MEM** on the Handset to complete programming.

■ For example, if your phone is connected to a PBX, you can store the PBX access number and a pause before the phone number. To store 9-PAUSE-555-1234, in Memory Location 8, you would:

■ Press **PRG/PRV**

■ Press **8**

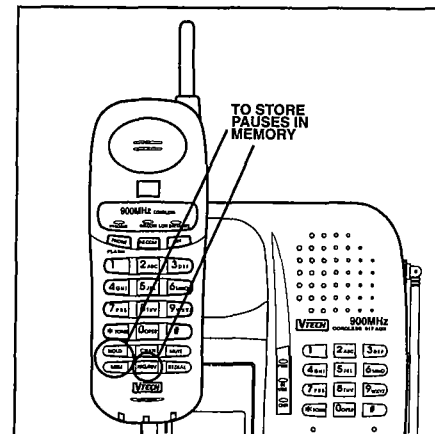

OPERATING INSTRUCTIONS

- Press 9
- Press HOLD
- Dial 555-1234
- Press MEM

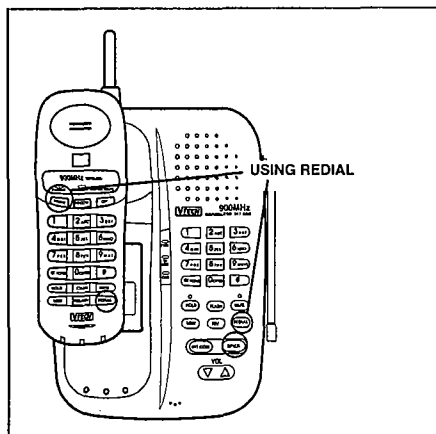

USING REDIAL

■ The **917 ADX** cordless phone automatically stores the last number you dialed in a special redial memory.

■ To redial the last number, press **PHONE** (on the Handset) or **SPKR** (on the Base Unit), then **REDIAL**.

STORING A REDIAL NUMBER IN MEMORY DIAL

■ To store the last number you dialed as a regular Memory Dial number, do the following on the Handset:

- Press **PRG/PRV**
- Press the Memory Location key where the phone number will be stored (0-9)
- Press **REDIAL**
- Press **MEM**

CHANGING CHANNELS

■ If you are experiencing noise or interference when using your Handset, press the **CHAN** key to switch to a clear channel. This function is available when you are on a call or intercom.

■ NOTE: You may need to press **CHAN** more than once to find an interference-free channel.

OPTIONAL HEADSET INSTALLATION AND OPERATING INSTRUCTIONS

■ Your **917 ADX** cordless telephone is equipped with a 2.5mm Headset Jack for use with an **optional** accessory Headset for hands-free operation

■ If you choose to use the Headset option, you must do the following:

INSTALLATION

■ Obtain an optional accessory Headset, which is compatible with the **917 ADX**.

In the U.S. please contact **VTech Communications Customer Service**, toll-free at **1-800-595-9511**, in Canada call **VTech Electronics** at **1-800-267-7377** for dealer information in your local area. You can also purchase a compatible Headset directly from VTech Communications Customer Service.

■ Once you have a compatible 2.5mm Headset, locate the Headset Jack on the Handset of your **917 ADX**. Connect the plug on the Headset to the jack on the cordless Handset. The plug should fit securely. Do not force the connection. See illustration.

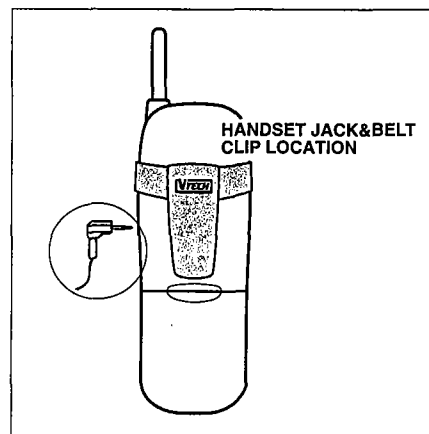

■ The **917 ADX** is also equipped with a detachable belt clip. Align the pins on the inside edge of the belt clip with the notches on the side of the **917 ADX** handset. The belt clip should snap securely into place. Do not force the connection. See illustration.

OPERATION

■ NOTE: Whenever a compatible Headset is connected to the cordless Handset, the microphone on the Handset will be MUTED. This is done to limit the effect of background noise.

■ The following operational characteristics apply to VTech Headsets. The same may also apply to other (non-VTech) compatible headsets, but VTech assumes no responsibility for their performance.

■ The VTech brand compatible Headset has a monaural design which is reversible, so you can wear your Headset on either the left or right ear, leaving one ear free for room conversation

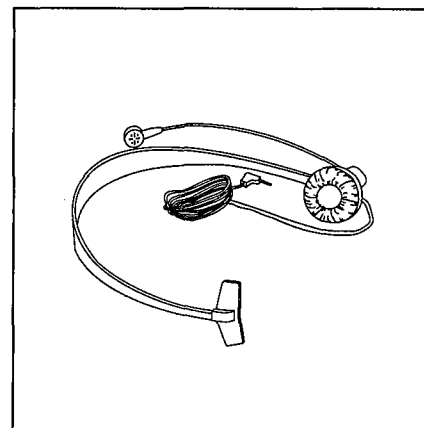

■ The headband can be adjusted to fit the contour of your head. Using both hands,

OPTIONAL HEADSET INSTALLATION AND OPERATING INSTRUCTIONS

slide the headband up or down so that it rests comfortably on your head with the speaker cushion centered against your ear.

■ For maximum sound quality, the flexible microphone should be positioned at the corner of your mouth, about one inch from your mouth.

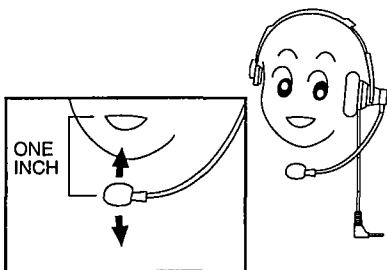

M A I N T E N A N C E

■ TAKING CARE OF YOUR TELEPHONE.

Your **VTech 917 ADX** cordless telephone contains sophisticated electronic parts so it must be treated with care.

■ Avoid rough treatment

Place the Handset down gently. Save the original packing materials to protect your telephone if you ever need to ship it.

■ Avoid water

Your telephone can be damaged if it gets wet. Do not use the Handset outdoors in the rain, or handle it with wet hands. Do not install your Base Unit near a sink, bathtub or shower.

Remember that electrical appliances can cause serious injury if used when you are wet or standing in water. If your Base Unit should fall into water, **DO NOT RETRIEVE IT UNTIL YOU UNPLUG THE POWER CORD AND TELEPHONE LINE CORDS FROM THE WALL.** Then pull the unit out by the unplugged cords.

■ Electrical storms

Electrical storms can sometimes cause power surges harmful to electronic equipment.

For your own safety, use caution when using electric appliances during storms.

■ Cleaning your telephone

Your telephone has a durable plastic casing that should retain its luster for many years. Clean it only with a soft cloth slightly dampened with water or a mild soap. Do not use excess water or cleaning solvents of any kind.

IN CASE OF DIFFICULTY

■ If you have difficulty operating your phone, the suggestions below should solve the problem. If you still have difficulty after trying these suggestions, In the US call:

VTECH Communications at

1-800-595-9511 ,In Canada call :VTECH Electronics at 1-800-267-7377.

THE PHONE DOESN'T WORK AT ALL.

- Make sure the power cord is plugged in.
- Make sure the telephone line cord is plugged firmly into the Base Unit and the telephone wall jack.
- Make sure the battery pack is properly charged. If the **LOW BATT** LED is on, the battery pack needs charging. If the **IN USE** LED (on the Base Unit) and the **PHONE** LED (on the Handset) do not light when you press **PHONE**, you should charge the battery pack.
- If you recently installed a new battery pack, make sure it is installed correctly.

NO DIAL TONE.

- First check all the suggestions above.
- If you still don't hear a dial tone, disconnect the Base Unit from the telephone jack and connect a different phone. If there is no dial tone on that phone either, the problem is in your wiring or local service. Call your local telephone company.

YOU GET NOISE, STATIC, OR A WEAK SIGNAL EVEN WHEN YOU'RE NEAR THE BASE UNIT.

- Place the Handset in the base momentarily to re-set the security code. Then press **PHONE** to get a line.
- Household appliances plugged into the same circuit as the Base Unit can sometimes cause interference. Try moving the

appliance or the Base Unit to another outlet.

YOU GET NOISE, STATIC, OR A WEAK SIGNAL WHEN YOU'RE AWAY FROM THE BASE UNIT.

- You may be out of range. Either move close to the base, or relocate the Base Unit.
- The layout of your home may be limiting the range. Try moving the Base Unit to the second or third floor, or to some other location.

THE HANDSET DOES NOT RING WHEN YOU RECEIVE A CALL.

- Ensure that the ringer is turned on.
- Make sure the telephone line cord is plugged firmly into the Base Unit and the telephone jack. Make sure the power cord is plugged in.
- You may be too far from the Base Unit.
- You may have too many extension phones on your telephone line to allow all of them to ring. Try unplugging some of the other phones.

THE BASE DOES NOT RING

- Make sure the **BASE RINGER** switch is not set to off.
- There may be too many extension phones on your line. Try unplugging one of the other phones.

YOUR CALLER FADES IN AND OUT.

- You may be nearly out of range. Move closer, or relocate the base.

YOU HEAR OTHER CALLS WHILE USING YOUR PHONE.

- Replace the Handset in the base cradle, wait a few moments and try again. Disconnect your Base Unit from the telephone jack, and

IN CASE OF DIFFICULTY

plug in a regular telephone. If you still hear other calls, the problem is probably in your wiring or local service. Call your local telephone company.

YOU HEAR NOISE IN THE HANDSET, AND NONE OF THE KEYS OR BUTTONS WORK.

- Make sure the power cord is plugged in.
- Your Base Unit and Handset may not be operating on the same channel or security code. Place the Handset in the cradle for a few moments to reload the security code and reset the channel.

COMMON CURE FOR ELECTRONIC EQUIPMENT

■ Electronics, like people, can sometimes get confused. If the unit does not seem to be responding normally, then try putting the Handset in the cradle to reinitialize the unit. If it still does not seem to respond, perform the following steps (in the order listed):

1. Disconnect the power to the Base Unit.
2. Remove the Handset battery Pack
3. Wait a few minutes.
4. Connect power to the Base Unit.
5. Install the Handset battery pack.
6. Put the Handset in the Base Unit cradle to reinitialize.

WARRANTY STATEMENT

WHAT DOES OUR WARRANTY COVER?

- Any defect in material or workmanship.

FOR HOW LONG AFTER THE ORIGINAL PURCHASE?

- To the original purchaser only - ONE YEAR.

WHAT WILL VTECH DO?

- At our option, repair or replace your unit.

HOW DO I SEND MY UNIT, IN OR OUT OF WARRANTY?

- In the U.S. call VTECH Communications customer service for Return Authorization at:
1-800-595-9511.

in Canada call VTECH ELECTRONICS at **1-800-267-7377.**

- Properly pack your unit. Include any cables & accessories which were originally provided with the product. We recommend using the original carton and packing materials.
- Include in the package a copy of the sales receipt or other evidence of date of original purchase (if the unit was purchased within the last twelve months).
- Print your name and address, along with a description of the defect, and include this in the package.
- Include payment for any service or repair not covered by warranty, as determined by VTECH Communications.
- In the U.S. Ship the unit via UPS Insured, or equivalent to:

VTECH COMMUNICATIONS
8770 SW NIMBUS AVENUE
BEAVERTON, OREGON 97008

In Canada Ship the unit via UPS insured, or equivalent to:

VTECH ELECTRONICS
Suite 200 -7671 Alderbridge Way
Richmond, B.C. V6X 1Z9

VTECH Communications assumes no responsibility for units sent without prior Return Authorization.

WHAT DOES OUR WARRANTY NOT COVER?

- Batteries
- Damage from misuse, neglect, or acts of nature (lightning, floods, power surges, etc.)
- Products which may have been modified or incorporated into other products
- Products purchased and/or operated outside the USA, its territories, or Canada.
- Products serviced by the owner or a service facility not expressly authorized by VTECH Communications

WARRANTY STATEMENT

Products purchased more than 12 months from current date

- Units purchased in "AS IS" condition, or units purchased as "Distressed Merchandise".

HOW DOES STATE LAW OR PROVINCIAL LAW RELATE TO THIS WARRANTY?

- This warranty gives you specific rights. You may also have other rights which vary from state to state or province to province.

FCC & IC REGULATIONS

■ This equipment complies with Parts 15 and 68 of the Federal Communications Commission (FCC) rules for the United States.

■ A label is located on the underside of the Base Unit containing either the FCC registration number and Ringer Equivalence Number (REN). You must, upon request, provide this information to your local telephone company.

■ This equipment is compatible with inductively coupled hearing aids.

■ Should you experience trouble with this telephone equipment, please contact:

In the United States:

VTECH COMMUNICATIONS

1-800-595-9511

In Canada:

VTECH ELECTRONICS

1-800-267-7377

for repair/warranty information. The telephone company may ask you to disconnect this equipment from the line network until the problem has been corrected.

■ Your **917 ADX** is designed to operate at the maximum power allowed by the FCC. This means your Handset and Base Unit can communicate only over a certain distance - which will depend on the location of the Base Unit and Handset, weather, and the construction and layout of your home or office.

FCC Part 15

Warning: Changes or modifications to this unit not expressly approved by the party responsible for compliances could void the user's authority to operate the equipment.

■ The equipment has been tested and found to comply with part 15 of the FCC rules. These limits are designed to provide reasonable protection against harmful interference in a residential installation. This equipment generates, uses and can radiate radio frequency energy and, if not

FCC & IC REGULATIONS

installed and used in accordance with the instructions, may cause harmful interference to radio communications. However, there is no guarantee that interference will not occur in a particular installation. If this equipment does cause harmful interference to radio or television reception, which can be determined by turning the equipment off and on, the user is encouraged to try and correct the interference by one or more of the following measures:

- Reorient or relocate the receiving antenna.
- Increase the separation between the equipment and receiver.
- Connect the equipment into an outlet on a circuit different from that to which the receiver is connected.
- Consult the dealer or an experienced radio/TV technician for help.

FCC Part 68

■ The FCC requires that you connect your cordless telephone to the nationwide telephone network through a modular telephone jack (USOC RJ11C or RJ11W).

■ Your telephone company may discontinue your service if your equipment causes harm to the telephone network. They will notify you in advance of disconnection, if possible. During notification, you will be informed of your right to file a complaint with the FCC.

■ Occasionally, your telephone company may make changes in its facilities, equipment, operation, or procedures that could affect the operation of your equipment. If so, you will be given advance notice of the change to give you an opportunity to maintain uninterrupted service.

■ The Base Unit contains no user serviceable parts. The Handset contains a user replaceable battery pack.

■ If it is determined that your telephone equipment is malfunctioning, the FCC requires that it not be used and that it be unplugged from the modular jack until the problem has been corrected. Repairs to this telephone equipment can only be made by the manufacturer or its authorized agents or by others who may be authorized by the FCC. For repair procedures, follow the instructions outlined under the VTECH Limited Warranty.

■ This equipment may not be used on coin service provided by the phone company or Party Lines.

■ The REN is useful in determining the number of devices you may connect to your telephone line and still enable the devices to ring when you receive a call. The general rule is that the REN value should not exceed 5.0 total; however, contact your local telephone company for the specific number in your area.

FCC & IC REGULATIONS

IC (Industry Canada)

■ This telephone is registered for use in Canada.

Notice: The Industry Canada label identifies certified equipment. This certification means that the equipment meets certain telecommunications network, protective, operational and safety requirements. Industry Canada does not guarantee the equipment will operate to the user's satisfaction.

■ Before installing this equipment, users should ensure to the facilities of the local telecommunications company. The equipment must also be installed using an acceptable method of connections. The customer should be aware that compliance with the above conditions may not prevent degradation of service in some situations.

■ Repairs to certified equipment should be made by an authorized Canadian maintenance facility designated by the supplier. Any repairs or alterations made by the user to this equipment, or equipment malfunctions, may give the telecommunications company cause to request the user to disconnect the equipment.

■ Users should ensure for their own protection that the electrical ground connections of the power utility, telephone lines and internal metallic water pipe system, if present, are connected together. This precaution may be particularly important in rural areas.

Caution : Users should not attempt to make such connections themselves, but should contact appropriate electric inspection authority, or electrician, as appropriate.

■ The Load Number (LN) assigned to this device denotes the percentage of the total load to be connected to a telephone loop which is used by the device to prevent overloading. The termination on a loop may consist of any combination of devices subject only to the requirement that the total of the load numbers of all devices does not exceed 100.

■ This device complies with RSS-210 of Industry Canada. Operation is subject to the following two conditions: (1) this device may not cause interference, and (2) this device must accept any interference, including interference that may cause undesired operation of the device.

TECHNICAL SPECIFICATIONS

FREQUENCY CONTROL

Crystal Controlled Dual PLL Synthesizer

TRANSMIT FREQUENCY

Handset: 925.05 MHz to 927.75 MHz (All ten channels within this range)

Base: 902.3 MHz to 905.0 MHz (All ten channels within this range)

RECEIVE FREQUENCY

Handset: 902.3 MHz to 905.0 MHz (All ten channels within this range)

Base: 925.05 MHz to 927.75 MHz (All ten channels within this range)

NOMINAL EFFECTIVE RANGE

Maximum power allowed by FCC & IC. Actual operating range may vary according to environmental conditions at the time of use.

SIZE45fh

Handset: 18.2cm x 6.2cm x 3.8cm
(L x W x T) maximum
(antenna excluded)

Base: 21.0cm x 14.8cm x 5.5cm
(L x W x T) maximum
(antenna excluded)

WEIGHT

Handset: 250 grams

Base: 550 grams

POWER REQUIREMENTS

Handset: Self-contained nickel-cadmium rechargeable battery supply, 3.6V nominal, 600mAh capacity.

Power Adaptor: 9V DC@500mA

SPECIFICATIONS ARE TYPICAL AND MAY CHANGE WITHOUT NOTICE.

Free Manuals Download Website

<http://myh66.com>

<http://usermanuals.us>

<http://www.somanuals.com>

<http://www.4manuals.cc>

<http://www.manual-lib.com>

<http://www.404manual.com>

<http://www.luxmanual.com>

<http://aubethermostatmanual.com>

Golf course search by state

<http://golfingnear.com>

Email search by domain

<http://emailbydomain.com>

Auto manuals search

<http://auto.somanuals.com>

TV manuals search

<http://tv.somanuals.com>