

Table of contents

Getting started	4	Conference call	16
Parts checklist	4	Find Handset.	16
Installation	5	Voice mail service	16
Choose location	5	Telephone directory	17
Install handset battery	5	Store a new entry	17
Connect power to base unit/chargers	6	Characters by number	18
Connect to phone line	6	Review/dial from the directory	19
Check battery indicator	7	Edit a directory entry.	19
Check for dial tone	7	Delete a directory entry	20
If you subscribe to DSL service	8	Caller ID	21
Belt clip (optional)	8	Caller ID - call waiting ID.	21
Wall mounting (optional)	9	Review caller ID	22
Handset layout	10	Store caller ID	22
Base unit layout.	11	Dial from caller ID	24
Basic operation	12	Delete caller ID.	24
Handset icons	12	Handset settings	25
Handset LEDs	12	Ringer volume	25
Base LEDs	12	Key tone	25
Handset operation	13	Handset name	25
Making calls	13	Language	26
Answering calls	13	Clear voice mail	26
Adjust handset volume.	13	Dial type	26
Flash function	13	Headset operation	27
Redial	14	Headset	27
Mute	14	Operating range	27
Intercom	14	Batteries	28
Call forward	15	Battery care and performance.	28
Call transfer	16	Replace handset battery.	28

Table of contents

Additional information	29
Troubleshooting	29
Maintenance	35
Warranty	35
Important safety instructions	37
FCC, ACTA and IC regulations	38
The RBRC® Seal	39
Technical specifications	40
Index	41

NEED HELP?

This manual has all the feature operations and troubleshooting you need to install and operate your new VTech telephone. Please take the time to review thoroughly to ensure proper installation of this VTech innovative and feature rich product. You can also visit our website at www.vtechphones.com for support, shopping, and everything new at VTech.
In Canada, please visit www.vtechcanada.com.

VTech toll free 1-800-595-9511
In Canada dial 1-800-267-7377

note

- Before using this telephone, you must read **important safety instructions** on page 37.

Getting started

Parts checklist:

1. Base unit
2. Handsets (2)
3. Charger power adaptor
4. Charger
5. Telephone line cord
6. Wall mount bracket
7. Belt clips (2)
8. Base power adaptor
9. Battery packs (2)
10. User's manual
11. Quick Start Guide

To purchase replacement battery packs, visit us on the web at www.vtechphones.com or call VTech Communications, Inc. at 1-800-595-9511. In Canada, contact VTech Telecommunications Canada Ltd. at www.vtechcanada.com or 1-800-267-7377.

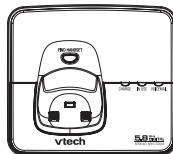

Base unit



Handsets (2)



Charger power adaptor



Charger

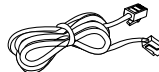

Telephone line cord

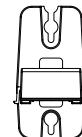

Wall mount bracket

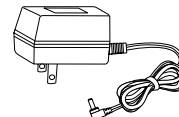

Base power Adaptor



Belt clips (2)



Batteries (2)



Quick Start Guide



User's manual

Installation

Choose location

For maximum performance of your cordless telephone system:

1. Choose a central location for your base unit.
2. Install your phone(s) as far away as possible from any other cordless (wireless) device such as cordless telephones, 802.11 wireless router (for example, WiFi).
3. Install your phone(s) as far away as possible from other electronic equipment such as microwave ovens, televisions, computers, etc.
4. Install your telephone equipment away from heat sources and direct sunlight.
5. Avoid excessive moisture, dust or extreme cold.

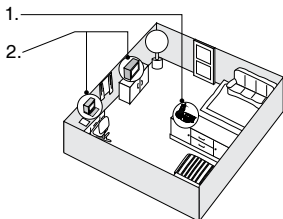

Install handset battery

1. Align the two holes in the plug with the socket pins, matching the red and the black connectors, then snap the plug into place.
2. Place the battery in the compartment with the wires in the upper right corner.
3. Replace cover by sliding it upwards until it clicks into place.
4. Be sure to charge the battery for 16 hours before using your phone.

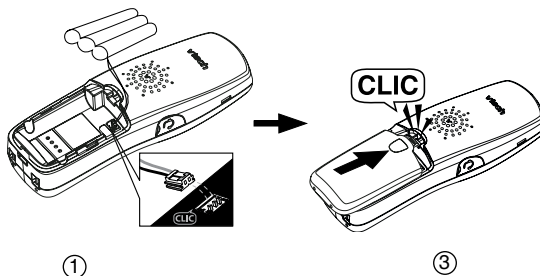

note

- Use only the provided VTech battery, or equivalent.
- Place the handset in its base or charger when not in use to ensure optimum performance.
- If you need to install your phone within the same room as other cordless phones or wireless products, you may need to select a different channel for your router and or change the channel on your phone's handsets.

note

- Connect the power and telephone line cords to the underside of the base as illustrated.
- Plug the AC adaptor into an electrical outlet. If the battery has not been charged, place the handset in the base or charger, and allow it to charge for at least 16 hours.
- Be sure to use an electrical outlet not controlled by a wall switch.

Installation

Connect power to base unit/chargers

1. Plug the power adaptor into an electrical outlet not controlled by a wall switch, and the connector into the bottom of the base unit.
2. Choose the location for your charger, and plug its power supply into an electrical outlet.

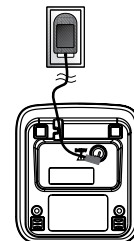
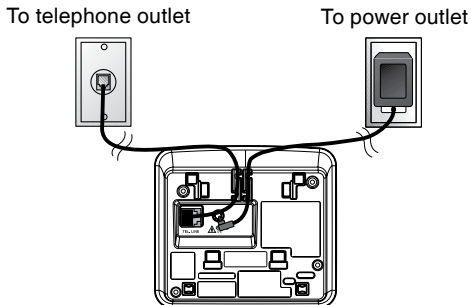

Connect to phone line

Plug one end of the telephone line cord into the telephone line jack at the bottom of the telephone base. Then plug the other end of the cord into the wall telephone outlet.

Installation

Check battery indicator

When the handset displays **WARNING CHECK BATTERY**, it indicates one of the following:

1. There is no battery in your handset. You need to install the supplied battery into your handset (see **Install handset battery** on page 5.)
2. The battery needs to be replaced.
3. The battery has been installed incorrectly. Please reinstall (see **Install handset battery**) and/or see the diagram in the battery compartment of the handset.

Check for dial tone

After the battery is charged, press  or **SPEAKER** on the handset. You should hear a dial tone. If not, see the **Troubleshooting** section near the end of this user's manual.

 **CAUTION:** Use only the VTech power supply provided with your telephone.

note

- If the phone will not be used for a long period of time, remove the battery pack to prevent possible leakage.
- If you have any trouble installing your phone, please refer to the **Troubleshooting** section near the end of this manual.
- When in **LOW BATTERY** mode, the keypad sounds, backlighting and speakerphone features will not work. When the battery has been charged, these features will return to their normal function.

Installation

If you subscribe to DSL service

If you hear interference during conversations, and/or your caller ID features are not functioning properly, and you subscribe to DSL service from your telephone company, install a noise filter to the telephone line between the base unit and the telephone line jack. Contact your DSL provider to obtain a noise filter.

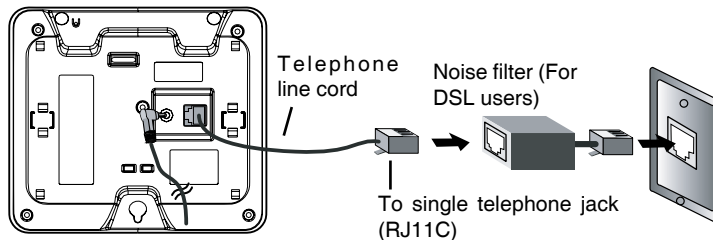

Belt clip (optional)

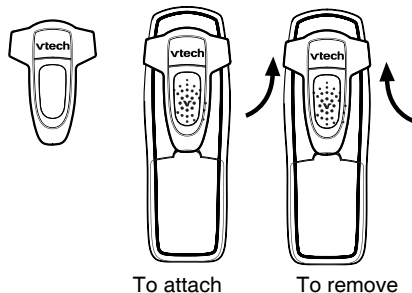

Wall mounting (optional)

The wall mount brackets are designed for use on standard wall mount plates only.

1. Plug the connector of the base power adaptor to the connector jack at the bottom of the base unit. Then plug the adaptor into an electrical outlet.
2. Connect the telephone line cord to the jack at the bottom of the base unit, and the other end to the wall jack.
3. Line up the tabs on the wall mount adaptors with the holes at the bottom of the base unit/back of the charger. Snap the wall mount bracket firmly in place.
4. Mount the base unit on the wall. Position the base unit so that the mounting studs will fit into the holes on the wall mount bracket. Slide base unit down on the mounting studs until it locks into place.

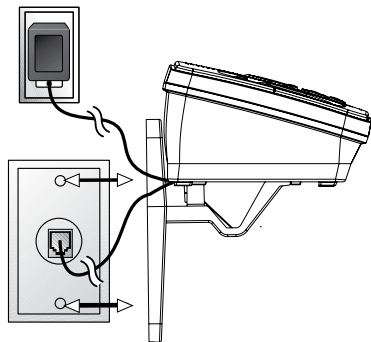

Handset layout

1. Earpiece
2. Headset jack (2.5mm)
3. Caller ID (scroll down)
4. Talk/flash
5. Dialing keys (0-9, *, #)
6. Redial/pause
7. Speaker
8. LCD display
9. Directory (scroll up)
10. Volume control
11. Select/menu
12. Off/clear
13. Intercom
14. Mute/remove

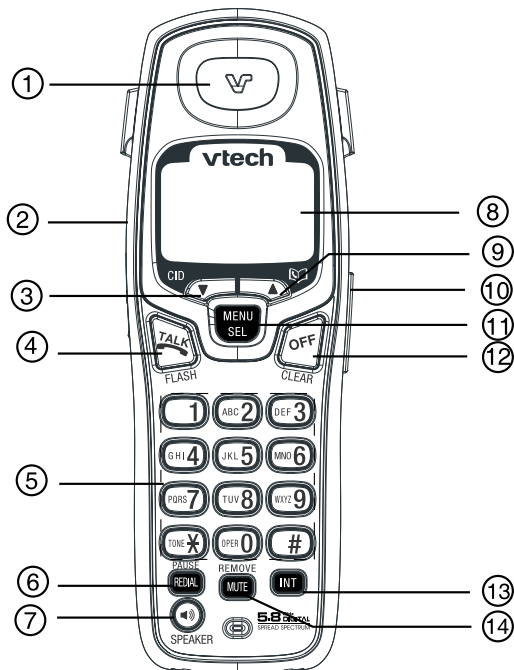

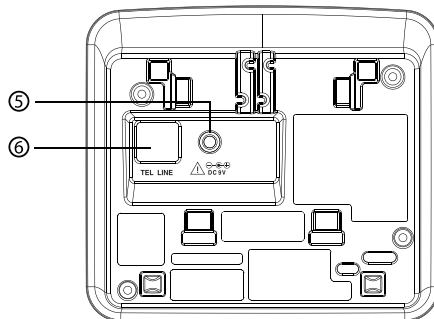
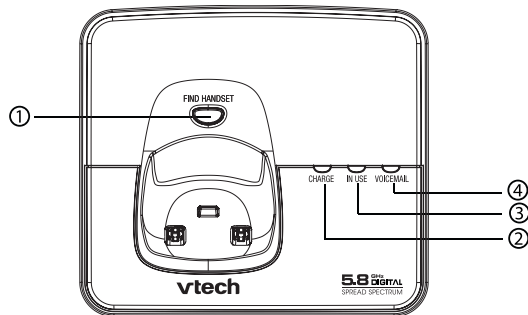

Base unit layout

1. Find handset
2. Charge
3. In use
4. Voice mail
5. Power connector jack
6. Telephone jack



Basic operation

Handset icons

Icon	Description
MUTE	<ul style="list-style-type: none">On when the microphone is muted, see page 14.
NEW	<ul style="list-style-type: none">On when there are new calls in the call log, see page 22.
	<ul style="list-style-type: none">On when the handset ringer is muted, see page 25.
	<ul style="list-style-type: none">Low battery or charging indicator, see page 8.

Handset LEDs

Icon	Description
	<ul style="list-style-type: none">On when handset speakerphone is in use.

Base LEDs

Icon	Description
IN USE	<ul style="list-style-type: none">On when the phone is on a call.Flashes when an extension phone is on a call.
CHARGE	<ul style="list-style-type: none">On when handset is positioned so its battery can charge.
Voice mail	<ul style="list-style-type: none">Flashes to indicate that you have new voice mail messages. (Service must be subscribed to through your local telephone company.)

Handset operation

Making calls

- Press **TALK** (or **SPEAKER**) to use the handset speakerphone feature), then dial the phone number.
-OR-
Dial the phone number first, then press **TALK** (or **SPEAKER**).
- Press **OFF** to end your call or place the handset in its base or charger.

Answering calls

- Press **TALK**, **SPEAKER** or any dialing keys.
- Press **OFF** to end your call or place the handset into its base or charger.

Adjust handset volume

The volume control is on the right side of the handset. During a call, press the **VOLUME +** or **-** keys to adjust the listening volume to a comfortable level. When you reach the maximum or minimum setting, a double beep will sound.

Flash function

When you subscribe to call waiting service from your telephone company, press **TALK** to switch to the new call when you receive a call waiting signal. Press **TALK** again to switch back to the original call.

Redial

- Press **REDIAL/PAUSE** to display the last telephone number dialed from the handset (up to 32 digits). Use **▲** or **▼**, or **REDAIL** button to scroll through the last five numbers dialed. When the beginning or the end of the redial list is reached, a double beep will sound.

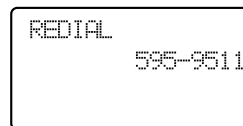
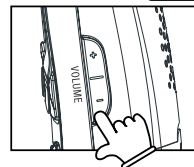
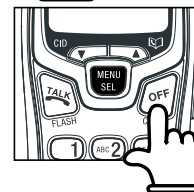
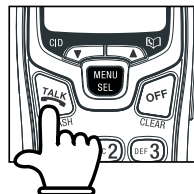

note

- The procedure to change the volume is the same for the handset earpiece, speakerphone and headset.
- Use **TALK** to access phone company subscriber services, as described by your provider.
- If the redial memory is empty, and **REDIAL** is pressed, a double beep will sound.

Handset operation

- Press **TALK** or **SPEAKER** to dial the displayed number.
- Press **MUTE/REMOVE** to delete the displayed number. You'll hear a confirmation beep.
- To exit the redial review list, Press **OFF**.

Mute

- During a call, press the **MUTE/REMOVE** key to disable the microphone. The other person on the call will not be able to hear you. The screen will display **MUTED** briefly:
- Press **MUTE/REMOVE** again to return to normal two-way conversation. **MICROPHONE ON** will display briefly.

```
PHONE 00:00:15
MUTED
MUTE
```

```
PHONE 00:00:15
MICROPHONE ON
```

Intercom

- Press **INT** on the originating handset (HS1) and **CALLING OTHER HANDSET** will show on the screen.
- The destination handset (HS2) will show **OTHER HANDSET IS CALLING**.
- Press **INT**, **TALK**, **SPEAKER**, or any dialing key on HS2 to pick up the call. The display will change to **INTERCOM**.

```
CALLING OTHER
HANDSET
```

```
OTHER HANDSET
IS CALLING
```

```
INTERCOM
```

Handset operation

Intercom (continued)

- Press **INT**, **OFF**, or place HS1 or HS2 back in the base or charger to end the call.

If HS2 is out of range, the screen on HS1 will show **NO SIGNAL CALL ENDED**. If HS2 is off, in use or out of range, HS1 will show **UNABLE TO CALL TRY AGAIN**.

Call forward

An external call can be forwarded or transferred from the originating handset (HS1) to the destination handset (HS2).

- While HS1 is on an external call, you can forward the call to HS2 by pressing and holding **INT**. **CALL FORWARDED** will display on HS1.
- HS2 will begin ringing and display **INCOMING CALL**.
- Press **TALK/FLASH** on HS2 to answer the call.

If the forwarded call is not answered within 30 seconds, the external call will be returned to HS1 and the screen will display **CALL BACK** and rings for 30 seconds. If the returned call is not answered within 30 seconds, the external call will end automatically .

INTERCOM ENDED

UNABLE TO CALL
TRY AGAIN

CALL FORWARDED

note

- For the **FIND HANDSET** function to work, the system handsets need to be in idle (off) mode.

Handset operation

Call transfer

- The originating handset (HS1) can transfer an external call to another handset (HS2) by pressing **INT**. The external call is put on hold and the screen will display **CALLING OTHER HANDSET**.
- HS2 will ring and display **OTHER HANDSET IS CALLING**.
- HS2 can pick up the transferred call by pressing **TALK/FLASH**.
- An intercom call is established between HS1 and HS2 and they can discuss the call prior to the external call being transferred to HS2. **CALL TRANSFERRED** will display on the HS1.

If the transferred call is not answered within 100 seconds, the external call will be returned to HS1.

Conference call

It is possible to establish a conference call between two handsets and the external line.

While HS1 is on an external call, HS2 can join the call by pressing **TALK**. A conference call will be established.

PHONE 00:00:25

Find Handset

- To locate a lost handset, press **Find Handset** on the base to page all system handsets.
- To end the page at the base, press **Find Handset** again.
- To end the page at the handset, press **TALK**, **SPEAKER** or any dial pad keys (0-9, *, #).

** PAGING **

Voice mail

If you subscribe to voice mail service provided by your telephone company, you can receive voice mail messages from callers. When you have a new voice mail, the screen will display **NEW VOICE MAIL**, and the voice mail indicator will flash.

On how to access your voice mail, contact your local telephone company for further instruction.

HANDSET 1
NEW VOICE MAIL

Telephone directory

Your phone can store up to 50 numbers with names in the directory. Each directory location can hold up to 32 digits for the number and 16 characters for the name. Only one handset can access the directory at a time. **NOT AVAILABLE AT THIS TIME** will be displayed if you try to access the directory when another handset is already using the directory

Store a new entry

- Press **MENU**.
- With **DIRECTORY** selected, press **SEL**.
- Press **▼** to select **STORE**. Press **SEL**.
- You will be prompted to **ENTER NUMBER**. Use the dialing keys to enter the number you wish to store in the directory. Press the **MUTE/REMOVE** key to backspace and make corrections. Press **SEL**.
- You will then be prompted to **ENTER NAME**. Use the dialing keys to spell the name. Press **SEL**.
- You'll hear a confirmation tone, and the new directory entry will display briefly.
- If the directory is full, the handset will display **LIST FULL**.

```
>STORE  
REVIEW
```

```
ENTER NUMBER  
800-595-9511_
```

```
ENTER NAME  
_
```

```
LIST FULL
```

note

- All handsets share a common directory which is stored in the base. Entries inserted into one handset are available for all handsets, and if one deletes a directory entry, it will disappear from all handsets.
- While entering numbers, press and hold **REDIAL/PAUSE** to add pauses if necessary.
- If there is a duplicated number in directory, the display will show **ALREADY SAVED**.

note

- If you wish to store a number from redial memory into the directory, press **REDIAL/PAUSE** then ▲ or ▼ to scroll to the desired redial number from memory. Press **SEL**.

Telephone directory

Characters by number

Pressing any particular key causes different characters to be displayed in the following order:

Key	Characters by number of key presses								
	1	2	3	4	5	6	7	8	9
1	1	#	'	,	-	.	&		
2	A	B	C	2	a	b	c		
3	D	E	F	3	d	e	f		
4	G	H	I	4	g	h	i		
5	J	K	L	5	j	k	l		
6	M	N	O	6	m	n	o		
7	P	Q	R	S	7	p	q	r	s
8	T	U	V	8	t	u	v		
9	W	X	Y	Z	9	w	x	y	z
0	0								
*	*	?	!	/	()	@		
#	space								

Telephone directory

Review/dial from the directory

- Press **MENU**, when **DIRECTORY** is displayed, press **SEL**. With **REVIEW** in the first line, press **SEL**.

- OR -

With the handset in idle, press **▲** to enter the directory review mode. The first directory entry will be displayed.

- Scroll through the directory entries using **▲** and **▼** or enter the first character of the name to be searched (using the digit keys). Continue navigating using the **▲** or **▼** scroll keys, until you reach the entry to be dialed.
- Press **TALK** or **SPEAKER** to dial the number.

Edit a directory entry

- Follow the steps in **Review/dial from the directory** (above) to reach the entry to be edited.
- Press **SEL** to enter number edit mode.
- Press **MUTE/REMOVE** to backspace and delete numbers, or press **CID ▼** or **DIR ▲** to move the cursor to the number you wish to change. Then re-enter the correct number(s) by pressing the dialing keys (0-9). Press and hold **REDIAL/PAUSE** to add pauses if necessary.

```
>DIRECTORY  
CALL LOG
```

```
EDIT NUMBER  
800-595-9511_
```

note

- When reviewing the phonebook, the second line of the display will show the number, up to 16 digits. For numbers longer than 16 digits, only the first 13 digits will be shown. Press **★** or **#** to scroll the phone number to see the additional digits.
- If there are no entries in the directory, when it is accessed, **DIRECTORY EMPTY** will display.

Telephone directory

- Press **SEL**.
- Press **MUTE/REMOVE** to backspace and use the digit keys to enter the correct name.
- Press **SEL**. You'll hear a confirmation tone.

```
EDIT NAME  
VTech Con_
```

Delete a directory entry

- Follow the steps in **Review/dial from the directory** (page 19) to reach the entry to be deleted.
- Press **MUTE/REMOVE** to delete the entry. A confirmation tone will sound.
- The handset will then advance to the next entry, if any.

Caller ID

Caller ID - call waiting ID

Your phone is capable of displaying the number of the calling party before you answer the phone (**Caller ID** or **CID**). If the number is already in the directory, the name of the caller will also be displayed. It is also capable of displaying CID information in conjunction with a call waiting alert signal (**call waiting caller ID**). With call waiting caller ID, the CID data is displayed so you can decide whether to answer the incoming call, or continue with your current conversation. Your phone can hold up to 50 CID entries.

NOTES ABOUT CALLER ID & CALL WAITING CALLER ID These are subscription services, provided by most regional telephone service providers. You must subscribe to these services to get the benefits of these features. If you do not subscribe to CID services, you can still use your phone and the other features it offers.

Due to regional incompatibilities, CID information may not be available for every incoming call. In addition, the calling parties may intentionally block their name and/or phone number from being sent.

- As new CID/call waiting ID records are received, your handset displays will alert you to the new CID records, for example:

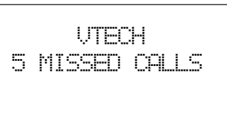

VTECH
5 MISSED CALLS

- After you review all new CID records, the **NEW** call indicator will be turned off and the screen will show:

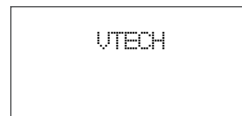

VTECH

note

- If you answer a call before the information appears on the screen, it will not be in the caller ID log.
- Press **OFF** any time to exit caller ID log.
- The **NEW** icon in the lower left corner indicates the call has not yet been reviewed.

Caller ID

- If the call log is full, the oldest entry is deleted to make room for the new call. If the call log is empty when you try to enter to call log review, the following message is displayed:

CALL LOG EMPTY

Review caller ID

You can review the CID records via the menu as described below, or by pressing ▼ while in idle, and the handset moves directly to CID review.

- In idle mode, press **MENU**.
- Press ▼ to scroll to the **CALL LOG** option.
- Press **SEL**. Use ▲ and ▼ to scroll through the call log entries. When the beginning or the end of the call log is reached, a double beep will sound.

>CALL LOG
RINGER VOLUME

Store caller ID

- Follow the steps in **Review caller ID** (above) to scroll to the record to be stored.
- To view alternate dialing sequences, press the # key repeatedly. The screen will scroll through the various dialing options (1 + area code + number, area code + number, 1 + number, number only). Press **SEL** to store the displayed number. The various dialing options are:
- If the CID record contains both name and number, the CID will be stored after pressing **SEL**.
- If the CID record does not contain a name, you will be prompted to **EDIT NAME** and the screen will show:

595-9511
1-595-9511
800-595-9511
1-800-595-9511

EDIT NAME
VTech Com_

Caller ID

- If the CID record does not contain a number, you will be prompted to **EDIT NUMBER**, and the screen will show:
- A confirmation beep will sound and the screen will display:
- If both name and number are missing, for example, as in a private listing, the request will be rejected with the message:
- If the number already exists in the directory, the entry will not be stored, and the screen will show:
- If the directory is full, the screen will show:



EDIT NUMBER
800-595-9511_



SAVED

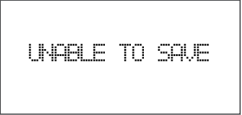

UNABLE TO SAVE



ALREADY
SAVED

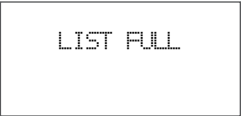

LIST FULL

Caller ID

Dial from caller ID

- Follow the steps in **Review caller ID** (page 22) to scroll to the entry to be dialed.
- To change how the number will be dialed, press # repeatedly. The screen will scroll through the dialing options:
Press  /**FLASH** or **SPEAKER** key to dial the number.



595-9511
1-595-9511
800-595-9511
1-800-595-9511

Delete caller ID

- Follow the steps in **Review caller ID** (page 22) to scroll to the record to be deleted.
- Press the **MUTE/REMOVE** key to delete the desired record. A confirmation beep will sound and the previous CID record will be displayed on the screen.
- To delete all the CID records, press and hold the **MUTE/REMOVE** key. The screen will ask if you want to **DELETE ALL CALLS?** Press **SEL** to confirm. Press **OFF** to return to the CID record previously displayed.



DELETE ALL
CALLS?

Handset settings

Ringer volume

- From the idle (off) mode, press **SEL** then ▲ or ▼ until **RINGER VOLUME** is shown.
- Press **SEL**. The current ringer volume will be shown:
- Press ▲ and ▼ or enter a digit (0 through 6) to the desired ringer volume. The current ring tone will play and the volume bar is increased or decreased each time the setting is adjusted. At the lowest setting the display will show:
- OR -
- From idle (off) mode, press the +/- volume control keys on the side of the handset to directly enter the **RINGER VOLUME** menu.
- Press ▲ and ▼ to the desired ringer volume.

Ring tone

- From the idle (off) mode, press **SEL** then ▲ or ▼ until **RINGER TONE** is displayed.
- Press **SEL**. You can then use ▲ or ▼ or enter a digit (0 through 9) to sample the ring tone.
- Press **SEL** to confirm.

Key tone

- From the idle (off) mode, press **SEL** then ▲ or ▼ to **KEY TONE**.
- Press **SEL**. The current setting will be shown. Press ▲ or ▼ to scroll to **ON** or **OFF**. When set to **ON**, the handset will emit a beep whenever a key is pressed.
- When the desired option is shown, press **SEL**.

Handset name (preset to VTECH)

- You can give each handset its own unique name (such as kitchen or office). The name is shown in the first line when the handset is idle. The name can be a up to 16 characters in length.

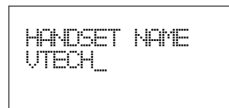
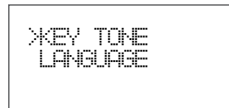
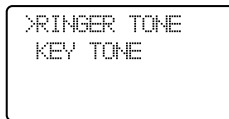

note

- The handset will not ring when a call comes in if ringer volume is set at the lowest setting.

note

- The clear voice mail function only cancels the voice mail indicator on the screen of the handset.
- When the phone is set for pulse dial mode, it is possible to switch to temporary tone mode during an outgoing call by pressing ***TONE**. Once pressed, tone will be used for rest of the call. After you hang up, the phone will return to pulse dialing for the next call.

Handset settings

- From idle (off) mode, press **SEL** then ▲ or ▼ to **HANDSET NAME**.
- Press **SEL**. The display will show the current setting, for example:
- Press **DELETE** to backspace then enter the desired name.

NOTE: The characters are entered in the same way as for the telephone directory, see the table on page 18.

- Press **SEL** to confirm.

Language (preset to English)

- From the idle (off) mode, press **MENU** then ▲ or ▼ to **LANGUAGE**.
- Press **SEL**. Press ▲ or ▼ to select from English, Spanish or French.
- Press **SEL** to confirm.

Clear voice mail

- From the idle (off) mode, press **MENU** then ▲ or ▼ to **CLR VOICE MAIL**.
- Press **SEL**.
- Press **SEL** again to confirm or press **OFF** to exit.

Dial type (preset to tone)

- From idle (off) mode, press **MENU** then ▲ or ▼ to **DIAL TYPE**.
- Press **SEL** then ▲ or ▼ to scroll to **TONE** or **PULSE**.
- Press **SEL** to confirm.

```
HANDSET NAME  
Kitchen_
```

```
LANGUAGE  
ENGLISH
```

```
>CLR VOICE MAIL  
DIAL TYPE
```

```
TURN INDICATOR  
OFF?
```

```
>DIAL TYPE  
DIRECTORY
```

```
DIAL TYPE  
PULSE
```

Headset operation

Headset

You can use this telephone handsfree when you install any VTech 2.5 mm headset, purchased separately.

Plug the headset into the jack located on the left side of the handset (under the small rubber flap). Do not force the connection, but make sure the plug fits securely.

Operating range

This cordless telephone operates within the maximum power allowed by the Federal Communications Commission (FCC). Even so, this handset and base can communicate only over a certain distance - which can vary with the locations of the base and handset, the weather, and the construction of your home or office.

If you receive a call while you are out of range, the handset might not ring or if it does ring, the call might not connect well when you press **TALK**. Move closer to the base, then press **TALK** to answer the call.

If you move out of range during a phone conversation, you might hear noise or interference. To improve reception, move closer to the base.

If you move out of range without pressing **OFF**, the phone will be left off the hook. To hang up properly, walk back into range, periodically pressing **OFF**.



note

- To purchase a headset, visit us on the web at www.vtechphones.com or call VTech Customer Service at 1-800-595-9511. In Canada, contact VTech Telecommunications Canada Ltd. at www.vtechcanada.com or 1-800-267-7377.

note

- If you repeatedly get a low battery indicator, even after charging overnight, the battery should be replaced.
- To reduce the risk of fire or injury to persons or damage to the telephone, read and follow these instructions carefully.
- Charge the battery provided or identified for use with this product in accordance with the instructions and limitations specified in this user's manual.

Batteries

Battery care and performance

After the battery is fully charged, you can expect the following performance:

Operation	Operating time
While in use (talking)	up to 7 hours
While not in use (standby*)	up to 3 days

* Handset is off the base unit or charger but not in use.

- The battery needs charging when:
 - A new battery is installed in the handset.
 - The phone beeps twice every five seconds.
 - The screen displays **LOW BATTERY** and the low battery icon.
- Place the handset in the base so the **CHARGE** light turns on. The battery is usually fully charged in about 16 hours.
- You can keep the battery fully charged by returning the handset to the base or charger after each use.

Replace the handset battery

1. Remove the battery compartment cover on the handset by pressing on the indentation and sliding the cover downward.
2. Lift out the old battery and disconnect.
3. Align the two holes in the new battery's plug with the socket pins, and snap the plug into place. Snap the battery in the compartment, as described in **Installation**, on page 5.
4. Replace the cover by sliding it up into place.
5. The new battery must be fully charged before using the phone. Place the handset in the base or charger and allow it to charge for at least 16 hours the first charge. The telephone might operate before that, but for best performance, let the battery charge fully.

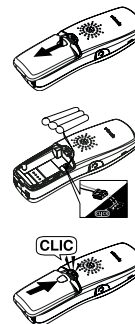

Additional Information

Troubleshooting

If you have difficulty operating your phone, the suggestions below should solve the problem. If you still have difficulty after trying these suggestions, call VTech Communications at 1-800-595-9511. In Canada, call VTech Telecommunications Canada Ltd. at 1-800-267-7377.

Problem	Suggestion
My phone doesn't work at all.	<ul style="list-style-type: none">• Make sure the power cord is plugged in.• Make sure the telephone line cord is plugged firmly into the base unit and the telephone wall jack.• Disconnect the AC adaptor for a few minutes, and then reconnect it.• Charge the battery in the handset for at least 16 hours. For optimum daily performance, return the handset to its base when not in use.• Reset the base. Unplug the unit's electrical power. Wait for 15 seconds then plug it back in. Allow up to one minute for the handset and base to reset.• You may need to purchase a new battery, please refer to the Batteries section of this user's manual.
I cannot get a dial tone.	<ul style="list-style-type: none">• Try all the suggestions above.• Move the handset closer to the base. You might have moved out of range.• Your line cord might be malfunctioning. Try installing a new line cord.• If the previous suggestions don't work, disconnect the base unit from the telephone jack and connect a different phone. If there is no dial tone on that phone either, the problem is in your wiring or local service. Contact your local telephone company.

Troubleshooting

Problem	Suggestion
I cannot dial out.	<ul style="list-style-type: none">• Make sure you have a dial tone before dialing. The handset may take a second or two to find the base and produce a dial tone. This is normal. Wait an extra second before dialing.• Make sure your phone is set to the correct dial mode for the type of service that you have (pulse or touch tone). Refer to the dial mode section of this user's manual.• If the other phones in your home are having the issue, the problem is in your wiring or local service. Contact your local telephone company.• Eliminate any background noise. Noise from a television, radio or other appliance may cause the phone not to dial out properly. If you cannot eliminate the background noise, first try muting the handset before dialing, or dialing from another room in your home with less background noise.
UNABLE TO CALL TRY AGAIN displays on my handset.	<ul style="list-style-type: none">• Move the handset closer to the base. You might have moved out of range.• If the handset is in its base and the charging light does not light, refer to the Charge light is off section in this troubleshooting guide.• Reset the base. Unplug the unit's electrical power. Wait for 15 seconds then plug it back in. Allow up to one minute for the handset and base to reset.• Other electronic products can cause interference with your cordless phone. Try installing your phone as far away from these types of electronic devices as possible: wireless routers, radios, radio towers, pager towers, cell phones, intercoms, room monitors, televisions, personal computers, kitchen appliances and other cordless phones.
The battery does not hold a charge.	<ul style="list-style-type: none">• Charge the battery in the handset for 16 hours. For optimum daily performance, return the handset to its base when not in use.• You may need to purchase a new battery, please refer to the Batteries section of this user's manual.• Your phone might be malfunctioning. Please refer to the Warranty section of this user's manual for further instruction.

Troubleshooting

Problem	Suggestion
If you subscribe to DSL service	<ul style="list-style-type: none">• If you hear noise during conversations and/or your caller ID features aren't functioning properly, install a noise filter to the telephone line between the base unit and the telephone line jack. Contact your DSL provider to obtain a noise filter.
I get noise, static, or weak signal even when I'm near the base.	<ul style="list-style-type: none">• Other cordless phones and 802.11 wireless routers that are used for home computer networks both use internal radios to communicate. The radios may interfere with one another. You can improve the performance of your cordless phones and your router by:<ol style="list-style-type: none">a. positioning your new phone as far away as possible from any other existing cordless telephone system that is already installed in your home to avoid the two systems interfering with each other.b. positioning your telephone base as far as possible from your router, computer or any other computer devices.c. selecting channels four through 10 for your router (refer to your router's user manual for more information).• Other electronic products can cause interference with your cordless phone. Try installing your phone as far away from these types of electronic devices as possible: wireless routers, radios, radio towers, pager towers, cell phones, intercoms, room monitors, televisions, personal computers, kitchen appliances and other cordless phones.• Microwaves operate on the same frequency as your phone. It is normal to experience static on your phone while the microwave is running. Do not install this phone in the same outlet or near the microwave.• If your phone is plugged in with a modem or surge protector, plug the phone (or modem/surge protector) into a different location. If this solves the problem, re-locate your phone or modem farther apart from one another, or use a different surge protector.• Relocate your phone to a higher location. The phone will likely get better reception not installed in a low area.• If the other phones in your home are having the issue, the problem is in your wiring or local service. Contact your local telephone company (charges may apply.)

Troubleshooting

Problem	Suggestion
I hear other calls while using my phone.	<ul style="list-style-type: none">• Disconnect your base unit from the telephone jack, and plug in a regular telephone. If you still hear other calls, the problem is probably in your wiring or local service. Call your local telephone company.
My handset does not ring when I receive a call.	<ul style="list-style-type: none">• Make sure you have the ringer activated. Refer to the section(s) on ringer selection in this user's manual.• Make sure the telephone line cord is plugged firmly into the base unit and the telephone jack. Make sure the power cord is plugged in.• You may be too far from the base unit.• Charge the battery in the handset for 16 hours. For optimum daily performance, return the handset to its base when not in use.• You may have too many extension phones on your telephone line to allow all of them to ring. Try unplugging some of the other phones.• The layout of your home or office might be limiting the operating range. Try moving the base to another location, preferably on an upper floor.• If the other phones in your home are having the issue, the problem is in your wiring or local service. Contact your local telephone company (charges may apply.)• Test a working phone at the phone jack. If another phone has the same problem, the problem is the phone jack. Contact your local telephone company (charges may apply.)• Other electronic products can cause interference with your cordless phone. Try installing your phone as far away from these types of electronic devices as possible: wireless routers, radios, radio towers, pager towers, cell phones, intercoms, room monitors, televisions, personal computers, kitchen appliances and other cordless phones• Your line cord might be malfunctioning. Try installing a new line cord.

Troubleshooting

Problem	Suggestion
My calls fade or cut in and out while I'm using my handset.	<ul style="list-style-type: none">• Other electronic products can cause interference with your cordless phone. Try installing your phone as far away from these types of electronic devices as possible: wireless routers, radios, radio towers, pager towers, cell phones, intercoms, room monitors, televisions, personal computers, kitchen appliances and other cordless phones• Microwaves operate on the same frequency as your phone. It is normal to experience static on your phone while the microwave is running. Do not install this phone in the same outlet or near the microwave.• If your phone is plugged in with a modem or surge protector, plug the phone (or modem/surge protector) into a different location. If this solves the problem, re-locate your phone or modem farther apart from one another, or use a different surge protector.• Relocate your phone to a higher location. The phone will get better reception not installed in a low area.• If the other phones in your home are having the issue, the problem is in your wiring or local service.
The charge light is off.	<ul style="list-style-type: none">• Clean the handset and base charging contact each month using a pencil eraser or cloth.• Make sure the power and line cords are plugged in correctly and firmly.• Reset the base. Unplug the unit's electrical power. Wait for 15 seconds then plug it back in. Allow up to one minute for the handset and base to reset.• Your phone might be malfunctioning. Please refer to the Warranty section of this user's manual for further instruction.

Troubleshooting

Problem	Suggestion
My Caller ID isn't working.	<ul style="list-style-type: none">• Caller ID is a subscription service. You must subscribe to this service for this feature to work on your phone.• Your caller must be calling from an area that supports caller ID.• Both you and your caller's telephone companies must use caller ID compatible equipment.
Common cure for electronic equipment.	<p>If the unit does not seem to be responding normally, then try putting the handset in its base. If it does not seem to respond, do the following (in the order listed):</p> <ol style="list-style-type: none">1. Disconnect the power to the base.2. Disconnect the handset battery, and spare battery, if applicable.3. Wait a few minutes.4. Connect power to the base.5. Re-install the battery(ies).6. Wait for the handset to re-establish its link with the base. To be safe, allow up to one minute for this to take place.

Maintenance

Taking care of your telephone

Your cordless telephone contains sophisticated electronic parts, so it must be treated with care.

Avoid rough treatment

Place the handset down gently. Save the original packing materials to protect your telephone if you ever need to ship it.

Avoid water

Your telephone can be damaged if it gets wet. Do not use the handset outdoors in the rain, or handle it with wet hands. Do not install your base unit near a sink, bathtub or shower.

Electrical storms

Electrical storms can sometimes cause power surges harmful to electronic equipment. For your own safety, use caution when using electric appliances during storms.

Cleaning your telephone

Your telephone has a durable plastic casing that should retain its luster for many years. Clean it only with a soft cloth slightly dampened with water or a mild soap. Do not use excess water or cleaning solvents of any kind.

Remember that electrical appliances can cause serious injury if used when you are wet or standing in water. If your base unit should fall into water, DO NOT RETRIEVE IT UNTIL YOU UNPLUG THE POWER CORD AND TELEPHONE LINE CORDS FROM THE WALL. Then pull the unit out by the unplugged cords.

Warranty

What does this limited warranty cover?

- The manufacturer of this VTech product, VTech Communications, warrants to the holder of a valid proof of purchase ("Consumer" or "you") that the product and all accessories provided by VTech in the sales package ("Product") are free from material defects in material and workmanship, pursuant to the following terms and conditions, when installed and used normally and in accordance with operation instructions. This limited warranty extends only to the Consumer for Products purchased and used in the United States of America.

What will VTech Communications do if the Product is not free from material defects in materials and workmanship during the limited warranty period ("Materially Defective Product")?

- During the limited warranty period, VTech's authorized service representative will repair or replace at VTech's option, without charge, a Materially Defective Product. If we repair this product, we may use new or refurbished replacement parts. If we choose to replace this product, we may replace it with a new or refurbished product of the same or similar design. VTech will return repaired or replacement products to you in working condition. VTech will retain defective parts, modules, or equipment. Repair or replacement of Product, at VTech's option, is your exclusive remedy. You should expect the repair or replacement to take approximately 30 days.

How long is the limited warranty period?

- The limited warranty period for the product extends for ONE (1) YEAR from the date of purchase if we repair or replace a Materially Defective Product under the terms of this limited warranty. This limited warranty also applies to repaired or replacement Products for a period of either (a) 90 days from the date the repaired or replacement Product is shipped to you or (b) the time remaining on the original one-year warranty; whichever is longer.

What is not covered by this limited warranty?

This limited warranty does not cover

1. Product that has been subjected to misuse, accident, shipping or other physical damage, improper installation, abnormal operation or handling, neglect, inundation, fire, water or other liquid intrusion; or
2. Product that has been damaged due to repair, alteration or modification by anyone other than an authorized service representative of VTech; or
3. Product to the extent that the problem experienced is caused by signal conditions, network reliability or cable or antenna systems; or
4. Product to the extent that the problem is caused by use with non-VTech electrical accessories; or

Warranty

5. Product whose warranty/quality stickers, Product serial numbers plates or electronic serial numbers have been removed, altered or rendered illegible; or
6. Product purchased, used, serviced, or shipped for repair from outside the United States, or used for commercial or institutional purposes (including but not limited to Products used for rental purposes); or
7. Product returned without valid proof of purchase (see 2 below); or
8. Charges for installation or set up, adjustment of customer controls, and installation or repair of systems outside the unit.

How do you get warranty service?

- To obtain warranty service in the United States of America, call 1-800-595-9511 for instructions regarding where to return the Product. Before calling for service, please check the user's manual. A check of the Product controls and features may save you a service call.
- Except as provided by applicable law, you assume the risk of loss or damage during transit and transportation and are responsible for delivery or handling charges incurred in the transport of Product (s) to the service location. VTech will return repaired or replaced product under this limited warranty to you, transportation, delivery or handling charges prepaid. VTech assumes no risk for damage or loss of the Product in transit.
- If the Product failure is not covered by this limited warranty, or proof of purchase does not meet the terms of this limited warranty, VTech will notify you and will request that you authorize the cost of repair prior to any further repair activity. You must pay for the cost of repair and return shipping costs for the repair of Products that are not covered by this limited warranty.

What must you return with the Product to get warranty service?

1. Return the entire original package and contents including the Product to the VTech service location along with a description of the malfunction or difficulty;
2. Include "valid proof of purchase" (sales receipt) identifying the Product purchased (Product model) and the date of purchase or receipt; and
3. Provide your name, complete and correct mailing address, and telephone number.

Other Limitations

- This warranty is the complete and exclusive agreement between you and VTech. It supersedes all other written or oral communications related to this Product. VTech provides no other warranties for this product. The warranty exclusively describes all of VTech's responsibilities regarding the product. There are no other express warranties. No one is authorized to make modifications to this limited warranty and you should not rely on any such modification.

State Law Rights: This warranty gives you specific legal rights, and you may also have other rights which vary from state to state.

Limitations: Implied warranties, including those of fitness for a particular purpose and merchantability (an unwritten warranty that the product is fit for ordinary use) are limited to one year from date of purchase. Some states do not allow limitations on how long an implied warranty lasts, so the above limitation may not apply to you.

- In no event shall VTech be liable for any indirect, special, incidental, consequential, or similar damages (including, but not limited to lost profits or revenue, inability to use the product, or other associated equipment, the cost of substitute equipment, and claims by third parties) resulting from the use of this product. Some states do not allow the exclusion or limitation of incidental or consequential damages, so the above limitation or exclusion may not apply to you.

Important safety instructions

When using your telephone equipment, basic safety precautions should always be followed to reduce the risk of fire, electric shock and injury, including the following:

1. Read and understand all instructions.
2. Follow all warnings and instructions marked on the product.
3. Unplug this product from the wall outlet before cleaning. Do not use liquid or aerosol cleaners. Use a damp cloth for cleaning.
4. Do not use this product near water (for example, near a bath tub, kitchen sink or swimming pool).
5. Do not place this product on an unstable surface, such as a table, shelf or stand. The product may fall, causing serious damage.
6. Slots and openings in the back or bottom of the base unit and handset are provided for ventilation. To protect them from overheating, these openings must not be blocked by placing the product on a soft surface such as a bed, sofa or rug. This product should never be placed near or over a radiator or heat register. This product should not be placed in any area where proper ventilation is not provided.
7. This product should be operated only from the type of power source indicated on the marking label. If you are not sure of the type of power supply in your home, consult your dealer or local power company.
8. Do not allow anything to rest on the power cord. Do not install this product where the cord may have anyone walking on it.
9. Never push objects of any kind into this product through slots in the base or handset as they may touch dangerous voltage points or short out parts that could result in a risk of fire or electric shock. Never spill liquid of any kind on the product.
10. To reduce the risk of electric shock, do not disassemble this product, but take it to an authorized service facility. Opening or removing parts of the base or handset other than specified access doors may expose you to dangerous voltages or other risks. Incorrect reassembling can cause electric shock when the product is subsequently used.
11. Do not overload wall outlets and extension cords as this can result in the risk of fire or electric shock.
12. Unplug this product from the wall outlet and refer servicing to an authorized service facility under the following conditions:
 - A. When the power supply cord or plug is damaged or frayed.
 - B. If liquid has been spilled onto the product.
 - C. If the product has been exposed to rain or water.
 - D. If the product does not operate normally by following the operating instructions. Adjust only those controls that are covered by the operating instructions, as improper adjustment of other controls may result in damage and often requires extensive work by an authorized technician to restore the product to normal operation.
 - E. If the product has been dropped and the base and/or handset has been damaged.
 - F. If the product exhibits a distinct change in performance.
13. Avoid using a telephone (other than cordless) during an electrical storm. There is a remote risk of electric shock from lightning.
14. Do not use the telephone to report a gas leak in the vicinity of the leak.
15. Only put the handset of your telephone next to your ear when it is in normal talk.

SAVE THESE INSTRUCTIONS

FCC, ACTA and IC regulations

FCC Part 15

This equipment has been tested and found to comply with the requirements for a Class B digital device under Part 15 of the Federal Communications Commission (FCC) rules. These requirements are intended to provide reasonable protection against harmful interference in a residential installation. This equipment generates, uses and can radiate radio frequency energy and, if not installed and used in accordance with the instructions, may cause harmful interference to radio communications. However, there is no guarantee that interference will not occur in a particular installation. If this equipment does cause harmful interference to radio or television reception, which can be determined by turning the equipment off and on, the user is encouraged to try to correct the interference by one or more of the following measures:

- * Reorient or relocate the receiving antenna.
- * Increase the separation between the equipment and receiver.
- * Connect the equipment into an outlet on a circuit different from that to which the receiver is connected.
- * Consult the dealer or an experienced radio/TV technician for help.

Changes or modifications to this equipment not expressly approved by the party responsible for compliance could void the user's authority to operate the equipment.

To ensure safety of users, the FCC has established criteria for the amount of radio frequency energy that can be safely absorbed by a user or bystander according to the intended usage of the product. This product has been tested and found to comply with the FCC criteria. The handset may be safely held against the ear of the user. The base unit shall be installed and used such that parts of the user's body other than the hands are maintained at a distance of approximately 20 cm (8 inches) or more. If you choose to use a clipping device, please make sure to only use the supplied VTech belt clip.

FCC Part 68 and ACTA

This equipment complies with Part 68 of the FCC rules and with technical requirements adopted by the Administrative Council for Terminal Attachments (ACTA). The label on the back or bottom of this equipment contains, among other things, a product identifier in the format US:AAAEQ##TXXXX. This identifier must be provided to your local telephone company upon request.

The plug and jack used to connect this equipment to premises wiring and the telephone network must comply with applicable Part 68 rules and technical requirements adopted by ACTA. A compliant telephone cord and modular plug is provided with this product. It is designed to be connected to a compatible modular jack that is also compliant. An RJ11 jack should normally be used for connecting to a single line and an RJ14 jack for two lines. See Installation Instructions in the user's manual.

The Ringer Equivalence Number (REN) is used to determine how many devices you may connect to your telephone line and still have them ring when you are called. The REN for this product is encoded as the 6th and 7th characters following the US: in the product identifier (e.g., if ## is 03, the REN is 0.3). In most, but not all areas, the sum of all RENs should be five (5.0) or less. For more information, please contact your local telephone company.

This equipment may not be used with Party Lines. If you have specially wired alarm dialing equipment connected to your telephone line, ensure the connection of this equipment does not disable your alarm equipment. If you have questions about what will disable alarm equipment, consult your telephone company or a qualified installer.

If this equipment is malfunctioning, it must be unplugged from the modular jack until the problem has been corrected. Repairs to this telephone equipment can only be made by the manufacturer or its authorized agents. For repair procedures, follow the instructions outlined under the Limited Warranty.

If this equipment is causing harm to the telephone network, the telephone company may temporarily discontinue your telephone service. The telephone company is required to notify you before interrupting service. If advance notice is not practical, you will be notified as soon as possible. You will be given the opportunity to correct the problem and the telephone company is required to inform you of your right to file a complaint with the FCC. Your telephone company may make changes in its facilities, equipment, operation, or procedures that could affect the proper functioning of this product. The telephone company is required to notify you if such changes are planned.

FCC, ACTA and IC regulations

If this product is equipped with a corded or cordless handset, it is hearing aid compatible.

If this product has memory dialing locations, you may choose to store emergency telephone numbers (e.g., police, fire, medical) in these locations. If you do store or test emergency numbers, please:

- * Remain on the line and briefly explain the reason for the call before hanging up.
- * Perform such activities in off-peak hours, such as early morning or late evening.

Industry Canada

This equipment complies with regulations RSS210 and CS-03 of Industry Canada. Operation is subject to the following two conditions: (1) this device may not cause interference, and (2) this device must accept any interference, including interference that may cause undesired operation of the device.

The term "IC:" before the certification/registration number only signifies that the Industry Canada technical specifications were met.

The Ringer Equivalence Number (REN) for this terminal equipment is 0.1. The REN is an indication of the maximum number of devices allowed to be connected to a telephone interface. The termination on an interface may consist of any combination of devices subject only to the requirement that the sum of the RENs of all the devices does not exceed five.

The RBRC® Seal



The RBRC® Seal on the nickel-metal-hydride battery indicates that VTech Communications, Inc. is voluntarily participating in an industry program to collect and recycle these batteries at the end of their useful lives, when taken out of service within the United States and Canada.

The RBRC® program provides a convenient alternative to placing used nickel-metal-hydride batteries into the trash or municipal waste, which may be illegal in your area.

VTech's participation in RBRC® makes it easy for you to drop off the spent battery at local retailers participating in the RBRC® program or at authorized VTech product service centers. Please call **1-800-8-BATTERY™** for information on Ni-MH battery recycling and disposal bans/restrictions in your area. VTech's involvement in this program is part of its commitment to protecting our environment and conserving natural resources.

RBRC® is a registered trademark of Rechargeable Battery Recycling Corporation.

Technical specifications

Enhanced 5.8GHz technology—your phone operates on a dual band transmission that combines the best of 5.8GHz and 2.4GHz technologies, providing enhanced performance over standard cordless telephones.

Frequency Control	Crystal controlled PLL synthesizer
Transmit Frequency	Base: 5725-5850 MHz Handset: 2400-2483.5 MHz
Receive Frequency	Base: 2400-2483.5 MHz Handset: 5725-5850 MHz
Channels	95
Nominal Effective Range	Maximum power allowed by the FCC and IC. Actual operating range may vary according to environmental conditions at the time of use.
Size	Handset: 150.3mm X 50.3mm X 37.3mm Base: 122.8mm X 108.7mm X 62.3mm Charger: 80mm X 89.3mm X 51mm
Weight	Handset: 120.4 grams Base: 175 grams (with wall mount) Charger: 64.4 grams
Power Requirements	Handset: 600mAH Ni-MH battery Base: 9V DC @ 400mA Charger: 9V DC @ 200mA
Memory	Directory: 50 memory locations, up to 32 digits, 16 characters per location Caller ID: 50 memory locations

Index

A

- Adjust handset volume 13
- Answering calls 13

B

- Base LEDs 12
- Base unit layout 11
- Batteries 28
- Belt clip 8

C

- Caller ID 21–24
- Caller ID - call waiting ID 21
- Characters by number 18
- Check battery indicator 7
- Check for dial tone 8
- Choose location 5
- Clear voice mail 26
- Conference call 16
- Connect power to base unit/
chargers 6
- Connect to phone 6

D

- Delete a directory entry 20
- Delete caller ID 24

- Dial from caller ID 24
- Directory 17
- DSL (internet) 9

E

- Edit a directory entry 19

F

- FCC, ACTA and IC regulations 38
- Find handset 16
- Flash function 13

H

- Handset icons 12
- Handset layout 10
- Handset LEDs 12
- Handset name 41
- Handset operation 13–16
- Handset settings 25–26
- Headset 27
- Headset operation 27

I

- If you subscribe to DSL service 8
- Important safety instructions 37
- Installation 5–9

- Installing handset battery 5
- Internet 9

K

- Key tone 25

L

- Language 26

M

- Maintenance 35
- Making calls 13
- Mute 14

N

- Noise filter 9

O

- Operating range 27

P

- Parts check list 4

R

- Redial 14
- Replace handset battery 28

Index

Review/dial from the directory 19
Review caller ID 22
Ringer volume 25

S

Store a new entry 17
Store caller ID 22

T

Technical specifications 40
Telephone directory 17–20
The RBRC® Seal
Troubleshooting 29

V

Voice mail service 16
Volume 13, 25

W

Wall mounting (optional) 9
Warranty 35

VTECH TELECOMMUNICATION LTD.

A member of THE VTECH GROUP OF COMPANIES.

Distributed in the U.S.A. by VTech Communications, Inc. Beaverton, Oregon

Distributed in Canada by VTech Telecommunications Canada Ltd., Richmond, B.C.

Copyright ©2005 for VTECH TELECOMMUNICATIONS LTD.

Printed in China.

91-000470-030-000

vtech[®]
Innovation Beyond Technology



User's Manual

www.vtechphones.com

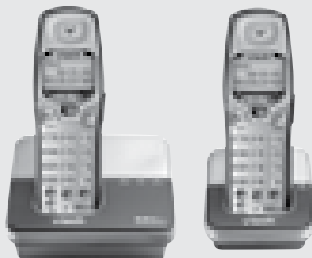

Model: i6725

Download from www.somanuals.com. All Manuals Search And Download.

5.8
GHz
DIGITAL

Free Manuals Download Website

<http://myh66.com>

<http://usermanuals.us>

<http://www.somanuals.com>

<http://www.4manuals.cc>

<http://www.manual-lib.com>

<http://www.404manual.com>

<http://www.luxmanual.com>

<http://aubethermostatmanual.com>

Golf course search by state

<http://golfingnear.com>

Email search by domain

<http://emailbydomain.com>

Auto manuals search

<http://auto.somanuals.com>

TV manuals search

<http://tv.somanuals.com>