

vtech[®]
Innovation Beyond Technology™



User's manual

www.vtechphones.com

Models:
DS6111-2/
DS6111-3/
DS6111-4

Download from Www.Somanuals.com. All Manuals Search And Download.

DECT 6.0

Congratulations

on purchasing your new VTech product.
Before using this telephone, please read the
Important safety instructions
on page 40 of this manual.

This manual has all the feature operations and troubleshooting necessary to install and operate your new VTech telephone. Please review this manual thoroughly to ensure proper installation and operation of this innovative and feature rich VTech product. For support, shopping, and everything new at VTech, visit our website at www.vtechphones.com.

In Canada, please visit www.vtechcanada.com.



The ENERGY STAR® program (www.energystar.gov) recognizes and encourages the use of products that save energy and help protect our environment. We are proud to mark this product with the ENERGY STAR® label indicating it meets the latest energy efficiency guidelines.

Table of contents

| | | | |
|---|-----------|---|----|
| Getting started | 1 | Mute. | 13 |
| Parts checklist | 1 | Ringer mute. | 13 |
| Telephone base and charger installation | 2 | Call waiting | 13 |
| Battery installation and charging | 3 | Chain dialing | 14 |
| Mounting bracket installation | 4 | Find handset | 14 |
| Handset layout | 6 | Intercom | 15 |
| Telephone base layout | 7 | Conference call | 16 |
| Telephone settings | 8 | Transfer an external call | 17 |
| Ringer volume (handset) | 8 | Switch between external and intercom calls | 19 |
| Ringer tone | 9 | Answer an incoming call during an intercom call | 20 |
| Key tone | 10 | Directory | 21 |
| Language | 10 | Store a directory entry | 22 |
| Clear voice mail. | 11 | Character chart | 23 |
| Telephone operation | 12 | Search the directory | 24 |
| Make a call | 12 | Dial a directory entry | 24 |
| Answer a call | 12 | Edit a directory entry | 25 |
| End a call | 12 | Delete from the directory | 26 |
| Speakerphone | 12 | About caller ID | 27 |
| Volume | 12 | Call log | 28 |

Table of contents

| | | | |
|--|-----------|--|----|
| Missed calls indicator | 29 | The RBRC® seal | 50 |
| Review the call log | 29 | Warranty | 51 |
| Make a call log entry ready to dial | 30 | FCC, ACTA and IC regulations | 53 |
| Dial a call log entry | 30 | Technical specifications | 55 |
| Save a call log entry to the directory | 31 | Index | 56 |
| Delete from the call log | 32 | | |
| Call log display screen messages | 33 | | |
| Redial list | 34 | | |
| Dial a redial entry | 34 | | |
| Delete from redial | 34 | | |
| Appendix | 35 | | |
| Handset display screen messages | 35 | | |
| Handset and telephone base indicators | 37 | | |
| Battery | 39 | | |
| Important safety instructions | 40 | | |
| Troubleshooting | 41 | | |
| Operating range | 49 | | |
| Maintenance | 49 | | |
| About cordless telephones | 50 | | |

Getting started

Parts checklist

Your telephone contains the following items. Save your sales receipt and original packaging in the event warranty service is necessary.



1. Handsets
(2 for DS6111-2,
3 for DS6111-3,
4 for DS6111-4)



2. Battery compartment covers
(2 for DS6111-2,
3 for DS6111-3,
4 for DS6111-4)

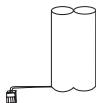

3. Batteries
(2 for DS6111-2,
3 for DS6111-3,
4 for DS6111-4)



4. Telephone line cord



5. Telephone base power adapter

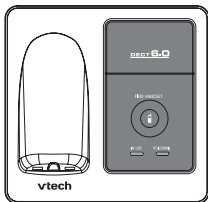

6. Telephone base with mounting bracket

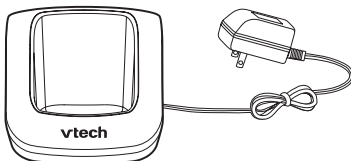

7. Chargers and charger adapters
(1 for DS6111-2,
2 for DS6111-3,
3 for DS6111-4)

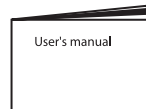

8. User's manual

note

- To purchase replacement batteries or power adapters, visit our website at www.vtechphones.com or call 1 (800) 595-9511. In Canada, go to www.vtechcanada.com or call 1 (800) 267-7377.

note

- Use only the power adapters supplied with this product. To order a replacement, visit our website at www.vtechphones.com or call 1 (800) 595-9511. In Canada, go to www.vtechcanada.com or call 1 (800) 267-7377.
- The telephone base power adapter and the charger adapter(s) are intended to be correctly oriented in a vertical or floor mount position. The prongs are not designed to hold the plug in place if it is plugged into a ceiling or an under-the-table/cabinet outlet.

Getting started

Telephone base and charger installation

Install the telephone base and charger as shown below. Make sure that the electrical outlet is not controlled by a wall switch. If you subscribe to Digital Subscriber Line (DSL) high-speed Internet service through your telephone line, you must have a DSL filter between the telephone base and the telephone wall jack. The filter prevents noise and caller ID problems caused by DSL interference. Please contact your DSL service provider for more information about DSL filters.

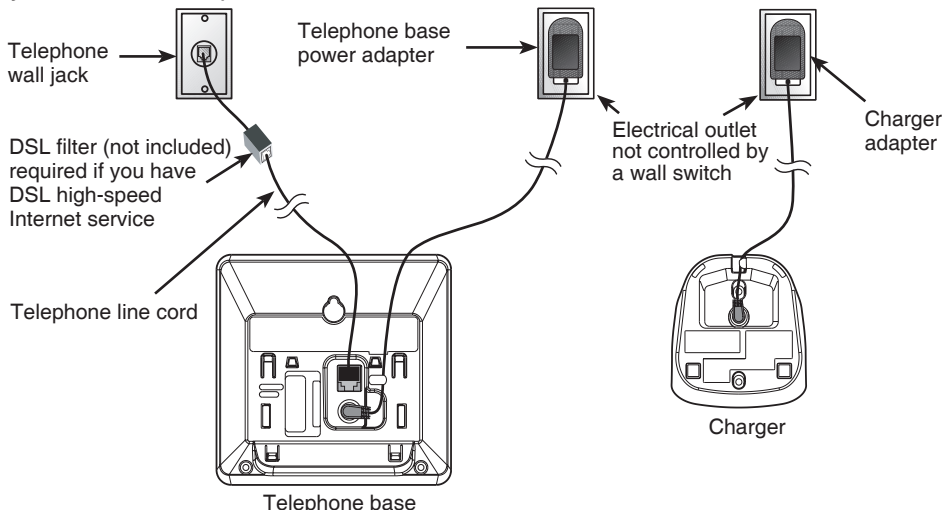

Getting started

Battery installation and charging

Install the battery as shown below. The battery may have enough charge for short calls. For best performance, charge the handset for at least 16 hours. When the battery power is low, the handset will beep, display **LOW BATTERY** and  will flash on the handset screen. Place the handset in the telephone base or charger to charge the battery when not in use. When fully charged, the handset battery provides approximately nine hours of talk time or five days of standby time.

1. Insert the plug of the battery as indicated. Make sure it is plugged securely and matches the color-coded label inside the battery compartment.
2. Place the battery with the label **THIS SIDE UP** facing up and the wires inside the battery compartment.
3. Align the cover flat against the battery compartment, then slide it upwards until it clicks into place.
4. Charge the handset by placing it in the telephone base or the charger. The handset charge light will be on when charging.

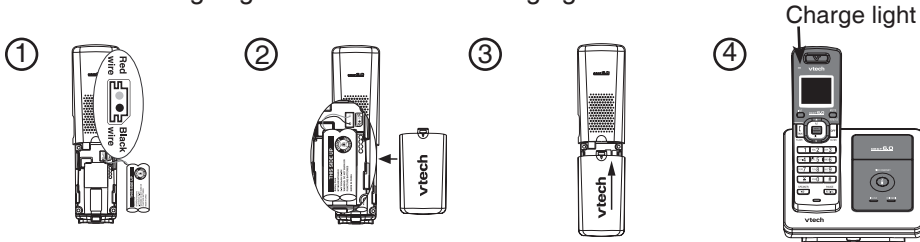

note

- If the handset will not be used for a long time, disconnect and remove the battery to prevent possible leakage.
- To purchase replacement batteries, visit our website at www.vtechphones.com or call 1 (800) 595-9511. In Canada, go to www.vtechcanada.com or call 1 (800) 267-7377.

Getting started

Mounting bracket installation

Your telephone base comes with the mounting bracket installed for desktop use. If you prefer to mount your telephone on the wall (optional), it is designed to mount on a standard telephone wall plate.

Wall mounting bracket installation:

1. Slide the bracket down and away from the telephone base.
2. Tilt the top of the bracket down so that it rests on the base. Align the grooves on the bracket with the tabs on the base. See image 2 below.
3. Slide the bracket down until it clicks into place. See image 3 below.
4. Align the holes on the telephone base with the standard wall plate and slide down until the telephone is secure.

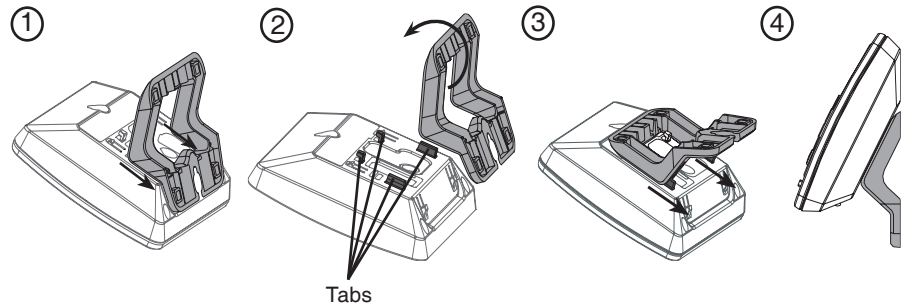

Getting started

Mounting bracket installation (continued)

Desktop/tabletop bracket installation:

Your telephone comes ready for desktop use. If you have repositioned the bracket for wall mounting and now want to return to desktop use, follow the following steps:

1. Remove the bracket from wall mount orientation by sliding it up towards the top of the base.
2. Tilt the top of the bracket up so that the lower portion of the bracket rests on the base. See image 2.
3. Slide the bracket up, onto the tabs towards the center of the telephone base until it clicks into place.

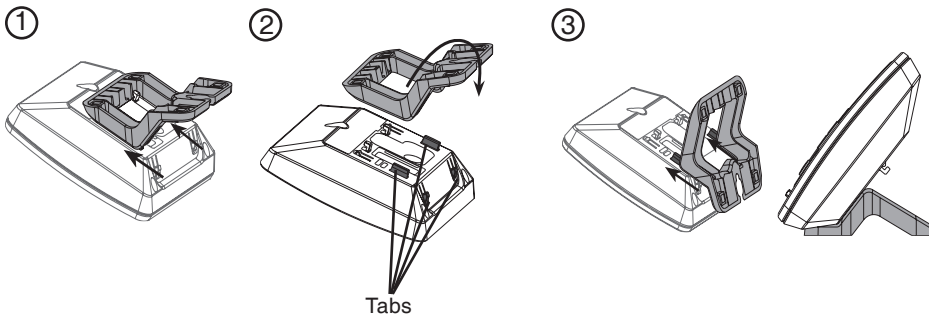

Getting started

Handset layout

CHARGE light

- On when the handset is charging in the telephone base or charger.

INT (intercom)

- Press to initiate an intercom conversation or transfer a call.

TALK/FLASH

- Press to make or answer a call.
- During a call, press to receive an incoming call when you receive a call waiting alert.

▼/CID

- When the handset is not in use, press to review the call log.
- While in the menu, press to scroll down.

SPEAKER

- Press to activate the handset speakerphone.
- Press again to resume normal handset use.

REDIAL/PAUSE

- Press to review the redial list.
- While dialing or entering numbers into the directory, press and hold to insert a dialing pause.

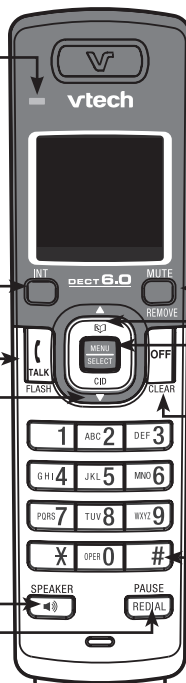

MUTE/REMOVE

- While on a call, press to mute microphone.
- While reviewing the call log, press to delete an individual entry, or press and hold to delete the entire call log.
- Press to delete digits when predialing (preview numbers before dialing).

▲ / (Directory)

- Press to enter the directory when the handset is not in use.
- While in the menu, press to scroll up.

MENU/SELECT

- Press to display the menu.
- When in the menu, press to select an item, or save an entry or setting.

OFF/CLEAR

- During a call, press to hang up.
- While the handset is ringing, press to silence the ringer.
- Press and hold when the handset is not in use to erase the **MISSED CALLS** display.
- During programming, press to exit without making changes.

#

- Press repeatedly to display other dialing options when reviewing a call log entry (page 30).

Getting started

Telephone base layout

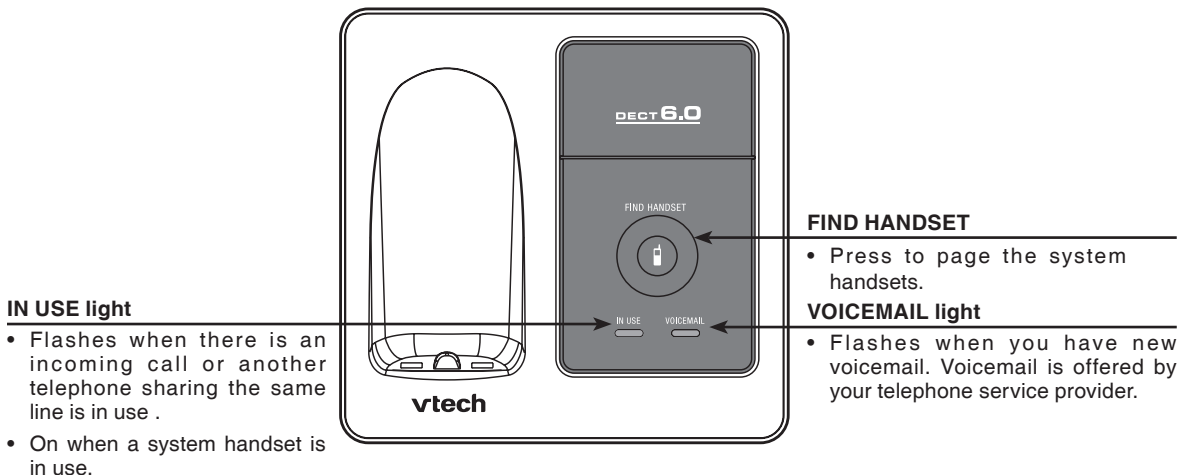

note

- The ringer will be off if the volume is set to zero, and a ringer off icon  will be displayed.

Telephone settings

Ringer volume (handset)

You can change the ringer volume to a comfortable level. The ringer can also be turned off so the telephone does not ring when there are incoming calls.

To adjust the ringer volume:

1. Press **VOL▲** or **VOL▼** to select the desired ringer volume when the handset is not in use.
2. When you stop pressing the volume buttons, the setting will be saved.

-OR-

1. Press **MENU/SELECT** to display the menu when the handset is not in use.
2. Press **▲** or **▼** to select **>RINGER VOLUME**, then press **MENU/SELECT**.
3. Press **▲** or **▼** to adjust the volume. A sample of each ringer volume will be played when scrolling through the choices.
4. Press **MENU/SELECT** to confirm your selection. You will hear a confirmation tone.

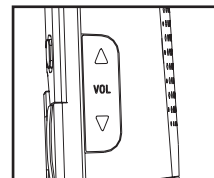

>RINGER VOLUME
RINGER TONE

RINGER VOLUME
■■■■■

Telephone settings

Ringer tone

This menu allows you to choose from different ringer tones.

To choose a ringer tone:

1. Press **MENU/SELECT** to display the menu when the handset is not in use.
2. Press **▲** or **▼** to select **>RINGER TONE**, then press **MENU/SELECT**.
3. Press **▲** or **▼** to select the desired ringer tone. A sample of each ringer tone will be played when scrolling through the choices.
4. Press **MENU/SELECT** to confirm your selection. You will hear a confirmation tone.

```
>RINGER TONE  
KEY TONE
```

```
RINGER TONE  
1
```

note

- If the ringer is turned off while scrolling through the options in the **RINGER TONE** menu, the sample of the ringer will not be heard.

Telephone settings

Key tone

The handset will beep when you press any handset key. You may turn the key tone on or off. To change the setting:

1. Press **MENU/SELECT** to display the menu when the handset is not in use.
2. Press **▲** or **▼** to select **>KEY TONE**, then press **MENU/SELECT**.
3. Press **▲** or **▼** to choose **ON** or **OFF**.
4. Press **MENU/SELECT** to confirm your selection. You will hear a confirmation tone.



```
>KEY TONE
LANGUAGE
```

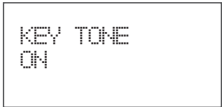

```
KEY TONE
ON
```

Language

You can select **ENGLISH**, **FRANÇAIS** or **ESPAÑOL** to be used in all screen displays. To change the setting:

1. Press **MENU/SELECT** to display the menu when the handset is not in use.
2. Press **▲** or **▼** to select **>LANGUAGE**, then press **MENU/SELECT**.
3. Press **▲** or **▼** to scroll through the choices.
4. Press **MENU/SELECT** to confirm your selection. You will hear a confirmation tone.



```
>LANGUAGE
CLR VOICE MAIL
```



```
LANGUAGE
ENGLISH
```

Telephone settings

Clear voice mail

If you subscribe to voicemail service offered by your telephone service provider, **NEW VOICE MAIL** and  will appear on the handset, and the **VOICEMAIL** light on the telephone base will flash when you have new voicemail messages. Please contact your local telephone company for more information and assistance about using your voicemail service.

After you have listened to all new voicemail messages, the indicators on both the handset and telephone base will be turned off automatically.

Use the clear voicemail feature when the telephone indicates that there is new voicemail but there is none (for example, when you have accessed your voicemail from a different telephone line while away from home). Clearing the voicemail waiting indicator only turns off the indicators; it does not delete your voicemail message(s). If there actually are new voicemail messages, your local telephone company will continue to send the signal which will turn the indicators back on.

To manually turn off these indicators:

1. Press **MENU/SELECT** to display the menu when the handset is not in use.
2. Press **▲** or **▼** to select **>CLR VOICE MAIL**, then press **MENU/SELECT**. The screen displays **TURN INDICATOR OFF?**
3. Press **MENU/SELECT** to confirm your selection. You will hear a confirmation tone.



```
>CLR VOICE MAIL
DIRECTORY
```



```
TURN INDICATOR
OFF?
```

note





- The telephone service provider may alert you to new messages with a stutter (broken) dial tone. Contact your service provider for details.

note

- The screen displays the elapsed time as you talk (in hours, minutes and seconds).
- When predialing (preview numbers before dialing), press **MUTE/REMOVE** or **OFF/CLEAR** to backspace and delete; press and hold **REDIAL/PAUSE** to insert a dialing pause.

Telephone operation

Make a call

1. Press /FLASH or /SPEAKER.
2. Dial the number.
-OR-
 1. Dial the number.
 2. Press /FLASH or /SPEAKER.

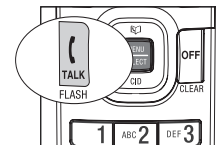

Answer a call

- Press /FLASH, /SPEAKER or any of the dialing key (0-9, #, *).

End a call

- Press **OFF/CLEAR** or put the handset in the telephone base or charger.

Speakerphone

During a call, press /SPEAKER to switch between speakerphone and normal handset use.

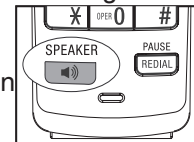

Volume

During a call, use the volume button on the right side of the handset to adjust the listening volume.

- Press **VOL▲** or **VOL▼** to adjust the listening volume to a comfortable level.

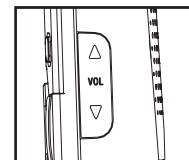

Telephone operation

Mute

The mute function allows you to hear the other party while the other party cannot hear you.

1. During a call, press **MUTE/REMOVE** on the handset. **MUTED** will be temporarily displayed on the screen, along with the smaller **MUTE** icon.
2. Press **MUTE/REMOVE** again to resume the conversation. **MICROPHONE ON** will be temporarily displayed on the screen.

Ringer mute

You can mute the ringer temporarily when the telephone is ringing.

- Press **OFF/CLEAR** or **MUTE/REMOVE** to temporarily silence the ringer. The next call will ring normally.

Call waiting

If you subscribe to call waiting service from your telephone company, you will hear an alert tone if there is an incoming call while you're on another call. Press **TALK/FLASH** to answer the new incoming call. Press **TALK/FLASH** again to return to the original call.

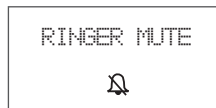
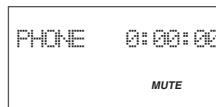
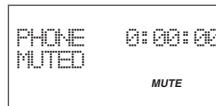
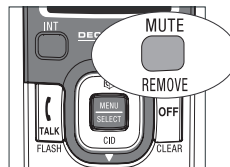

note

- Chain dialing can be useful if you wish to access numbers other than phone numbers (such as bank account information or access codes) from the directory, call log or redial list.

Telephone operation

Chain dialing

This feature allows you to initiate a dialing sequence from numbers stored in the directory, call log or redial list while you are on a call.

To access a number in the directory:

1. Press **MENU/SELECT** twice to enter the directory menu.
2. Scroll by pressing **▲** or **▼** to find the desired entry.
3. Press **MENU/SELECT** to dial the desired number when it is displayed.

To access a number in the call log:

1. Press **MENU/SELECT** and then press **▼** to select **>CALL LOG**.
2. Press **MENU/SELECT** to confirm.
3. Scroll by pressing **▲** or **▼** to find the desired entry.
4. Press **MENU/SELECT** to dial the desired number when it is displayed.

To access the last number in the redial list:

- Press **REDIAL/PAUSE** to dial.
- Press **REDIAL/PAUSE** again within two seconds to cancel the chain dialing.

Find handset

This feature allows the telephone base to page all the handsets.

1. Press **FIND HANDSET** on the telephone base. All the handsets will ring and the screens display **** PAGING ****.
2. Press **(TALK) /FLASH, (SPEAKER)** or any dialing key (**0-9, #, ***) on the handset; or press **FIND HANDSET** on the telephone base to end paging.



Telephone operation

Intercom

The intercom feature allows conversation between two registered handsets of the same system.

Model DS6111-2

1. Press **INT** on the originating handset when the handset is not in use and its screen displays **CALLING OTHER HANDSET**.
2. The destination handset rings and its screen displays **OTHER HANDSET IS CALLING**.
3. To answer the intercom call, press **TALK/FLASH, [SPEAKER], INT** or any dialing key (**0-9,#,***) on the destination handset.
4. To end an intercom call, press **INT, OFF/CLEAR** or place the handset back in the telephone base or charger.

Models DS6111-3/DS6111-4

1. Press **INT** on the originating handset when the handset is not in use. The screen displays **INTERCOM TO:**
2. Use the dialing keys to select the destination handset. The originating handset screen displays **CALLING HANDSET X**.
3. The destination handset rings and its screen displays **HANDSET X IS CALLING**.
4. To answer the intercom call, press **TALK/FLASH, [SPEAKER], INT** or any dialing key (**0-9,#,***) on the destination handset.
5. To end an intercom call, press **INT, OFF/CLEAR** or place the handset back in the telephone base or charger.

note

- If the destination handset does not answer the intercom call within 100 seconds, is in the directory, is in the call log, is on a call, or out of range, the originating handset screen will display **UNABLE TO CALL TRY AGAIN** and return to idle mode.

CALLING
OTHER HANDSET

OTHER HANDSET
IS CALLING

INTERCOM TO:

CALLING
HANDSET X

HANDSET X
IS CALLING

Telephone operation

Conference call

You can have a conference call with an external line and two registered handsets.

When one handset is on the line,

- Press /FLASH or /SPEAKER on another handset to join the call.

-OR-

Model DS6111-2

1. Press **INT** to initiate an intercom call and its screen displays **CALLING OTHER HANDSET**. The destination handset rings and its screen displays **OTHER HANDSET IS CALLING**.
2. After the destination handset has been answered, press and hold **INT** on the originating handset to let the destination handset join the call.

Models DS6111-3/DS6111-4



1. Press **INT** to initiate an intercom call. The screen displays **TRANSFER TO:**
2. Use the dialing keys to select the destination handset. The originating handset screen displays **CALLING HANDSET X**.
3. The destination handset rings and its screen displays **HANDSET X IS CALLING**.
4. After the destination handset has been answered, press and hold **INT** on the originating handset to let the destination handset join the call.

Telephone operation

Transfer an external call

You can transfer an external call from one handset to any other handset.

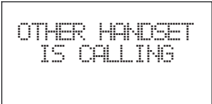
Model DS6111-2

1. During a call, press **INT** to put the call on hold at the originating handset. Its screen displays **CALLING OTHER HANDSET**.

2. The destination handset rings and its screen displays **OTHER HANDSET IS CALLING**.

3. To answer the call at the destination handset, press **TALK**/**FLASH**, **⏏**/**SPEAKER**, **INT** or any dialing key (**0-9**, **#**, *****) on the destination handset.
4. Now the party at the originating handset can have a conversation with the party at the destination handset. Both screens display **INTERCOM**.

5. Press **OFF/CLEAR** on the originating handset, or place it back in the telephone base or charger to transfer the external call to the destination handset. The originating handset displays **CALL TRANSFERED**.

If you wish to cancel call transfer during intercom mode and reconnect to the external call:



- Press **TALK**/**FLASH** on the originating handset.
- OR-**
- Press **OFF/CLEAR** or **INT** on the destination handset, or place it back in the telephone base or charger.

note

- If the destination handset does not pick up the intercom call, the originating handset can return to the external call by pressing **TALK**/**FLASH**, or **OFF/CLEAR** or **INT**.
- If a call remains on hold for about 100 seconds, or if the destination handset is in the directory, in the call log, or out of range, the screen of the originating handset shows **UNABLE TO CALL TRY AGAIN** and reconnects to the external call automatically.

Telephone operation

Models DS6111-3/DS6111-4

1. During a call, press **INT** to put the call on hold at the originating handset. The screen displays **TRANSFER TO:**
 2. Use the dialing keys to enter the destination handset number. The originating handset screen displays **CALLING HANDSET X.**
 3. The destination handset rings and its screen displays **HANDSET X IS CALLING.**
 4. To answer the call at the destination handset, press **(/FLASH, )/SPEAKER, INT** or any dialing key (**0-9, #, ***) on the destination handset.
 5. Now the party at the originating handset can have a conversation with the party at the destination handset. Both screens display **INTERCOM.**
 6. Press **OFF/CLEAR** on the originating handset, or place it back in the telephone base or charger to transfer the external call to the destination handset. The originating handset displays **CALL TRANSFERED.**
- If you wish to cancel call transfer during intercom mode and reconnect to the external call:
- Press **(/FLASH** on the originating handset.
- OR-**
- Press **OFF/CLEAR** or **INT** on the destination handset, or place it back in the telephone base or charger.

TRANSFER TO:

CALLING
HANDSET X

HANDSET X
IS CALLING



INTERCOM

Telephone operation

Switch between external and intercom calls

If you are on an external call and you wish to intercom another handset without disconnecting the external call:

Model DS6111-2

1. During a call, press **INT** to put the call on hold at the originating handset. Its screen displays **CALLING OTHER HANDSET**.
2. The destination handset will ring and its screen will display **OTHER HANDSET IS CALLING**.
3. To answer the call at the destination handset, press  **FLASH**,  **SPEAKER**, **INT** or any dialing key (**0-9, #, ***) on the destination handset.
4. Now the party at the originating handset can have a conversation with the party at the destination handset. Both screens display **INTERCOM**.
5. Press **INT** on the originating handset to alternate between the external call (outside call) and the intercom call.

Telephone operation

Models DS6111-3/DS6111-4

1. During a call, press **INT** to put the call on hold at the originating handset. The screen displays **TRANSFER TO:**
2. Use the dialing keys to enter the destination handset number. The originating handset screen displays **CALLING HANDSET X.**
3. The destination handset will ring and its screen will display **HANDSET X IS CALLING.**
4. To answer the call at the destination handset, press **TALK/FLASH, SPEAKER, INT** or any dialing key (**0-9, #, ***) on the destination handset.
5. Now the party at the originating handset can have a conversation with the party at the destination handset. Both screens display **INTERCOM.**
6. Press **INT** on the originating handset to alternate between the external call (outside call) and the intercom call.

Answer an incoming call during an intercom call

During an intercom call, there will be an alert tone signaling an incoming call.

- To answer the incoming call, press **TALK/FLASH** and the intercom call will end automatically.
- To terminate the intercom call without answering the incoming call, press **OFF/CLEAR** on the handset.

Telephone operation

Directory

The directory can store up to 50 entries. Each entry may have up to 30 digits for the phone number and 15 characters for the name.

- The directory can be accessed when the handset is not in use by pressing  once or **MENU/SELECT** three times.
- The screen will display **DIRECTORY EMPTY** if there are no records in the directory.
- When the directory is full and you attempt to save an entry, the screen will display **LIST FULL**.
- If you attempt to save a number already stored in the directory, the screen will display **ALREADY SAVED**.
- Since the directory is shared by all the handsets, only one handset can review the directory at a time. If a handset attempts to enter the directory while another handset is already in the directory, **NOT AVAILABLE AT THIS TIME** will be displayed.
- If the telephone number in the directory exceeds 15 digits, **<*** will be displayed in front of the telephone number. Press ***** to move to the right of the telephone number or press **#** to move to the left of the telephone number.



DIRECTORY EMPTY

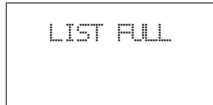

LIST FULL



ALREADY SAVED

note

- Saving or deleting a number on one handset will automatically update the other handset.

Telephone operation

Store a directory entry

1. Press **MENU/SELECT** twice when the handset is not in use.
2. Press **▲** or **▼** to select **>STORE**, then press **MENU/SELECT**. The screen displays **ENTER NUMBER**.
3. Use the dialing keys to enter the number.
 - Press **MUTE/REMOVE** to backspace and erase a digit.
 - Press and hold **MUTE/REMOVE** to erase the entire entry.
 - Press **▼** to move the cursor to the left or **▲** to the right.
 - Press and hold **REDIAL/PAUSE** to insert a dialing pause (**p** will be displayed).

- OR -

 - Copy a number from the redial list by pressing **REDIAL/PAUSE** and then **▲**, **▼** or **REDIAL/PAUSE** to scroll to the desired number. Press **MENU/SELECT** to copy the number.
4. Press **MENU/SELECT** to move on to the name. The screen displays **ENTER NAME**.
5. Use the dialing keys (see the **Character chart** on page 23) to enter the name.
 - Press **MUTE/REMOVE** to backspace and erase a character.
 - Press and hold **MUTE/REMOVE** to erase the entire entry.
 - Press **▼** to move the cursor to the left or **▲** to the right.
 - Press **#** to insert a space.
6. Press **MENU/SELECT** to confirm. You will hear a confirmation tone.



```
>DIRECTORY  
CALL LOG
```



```
>STORE  
REVIEW
```

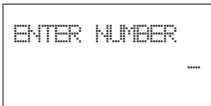

```
ENTER NUMBER  
--
```



```
ENTER NAME  
--
```

Telephone operation

Character chart

Use the dial pad and the chart below to enter a name (up to 15 characters). Each press of a particular key causes the characters to be displayed in the following order:

| Number key | Characters by number of key presses | | | | | | | | |
|------------|-------------------------------------|---|---|---|---|---|---|---|---|
| | 1 | 2 | 3 | 4 | 5 | 6 | 7 | 8 | 9 |
| 1 | 1 | # | ' | , | - | . | & | | |
| 2 | A | B | C | 2 | a | b | c | | |
| 3 | D | E | F | 3 | d | e | f | | |
| 4 | G | H | I | 4 | g | h | i | | |
| 5 | J | K | L | 5 | j | k | l | | |
| 6 | M | N | O | 6 | m | n | o | | |
| 7 | P | Q | R | S | 7 | p | q | r | s |
| 8 | T | U | V | 8 | t | u | v | | |
| 9 | W | X | Y | Z | 9 | w | x | y | z |
| 0 | 0 | | | | | | | | |
| * | * | ? | ! | / | (|) | @ | | |
| # | space | | | | | | | | |

- Press **MUTE/REMOVE** to backspace and erase when entering characters.
- Press and hold **MUTE/REMOVE** to delete the entire entry.

note

- When entering a name in the directory, the first letter of each word will be capitalized automatically.

Telephone operation

Search the directory

Entries are sorted alphabetically.

To search the directory:

1. Press  once or **MENU/SELECT** three times to enter the directory.
2. Press **▲** or **▼** to scroll through the directory.



>REVIEW
STORE



To start an alphabetical search:

1. Press  once or **MENU/SELECT** three times to enter the directory.
2. Use the dialing keys to enter the first letter associated with the name. For example, press **5** (JKL) once to find Jenny, twice to find Kristen, or three times to find Linda. If there is no name entry matching your search, the next closest matching entry in alphabetical order will be displayed. If necessary, press **▲** or **▼** to find the desired entry.



VTECH
800-595-9511

Dial a directory entry

1. Press  once or **MENU/SELECT** three times to enter the directory.
2. Press **▲** or **▼** to scroll to the desired entry, or use the alphabetical search to find it.
3. Press /FLASH or /SPEAKER to dial the entry.

Telephone operation

Edit a directory entry

1. Press  once or **MENU/SELECT** three times to enter the directory.
2. Press **▲** or **▼** to scroll to the desired entry, or use the alphabetical search to find it.
3. Press **MENU/SELECT** to confirm your selection. The screen displays **EDIT NUMBER**.

EDIT NUMBER
595-9511_
4. Use the dialing keys to edit the number.
 - Press **MUTE/REMOVE** to backspace and erase a digit.
 - Press and hold **MUTE/REMOVE** to erase the entire entry.
 - Press **▼** to move the cursor to the left or **▲** to the right.
 - Press and hold **REDIAL/PAUSE** to insert a dialing pause (p will be displayed).
 - Copy a number from the redial list by pressing **REDIAL/PAUSE** and then **▲**, **▼** or **REDIAL/PAUSE** to scroll to the desired number. Press **MENU/SELECT** to copy the number.
5. Press **MENU/SELECT** to move on to the name. The screen displays **EDIT NAME**.

EDIT NAME
VTECH_
6. Use the dialing keys (see the **Character chart** on page 23) to edit the name.
 - Press **MUTE/REMOVE** to backspace and erase a character.
 - Press and hold **MUTE/REMOVE** to erase the entire entry.
 - Press **▼** to move the cursor to the left or **▲** to the right.
 - Press **#** to insert a space.
7. Press **MENU/SELECT** to save. You will hear a confirmation tone.

Telephone operation

Delete from the directory

1. Press  once or **MENU/SELECT** three times to enter the directory.
2. Press **▲** or **▼** to scroll to the desired entry, or use the alphabetical search to find it.
3. Press **MUTE/REMOVE** to remove the desired entry. You will hear a confirmation tone.

Telephone operation

About caller ID

The caller ID with call waiting feature in this telephone lets you see the name and telephone number of the caller before answering the call, even when you're on a call. These features require services provided by your local telephone company.

Contact your telephone company if:

- you have both caller ID and call waiting, but as separate services (you may need combined service);
- you have only caller ID service, or only call waiting service; or
- you do not subscribe to any caller ID or call waiting services, but wish to order them.

You can use this telephone with regular caller ID service, and you can use its other features without subscribing to either caller ID or combined caller ID with call waiting service. There may be fees for these services, and these services may not be available in all areas.

The caller ID features will work only if both you and the caller are in areas offering caller ID service, and if both telephone companies use compatible equipment.

note

- Due to regional service differences, the caller ID information may not be available for every incoming call. In addition, the callers may intentionally block their names and/or telephone numbers.
- For call log entries with numbers between 16 and 23 digits, in order to view the entire number you must save the entry to the directory. For information on saving call log entries to the directory, see page 31.

Telephone operation

Call log

If you subscribe to caller ID service, information about each caller will be displayed after the first or second ring.

- The call log can store up to 50 entries. Each entry may have up to 24 digits for the phone number and 15 characters for the name. If the phone number has more than 24 digits, it will not be saved or displayed in the call log. If the phone number has more than 15 but fewer than 24 digits, only the last 15 digits will be shown. If the name is longer than 15 characters, only the first 15 characters will be shown and saved in the call log.
- You can review, redial, and copy an entry into the directory.
- Entries are displayed in reverse chronological order, i.e. from the most recent entry to the earliest entry.
- When the call log is full, the earliest entry is deleted to make room for new incoming call information.
- **XX MISSED CALL(S)** will be displayed if there are new call log entries (including missed and unreviewed calls).
- **CALL LOG EMPTY** will be displayed if there are no records in the call log.
- Since the call log is shared by all the handsets, only one handset can review the call log at a time. If a handset attempts to enter the call log while another handset is already in it, **NOT AVAILABLE AT THIS TIME** will be displayed.

HANDSET X
XX MISSED CALLS

CALL LOG EMPTY

Telephone operation

Missed calls indicator

When the handset is not in use and there are unreviewed calls in the call log, its screen will display **XX MISSED CALL(S)**.

Each time a call log entry marked **NEW** is reviewed, the number of missed calls decreases by one.

When all the missed calls have been reviewed, the missed calls indicator will no longer display.

If you do not want to review the missed calls one by one, press and hold **OFF/CLEAR** to erase the missed calls indicator. All the entries will be considered old and kept in the call log.

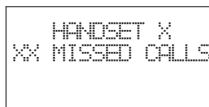

HANDSET X
XX MISSED CALLS



VTECH
595-9511
3:45^{PM} 1/02 ^{NEW}

Review the call log

1. Press **CID** when the handset is not in use.
2. Press **▲** or **▼** to browse through the call log.

-OR-

1. Press **MENU/SELECT** when the handset is not in use.
2. Press **▲** or **▼** to select **>CALL LOG**.
3. Press **MENU/SELECT**.
4. Press **▲** or **▼** to browse through the call log.

- The name (if available), telephone number, date and time of all incoming calls are displayed on the screen.
- There will be an error tone when the list reaches the beginning or end of the call log.



VTECH
595-9511
3:45^{PM} 1/02

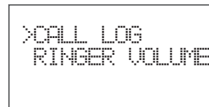

>CALL LOG
RINGER VOLUME

Telephone operation

Make a call log entry ready to dial

Although the call log entries received have 10 digits (the area code plus the seven-digit number), in some areas, you may need to dial only the seven digits, or a 1 plus the seven digits, or a 1 plus the area code plus the seven digits. You can change the number of digits that you dial from or store in the call log.

While reviewing the call log, press # repeatedly to display different dialing options for local and long distance numbers before dialing or saving the telephone number in the directory. See the example on the right.

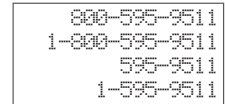

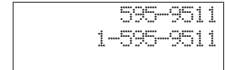

800-595-9511
1-800-595-9511
595-9511
1-595-9511

You may also press 1 repeatedly to add or remove a 1 in front of the telephone number before dialing or saving it in the directory. See the examples on the right.



595-9511
1-595-9511

When the number displayed is in the correct format for dialing, press /FLASH or /SPEAKER to call the number.

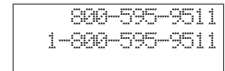

800-595-9511
1-800-595-9511

Dial a call log entry

1. When in the call log, press ▲ or ▼ to scroll to the desired entry.
2. Press /FLASH or /SPEAKER to dial the entry.

Telephone operation

Save a call log entry to the directory

1. When in the call log, press ▲ or ▼ to scroll to the desired entry.
2. Press **MENU/SELECT**.
 - You can edit the phone number, if necessary. Make sure the number is in the correct dialing format for your area. Press **MENU/SELECT** when done.
 - Edit the name, if necessary. Press **MENU/SELECT** when done.
3. Successful programming is indicated by **SAVED** on the handset display along with a confirmation tone.
 - If the entry is already saved in the directory before, the screen will display **ALREADY SAVED**.
 - If there is no caller ID information, the screen will display **UNABLE TO SAVE**.

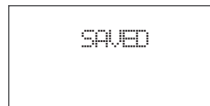

SAVED

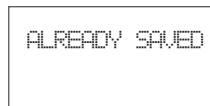

ALREADY SAVED

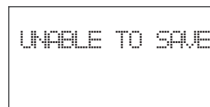

UNABLE TO SAVE

note

- Saving or deleting a number on one handset will automatically update the other handset.

Telephone operation

Delete from the call log

To delete one entry:

1. When in the call log, press ▲ or ▼ to scroll to the desired entry.
2. Press **MUTE/REMOVE** to delete the selected entry. You will hear a confirmation tone.

To delete all entries:

1. When in the call log, press and hold **MUTE/REMOVE** to delete the entire call log. The screen displays **DELETE ALL CALLS?**
2. Press **MENU/SELECT** to confirm. You will hear a confirmation tone. If you change your mind, press **OFF/CLEAR** to cancel the deletion and return to the call log.



DELETE ALL
CALLS?

Telephone operation

Call log display screen messages

| Displays: | When: |
|----------------|--|
| PRIVATE NAME | The caller is blocking the name information. |
| PRIVATE NUMBER | The caller is blocking the telephone number information. |
| PRIVATE CALLER | The caller is blocking the name and number information. |
| UNKNOWN NAME | This caller's name is unavailable. |
| UNKNOWN NUMBER | This caller's number is unavailable. |
| UNKNOWN CALLER | No information is available about this caller. |

Telephone operation

Redial list

The telephone stores the five most recently dialed numbers on the redial list.

- When there are already five entries on the redial list, the earliest entry will be deleted to make room for the latest entry.
- Entries are displayed in reverse chronological order, i.e. from the latest entry to the earliest entry.

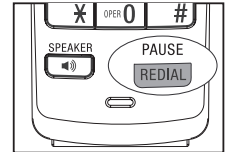

The redial list can be accessed by pressing **REDIAL** when in idle mode.

Dial a redial entry

1. Press **REDIAL**, then press **▲**, **▼** or **REDIAL** to scroll to the desired number. You will hear an error tone when you reach the beginning or end of the redial list.
2. Press **TALK/FLASH** or **SPEAKER** to dial the number.

Delete from redial

1. Press **REDIAL**, then press **▲**, **▼** or **REDIAL** to scroll to the desired number.
2. Press **MUTE/REMOVE** to delete the selected entry. You will hear a confirmation tone.

Handset display screen messages

| | |
|---|--|
| ALREADY SAVED | The telephone number you have entered is already stored in the directory. |
| CALL LOG EMPTY | There are no call log entries. |
| CALLING HANDSET X (for DS6111-3/DS6111-4) CALLING OTHER HANDSET (for DS6111-2) | Calling another handset. |
| CONNECTING... | The cordless handset is searching for the telephone base. |
| CHARGING | A handset with low battery has been placed in the telephone base or charger to recharge. |
| DIRECTORY EMPTY | There are no directory entries. |
| ENDED | You have just ended a call. |
| HANDSET X IS CALLING (for DS6111-3/DS6111-4) OTHER HANDSET IS CALLING (for DS6111-2) | Another system handset is calling. |
| INTERCOM | The handset is on an intercom call. |
| INCOMING CALL | There is an incoming call. |
| INTERCOM ENDED | The handset is terminating an intercom call. |
| LINE IN USE | A handset or another telephone on the same line is in use. |
| LIST FULL | The directory is full. |
| LOW BATTERY | The battery needs to be recharged. |

Handset display screen messages

| | |
|----------------------------|--|
| MICROPHONE ON | MUTE has been turned off and the person on the other end can hear you. |
| MUTED | The microphone is muted temporarily during a conversation. |
| NEW VOICE MAIL | There are new voicemail messages from the local telephone company. |
| NO LINE | There is no telephone line connected. |
| NO SIGNAL, CALL ENDED | Communication between handset and telephone base is lost during a call. |
| NOT AVAILABLE AT THIS TIME | One handset is already viewing the call log or directory and another handset attempts to review it. |
| OUTSIDE CALL | Connected to the external call during call transfer. |
| **PAGING** | The cordless handset locator has been activated. |
| PHONE | The handset is in use. |
| PLACE IN CHARGER | The battery is very low. The handset should be placed in the telephone base or charger. |
| RINGER MUTE | The ringer is muted temporarily during incoming call. |
| SAVED | Your operation has been saved. |
| SPEAKER | The handset speakerphone is in use. |
| UNABLE TO CALL TRY AGAIN | You have attempted to make an intercom call, but the handset you are calling is out of range or on an external call. |
| UNABLE TO SAVE | You are attempting to save caller ID entry with no name or number. |

Handset display screen messages

| | |
|---------------------------|--|
| WARNING CHECK BATTERY! | The battery is not installed or not installed properly in the handset. -OR - The battery needs to be replaced. -OR - An incorrect battery has been installed. Use only the supplied VTech battery or equivalent. |
| XX MISSED CALLS | There are unreviewed calls in your call log. |

Handset and telephone base indicators

Handset lights





| | |
|--|--|
|  | <ul style="list-style-type: none">• On when the handset speakerphone is in use. |
| CHARGE | <ul style="list-style-type: none">• On when the handset is in the telephone base or charger and is charging. |

Telephone base lights

| | |
|-----------|--|
| IN USE | <ul style="list-style-type: none">• Flashes when there is an incoming call or another telephone sharing the same line is in use.• On when a system handset is in use. |
| VOICEMAIL | <ul style="list-style-type: none">• Flashes when you have new voicemail. Voicemail is offered by your telephone service provider. |

Handset and telephone base indicators

Handset icons

| | |
|---|--|
| MUTE | <ul style="list-style-type: none">• Microphone is muted. |
|  | <ul style="list-style-type: none">• Ringer off. |
| NEW | <ul style="list-style-type: none">• New call log entries. |
| NEW VOICE MAIL  | <ul style="list-style-type: none">• New voicemail received from the local telephone company. |
| SPEAKER  | <ul style="list-style-type: none">• In speakerphone mode. |
| Battery indicator  | <ul style="list-style-type: none">• Cycles (low, medium, and full) when the handset battery is charging.• Flashes when the battery is low and needs charging.• Displays solid when the battery is fully charged. |

Battery

It takes up to 16 hours for the battery to be fully charged. When it is fully charged, you can expect the following performance:

| Operation | Operating time |
|---------------------------------------|----------------------|
| While in handset use (talking*) | Nine hours |
| While in speakerphone mode (talking*) | One and a half hours |
| While not in use (standby**) | Five days |

*Operating times are approximate. Your results may vary.

**Handset is off the telephone base but not in use.

The battery needs charging when:

- A new battery is installed in the handset.
- The handset beeps.
- **LOW BATTERY** is displayed and the battery indicator on the handset screen is flashing.

CAUTION:

To reduce the risk of fire or injury, read and follow these instructions:

- Use only the battery(ies) provided or equivalent. To order a replacement, visit our website at www.vtechphones.com or call 1 (800) 595-9511. In Canada, go to www.vtechcanada.com or call 1 (800) 267-7377.
- Do not dispose of the battery(ies) in a fire. They may explode. Check with local waste management codes for special disposal instructions.
- Do not open or mutilate the battery(ies). Released electrolyte is corrosive and may cause burns or injury to the eyes or skin. The electrolyte may be toxic if swallowed.
- Exercise care in handling batteries in order not to create a short circuit with conductive materials such as rings, bracelets, and keys. The battery and/or conductor may overheat and cause burns.
- Charge the battery(ies) provided with or identified for use with this product only in accordance with the instructions and limitations specified in this manual.

WARNING:

TO PREVENT FIRE OR SHOCK HAZARD, DO NOT EXPOSE THIS PRODUCT TO WATER OR ANY TYPE OF MOISTURE.

Important safety instructions

When using your telephone equipment, basic safety precautions should always be followed to reduce the risk of fire, electric shock and injury, including the following:

1. Read and understand all instructions.
2. Follow all warnings and instructions marked on the product.
3. Unplug this product from the wall outlet before cleaning. Do not use liquid or aerosol cleaners. Use a damp cloth for cleaning.
4. Do not use this product near water (for example, near a bathtub, kitchen sink, or swimming pool).
5. Do not place this product on an unstable table, shelf, stand or other unstable surfaces.
6. Slots and openings in the back or bottom of the telephone base and handset are provided for ventilation. To protect them from overheating, these openings must not be blocked by placing the product on a soft surface such as a bed, sofa or rug. This product should never be placed near or over a radiator or heat register. This product should not be placed in any area where proper ventilation is not provided.
7. This product should be operated only from the type of power source indicated on the marking label. If you are not sure of the type of power supply in your home, consult your dealer or local power company.
8. Do not allow anything to rest on the power cord. Do not install this product where the cord may be walked on.
9. Never push objects of any kind into this product through the slots in the telephone base or handset because they may touch dangerous voltage points or create a short circuit. Never spill liquid of any kind on the product.
10. To reduce the risk of electric shock, do not disassemble this product, but take it to an authorized service facility. Opening or removing parts of the telephone base or handset other than specified access doors may expose you to dangerous voltages or other risks. Incorrect reassembling can cause electric shock when the product is subsequently used.
11. Do not overload wall outlets and extension cords.
12. Unplug this product from the wall outlet and refer servicing to an authorized service facility under the following conditions:
 - A. When the power supply cord or plug is damaged or frayed.
 - B. If liquid has been spilled onto the product.
 - C. If the product has been exposed to rain or water.
 - D. If the product does not operate normally by following the operating instructions. Adjust only those controls that are covered by the operation instructions. Improper adjustment of other controls may result in damage and often requires extensive work by an authorized technician to restore the product to normal operation.
 - E. If the product has been dropped and the telephone base and/or handset has been damaged.
 - F. If the product exhibits a distinct change in performance.
13. Avoid using a telephone (other than cordless) during an electrical storm. There is a remote risk of electric shock from lightning.
14. Do not use the telephone to report a gas leak in the vicinity of the leak.
15. Only put the handset of your telephone next to your ear when it is in normal talk mode.
16. The power adapters are intended to be correctly oriented in a vertical or floor mount position. The prongs are not designed to hold the plug in place if it is plugged into a ceiling or an under-the-table/cabinet outlet.

SAVE THESE INSTRUCTIONS

www.vtechphones.com

Download from Www.Somanuals.com. All Manuals Search And Download.

Troubleshooting

If you have difficulty with your telephone, please try the suggestions below. For Customer Service, visit our website at www.vtechphones.com, or call 1 (800) 595-9511; in Canada, call 1 (800) 267-7377.

| Problem | Suggestion |
|--|--|
| My telephone does not work at all. | <ul style="list-style-type: none">• Make sure the battery is installed and charged correctly (page 3). For optimum daily performance, return the handset to the telephone base or charger after use.• Make sure the power adapter is securely plugged into an outlet not controlled by a wall switch.• Make sure the telephone line cord is plugged firmly into the telephone base and the telephone wall jack.• Unplug the electrical power to the telephone base. Wait for approximately 15 seconds, then plug it back in. Allow up to one minute for the cordless handset and telephone base to synchronize.• Charge the battery in the handset for up to 16 hours.• Remove and re-insert the battery. If that still does not work, it may be necessary to purchase a new battery.• Disconnect the telephone base from the telephone wall jack and plug in a working telephone. If the other telephone does not work, the problem is probably in the wiring or the local service. Call the local telephone company. |
| LOW BATTERY is displayed on screen. | <ul style="list-style-type: none">• Place the handset in the telephone base or charger for recharging.• Remove and re-install the battery and use it normally until fully discharged, then recharge the handset on the telephone base or charger for up to 16 hours.• If the above measures do not correct the problem, the battery may need to be replaced. |

Troubleshooting

| Problem | Suggestion |
|---|--|
| The battery does not charge in the handset or the handset battery does not accept charge. | <ul style="list-style-type: none">• Make sure the handset is placed in the telephone base or charger correctly. The CHARGE light on the handset should be on.• Remove and reinstall the battery, then charge for up to 16 hours.• If the handset is in the charger or in the telephone base but the CHARGE light on the handset is not on, refer to The CHARGE light is off in this section.• It may be necessary to purchase a new battery. Please refer to the Battery section (page 39) of this user's manual. |
| The CHARGE light is off. | <ul style="list-style-type: none">• Clean the charging contacts on the handset(s) and telephone base each month using a pencil eraser or a dry non-abrasive fabric.• Make sure the power adapter and telephone line cords are plugged in correctly and securely.• Unplug the power adapter. Wait for 15 seconds before plugging it back in. Allow up to one minute for the handset and telephone base to reset. |
| There is no dial tone. | <ul style="list-style-type: none">• First, try all the above suggestions.• Move the handset closer to the telephone base. It might be out of range.• The telephone line cord might be malfunctioning. Try installing a new telephone line cord.• Disconnect the telephone base from the telephone wall jack and connect a different telephone. If there is no dial tone on this telephone either, the problem is in your wiring or local service. Contact your local telephone company. |

Troubleshooting

| Problem | Suggestion |
|---|--|
| The telephone does not ring when there is an incoming call. | <ul style="list-style-type: none">• Make sure the ringer volume is not set to zero (page 8).• Make sure the telephone line cord and power adapter are plugged in properly (page 2).• The handset may be too far from the telephone base. Move it closer to the telephone base.• There may be too many extension phones on the telephone line to allow all of them to ring simultaneously. Try unplugging some of them.• If the other telephones in your home are having the same problem, the problem is in the wiring or local service. Contact the local telephone company (charges may apply).• Other electronic products can cause interference to your cordless telephone. Try installing your telephone as far away as possible from the following electronic devices: wireless routers, radios, radio towers, pager towers, cellular telephones, digital telephones, intercoms, room monitors, televisions, VCRs, personal computers, kitchen appliances, and other cordless telephones.• Test a working telephone at the telephone wall jack. If another telephone has the same problem, the problem is in the telephone wall jack. Contact your local telephone company (charges may apply).• The telephone line cord might be malfunctioning. Try installing a new telephone line cord.• Re-install the battery and place the handset in the telephone base.• Wait for the handset to synchronize with the telephone base. Allow up to one minute for this to take place. |

Troubleshooting

| Problem | Suggestion |
|--|---|
| I cannot dial out. | <ul style="list-style-type: none">• First, try all the above suggestions.• Make sure there is a dial tone before dialing. It is normal if the handset takes a second or two to synchronize with the telephone before producing a dial tone. Wait an extra second before dialing.• If the other telephones in your home are having the same problem, the problem is in the wiring or local service. Contact your local telephone company (charges may apply).• Eliminate any background noise. Noise from a television, radio, or other appliances may cause the telephone not to dial out properly. If you cannot eliminate the background noise, first try muting the cordless handset before dialing, or dialing from another room in your home with less background noise. |
| My handset beeps and is not performing normally. | <ul style="list-style-type: none">• Make sure the power cord is securely plugged into the telephone base. Plug the telephone base into a different working electrical outlet not controlled by a wall switch.• Move the handset closer to the telephone base. It may be out of range.• Reset the telephone base by unplugging the electrical power to the base. Wait for 15 seconds and plug it back in again. Allow up to one minute for the cordless handset and the telephone base to synchronize.• Other electronic products can cause interference to your cordless telephone. Try installing your telephone as far away from these electronic devices as possible: wireless routers, radios, radio towers, pager towers, cellular telephones, intercoms, room monitors, televisions, personal computers, kitchen appliances and other cordless telephones. |

Troubleshooting

| Problem | Suggestion |
|--|---|
| <p>There is interference during a telephone conversation.</p> <p>My calls fade out when I am using the cordless handset.</p> | <ul style="list-style-type: none">• The handset may be out of range. Move it closer to the telephone base.• Do you have DSL service? If yes, you need to have a DSL filter installed at every telephone wall jack that has a telephone connected to it (page 2). Contact your DSL service provider for filter information.• Appliances or other cordless telephones plugged into the same circuit as the telephone base can cause interference. Try moving the appliance or telephone base to another outlet.• Other electronic products can cause interference to your cordless telephone. Try installing your telephone as far away as possible from the following electronic devices: wireless routers, radios, radio towers, pager towers, cellular telephones, digital telephones, intercoms, room monitors, televisions, VCRs, personal computers, kitchen appliances, and other cordless telephones.• If your telephone is plugged in with a modem or a surge protector, plug the telephone (or modem/surge protector) into a different location. If this doesn't solve the problem, re-locate your telephone or modem farther apart from each other, or use a different surge protector.• The location of your telephone base can impact the performance of your cordless phone. For better reception, install the telephone base in a centralized location within your home or office, away from walls or other obstructions. In many environments, elevating the telephone base will improve overall performance.• Disconnect the telephone base from the telephone wall jack and plug in a corded telephone. If calls are still not clear, the problem is probably in the wiring or local service. Contact your local service company (charges may apply).• If the other telephones in your home are having the same problem, the problem is in the wiring or local service. Contact the local telephone company (charges may apply). |

Troubleshooting

| Problem | Suggestion |
|---|--|
| I hear other calls when using the telephone. | <ul style="list-style-type: none">• Disconnect the telephone base from the telephone wall jack. Plug in a different telephone. If you still hear other calls, the problem is probably in the wiring or local service. Call your local telephone company. |
| I hear noise on the cordless handset, and none of the keys or buttons works. | <ul style="list-style-type: none">• Make sure the telephone line cord is plugged in securely. |
| My caller ID features are not working properly. | <ul style="list-style-type: none">• Caller ID is a subscription service. You must subscribe to this service from your local telephone company for this feature to work on your telephone.• The caller may not be calling from an area which supports caller ID.• Both you and the caller's telephone companies must use equipment which are compatible with the caller ID service.• The caller ID information will be displayed after the first or second ring.• If you subscribe to DSL service, install a DSL filter to the telephone line between the telephone base and the telephone line jack. Contact your DSL service provider for filter information. |
| The system does not receive caller ID or the system does not display caller ID during call waiting. | <ul style="list-style-type: none">• Make sure you subscribe to caller ID with call waiting features provided by the local telephone company.• The caller may not be calling from an area which supports caller ID.• Both you and the caller's telephone companies must use equipment which are compatible with caller ID service.• If you subscribe to DSL service, install a DSL filter to the telephone line between the telephone base and the telephone line jack. Contact your DSL service provider for filter information. |

Troubleshooting

| Problem | Suggestion |
|--|---|
| Caller ID entries do not match the numbers I need to dial. | <ul style="list-style-type: none">• Although the call log entries you receive have 10 digits, (the area code plus the seven-digit number,) in some areas, you may need to dial only the seven digits, or a 1 plus the seven digits, or a 1 plus the area code plus the seven digits. You can change the number of digits that you dial from or store in the call log.• While reviewing the call log, press # repeatedly to display these dialing options for local and long distance numbers before dialing or saving the telephone number. |
| CONNECTING... is shown in the handset display window. Why don't I get a dial tone when I try to use this telephone? | <ul style="list-style-type: none">• The handset may be out of range. Move it closer to the telephone base.• Make sure the power cord is securely plugged into the telephone base. Use a working electrical outlet that is not controlled by a wall switch.• Reset your telephone by unplugging the power adapter from the telephone base. Disconnect the battery from the cordless handset. Wait for 15 seconds, then plug in the power adapter and re-install the battery. Place the handset in the telephone base and allow up to one minute for the handset and telephone base to synchronize.• Other electronic products may prevent your handset and telephone base from communicating with each other. Try installing your telephone base as far away from these electronic devices as possible: wireless routers, radios, radio towers, pager towers, cellular telephones, intercoms, room monitors, televisions, personal computers, kitchen appliances and other cordless telephones. |

Troubleshooting

| Problem | Suggestion |
|---------------------------------------|--|
| Common cure for electronic equipment. | <ul style="list-style-type: none">• If the telephone is not responding normally, try putting the cordless handset in the telephone base or the charger. If it does not respond, try the following (in the order listed):• Disconnect the power to the telephone base.• Disconnect the battery on the cordless handset.• Wait a few minutes before connecting power to the telephone base.• Re-install the battery and place the cordless handset in the telephone base or charger.• Wait for the cordless handset to synchronize its connection with the telephone base. Allow up to one minute for this to take place. |

Operating range

This cordless telephone operates with the maximum power allowed by the Federal Communications Commission (FCC). Even so, this handset and telephone base can communicate over only a certain distance - which can vary with the locations of the telephone base and handset, the weather, and the layout of your home or office.

When the handset is out of range, the handset will display **CONNECTING...**

If there is a call while the handset is out of range, it might not ring, or if it does ring, the call might not connect well when you press **TALK/FLASH**.

Move closer to the telephone base, then press **TALK/FLASH** to answer the call.

If the handset moves out of range during a telephone conversation, there might be interference.

To improve reception, move closer to the telephone base.

Maintenance

Taking care of your telephone

Your cordless telephone contains sophisticated electronic parts, so it must be treated with care.

Avoid rough treatment

Place the handset down gently. Save the original packing materials to protect your telephone if you ever need to ship it.

Avoid water

Your telephone can be damaged if it gets wet. Do not use the handset outdoors in the rain, or handle it with wet hands. Do not install the telephone base near a sink, bathtub or shower.

Electrical storms

Electrical storms can sometimes cause power surges harmful to electronic equipment. For your own safety, take caution when using electrical appliances during storms.

Cleaning your telephone

Your telephone has a durable plastic casing that should retain its luster for many years. Clean it only with a soft cloth slightly dampened with water or a mild soap. Do not use excess water or cleaning solvents of any kind.

Remember that electrical appliances can cause serious injury if used when you are wet or standing in the water. If the telephone base should fall into the water, **DO NOT RETRIEVE IT UNTIL YOU UNPLUG THE POWER CORD AND TELEPHONE LINE CORDS FROM THE WALL.** Then pull the unit out by the unplugged cords.

About cordless telephones

- **Privacy:** The same features that make a cordless telephone convenient create some limitations. Telephone calls are transmitted between the telephone base and the cordless handset by radio waves, so there is a possibility that the cordless telephone conversations could be intercepted by radio receiving equipment within range of the cordless handset. For this reason, you should not think of cordless telephone conversations as being as private as those on corded telephones.
- **Electrical power:** The telephone base of this cordless telephone must be connected to a working electrical outlet. The electrical outlet should not be controlled by a wall switch. Calls cannot be made from the cordless handset if the telephone base is unplugged or switched off, or if the electrical power is interrupted.
- **Potential TV interference:** Some cordless telephones operate at frequencies that may cause interference to televisions and VCRs. To minimize or prevent such interference, do not place the telephone base of the cordless telephone near or on top of a TV or VCR. If interference is experienced, moving the cordless telephone farther away from the TV or VCR will often reduce or eliminate the interference.
- **Rechargeable batteries:** This product contains either Nickel-cadmium or Nickel-metal hydride rechargeable batteries. Exercise care in handling batteries in order not to create a short circuit with conducting material such as rings, bracelets, and keys. The battery or conductor may overheat and cause harm. Observe proper polarity between the battery and the battery charger.
- **Nickel-metal hydride rechargeable batteries:** Dispose of these batteries in a safe manner. Do not burn or puncture the battery. Like other batteries of this type, if burned or punctured, they could release caustic material which could cause injury.

The RBRC® seal



The RBRC® seal on the nickel-metal-hydride battery indicates that VTech Communications, Inc. is voluntarily participating in an industry program to collect and recycle these batteries at the end of their useful lives, when taken out of service within the United States and Canada.

The RBRC® program provides a convenient alternative to placing used nickel-metal-hydride batteries into the trash or municipal waste, which may be illegal in your area.

VTech's participation in RBRC® makes it easy for you to drop off the spent battery at local retailers participating in the RBRC® program or at authorized VTech product service centers. Please call **1-800-8-BATTERY™** for information on Ni-MH battery recycling and disposal bans/restrictions in your area. VTech's involvement in this program is part of its commitment to protecting our environment and conserving natural resources.

RBRC® is a registered trademark of Rechargeable Battery Recycling Corporation.

Warranty

What does this limited warranty cover?

The manufacturer of this VTech Product warrants to the holder of a valid proof of purchase (“Consumer” or “you”) that the Product and all accessories provided in the sales package (“Product”) are free from defects in material and workmanship, pursuant to the following terms and conditions, when installed and used normally and in accordance with the Product operating instructions. This limited warranty extends only to the Consumer for Products purchased and used in the United States of America and Canada.

What will VTech do if the Product is not free from defects in materials and workmanship during the limited warranty period (“Materially Defective Product”)?

During the limited warranty period, VTech’s authorized service representative will repair or replace at VTech’s option, without charge, a Materially Defective Product. If we repair the Product, we may use new or refurbished replacement parts. If we choose to replace the Product, we may replace it with a new or refurbished Product of the same or similar design. We will retain defective parts, modules, or equipment. Repair or replacement of the Product, at VTech’s option, is your exclusive remedy. VTech will return the repaired or replacement Products to you in working condition. You should expect the repair or replacement to take approximately 30 days.

How long is the limited warranty period?

The limited warranty period for the Product extends for ONE (1) YEAR from the date of purchase. If VTech repairs or replaces a Materially Defective Product under the terms of this limited warranty, this limited warranty also applies to repaired or replacement Product for a period of either (a) 90 days from the date the repaired or replacement Product is shipped to you or (b) the time remaining on the original one-year warranty; whichever is longer.

What is not covered by this limited warranty?

This limited warranty does not cover:

1. Product that has been subjected to misuse, accident, shipping or other physical damage, improper installation, abnormal operation or handling, neglect, inundation, fire, water or other liquid intrusion; or
2. Product that has been damaged due to repair, alteration or modification by anyone other than an authorized service representative of VTech; or
3. Product to the extent that the problem experienced is caused by signal conditions, network reliability, or cable or antenna systems; or
4. Product to the extent that the problem is caused by use with non-VTech accessories; or
5. Product whose warranty/quality stickers, product serial number plates or electronic serial numbers have been removed, altered or rendered illegible; or
6. Product purchased, used, serviced, or shipped for repair from outside the United States of America or Canada, or used for commercial or institutional purposes (including but not limited to Products used for rental purposes); or
7. Product returned without a valid proof of purchase (see item 2 below); or

Warranty

8. Charges for installation or set up, adjustment of customer controls, and installation or repair of systems outside the unit.

How do you get warranty service?

To obtain warranty service in the United States of America, please call 1 (800) 595-9511. In Canada, please call 1 (800) 267-7377. NOTE: Before calling for service, please review the user's manual - a check of the Product's controls and features may save you a service call.

Except as provided by applicable law, you assume the risk of loss or damage during transit and transportation and are responsible for delivery or handling charges incurred in the transport of the Product(s) to the service location. VTech will return repaired or replaced Product under this limited warranty. Transportation, delivery or handling charges are prepaid. VTech assumes no risk for damage or loss of the Product in transit. If the Product failure is not covered by this limited warranty, or proof of purchase does not meet the terms of this limited warranty, VTech will notify you and will request that you authorize the cost of repair prior to any further repair activity. You must pay for the cost of repair and return shipping costs for the repair of Products that are not covered by this limited warranty.

What must you return with the Product to get warranty service?

1. Return the entire original package and contents including the Product to the VTech service location along with a description of the malfunction or difficulty; and
2. Include a "valid proof of purchase" (sales receipt) identifying the Product purchased (Product model) and the date of purchase or receipt; and
3. Provide your name, complete and correct mailing address, and telephone number.

Other Limitations

This warranty is the complete and exclusive agreement between you and VTech. It supersedes all other written or oral communications related to this Product. VTech provides no other warranties for this Product. The warranty exclusively describes all of VTech's responsibilities regarding the Product. There are no other express warranties. No one is authorized to make modifications to this limited warranty and you should not rely on any such modification.

State/Provincial Law Rights: This warranty gives you specific legal rights, and you may also have other rights, which vary from state to state or province to province.

Limitations: Implied warranties, including those of fitness for a particular purpose and merchantability (an unwritten warranty that the Product is fit for ordinary use) are limited to one year from the date of purchase. Some states/provinces do not allow limitations on how long an implied warranty lasts, so the above limitation may not apply to you. In no event shall VTech be liable for any indirect, special, incidental, consequential, or similar damages (including, but not limited to lost profits or revenue, inability to use the Product or other associated equipment, the cost of substitute equipment, and claims by third parties) resulting from the use of this Product. Some states/provinces do not allow the exclusion or limitation of incidental or consequential damages, so the above limitation or exclusion may not apply to you.

Please retain your original sales receipt as proof of purchase.

FCC, ACTA and IC regulations

FCC Part 15

This equipment has been tested and found to comply with the requirements for a Class B digital device under Part 15 of the Federal Communications Commission (FCC) rules. These requirements are intended to provide reasonable protection against harmful interference in a residential installation. This equipment generates, uses and can radiate radio frequency energy and, if not installed and used in accordance with the instructions, may cause harmful interference to radio communications. However, there is no guarantee that interference will not occur in a particular installation. If this equipment does cause harmful interference to radio or television reception, which can be determined by turning the equipment off and on, the user is encouraged to try to correct the interference by one or more of the following measures:

- Reorient or relocate the receiving antenna.
- Increase the separation between the equipment and receiver.
- Connect the equipment into an outlet on a circuit different from that to which the receiver is connected.
- Consult the dealer or an experienced radio/TV technician for help.

Changes or modifications to this equipment not expressly approved by the party responsible for compliance could void the user's authority to operate the equipment.

This device complies with Part 15 of the FCC rules. Operation is subject to the following two conditions: (1) this device may not cause harmful interference, and (2) this device must accept any interference received, including interference that may cause undesired operation. Privacy of communications may not be ensured when using this telephone.

To ensure safety of users, the FCC has established criteria for the amount of radio frequency energy that can be safely absorbed by a user or bystander according to the intended usage of the product. This product has been tested and found to comply with the FCC criteria. The handset may be safely held against the ear of the user. The telephone base shall be installed and used such that parts of the user's body other than the hands are maintained at a distance of approximately 20 cm (8 inches) or more. If you choose to use a clipping device, please make sure to only use the supplied VTech belt clip.

This Class B digital apparatus complies with Canadian ICES-003.

FCC Part 68 and ACTA

This equipment complies with Part 68 of the FCC rules and with technical requirements adopted by the Administrative Council for Terminal Attachments (ACTA). The label on the back or bottom of this equipment contains, among other things, a product identifier in the format US: AAAEQ##TXXXX. This identifier must be provided to your local telephone company upon request.

The plug and jack used to connect this equipment to premises wiring and the telephone network must comply with applicable Part 68 rules and technical requirements adopted by ACTA. A compliant telephone cord and modular plug is provided with this product. It is designed to be connected to a compatible modular jack that is also compliant. An RJ11 jack should normally be used for connecting to a single line and an RJ14 jack for two lines. See Installation Instructions in the user's manual.

FCC, ACTA and IC regulations

The Ringer Equivalence Number (REN) is used to determine how many devices you may connect to your telephone line and still have them ring when you are called. The REN for this product is encoded as the 6th and 7th characters following the US: in the product identifier (e.g., if ## is 03, the REN is 0.3). In most, but not all areas, the sum of all RENs should be five (5.0) or less. For more information, please contact your local telephone company.

This equipment may not be used with Party Lines. If you have specially wired alarm dialing equipment connected to your telephone line, ensure the connection of this equipment does not disable your alarm equipment. If you have questions about what will disable alarm equipment, consult your telephone company or a qualified installer.

If this equipment is malfunctioning, it must be unplugged from the modular jack until the problem has been corrected. Repairs to this telephone equipment can only be made by the manufacturer or its authorized agents. For repair procedures, follow the instructions outlined under the Limited Warranty.

If this equipment is causing harm to the telephone network, the telephone company may temporarily discontinue your telephone service. The telephone company is required to notify you before interrupting service. If advance notice is not practical, you will be notified as soon as possible. You will be given the opportunity to correct the problem and the telephone company is required to inform you of your right to file a complaint with the FCC. Your telephone company may make changes in its facilities, equipment, operation, or procedures that could affect the proper functioning of this product. The telephone company is required to notify you if such changes are planned.

If this product is equipped with a corded or cordless handset, it is hearing aid compatible.

If this product has memory dialing locations, you may choose to store emergency telephone numbers (e.g., police, fire, medical) in these locations. If you do store or test emergency numbers, please:

Remain on the line and briefly explain the reason for the call before hanging up.

Perform such activities in off-peak hours, such as early morning or late evening.

Industry Canada

Operation is subject to the following two conditions: (1) this device may not cause harmful interference, and (2) this device must accept any interference, including interference that may cause undesired operation.

The term "IC: " before the certification/registration number only signifies that the Industry Canada technical specifications were met.

The Ringer Equivalence Number (REN) for this terminal equipment is 0.1. The REN is an indication of the maximum number of devices allowed to be connected to a telephone interface. The termination on an interface may consist of any combination of devices subject only to the requirement that the sum of the RENs of all the devices does not exceed five.

This product meets the applicable Industry Canada technical specifications.

Technical specifications

| | |
|-------------------------|---|
| Frequency control | Crystal controlled PLL synthesizer |
| Transmit frequency | Handset: 1921.536-1928.448 MHz Telephone base: 1921.536-1928.448 MHz |
| Channels | 5 |
| Nominal effective range | Maximum power allowed by FCC and IC. Actual operating range may vary according to environmental conditions at the time of use. |
| Size | Handset: 6.61in X 1.77in X 1.06in (168.0mm X 45.0mm X 27.0mm) Telephone base: 5.02in X 4.04in X 4.06in (127.5mm X 102.5mm X 103.0mm) Charger: 2.80in X 3.14in X 2.39in (71.0mm X 79.8mm X 60.8mm) |
| Weight | Handset: 5.29oz (150.0g) (including battery) Telephone base: 6.04oz (171.1 g) Charger: 1.98oz (56.0g) |
| Power requirements | Handset: 2.4V 550mAh Ni-MH battery Telephone base: 6V DC @ 300mA Charger: 6V DC @200mA |
| Memory | Handset directory: 50 memory locations; up to 30 digits and 15 characters Handset call log: 50 memory locations; up to 24 digits and 15 characters |

Index

A

- About caller ID 27
- About cordless telephones 50
- Answer a call 12
- Answer an incoming call during an intercom call 20

B

- Battery 3, 39

C

- Call log 28
- Call log display screen messages 33
- Call waiting 13
- Chain dialing 14
- Character chart 23
- Charger installation 2
- Charging 3
- Clear voice mail 11
- Conference call 16

D

- Delete from redial 34
- Delete from the call log 32
- Delete from the directory 26
- Desk mounting 5
- Dial a call log entry 30
- Dial a directory entry 24

- Dial a redial entry 34
- Directory 21
- DSL filter 2

E

- Edit a directory entry 25
- End a call 12

F

- FCC, ACTA and IC regulations 53
- Find handset 14

H

- Handset and telephone base indicators 37
- Handset display screen messages 35
- Handset layout 6

I

- Indicators 37
- Intercom 15

K

- Key tone 10

L

- Language 10

Index

M

- Maintenance 49
- Make a call 12
- Make a call log entry ready to dial 30
- Missed calls indicator 29
- Mounting bracket installation 4
- Mute 13

O

- Operating range 49

P

- Paging 14
- Parts checklist 1
- Pause 22, 25

R

- RBRC® seal 50
- Redial list 34
- Review the call log 29
- Ringer mute 13
- Ringer tone 9
- Ringer volume (handset) 8

S

- Save a call log entry to the directory 31
- Search the directory 24
- Speakerphone 12
- Store a directory entry 22
- Switch between external and intercom calls 19

T

- Technical specifications 55
- Telephone base installation 2
- Telephone base layout 7
- Transfer an external call 17
- Troubleshooting 41

V

- Voice mail 11
- Volume 8, 12

W

- Wall mounting 4
- Warranty 51

VTECH TELECOMMUNICATIONS LTD.
A member of THE VTECH GROUP OF COMPANIES.
Distributed in the U.S.A. by VTech Communications, Inc. Beaverton, Oregon
Distributed in Canada by VTech Technologies Canada, Ltd., Richmond, B.C.
Copyright ©2008 for VTECH TELECOMMUNICATIONS LTD.
Printed in China.

91-001514-040-100

Free Manuals Download Website

<http://myh66.com>

<http://usermanuals.us>

<http://www.somanuals.com>

<http://www.4manuals.cc>

<http://www.manual-lib.com>

<http://www.404manual.com>

<http://www.luxmanual.com>

<http://aubethermostatmanual.com>

Golf course search by state

<http://golfingnear.com>

Email search by domain

<http://emailbydomain.com>

Auto manuals search

<http://auto.somanuals.com>

TV manuals search

<http://tv.somanuals.com>