

INTRODUCTION

1. Becoming Familiar With Your Speakerphone

Congratulations! You have purchased one of the best performing 4-line speakerphones on the market!

This manual is designed to familiarize you with the **VT 4121**. To get the most use out of your **VT 4121**, we strongly recommend you read the manual before using your phone.

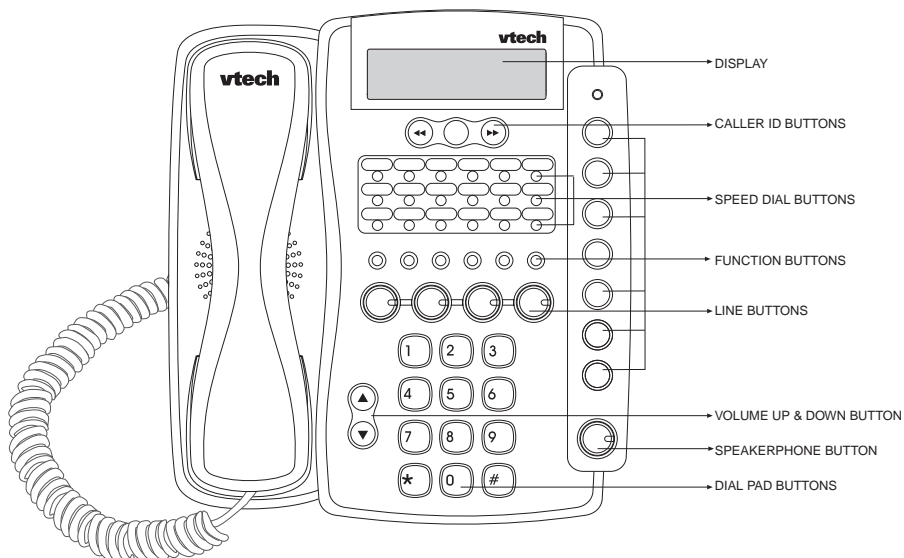

Display and Function Buttons:

◀▶ and ▶▶ keys

- Allow you to scan through the caller ID list.

CID

- Allows you to review calls in caller ID memory.

END

- Used to exit the programming mode.

ERASE

- Enables you to erase a programmed setting.

DND

- Used to place your telephone in Do Not Disturb mode.

DIAL

- Used to dial a telephone number from the caller ID list.

INTRODUCTION

PAGE

- You can page an individual extension.

PAGE ALL

- You can page all speakerphones simultaneously.

LINE Buttons

- Allow access for up to four (4) lines.

ICM

- Used to place an intercom call.

MUTE (ENTER)

- Mutes the microphone so the distant party can't hear you. Also used as "enter" during programming.

PROGRAM

- Used to define various features settings.

VOLUME

- Adjusts the ringing, receiver, and speaker volumes.

CONFERENCE

- You can establish a 3-way conference.

FLASH

- Programmable from 0.1 second to 1.2 seconds.

REDIAL (PAUSE)

- Redials the last number dialed from the telephone. Also used to insert a pause into a dialing sequence.

SPEAKER

- Allows you to speak hand free. Also controls headset use.

HOLD

- Enables you to place a line on hold or transfer the line.

2. The display

Your telephone is equipped with a wide angle viewing "supertwist" display. The 2-line by 16 character dot matrix liquid crystal display indicates the current time, day, date, and extension number. A call duration timer appears automatically to time your calls. The telephone number that you dial is displayed. You can also view caller ID information for an incoming call, provided that you are subscribing to Caller ID service from your telephone company.



JAN- The month of the year.
21- The date of the month.
SA- The day of the week.
11:35A- The time of day.
EXT- Your extension number.

3. The Features

Your **VT 4121** 4-line speakerphone provides many features such as:

Caller ID

- The caller's name and number and the time and date of the call will be displayed on the Speakerphones. (You will need to subscribe to Caller ID service provided by your local telephone company for each telephone line you want caller ID information displayed.)

INTRODUCTION

Caller ID Log

- Up to 99 telephone numbers will be stored in the Caller ID Log for review, redial, save to speed dial or deletion.

Message Waiting Indicator

- Message LED will indicate presence of network based voice messages. (You will need to subscribe to the Voice Messaging service provided by your local telephone company.)

Desktop Data Port

- Modular desktop connection for single line devices to line four (modem, fax, answering machine, etc.)

Headset Jack

- 2.5 mm jack for connecting an optional telephone headset for hands free communications.

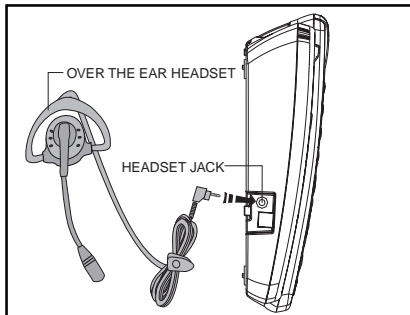

Handsfree Speakerphone

- This feature enables you to conduct telephone conversations handsfree.

Supertwist 2 x 16 Dot Matrix Liquid Crystal Display

- The display shows useful information such as the current time, and date, as well as a number dialed and the call duration.

Four (4) CO Lines with Line Status Indication

- You can connect up to 4 lines. The lamps will light to indicate the status of the lines.

Line-In-Use Detection of Other Connected Telephones (fax, modem, etc.)

- A line lamp will light to indicate that the line is busy. This helps to prevent accidental line pick-up interruptions.

Automatic Line Selection

- You can designate a line to be automatically accessed whenever you lift the handset or press the speakerphone button.

Distinctive Ringing

- Choose from four (4) unique ring tones to easily identify calls ringing at your telephone.

Delayed Ringing

- You can delay the ringing of a line for overflow call coverage.

Adjustable Ringer, Receive and Speaker Volume Levels

- You can adjust the volume levels to suit your own preferences.

Intercom with Direct Station Select Buttons

- You can call another extension with the touch of one button.

Intercom Call Pick-Up

- Any telephone can answer an intercom call ringing at another extension.

INTRODUCTION

Page

- You can voice page all extensions or perform a single page to a telephone. Meet-Me-Answer allows you to answer an All Page from any telephone. Automatic Mute may be programmed to prevent sounds in your room from being heard while someone makes a single page to you.

Hold with Reminder

- When you place a call on Hold you will hear a tone every thirty (30) seconds to remind you that the call is on Hold.

Call Privacy with Release

- When you are using an outside line, another person cannot join your conversation on that line unless you release Call Privacy.

Conference

- You can establish a 3-way conversation with any two outside parties or with one outside party and one other extension.

Call Forward to Other Speakerphones

- You can forward your calls to another speakerphone (VT 4121 only).

Call Transfer

- You can transfer a call to another extension.

Auto Busy Redial

- The telephone will automatically redial the last number dialed from the telephone, up to ten (10) attempts. This feature is useful when you are trying to call a busy telephone number.

Last Number Redial

- The telephone will automatically re-

dial the last number dialed from the telephone (up to 32 digits) with the touch of one button.

Speed Dialing

- You can store up to eighteen (18) frequently dialed telephone number which can be dialed by pressing one button.

Mute (Enter)

- While on a call, if you want to have a private conversation with someone in the room, you can mute the telephone's microphone so the distant party cannot hear you. The Enter feature is used during programming.

Do Not Disturb

- You can prevent interruptions from incoming calls, intercom calls, and pages by activating Do Not Disturb.

Pause

- Some telephone systems require you to dial an access code (i.e. 8 or 9) prior to dialing an outside number. A pause can be inserted after the access code in the dialing sequence.

Flash

- The telephone will send an electronic switch-hook signal for use with special services, such as call waiting, provided by your telephone company.

Tone/Pulse Dialing

- The telephone will operate with either tone (DTMF) or pulse (rotary) dialing service.

Hearing Aid Compatible

- This telephone will support hearing aids.

INTRODUCTION

4. Parts Check list

1. Handset
2. B/U
3. 10 foot handset cord
4. Wall mounting screws and anchors

5. AC power adapter
6. Two long line cords
7. Desk/Wall mount bracket
8. Over the ear headset
9. Manual

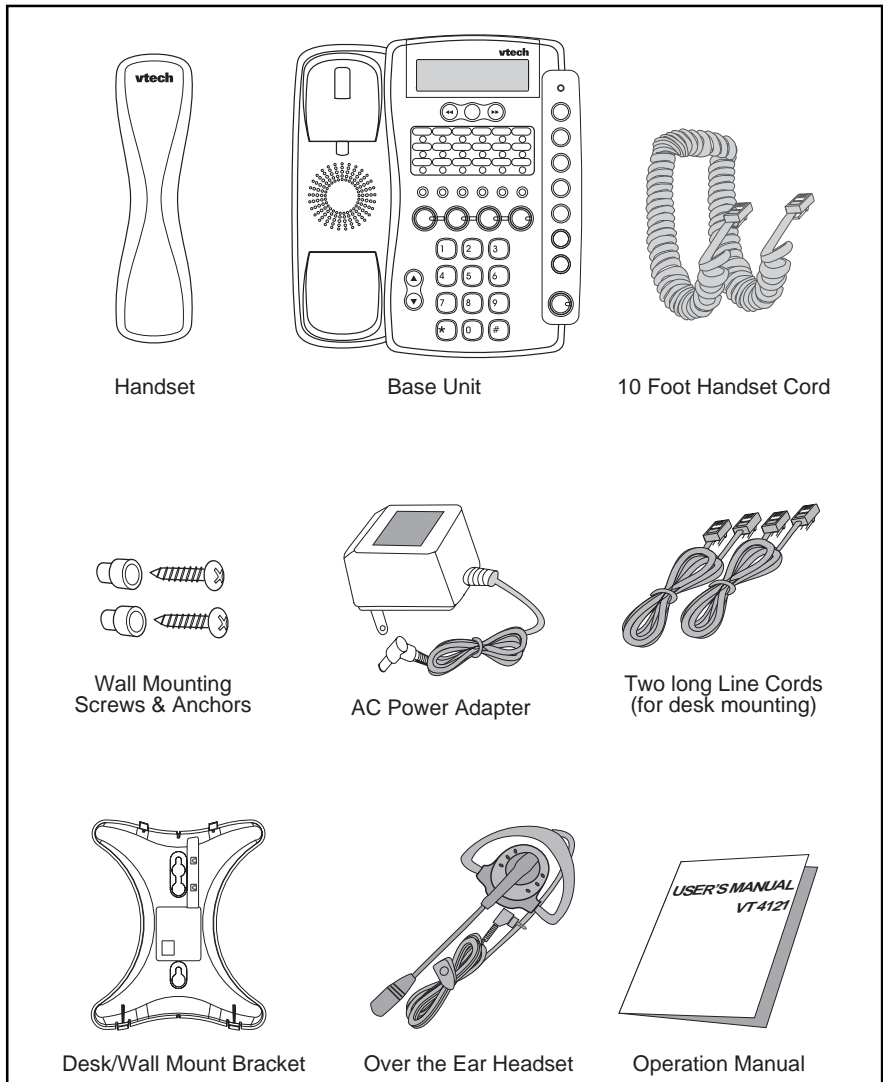

FCC REGULATIONS

This equipment complies with Parts 15 and 68 of the Federal Communications Commission (FCC) rules for the United States. It also complies with regulations RSS210 and CS-03 of Industry and Science Canada. Operation is subject to the following two conditions:

1. This device may not cause interference, and
2. This device must accept any interference, including interference that may cause undesired operation of the device.

A label is located on the underside of the base unit containing either the FCC registration number and Ringer Equivalence Number (REN) or the IC registration number and Load Number. You must, upon request, provide this information to your local telephone company.

This equipment is compatible with inductively coupled hearing aids.

Should you experience trouble with this telephone equipment, please contact:

VTECH COMMUNICATIONS

SERVICE DEPT. at 1-800-595-9511.

For repair/warranty information. The telephone company may ask you to disconnect this equipment from the line network until the problem has been corrected.

FCC Part 15

Warning: Changes or modifications to this unit not expressly approved by the party responsible for compliances could void the user's authority to operate the equipment.

The equipment has been tested and found to comply with part 15 of the FCC rules. These limits are designed to provide reasonable protection against harmful interference in a residential installation. This equipment generates, uses and can radiate radio frequency energy and, if not installed and used in accordance with the instructions, may cause harmful interference to radio communications. However, there is no guarantee that interference will not occur in a particular installation. If this equipment does cause harmful interference to radio or television reception, which can be determined by turning the equipment off and on, the user is encouraged to try and correct the interference by one or more of the following measures:

- Reorient or relocate the receiving antenna.
- Increase the separation between the equipment and receiver.
- Connect the equipment into an outlet or on a circuit different from that to which the receiver is connected.
- Consult the dealer or an experienced radio/TV technician for help.

FCC REGULATIONS

FCC Part 68

The FCC requires that you connect your cordless telephone to the nationwide telephone network through a modular telephone jack (USOC RJ11C, RJ11W or RJ14).

Your telephone company may discontinue your service if your equipment causes harm to the telephone network. They will notify you in advance of disconnection, if possible. During notification, you will be informed of your right to file a complaint with the FCC.

Occasionally, your telephone company may make changes in its facilities, equipment, operation, or procedures that could affect the operation of your equipment. If so, you will be given advance notice of the change to give you an opportunity to maintain uninterrupted service.

The base unit contains no user serviceable parts. The handset contains a user replaceable battery pack.

If it is determined that your telephone equipment is malfunctioning, the FCC requires that it not be used and that it be unplugged from the modular jack until the problem has been corrected. Repairs to this telephone equipment can only be made by the manufacturer or its authorized agents or by others who may be authorized by the FCC. For repair procedures, follow the instructions outlined under the VTECH Limited Warranty.

This equipment may not be used on coin service provided by the phone company or Party Lines.

The REN is useful in determining the number of devices you may connect to your telephone line and still enable the devices to ring when you receive a call. The general rule is that the REN value should not exceed 5.0A total; however, contact your local telephone company for the specific number in your area.

IMPORTANT SAFETY INSTRUCTIONS

When using your telephone equipment, basic safety precautions should always be followed to reduce the risk of fire, electric shock and injury to persons, including the following:

1. Read and understand all instructions.
2. Follow all warnings and instructions marked on the product.
3. Unplug this product from the wall outlet before cleaning. Do not use liquid cleaners or aerosol cleaners. Use a damp cloth for cleaning.
4. Do not use this product near water (for example, near a bath tub, kitchen sink, or swimming pool).
5. Do not place this product on an unstable cart, stand, or table. The product may fall, causing serious damage to the product.
6. Slots and openings in the cabinet and the back or bottom are provided for ventilation. To protect it from overheating, these openings must not be blocked by placing the product on the bed, sofa, rug, or other similar surface. This product should never be placed near or over a radiator or heat register. This product should not be placed in a built-in installation where proper ventilation is not provided.
7. This product should be operated only from the type of power source indicated on the marking label. If you are not sure of the type of power supply to your home, consult your dealer or local power company.
8. Do not allow anything to rest on the power cord. Do not locate this product where the cord will be abused by persons walking on it.
9. Never push objects of any kind into this product through cabinet slots as they may touch dangerous voltage points or short out parts that could result in a risk of fire or electric shock. Never spill liquid of any kind on the product.
10. To reduce the risk of electric shock, do not disassemble this product, but take it to a VTech authorized service facility. Opening or removing cabinet parts other than specified access doors may expose you to dangerous voltages or other risks. Incorrect reassembling can cause electric shock when the appliance is subsequently used.
11. Do not overload wall outlets and extension cords as this can result in the risk of fire or electric shock.
12. Unplug this product from the wall outlet and refer servicing to a VTech authorized service facility under the following conditions:
 - a. When the power supply cord or plug is damaged or frayed.
 - b. If liquid has been spilled into the product.
 - c. If the product has been exposed to rain or water.

IMPORTANT SAFETY INSTRUCTIONS

- d. If the product does not operate normally by following the operating instructions. Adjust only those controls that are covered by the operating instructions, because improper adjustment of other controls may result in damage and will often require extensive work by a VTech authorized technician to restore the product to normal operation.
 - e. If the product has been dropped and the cabinet has been damaged.
 - f. If the product exhibits a distinct change in performance.
13. Avoid using a telephone (other than a cordless type) during an electrical storm. There may be a remote risk of electric shock from lighting.
 14. Do not use the telephone to report a gas leak in the vicinity of the leak.

SAVE THESE INSTRUCTIONS

INSTALLATION

1. Site Planning

Select a location where the speakerphone will not interfere with daily activities. You can choose to connect the speakerphone to as many as four telephone lines. The speakerphone can be connected to two 2-line (RJ14C) modular telephone jacks to accommodate all four lines. The speakerphone is factory-programmed for intercom extension number 12.

When the telephone is first installed, the display will show a message to check the clock and the extension ID. Refer to the Programming section to set the extension number.

IMPORTANT: For all system features to operate correctly, every speakerphone, must be connected to the same Line 2 wiring. They do not need to be located in the same area.

2. Installing the Speakerphone

You can choose from two (2) installation options:

- Locate the telephone on a desk or tabletop, or
- Mount the telephone on the wall.

2.1 Desk/Tabletop Mounting

To have better viewing angle, you could choose to install the desk/wall mount bracket by squeezing the side tabs on the thicker end of the bracket, insert them into their respective slots.

- a. Position the telephone in the desired location on a tabletop or desk.
- b. Plug one of the long line cords into the L1/2 jack at the back of the telephone. Plug the other long line cord into the L3/4 jack.
- c. Plug the AC adaptor power cord into the jack at the back of the telephone.

Note: Use only the AC power adaptor provided with the telephone.

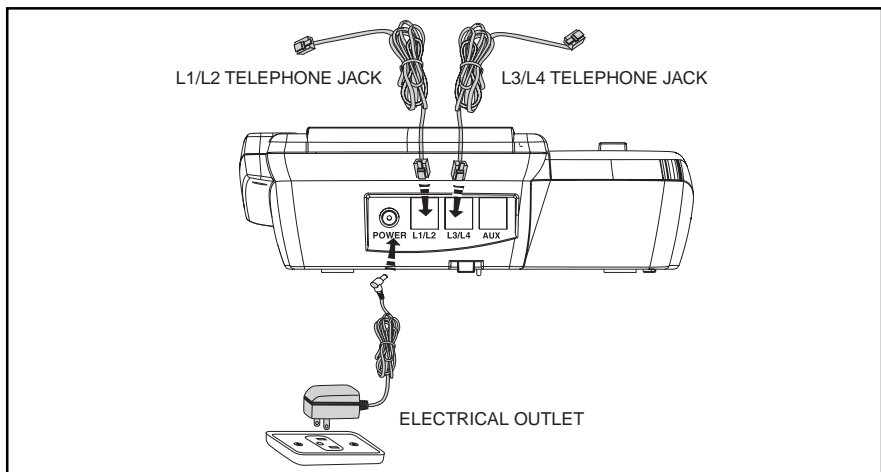

INSTALLATION

- d. Insert one end of the handset cord into the handset and the other end into the left side of the telephone. Place the handset in the telephone cradle.
- e. Plug the two long line cords into the wall jacks. **Double check that you have not reversed the L1/L2 and L3/L4 cord connections.**
- f. Plug the AC power cord adaptor into a standard 120V AC wall outlet. The display shows "Check Clock & ID ". Refer to the programming section to program the clock and change the extension ID.
- g. Ensure that all cords are positioned to prevent tripping and rubbing which could create a potential electrical hazard.

2.2 Wall Mounting

You will want to ensure the following:

- The location where the telephone will be mounted should be away from electrical cables, pipes, or other items which may be punctured when the screws are inserted into the wall.
- The wall surface should be capable of supporting the telephone weight.
- Use the screws and anchoring devices provided with the telephone.
- The telephone is located near an AC outlet.

Two (2) long line cords are provide to meet various wall mounting conditions. A template is provided at the back of this manual to assist you with the installation of the telephone directly onto

the wall.

1. Insert the two (2) screws and anchoring devices into the wall 3-5/8 inches apart vertically, allowing approximately 3/16 inch between the wall and screw heads for mounting the telephone. Ensure that the screws are secure.
2. Turn the speakerphone over to view the bottom.

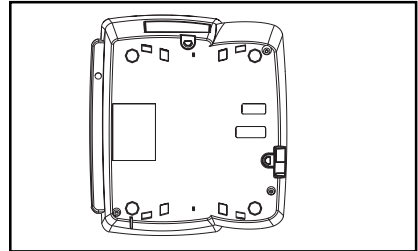

3. If you have already installed the desk/wall mount bracket in desk mode, please remove the desk/ wall mount bracket by gently moving one tab at a time while pulling the peg out of the tab hole.
4. Rotate the bracket and install it in the wall mounting position by aligning the four holes on the bracket with the four hooks on the bottom of the telephone.

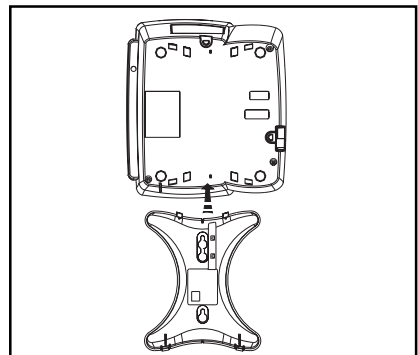

INSTALLATION

5. Slide the bracket down onto the hooks and snap into place.
6. Plug one of the line cord into the L1/L2 jack at the back of the telephone. Plug the other line cord into the L3/L4 jack.
7. Plug the AC adapter power cord into the bottom of the telephone. Use only the AC power adapter provided with the telephone.
8. Position the telephone on the two screws in the wall and slide the telephone downward to secure it to the wall.
9. Rotate the handset tab by lifting up

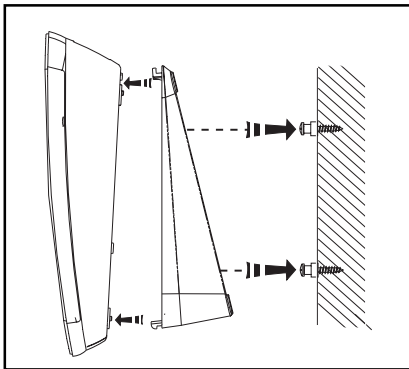

- and turning to position it in the wall mount mode.
10. Insert one end of the handset cord into the handset and the other end into the left side of the telephone. Hang the handset in the telephone cradle.
 11. Plug the two line cords into the wall jacks. **Double check that you have not reversed the L1/L2 and L3/L4 cord connections.**
 12. Plug the AC power cord adapter into a standard 120V AC wall outlet. The display shows " Check Clock & ID". Refer to the programming section to program the clock and change the extension ID.
 13. Ensure that all cords are positioned to prevent tripping and rubbing which could create a potential electrical hazard.

PROGRAMMING

1. General Programming Guidelines

- Press **PROGRAM** to enter the programming mode. The **MUTE (ENTER)** will light steady. The display will show:

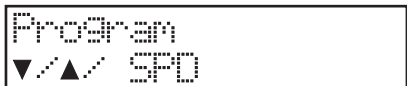

- The **▼VOLUME ▲** buttons are used for scrolling through the programming selections.
- The **MUTE (ENTER)** button acts as "enter".
- Press **HOLD** to return to the previous main menu.
- Pressing a **SPEED DIAL** button allows you to program that particular button.
- Press **ERASE** to erase a previously programmed setting.
- Press **END** to exit the programming mode.

Note1: A button must be pressed within about 30 seconds or the programming mode will be automatically cancelled.

Note 2: When a feature has been successfully programmed, you will hear a single confirmation tone and the display will show "OK!". If the feature has not been programmed correctly, you will hear a double tone and the display will show "Fail!".

Note 3: If you are already in the programming mode all the features can be programmed consecutively without pressing **PROGRAM** again.

2. Extension Number

Default setting: 12
Extension Number Range: 11-22

Each Speakerphone must have a unique extension number programmed. It is highly recommended that you assign a new extension number at the time of installation.

You will hear a continuous alerting tone if two speakerphones are assigned the same extension number.

1. Press **PROGRAM**.
2. Press **▼ VOLUME**. The display shows:



3. Press **MUTE (ENTER)**.
4. Press **▼VOLUME ▲** to select extension number.
5. Press **MUTE (ENTER)** to save.

3. Tone/Pulse Dialing

Default Setting: Tone

If you have tone dialing service from your telephone company, you will want to ensure that your telephone is set for tone dialing mode.

1. Press **PROGRAM**.
2. Press **VOLUME ▲** until the display shows:

PROGRAMMING



Tone/Pulse
▼/▲ENTER

3. Press **MUTE (ENTER)**. The display shows:



Tone
▼/▲ENTER

4. Press **▼VOLUME ▲** to select the dialing mode.
5. Press **MUTE (ENTER)** to save.

4. Date and Time

Default setting: Jan 01 FR 1:00A

You can program the time in either 12-hour or 24-hour (military) format.

1. Press **PROGRAM**.
2. Press **VOLUME ▲** until the display shows:

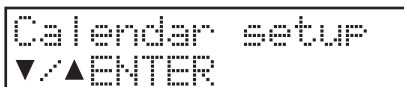

Calendar setup
▼/▲ENTER

3. Press **MUTE (ENTER)** to program the month.
4. Press **▼ VOLUME ▲** to view the months.
5. Press **MUTE (ENTER)** to select the appropriate month and proceed to programming the date.
6. Press **▼ VOLUME ▲** to view the choice for the date.
7. Press **MUTE (ENTER)** to select the appropriate date and proceed to programming the day of the week.
8. Press **▼ VOLUME ▲** to view the choices for the day.

9. Press **MUTE (ENTER)** to select the appropriate day and proceed to programming the clock for AM/PM or 24-Hour.

10. Press **▼ VOLUME ▲** to switch between the three choices.

11. Press **MUTE (ENTER)** to select the appropriate setting and proceed to programming the hour.

12. Press **▼ VOLUME ▲** to view the choice for the hour.

13. Press **MUTE (ENTER)** to select the appropriate hour and proceed to programming the minutes.

14. Press **▼ VOLUME ▲** to view the choice for the minutes.

15. Press **MUTE (ENTER)** to select the appropriate minutes. You will hear a single confirmation tone and the display will show the new date and time.

5. CO/PBX Line Ringing

Default Setting: Enabled

You can program the ringer for each central office/PBX line(1-4). If you do not want the line(s) to ring at your telephone, choose the "OFF" setting for each line.

1. Press **PROGRAM**.
2. Press **▼ VOLUME** until the display shows:



Ring on/off
▼/▲ENTER

3. Press **MUTE (ENTER)**. The display shows:



CO#1 RING on/off
▼/▲ENTER

PROGRAMMING

4. Press **MUTE (ENTER)** again. The display shows:



CO#1 Enable
▼/▲ENTER

5. Press ▼ **VOLUME** ▲ to choose the setting.
6. Press **MUTE (ENTER)**.

To continue programming the remaining lines press **VOLUME** ▲ and then perform steps 4-6.

6. CO Line Ring Tone

Default Setting: 1
Range: 1-4

You can choose one of four different ringing tones for your telephone. The selection chosen will apply to all four CO lines on your telephone.

1. Press **PROGRAM**.
2. Press ▼ **VOLUME** until the display shows:



Ringer type
▼/▲ENTER

3. Press **MUTE (ENTER)**. The display shows:



Type 1
▼/▲ENTER

4. Press ▼ **VOLUME** ▲ to select a different ring tone. You will hear a sample tone for each choice.
5. Press **MUTE (ENTER)**.

7. Delayed Ringing

Default Setting: Disabled

Range: Disable, 2 seconds to 30 seconds (2 second increments)

You may choose to have the CO line ringing delayed for overflow and caller ID applications.

1. Press **PROGRAM**.
2. Press ▼ **VOLUME** until the display shows:



Delayed ring
▼/▲ENTER

3. Press **MUTE (ENTER)**. The display shows:



Disable
▼/▲ENTER

4. Press ▼ **VOLUME** ▲ to select the delay time between 2 seconds and 30 seconds (in 2 second increments).
5. Press **MUTE (ENTER)**.

8. CO Trunk Connection

Default Setting: All Lines Connected

Your telephone can detect another telephone, facsimile, or modem that is in-use on one or more of the CO lines. This privacy feature will prevent accidental instruction by another **VT4121** speakerphone user. The "Line-In-Use" circuit will light the CO line button if the line is not physically connected. For instance, if you only have lines 1,2, and 3 connected you can disable line 4(if you do not disable that line, the lamp will remain lit steady even though you can't access the line). When you disable a CO line the lamp and button will not operate.

PROGRAMMING

1. Press **PROGRAM**.
2. Press **▼ VOLUME** until the display shows:

```
Line connection
▼/▲ENTER
```

3. Press **MUTE (ENTER)**, The display shows:

```
CO#1 connection
▼/▲ENTER
```

4. Press **MUTE (ENTER)**. The display shows:

```
CO#1 Enable
▼/▲ENTER
```

5. Press **▼ VOLUME ▲** to choose the setting.
6. Press **MUTE (ENTER)** to save.

To continue programming the remaining lines press **VOLUME ▲** and then perform steps 4-6.

9. Automatic Line Selection

Default Setting: CO 1

The line that you assign for automatic line selection(line preference) will be automatically accessed when you pick up the handset or press **SPEAKER**.

1. Press **PROGRAM**.
2. Press **▼ VOLUME** until the display shows:

```
Auto-Line choice
▼/▲ENTER
```

3. Press **MUTE (ENTER)**. The display

shows:

```
Auto-Line=co#1
▼/▲ENTER
```

4. Press **▼ VOLUME ▲** to choose the line(or intercom) you want to program for this feature.
5. Press **MUTE (ENTER)** to save.

10. Call Forward

Default Setting: OFF
Range 11-22

When this feature is enabled (on) any intercom or transferred call you receive will be forwarded to the Speakerphone extension that you have identified.

When the feature is enabled, upon receiving a call you will hear a triple tone and the display will briefly show Call forward on the display prior to the call being forwarded.

1. Press **PROGRAM**.
2. Press **▼ VOLUME** until the display shows:

```
Call forward
▼/▲ENTER
```

3. Press **MUTE (ENTER)**. The display shows:

```
Call forward=OFF
▼/▲ENTER
```

4. Press **▼ VOLUME ▲** to select the extension number (11-22) where you want to forward your calls.
5. Press **MUTE (ENTER)** to save.

PROGRAMMING

11. Auto Mute Enable/Disable

Default Setting: Disable

This feature prevents unauthorized eavesdropping when someone makes a single page to you.

Note: For intercom page with handsfree reply at your extension, Auto Mute must be set to Disable.

1. Press **PROGRAM**.
2. Press **VOLUME ▲** until the display shows:

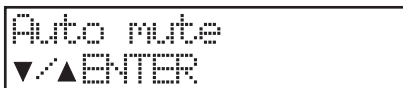

Auto mute
▼/▲ENTER

3. Press **MUTE (ENTER)**. The display shows:

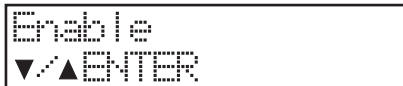

Enable
▼/▲ENTER

4. Press **▼ VOLUME ▲** to choose between the enable or disable setting.
5. Press **MUTE (ENTER)**.

12. Flash

Default Setting: 0.7 seconds
Range: 0.1 seconds to 1.2 seconds

This feature is typically used to access custom calling service. You may also use Flash to end a call without hanging up the handset or pressing **SPEAKER**.

1. Press **PROGRAM**.
2. Press **VOLUME ▲** until the display shows:



Flash length
▼/▲ENTER

3. Press **MUTE (ENTER)**. The display shows:



0.7 second(s)
▼/▲ENTER

4. Press **▼ VOLUME ▲** to choose the flash length.
5. Press **MUTE (ENTER)** to save.

13. Speed Dial

You can store eighteen (18) frequently dialed numbers in a speed dial bin by pressing the appropriate speed dial button during programming.

A number stored in the Called ID memory can be stored in a speed dial bin. You can store numbers in either pulse or tone dialing modes. Pauses and flashes may also be stored in memory. Each speed dial bin can store up to 16 digits (numbers) including pause, tone, and flash.

13.1 Storing a Telephone Number in Speed Dial

1. Press **PROGRAM**.
2. Press **SPEED DIAL** Button 1. The display shows:



01: (empty)
▼/▲ENTER

3. Press **MUTE (ENTER)**. The display shows:

PROGRAMMING



01: (empty)
digi/CID/DEL

4. Dial the number (digi) you want to store.
5. Press **MUTE (ENTER)** to save.

Repeat step 2 and press another speed dial button to continue programming speed dial numbers.

13.2 Storing a Caller ID Number

1. Display the number in the caller ID list. (Refer to Caller ID Operation).
2. Press **PROGRAM**.
3. Press the **SPEED DIAL** button.
4. Press **MUTE (ENTER)**.
5. Press **CID**.
6. Press **MUTE (ENTER)** to save.

13.3 Erasing the Contents of a Speed Dial Bin

1. Press **PROGRAM**.
2. Press the **SPEED DIAL** button.
3. Press **MUTE (ENTER)**.
4. Press **ERASE** twice. For example, if you are deleting the contents of bin 10, the display will show:

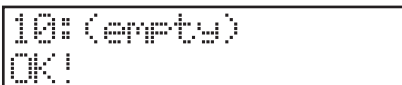

10: (empty)
OK!

14. Line In Use Detection

Default Setting: Enable

This feature allows the speakerphone to detect other telephone devices using any of the four telephone lines. The speakerphone indicates line-in-use status by illuminating the LED correspond-

ing to the line-in-use. This feature may not be compatible with some telephone systems. You may disable line-in-use detection if you use the speakerphone as a private telephone system extension.

1. Press **PROGRAM**.
2. Press **▼ VOLUME** until the display shows:



LIU Detection
▼/▲ENTER

3. Press **MUTE (ENTER)**. The display shows:



Enable
▼/▲ENTER

4. Press **▼ VOLUME ▲** to choose setting.
5. Press **MUTE (ENTER)**.

15. Reset default Values

You may clear all the programmed data, and reset all parameters back to the original factory default values.

1. Press **PROGRAM**.
2. Press **▼ VOLUME** until the display shows:



Back to default
▼/▲ENTER

3. Press **MUTE (ENTER)**. The display shows:

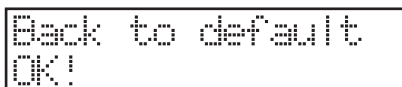

Back to default
OK!

PROGRAMMING

For your reference, here is the default value list:

Extension ID:	12
Call forward:	Disable
Ringer On/Off:	“on” for each co line
Ringer Type:	Type 1
Delayed Ring:	Disable
Co Trunk Connection:	Connected for each line
Line Preference:	CO #1
Auto-Mute:	Disable
Tone/Pulse dialing:	Tone Dialing
Flash Length:	700 mili-seconds
LIU Detection:	Enable
Calendar:	Jan 01 FR 12:00A
Area Code Setting:	None
Speed Dialing:	Empty
Ringer Volume:	Middle
Speaker Volume:	Level 4
Handset Volume:	Minimum Level
Headset Volume:	Middle

BASIC OPERATION

1. Lamp (LED) Operation

Line Buttons

Off

- Lamp is off when the line is not being used.

On steady

- Lamp is on if the line is being used by another extension.

Wink

- Lamp will “wink” to indicate the line you are talking on.

Slow flash

- Lamp flashes slowly when an incoming call is ringing or you receive a transferred call.

Fast flash

- Lamp flashes fast when another extension places that line on hold.

Very fast flash

- Lamp flashes very fast when you place a line on hold or you transfer a call.

ICM Button

Off

- Lamp is off when you are not using the intercom.

On steady

- Lamp is on steady when the intercom path is busy.

Wink

- Lamp will “wink” when you are using the intercom.

Fast flash

- Lamp flashes fast when an intercom call is ringing at your phone.

Speaker Button

Off

- Lamp is off when the telephone is idle or you are using the handset.

On steady

- Lamp is on if you are using the speakerphone.

Slow flash

- Lamp slowly flashes when you are using Auto Busy Redial (while waiting for the telephone to redial.)

Fast flash

- Lamp flashes fast when the Auto Busy Redial feature is used.

Wink

- Lamp will “wink” when you are using the headset.

Mute (Enter) Button

Off

- Lamp is off when the telephone is not muted.

On steady

- Lamp is on when the telephone is muted, the telephone is in the programming mode or the telephone is performing Auto Busy Redial.

Message Lamp

The lamp to the right of the CID keys will:

BASIC OPERATION

Slow Flash

- Lamp will slowly flash when you have new Telco voice messages (subscription required.)

Fast Flash

- Lamp will flash quickly when the speakerphone is ringing.

On steady

- Lamp will light steady when the speakerphone is in the Do Not Disturb mode.

Off

- Lamp is off if there are no new messages and the Do Not Disturb mode is off.

2. Line-In-Use Indication

If a single line telephone or other equipment such as a facsimile machine is using a line, that line lamp will light on your telephone to indicate that the line is busy. You may intrude on that busy line to verify that the line is not out of order. However, lines being used solely by **VT 4121** speakerphone are privacy protected from intrusion.

3. Adjusting the Handset Volume Level

While using the handset, you may adjust the volume level of the distant party's voice by pressing **▼VOLUME ▲**. You will hear a confirmation tone when the highest or lowest volume setting is reached.

4. Adjusting the Speaker Volume Level

While using the speakerphone, you may adjust the volume level of the distant party's voice by pressing **▼ VOLUME ▲**. You will hear a confirmation tone when the highest or lowest volume setting is reached.

5. Adjusting the Headset Volume Level

While using a headset, you may adjust the volume level of the distant party's voice by pressing **▼ VOLUME ▲**. You will hear a confirmation tone when the highest or lowest volume setting is reached.

6. Adjusting the Ringer Volume Level

While the telephone is idle (not being used), you may adjust the ringer volume level by pressing **▼ VOLUME ▲**. You will hear a confirmation tone when the highest or lowest volume setting is reached.

7. AC Power Failure Indication

If power has been interrupted to your speakerphone the display will show:



Check Clock & ID

Press any button or key to cancel the power failure message.

BASIC OPERATION

8. Making an Outside Call

Each **VT 4121** speakerphone may have four (4) outside lines programmed for direct access and dialing.

8.1 Using the Handset

1. Lift the handset. (If you have Automatic Line Selection enabled, the telephone will automatically select a line-proceed to Step 3).
2. Press a line button.
3. Dial the telephone number. The display will show the digits you dial. After the last digit is dialed, the timer will soon begin to display the call duration:

Note: If you dial more than 15 digits, all the digits will shift to the left of the display:

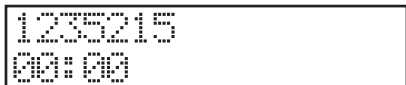

4. Hang up the handset or press **END** when you've completed your call.

8.2 Using the Speakerphone / Headset

Note: The Speakerphone will automatically switch to headset mode when a compatible headset is plugged into the headset jack.

1. Press **SPEAKER**. (If you have Automatic Line Selection enabled, the telephone will automatically select a line-proceed to Step 3.)
2. Press a line button.

3. Dial the telephone number. The display will show the digits you dial. After the last digit is dialed, the timer will soon begin to display the call duration:

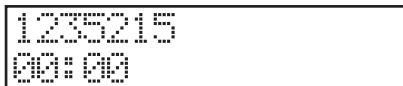

Note: If you dial more than 15 digits, all the digits will shift to the left of the display.

4. Press **SPEAKER** or **END** when you've completed your call.

9. Answering an Outside Call

9.1 Using the Handset

Lift the handset. The ringing outside line is automatically selected.

9.2 Using the Speakerphone

1. Press the flashing line button,

OR

Press **SPEAKER**

Note: When several lines are ringing, you can directly answer any line by pressing the associated line button.

10. Placing a Call on Hold

While on a call:

1. Press **HOLD**. The display will briefly show:

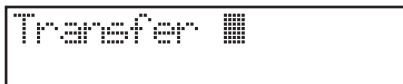

BASIC OPERATION

2. Hang up.
Press **ICM**. If you want to make an intercom call without autotransferring the line or simply hang up the handset and the line will remain on hold.

11. Retrieving a Call on Hold

When you place a call on Hold at your speakerphone you will hear a brief remainder tone after 30 seconds.

To retrieve a held call press the line button corresponding to the holding line.

12. Making an Intercom Call

12.1 Using the Handset

Note: Skip Step 1 if you programmed the intercom for Automatic Line Selection.

1. Press **ICM**. The display will show:



ICM ■■

2. Lift the handset.
3. Dial the desired intercom number (from 11 to 22). For instance, if you dial intercom number 15 the display will show:



ICM 15

When the person you called answers, your display will show:



JAN 21 SA 11:35A
ICM 15

4. Hang up the handset to end the call.

Note1: If the telephone you are calling is busy, you will hear busy tone. If the telephone you are calling is in Do Not Disturb (DND) mode, you will hear DND tone.

Note 2: If you do not perform Step 3 above within approximately 10 seconds, the intercom will be released.

12.2 Using the Speakerphone

Note: Skip Step 1 below if you programmed the intercom for Automatic Line Selection.

1. Press **ICM**. The display will show:



ICM ■■

2. Press **SPEAKER**.
3. Dial the desired intercom number (from 11 to 22). For instance, if you dial intercom number 15 the display will show:



ICM 15

When the person you called answers, your display will show:



JAN 21 SA 11:35A
ICM 15

4. Press **SPEAKER** to hang up.

Note 1: If the telephone you are calling is busy, you will hear busy tone. If the telephone you are calling is in Do Not Disturb

BASIC OPERATION

(DND) mode, you will hear DND tone.

Note 2: If you do not perform Step 3 above within approximately 10 seconds, the intercom will be released.

12.3 Using the Direct Station Buttons

The speed dial buttons are also preprogrammed for use as Direct Station Selection (DSS) buttons. You can access extensions 11 through 22 by simply pressing the appropriate button.

Note: Skip Step 1 below if you programmed the intercom for Automatic Line Selection.

1. Press **ICM**.
2. Lift the handset or press **SPEAKER**.
3. Press the desired **DSS** button.
4. Hang up the handset to end the call.

Note1: If the telephone you are calling is busy, you will hear busy tone. If the telephone you are calling is in Do Not Disturb (DND) mode, you will hear DND tone.

Note 2: If you do not perform Step 3 above within approximately 10 seconds, the intercom will be released.

13. Answering an Intercom Call

13.1 Using the Handset

For example, if Station 12 is calling you, your handset will ring, your **ICM** button will flash, and the display will show:



ICM 12

1. Lift the handset.



JAN 21 SA 11:35A
ICM 12

2. Hang up the handset to end the call. The display will return to the idle mode.

13.2 Using the Speakerphone/Headset

For example, if Station 12 is calling you, your handset will ring, your **ICM** button will flash, and the display will show:



ICM 12

1. Press **ICM** or **SPEAKER**.



JAN 21 SA 11:35A
ICM 12

2. Press **END** or **SPEAKER** to end the call. The display will return to the idle mode.

14. Intercom Call Pick Up

You may answer an intercom call ringing at another speakerphone in the system by pressing **ICM**.

15. Transferring a Call

While on a line:

1. Press **HOLD**. The display shows:

BASIC OPERATION



Transfer █

2. Dial the extension number where you will transfer the call (or press a DSS button). For instance, if you want to transfer a call to extension 15 the display will show:

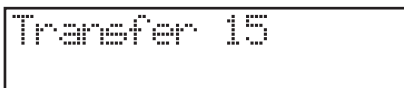

Transfer 15

Note 1: You will hear a single tone if the call has transferred.

Note 2: You will hear a transfer reminder tone every 30 seconds if the transfer isn't answered.

Note 3: You can still transfer calls even if the system intercom is busy.

16. Receiving a Transferred Call

Any extension may pick-up a transferred call.

You will hear transfer ring tone and the lamp for the transferred line will flash.

17. Muting a Call

The Mute feature turns off the telephone handset and speakerphone microphone so the distant party cannot hear you. You can also use Mute to block out background noise momentarily.

While on a line or using the intercom:

1. Press **MUTE (ENTER)**. The lamp will light.
2. Press **MUTE (ENTER)** again to deactivate the feature.

18. Conferencing

A three-way conference call may consist of two (2) outside lines or one (1) outside line and two (2) extensions.

18.1 Two (2) Outside Lines

While on a call on the first line:

1. Press **HOLD**. The first line is placed on HOLD and the display shows:



Transfer █

2. Press a second line button.
3. Dial the telephone number for the second party.
4. Press **CONFERENCE**. The display will show the second telephone number that you dialed:

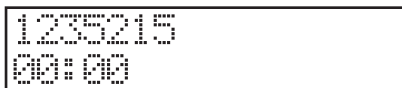

1235215
00:00

5. Hang up to disconnect the lines and end the conference.

18.2 One (1) Outside Line and Two (2) Extensions

While on a call on the first line:

1. Press **HOLD**. The first line is placed on Hold and the display shows:



Transfer █

2. Press **ICM**.
3. Dial the intercom number for the other internal party. For example, if you dial extension 20 the display will show the following when extension

BASIC OPERATION

20 answers:



JAN 21 SA 11:35A
ICM 20

4. Press **CONFERENCE**. The display shows:



1235215
00:00

5. Hang up to end the conference.

Note: When you hang up extension 20 will still be connected to the line until that extension hangs up.

19. Paging

19.1 Paging Another Speakerphone

1. Lift the handset.
2. Press **PAGE**. The display shows:

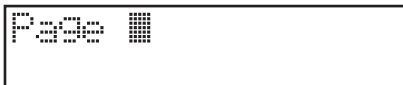

Page █

3. Dial the desired intercom number. For instance, if you dial extension 15 the display shows:

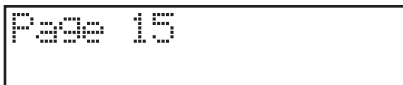

Page 15

4. Make your page announcement.

Note: Only **VT4121** speakerphones can receive voice paging.

19.2 Answering a Page

You will hear a tone prior to receiving a voice page. You may then answer the page using the speakerphone.

Note: If you have programmed Auto-Mute, the Mute lamp will turn on and sounds in your room will not be heard by the calling party.

1. Lift the handset or press **MUTE (ENTER)** (if the Mute lamp is lit).
2. Hang up to end the call.

19.3 Changing Signaling Modes

If you have made a voice page to an extension and do not receive a reply, press **ICM** and the other extension will begin tone signaling to alert users in the area.

To Switch From Page Mode to Tone Ringing:

After establishing a voice page to another extension, press **ICM**.

To Switch From Tone Ringing to Page Mode:

After establishing an intercom call, Press **PAGE**.

19.4 To Voice Page All Speakerphone Extensions

1. Lift the handset.
2. Press **PAGE ALL**. The display shows:

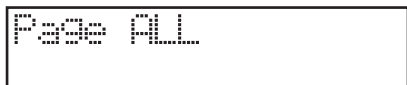

Page ALL

3. Announce your message.

BASIC OPERATION

19.5 Receiving a Voice Page to All Speakerphone Extension.

For example, if extension 12 sends a Voice Page to all telephones in the system, the extension telephone will show:

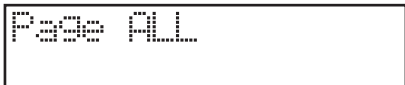

19.6 Meet Me Answer to All Page

Press **PAGE** or **PAGE ALL** to answer the page. For instance, if extension 12 performs an All Page, the display shows:



20. Do Not Disturb

You may use the DND feature to avoid telephone interruptions. When activated, you will not hear incoming ringing from outside lines, intercom calls and pages.

While the telephone is idle:
Press **DND**. The display shows:



Note: Press **DND** again to deactivate **DND**. The display will return to the idle mode.

21. Using the Flash Button

You may use Flash instead of pressing the hookswitch to access custom calling features provided by your telephone

service such as call waiting, 3-way calling, etc.

While on a line:

1. Press **FLASH** to obtain new dial tone.
2. Dial the new telephone number or service code.

22. Using the Pause Feature

During speed dialing you can use the Pause feature to insert a delay in a dialing sequence. Pause may be needed to access certain banking and long distance services. Each pause is 3 seconds. During manual dialing, you can press the button repeatedly to create a longer delay.

While on a line:

1. Dial the numbers prior to the pause.
2. Press **REDIAL/PAUSE**.
3. Dial the remaining number after the pause.

23. Auto Busy Redial

To continue dialing a busy number from the telephone:

When you dial a telephone number that is busy, hang up and perform the following steps.

1. Press **SPEAKER** (If you have Automatic Line Selection enabled, telephone will automatically select a line-proceed to Step 3.)
2. Press a line button.
3. Press **REDIAL/PAUSE**. The telephone will dial the number. If the distant party is still busy, the telephone will hang up after about 15 seconds, it will then wait about 5

BASIC OPERATION

seconds, and then dial the number again.

4. When you hear ringing, lift the handset to speak.

Note: The **MUTE** lamp lights steady when the Auto Busy Redial feature is activated. The **SPEAKER** lamp will flash slowly during dialing attempts, and quickly during dialing.

24. Last Number Redial

To dial the last number dialed from the telephone:

1. Lift the handset.
2. Press a line button.
3. Press **REDIAL/PAUSE** and the number is dialed automatically.

Note: You may also redial using the speakerphone by simply pressing **REDIAL/PAUSE**. If you press **SPEAKER** first, you will activate Auto Busy Redial.

25. Speed Dialing

1. Lift the handset.
2. Press a **SPEED DIAL** button. The number will be dialed automatically.

Note: You may use the speakerphone to dial a speed dial number by simply pressing the **SPEED DIAL** button.

26. Call Privacy

Another extension cannot access a line that you are using unless you override Privacy for that call. Overriding the Call

Privacy feature allows someone else to join your conversation on the same line.

To override (disable) Call Privacy:

Press the line button that you are currently accessing until you hear a single tone.

To enable Call Privacy:

Press the line button until you hear a double tone.

Note 1: When non-system equipment, such as a single line telephone or facsimile machine, is using a line, any VT 1421 system telephone may access that line also. However, when a system telephone accesses the line the Call Privacy feature is enabled and additional system telephone may not access the line.

Note 2: Due to the direct wiring of single line telephones, cordless telephones, facsimile machines, or modems, it is not possible to prevent these devices from accidentally intruding on a line that you are using.

27. Pulse-to-Tone Switching

If you are pulse dialing service you may need to access a computer or calling services that use tone dialing.

While on a line:

1. Dial the telephone number in pulse mode.
2. Dial *tone to change to the tone dialing mode.

BASIC OPERATION

3. Dial the remaining numbers to be dialed in the tone mode.

Note: When you hang up the telephone will return to the pulse dialing mode.

28. Message Waiting Light

If you subscribe to voice mail service from your local telephone company, the LED to the right of the Caller ID keys will flash when someone has left a message for you. This feature is compatible with FSK signaling from the telephone company*. The display will indicate line (1-4) that the message signal was received. The display will show:

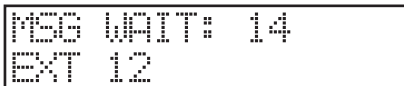

```
MSG WAIT: 14
EXT 12
```

In this example, there is a message waiting on L1 and L4. Follow your voice mail service instructions for retrieving a message.

Note: Your telephone company may send a signal to remove the indicator light once you have retrieved your messages, or you may press **ERASE** twice to remove the indicator light manually.

*Not all local telephone service providers send the FSK signal required to activate the Message Waiting Light. If you have voice messaging, but your Message Waiting does not flash when receive new messages, check with your service, provider to see if FSK signaling is available.

CALLER ID OPERATION

IMPORTANT: You must subscribe to **Caller ID service provided by your local telephone company on each line you wish to receive call information.**

1. Caller ID Buttons

There are five (5) buttons used to access Caller ID functions:

CID

- To switch between multiple caller ID screens during 2 or more ringing calls.



- To move backward through the caller ID list.



- To move forward through the caller ID list.

ERASE

- To erase a call from the caller ID list.

DIAL

- To dial a number from the caller ID list.

2. Programming the Area Code

Default: empty

When you receive a local call from a person with your same home area code, the telephone will not store the area code. This feature will enable you to redial the caller in the future.

2.1 To Program the Area Code

1. Press **PROGRAM**.
2. Press **VOLUME ▲** until the display shows:

Area code
▼/▲/ENTER

3. Press **MUTE (ENTER)**.
4. Dial the area code.
5. Press **MUTE (ENTER)**.

2.2 To Erase the Programmed Area Code

1. Press **PROGRAM**.
2. Press **VOLUME ▲** until the display shows:

Area code
▼/▲/ENTER

3. Press **MUTE (ENTER)**.
4. Press **ERASE**. The display will show:

delete?
DEL

5. Press **ERASE** again. The area code is deleted.

3. Receiving a Call

You will need to subscribe to the Caller ID service from your telephone company to receive Caller ID information.

When a call is received, the display will show the name and number of the caller, and the date and time the call is received. Some telephone companies send both the name and number of the

CALLER ID OPERATION

caller. Other telephone companies may only provide the number of the calling party.

Note 1: When the **VT 4121** is connected behind a PBX or key system, the caller ID features cannot be used.

3.1 Receiving a Name and Number Call

The display will show the caller ID information typically after the first ring:

```
L1: 1235215
ABC CO.
```

Where: **L1** is the ringing line number
1235215 is the number of the caller
ABC CO. is the name of the caller

Note: The display will return to the idle mode when:

- The caller hangs up and ringing stops.
- An extension telephone answers the call.
- You answer the call and hang up.
- You perform another telephone function.

3.2 Receiving Multiple Calls

If two or more lines are ringing, the telephone will show the caller ID information for the line that began ringing first. Press **CID** to view the caller ID information for the next ringing line. You can continue to press the button to view

caller ID information for subsequent ringing lines. Once you have received the information for all the ringing lines, press **CID** again and the display will return to the date and time mode.

The display will first show the caller ID information for Line 1:

```
L1: 1235215
ABC CO.
```

1. Press **CID** to review the information for Line 2:

```
L2: 3235555
JANE DOE
```

2. Press **CID** to return to the time/date display if no other lines are ringing.
3. Press **CID** to review the information for Line 1 again:

```
L1: 1235215
ABC CO.
```

3.3 Receiving a Number Only Call

The display will show:

```
L1: 1235215
```

3.4 Receiving a Blocked Call

Sometimes a caller will prevent their number from being displayed on your telephone:

```
L1: Private
```

CALLER ID OPERATION

3.5 Receiving a Call from Outside the Calling Area

If a caller is outside of your Caller ID area:

```
L1: Out of Area
```

4. Reviewing Calls in the Caller List

Information for a maximum of ninety-nine (99) calls will be maintained. If more than 99 calls are received, the newest call will replace the oldest call in the list.

1. Press **◀◀** or **▶▶**. The display will show the total Caller ID record number and new call number.

```
TOTAL CALLS: 20  
NEW CALLS: 05
```

- 2a. Press **▶▶** to display the information of the first call record.
- 2b. Press **◀◀** to display the information of the last call record.
- 3a. Press **▶▶** to display the information of the second call record.
- 3b. Press **◀◀** to display the information of the first call record again.
- 4a. Press **▶▶** to repeatedly to scroll through the list forward.
- 4b. Press **◀◀** to repeatedly to scroll through the list backwards.

Note: The call records will be displayed in the following format:

```
RR/L: (NUMBER)  
(NAME)
```

```
RR/L: (NUMBER)  
(DATE & TIME)
```

Where:

- | | |
|---------------|---|
| RR | -Index no. of the call list (01-99) |
| L | -Telephone line number associated with call (1-4) |
| (NUMBER) | -Phone number |
| (NAME) | -Caller's name |
| (DATE & TIME) | -Date and time call record was received |
| NEW | -NEW call record or not (no label) |

EXAMPLE:

```
20/1:2018913417  
JOHN PRICE
```

Press # to view date and time display:

```
20/1:2018913417  
FEB26 10:01 NEW
```

5. Press **END** to exit the review mode and return to the time/date display.

5. Delete an Individual Record from the List

You can delete individual call records from the list by pressing **ERASE** while reviewing a record in the list.

CALLER ID OPERATION

6. Delete the Entire Caller ID List

You can delete the entire Caller ID List by pressing **ERASE** while viewing the total calls/new calls display.

7. Dialing a number from the Caller ID List

You can dial a number from the Caller ID list while in the review mode.

1. Select a Line Key (L1-L4);
2. Dial any required prefix (1);
3. Press **DIAL**;
4. The display shows the number digit by digit as it is dialed.

8. Saving a Number to a Speed Dial Key

You may save a number from the Caller ID List to a Speed Dial Key while in review mode:

1. Enter the programming mode by pressing **PROGRAM**. The display shows:

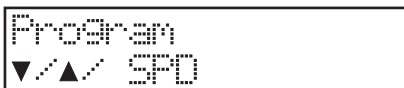

2. Select an available Speed Dial Key
3. Press **MUTE (ENTER)** to store the Caller ID Number on the Speed Dial Key.
4. Press **CID** to review calls in caller ID memory.
5. Press **MUTE (ENTER)** to confirm the storing.

AUX DATA PORT

The Speakerphone is equipped with an auxiliary data port on the back panel as shown:

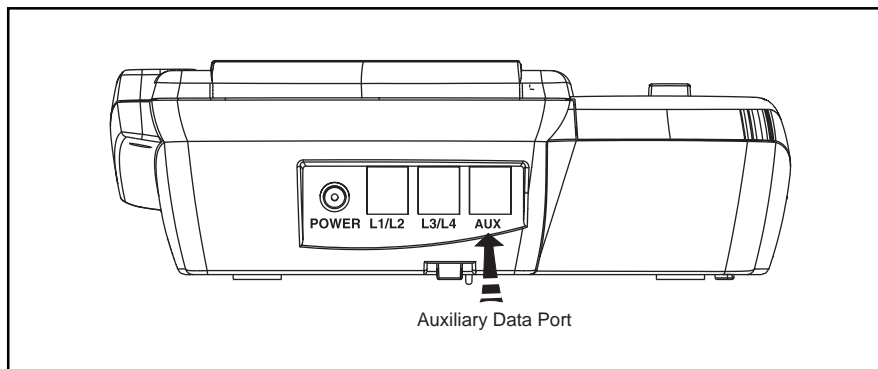

The auxiliary data port can be used to connect any standard single line device to line 4 for basic line service. This is particularly useful for notebook PC modem connections, as well as fax machines or other single line telephone devices.

MAINTENANCE

TAKING CARE OF YOUR TELEPHONE.

Your **VT4121** contains sophisticated electronic parts, so it must be treated with care.

Avoid rough treatment

Place the handset down gently. Save the original packing materials to protect your telephone if you ever need to ship it.

Avoid water

Your telephone can be damaged if it gets wet. Do not handle your speakerphone with wet hands. Do not install it near a sink, bathtub or shower.

Electrical storms

Electrical storms can sometimes cause power surges harmful to electronic equipment.

For your own safety, use caution when using electric appliances during storms.

WARRANTY STATEMENT

WHAT DOES OUR WARRANTY COVER?

- Any defect in material or workmanship.

FOR HOW LONG AFTER THE ORIGINAL PURCHASE?

- To the original purchaser only - ONE YEAR.

WHAT WILL VTECH DO?

- At our option, repair or replace your unit.

HOW DO I SEND MY UNIT, IN OR OUT OF WARRANTY?

- In the U.S. Call VTECH Communications customer service for Return Authorization at: **1-800-595-9511**
- Properly pack your unit. Include any cables & accessories which were originally provided with the product. We recommend using the original carton and packing materials.
- Include in the package a copy of the sales receipt or other evidence of date of original purchase (if the unit was purchased within the last twelve months).
- Print your name and address, along with a description of the defect, and include this in the package Or Vtech Electronics.
- Include payment for any service or repair not covered by warranty, as determined by VTECH Communications.
- Ship the unit via UPS Insured, or equivalent to:
- In the U.S.

VTECH COMMUNICATIONS

11035 SW 11th Street
Bldg. B Suite 270
Beaverton, OR 97005

VTECH Communications assumes no responsibility for units sent without prior Return Authorization.

TECHNICAL SPECIFICATIONS

VT 4121 Speakerphone

Physical:	Modular, Desk/Wall Mounted, High/Low Angle Stand	Function Buttons: ◀◀, C I D, ▶▶, E n d, ERASE, Do Not Disturb, Dial, Page, Page All, CO Lines 1/2/3/4*, Intercom*, Mute(Enter)*, Program, Volume, Conference, Flash, Redial(Pause), Speaker*, Hold, 18 Speed Dial Buttons
Power:	Class 2 Transformer	
Input:	120VAC, 60Hz, 7W	
Output:	12VDC, 400MA (milliamps)	(*) denotes button with LED
Electrical:	4 CO/PBX Lines, 2 Wire, Loop Start, 600 Ohms, 24/48VDC	Dial Keys: 12 Keys, Continuous DTMF
Ringer Equivalence:	0.3B	Dimensions: 237 mm long 212 mm wide 93.5 mm high
Mechanical:	2 Each RJ-14C Jacks Line 4 Auxiliary Jack 2.5mm Headset Jack Power Jack 12 VDC	Weight: 35.1 ounces (0.994 kg)
LCD:	Wide Angle Super-Twist (STN) 2 x16 Alpha-Numeric	Specifications, features, and availability of optional accessories are all subject to change without prior notice.

VT 4121

4-Line Speakerphone

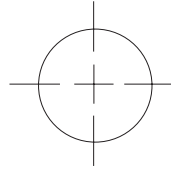

Wall Mounting Template

Use this template when wall mounting your base unit. To mark the positions of the mounting screws, hold this template against the wall, and press a pencil or pen point through the center of each crossmark.

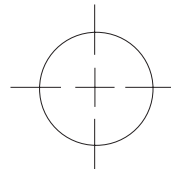

NOTE:

Select a spot where you can screw into a wooden stud within the wall. The mounting screws will not hold securely in plaster or wallboard alone.

TABLE OF CONTENTS

INTRODUCTION	1
Becoming familiar with your speakerphone	1
The display	2
The Features	2
Parts Check list	5
FCC REGULATIONS	6
IMPORTANT SAFETY INSTRUCTIONS	8
INSTALLATION	10
Site Planning	10
Installing the Speakerphone	10
Desk/Tabletop Mounting	10
Wall Mounting	11
PROGRAMMING	13
General Programming Guidelines	13
Extension Number	13
Tone/Pulse Dialing	13
Date and Time	14
CO/PBX Line Ringing	14
CO Line Ring Tone	15
Delayed Ringing	15
CO Trunk Connection	15
Automatic Line Selection	16
Call Forward	16
Auto Mute Enable/Disable	17
Flash	17
Speed Dial	17
Storing a Telephone Number in Speed Dial	17
Storing a Caller ID Number	18
Erasing the Contents of a Speed Dial Bin	18
Line In Use Detection	18
Reset default Values	18
BASIC OPERATION	20
Lamp (LED) Operation	20
Line-In-Use Indication	21
Adjusting the Handset Volume Level	21
Adjusting the Speaker Volume Level	21
Adjusting the Headset Volume Level	21
Adjusting the Ringer Volume Level	21
AC Power Failure Indication	21

TABLE OF CONTENTS

Making an Outside Call	21
Using the Handset	22
Using the Speakerphone/Headset	22
Answering an Outside Call	22
Using the Handset	22
Using the Speakerphone	22
Placing a Call on Hold	22
Retrieving a Call on Hold	23
Making an Intercom Call	23
Using the Handset	23
Using the Speakerphone	23
Using the Direct Station Buttons	24
Answering an Intercom Call	24
Using the Handset	24
Using the Speakerphone/Headset	24
Intercom Call Pick Up	24
Transferring a Call	24
Receiving a Transferred Call	25
Muting a Call	25
Conferencing	25
Two (2) Outside Lines	25
One (1) Outside Line and Two (2) Extensions	25
Paging	26
Paging Another Executive Speakerphone	26
Answering a Page	26
Changing Signaling Modes	26
To Voice Page All Speakerphone Extensions	26
Receiving a Voice Page to All Speakerphone Extension	27
Meet Me Answer to All Page	27
Do Not Disturb	27
Using the Flash Button	27
Using the Pause Feature	27
Auto Busy Redial	27
Last Number Redial	28
Speed Dialing	28
Call Privacy	28
Pulse-to-Tone Switching	28
Message Waiting Light	29
CALLER ID OPERATION	30
Caller ID Buttons	30
Programming the Area Code	30
To Program the Area Code	30
To Erase the Programmed Area Code	30

TABLE OF CONTENTS

Receiving a Call	30
Receiving a Name and Number Call	31
Receiving Multiple Calls	31
Receiving a Number Only Call	31
Receiving a Blocked Call	31
Receiving a Call from Outside the Calling Area	32
Reviewing Calls in the Caller List	32
Delete an Individual Record from the List	32
Delete the Entire Caller ID List	32
Dialing a number form the Caller ID List	32
Saving a Number to a Speed Dial Key	33
AUX DATA PORT	34
MAINTENANCE	35
WARRANTY STATEMENT	36
TECHNICAL SPECFCATIONS	37
WALL MOUNTING TEMPLATE	38

vtech

VTECH COMMUNICATIONS LTD.



Is a trademark of VTECH COMMUNICATIONS LTD., a member of THE VTECH GROUP OF COMPANIES.

Distributed in the U.S.A. by VTECH Communications, Beaverton, OR, 97008.

Copyright 1999 for VTECH COMMUNICATIONS LTD..

ISSUE 0

Free Manuals Download Website

<http://myh66.com>

<http://usermanuals.us>

<http://www.somanuals.com>

<http://www.4manuals.cc>

<http://www.manual-lib.com>

<http://www.404manual.com>

<http://www.luxmanual.com>

<http://aubethermostatmanual.com>

Golf course search by state

<http://golfingnear.com>

Email search by domain

<http://emailbydomain.com>

Auto manuals search

<http://auto.somanuals.com>

TV manuals search

<http://tv.somanuals.com>