

Table of Contents

GETTING STARTED	3
Before You Begin	3
Parts Checklist	3
Installation	4
Choose Location	4
Install Handset Battery	4
Table/Desk Installation	5
Wall Mounting	6
Charge the Handset Battery	7
Set Language	7
Check for Dial Tone	7
Set the Dial Mode	7
Set Handset Date and Time	7
Handset Ringer Style/Battery Save	8
If you subscribe to DSL service	8
BASIC OPERATION	9
Telephone Operation	9
Handset Operation	9
Base Operation	10
Temporary Tone Dialing	11
Operating Range	11
Display Screen Messages	12
Speed Dialing	13
Store a Number/Name in Speed Dial	13
Edit a Number/Name in Speed Dial	15
Delete a Number/Name in Speed Dial	15
Dial a Speed Dial Number	15
Reassign Locations in Speed Dial	15
Telephone Directory	16
Store a Number/Name in the Directory	16
Edit a Number/Name in the Directory	17
Delete a Number/Name in the Directory	17
Dial a Number from the Directory	18
Move a Number/Name to the Memory	18
Caller ID Operation	19
About Call History (Caller ID)	20
Review Call History	20
Delete Records from Call History	20

Dial a Displayed Number21
Store a Call History Record in the Directory21
Answering System Operation At The Base22
Audible Indicators22
Setting the Clock22
About Announcements22
Record Your Announcement24
To review your announcement at any time:24
To delete your announcement:24
Setting Up Your Answering System24
Feature Summary25
Listen to & Delete Messages26
Call Screening/Intercept28
Record a Memo28
Message Window Display29
Answering System—Remote Access Commands30
Remote access30
Remote access Commands30
Batteries32
Battery Care and Maintenance32
Replacing the Handset Battery32
ADDITIONAL INFORMATION33
Troubleshooting33
If you subscribe to DSL service39
Maintenance40
Limited Warranty40
Important Safety Instructions42
FCC, ACTA and IC Regulations43
The RBRC® Seal44
Technical Specifications45
INDEX46

NEED HELP?

This book has all the feature operation and troubleshooting you need to install and operate your new VTech phone. Please take the time to review thoroughly to ensure proper installation and the benefit of this VTech innovative and feature rich product. You can also visit our website at www.vtechphones.com for support, shopping, and everything new at VTech.

In Canada, please visit www.vtechcanada.com

VTech toll free 1-800-595-9511
In Canada dial 1-800-267-7377

Before You Begin

Parts Checklist

1. Charger Power Adapter
2. Handsets (2)
3. Base Unit
4. Charger
5. Telephone Line Cord
6. Batteries (2)
7. AC Power Adapter
8. User's Manual

To purchase replacement batteries, visit us on the web at www.vtechphones.com or call VTech Communications, Inc. at 1-800-595-9511. In Canada, call VTech Telecommunications Canada Ltd. at 1-800-267-7377.



HANDSET x 2

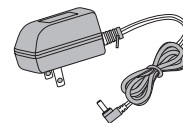

BASE UNIT

CHARGER
POWER ADAPTER

CHARGER

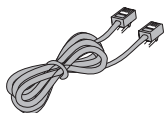
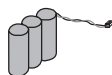
TELEPHONE
LINE CORD

BATTERY x 2

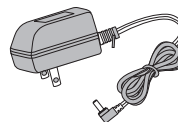

AC POWER ADAPTOR

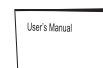

USER'S MANUAL

note

- Important! Before using this telephone, you must read the important safety instructions on page 42.

note

- Use only the provided VTech battery, or equivalent.

Installation

Choose Location

For maximum performance of your cordless telephone system:

1. Choose a central location for your Base Unit.
2. Install your base unit and extension handsets away from electronic equipment, such as personal computers, television sets and microwave ovens.
3. In locations where there are multiple cordless telephones, separate base units as much as possible.
4. Install your telephone equipment away from heat sources and sunlight.
5. Avoid excessive moisture, dust or extreme cold.

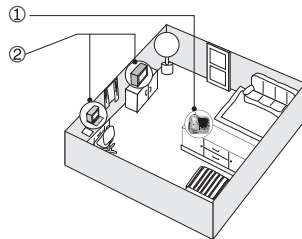

Install Handset Battery

- a) Align the two holes in the plug with the socket pins, then snap the plug into place.
- b) Place the battery in the compartment with the wires in the lower right corner. Angle the top of the battery under the top claws first, then snap the bottom of the pack in. Place the wires under the guide, located below the battery.
- c) Replace cover by sliding it up into place.
- d) Place the handset in its base when not in use to ensure maximum daily performance.

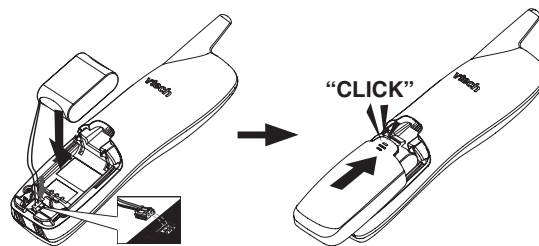

Installation

Table/Desk Installation

Connect the power cord. After charging the battery for at least 16 hours, connect the telephone line cord.

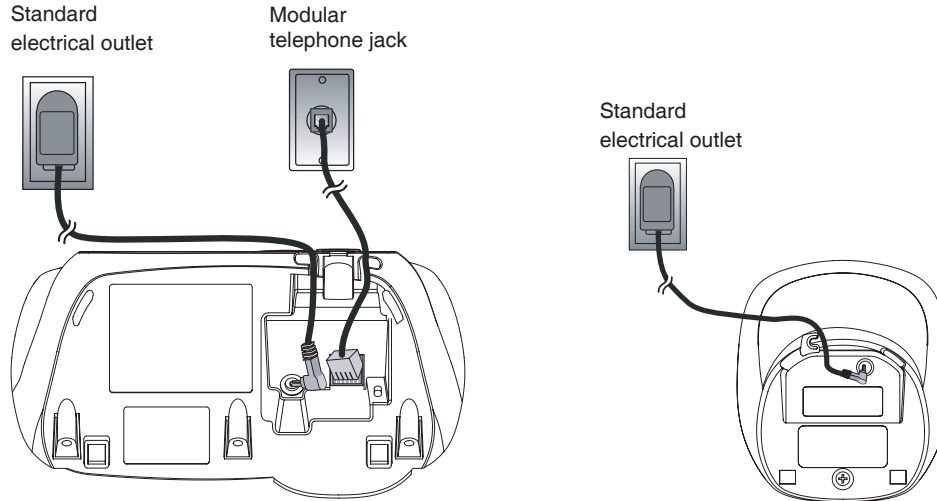

note

- Install the base unit away from electronic equipment such as personal computers, television sets or microwave ovens. Avoid excessive heat, cold, dust or moisture.
- This power unit is intended to be correctly orientated in a vertical or floor mount position. The prongs are not designed to hold the plug in place if it is plugged into a ceiling or an under the table/cabinet outlet.

Installation

Wall Mounting

Your phone base unit is designed to mount on a standard telephone wall plate. Wall mounting is optional.

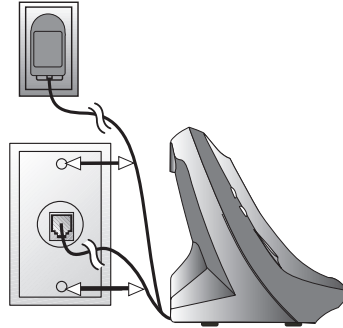

1. Run the power and telephone cords through the slot, then connect them to the jacks located on the underside of the base.
2. Plug the AC adapter into an electrical outlet. If the battery has not been previously charged, place the handset in the base, and allow it to charge for at least 16 hours (or overnight). Connect the telephone line cord to the wall jack.
3. Mount the base on the wall. Position the base unit so the mounting studs will fit into the holes on the wall mount bracket. Slide the base unit down on the mounting studs until it locks into place.

Installation

Charge the Handset Battery

Place the handset in the base. **CHARGING...** will display. Be sure to charge the battery for at least 16 hours before using your phone.

Set Language Mode

- Press **PROG**, then press ▼ or ▲ until **LANGUAGE** is displayed. Press **SELECT**.
- The current setting blinks. Press ▼ or ▲ until the screen displays the correct language.
- Press **SELECT** to save your selection.

Check for Dial Tone

After the batteries are charged, pick up the handset and press **TALK**; you should hear a dial tone. If you do not, try this phone in another phone jack.

Set the Dial Mode

If you have touch tone service, the phone is ready to use as soon as the battery is charged. If you have pulse (rotary) service, you'll need to change the dial mode.

- Press **PROG**.
- Press ▼ or ▲ until the screen displays **DIAL MODE**: and the current setting.
- Press **SELECT**. The current setting blinks.
- Press ▼ or ▲ to select **TONE** or **PULSE**.
- Press **SELECT** to save.

Set Handset Date and Time

If you subscribe to caller ID service, the date and time will be set automatically with the first incoming call. If you do not have caller ID service, you can set the date and time manually:

- Press **PROG**, then press ▼ or ▲ until **DATE/TIME** is displayed. Press **SELECT**.
- The month is flashing. Press ▼ or ▲ until the screen displays the correct month. Press **SELECT**.
- The day is flashing. Press ▼ or ▲ until the screen displays the correct day. Press **SELECT**.
- The hour is flashing. Press ▼ or ▲ until the screen displays the correct hour. Press **SELECT**.

note

- If the phone will not be used for a long period of time, remove the battery to prevent possible leakage.
- If you have any trouble installing your phone, please refer to the **Troubleshooting** section near the end of this manual.

note

- In the event of a power outage, or if your phone's power cord is unplugged, the time setting will be lost.

Installation

- The minute is flashing. Press ▼ or ▲ until the screen displays the correct minute. Press **SELECT**.
- **AM** or **PM** is flashing. Press ▼ or ▲ to choose between **AM** or **PM**. Press **SELECT**

Handset Ringer Style/Battery Save

You can select from four different handset ringer styles, or turn the ringer off and extend the battery life.

- With the handset in idle (off) mode, press **PROG**.
- Press ▼ or ▲ until the screen displays **RINGER:** and the current setting.
- Press **SELECT**. The current setting blinks, and you will hear a sample of the ring.
- Press ▼ or ▲ to select **RINGER: 1, 2, 3, 4 or OFF**. You will hear a sample of each ring tone.
- Press **SELECT**.

If you subscribe to DSL service:

If you hear noise during conversations and/or your caller ID features aren't functioning properly, install a noise filter to the telephone line between the base unit and the telephone line jack. Contact your DSL provider to obtain a noise filter.

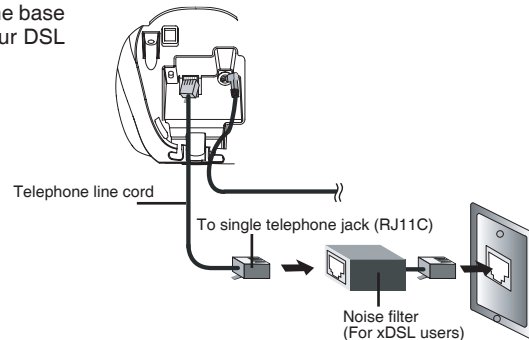

Telephone Operation

Handset Operation

1. Make a Call

Press before or after dialing number to place a call.

2. Flash/Call Waiting

Press to begin a call, then dial a number. During a call, press to receive an incoming call, if call waiting is activated.

3. Chan

While on a call, press **CHAN** to switch to a clearer channel.

4. Delete

Press to delete one or all calls in the call log. See page 20 for complete instructions.

5. Answer a Call (any key)

Press any key (except **OFF**) to answer a call.

6. Handset Volume

Adjust the volume while on a call. A double beep will sound when you reach the maximum or minimum setting.

CID and DIR keys

- When phone is not in use, press ▼/CID to display caller ID information.
- When phone is not in use, press ▲/DIR to display directory entries.

7. Select

Press to confirm the highlighted option while in programming mode.

8. Off

During a call, press to hang up. While in programming mode, press to cancel an operation, back up, or exit.

9. Redial/Pause

Press to view redial memory. While entering numbers, press and hold to insert a dialing pause.

10. PROG

Press to enter programming mode.

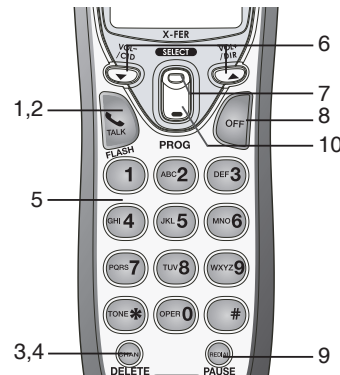

Telephone Operation

Base Operation

1. Locate Handset
2. Answer on/off
3. Delete
4. Microphone
5. Repeat
6. Play/Stop
7. Skip
8. Menu
9. Rec/Memo
10. Time/Set
11. Change
12. Base Volume
13. Message Window Display

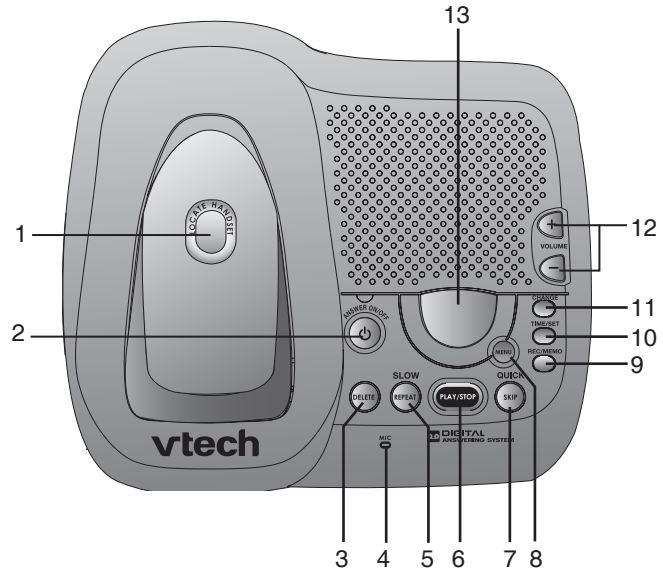

Telephone Operation

Operating Range

This cordless telephone operates within the maximum power allowed by the Federal Communications Commission (FCC) Even so, this handset and base can communicate over only a certain distance — which can vary with the locations of the base and handset, the weather, and the construction of your home or office.

If you receive a call while you are out of range, the handset might not ring or if it does ring, the call might not connect when you press **TALK**. Move closer to the base, then press **TALK** to answer the call.

If you move out of range during a phone conversation, you might hear noise or interference To improve reception, move closer to the base.

If you move out of range without pressing **OFF**, your phone will be left off the hook To hang up properly, walk back into range, periodically pressing **OFF**.

Temporary Tone Dialing

If you have pulse (rotary) service, you can change from pulse dialing to touch tone dialing during a call by pressing * **TONE** This is useful if you need to send touch tone signals for access to telephone banking or long distance services

1. Dial the number.
2. Press * **TONE**. Buttons pressed after this send touch tone signals.
3. After you hang up, the phone automatically returns to pulse service.

Call Forward

An external call can be forwarded from one handset (HS1) to the other handset (HS2)

1. While on a call, press **SELECT** on HS1 to forward the call to HS2 HS1 will display: **CALL TRANSFERRED**. HS2 will ring and show: **TRANSFERRED CALL**.
2. Press any key except **OFF** on HS2 to answer the forwarded call HS1 will return to the idle screen.

note

- Only one handset of your phone system can be in use (off hook) at a time For example, if HS1 is on a call and HS2 presses **TALK**, **CAN'T CONNECT** will display.
- For clearer reception while on a call, press the **CHAN** button until the interference has been eliminated.
- If HS2 cannot be found, HS1 will generate a sad tone and continue the call automatically. After HS2 answers, HS1 can press **TALK** to cancel the forward function and continue the external call.
- If HS2 does not respond within 30 seconds, HS1 will start ringing until you press **TALK** to pick up the returned call If the returned call is not answered within another 30 seconds, the external call will end automatically.

Telephone Operation

Display Screen Messages

Screen Displays:	When:
** RINGING **	There is a call coming in.
CONNECTING...	The handset is waiting for dial tone.
PHONE ON	The handset is in use.
CHARGING	The handset is in the base and the battery is charging.
** PAGING **	The base is paging the handset.
BATTERY LOW	The battery needs to be recharged.
SCANNING...	The handset is changing to another of the 30 channels available.
CAN'T CONNECT	Displays and a sad tone sounds when the base power is off and TALK is pressed.
RINGER OFF	The handset ringer is turned off.

Speed Dialing

You can store telephone numbers you call frequently in two different ways, as speed dial numbers, or in the directory. Each number can have up to 24 digits. You will program names to go with the numbers, each can have up to 15 characters.

Up to ten numbers and names can be stored, total. You can store as many as nine numbers with names into speed dial memory locations you assign (1 through 9). You can also store numbers with names alphabetically in the directory. See Telephone Directory for instructions.

Store a Number/Name in Speed Dial

1. Press **PROG** on the handset.
2. Press **▲** or **▼** until the screen displays **SPEED DIAL**.
3. Press **SELECT** The screen displays **ENTER 1-9**.
4. Press the key (1 through 9) for the memory location where you want to store this entry. The screen displays **ENTER NAME**.
5. Using the chart on the next page, enter up to 15 characters for the name you're storing with the number. Use **▼** to backspace and make corrections; use **▲** to advance and add a space.
6. When you finish entering the name, press **SELECT**. The screen displays **ENTER NUMBER**.
7. Enter the telephone number using the number keys. Use **▼** to backspace and make corrections. After at least one digit has been entered, press **REDIAL/PAUSE** to store pauses in the dialing sequence, if necessary. Press **REDIAL/PAUSE** to display the last number dialed.
8. Press **SELECT** to store your entry. The screen displays **DISTINCT RING?** and the current setting.
9. Press **▼** or **▲** to change the setting. Choose **Y** (for yes) if you wish the phone to alert you to calls from this number by changing to a distinctive ringing pattern after the first ring. Choose **N** for a normal ringing pattern.
10. Press **SELECT** to confirm your selection. If you chose **Y**, a **D** will be displayed with the directory entry.

note

- The entries you stored in speed dial memory will be marked with 01 through 09 in the telephone directory.
- Each handset's speed dial entries are independent from the other. For example, a speed dial entry stored in HS1 cannot be accessed/dialed by HS2.
- Press **OFF** at any time to exit memory mode.

note

- When directory memory is full the screen displays **MEMORY FULL**, an error tone sounds, and you cannot store a new number until you delete a record in speed dial memory or the directory.
- If the speed dial location is not empty, your new entry will be stored in place of the old and the first entry will be deleted. Take caution to not save over entries you do not wish to delete from memory.

Speed Dialing

Press	Once	Twice	3 Times	4 Times	5 Times	6 Times
1	1					
2	A	B	C	2		
3	D	E	F	3		
4	G	H	I	4		
5	J	K	L	5		
6	M	N	O	6		
7	P	Q	R	S	7	
8	T	U	V	8		
9	W	X	Y	Z	9	
0	0					
*	*					
#	&	'	,	-	.	#

Speed Dialing

Edit a Number/Name in Speed Dial

1. Press and hold the memory location key (1 through 9) of the entry you wish to edit.
2. When the screen displays the entry you want to edit, press **SELECT**. Then press ▼ or ▲ until **EDIT** flashes.
3. Press **SELECT**. The screen displays the name and number. The cursor appears at the end of the name.
4. Use ▼, ▲ and the dial pad keys to edit the name. Press **SELECT** to move on to edit the number. Use ▼ to backspace and make corrections. Press **SELECT** to move to edit the distinctive ring setting.
5. Press ▼ or ▲ to change the setting. Press **SELECT** to save.



```
SPEED EDIT ERASE
8005939511
01
```

Delete a Number/Name in Speed Dial

1. Press and hold the memory location key (1 through 9) of the entry you wish to delete.
2. When the screen displays the entry you want to delete, press **SELECT**. Then press ▼ or ▲ until **ERASE** flashes.
3. Press **SELECT**, the screen displays:
4. Press ▼ or ▲ until **YES** flashes.
5. Press **SELECT**. You'll hear a confirmation beep.

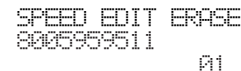

```
SPEED EDIT ERASE
8005939511
01
```

Dial a Speed Dial Number

- Press and hold the memory location key (1 through 9) of the entry you wish to dial.
- Press **TALK** to dial the displayed memory number.

Reassign Locations in Speed Dial

1. Press and hold the memory location key (1 through 9) of the entry you wish to reassign.
2. When the screen displays the entry you want to reassign, press **SELECT**. Then press ▲ until **SPEED** flashes.
3. Press **SELECT**. The screen displays **ENTER 1-9**.
4. Press the keys (1 through 9) to reassign this entry into another memory location.

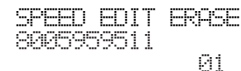

```
SPEED EDIT ERASE
8005939511
01
```

note

- Press **REDIAL/PAUSE** to display the last number dialed from this phone to store it in speed dial memory.
- Each handset's speed dial entries are independent from the other. For example, a speed dial entry stored in HS1 cannot be accessed/dialed by HS2.

Telephone Directory

Your phone can store 10 (including the nine speed dial entries) numbers with names (up to 15 characters for the name and 24 digits for the number) in each handset. When memory is full the screen displays **MEMORY FULL**, an error tone sounds, and you will not be able to store a new number until you delete a stored number.

Store a Number/Name in the Directory

1. Press **PROG**. The screen displays **DIRECTORY**.
2. Press **SELECT**. The screen displays **ENTER NAME**.
3. Using the chart on page 14, enter up to 15 characters for the name you're storing with the number. Use **▲** to backspace and make corrections; use **▼** or **▲** to advance and add a space.
4. When you finish entering the name, press **SELECT**. The screen displays **ENTER NUMBER**.
5. Enter the telephone number. Use **▼** to backspace and make corrections. Press **REDIAL/PAUSE** to store a pause in the dialing sequence.
-OR-
Press **REDIAL/PAUSE** if you wish to display and then store the last number dialed.
6. Press **SELECT**. The screen displays **DISTINCT RING?** and the current setting.
7. Press **▼** or **▲** to change the setting. Choose **Y** (for yes) if you wish the phone to alert you to calls from this number by changing to a distinctive ringing pattern after the first ring. Choose **N** for a normal ringing pattern.
8. Press **SELECT** to confirm your selection. If you chose **Y**, a **D** will be displayed with the directory entry.

Telephone Directory

Edit a Number/Name in the Directory

1. Press **▲ (DIR)**. The screen displays **DIRECTORY**.
2. Press **▼** or **▲** to scroll alphabetically through the entries stored in the directory.

-OR-

Press the dial pad key for the first letter of the entry you want to edit.

3. When the screen displays the entry you want to edit, press **SELECT**. Then press **▼** or **▲** until **EDIT** flashes.
4. Press **SELECT**. The screen displays the name and number. The cursor appears at the end of the name. Use **▼**, **▲** and the dial pad keys to edit the name.
5. Press **SELECT** to move on to edit the number. Use **▼** to back space and make corrections.
6. Press **SELECT** to move on to edit the distinctive ring setting. Use the **▼** and **▲** to change the setting.
7. Press **SELECT** to save the edited information.



```
SPEED EDIT ERASE
8005999511
```

Delete a Number/Name in the Directory

1. Press **▲ (DIR)**. The screen displays **DIRECTORY**.
2. Press **▼** or **▲** to scroll alphabetically through entries in the directory.

-OR-

Press the dial pad key for the first letter of the entry you want to delete.

3. When the screen displays the entry you want to delete, press **SELECT**. Then press **▼** or **▲** until **ERASE** flashes.
4. Press **SELECT**. The screen displays **ERASE NO YES** and the number. The current choice flashes.
5. Press **▼** or **▲** until **YES** flashes.
6. Press **SELECT**. You'll hear a confirmation beep.



```
SPEED EDIT ERASE
8005999511
```

note

- Press **OFF** at any time to exit directory.

note

- Press **OFF** at any time to exit directory.

Telephone Directory

Dial a Number from the Directory

1. Press **▲ (DIR)**. The screen displays **DIRECTORY**.
2. Press **▼** or **▲** to scroll alphabetically through entries stored in directory.
-OR-
Press the dial pad key for the first letter of the entry you want to dial.
3. When the number you want to dial is displayed, press **TALK**.

Move a Number/Name to the Memory

1. Press **▲ (DIR)**. The screen displays **DIRECTORY**.
2. Press **▼** or **▲** to scroll alphabetically through directory.
-OR-
Press the dial pad key for the first letter of the entry you want to move.
3. When the screen displays the entry you want to move, press **SELECT**. Then press **▼** or **▲** until **SPEED** flashes.
4. Press **SELECT**. The screen displays **ENTER 1-9**.
5. Press the key (1 through 9) to move this entry from the normal directory to the speed dial memory and assign the memory location. You'll hear a confirmation beep. A memory location number (01 through 09) will be displayed with this entry.

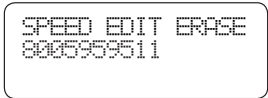

```
SPEED EDIT ERASE
0005959511
```

Caller ID Operation

Your phone has a caller ID (CID) with call waiting feature that works with service from your local phone service provider. Caller ID with call waiting lets you see who's calling before you answer the phone, even when you're on another call.

You may need to change your phone service to use this feature. Contact your service provider if:

- You have both caller ID and call waiting, but as separate services (you may need combined service)
- You have only caller ID service, or only call waiting service.
- You don't subscribe to any caller ID or call waiting services.

You can use this product with regular caller ID service, and you can use this product's other features without subscribing to either caller ID or combined caller ID with call waiting service.

There are fees for caller ID services, and they may not be available in all areas.

This product can provide information only if both you and the caller are in areas offering caller ID service, and if both telephone companies use compatible equipment.

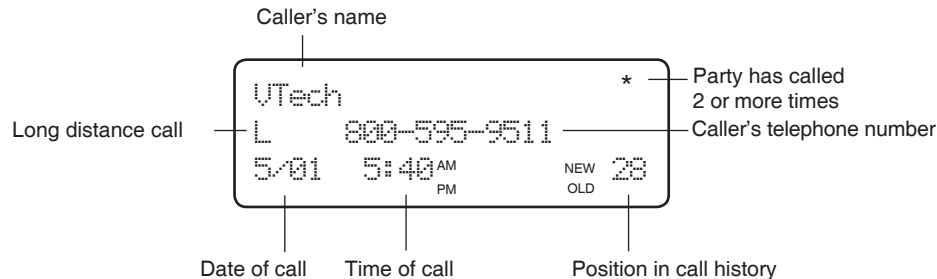

note

- If you answer a call before the caller ID information appears on the screen, it will not be in the call history.
- Each handset's call log is independent from the other handset. For example, when you delete one or all call log entries in one handset, they will not be deleted from the other handset.

Caller ID Operation

About Call History (Caller ID)

Your phone can store up to 30 calls in its caller ID memory. The most recent call will have the highest number. When the memory is full, the oldest call will be deleted to make room for new incoming call information. For each call that comes in, the screen displays the following information between the first and second rings:

- Your caller's name (15 letters are sent by your telephone company).
- The caller's area code and telephone number.
- The time and date of the call.
- The repeat tag (*) in the upper right corner, indicating the party has called more than once.

Review Call History

1. Press ▼ (CID) to view call history.
2. Use ▼ and ▲ to scroll through records in call history.

Delete Records from Call History

Delete a Specific Call:

1. Locate the record you want to delete from call history.
2. Press **DELETE**. You'll hear a confirmation beep.

Delete All Calls:

1. With the handset in idle (off) mode, press and hold **DELETE**. The screen displays **ERASE ALL NO YES**. The current choice flashes.
2. Press ▲ until **YES** flashes.
3. Press **SELECT**. You'll hear a confirmation beep.

Caller ID Operation

Dial a Displayed Number

1. Locate the record in call history that you want to dial.
2. If you wish to change how the number is dialed, press #. The screen displays alternate dialing sequences available for this call.
3. Press **SELECT**. Press ▼ or ▲ until **DIAL** flashes.
4. Press **SELECT** again. The number is automatically dialed.

-OR-

When the number is correctly displayed for dialing, press **TALK**.

```

595-9511
5/01 5:40PMOLD28
    
```

```

DIAL PROGRAM
800-595-9511
5/01 5:40PM OLD28
    
```

```

DIAL PROGRAM
800-595-9511
5/01 5:40PM OLD28
    
```

```

DISTINCT RING? N
800-595-9511
    
```

Store a Call History Record in the Directory

1. Locate the record in the call history you want to store in the directory.
2. If you wish to change how the number is stored, press #. The screen displays alternate dialing sequences available for this call.
3. Press **SELECT**, then press ▼ or ▲ until **PROGRAM** flashes.
4. Press **SELECT** three times. The screen displays:
5. Press ▼ or ▲ to select **Y** or **N** for distinctive ringer.
6. Press **SELECT**. You'll hear a confirmation beep. If you choose **Y** in step 5 a **D** will be displayed with the directory entry.

note

- Press **OFF** at any time to exit call history.

Basic Operation

Screen Displays:	When:
PRIVATE	The other party is blocking name and/or number information.
UNKNOWN	Your phone company is unable to receive information about this caller's name and/or number.
* (after name)	This caller has called you more than once.

note

- The time will be set automatically with incoming caller ID data.
- To advance the minutes or years by increments of 10, press and hold **CHANGE**.

Answering System Operation At The Base

Audible Indicators

Your phone system gives you voice prompts for feature operations and voice confirmations when you press a button or complete an operation.

Setting the Clock

If you do not subscribe to caller ID service (fee required), or simply wish to set the clock manually:

1. Press **TIME/SET**. The system announces the clock setting, then announces: ***“To set day and time, press TIME/SET.”***
2. Press **TIME/SET**.
3. Press **CHANGE** until the system announces the correct day, then press **TIME/SET**.
4. Press **CHANGE** until the system announces the correct hour, then press **TIME/SET**.
5. Press **CHANGE** until the system announces the correct minute, then press **TIME/SET**.
6. Press **CHANGE** until the system announces the correct year, then press **TIME/SET**. The system will announce the new setting.

About Announcements

- You can record two different announcements — one for normal answering and one for when you’ve set the system to play the announcement only.
- Use normal answering when you want the system to record callers’ messages. Use **Announce Only** when you want to give information to callers without accepting messages.
- If you choose not to record an announcement, the system answers with a pre-recorded announcement.
- The normal answering pre-recorded announcement says: ***“Hello. I’m unable to answer your call***

Answering System Operation At The Base

right now. Please leave your name, number and a message after the tone.” The announce only pre-recorded announcement says: *“Hello, I’m unable to answer your call right now. Please call again. Thank you.”*

- By setting announce only to on or off, you decide which announcement your callers will hear when the system answers a call (the system comes set for normal answering, with announce only turned off). See **Set Announce Only**, located in the **Feature Summary** chart later in this section, to change your announcement selection.

Record Your Announcement

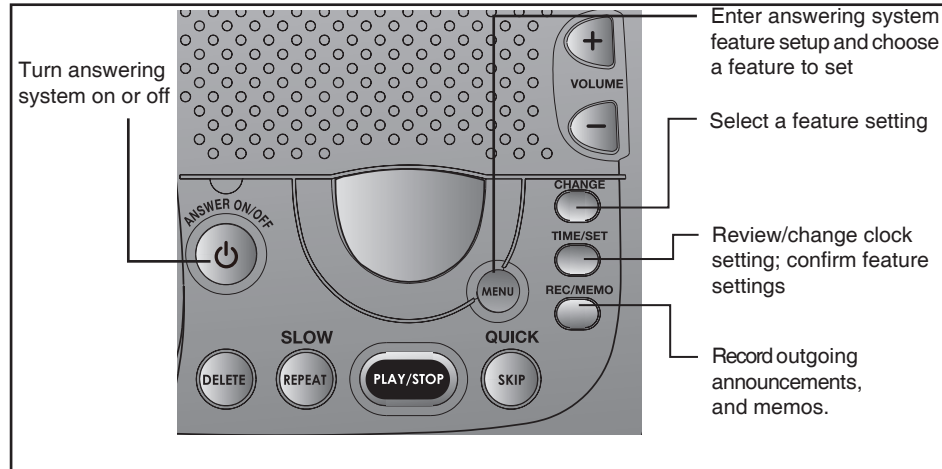

note

- Announcements less than three seconds will not be saved.

Answering System Operation At The Base

1. Press **MENU** until you hear "*Record outgoing message.*"
2. Press **REC/MEMO**. After you hear "*Now recording*" followed by a beep, speak toward the base to record an announcement up to 90 seconds long.
3. Press **PLAY/STOP**. The system plays back your recorded message.

To review your announcement at any time:

1. Press **MENU** until you hear "*Record outgoing message.*"
2. Press **PLAY/STOP**. The system plays the current announcement.

To delete your announcement:

Press **DELETE** during announcement playback. The system will use the pre-recorded announcement until you record a new one.

Setting Up Your Answering System

You can set up one feature at a time, or you can set up a feature and then move on to set up the other features in sequence.

1. Press **MENU** until the system announces the feature you want to set. Refer to the **Feature Summary** on the following page for a description of the features and your choices.
2. Press **CHANGE** until the system announces the desired setting.
3. Press **TIME/SET** to confirm your selection.
4. Press **MENU** to move on to the next feature, or press **PLAY/STOP** button to exit feature setup.

Feature Summary

Answering System Operation At The Base

System Announce	Description/Directions
<p>“Set security code” 19*</p>	<p>Use CHANGE to choose the remote access code you will use to access features and functions of the answering system from a touch tone phone. You can select any 2-digit code, from 10 to 99.</p>
<p>“Set audible message alert” Off * On</p>	<p>When message alert is turned on, the base beeps once every 10 seconds when new messages have been received.</p>
<p>“Set announce only” Off* On</p>	<p>When you turn announce only ON, callers hear your announcement, but cannot leave a message.</p>
<p>“Set base ringer” On* Off</p>	<p>Turn the base ringer on or off.</p>
<p>“Set number of rings” 2 4 * 6</p>	<p>Choose how many times the phone will ring before the system answers a call.</p>
<p>Toll Saver</p>	<p>With toll saver active, the system answers after two rings when you have new messages and after four when you have no new messages.</p>

Listen to & Delete Messages

note

- To advance the remote access code by 10, press and hold **SELECT**.
- Feature summary options listed with an * are your phones default setting.

note

If the system has less than 30 seconds of record time left, the answering system turns off. The system will answer after 10 rings and announce "**Memory full, please enter your security code**" and wait for the caller to enter the remote access code.

Answering System Operation At The Base

The system automatically saves your messages until you delete them, and can store approximately 15 minutes of messages, memos, and announcements (up to a maximum of 99 messages). A message or memo can be up to four minutes long.

The message window will flash to alert you to new, unplayed messages. If all messages have been reviewed, the number displayed in the window will glow steadily. If the system contains both old and new messages, it will play only the new messages first. After all new messages are played, press the **PLAY/STOP** to hear all messages.

Before playing a message, the system announces the day and time it was received. While the message plays, the message window displays the number of the message. After playing the last message in a mailbox, the system announces "**End of messages.**" If the system has less than five minutes of recording time left, it announces remaining time.

Answering System Operation At The Base

note

- You cannot delete a message until it's been reviewed: deleted messages cannot be recovered.

Message Window

Delete Messages

- To delete a message, press **DELETE** while the message is playing.
- Press and hold **DELETE** button to delete all old messages in that mailbox.
- You cannot delete a message until it's been reviewed; deleted messages cannot be recovered.

Adjust Playback Volume

System beeps three times at highest or lowest setting.

Press to skip to the next message; hold to speed up playback.

Play Messages
Press to play messages. Press again to stop playback.

Press to repeat a message; hold to slow down playback.

The diagram shows a control panel with a speaker grille at the top labeled "Message Window". Below the grille are several buttons: "ANSWER ON/OFF" (power icon), "DELETE", "REPEAT", "PLAY/STOP", "SKIP", "MENU", "CHANGE", "TIME/SET", and "REC/MEMO". A "VOLUME" control with "+" and "-" buttons is on the right. A "MIC" indicator is at the bottom left. The text "DIGITAL ANSWERING SYSTEM" is printed at the bottom center of the panel.

Basic Operation

Answering System Operation At The Base

Call Screening/Intercept

1. Make sure the answering system is on, and set the message playback volume control above level **1** so you can hear the caller's message.
2. If you decide to take the call, press **TALK** on the handset.
3. If you pick up an extension phone during the announcement and the announcement does not stop right away, press and release the telephone switchhook.

Record a Memo

You can record a memo up to four minutes long, which is stored as an incoming message.

1. Press and release **REC/MEMO**.
2. The system announces "***Now recording***". After the beep, speak toward the microphone. The message window displays the length of your memo up to 99 seconds, if you record a memo longer than 99 seconds, 99 continues to flash until you finish.
3. To stop recording, press the **PLAY/STOP**.

Answering System Operation At The Base

Message Window Display

Window Display:	When:
0	No messages in the mailbox.
1–99	Total number of messages in the mailboxes, or message number during message playback.
0-99 <-->F	Memory is full, or total number of messages is 99.
1 to 99 (counting)	Duration of announcement or memo in seconds. (Maximum length of announcement is 90 seconds)
99 (flashing)	Length of recording is more than 99 seconds.
1–8 (on steady for one second)	Indicates volume level selected when VOL- or VOL+ is pressed.
10–99	Current remote access code while setting.
A	Announce only mode.
CL <--> (normal display)	Clock needs to be set.
– (steady)	System is answering a call or is in remote operation.
– (flashing)	System is in programming mode or initializing.

Answering System–Remote Access Commands

Remote Access

You can access many features of this system remotely from a touch tone phone.

1. Dial your telephone number.
2. When the system answers, enter your remote access code (preset to 19). The system beeps once and then announces the number of new messages.
3. Enter a remote command (see **Remote Access Commands**).
4. Press * 0 to exit remote operation.

The system has voice prompts to help you with remote operation. Press #1 to hear your options while remotely connected to the answering system.

Remote Access Commands

Function:	Command:
Play messages in a mailbox	Press #2. The system will play new messages. If there are no new messages, the system plays old messages.
Repeat a message	Press #4 while message is playing; press #4#4 to back up previous message.
Skip a message	Press #6 while message is playing; each press advances to the next message.
Stop	Press #5.

Answering System–Remote Access Commands

Function:	Command:
Save messages	Hang up.
Delete a message	Press #9 while message is playing.
Review announcement	Press #7 ; system plays announcement, then beeps.
Record announcement	Press *7 ; after beep, record announcement, press #5 to stop. System plays back announcement.
Record memo	Press *8 , then mailbox number where you want the memo recorded; speak after beep; press #5 when finished.
End remote access call	Press *0 .
Turn system off	Press #0 ; the system announces, “Answering machine off.” Press #0 again to turn the system back on.
Turn system on	When system is off, it answers after 10 rings and announces, “Please enter your security code.” Enter your remote access code.

note

- If no key is pressed within 10 seconds of entering remote access, your remote access options will be announced. After the announcement if no key is pressed within 20 seconds, the remote access call will automatically end.

note

- If you repeatedly get a low battery indicator, even after charging overnight, the battery should be replaced.
- To reduce the risk of fire or injury to persons or damage to the telephone, charge the battery provided with or identified for use with this product only in accordance with the instructions and limitations specified in the user's manual.
- Battery power is consumed whenever the handset is off the base unit, even with the handset is not in use.
- Once the battery is fully charged, you do not have to charge it again until **BATTERY LOW** is displayed or  flashes. This will maximize the battery life.

Batteries

Battery Care and Maintenance

After your battery is fully charged, you can expect the following performance:

Operation	Operating time
While in use (talking)	up to 4 hours
While not in use (standby*)	up to 4 days

* Handset is off the base unit or charger but not in use.

- The battery needs charging when:
 - A new battery is installed in the handset.
 - The phone beeps twice every five seconds.
 - The screen displays **BATTERY LOW** and the low battery icon.
- Place the handset in the base. The battery is typically fully charged at least 16 hours.
- You can keep the battery fully charged by returning the handset to the base after each use.

Replacing the Handset Battery

1. Remove the battery compartment cover on the handset by pressing on the indentation and sliding the cover downward.
2. Lift out the old battery and disconnect.
3. Align the two holes in the new battery's plug with the socket pins, and snap the plug into place. Snap the battery in the compartment, as described in **Installation**, on page 4.
4. Replace the cover by sliding it up into place.
5. The new battery must be charged before using the phone. Place the handset in the base and allow it to charge for at least 16 hours the first charge. The telephone might operate before that, but for best performance, let the battery charge fully.

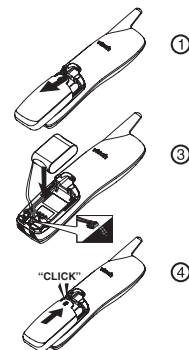

Troubleshooting

If you have difficulty operating your phone, the suggestions below should solve the problem. If you still have difficulty after trying these suggestions, call VTech Communications at 1-800-595-9511. In Canada, call VTech Telecommunications Canada Ltd. at 1-800-267-7377.

Problem	Suggestion
My phone doesn't work at all.	<ul style="list-style-type: none">• Make sure the power cord is plugged in.• Make sure the telephone line cord is plugged firmly into the base unit and the telephone wall jack.• Charge the battery in the handset for at least 16 hours. For optimum daily performance, return the handset to its base when not in use.• Reset the base. Unplug the unit's electrical power. Wait for 15 seconds then plug it back in. Allow up to one minute for the handset and base to reset.• You may need to purchase a new battery, please refer to the Batteries section of this user's manual.
I cannot get a dial tone.	<ul style="list-style-type: none">• First try all the suggestions above.• Move the handset closer to the base. You might have moved out of range.• Your line cord might be malfunctioning. Try installing a new line cord.• If the previous suggestions don't work, disconnect the base unit from the telephone jack and connect a different phone. If there is no dial tone on that phone either, the problem is in your wiring or local service. Contact your local telephone company.

Troubleshooting

Problem	Suggestion
I cannot dial out.	<ul style="list-style-type: none">• Make sure you have a dial tone before dialing. The handset may take a second or two to find the base and produce a dial tone. This is normal. Wait an extra second before dialing.• Make sure your phone is set to the correct dial mode for the type of service that you have (pulse or touchtone). Refer to the Installation section of this user's manual to set the dial mode.• If the other phones in your home are having the issue, the problem is in your wiring or local service. Contact your local telephone company (charges may apply.)• Eliminate any background noise. Noise from a television, radio or other appliance may cause the phone to not dial out properly. If you cannot eliminate the background noise, first try muting the handset before dialing, or dialing from another room in your home with less background noise.
My handset beeps four times and isn't performing normally.	<ul style="list-style-type: none">• Make sure the power cord is securely plugged into the base. Plug the unit into a different, working outlet not controlled by a wall switch.• Move the handset closer to the base. You might have moved out of range.• Reset the base. Unplug the unit's electrical power. Wait for 15 seconds then plug it back in. Allow up to one minute for the handset and base to reset.• Other electronic products can cause interference with your cordless phone. Try installing your phone as far away from these types of electronic devices as possible: wireless routers, radios, radio towers, pager towers, cell phones, intercoms, room monitors, televisions, personal computers, kitchen appliances and other cordless phones.

Troubleshooting

Problem	Suggestion
<p>CAN'T CONNECT displays on my handset.</p>	<ul style="list-style-type: none"> • Only one handset of your phone system can be in use (off hook) at a time. For example, if HS1 is on a call and HS2 presses TALK, CAN'T CONNECT will display. Be sure only one handset is in use at a time. • Move the handset closer to the base. You might have moved out of range. • Reset the base. Unplug the unit's electrical power. Wait for 15 seconds then plug it back in. Allow up to one minute for the handset and base to reset. • Other electronic products can cause interference with your cordless phone. Try installing your phone as far away from these types of electronic devices as possible: wireless routers, radios, radio towers, pager towers, cell phones, intercoms, room monitors, televisions, personal computers, kitchen appliances and other cordless phones. • You are trying to use both system handsets at the same time. Be sure to only use one system handset at a time.
<p>The batteries will not hold a charge.</p>	<ul style="list-style-type: none"> • Make sure the battery is plugged into the handset. • Be sure to use the AC power adaptor provided with your phone. • Charge the battery in the handset for at least 16 hours. For optimum daily performance, return the handset to its base when not in use. • You may need to purchase a new battery, please refer to the Batteries section of this user's manual. • Your phone might be malfunctioning. Please refer to the Warranty section of this user's manual for further instruction.

Troubleshooting

Problem	Suggestion
I get noise, static, or weak signal even when I'm near the base.	<ul style="list-style-type: none">• Press the CHAN button while on a call until the interference has been eliminated.• Other electronic products can cause interference with your cordless phone. Try installing your phone as far away from these types of electronic devices as possible: wireless routers, radios, radio towers, pager towers, cell phones, intercoms, room monitors, televisions, personal computers, kitchen appliances and other cordless phones.• Microwaves operate on the same frequency as your phone. It is normal to experience static on your phone while the microwave is running. Do not install this phone in the same outlet or near the microwave.• If your phone is plugged in with a modem or surge protector, plug the phone (or modem/surge protector) into a different location. If this solves the problem, re-locate your phone or modem farther apart from one another, or use a different surge protector.• Relocate your phone to a higher location. The phone will likely get better reception not installed in a low area.• If the other phones in your home are having the issue, the problem is in your wiring or local service. Contact your local telephone company (charges may apply.)
I hear noise in the handset, and none of the keys or buttons work.	<ul style="list-style-type: none">• Make sure the power cord is plugged in.

Troubleshooting

Problem	Suggestion
I hear other calls while using my phone	<ul style="list-style-type: none">• Disconnect your base unit from the telephone jack, and plug in a regular telephone. If you still hear other calls, the problem is probably in your wiring or local service. Call your local telephone company.
My handset does not ring when I receive a call.	<ul style="list-style-type: none">• Make sure you have the ringer activated. Refer to the section(s) on ringer selection in this user's manual.• Make sure the telephone line cord is plugged firmly into the base unit and the telephone jack. Make sure the power cord is plugged in.• You may be too far from the base unit.• Charge the battery in the handset for at least 16 hours. For optimum daily performance, return the handset to its base when not in use.• You may have too many extension phones on your telephone line to allow all of them to ring. Try unplugging some of the other phones.• The layout of your home or office might be limiting the operating range. Try moving the base to another location, preferably on an upper floor.• If the other phones in your home are having the issue, the problem is in your wiring or local service. Contact your local telephone company (charges may apply.)• Test a working phone at the phone jack. If another phone has the same problem, the problem is the phone jack. Contact your local telephone company (charges may apply.)• Other electronic products can cause interference with your cordless phone. Try installing your phone as far away from these types of electronic devices as possible: wireless routers, radios, radio towers, pager towers, cell phones, intercoms, room monitors, televisions, personal computers, kitchen appliances and other cordless phones• Your line cord might be malfunctioning. Try installing a new line cord.

Troubleshooting

Problem	Suggestion
My calls fade or cut in and out while I'm using my handset.	<ul style="list-style-type: none"> • Press the CHAN button while on a call until the interference has been eliminated. • Other electronic products can cause interference with your cordless phone. Try installing your phone as far away from these types of electronic devices as possible: wireless routers, radios, radio towers, pager towers, cell phones, intercoms, room monitors, televisions, personal computers, kitchen appliances and other cordless phones • Microwaves operate on the same frequency as your phone. It is normal to experience static on your phone while the microwave is running. Do not install this phone in the same outlet or near the microwave. • If your phone is plugged in with a modem or surge protector, plug the phone (or modem/surge protector) into a different location. If this solves the problem, re-locate your phone or modem farther apart from one another, or use a different surge protector. • Relocate your phone to a higher location. The phone will get better reception not installed in a low area. • If the other phones in your home are having the issue, the problem is in your wiring or local service. Contact your local telephone company (charges may apply.)
My caller ID isn't working.	<ul style="list-style-type: none"> • Caller ID is a subscription service. You must subscribe to this service for this feature to work on your phone. • Your caller must be calling from an area that supports caller ID. • Both you and your caller's telephone companies must use caller ID compatible equipment.
My answering machine is not recording messages.	<ul style="list-style-type: none"> • Make sure system is turned ON (the Answer ON/OFF LED is illuminated.). • Make sure the announce only feature is set to OFF.
I cannot hear recorded messages.	Using the base volume control, raise the volume to a comfortable listening level.

Troubleshooting

Problem	Suggestion
CL is flashing in the base message display window.	<ul style="list-style-type: none">You need to set the day and time. Refer to the section(s) on setting the clock in this user's manual.
Common cure for electronic equipment.	<p>If the unit does not seem to be responding normally, then try putting the handset in its base. If it does not seem to respond, do the following (in the order listed):</p> <ol style="list-style-type: none">1. Disconnect the power to the base.2. Disconnect the handset battery, and spare battery, if applicable.3. Wait a few minutes.4. Connect power to the base.5. Re-install the battery(ies).6. Wait for the handset to re-establish its link with the base. To be safe, allow up to one minute for this to take place.

If you subscribe to DSL service:

If you hear noise during conversations and/or your caller ID features aren't functioning properly, install a noise filter to the telephone line between the base unit and the telephone line jack. Contact your DSL provider to obtain a noise filter.

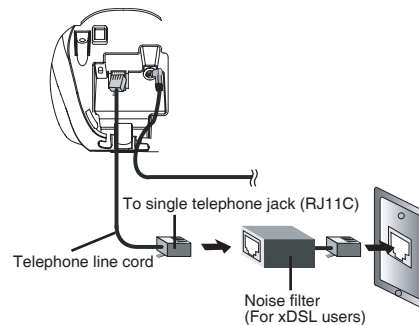

Maintenance

Taking care of your telephone

Your cordless telephone contains sophisticated electronic parts, so it must be treated with care.

Avoid rough treatment

Place the handset down gently. Save the original packing materials to protect your telephone if you ever need to ship it.

Avoid water

Your telephone can be damaged if it gets wet. Do not use the handset outdoors in the rain, or handle it with wet hands. Do not install your base unit near a sink, bathtub or shower.

Electrical storms

Electrical storms can sometimes cause power surges harmful to electronic equipment. For your own safety, use caution when using electric appliances during storms.

Cleaning your telephone

Your telephone has a durable plastic casing that should retain its luster for many years. Clean it only with a soft cloth slightly dampened with water or a mild soap. Do not use excess water or cleaning solvents of any kind.

Limited Warranty

What does this limited warranty cover?

- The manufacturer of this VTech Product warrants to the holder of a valid proof of purchase ("Consumer" or "you") that the Product and all accessories provided in the sales package ("Product") are free from defects in material and workmanship, pursuant to the following terms and conditions, when installed and used normally and in accordance with the Product operating instructions. This limited warranty extends only to the Consumer for Products purchased and used in the United States of America and Canada.

What will VTech do if the Product is not free from defects in materials and workmanship during the limited warranty period ("Materially Defective Product")?

- During the limited warranty period, VTech's authorized service representative will repair or replace at VTech's option, without charge, a Materially Defective Product. If we repair the Product, we may use new or refurbished replacement parts. If we choose to replace the Product, we may replace it with a new or refurbished Product of the same or similar design. We will retain defective parts, modules, or equipment. Repair or replacement of the Product, at VTech's option, is your exclusive remedy. VTech will return repaired or replacement Products to you in working condition. You should expect the repair or replacement to take approximately 30 days.

How long is the limited warranty period?

- The limited warranty period for the Product extends for ONE (1) YEAR from the date of purchase. If VTech repairs or replaces a Materially Defective Product under the terms of this limited warranty, this limited warranty also applies to repaired or replacement Product for a period of either (a) 90 days from the date the repaired or replacement Product is shipped to you or (b) the time remaining on the original one-year warranty; whichever is longer.

What is not covered by this limited warranty?

This limited warranty does not cover:

1. Product that has been subjected to misuse, accident, shipping or other physical damage, improper installation, abnormal operation or handling, neglect, inundation, fire, water or other liquid intrusion; or
2. Product that has been damaged due to repair, alteration or modification by anyone other than an authorized service representative of VTech; or
3. Product to the extent that the problem experienced is caused by signal conditions, network reliability, or cable or antenna systems; or
4. Product to the extent that the problem is caused by use with non-VTech accessories; or
5. Product whose warranty/quality stickers, Product serial numbers plates or electronic serial numbers have been removed, altered or rendered illegible; or

Limited Warranty

6. Product purchased, used, serviced, or shipped for repair from outside the United States of America or Canada, or used for commercial or institutional purposes (including but not limited to Products used for rental purposes); or
7. Product returned without valid proof of purchase (see item 2 below); or
8. Charges for installation or set up, adjustment of customer controls, and installation or repair of systems outside the unit.

How do you get warranty service?

- To obtain warranty service in the United States of America, call 1-800-595-9511 for instructions regarding where to return the Product. Before calling for service, please check the user's manual. A check of the Product controls and features may save you a service call.
- Except as provided by applicable law, you assume the risk of loss or damage during transit and transportation and are responsible for delivery or handling charges incurred in the transport of Product (s) to the service location. VTech will return repaired or replaced product under this limited warranty to you, transportation, delivery or handling charges prepaid. VTech assumes no risk for damage or loss of the Product in transit.
- If the Product failure is not covered by this limited warranty, or proof of purchase does not meet the terms of this limited warranty, VTech will notify you and will request that you authorize the cost of repair prior to any further repair activity. You must pay for the cost of repair and return shipping costs for the repair of Products that are not covered by this limited warranty.

What must you return with the Product to get warranty service?

1. Return the entire original package and contents including the Product to the VTech service location along with a description of the malfunction or difficulty; and
2. Include "valid proof of purchase" (sales receipt) identifying the Product purchased (Product model) and the date of purchase or receipt; and
3. Provide your name, complete and correct mailing address, and telephone number.

Other Limitations

- This warranty is the complete and exclusive agreement between you and VTech. It supersedes all other written or oral communications related to this Product. VTech provides no other warranties for this Product. The warranty exclusively describes all of VTech's responsibilities regarding the Product. There are no other express warranties. No one is authorized to make modifications to this limited warranty and you should not rely on any such modification.
- State/Provincial Law Rights: This warranty gives you specific legal rights, and you may also have other rights, which vary from state to state or province to province.
- Limitations: Implied warranties, including those of fitness for a particular purpose and merchantability (an unwritten warranty that the Product is fit for ordinary use) are limited to one year from date of purchase. Some states/provinces do not allow limitations on how long an implied warranty lasts, so the above limitation may not apply to you. In no event shall VTech be liable for any indirect, special, incidental, consequential, or similar damages (including, but not limited to lost profits or revenue, inability to use the Product or other associated equipment, the cost of substitute equipment, and claims by third parties) resulting from the use of this Product. Some states/provinces do not allow the exclusion or limitation of incidental or consequential damages, so the above limitation or exclusion may not apply to you.

Please retain your original sales receipt as proof of purchase.

Important Safety Instructions

When using your telephone equipment, basic safety precautions should always be followed to reduce the risk of fire, electric shock and injury, including the following:

1. Read and understand all instructions.
2. Follow all warnings and instructions marked on the product.
3. Unplug this product from the wall outlet before cleaning. Do not use liquid or aerosol cleaners. Use a damp cloth for cleaning.
4. Do not use this product near water (for example, near a bath tub, kitchen sink or swimming pool).
5. Do not place this product on an unstable surface, such as a table, shelf or stand. The product may fall, causing serious damage.
6. Slots and openings in the back or bottom of the base unit and handset are provided for ventilation. To protect them from overheating, these openings must not be blocked by placing the product on a soft surface such as a bed, sofa or rug. This product should never be placed near or over a radiator or heat register. This product should not be placed in any area where proper ventilation is not provided.
7. This product should be operated only from the type of power source indicated on the marking label. If you are not sure of the type of power supply in your home, consult your dealer or local power company.
8. Do not allow anything to rest on the power cord. Do not install this product where the cord may have anyone walking on it.
9. Never push objects of any kind into this product through slots in the base or handset as they may touch dangerous voltage points or short out parts that could result in a risk of fire or electric shock. Never spill liquid of any kind on the product.
10. To reduce the risk of electric shock, do not disassemble this product, but take it to an authorized service facility. Opening or removing parts of the base or handset other than specified access doors may expose you to dangerous voltages or other risks. Incorrect reassembling can cause electric shock when the product is subsequently used.
11. Do not overload wall outlets and extension cords as this can result in the risk of fire or electric shock.
12. Unplug this product from the wall outlet and refer servicing to an authorized service facility under the following conditions:
 - A. When the power supply cord or plug is damaged or frayed.
 - B. If liquid has been spilled onto the product.
 - C. If the product has been exposed to rain or water.
 - D. If the product does not operate normally by following the operating instructions. Adjust only those controls that are covered by the operating instructions, as improper adjustment of other controls may result in damage and often requires extensive work by an authorized technician to restore the product to normal operation.
 - E. If the product has been dropped and the base and/or handset has been damaged.
 - F. If the product exhibits a distinct change in performance.
13. Avoid using a telephone (other than cordless) during an electrical storm. There is a remote risk of electric shock from lightning.
14. Do not use the telephone to report a gas leak in the vicinity of the leak.
15. Only put the handset of your telephone next to your ear when it is in normal talk.
16. This power unit is intended to be correctly orientated in a vertical or floor mount position. The prongs are not designed to hold the plug in place if it is plugged into a ceiling or an under the table/cabinet outlet.

SAVE THESE INSTRUCTIONS

FCC, ACTA and IC Regulations

FCC Part 15

This equipment has been tested and found to comply with the requirements for a Class B digital device under Part 15 of the Federal Communications Commission (FCC) rules. These requirements are intended to provide reasonable protection against harmful interference in a residential installation. This equipment generates, uses and can radiate radio frequency energy and, if not installed and used in accordance with the instructions, may cause harmful interference to radio communications. However, there is no guarantee that interference will not occur in a particular installation. If this equipment does cause harmful interference to radio or television reception, which can be determined by turning the equipment off and on, the user is encouraged to try to correct the interference by one or more of the following measures:

- * Reorient or relocate the receiving antenna.
- * Increase the separation between the equipment and receiver.
- * Connect the equipment into an outlet on a circuit different from that to which the receiver is connected.
- * Consult the dealer or an experienced radio/TV technician for help.

Changes or modifications to this equipment not expressly approved by the party responsible for compliance could void the user's authority to operate the equipment.

To ensure safety of users, the FCC has established criteria for the amount of radio frequency energy that can be safely absorbed by a user or bystander according to the intended usage of the product. This product has been tested and found to comply with the FCC criteria. The handset may be safely held against the ear of the user. The base unit shall be installed and used such that parts of the user's body other than the hands are maintained at a distance of approximately 20 cm (8 inches) or more. If you choose to use a clipping device, please make sure to only use the supplied VTech belt clip.

FCC Part 68 and ACTA

This equipment complies with Part 68 of the FCC rules and with technical requirements adopted by the Administrative Council for Terminal Attachments (ACTA). The label on the back or bottom of this equipment contains, among other things, a product identifier in the format US:AAAEQ#TXXXX. This identifier must be provided to your local telephone company upon request.

The plug and jack used to connect this equipment to premises wiring and the telephone network must comply with applicable Part 68 rules and technical requirements adopted by ACTA. A compliant telephone cord and modular plug is provided with this product. It is designed to be connected to a compatible modular jack that is also compliant. An RJ11 jack should normally be used for connecting to a single line and an RJ14 jack for two lines. See Installation Instructions in the user's manual.

The Ringing Equivalence Number (REN) is used to determine how many devices you may connect to your telephone line and still have them ring when you are called. The REN for this product is encoded as the 6th and 7th characters following the US: in the product identifier (e.g., if ## is 03, the REN is 0.3). In most, but not all areas, the sum of all RENs should be five (5.0) or less. For more information, please contact your local telephone company.

This equipment may not be used with Party Lines. If you have specially wired alarm dialing equipment connected to your telephone line, ensure the connection of this equipment does not disable your alarm equipment. If you have questions about what will disable alarm equipment, consult your telephone company or a qualified installer.

If this equipment is malfunctioning, it must be unplugged from the modular jack until the problem has been corrected. Repairs to this telephone equipment can only be made by the manufacturer or its authorized agents. For repair procedures, follow the instructions outlined under the Limited Warranty.

If this equipment is causing harm to the telephone network, the telephone company may temporarily discontinue your telephone service. The telephone company is required to notify you before interrupting service. If advance notice is not practical, you will be notified as soon as possible. You will be given the opportunity to correct the problem and the telephone company is required to inform you of your right to file a complaint with the FCC. Your telephone company may make changes in its facilities, equipment, operation, or procedures that could affect the proper functioning of this product. The telephone company is required to notify you if such changes are planned.

If this product is equipped with a corded or cordless handset, it is hearing aid compatible.

If this product has memory dialing locations, you may choose to store emergency telephone numbers (e.g., police, fire, medical) in these locations. If you do store or test emergency numbers, please:

www.vtechphones.com

ADDITIONAL INFO

43

FCC, ACTA and IC Regulations

- * Remain on the line and briefly explain the reason for the call before hanging up.
- * Perform such activities in off-peak hours, such as early morning or late evening.

Industry Canada

This equipment complies with regulations RSS210 and CS-03 of Industry Canada. Operation is subject to the following two conditions: (1) this device may not cause interference, and (2) this device must accept any interference, including interference that may cause undesired operation of the device.

The term "IC: " before the certification/registration number only signifies that the Industry Canada technical specifications were met.

The Ringer Equivalence Number (REN) for this terminal equipment is 0.1. The REN is an indication of the maximum number of devices allowed to be connected to a telephone interface. The termination on an interface may consist of any combination of devices subject only to the requirement that the sum of the RENs of all the devices does not exceed five.

The RBRC[®] Seal

The RBRC[®] Seal



The RBRC[®] Seal on the nickel-cadmium battery indicates that VTech Communications, Inc. is voluntarily participating in an industry program to collect and recycle these batteries at the end of their useful lives, when taken out of service within the United States and Canada.

The RBRC[®] program provides a convenient alternative to placing used nickel-cadmium batteries into the trash or municipal waste, which may be illegal in your area. VTech's participation in RBRC[®] makes it easy for you to drop off the spent battery at local retailers participating in the RBRC[®] program or at authorized VTech product service centers. Please call 1-800-8-BATTERY™ for information on Ni-Cd battery recycling and disposal bans/restrictions in your area. VTech's involvement in this program is part of its commitment to protecting our environment and conserving natural resources.

RBRC[®] is a registered trademark of Rechargeable Battery Recycling Corporation.

Technical Specifications

Enhanced 2.4GHz technology—your phone operates on a dual band transmission that combines the best of 2.4GHz and 900MHz technologies, providing enhanced performance over standard cordless telephones.

Frequency Control	Crystal controlled PLL synthesizer
Transmit Frequency	Base: 2410.2–2418.9 MHz Handset: 912.75–917.10 MHz
Receive Frequency	Base: 912.75–917.10 MHz Handset: 2410.2–2418.9 MHz
Channels	30
Nominal Effective Range	Maximum power allowed FCC and IC. Actual operating range may vary according to environmental conditions at the time of use.
Size	Handset: 39mm X 54mm X 186mm Base: 159mm X 107mm X 123mm Charger: 76mm X 81mm X 54mm
Weight	Handset: 116 grams Base: 281 grams Charger: 41grams
Power Requirements	Handset: 300mAH Ni-Cd Battery Base: 9V DC @ 300mA Charger: 6V DC @ 200mA
Memory	Speed Dial: 9 Memory locations, 24 digits per location Directory: 10 Memory locations, 24 digits per location CID: 30 Memory locations

Index

A

About Announcements 22
About Call History (Caller ID) 20
Answering System Operation At The Base 22
Answering System—Remote Access Commands 30
Audible Indicators 22

B

Base Operation 10
Batteries 32
Battery Care and Maintenance 22
Before You Begin 3

C

Caller ID Operation 19
Charge the Handset Battery 7
Charge the Handset Battery 7
Check for Dial Tone 7
Choose Location 4

D

Delete a Number/Name in Speed Dial 15
Delete a Number/Name in the Directory 17
Delete Records from Call History 20
Dial a Displayed Number 21
Dial a Number from the Directory 18
Dial a Speed Dial Number 15
Display Screen Messages 12

E

Edit a Number/Name in Speed Dial 15
Edit a Number/Name in the Directory 17

F

FCC, ACTA and IC Regulations 43-44
Feature Summary 25

G

GETTING STARTED 3

H

Handset Operation 9
Handset Ringer Style/Battery Save 8

I

If you subscribe to DSL service 8,39
Important Safety Instructions 42
Install Handset Battery 4
Installation 4

L

Limited Warranty 40-41
Listen to & Delete Messages 26

M

Maintenance 40
Message Window Display 29
Move a Number/Name to the Memory 18

O

Operating Range 11

P

Parts Checklist 3

R

Reassign Locations in Speed Dial 15

Record a Memo 28

Record Your Announcement 24

Remote access Commands 30

Remote access 30

Replacing the Handset Battery 32

Review Call History 20

S

Set Handset Date and Time 7

Set Language mode 7

Set the Dial Mode 7

Setting the Clock 22

Setting Up Your Answering System 24

Speed Dialing 13

Store a Call History Record in the Directory 21

Store a Number/Name in Speed Dial 13

Store a Number/Name in the Directory 16

T

Table/Desk Installation 5

Technical Specifications 45

Telephone Directory 16

Telephone Operation 9

Temporary Tone Dialing 11

The RBRC Seal 44

To delete your announcement 24

To review your announcement at any time 24

Troubleshooting 33-39

W

Wall Mounting 6

VTECH TELECOMMUNICATIONS LTD.

A member of THE VTECH GROUP OF COMPANIES.

Distributed in the U.S.A. by VTech Communications, Inc. Beaverton, Oregon
Distributed in Canada by VTech Telecommunications Canada Ltd., Richmond, B.C.

Copyright ©2007 for VTECH TELECOMMUNICATIONS LTD.
Printed in China.

91-000442-070-000

vtech[®]
Innovation Beyond Technology™

vtech[®]
Innovation Beyond Technology™

User's Manual
www.vtechphones.com



Models:
t2350/2350-01/
t2353

2.4 GHz
Technology

Free Manuals Download Website

<http://myh66.com>

<http://usermanuals.us>

<http://www.somanuals.com>

<http://www.4manuals.cc>

<http://www.manual-lib.com>

<http://www.404manual.com>

<http://www.luxmanual.com>

<http://aubethermostatmanual.com>

Golf course search by state

<http://golfingnear.com>

Email search by domain

<http://emailbydomain.com>

Auto manuals search

<http://auto.somanuals.com>

TV manuals search

<http://tv.somanuals.com>