

TuffSet Powerline Amplifier

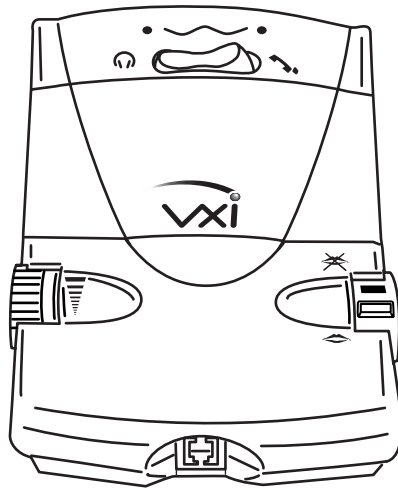

VXi Corporation
One Front Street, Rollinsford, NH 03869
603-742-2888
1-800-742-8588
email: tuffset@vxicorp.com
website: www.vxicorp.com

©2002 VXi Corporation

COMPONENTS

1. Headset Stand
2. Top Door
3. Headset/Handset Switch
4. Compatibility Switches
5. Microphone Volume Control
6. Mute Switch
7. Receive Volume Control
8. Headset Port

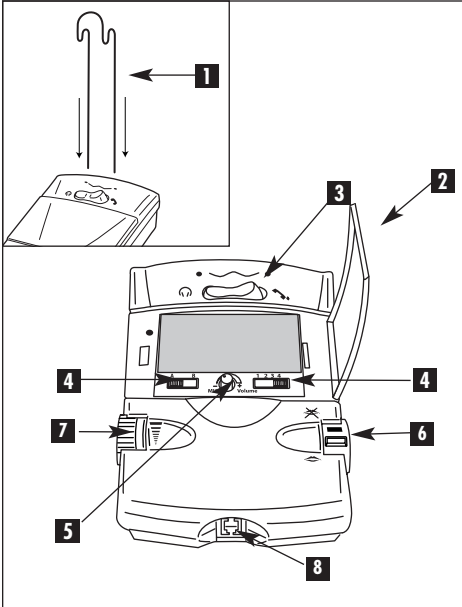

9. To Phone Line Jack on Phone
10. Optional AC Adapter Port - Use only Listed Direct Plug-In Power Unit marked "Class 2" and rated 9 VDC 100 mA.
11. To Handset Jack on Phone
12. Handset Cord Jack
13. Wall Jack
14. Black Cord (4 position plugs)
15. Gray Cord (6 position plugs)
16. Lower Coil Cord



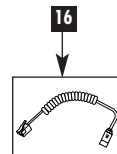
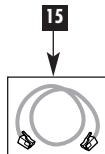
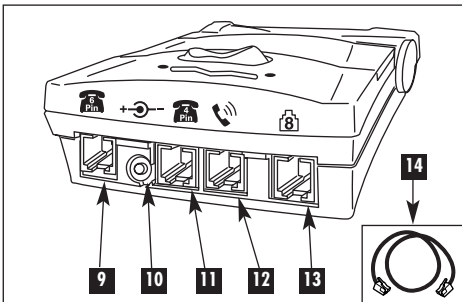

Note: Refer to icons printed on bottom of amplifier.



STEP 1:

Connect the Cords- Follow instructions below for your phone type.

Connection for Electronic Phones (Figure 1)

1. Disconnect your telephone cord from the back of your telephone and insert it into the Wall Line Jack . This jack will accept both 8-position and 6-position modular plugs.
2. Plug the gray cord into the Phone Line Jack on the amplifier . Plug the free end of this cord into the now vacant jack on your phone.
3. Remove the coiled handset cord from your telephone and plug it into the jack marked .
4. Connect one end of the black cord into the now empty handset jack on your phone. Connect the other end of this cord into the jack marked .

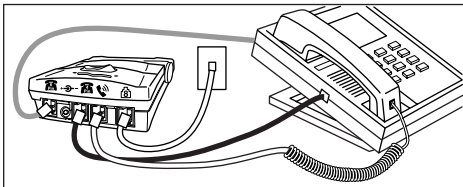

Figure 1

Connection for Carbon Phones (Figure 2)

1. Remove the coiled handset cord from your telephone and plug it into the jack marked .
2. Connect one end of the black cord into the now empty handset jack on your phone. Connect the other end of this cord into the jack marked .

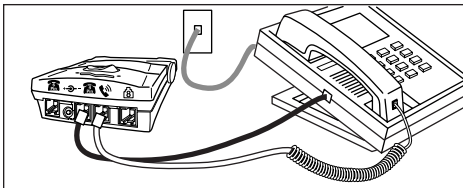

Figure 2

STEP 2:

Connecting the Headset

The Powerline headset port is compatible with the supplied VXI lower cord, and is also compatible with GN Netcom® and Fellowes® headsets (please see instructions below for installation requirements).

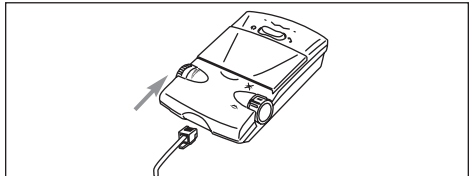

Figure 3

Connecting a VXI Headset

Connect the VXI headset to the lower coil cord provided with the amplifier and insert modular plug into the front port of the amplifier (Figure 3).

Connecting a GN Netcom or Fellowes Headset

Connect the GN Netcom or Fellowes headset, including its lower cord, by inserting modular plug into the front port of the amplifier (Figure 3).

Discard the VXI-provided lower cord.

STEP 3:

Setting up the Headset/Handset

Set the headset/handset switch to the headset position (Figure 4).

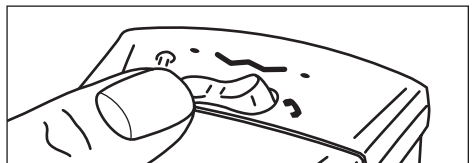

Figure 4

STEP 4:
Setting the Mute Switch

To activate the headset microphone, rotate the mute switch forward so the green box on the switch is showing (Figure 5). Note: If the red box on the switch is showing, your microphone will be muted.

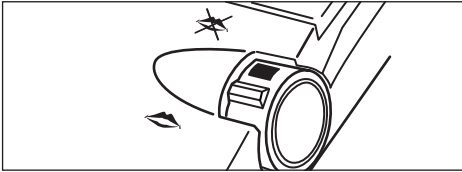

Figure 5

STEP 5:
Setting Compatibility Switches

1. Place headset on head
2. Take phone off of the hook
3. If you do not get a clear dial tone, locate the compatibility switches below the top door and adjust the switches in the following order as depicted in Figure 6:
 - A4 through A1
 - B4 through B1

Try all switch positions. Choose the setting with the best dial tone. Proceed to Step 6 to place a test call to ensure that your settings also provide the clearest voice.

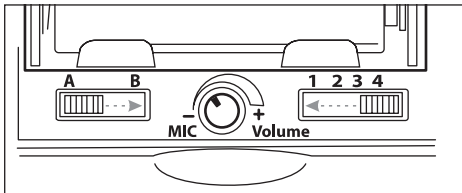

Figure 6

STEP 6:
Place a Call

Adjust microphone volume until the other party can hear you clearly and hear minimal background noise (Figure 7).

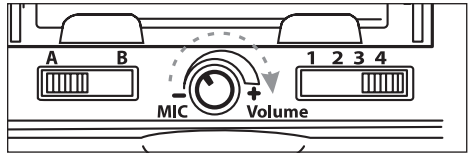

Figure 7

STEP 7:
Adjust Receive Volume

Adjust the receive volume control by sliding the wheel until you can comfortably hear the other party (Figure 8).

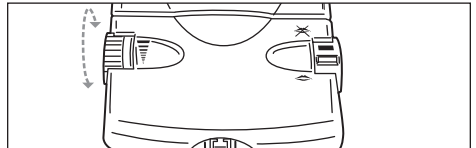

Figure 8

Troubleshooting

Why can't I hear callers?

- Check if all cords are connected
- Adjust receive volume control on amplifier
- Adjust compatibility switches

Why can't callers hear me?

- Make sure mute switch on telephone or amplifier is not turned on
- Make sure microphone is positioned correctly. See your headset instructions that are included with your headset
- Adjust microphone volume control
- Adjust compatibility switches

There is excess noise in my speaker. What can I do to fix this?

- Turn down the volume on the microphone on your amplifier or telephone

LIMITED WARRANTY

1. If your VXI headset or amplifier fails to work for any reason during the first two years from the date of purchase as shown by the purchaser's warranty registration, VXI will repair or replace the headset or amplifier, at its election, free of charge. To register your product, you may do so online at www.vxicorp.com, or by calling customer service at 800-742-8588. Without warranty registration, the warranty period begins on the date of manufacture. All products returned to VXI after the two-year warranty period will be repaired as "out of warranty" products, and purchaser will be billed for such repairs pursuant to the Out-of-Warranty Repair provisions set forth below.

2. The obligations of VXI under this warranty shall be limited to repair or replacement (at our option) of any part returned, freight pre-paid to VXI.

Returned products require a Return Authorization that may be requested from VXI at 800-742-8588 or www.vxicorp.com. Send repairs to: VXI Corporation, One Front Street, Rollinsford, NH 03869.

3. THIS LIMITED WARRANTY IS IN LIEU OF ALL OTHER WARRANTIES, EXPRESS OR IMPLIED, INCLUDING THE IMPLIED WARRANTIES OF MERCHANTABILITY AND FITNESS FOR A PARTICULAR PURPOSE.

4. Some jurisdictions do not permit the exclusion of implied warranties and the foregoing exclusions may not apply to you.

5. In no event shall VXI be responsible for any other damages whatsoever including direct, indirect, special, incidental, consequential or otherwise for breach of this or any other warranty, express or implied.

6. Products returned to VXI for Warranty and Out-of-Warranty repairs, freight prepaid and with proper Returned Authorizations, will be return shipped to the customer at VXI's expense within five (5) days of VXI's receipt of payment.

GN Netcom and Fellowes are trademarks or registered trademarks of their respective owners.

VXI TuffSet Powerline Amplifier – Instruction Guide

P/N 200911B



VXI Corporation
One Front Street, Rollinsford, NH 03869
603-742-2888 1-800-742-8588 <http://www.vxicorp.com>

THIS PAGE DOES NOT PRINT!

VXI Part Number: 200911B

VXI Artwork Number: 200912B

Size: 5.75" W x 7.25" H

Pages: 8

Ink: 1/1; black; full bleed

Stock: 80 gm offset text

Free Manuals Download Website

<http://myh66.com>

<http://usermanuals.us>

<http://www.somanuals.com>

<http://www.4manuals.cc>

<http://www.manual-lib.com>

<http://www.404manual.com>

<http://www.luxmanual.com>

<http://aubethermostatmanual.com>

Golf course search by state

<http://golfingnear.com>

Email search by domain

<http://emailbydomain.com>

Auto manuals search

<http://auto.somanuals.com>

TV manuals search

<http://tv.somanuals.com>