

**"Save These Instructions"**



**V-130**  
HE55



**V-150**  
HE120

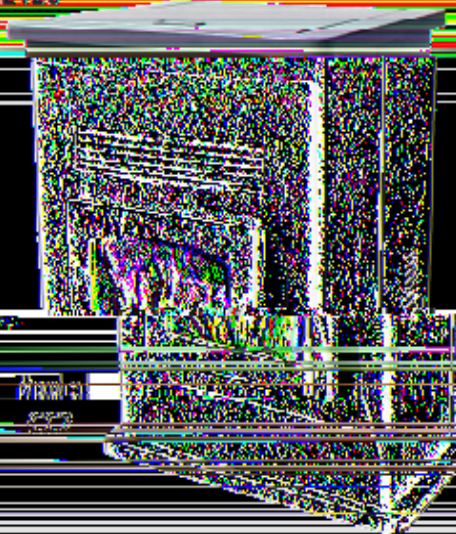

**Danson's Group Inc.**  
Sustainable. Resource. Development.

**Canadian Comfort Industries**  
A Technological Company

To register your purchase:  
[www.dansons.com/support](http://www.dansons.com/support)

My local "V" Series dealer is:



**READ THIS ENTIRE MANUAL BEFORE YOU INSTALL AND USE YOUR HEATER. FAILURE TO FOLLOW INSTRUCTIONS MAY RESULT IN PROPERTY DAMAGE, BODILY INJURY OR EVEN DEATH!**

Installation shall conform to CAN/CSA 4969 Installation Code for Solid-Fuel-Burning Appliances and Equipment in Canada and NFPA 211 Chimney, Fireplace, Stove and Solid Fuel Burning Appliances in the US.

Contact local building or fire officials about restrictions and installation inspection requirements in your area.

Dear *VULCAN "V" SERIES* Pellet Stove Owner:

**CONGRATULATIONS** on the purchase of your *VULCAN "V" SERIES* wood pellet appliance! You have selected the finest in residential wood pellet heating technology.

Let us pass on a few "**tips**" concerning installing your stove and heating with wood pellets.

1. Whether you install your stove yourself or hire a professional installer, **a quality installation is a must** for the safety of your family and for efficient, satisfactory operation of your stove.
2. **Initial Burn Setup of the stove is the most important step** to ensure the efficient and satisfactory operation of your appliance for many years to come.
3. **Know the quality and characteristics of the pellets you burn.** Pellets can vary greatly from company to company, from load to load and occasionally from bag to bag.
4. **Be extra diligent in your cleaning program.**
5. Remember that **most operational dilemmas** with a pellet stove are usually traced back to **Improper installation, poor quality pellets and/or a lack of timely cleaning.**

With just a minimum of daily care your *VULCAN "V" SERIES* pellet appliance will provide years of clean, efficient, comfortable and environmentally sound heating.

Thank you for selecting a *VULCAN "V" SERIES* wood pellet appliance.

Sincerely,

***Canadian Comfort Industries &  
Dansons Group Inc.***

#### **UPDATES and REGISTRATION**

Up to date additions, product information, product registration and warranty extension registration can be found on our website **[www.dansons.com/support](http://www.dansons.com/support)**

#### **COPYRIGHT NOTICE**

Copyright 2005, ***Canadian Comfort Industries***. All rights reserved.

No part of this manual may be copied, transmitted, transcribed, stored in a retrieval system, in any form or by any means without the expressed written permission of,  
***Canadian Comfort Industries; 26319 Twp Rd 531, Acheson, AB, Canada T7X 5A3***

# TABLE OF CONTENTS

<b>GENERAL INFORMATION</b>	
SAFETY PRECAUTIONS .....	4
SAFETY TESTING .....	5
HOW YOUR VULCAN "V" SERIES STOVE WORKS .....	6
AUTOMATIC SAFETY FEATURES .....	7
SPECIFICATIONS .....	8
<b>INSTALLATION</b>	
INSTALLATION PLANNING & CHECK LISTS .....	9
INSTALLATION OPTIONS .....	10
EXHAUST SYSTEMS .....	11
SIZING .....	11
TERMINATION .....	12
CLEARANCES .....	12
OUTSIDE AIR .....	13
FREESTANDING INSTALLATION	
STOVE PLACEMENT .....	14
FLOOR PROTECTION .....	14
CLEARANCES .....	14
ALCOVE .....	15
THROUGH THE WALL DIRECT INSTALLATION .....	16
VERTICAL INSTALLATIONS .....	17
MOBILE HOME INSTALLATION .....	18
<b>OPERATION</b>	
LIGHTING A FIRE .....	19
THE ACUTRON CONTROLS .....	20
SHUTTING THE STOVE OFF .....	21
ACUTRON WALL THERMOSTAT (OPTIONAL) .....	22
INITIAL BURN SETUP .....	23
PERFORMANCE ENHANCEMENT TIPS .....	24
<b>PELLETS</b>	
PELLET QUALITY .....	25
PELLET CONSUMPTION .....	25
FACTORS EFFECTING PELLET FEED RATES .....	25
FINE TUNING THE PELLET FEED RATES .....	25
ASH and CLINKERS .....	26
FINES .....	26
PFI PELLET STANDARDS .....	26
<b>MAINTENANCE</b>	
REQUIRED CLEANING .....	27
INSERTING, REMOVING, AND ADJUSTING THE BURN GRATE .....	28
PERIODIC MAINTENANCE .....	29
TROUBLE SHOOTING .....	31
LIMITED WARRANTY .....	32
<b>APPENDIX "A" - VULCAN "V" SERIES OPTIONS .....</b>	<b>33</b>
<b>APPENDIX "B" - VULCAN "V" SERIES ACCESSORIES .....</b>	<b>34</b>
<b>APPENDIX "C" - AcuTron WALL THERMOSTAT INSTALLATION .....</b>	<b>35</b>
<b>APPENDIX "D" - HOPPER CLEAN-OUT DROP CHUTE .....</b>	<b>36</b>
<b>SERVICE LOG .....</b>	<b>37</b>

# SAFETY PRECAUTIONS

**IMPORTANT:** Read, save and follow the instructions in this manual. It contains important Safety, Operating and Maintenance instructions you will need.

- **BEFORE** installing or having the pellet appliance installed contact the local building officials to obtain the necessary permits and information on any installation restrictions or inspection requirements in your area and notify your insurance company you have installed a pellet appliance.
- This unit must be properly installed to prevent the possibility of a house fire. The instructions and local building codes requirements must be strictly adhered to. **Do not**; use makeshift methods or material that may compromise the installation.
- When the pellet appliance is installed in a mobile home, the heater must be bolted to the floor, have outside air, and **MUST NOT BE INSTALLED IN THE BEDROOM** (Per H.U.D. requirements). Check with local building officials.
- **NEVER** try to repair or replace any part of the heater unless instructions for consumer are given in this manual or instructed by Dansons Customer Service Department. A trained technician should do all other work.
- **Educate** all children of the danger of a high-temperature heater. Young children should be supervised when they are in the same room as the heater.
- This heater is designed and approved for pelletized wood fuel only. Any other type of fuel burned in this heater will void the warranty and safety listing. Keep foreign objects out of the hopper.
- **NEVER** use gasoline, gasoline-type lantern fuel, kerosene, charcoal lighter fluid, or similar liquids to start or “freshen up” a fire in this appliance. Keep all such liquids well away from the appliance while it is in use.
- This heater must be connected to a standard 115 V., 60 Hz grounded electrical outlet. **A grounded surge-protection unit is recommended.**
- **Do not** use an adapter plug or sever the grounding prong on the electrical plug.
- **Do not** route the electrical cord underneath, in front of, or over the heater.
- **Do not** unplug the stove if you suspect a malfunction. Push the “OFF” Touch Pad and inspect the heater.
- The heater will not operate during a power outage. If a power outage does occur, check the heater for smoke spillage and open a window if any smoke spills into the room.
- **DO NOT** operate the heater if you smell smoke coming from the heater. Push the “OFF” Touch Pad, monitor your pellet appliance, and call your local authorized dealer.
- **Do not** place clothing or other flammable items on or near the heater. When installed with a thermostat there is a possibility of the heater turning on and igniting any items placed on or near the unit.
- **CAUTION: NEVER** put fingers in or near pellet feed auger. The pellet fuel is fed to the burn pot by a screw auger that is driven by a high torque motor. This auger can start and stop anytime automatically without warning while stove is operating.

# SAFETY PRECAUTIONS . . . Continued

- **DO NOT** operate the stove if the flame becomes dark and sooty or if the firepot overfills with pellets. Push the **OFF** Touch Pad and inspect the heater. (See Operating Your Stove). Soot or creosote may accumulate in the exhaust vent system when the stove is operated under incorrect conditions such as an extremely rich burn. The flame will have a lazy orange color with black tips. This indicates poor pellet fuel combustion.
- **NEVER** block free airflow through the open vents of the unit. The viewing door and ash pan must be closed and latched during operation.
- The pellet appliance exhaust system works with **negative** combustion chamber pressure and a **positive** chimney pressure, therefore the exhaust system must be completely airtight and properly installed. All exhaust system vent joints must be sealed, gas tight, with HI-TEMP RTV silicone sealant, and/or at least 3 sheet metal screws **per joint and to the heater** also.
- Your heater requires periodic maintenance and cleaning (Refer to "Routine Cleaning" section of the manual). Failure to maintain your heater may lead to smoke spillage in your home.
- **Disconnect** the power cord from the electrical outlet before performing any maintenance. Pushing "OFF" Touch Pad does not disconnect all power to the heater.
- **BEFORE** carrying out any maintenance or cleaning, allow the heater to cool. Ashes must be disposed in a metal container with a tight lid and placed on a non-combustible surface or on the ground, well away from all combustible materials, pending final disposal.
- The exhaust system should be checked twice a year minimum for any build-up of soot or creosote. Do not touch the hot surfaces of the heater.

**Note: Canadian Comfort Industries grants no warranty, implied or stated, for the installation or maintenance of your heater, and assumes no responsibility of any consequential damage(s).**

## SAFETY TESTING

In accordance with the procedures and specifications listed in UL1482 – 1998 & ASTM E 1509-95, and ULC-S627-00 and ULC-S628-M93 for solid fuel room heater, the Canadian Comfort Industries pellet stove has been independently tested and listed by I.T.S. (an accredited testing laboratory) to UL, ULC and CSA standards. It is tested and listed for residential installation according to current national and local building codes as:

- A Freestanding Room Heater
- A hearth insert when installed into a masonry or factory built fireplace.
- A Mobile Home Heater.

The Safety Listing Label is located on the rear inspection panel for model CC1, CC2, and CC3. Please read the label carefully. It contains important information about installation and operation of your pellet appliance. Note that your STOVE'S serial number is located on the safety label. Your appliance serial number is preceded by a "WH-" (example WH-00000)

FEED RATE

4 ( ) FAN SPEED

3 ( ) HI

2 ( ) MED AUGER CYCLE

1 ( ) LOW

START FEED RATE FAN SPEED

IGNITER OFF

To START: Press START  
 Set FEED RATE to 1 or 2  
 To Turn OFF: Press OFF

Can be used with optional Wall Thermostat. See Owner's Manual for detailed instructions.

FAN Fine Tune Adjustments

# AUTOMATIC SAFETY FEATURES

## L120 LOW LIMIT SWITCH

This limit switch is mounted on the exhaust blower housing and has 2 main functions.

1. Should the fire happen to go out, for any reason, this limit switch will shut the stove off when the exhaust temperature drops below 120deg F.
2. Upon starting the appliance, the AcuTron control board has a 15 minute "Lighting Mode", if the stove exhaust does not reach 120deg F in that 15 minutes the stove will shut off. As soon as the stove exhaust does reach 120deg F, the limit switch opens and the AcuTron enters a 5 minute "Safety Delay" mode.

## F140 FAN LIMIT SWITCH

Your pellet appliance has a convection fan control limit switch. The room air fan's (F140) temperature limit snap switch automatically sets the fan on high when your stove is producing heat faster than the fan is carrying it into the room. This may occur when the heat control lever is set at [3 or 4] and the **FAN SPEED** is set to a very low or off setting. After the fan runs at this automatic high setting a few minutes, it may cycle back to its lower setting and may continue to cycle between [HIGH] and your selected setting. The circulation (room air) fan cycling from high to low is a normal condition as well as a safety feature of your appliance. To compensate for the fan cycling, adjust the FAN SPEED to a higher setting.

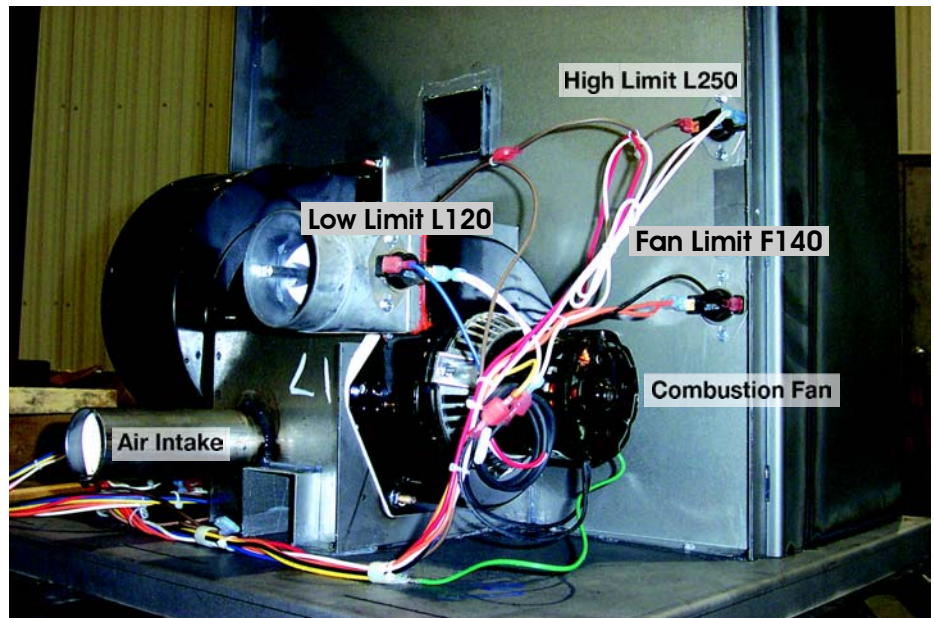

## L250 HIGH LIMIT SWITCH

Your pellet appliance has a high temperature limit switch installed. If the temperature at the back of the firebox reaches approximately 250deg F., the switch will shut off the electricity going to the Vacuum Switch and to the Auger Motor. The auger will automatically stop, and the appliance will shut down when the exhaust temperature cools (120deg F). If this happens call your dealer or Dansons Customer Service (1-866-456-9269).

**IT IS IMPORTANT TO FIND THE REASON WHY THE UNIT OVERHEATED.**

## VACUUM SWITCH

This safety device (mounted on the back panel pillar) detects vacuum in the exhaust system, firebox, and air intake. If the exhaust blower fails, the vent pipe becomes plugged, the viewing door is open, or if you are out of pellets, this switch will sense that there is a lack of vacuum and will stop the auger from continuing to feed pellets.

**If the power does go out, the pellet appliance will stop running. When the power comes back on, the stove will not restart if the switch is in the manual mode. If the exhaust temperature is above 120deg F or the switch is in the manual position, the stove will start to feed pellets again and may re-light itself.**

**NOTE:** If power outages are a concern you may wish to purchase a back-up generator system.

**For further information contact your local Specialty Retailer, Certified HVAC Service Depot, or Dansons Group Inc. Customer Service Department at 1-866-456-9269.**

# SPECIFICATIONS

## HEATING SPECIFICATIONS

- Approx. Heating capacity (Sq Feet) <sup>1</sup> = 800 – 2,000 sq ft
- Approx. Fuel burn rate per hour <sup>11</sup> = 1.75 – 5.5 lbs per hour
- Hopper Capacity VULCAN "V" Series V130 = 55 pounds
- Hopper Capacity VULCAN "V" Series V150 = 120 pounds

<sup>1</sup> Heating capacity will vary depending on floor plan layout of your home, degree of insulation, and the outside temperature. Fuel size, quality, density and moisture level will also have an effect.

<sup>11</sup> Pellet size may affect the actual rate of fuel feed and burn times. Fuel feed rates may vary by as much as 20%. Use PFI listed fuel for best results.

## DIMENSIONS

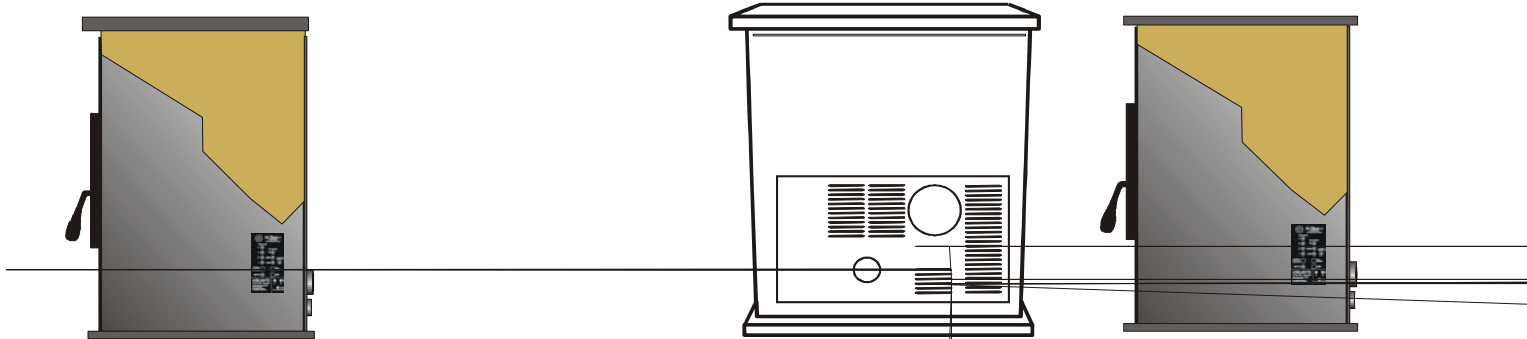

## ELECTRICAL SPECIFICATIONS

- Electrical Rating = 115 Volts 60 HZ 2.0 Amps
- Watts (operational) = 175 (approximately)
- Watts (optional igniter) = 475 (approximately)

**A voltage surge protector or ground fault outlet is required for this unit. The warranty on the circuit board will be voided if surge protection is not installed before operating this unit.**

## FUEL CONSIDERATIONS

Your VULCAN "V" Series shop and home heater, is designed to burn pellets that comply with Association of Pellet Fuel Industries standards. (Minimum of 40lbs density per cubic ft, ¼ to 5/16" diameter length no greater than 1.5", not less than 8,200 BTU's/lb, moisture under 8% by weight, ash under 1% by weight, and salt under 300 parts per million) Pellets that are soft, contain excessive amounts of loose sawdust, have been or are wet, produce clinkers and/or heavy ash will result in reduced performance and may actually cause the fire to go out. (see pelletheat.org for further information)

## EPA COMPLIANCE

This heater is exempt from EPA Phase II requirements, but has been tested for emissions using EPA test methods by Warnock Hersey, US. Pellet appliances that are designed with the combustion air supply exceeding 35:1 (by ratio) are exempt from EPA regulations.

**PRODUCT IS SUBJECT TO CHANGE WITHOUT NOTICE.**



# PLANNING & INSTALLATION CHECK LIST

Unless you are knowledgeable and experienced in stove installation, we recommend your *VULCAN "V" Series heater* receive a Pre-delivery Check and be installed by your local Specialty Retailer or Certified HVAC Service Depot.

## COMPLETE THIS CHECK LIST PRIOR TO INSTALLING YOUR PELLET APPLIANCE:

- \_\_\_\_\_ Carefully read this "Owner's Manual". **SAVE THIS MANUAL.**
- \_\_\_\_\_ Have your local Dealer **demonstrate all the operational, cleaning and maintenance steps necessary for your stove.**
- \_\_\_\_\_ **Select a location.** The design of your home and the stove placement will determine its value as a source of heat. A pellet appliance depends primarily on air circulation to disperse its heat. There are other practical considerations, which must be considered before a final placement is decided on: **Existing Chimneys, Pellet Fuel Storage, Aesthetic Considerations, Roof Design (rafter locations & roof pitch), Room Traffic, Clearances to Combustibles, and Existing Wiring.**
- \_\_\_\_\_ The installation of this appliance **must conform to local codes and applicable state and federal requirements.** Becoming familiar with these requirements **before** installation is essential.
- \_\_\_\_\_ Sign and keep a copy of the **Pre-delivery Check List** supplied by your **Authorized VULCAN "V" Series Dealer, OR "Dansons Certified Installer",** found inside our appliance or available online. Register online at [www.dansons.com/support](http://www.dansons.com/support) for Extended Warranty.
- \_\_\_\_\_ Register your purchase online at [www.dansons.com/support](http://www.dansons.com/support).

## COMPLETE THIS CHECK LIST WHILE INSTALLING YOUR PELLET APPLIANCE:

- \_\_\_\_\_ Carefully read the **ENTIRE** installation section first.
- \_\_\_\_\_ Read the Freestanding or Insert or Built-In section (which ever applies)
- \_\_\_\_\_ **Determine** the location and measurement needed your chosen location.
- \_\_\_\_\_ **Be sure to pre-fit** all items before you install, fasten or install the stove permanently. **Remember measure twice, cut once.**
- \_\_\_\_\_ **Ensure ALL** joints of "PL" vent and single wall stainless steel liner are tightly connected, **sealed with RTV Silicone, including to the exhaust connector,** and is correctly installed. (Follow vent manufacturer's instructions.)

## COMPLETE THIS CHECK LIST PRIOR TO LIGHTING YOUR FIRST FIRE:

- \_\_\_\_\_ **Obtain final inspection** and approval by local building officials.
- \_\_\_\_\_ Carefully **clean all marks off the brass, nickel or pewter parts** before the first fire is lit. Use a soft cloth and a gentle type cleaner. **Caution:** Never use an abrasive cleaner on any part of your stove.
- \_\_\_\_\_ **Polish the hopper** to remove the oil type coating used in manufacturing.
- \_\_\_\_\_ The high temp. stove paint used on your stove may take several hours of burning at a high fuel setting to fully cure. During this time an odor, which is not harmful, may be evident. The area around the stove should be well ventilated.
- \_\_\_\_\_ Review and follow the **Lighting and Controls Instructions.**
- \_\_\_\_\_ **Fill the hopper with quality pellets to prime the unit;** Using the CCI "AcuTron", (figure 5), PUSH the **FEED RATE** Touch Pad and this will start the auger and the combustion fan.  
**NOTE:** Do not attempt to light a fire at this time. Leave the **START / FEED RATE [ON]** for 2 to 5 minutes until pellets start dropping into the burn grate. Then touch the **OFF** pad to turn off system . The auger is now primed to deliver fuel to the burn grate (figure 6). Then light the stove according to the directions outlined in "LIGHTING YOUR STOVE",

# INSTALLATION OPTIONS

**READ THIS ENTIRE MANUAL BEFORE YOU INSTALL AND USE YOUR  
VULCAN "V" Series HOME & SHOP HEATER.  
FAILURE TO FOLLOW INSTRUCTIONS MAY  
RESULT IN PROPERTY DAMAGE, BODILY INJURY OR EVEN DEATH!**

(See specific installation details for clearances and other installation requirements)

The two VULCAN "V" Series products are the: "HE 55" VULCAN "V" Series 130 (figure 1), and the "HE 120" VULCAN "V" Series 150 (figure 2).. The "V-130" and "V-150" product allows you to choose from black painted, gold or pewter plated large view door and you can choose black, gold or pewter finished louvers.

All makes& models may be installed to code in both **conventional** and **mobile homes**.

## INSTALLATION OPTIONS INCLUDE:

1. A **FREESTANDING STOVE**: Set on a non-combustible floor pad.
2. A **HEARTH STOVE**: When installed on a non-combustible hearth of a masonry or factory built wood or coal burning fireplace.
3. An **ALCOVE**: When placed on a non-combustible floor pad in compliance with clearance requirements for an installation in an **alcove** (a recessed space or nook in a wall).

**V-130**  
**HE55**



**Model**  
**CC3**

Figure 1

**V-150**  
**HE120**



**Model**  
**CC2**

Figure 2



**PELLET VENT M**  
(INST)

**DO NOT CONNEC**

**DO NOT INSTALL**

**PELLET VENT T**

Must be an approved 3"  
factory built type "A" chim  
fireplace installations (fig  
above sea level.

**VENTING DISTA**

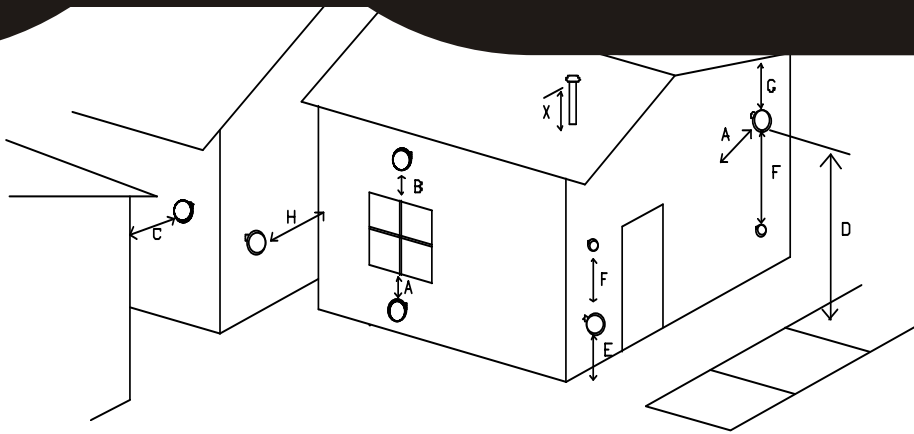

air may result

B)

**NOTE: Non-metallic material MUST NOT BE USED for outside air installations.**

A wind shield, (C), over the termination of the outside air pipe or a 90 degree elbow or away from the prevailing winds **MUST** be used when an outside air pipe is installed through a building. Keep the outside air pipe termination at least 1 foot away from the exhaust termination.

When outside air is taken from an existing chimney the exhaust system must not terminate in the same chimney.

The outside air pipe on your stove is 2" OD. The outside air connecting pipe must be at least 2" OD. The outside air connecting pipe must be as short and free of elbows as possible, and must terminate (A), not inside, the outside air pipe on your stove.

### Through The Wall Kits Include:

#### 3 FOOT PACKAGE – PART# ACFAKT03

- 1 – 2" Galvanized Hood c/w screen
- 1 – 2" Aluminum Flex Duct – compressed 15" length, extends to 30" – 36"
- 2 – 2" Worm Gear Clamps

#### 10 FOOT PACKAGE – PART# ACFAKT04

- 1 – 2" Galvanized Hood c/w screen
- 1 – 2" Aluminum Flex Duct – compressed 4' length, extends to 30" – 36"
- 2 – 2" Worm Gear Clamps

**NOTE:** Available from your local Authorized Dealer or Dansons Group Inc. 1-877-303-3134

Figure 11

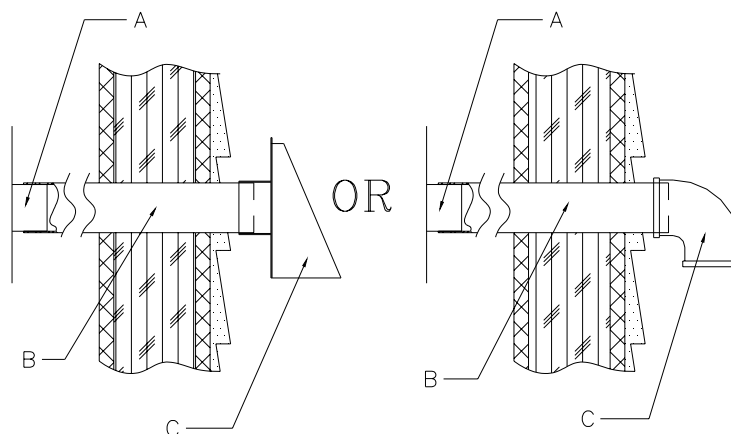

# FREESTANDING INSTALLATION

## HEATER PLACEMENT:



Stove must be placed so that no combustibles are within, or can swing within (i.e. drapes doors), 36" of the heater.



If the stove is placed in a location where the ceiling height is less than 7', it must follow the requirements in the section "Alcove Installation".

## FLOOR PROTECTION REQUIREMENTS:

Stove and floor protection must be installed on a level secure floor

The stove must be installed on a non-combustible floor protector (i.e. sheet steel with cement, tile slate) extending the full width and depth of the stove and extending 6" in front of the stove. Floor protector needs to be a minimum of 24.5" deep X 30.5" wide and be a minimum of .018" thick (26 gauge).

Must extend under and 2" to each side of chimney tee (if used).

## MINIMUM CLEARANCES TO COMBUSTIBLES

(Figures 12-17)

12" From Back Of Heater to Combustibles

10" From Front Side of Heater to Combustibles

12" From Back Corner of Heater to Combustibles

6" From Top Of Heater to Combustibles

3" From PL Vent to Combustibles

6" Non Combustible Surface In Front Of Heater  
36" to drapes, doors, anything that can swing

## CLEARANCES – "STRAIGHT INSTALLATION": THROUGH THE WALL

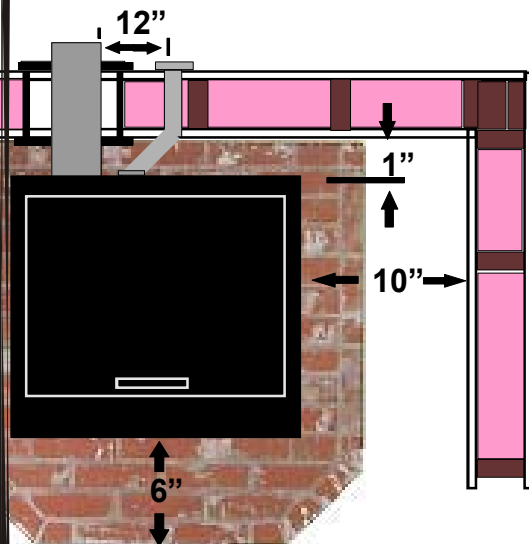

Figure 12

## INTERIOR VERTICAL

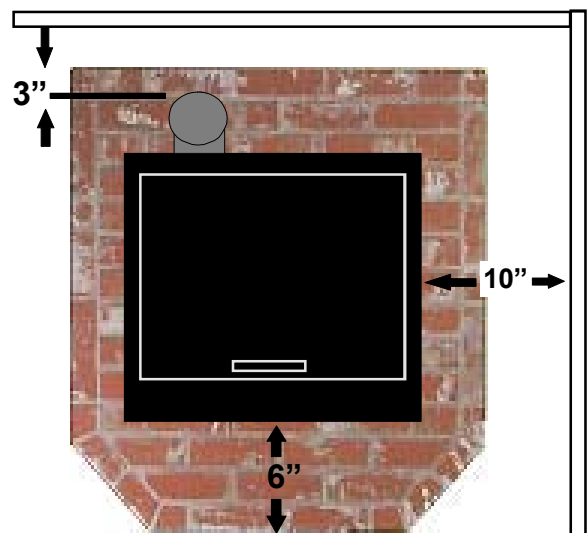

Figure 13

**FREESTANDING INSTALLATION . . . continued**  
**CLEARANCES – “CORNER INSTALLATION”:**

**45° CORNER**

**THROUGH THE WALL**

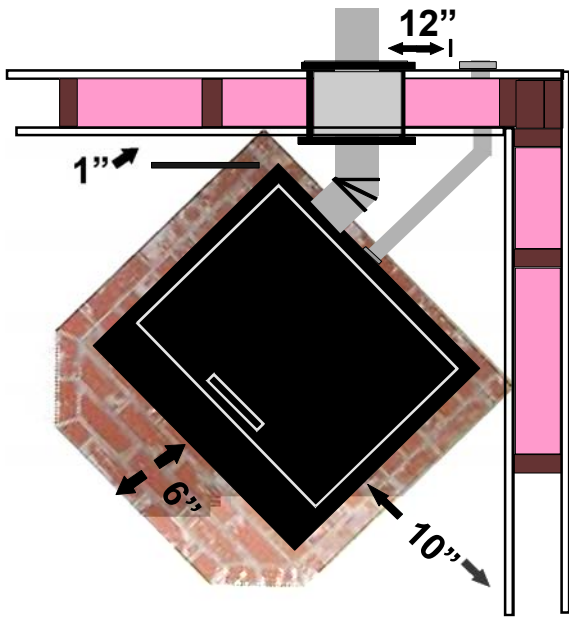

Figure 14

**45° CORNER  
 INTERIOR  
 VERTICAL**

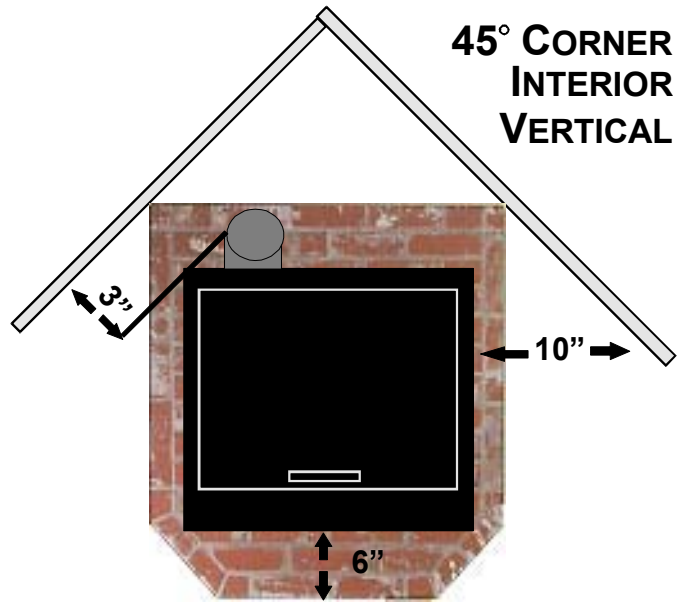

Figure 15

Note: If interior vertical vent is used, the clearance to the back wall is determined by the upward-turned elbow or “Tee”. It will vary in depth depending on the brand of PL vent used. Before placing the stove, connect the elbow or “Tee” and measure off the 3” clearance.

**ALCOVE INSTALLATION:**

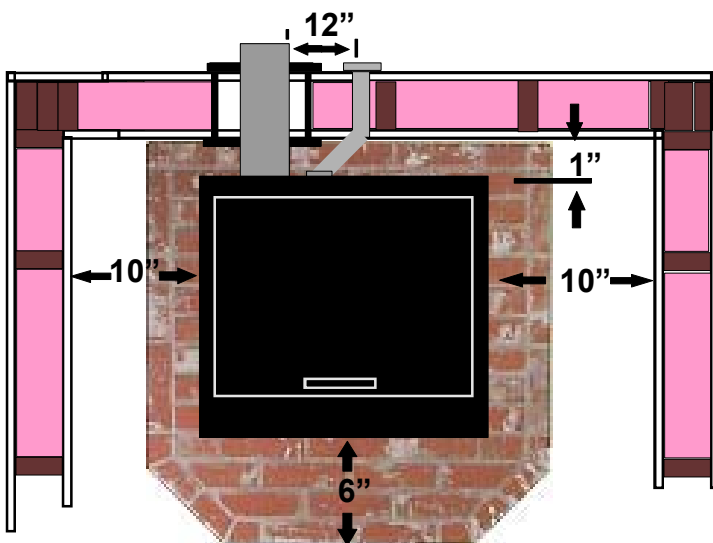

Figure 16

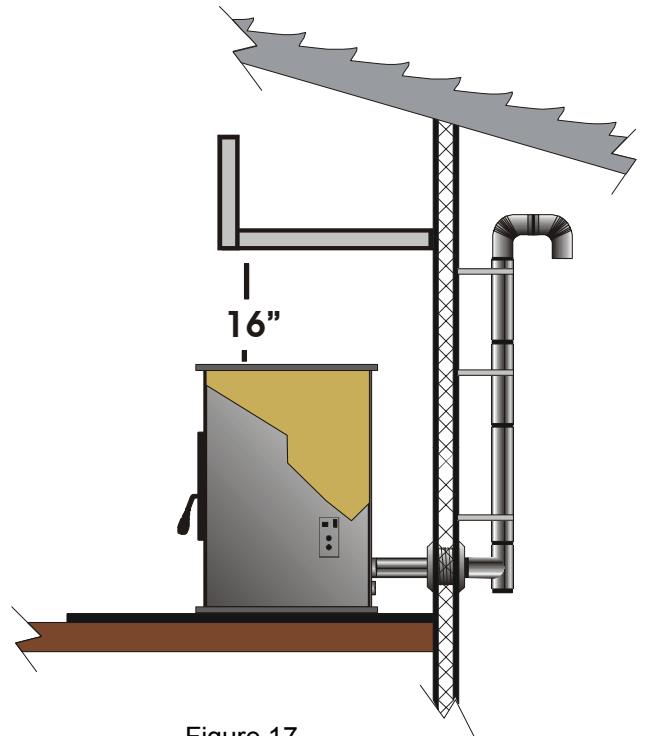

Figure 17

## FREESTANDING INSTALLATION . . . continued

### THROUGH THE WALL, DIRECT VENT INSTALLATION. (Figure 18)

1. Select the location for your stove, design the exhaust system and determine the brand and size of "PL" vent to be used.
2. Position the floor pad.
3. Following the "PL" vent manufacturer's specifications, mark and cut a hole through the wall to accommodate the wall thimble, (F), and the outside air pipe, (I), if outside air is to be used. Remember that the outside air intake must be located no closer than 12" from the vent exhaust. Try to avoid cutting wall studs, and use extreme caution to avoid cutting into power or water lines within the wall of your home.
4. Install the wall thimble, (F). Be sure to run a bead of silicone around the outside edges of the wall thimble to reduce drafts, both inside and outside. Insert the proper size of "PL" vent, (E), through the wall thimble, (F).
5. Place your stove on the floor pad, close to its final position. Leave room to connect the "PL" vent to "Quick Connect" end collar. If not already factory installed, install the gasket (B) and "Quick Connect" exhaust end (C) to your stove to the "Quick Connect" mounting plate. Use the 4 x 7/16" nuts, supplied and secure tightly.
6. Place a bead of RTV silicone around the end collar of the "Quick Connect" of your stove's exhaust, (C). Firmly push the "PL" vent pipe adaptor (J) into the bead of RTV silicone.  
**Note:** If 4" PL vent is required, use an 3" to 4" Pipe Adaptor Increaser, (J), on the stove exhaust pipe.
7. Connect the length of "PL" vent, (E), that is in the thimble, (F), onto the pipe adaptor (D). Fasten together with at least three sheet metal screws (approx. 3/8" in length). Place a bead of RTV silicone around the connection.
8. Place your stove in its final position on the pad. Place another bead of RTV silicone around the "PL" vent (E) and the inside of the wall thimble, to stop cold air drafts.
9. On the outside of the building, place an exhaust cap (G) or a 45 degree "PL" type elbow, (G), onto the end of the horizontal "PL" vent, (E). Optionally, place a rodent screen cap, (G), (may be required in some locals), on the end of the elbow, (G). Secure all connections using 3 sheet metal screws and run a bead of RTV silicone around all connections and around the "PL" vent pipe and the outside of the wall thimble.

**Note:** The end of the exhaust pipe must extend a minimum of 12" from the outside of the building.

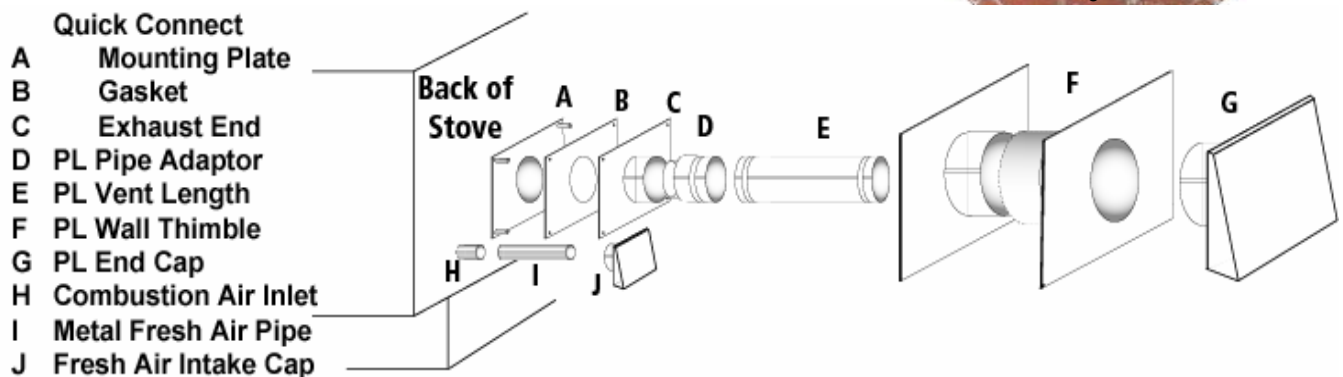
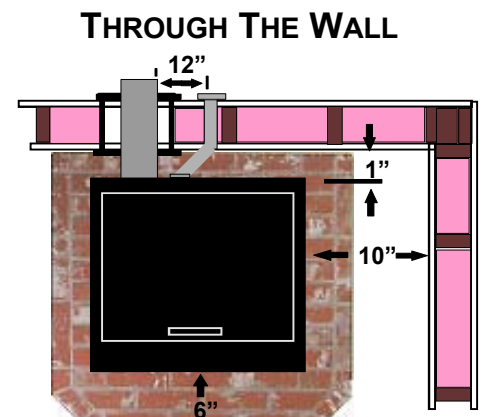

**NOTE:** Some horizontal, through the wall installations may require a Clean-Out Tee and a minimum 3' vertical rise of pipe inside or outside the building to help draft the stove. This is required if a proper burn cannot be maintained, after the stove has been tested and the airflow set. This is due to backpressure in the exhaust, caused by the airflow around the house.







## FREESTANDING INSTALLATION . . . continued

### VERTICAL INSTALLATIONS: (Figures 19 - 24)

Your stove may be installed using many different vertical designs. Follow the same basic steps in locating your stove, attaching the exhaust system and outside air intake to your stove as described in "**THROUGH THE WALL – DIRECT INSTALLATION**" and the "PL" vent manufacturer's procedures for installing through a wall, ceiling, eave and roof.

### COMMON, (but not inclusive), VERTICAL INSTALLATION DESIGNS ARE:

-  **VERTICAL, THROUGH THE CEILING**, through another room or space, or attic, then through the roof, terminating with a rain cap. Figure 19.
-  **VERTICAL, UP TO AN EXISTING CLASS A CHIMNEY OR MASONRY CHIMNEY**. An appropriately sized adapter will be needed when connecting onto either a Class A or into a masonry chimney. NOTE: The connection into a masonry chimney must be airtight. Figures 20, 21, and 23.
-  **HORIZONTAL, OUT THE WALL, THEN VERTICAL** to a minimum of 5 feet, into a 90-degree elbow and terminating with a 45-degree elbow pointed downward. Figure 22.
-  **HORIZONTAL, OUT THE WALL, THEN VERTICAL THROUGH THE EAVES**, then the roof, terminating with a rain cap. Figure 24.

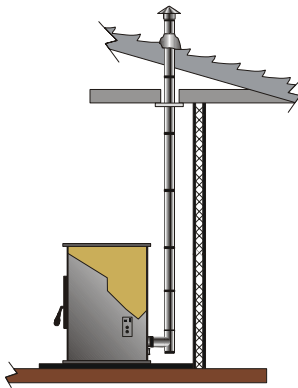

Figure 19

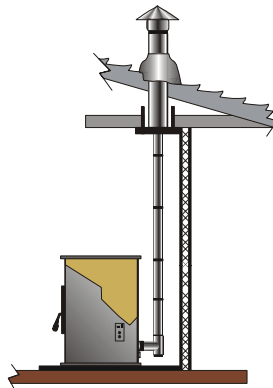

Figure 20

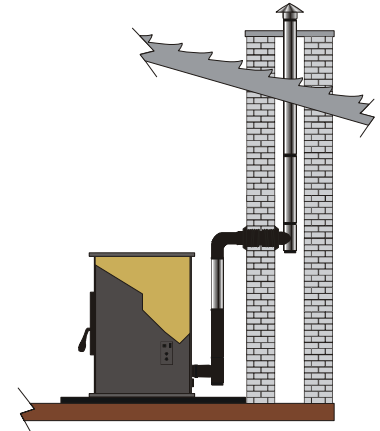

Figure 21

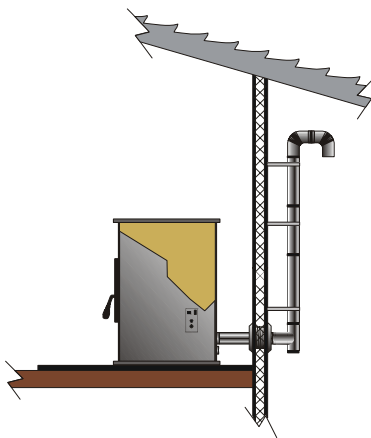

Figure 22

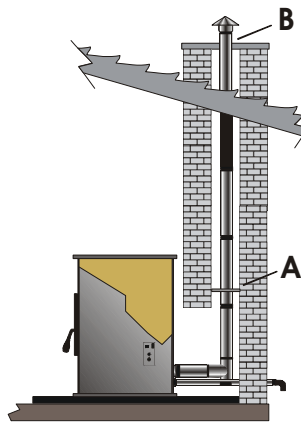

Figure 23

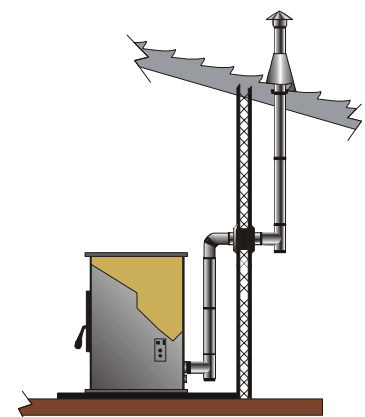

Figure 24

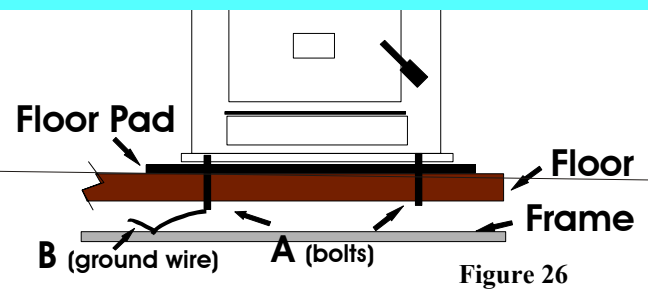

Figure 26

Mobile Home, all exterior venting must be removed while Mobile Home is of relocation all venting must be reinstalled and securely fastened.

# LIGHTING YOUR STOVE

Before lighting a fire check to ensure the Burn Grate is clean and adjusted and the Ash Tray is not full.  
**For safety reasons use extra caution when lighting a stove that is HOT!**

## Lighting stove manually (No Igniter) In the NON-Thermostat Mode

1. Push firmly on the **FEED RATE** or **START** touch pad.
  - The **COMBUSTION FAN** (exhaust) will start and operate at full speed for 60 seconds, then adjust downward to match feed rate #1
  - The **CONVECTION FAN** (heating) will start and the LED will go solid on LOW setting
  - The **AUGER CYCLE** LED will go solid for 3 seconds, indicating signal being sent to auger motor.
2. Place a small amount of a solid fuel fire starter, such as those made from sawdust and wax or use wood shavings, in the bottom of the burn grate.  
Add a small handful of pellets to the starter material.  
Add a small amount of fire starter over the pellets.

**CAUTION: DO NOT USE ANY FLAMMABLE LIQUIDS SUCH AS GASOLINE, GASOLINE-TYPE LANTERN FUEL, KEROSENE, CHARCOAL LIGHTER FLUID, OR SIMILAR LIQUIDS TO START OR FRESHEN-UP THE FIRE! KEEP ALL SUCH LIQUIDS WELL AWAY FROM THE HEATER WHILE IT IS IN USE.**

3. Light the fire starter and slowly close the **MAIN DOOR**, leaving it about 1 inch open. When the pellets are burning, close and latch the main door. If the fire goes out when the main door is closed, add more fire starter, re-light the fire and leave the main door open an inch or so until the pellets start to burn, then close and latch the main door.
4. Adjust the **FUEL RATE** and the **FAN SPEED** to your desired settings you require upon completion of startup sequence.

**NOTE:** If the fire does not start, your stove will continue to feed pellets and the fans will run for approximately 15 minutes. The stove will then automatically shut off. If this happens, some unburned pellets will build up in the burn grate. To restart the fire, clean the excess pellets out of the burn grate and follow the above "Lighting a Fire".

**NOTE:** Some odors may be given off a new stove during the initial few hours of burning while the stove and the paint are being cured. These odors are not harmful. However, ventilating the room until the odors disappear is strongly recommended.

## Lighting stove with Auto-Igniter In the NON-Thermostat Mode

1. Push firmly on the **FEED RATE** or **START** touch pad.
  - The **COMBUSTION FAN** (exhaust) will start and operate at full speed for 60 seconds, then adjust downward to match feed rate #1
  - The **CONVECTION FAN** (heating) will start and the LED will go solid on LOW setting
  - The **AUGER CYCLE** LED will go solid for 3 seconds, indicating signal being sent to auger motor.
  - The **IGNITER** LED will light up solid and the 300 watt igniter will begin to operate.
2. On a primed **AUGER** system pellets will begin to fall into the **BURN GRATE**, and the **AUTO SELF IGNITER** will automatically ignite the pellets in approx. 3 – 5 min.  
**Note: If stoves fails to light within 15 minutes, shut off the stove, remove the pellets from the burn grate and repeat step 2. If stove fails to ignite a second time, disconnect and contact your dealer.**
3. Adjust the **FUEL RATE** and the **FAN SPEED** to your desired settings you require upon completion of startup sequence.

**CAUTION: Never use liquid or volatile fire starters to start a fire in your stove!** Do not install or operate your stove in any room where any liquid or volatile fuels or any other highly combustible items are in the air or stored in the room. These could cause a safety hazard.

- **IGNITER** and **IGNITER LED** will turn off
- **FEED RATE LED** will become solid and the appliance will feed fuel at your selected heat output

### **RE-START (MANUAL OR NON-THERMOSTAT MODE)**

The AcuTron II or III board does have limited memory. To restart your appliance push the **START** touch pad. The appliance will automatically go through it normal start-up then return to the **FEED** and **FAN** setting you used prior to turning off the board and appliance the last time of use.

## THE CONTROLS ... CONTINUED

### TRIM POTS (Fine Tune Adjustments)– Factory Settings

The **COMBUSTION FAN (FAN)**, **HI (4)** and **LO (1) FEED RATE trim pots** have been preset at the factory, but may need to be adjusted onsite after your installation is complete. Due to different installation setups, length and size of venting, and pellet fuel quality, the preset from the factory will not always be correct. These settings will accommodate virtually all wood pellet fuels.

**FUEL FEED rates** at the Lowest (number 1) and highest (number 4) settings can be adjusted by adjusting the fine tune trim pots located on the control panel. To **raise fuel feed** turn trim pot **counter clockwise** and to **lower** turn **clockwise**. To assist in knowing what the change is you should note the amount of time the light on the **AUGER CYCLE LED** stays OFF. (Note: *The light stays on when ever the fuel feed motor, AUGER CYCLE, is running*). **Lengthening the time this LED stays OFF lowers the fuel feed and shortening the off-time increases the fuel feed.**

### COMBUSTION FAN SPEED (FAN)

In a few instances because of prevailing conditions pertinent to your specific installation, or even different batches of pellet fuel, the **COMBUSTION FAN SPEED** may be adjusted to raise or lower the amount of air moving through the grate for the cleanest burn. The FAN speed can be adjusted by adjusting the **FAN** trim pot **COUNTER CLOCKWISE to INCREASE** the speed and **CLOCKWISE to DECREASE** the speed of the combustion fan.

Note: If you attempt to adjust the Fuel Feed Trim Pots, use a small precision screwdriver.  
The Trim Pots do not make a full rotation.  
If using a metal screwdriver, be gentle as the plastic trim pot slot can be damaged or stripped.

### FAN SPEED (Convection or heating)

The **FAN SPEED** controls the speed of the room air fan. This fan blows room air through the heat exchange tubes and back into the room. The FAN SPEED has 5 different speeds, these are controlled by pushing the FAN SPEED touch pad. The Low LED will be solid when on the lowest fan speed, the LOW & MED will both be solid when the next highest speed is selected and so on. When the **FEED RATE** is set to a higher position, the **FAN SPEED** should be set higher and visa versa. When the **FEED RATE** is set at [3 OR 4] set the **FAN SPEED** to [MED/HIGH]. If you forget, the room air fan's (L140) temperature limit snap switch automatically sets the fan on high when your stove is producing heat faster than the fan is carrying it into the room. This may occur when the heat control lever is set at [3 or 4] and the **FAN SPEED** is set to a very low or off setting. After the fan runs at this automatic high setting a few minutes, it may cycle back to its lower setting and may continue to cycle between [HIGH ] and your selected setting. The circulation (room air) fan cycling from high to low is a normal condition, as well as a safety feature of your appliance.

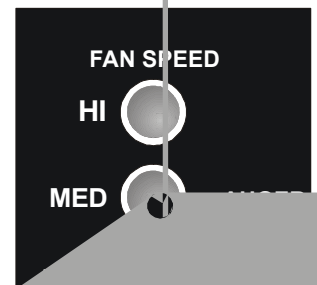

### AUGER CYCLE

The **AUGER CYCLE LED** indicates when a electrical signal is being sent to the auger motor. This LED is NOT used to indicate the actual movement of the auger. When the signal is sent, the LED will be solid for 3 seconds. When the LED is off no signal is being sent.

## SHUTTING

**Note:** DO NOT UNPLUG your stove from the wall outlet when the stove is running. This will cause the stove to shut off and the pellets to fall into the room. Remember the FAN SPEED setting.

On the CCI "AcuTron" Burner, the auger motor will turn off. The auger motor will turn off when the stove is in "Down" mode. The auger motor will automatically turn off when the stove is in "Down" mode.

Copyright ©  
C...









# PELLET FUEL

The performance of your pellet appliance is greatly affected by the type and quality of wood pellets burned. As the heat output of various quality wood pellets differ, so will the performance and heat output of your appliance.

## PELLET QUALITY

Your VULCAN "V" Series stove, with its standard "Super Grate", is designed to burn PFII, "Premium" or "Standard" quality wood pellets. Pellets that are soft, contain excessive amounts of loose sawdust, have been or are wet, produce clinkers and/or heavy ash will result in reduced performance and may actually cause the fire to go out.

## PELLET CONSUMPTION

Fuel consumption will vary somewhat between fuel brands and stoves. The following "**ROUGH GUIDE**" to pellet usage's may be useful in assessing your stove's operation, in ordering fuel and in providing information to your Authorized VULCAN "V" Series Dealer.

### Fuel Rate Setting...

Setting	Approximate Burn Time on		Amount of pellets burned
	120 lb. hopper	55 lb. hopper	
1	40 – 80 hours	35 – 22 hours	1.50 to 3.00 lbs. Per hour
2	35 – 48 hours	22 – 12 hours	2.50 to 3.50 lbs. Per hour
3	27 – 35 hours	12 – 15 hours	3.50 to 4.50 lbs. Per hour
4	22 – 30 hours	10 – 14 hours	4.00 to 5.50 lbs. Per hour

\* Fuel flow and burn times quoted are approximate. And may vary with type of fuel used.

## FACTORS EFFECTING PELLET FEED RATES

Generally, the smaller, harder and cleaner, free from fines the pellets are the faster they will feed at a given setting and visa versa. The extremes in pellet size and quality can cause several hours difference in burning time for a 40 pound bag of pellets. Heat production is directly related to the pounds of fuel burned per hour. As fuel consumption goes down so will heat output and visa versa. Pellet feed rate, at the same fuel settings, may vary greatly from brand to brand and may vary somewhat from batch to batch within the same brand.

## FINE TUNING THE PELLET FEED RATES

If the fire goes out at the LO (# 1) setting the pellets being used may not be feeding fast enough. Likewise if the fire is too high, i.e. burning fuel at the LO (# 1) setting the pellets being used may be feeding too fast. The fuel feed rate for each setting may be increased or decreased somewhat to accommodate different pellets

**NOTE:** Fine tuning the feed rates beyond the fuel settings provided, involves technical adjustments that you may wish to have performed by an **Authorized VULCAN "V" Series Dealer**. There may be a service charge for these adjustments.

## ASH and CLINKERS

Ash is a by-product of all pellets. Clinkers may be produced from some pellets and not from others. High quality pellets will produce less ash and fewer clinkers than lower quality pellets.

**ASH** is a natural product of burning wood. As the amount of ash in the wood increases the amount of ash left after burning high ash wood pellets will increase.

## ASH AND CLINKERS .... CONTINUED

**CLINKERS** are those solid, glassy or porous accumulations that may result from burning some types of wood pellets. Clinkers are formed in the bottom of the burn grate and if left undisturbed will accumulate and shut off the combustion air. As clinkers grow and shut off combustion air the fire becomes orange/brown and lazy. Pellets may build up in the burn grate. The firebox and window becomes sooty. Exhaust gases may become smoky.

*VULCAN "V" Series* heaters come complete with the "Super Grate" burn grate. This grate reduces the amount of clinkers formed by lower quality pellets. If ashes are quickly blown out of the grate they cannot easily stay in one spot, heat up to the melting point and fuse into a clinker. Clinkers form when pellets are of such poor quality their ashes contain minerals that easily melt under high firebox temperatures, are not blown out of the grate, and stay there until larger and larger clinkers are produced.

Since wood and the methods of handling wood used in making pellets can vary from plant to plant and year to year some clinking must always be expected. Stove owners without an "SUPER" grate must remove clinkers manually, some times several times a day. Stove owners using an "SUPER" grate and quality pellets may experience days or even weeks of burning without the need to remove any clinkers from the grate.

## FINES

**FINES** in pellets are pieces of sawdust that were not properly formed or are the results of pellets breaking down from handling, transporting and/or storage. Fines adversely affect the operations and heat production of a pellet shop and home heater and greatly increase the requirements for daily and periodic cleaning. Fines cause pellets to feed slower thus reducing the amount of heat produced at any given heat control setting.

**NOTE:** It is much easier to remove fines from pellets before they are placed in the stove than it is to service your stove for a plugged hopper, jammed auger and plugged exhaust system. Pellets with excessive sawdust may be screened to remove most of the fines. Pellet screeners may be built or purchased from most pellet stove Dealers.

## PFI PELLET STANDARDS

The Pellet Fuel Institute, standards for residential quality pellets are:

Length	1.5 inches, maximum.
Diameter	.235 to .350 inches, (approx. 1/4" to 3/8").
Fines:	.2# maximum per 40# bag.
Salts:	.005 % by weight, maximum.
Ash Content:	
- Premium Quality	.75% by weight, maximum, (.3# per 40# of pellets.)
- Standard Quality	2.5% by weight, maximum, (1# per 40# of pellets.)

Check with your Authorized *VULCAN "V" Series* Dealer on the quality of pellets in your local area and for information on what can be expected from the various local brands.

**NOTE:** Since Dansons Group Inc. or Canadian Comfort Industries has no control over the quality of pellets that you use, we assume no liability caused by the quality of wood pellets used.

# REQUIRED ROUTINE CLEANING

Proper care of your **VULCAN "V" Series** pellet shop and home heater is required for peak, sustained performance. The need for and frequency of cleaning depends on the amount of pellets burned, pellet quality, length of time since last cleaning and the quality of the fire. While becoming acquainted with your new stove and the types of local pellets, **inspect your BURN GRATE, BURN POT, HEAT TUBES, ASH PIT, and WINDOW daily and clean until a pattern of cleaning requirement is determined.** As heating demands increase the need for stove and exhaust system cleaning and ash removal will increase.

**WARNING:** Disconnect the electrical cord prior to opening the sides of your stove or opening the exhaust system for any inspection, cleaning, maintenance or service work. **NEVER** perform any inspection, cleaning, maintenance or service on a **HOT STOVE** or when the electrical cord is plugged in.

## EVERY 2 –3 DAYS / WEEKLY

 **BURN GRATE:** [COLD STOVE ONLY] Clean as needed, scraping off any residue that may stick to grate bottom or sides. Ensure that the holes are clean and unrestricted. **CAUTION:** When replacing the grate make sure it fits properly in the burn pot with the lip on the burn grate, toward the front of your stove.

 **BURN POT:** [COLD STOVE ONLY] Remove the burn grate. Clean out the burn pot as needed. Do not push the fly ash to the back of the pot, as this will restrict the air flow and performance of the appliance.

 **HEAT TUBES:** [COLD STOVE ONLY} With your stove's main door closed pull the **HEAT TUBE SCRAPER ROD** forward and backwards a few times. As different types of pellets produce different amounts of ash, cleaning the tubes enables the heat exchange to operate efficiently. **CAUTION:** On a burning stove the heat tube scraper rod will be hot.

 **ASH PIT:** Monitor the ash level on a weekly basis. Ash content is a good indication of fuel efficiency and quality. Refer to "Safety Precaution" for safe disposal of ashes.

 **WINDOW CLEANING:** [COLD STOVE ONLY as hot glass may cause serious burns] To enjoy a clear view of the fire you should clean your window as needed with a soft cloth or paper towel. You may use a glass cleaner to remove heavy build up on the window. **HOME TIP:** Dampen a piece of newsprint with water, dip this into the fly ash, then rub down the glass. This works like a charm. Do not use abrasive chemical cleaners

**DO NOT OPERATE STOVE WITH BROKEN GLASS AS LEAKAGE OF FLUE GASES MAY RESULT.**

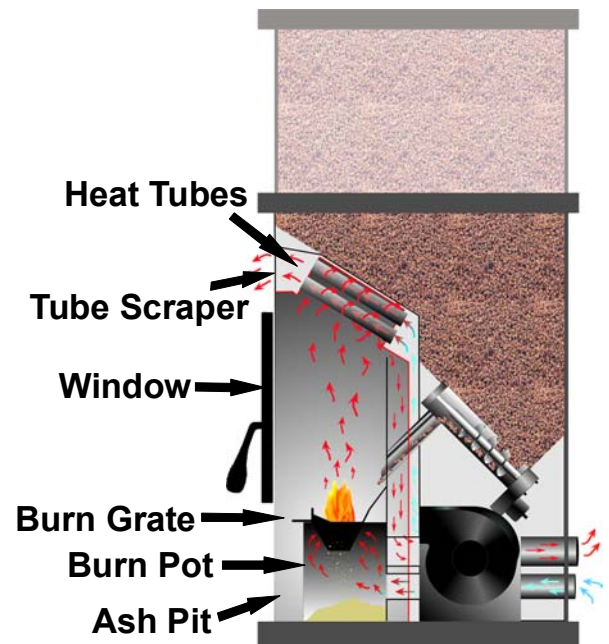

# CLEANING YOUR SUPER GRATE

## INSERTING, REMOVING & ADJUSTING THE BURN GRATE

The burn grate top, (D), must fit and seal firmly on the upper lips, of the burn box, (A). An improper seal will allow incoming combustion air to escape, not passing up through the burn grate thus reducing the amount of combustion air in the area needed to efficiently burn pellets.

- A Burn Box
  - Combustion air is brought into the backside and through the burn grate bottom, back and front
  - Check periodically for fly ash build up
- B "SUPER GRATE"
  - Stainless steel construction, slotted bottom and air holes on front and back
  - Slotted hole for Igniter air flow
- C Adjustment Tab
  - Used to fine tune and level burn grate
- D Super Grate Upper Lip

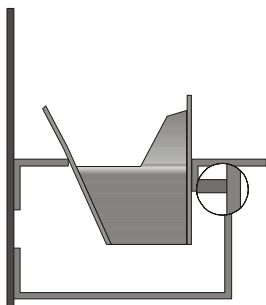
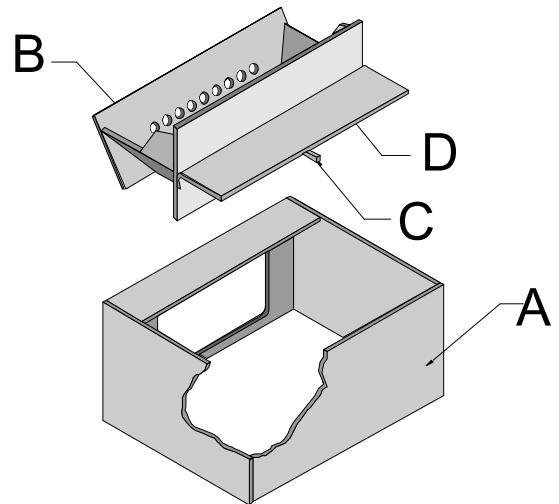

Adjust the burn grate top so that the burn grate top sits firmly on the top of the burn box and level.

### Removal of burn grate top:

- (1) Lift upward while sliding lip out from under lip of slide
- (2) Then pull out toward outside of burn box
- (3) Installation is reverse of this.

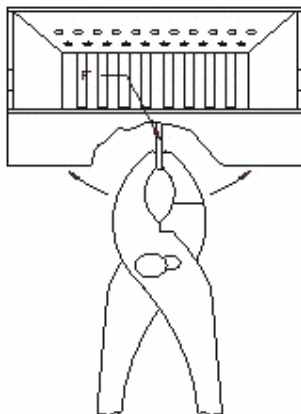
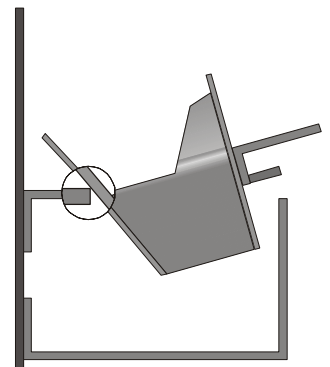

Grasp the burn grate adjustment tab, with a pair of pliers and bend it slightly to left or right (and re-install into burn box) until its length allows the burn grate top to rest tightly onto the burn grate bottom

# PERIODIC MAINTENANCE

## SOOT - FLY ASH:

The by products of combustion contain small particles of fly ash. Fly ash will collect in the exhaust venting system and restrict the flow of flue gases. Incomplete combustion, (such as during startup) shutdown or incorrect operation of the room heater will lead to some sort of soot formation which will collect in the exhaust system. Because of this it is important that the exhaust system be **inspected and cleaned at least once a year to determine if cleaning is needed. It is a good practice to inspect after every 1–2 tons of pellet fuel burning.**

With proper cleaning and the use of quality pellets, your **VULCAN F22 appliance** requires very little maintenance. However, **the following periodic maintenance is strongly recommended.** This should be performed seasonally, bi-seasonally, or every 1-2 tons of fuel usage.

**WARNING:** Unplug your stove's electrical cord prior to opening the sides of the stove or opening the exhaust system for any inspection, cleaning, maintenance or service work.

**NEVER** perform any inspections, cleaning, maintenance or service on a HOT STOVE.

 **ASH TRAPS: [COLD STOVE ONLY]** Remove the back plate from the firebox area. This will expose the two ash traps and the fuel drop shute. Fly ash may be removed by vacuuming inside the trap areas. It is also good to use a brush (bottle cleaner) to reach up and down to scrape the build up off the metal areas.

 **BURN GRATE:** Periodically remove and clean your grate. In particular it is advisable to clean out the holes to remove any build up that may prevent air from moving through grate freely. If grate has become plugged with hard residue from burning lower quality fuel, you may need to use a sharp awl or drill bit to open holes back to their original size.

 **BURN POT:** This is the “pot” where the pellets are burned in the grate. When removing your grate for cleaning, check the burn pot area for ash build up. Some ash will fall through the grate holes and build up under the grate. This needs to be cleaned out to prevent lack of air flow through the burn grate.

 **DOOR GASKET:** Inspect the main door gasket periodically. The main door may be removed to have frayed, broken or compacted gaskets replaced by your Authorized **VULCAN F22 Dealer**.

 **FAN MOTORS:** Clean the in-take on CONVECTION (ROOM AIR) fan as well as the air holes on the motors of both COMBUSTION and CONVECTION fans annually. Disassemble the COMBUSTION AIR FAN and clean out the internal fan blades as part of your fall start up.

 **FRESH AIR INTAKE:** Inspect periodically to be sure that it is not clogged with any foreign materials. A plugged screen will restrict or shut off combustion air and cause a fire to die or burn poorly.

 **GOLD / BRASS / NICKEL /PEWTER TRIM CLEANING:** Use a damp cloth to clean your door. **DO NOT USE ANY ABRASIVE CLEANERS AS YOU WILL REMOVE OR SCRATCH THE PLATING!**

 **CHECK AND CLEAN THE HOPPER:**  
Check the hopper periodically to determine if there is any sawdust or pellets that are sticking to the hopper surface. Clean as needed.

 **GLASS (High Temp, Neo-Ceram):** We recommend using a high quality glass cleaner. Should a build up of creosote or carbon accumulate you may wish to use 000 steel wool and water to clean glass. Ceramic is very hard and will not scratch from the steel wool.

 **GLASS REPLACEMENT:** In the event you need replacement only Neo-Ceram of the correct size and thickness may be used. Contact your local **VULCAN F22** dealer to obtain this glass.  
**DO NOT OPERATE STOVE WITH BROKEN GLASS AS LEAKAGE OF FLUE GASES MAY RESULT.**

## PERIODIC MAINTENANCE ... CONTINUED

**INSPECT AND CLEAN THE CHIMNEY:** [ELECTRICAL CORD UNPLUGGED] Under some conditions fly ash build up in the chimney system may occur rapidly. The fly ash will collect in the exhaust venting system and restrict the flow of the flue gases. Incomplete combustion, such as occurs during startup, shutdown, or incorrect operation of the room heater will lead to some soot formation which will collect in the exhaust venting system. Check the clean out tees and elbows in the exhaust system periodically to determine the cleaning schedule. To remove dust from the vent pipe, tap lightly on the pipe to dislodge any loose ash. Open the bottom of the "T" to dump the ash, then vacuum as much of the ash out of the vent pipe as possible. 3 or 4-inch chimney brushes are available for chimney cleaning. If the exhaust system has a screen on it, frequently clean the screen. A plugged screen will shut off combustion air and cause a fire to die or burn poorly.

**PAINTED SURFACES:** Painted surfaces may be wiped down with a damp cloth. If scratches appear or you wish to renew your paint, contact your Dealer to obtain a can of Satin Black ("Stove Bright") paint.  
**Tip: use a hair dryer to warm the surface prior to touching up the paint, this helps to reduce paint runs.**

**Note: Do not use any other brand than "Stove Bright" as they may not be compatible.**

**FALL START UP:** Prior to lighting the first fire check the outside area around the exhaust and air intake systems for obstructions. Clean the screens on the exhaust system and the outside air intake pipe. Turn all controls on to make sure they are working prior to lighting the first fire. Clean and remove fly ash from exhaust venting. Your local Authorized Dealer should have 3" and 4" chimney brushes available. This is also a good time to give the entire stove a good cleaning throughout.

**SPRING SHUTDOWN:** [COLD STOVE AND COLD ASHES ONLY]. After the last burn in the spring remove pellets from the hopper and the auger. Scoop out the pellets then run the auger until the hopper is empty and pellets stop flowing. Vacuum out the hopper. Thoroughly clean the burn grate, burn box, ashtray and ash traps. It's desirable to spray the inside of the cleaned hopper with an aerosol silicone spray if your stove is in a high humidity area. The **exhaust system** should be thoroughly cleaned.

**YEARLY SERVICING:** A yearly servicing and cleaning by your Authorized **VULCAN F22** Dealer is recommended. A fee may be charged for this service.

Figure 30

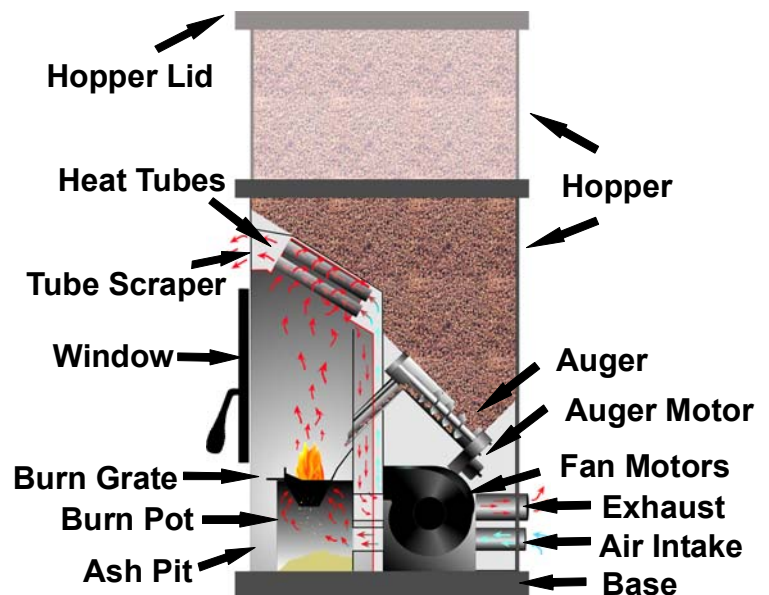

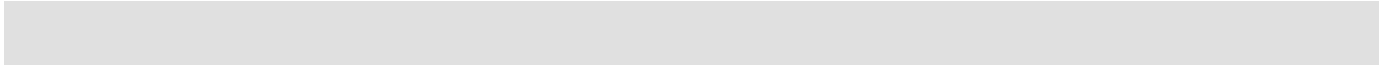

# LIMITED WARRANTY

The *VULCAN "V" Series* wood pellet shop and home heater, carries a **five (5)** year limited warranty from the date of sale to the original owner against defects and workmanship on all steel parts, (excluding the burn grate), and **one (1)** year on electrical components. There specifically is no warranty on the paint, glass, burn grate, and all gaskets or against damage caused from corrosion.

## Extended Warranty

Canadian Comfort Industries will offer an additional **one (1)** year limited warranty on electrical component parts, when your V Series wood pellet appliance is installed by a "**Dansons Certified Installer**" or **NFI (National Fireplace Institute) Certified Installer**.

To qualify for this extended warranty the unit must be installed by a "Dansons Certified Installer" and the "**Pre-Delivery & Install Check List**" form must be filled out and received at Canadian Comfort Industries

Fax 1-780-960-0430 or online at [www.dansons.com/support](http://www.dansons.com/support)

**There is no written or implied performance warranty on *VULCAN "V" Series* home and shop heaters as the manufacturer has no control over the installation, operations, cleaning, maintenance or the type of fuel burned.**

This limited warranty will not apply if your stove has not been installed, operated, cleaned and maintained in strict accordance with the manufacturer's instructions. Burning other than quality wood pellets may void the warranty. The warranty does not cover damage or breakage due to misuse, improper handling or modifications.

Your purchase must be registered with **CANADIAN COMFORT INDUSTRIES, INC.** This can be done online at [www.dansons.com/support](http://www.dansons.com/support).

**All claims under this limited warranty must be made through the dealer where your heater was purchased.** If an inspection by the dealer indicates that a limited warranty claim is justified, and all conditions of this limited warranty have been met, the manufacturer's total responsibilities and liabilities shall be to repair or replace, at the manufacturer's option, the defective part(s). All costs of removal, shipment to and from the dealer or manufacturer, any losses during shipment and reinstallation, and any other losses due to your stove being removed, shall be covered by the owner of the stove.

**NEITHER THE MANUFACTURER, NOR THE SUPPLIERS TO THE PURCHASER, ACCEPTS RESPONSIBILITY, LEGAL OR OTHERWISE, FOR THE INCIDENTAL OR CONSEQUENTIAL DAMAGE TO THE PROPERTY OR PERSONS RESULTING FROM THE USE OF THIS PRODUCT. ANY WARRANTY IMPLIED BY LAW, INCLUDING BUT NOT LIMITED TO IMPLIED WARRANTIES OF MERCHANTABILITY OR FITNESS, SHALL BE LIMITED TO ONE (1) YEAR FROM THE DATE OF ORIGINAL PURCHASE. WHETHER A CLAIM IS MADE AGAINST THE MANUFACTURER BASED ON THE BREACH OF THIS WARRANTY OR ANY OTHER TYPE OF WARRANTY EXPRESSED OR IMPLIED BY LAW, MANUFACTURER SHALL IN NO EVENT BE LIABLE FOR ANY SPECIAL, INDIRECT, CONSEQUENTIAL OR OTHER DAMAGES OF ANY NATURE WHATSOEVER IN EXCESS OF THE ORIGINAL PURCHASE PRICE OF THIS PRODUCT. ALL WARRANTIES BY MANUFACTURER ARE SET FORTH HEREIN AND NO CLAIM SHALL BE MADE AGAINST MANUFACTURER ON ANY ORAL WARRANTY OR REPRESENTATION.**

Some states do not allow the exclusion or limitation of incidental or consequential damages, or limitations of implied warranties, so the limitations or exclusions set forth in this limited warranty may not apply to you. This limited warranty gives you specific legal rights and you may have other rights, which vary from state to state.



# APPENDIX "A"

## OPTIONAL ACCESSORIES

CONTACT YOUR VULCAN "V" Series DEALER FOR MORE INFORMATION OR TO ORDER.

PRODUCT	PART NUMBER
<b>Acu-Tron Wall Thermostat Kit – Can.</b> Includes: Thermostat module, wall thermostat, and 25' 18 gauge bell wire - Celsius	<b>ACWTKTC</b>
<b>Acu-Tron Wall Thermostat Kit – USA</b> Includes: Thermostat module, wall thermostat, and 25' 18 gauge bell wire – Fahrenheit	<b>ACWTKTF</b>
<b>Small View Shop Door Assembly – Black</b> - large pin	<b>AHDRBAS</b>
<b>Large View Door Assembly – Black</b>	<b>ACDRBAS</b>
<b>Large View Door Assembly – Gold Trim</b>	<b>ACDRGAS</b>
<b>Fresh Air Kit – M/F</b> 3' x 2" alum duct, hood, and 2 gear clamps	<b>ACFAKT3</b>
<b>Fresh Air Kit – Basement</b> 10' x 2" alum duct, hood, and 2 gear clamps	<b>ACFAKT10</b>
<b>300 Watt Auto-Igniter Assembly</b>	<b>AHIGNAS</b>
<b>Log Set – Handcrafted 1pc. Stainless Steel</b>	<b>ACLOGCL1</b>
<b>Wall Thermostat – Canadian version</b>	<b>ACWTC</b>
<b>Wall Thermostat – USA version</b>	<b>ACWTF</b>

# APPENDIX "B"

## REPLACEMENT PARTS

<b>Assembly Packages</b>	
Auger Motor	<b>ACAMTRAS</b>
- includes (1) 2.1 RPM Gear Motor, (1) Auger Motor Bracket w/screws	
Auger Shaft	<b>ACAUSHAS</b>
- includes: shaft and flighting	
Combustion Fan	<b>ACCBFNAS</b>
- includes: (1) Draft Induction Fan, (1) Aluminum Adapter w/screws, (1) 1/8" Fibreglass	
Convection Fan	<b>ACCVFNAS</b>
- includes (1) Centrifugal Blower, (1) 1/8" Fibreglass Paper Gasket	
Igniter	<b>ACIGNAS</b>
- includes (1) 300 watt Ceramic Igniter, (1) igniter Tube Assembly	
<b>Body Panels</b>	
Right Side CC JR/Franklin Panel	<b>MHJRP</b>
Right Side CC SR Panel	<b>MHSRP</b>
Left Side CC JR/Franklin Panel	<b>MHJLP</b>
Left Side SR Panel	<b>MHJLP</b>
Hopper Lid	<b>MHHOPL</b>
Back Side Slotted Stove Panel	<b>MHBSLP</b>
Ash Compartment Cover	<b>MHACC</b>
<b>Control Panels - Complete</b>	
CCI100 - Start Button, Fuel Feed	<b>AHC100CAS</b>
CCIAT - Acutron Digital Board	<b>ACCATCAS</b>
<b>Door Assembly</b>	
Door c/w neo-ceramic glass, Small View - Black	<b>AHDASBD</b>
Door c/w neo-ceramic glass, - Large View - Black	<b>ACDABD</b>
Door c/w neo-ceramic glass, - Large View - Brass Trim	<b>ACDABTD</b>
<b>Gaskets</b>	
Glass Gasket -	<b>ACGLGA</b>
Door Gasket - 60"	<b>AGDRGA60</b>
Combustion Fan - 1/8" Fibreglass Paper Gasket	<b>ACCBFGA</b>
Convection Fan - 1/8" Fibreglass Paper Gasket	<b>ACCVFGA</b>
Ash Door Gasket -	<b>AGADGA</b>
<b>Glass</b>	
Neo-Ceramic - plain - Large View	<b>AGNCGP</b>
Neo-Ceramic - plain - Small View	
Neo-Ceramic-Large View- etched - Cheap Charlie logo	<b>AGNCGE</b>
<b>Grates</b>	
Grate - "Super Grate"	<b>ACSLGR</b>

<b>Kits</b>	
Dealers Parts Kit - CCI100 Board - 1of each fan, motor, timers, igniter, board, electrical, switches and grate	<b>AGDPKTSB</b>
Dealers Parts Kit - CCIAT Board - 1of each fan, motor, electrical, igniter, board and grate	<b>AGDPKTAT</b>
Dealers Stove Analysis Kit	<b>AGDSAKT</b>
- draft guage, volt meter, test board for SB and AT Boards	
Dwyer Draft Gauge	<b>ACDDG</b>
Volt Meter	<b>ACCVLTM</b>
<b>Knobs &amp; Handles</b>	
Door Spring Handle - Brass	<b>ACDSHB</b>
Fuel Control Knob	<b>ACFLCKN</b>
Damper Spring Handle - Brass	<b>ACDPSHB</b>
<b>Switches</b>	
Low Limit Switch - SE-L120	<b>ACLSW120</b>
High Limit Switch - SE-L250	<b>ACHSW250</b>
Igniter Limit Switch - SE-F140	<b>ACISW140</b>
Pressure Switch -	<b>ACPRSW</b>
Push Button Start Switch	<b>ACSTSWPB</b>
Fuel Potentiometer Switch	<b>AHFPSW</b>
<b>Timer Blocks</b>	
Timer Block - 30 minute	<b>ACTMR30M</b>
Timer Block - 3 second	<b>ACTMR03S</b>
<b>Wire</b>	
Wire Harness - CCISB - Main Assembly - with igniter	<b>ACSBMNVH</b>
Wire Harness - CCISB - Control Box Assembly	<b>ACSBPWH</b>
Wire Harness - CCIAT - Main Assembly - with igniter	<b>ACATMNVH</b>
3 Prong Plug Power Cord w/ ends	<b>ACPWCDAS</b>
<b>Wall Thermostat Kit - Complete Assembly</b>	
CCIAT - Control Board, Thermostat Module, 25' 18/2 bell wire, wall thermostat (white deg C)	<b>ACWTKTAC</b>
CCIAT - Control Board, Thermostat Module, 25' 18/2 bell wire, wall thermostat (almond deg F)	<b>ACWTKTAF</b>
<b>Wall Thermostat Kit - Add-on</b>	
Thermostat Module, wire, wall thermostat (white Deg C)	<b>ACWTKTC</b>
Thermostat Module, wire, wall thermostat (white Deg F)	<b>ACWTKTF</b>

SEE YOUR VULCAN "V" Series DEALER FOR ADDITIONAL INFO

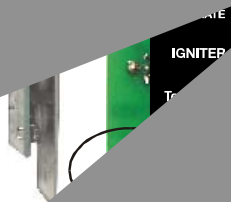

figure 31

# Appendix “D”

## Hopper Clean-Out Drop Chute



You would have found this along with your Owner's Manual, video and inspection card. This can have two purposes. The main one is to be an attachment to the side of the hopper to help with cleaning out the hopper. The second purpose would be used as a dust pan for your shop.

Keep this separate till needed.

### Purpose:

Should you find it necessary to remove the pellets from your hopper, for any reason, this handy attachment will save time and a lot of effort.

### Tools Needed:

¼" Hex Nut setter & Driver or Flat Head Screwdriver  
Pail or bin

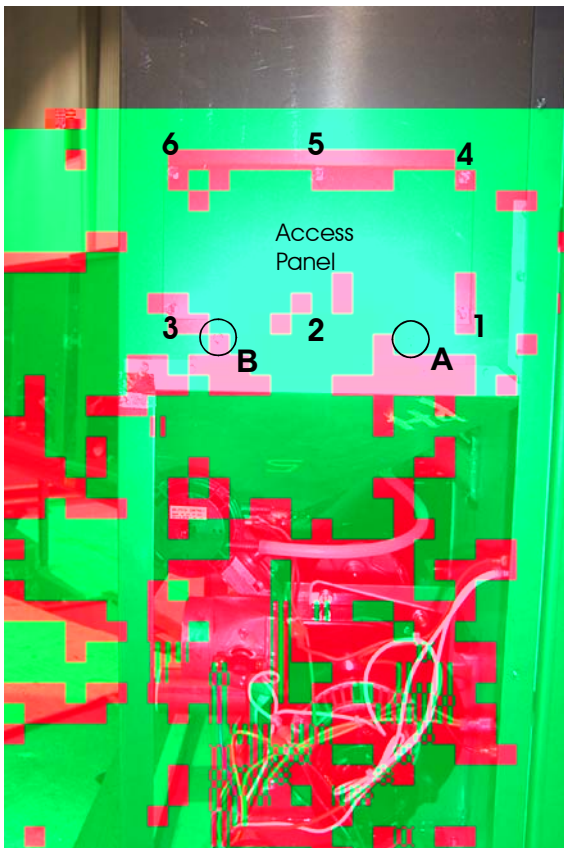

### How to Install:

1. Unplug the appliance power cord from the wall outlet.
2. To gain access to the inside of the appliance, remove the ¼" hex screws from the LEFT HAND SIDE PANEL (looking from the front of the heater). These are located on the back left hand side corner of the appliance.
3. Remove the panel simply by sliding it back toward the exhaust.
4. Remove the 2 - ¼" hex screws, labeled A & B.
5. Install the Hopper Drop Chute, re-installing the screws.
6. Remove the 5 - ¼" hex screws from the side hopper access panel. Number 1 - 5 (see picture)
7. Loosen the #6 screw, but leave it attached. This now allows the access panel to act as a door.
8. Place a catch pail under the drop chute.
9. Raise and lower the access panel as needed.
10. When finished cleaning out as many pellets as possible, re-install the 5 screws, remove the drop chute, replace the 2 screws and then install the side panel.



## Free Manuals Download Website

<http://myh66.com>

<http://usermanuals.us>

<http://www.somanuals.com>

<http://www.4manuals.cc>

<http://www.manual-lib.com>

<http://www.404manual.com>

<http://www.luxmanual.com>

<http://aubethermostatmanual.com>

Golf course search by state

<http://golfingnear.com>

Email search by domain

<http://emailbydomain.com>

Auto manuals search

<http://auto.somanuals.com>

TV manuals search

<http://tv.somanuals.com>