



SERVICE MANUAL



VPX SERIES ELECTRIC COUNTERTOP STEAMERS

<u>MODEL</u>	<u>ML</u>
VPX3	126586
VPX5	126588

- NOTICE -

This Manual is prepared for the use of trained Vulcan Service Technicians and should not be used by those not properly qualified. If you have attended a Vulcan Service School for this product, you may be qualified to perform all the procedures described in this manual.

This manual is not intended to be all encompassing. If you have not attended a Vulcan Service School for this product, you should read, in its entirety, the repair procedure you wish to perform to determine if you have the necessary tools, instruments and skills required to perform the procedure. Procedures for which you do not have the necessary tools, instruments and skills should be performed by a trained Vulcan Service Technician.

Reproduction or other use of this Manual, without the express written consent of Vulcan-Hart, is prohibited.

TABLE OF CONTENTS

GENERAL	3
Installation, Operation and Cleaning	3
Introduction	3
Features	3
Steam Cooking	3
Model Designations	3
Specifications	3
Water Requirements	3
Electric	3
Tools	3
REMOVAL AND REPLACEMENT OF PARTS	4
Covers and Panels	4
Component Panel Components	5
Timer	5
Standby Thermostat	5
High Limit Thermostat	6
Temperature Probe	6
Heating Element Assembly	6
Manual Drain Valve	8
Door	10
SERVICE PROCEDURES AND ADJUSTMENTS	12
Door Latch Adjustment	12
Door Sealing Adjustment	12
Heating Element Test	13
Temperature Control Calibration	13
ELECTRICAL OPERATION	14
Component Function	14
Component Location	15
Sequence of Operation	15
Wiring Diagrams	18
TROUBLESHOOTING	20
CONDENSED SPARE PARTS LIST	21

© Vulcan 2002

GENERAL

INSTALLATION, OPERATION AND CLEANING

Refer to the Installation & Operation Manual for specific instructions.

NOTE: Daily cleaning is required.

INTRODUCTION

Features

- Requires no water or drain line connections (manual fill & manual drain)
- Cast aluminum "element block" for efficient heat transfer and distribution
- Field convertible to single phase or three phase power
- When wired for single phase, a reduced 2/3 power output is available

Steam Cooking

The VPX series steamer provides timed or continuous mode cooking in a "pressure-less" compartment. The small physical size of the steamer offers an efficient way to produce many foods in small batches. Pressure-less, convection steam cooking will steam cook fresh foods or will steam defrost and cook frozen foods providing the maximum color, flavor and nutritional value with the least expenditure of energy and labor. The "pressure-less" cooking compartment allows the operator to open and close the door, anytime during a cooking cycle.

Model Designations

- VPX3 - 3 pan capacity*
- VPX5 - 5 pan capacity*

*based on 2.5 inch pan depth

Exterior Dimensions

- VPX3 - 21"w x 25"d x 25" h*
- VPX5 - 21"w x 25"d x 31.5" h*

*Includes 4" legs and 2" steam vent height

SPECIFICATIONS

Water Requirements

Use "potable" tap water that meets the following specifications:

- Hardness of 2-3 grains (34-35ppm)
- Total dissolved solids (TDS) less than 60ppm
- Ph factor of 7.0 to 7.5

These specifications can easily be obtained with the use of a properly maintained water softener.

- 2.5 gallons to fill holding pan (approximate)

Electric

MODEL	TOTAL KW	AMPERAGE PER LINE (60HZ) ¹				
		3 PHASE ²			1 PHASE ²	
		208V	240V	480V	208V	240V
VPX3	9.0 std.	25.0	21.7	10.9	43.3	37.5
	6.0 ³	-	-	-	28.9	25.0
VPX5	15.0 std.	41.7	36.1	18.1	72.2	62.5
	10.0 ³	-	-	-	48.1	41.7

NOTES:

1. Amperage values in the table are nominal. Tolerance is +5/-10%.
2. All models are shipped for three phase connections. If a single phase connection is needed, the steamer is field convertible. Requires jumper wire changes at terminal block. See wiring diagram 7264.
3. Field convertible to a reduced kw output (2/3 power connection). Requires jumper wire changes at terminal block. See wiring diagram 7264.

TOOLS

Standard

- Standard set of hand tools
- Clear silicone sealant
- VOM with an AC current tester (any quality VOM with a sensitivity of at least 20,000 ohms per volt can be used)
- Temperature meter & thermocouple

Special

- Thermal Transfer Compound, Dow Corning 340 P/N 819643-2 or equivalent

NOTE: The additional tools below are required if replacing heating element assembly.

- Torque wrench (in-lb.)
- Tile Trowel 3/16" x 5/32" V notch; Grainger catalog stock number 5LG08 or equivalent
- Loctite 271 or equivalent

REMOVAL AND REPLACEMENT OF PARTS

COVERS AND PANELS

WARNING: DISCONNECT THE ELECTRICAL POWER TO THE MACHINE AT THE MAIN CIRCUIT BOX. PLACE A TAG ON THE CIRCUIT BOX INDICATING THE CIRCUIT IS BEING SERVICED.

Right Side Panel

1. Remove screws from bottom of panel.

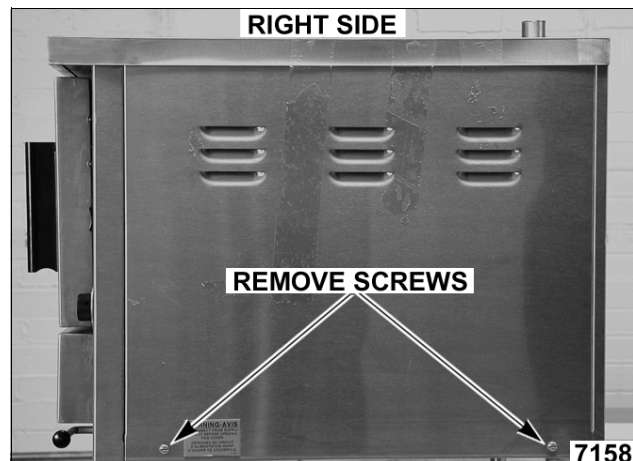

2. Slide panel down to clear top cover.
3. Reverse procedure to install.

Top Cover

1. Remove screws from the top rear of cover.

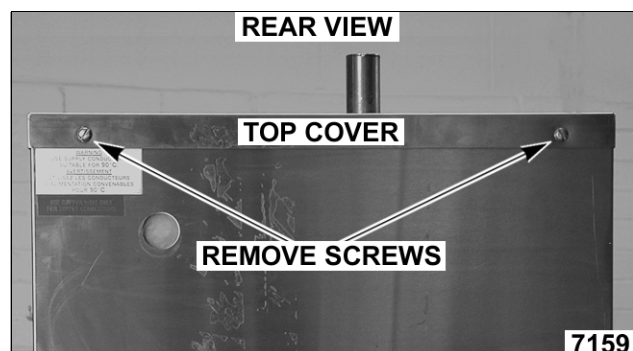

2. Push up on rear of cover to clear steam vent pipe and slide forward to clear the front lip.
3. Lift the cover off the cabinet.
4. Reverse procedure to install.

Left Side and Rear Panel

1. Remove top cover as outlined under "TOP COVER".
2. Disconnect electrical supply at terminal block.
3. Remove screws at bottom of panel.

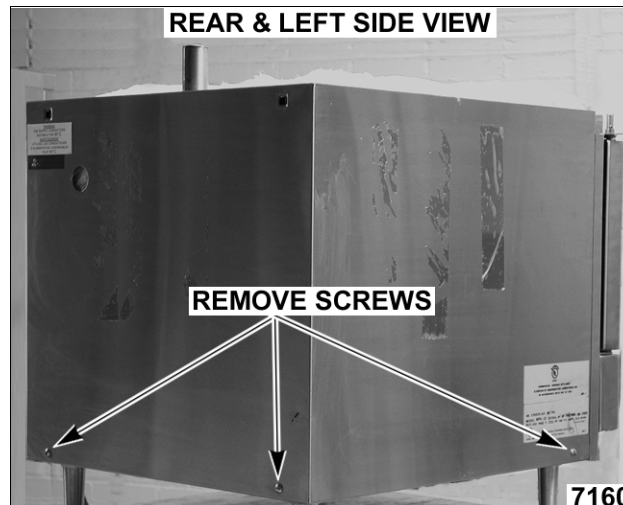

4. Pull the combination left side and rear panel off.
5. Reverse procedure to install.

Lower Front Cover

1. Remove screws from the lower front cover.



2. Open the door, cut the bead of silicone at the top rear of cover then remove cover.
3. Clean silicone residue from mating surfaces.
4. Reverse procedure to install and apply silicone sealant at the top rear of cover.

COMPONENT PANEL COMPONENTS

WARNING: DISCONNECT THE ELECTRICAL POWER TO THE MACHINE AT THE MAIN CIRCUIT BOX. PLACE A TAG ON THE CIRCUIT BOX INDICATING THE CIRCUIT IS BEING SERVICED.

1. Remove right side panel as outlined under "COVERS AND PANELS".
2. Disconnect lead wires to component being replaced.
3. Remove component.

NOTE: To remove temperature control, pull knob off and remove nut from shaft.

- Reverse procedure to install replacement component and check steamer for proper operation.

NOTE: If replacing temperature control, see "TEMPERATURE CONTROL CALIBRATION - ADJUSTMENT FOR ELEVATION" in "SERVICE PROCEDURES AND ADJUSTMENTS".

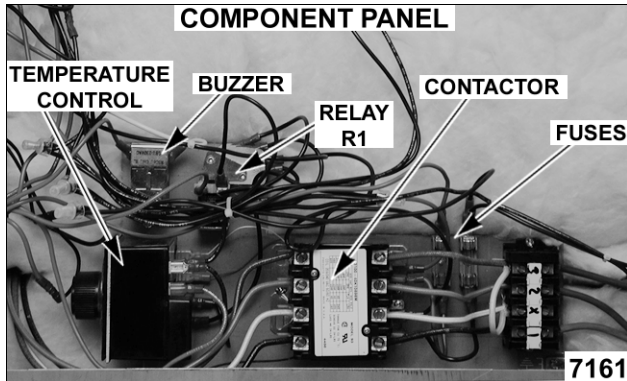

TIMER

WARNING: DISCONNECT THE ELECTRICAL POWER TO THE MACHINE AT THE MAIN CIRCUIT BOX. PLACE A TAG ON THE CIRCUIT BOX INDICATING THE CIRCUIT IS BEING SERVICED.

- Remove right side panel as outlined under "COVERS AND PANELS".
- Disconnect lead wires to timer.
- Loosen two set screws on dial and pull timer knob from shaft.
- Remove nut from timer shaft and remove timer.
- Reverse procedure to install.

STANDBY THERMOSTAT

WARNING: DISCONNECT THE ELECTRICAL POWER TO THE MACHINE AT THE MAIN CIRCUIT BOX. PLACE A TAG ON THE CIRCUIT BOX INDICATING THE CIRCUIT IS BEING SERVICED.

- Remove right side panel as outlined under "COVERS AND PANELS".
- Pull insulation back to expose standby thermostat and disconnect lead wires.

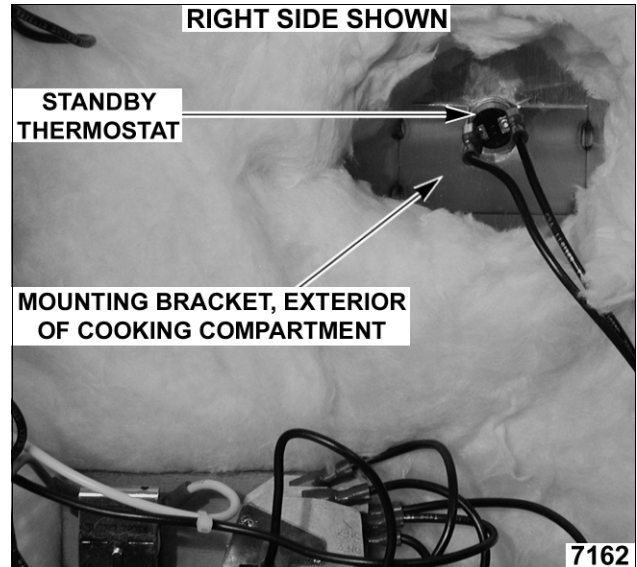

- Grasp thermostat body and push up to slide holding tabs out from mounting bracket.
- Apply a small amount of "thermal transfer compound" to the mating surface (disk side) of the replacement thermostat.
 - Spread the compound completely and evenly over the surface of the thermostat.
- Reverse procedure from step 3 to install and check steamer for proper operation.

HIGH LIMIT THERMOSTAT

WARNING: DISCONNECT THE ELECTRICAL POWER TO THE MACHINE AT THE MAIN CIRCUIT BOX. PLACE A TAG ON THE CIRCUIT BOX INDICATING THE CIRCUIT IS BEING SERVICED.

- Remove right side panel as outlined under "COVERS AND PANELS".
- Pull insulation back to expose high limit thermostat and disconnect lead wires.

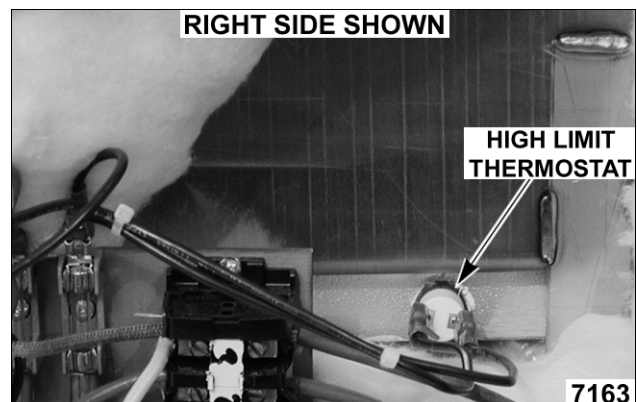

- Remove thermostat from heating element assembly.

NOTE: Thermostat base is a brass 5/8" hex with a threaded stem.

4. Apply a small amount of "thermal transfer compound" to the mating surface (disk side) of the replacement thermostat.
 - A. Spread the compound completely and evenly over the surface of the thermostat.
5. Reverse procedure from step 3 to install and check steamer for proper operation.

NOTE: Do not cross thread or over tighten the high limit or damage to the mounting threads may occur.

TEMPERATURE PROBE

WARNING: DISCONNECT THE ELECTRICAL POWER TO THE MACHINE AT THE MAIN CIRCUIT BOX. PLACE A TAG ON THE CIRCUIT BOX INDICATING THE CIRCUIT IS BEING SERVICED.

1. Remove all covers and panels as outlined under "COVERS AND PANELS".
2. Disconnect probe leads from the temperature control.
3. Remove temperature probe from steam vent pipe.

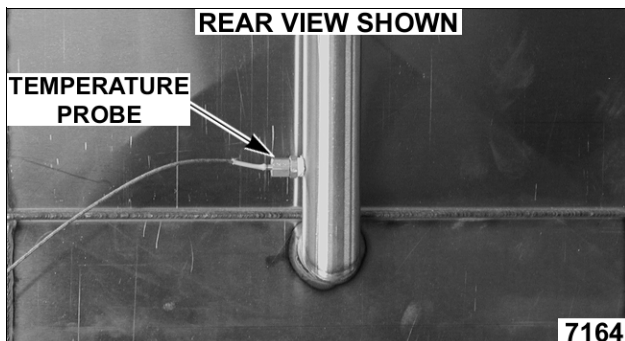

4. Reverse procedure to install replacement probe.
5. Adjust temperature control as outlined under "TEMPERATURE CONTROL CALIBRATION" in "SERVICE PROCEDURES AND ADJUSTMENTS".

HEATING ELEMENT ASSEMBLY

WARNING: DISCONNECT THE ELECTRICAL POWER TO THE MACHINE AT THE MAIN CIRCUIT BOX. PLACE A TAG ON THE CIRCUIT BOX INDICATING THE CIRCUIT IS BEING SERVICED.

The heating element assembly contains three elements molded into a cast aluminum block. The block is mounted on the underside of cooking compartment.

NOTE: As the steamer is disassembled, remove the sheets of insulation from top, rear and left side, and the bottom. Retain insulation for use during re-assembly.

1. Remove all covers and panels as outlined under "COVERS AND PANELS".
2. From the rear, tilt steamer until it rests on door.
 - A. Place wooden blocks opposite door handle to level and support steamer.
3. Grasp component panel and remove screws securing it to the base.
 - A. Lower component panel and leave at the side of steamer so that all the component lead wires can remain connected.

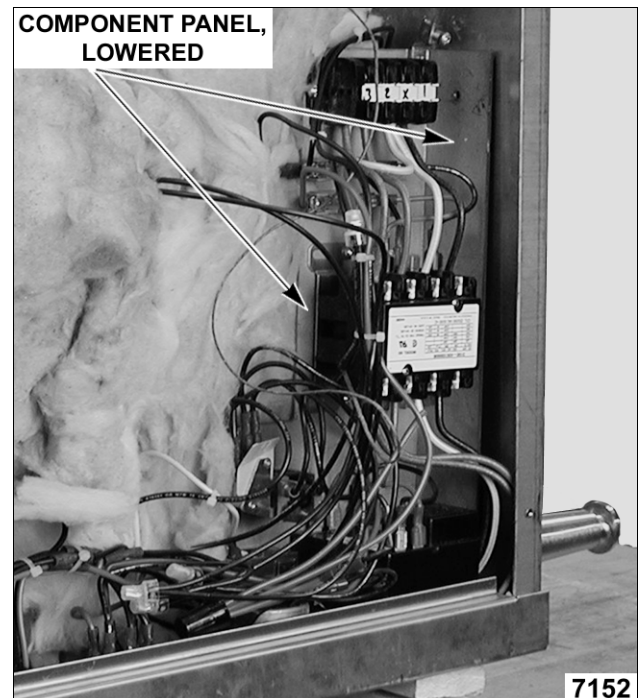

4. Remove screws securing base to steamer support frame.

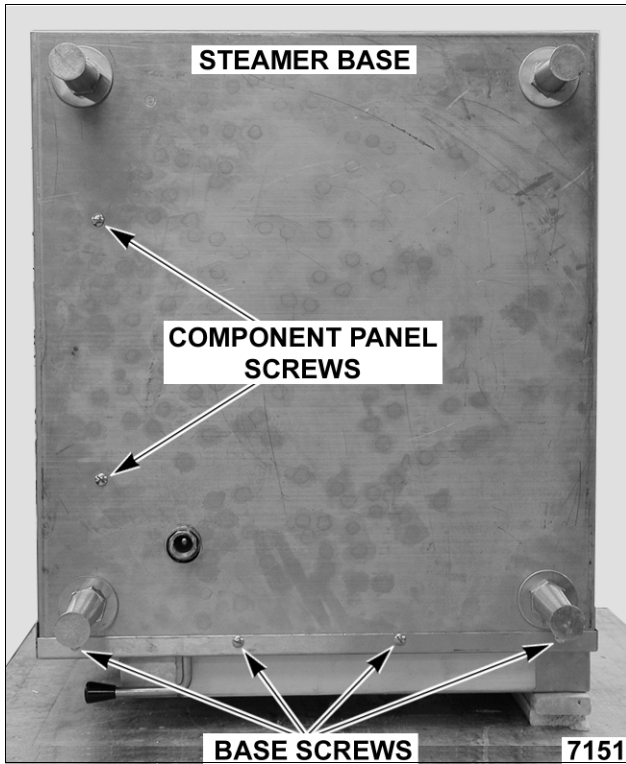

- Remove mounting nuts & washers from the rear cooking compartment support legs and remove base.

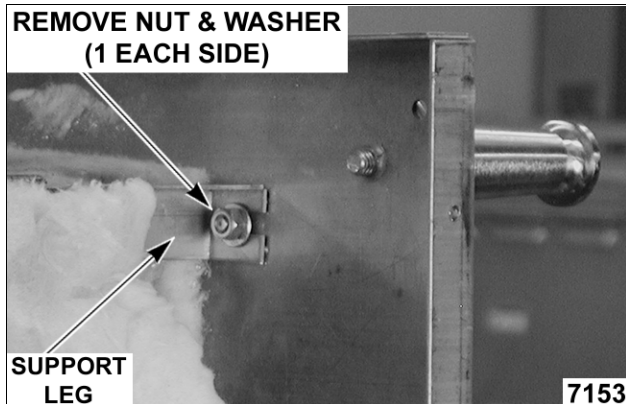

- Disconnect heating element lead wires from element terminals.

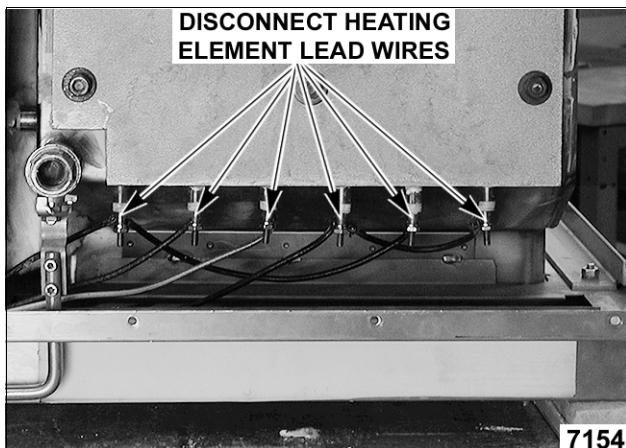

- Disconnect high limit thermostat lead wires and remove high limit from heating element assembly.

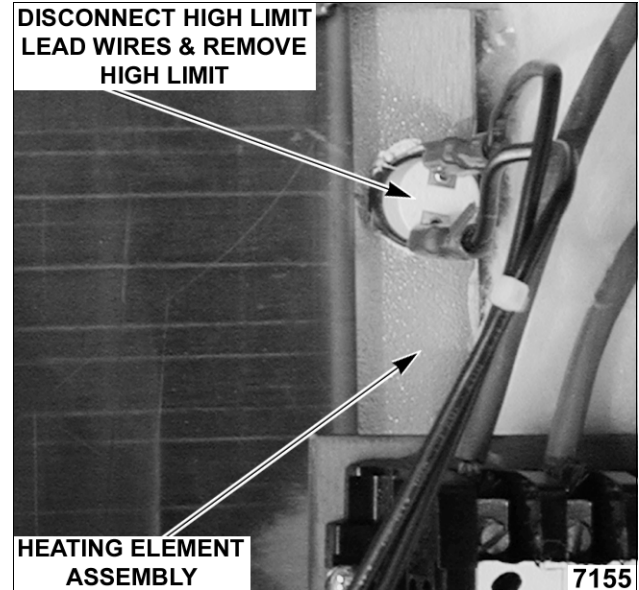

- Remove heating element assembly from steamer.



- Clean Loctite residue from heating element assembly mounting stud threads.
- Apply approximately 4 oz. of heat transfer compound to the mating surface (side opposite markings) on the heating element assembly.
 - Using a tile trowel, spread the compound evenly over the surface of the assembly.
- Mount replacement heating element assembly to the underside of cooking compartment.

- A. Temporarily install a flat washer and nut on all mounting studs. **Hand tighten only.**
- B. Tighten each nut to 100 in-lb using the sequence as shown.

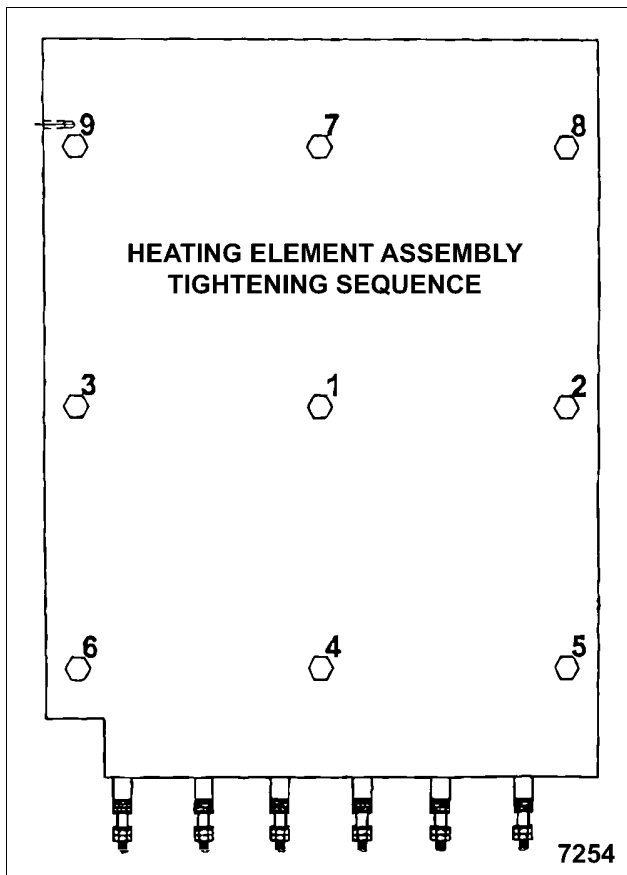

- C. Remove nut and washer from each mounting stud.
- D. Apply Loctite 271 to heating element assembly mounting stud threads.
- E. Stack two new spring disk washers (Belleville) together and install on each stud.
 - 1) Tighten each nut to 45 in-lb using the same sequence as shown.

12. Reverse procedure to re-assemble from step 7 and check steamer for proper operation.

MANUAL DRAIN VALVE

WARNING: DISCONNECT THE ELECTRICAL POWER TO THE MACHINE AT THE MAIN CIRCUIT BOX. PLACE A TAG ON THE CIRCUIT BOX INDICATING THE CIRCUIT IS BEING SERVICED.

1. Remove all covers and panels as outlined under "COVERS AND PANELS".
2. From the rear, tilt steamer until it rests on door.

- A. Place wooden blocks opposite door handle to level and support steamer.
3. Grasp component panel and remove screws securing it to the base.
 - A. Lower component panel and leave at side of steamer so that all the component lead wires can remain connected.

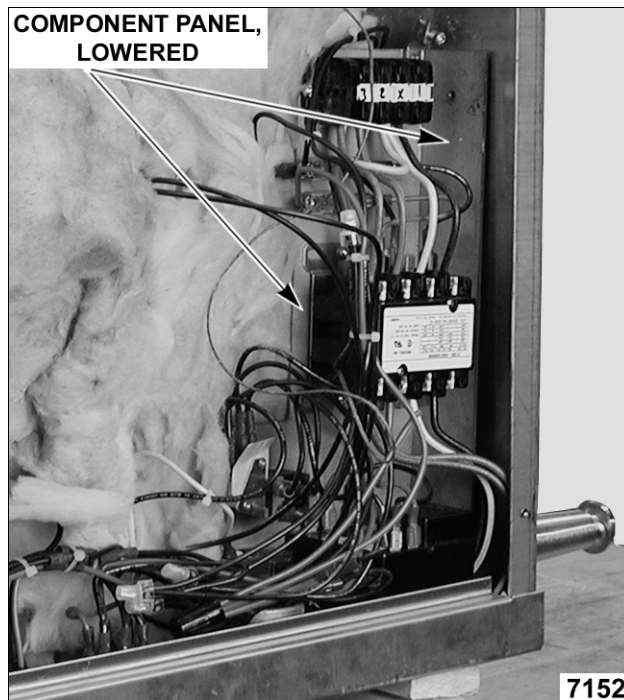

4. Remove screws securing base to steamer support frame.

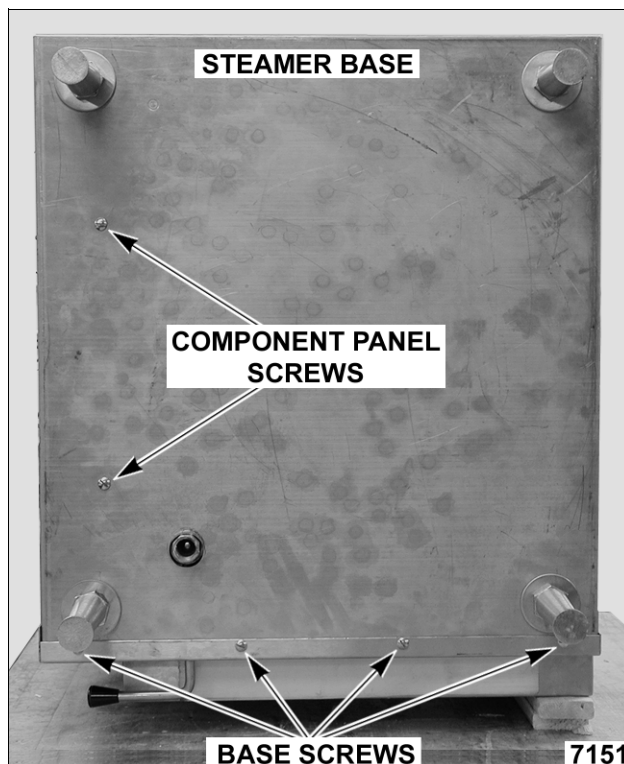

- Remove mounting nuts & washers from the rear cooking compartment support legs and remove base.

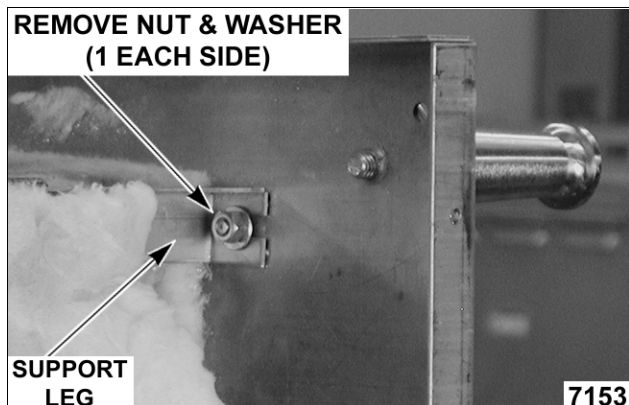

- Remove outer nut on drain valve stem and lift off drain handle assembly.

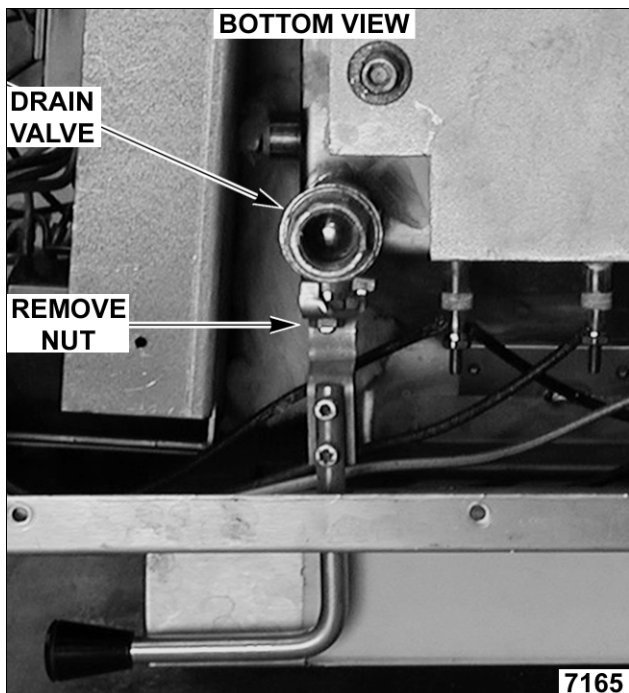

- Remove manual drain valve from cooking compartment drain pipe.
- Clean thread sealant residue from drain pipe threads and apply new sealant.
- Install a replacement drain valve.
 - Tighten valve body so that actuator stem is pointing towards front of steamer.
- Reverse procedure to re-assemble from step 6 and check steamer for proper operation.

DOOR

WARNING: DISCONNECT THE ELECTRICAL POWER TO THE MACHINE AT THE MAIN CIRCUIT BOX. PLACE A TAG ON THE CIRCUIT BOX INDICATING THE CIRCUIT IS BEING SERVICED.

Removal

- Remove top cover as outlined under "COVERS AND PANELS".
- Open the door.
- Pull hinge rod up.
- Reverse procedure to install, making sure the door bushings are in place.

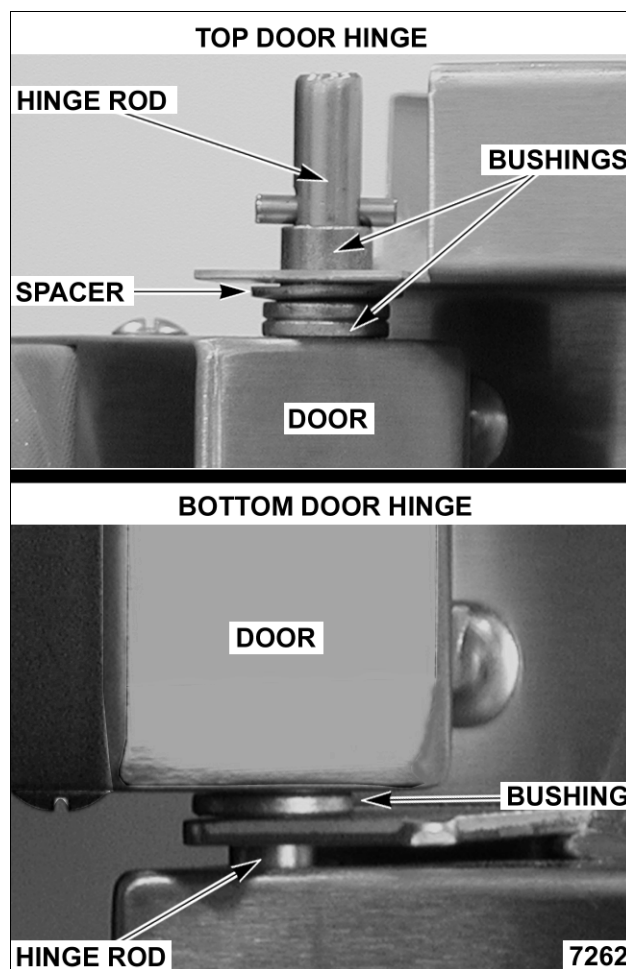

Gasket

1. Open the door.
2. Remove screws from the gasket plate.
3. Pull the gasket plate out from the door housing and remove the gasket.
4. Position the new gasket on the gasket plate and reverse the procedure to install. Adjust the door as outlined under "DOOR SEALING ADJUSTMENT".

NOTE: Do not over tighten gasket plate screws as this will compress the gasket excessively and interfere with proper door sealing.

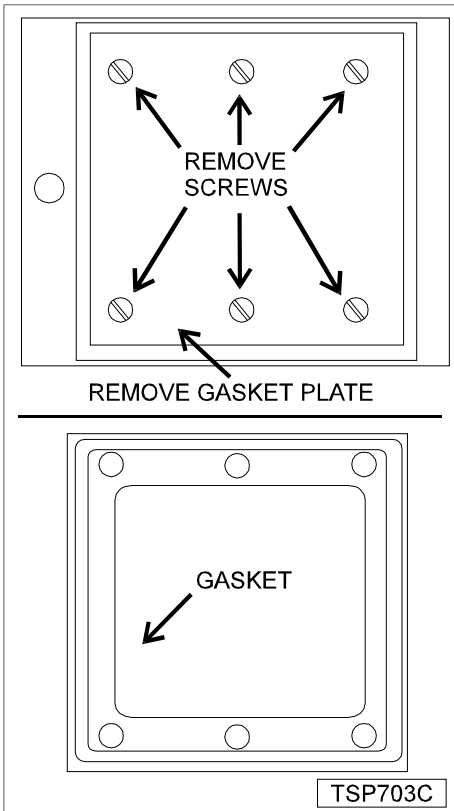

4. Remove the nuts and spacers from the handle screws and remove the handle from the door.

NOTE: When installing the spacers, the smaller diameter fits into the slot in the door and the latch lever must rest on top of the handle latch screw.

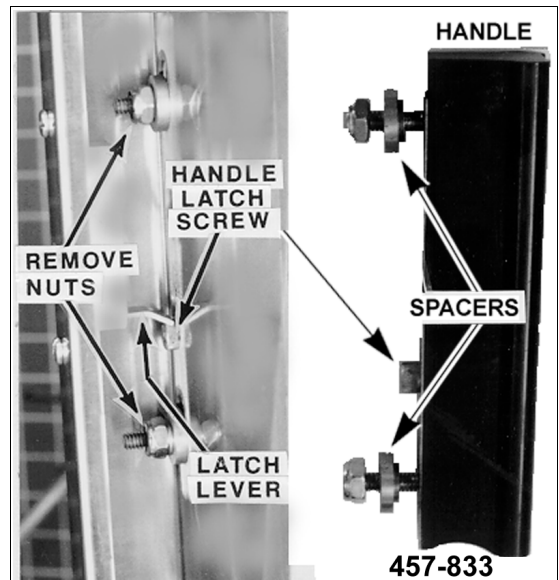

Handle

1. Open the door.
2. Remove screws from the top and bottom of the door.
3. Pull the "inner" door panel out from the door housing with the gasket plate and gasket still attached.

5. Reverse procedure to install.

Latch Assembly

1. Open the door.
2. Remove screws from the top and bottom of the door.
3. Pull the "inner" door panel out from the door housing with the gasket plate and gasket still attached.
4. Remove the screws from the side edge of the door that secure the latch mechanism and remove the latch from the door.



NOTE: When installing, the latch lever must rest on top of the handle latch screw.

5. Reverse procedure to install.

SERVICE PROCEDURES AND ADJUSTMENTS

WARNING: CERTAIN PROCEDURES IN THIS SECTION REQUIRE ELECTRICAL TEST OR MEASUREMENTS WHILE POWER IS APPLIED TO THE MACHINE. EXERCISE EXTREME CAUTION AT ALL TIMES. IF TEST POINTS ARE NOT EASILY ACCESSIBLE, DISCONNECT POWER, ATTACH TEST EQUIPMENT AND REAPPLY POWER TO TEST.

DOOR LATCH ADJUSTMENT

Should the steamer door "jam" and can not be opened, **DO NOT FORCE OR PRY** the door as damage will occur.

First, try lifting up on the bottom of the door at the handle end, to disengage the latch.

If that does not work, remove the right side panel. The striker that catches on the "door latch" is located behind the front face of the cooking cavity. Remove the nut from the striker and this will release it from the panel.

Once the nut and washer have been removed, door will open freely.

Remove any burrs on the striker that may cause the latch to stick.

Reinstall the striker and adjust, so door will not jam.

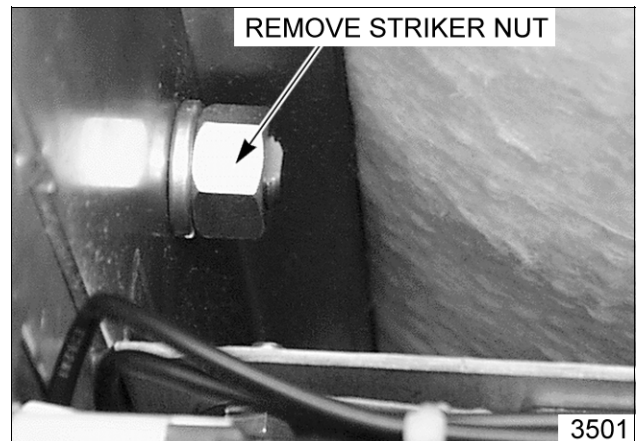

To adjust:

1. Reinstall the striker with the slot pointing upwards and "hand tighten" nut only.
2. Close the door to center the striker in the oval mounting hole.
3. Open the door and check the strikers' slot for horizontal alignment. The slot on the striker must be kept horizontal in order for the door latch to catch it properly and latch.

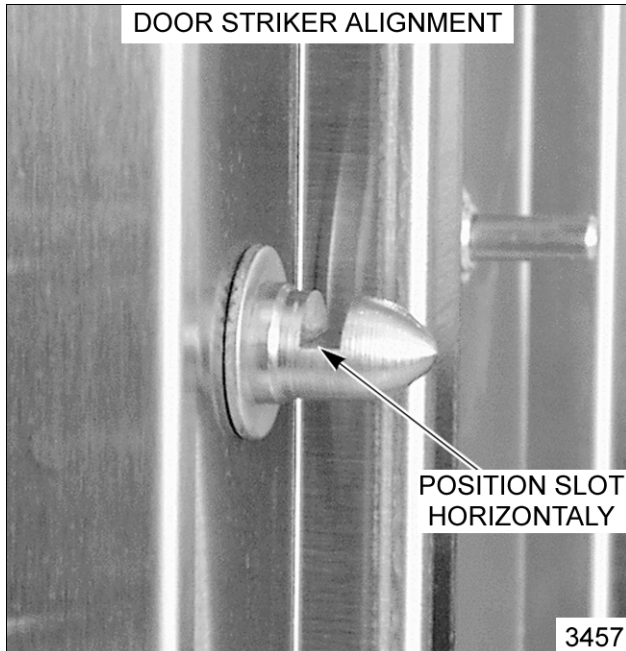

4. Once the proper slot alignment has been set, hold the striker close to its base using a rag and vise grips, then tighten the striker nut. Be careful not to damage the striker "slot" when tightening or door may not latch properly.

NOTE: Do not over tighten as the striker will begin to turn and change alignment.

DOOR SEALING ADJUSTMENT

On initial installation of new door gaskets, the door will be hard to close. This is required for proper gasket fit. As the door is used, it becomes easier to close after a few days.

1. Check the door gasket quality. If damaged or worn, replace as outlined under "DOOR".
2. Loosen screws until the screw heads no longer touch the gasket plate.
3. Tighten screws until screw head touches gasket plate and at that point begin counting turns.
4. Tighten all screws approximately two turns.
5. Close the door and check unit for proper operation.

6. If necessary, tighten all screws an additional $\frac{1}{2}$ turn and repeat step 5.
7. Repeat step 6 until the door closes properly and no steam "leaks" are seen around the gasket seal.

HEATING ELEMENT TEST

WARNING: THE FOLLOWING STEPS REQUIRE POWER TO BE APPLIED TO THE UNIT DURING THE TEST. USE EXTREME CAUTION AT ALL TIMES.

1. Turn cooking mode switch to "continuous".
2. Measure voltage at heating element terminals and verify it against data plate voltage.
 - A. If voltage is incorrect, find the source of the problem.
 - B. If voltage is correct, check current draw (amps) through the heating element lead wires.

NOTE: This method is preferred over a resistance check when a clamp on type amp meter is available.

- 1) If current draw is correct then heating element is functioning properly. **See table below for proper values.**
- 2) If current draw is not correct, turn cooking mode switch to OFF and **disconnect the electrical supply.**
 - a. Replace heating element then proceed to step 3.
- C. If unable to check current draw, a resistance check may indicate a malfunctioning element.
 - 1) Turn the cooking mode switch to OFF and **disconnect the electrical supply.**
 - 2) Remove the lead wires from the heating element and check resistance (ohms). **See table below for proper values.**
3. Check for proper operation.

VOLTAGE	KW PER ELEMENT	AMPS PER ELEMENT		OHMS PER ELEMENT
		1 PH	3 PH	
208	3	14.4	8.3	14.4
240	3	12.5	7.2	19.2
480	3		3.6	76.8
208	5	24.0	14.0	8.70
240	5	21.0	12.0	11.5
480	5		6.0	46.0

NOTES:

1. Values in the table are nominal. Tolerance is +5/-10%.
2. Voltage values are @ 60HZ.
3. Each heating element assembly contains 3 elements. Total KW would be the individual element KW times 3.
4. Resistance values (ohms) are @ room temperature.

ELEVATION (FT)	TEMPERATURE (°F)
Sea Level	210
1,000	208
2,000	206
3,000	204
4,000	202
5,000	200
6,000	198
7,000	196
8,000	195
9,000 or above	194

TEMPERATURE CONTROL CALIBRATION

To set the temperature control for optimum steamer operation, the elevation above sea level for the service location must first be determined.

The elevation is used in conjunction with the elevation table below, to determine the correct set point temperature for the control.

NOTE: If the set point temperature is too high, the excess boiling action will cause water droplets to exit the steam vent pipe, and cause high water usage.

1. Remove right side panel as outlined under "COVERS AND PANELS".
2. Place a thermocouple approximately one inch down in the center of steam vent pipe.
3. Turn steamer on by selecting "continuous" mode.
4. Allow steamer temperature to stabilize by completing two heating cycles.
5. Record the temperature reading when "heater" light goes out.
6. Using the elevation table, compare the recorded temperature to the temperature listed for the specific elevation.

NOTE: Use temperature scale on control dial plate for reference only. The scale represents dial turns in 1°F increments, not the actual temperature. When calibrating, use the recorded temperature taken from thermocouple.

- A. If the set point temperature of the control is correct, no adjustment is necessary.
- B. If the set point temperature of the control is not correct, adjust the temperature control. Repeat step 4 until the correct temperature is achieved.
 - 1) Turn the temperature control dial clockwise to increase temperature or counterclockwise to decrease temperature.

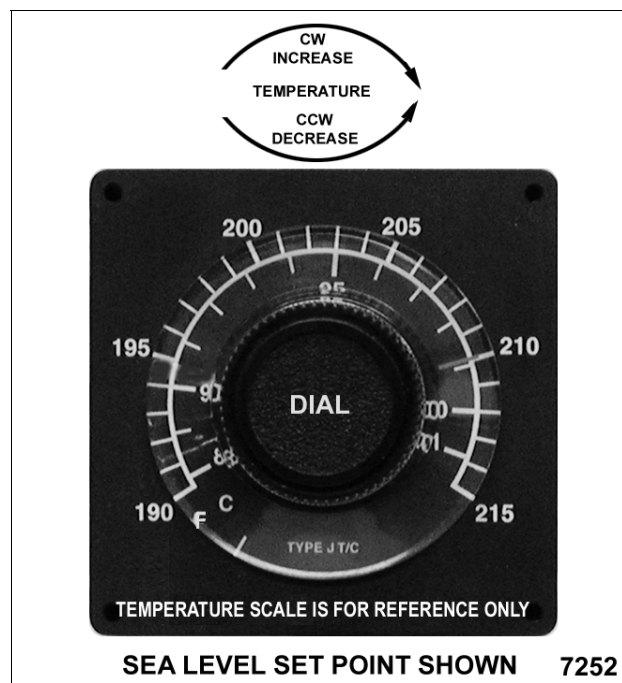

ELECTRICAL OPERATION

COMPONENT FUNCTION

- Buzzer** Signals end of a "cook" cycle when cooking time expires.
- Contactor** Supplies line voltage to heating element assembly.
- Relay R1** Supplies power to temperature control.
- Transformer** Provides 240V to the control circuit (480V only).
- Heater Light (green)** Indicates steamer is heating.
- Low Water Light (red)** Indicates additional water is required in cooking compartment.
- Cooking Mode Switch (with pilot lights)** Supplies 240V to the control circuit. Two internal "pilot" lights indicate the cooking mode selected. Timed mode is amber; Continuous mode is red.
- Door Switch** Removes control circuit power from steamer when door is opened.
- High Limit Thermostat** Protects steamer by removing control circuit power if the heating element assembly temperature goes above 350°F (+/-15; 50°F differential).
- Temperature Control** Monitors temperature probe and cycles power to heater contactor for steam generation.
- Standby Thermostat** Maintains steamer at a standby temperature of 168°F (+5/-8) when "cook" timer is off (timed mode only).
- Timer** Counts "cook" time of product when time is dialed and energizes buzzer when time expires. To silence buzzer, dial must be turned to off.
- Temperature Probe** Senses cooking compartment temperature and sends a corresponding DC voltage back to the temperature control (J-type thermocouple).

COMPONENT LOCATION

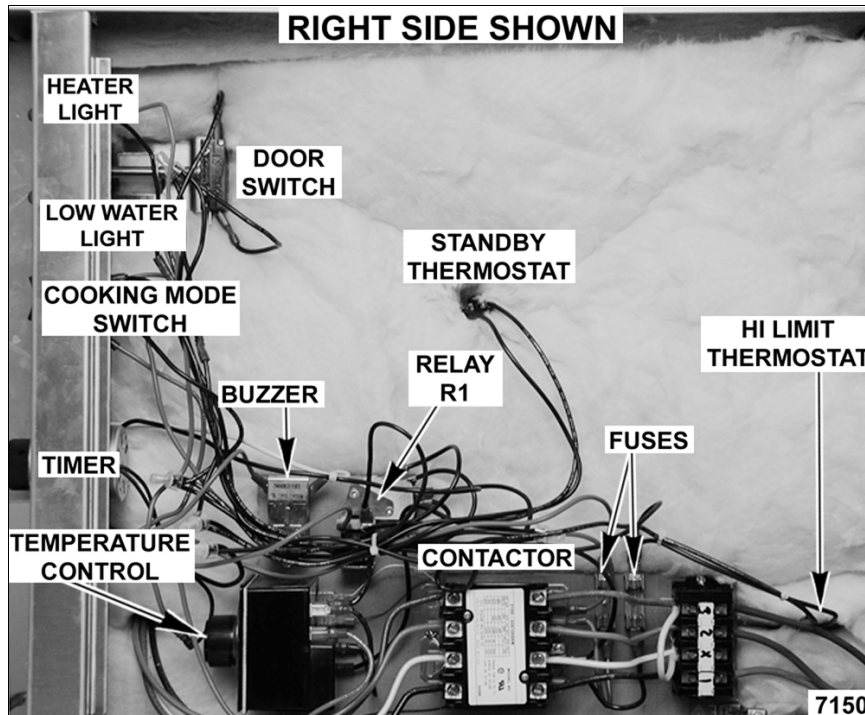

SEQUENCE OF OPERATION

Wiring diagram 7264 will be used to explain the electrical sequence of operation.

Timed Cooking Mode

1. Conditions.
 - A. Steamer connected to correct voltage and is properly grounded.
 - B. Cooking mode switch (power) off.
 - C. High limit thermostat closed.
 - D. Standby thermostat closed.
 - E. Temperature control is setup properly and is ready to use.
 - F. Door closed (door switch closed).
 - G. Timer "off".
 - H. Cooking compartment filled to the water level mark and below standby temperature of 168°F (+5/-8).

NOTE: At temperatures below 168°F, the steamer is in a "pre-heat" state.

2. Select "timed" on the cooking mode switch.
 - A. Internal "pilot" light (top, amber) comes on.
 - B. Internal "pilot" light (bottom, red) comes on.
 - C. Relay "R1" energized.
 - 1) R1-2A & R1-2B (both N.C.) open.
 - 2) R1-3A & R1-3B (both N.O.) close.
3. Temperature control energized and evaluates input from thermocouple.
 - A. With temperature below set point, internal relay contacts close.
 - 1) Heater light (green) comes on.
 - 2) Contactor energized and heating elements are powered.
4. Temperature reaches 168°F and standby thermostat opens.
 - A. Internal "pilot" light (top, amber) goes out.

NOTE: Steamer will maintain standby temperature until a "cook" time is dialed on timer; or the cooking mode switch is turned to off or continuous; or the door is opened.
 - B. Relay "R1" de-energized.
 - 1) R1-2A & R1-2B return to N.C. position.

- 2) R1-3A & R1-3B return to N.O. position.
 - a. Temperature control de-energized and internal relay contacts open.
 - a) Contactor de-energized and power removed from heating elements.
5. Set "cook" timer to desired time.
 - A. Timer contacts 1 & 3 close, timer motor is energized and timing down begins.

NOTE: Additional time can be set or the "cook" timer can be turned off throughout the cooking cycle. If turned to off, steamer reverts to standby temperature.
6. Temperature reaches set point and the temperature control's internal relay contacts open.
 - A. Contactor de-energized and power is removed from heating elements.
7. Steamer cycles on the temperature control until "cook" time expires.
8. Time expires on "cook" timer.
 - A. Timer contacts 1 & 3 open, timer motor is de-energized and timing stops.
 - B. Timer contacts 1 & 4 close.
 - 1) Buzzer energized and sounds.

NOTE: The buzzer continues to sound until timer dial is set to off position or additional time is set.
9. Turn "cook" timer off.
 - A. Steamer reverts to standby temperature and continues to cycle until a "cook" time is dialed on timer; or the cooking mode switch is turned to off or continuous; or the door is opened.

NOTE: If water level becomes low during cycling, high limit thermostat will open and low water light (red) will come on.

Continuous Cooking Mode

1. Conditions.
 - A. Steamer connected to correct voltage and is properly grounded.
 - B. Cooking mode switch (power) off.
 - C. High limit thermostat closed.
 - D. Standby thermostat closed.
 - E. Temperature control is setup properly and is ready to use.

- F. Door closed (door switch closed).
 - G. Timer "off".
 - H. Cooking compartment filled to the water level mark and below standby temperature of 168°F (+5/-8).
2. Select "continuous" on the cooking mode switch.
 - A. Internal "pilot" light (top, amber) comes on.
 - B. Internal "pilot" light (bottom, red) comes on.
 - C. Relay "R1" energized.
 - 1) R1-2A & R1-2B (both N.C.) open.
 - 2) R1-3A & R1-3B (both N.O.) close.
 3. Temperature control energized and evaluates input from thermocouple.
 - A. With temperature below set point, internal relay contacts close.
 - 1) Heater light (green) comes on.
 - 2) Contactor energized and heating elements are powered.
 4. Temperature reaches 168°F and standby thermostat opens.
 - A. Internal "pilot" light (top, amber) goes out.
 5. Temperature reaches set point and the temperature control's internal relay contacts open.
 - A. Contactor de-energized and power is removed from heating elements.
 6. Steamer continues to cycle on the temperature control until the cooking mode switch is turned to off or timed; or the door is opened.

NOTE: If water level becomes low during cycling, high limit thermostat will open and low water light (red) will come on.

WIRING DIAGRAMS

208-240V

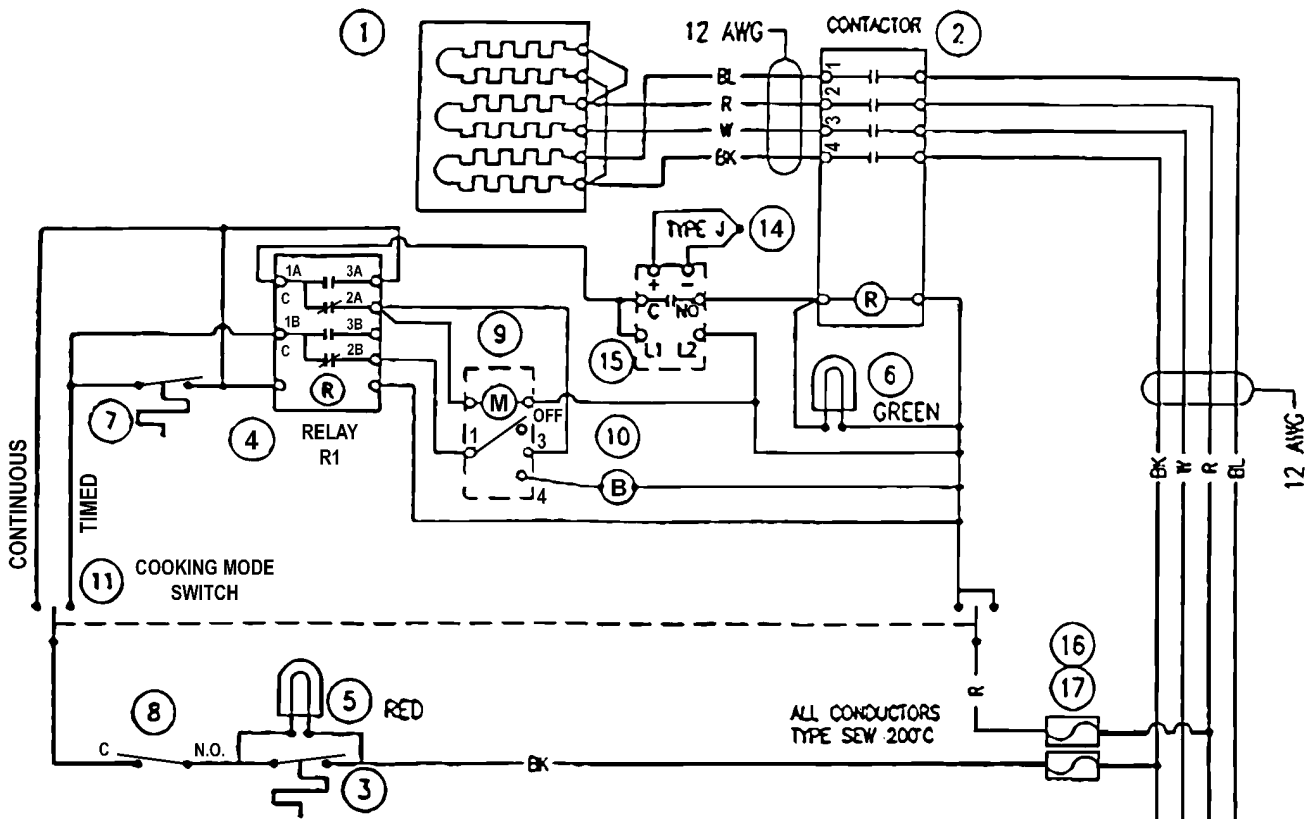

*SELECT AS REQUIRED.

ITEM	DESCRIPTION
1	ELEMENT ASSEMBLY, 208V 9kW
	ELEMENT ASSEMBLY, 208V 15kW
	ELEMENT ASSEMBLY, 240V 9kW
	ELEMENT ASSEMBLY, 240V 15kW
2	CONTACTOR
3	HIGH LIMIT THERMOSTAT
4	RELAY, DPDT
5	PILOT LAMP, RED (LOW WATER)
6	PILOT LAMP, GREEN (HEATER)
7	THERMOSTAT, STAND-BY, 168°F +5/-8
8	SWITCH SPOT, DOOR INTERLOCK
9	TIMER, 60 MIN@50HZ
10	BUZZER
11	SWITCH, ON/OFF, DPDT (COOKING MODE)
12	TERMINAL SECTION
13	TERMINAL END PIECE
14	THERMOCOUPLE
15	TEMPERATURE CONTROL
16	FUSE, 1A, 250V
17	FUSE HOLDER

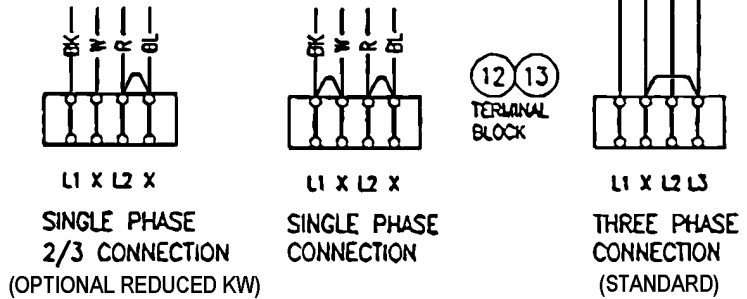

Volts-kw	AMPS		
	1 PH @ 2/3	1 PH	3-PH
208-9	28.9	43.3	25.0
240-9	25.0	37.5	21.7
208-15	48.1	72.2	41.7
240-15	41.7	62.5	36.1

DERIVED FROM:
3E-15027 REV 1

**VPX3 & VPX5
COUNTERTOP STEAMER
208V/240V**

7264

480V

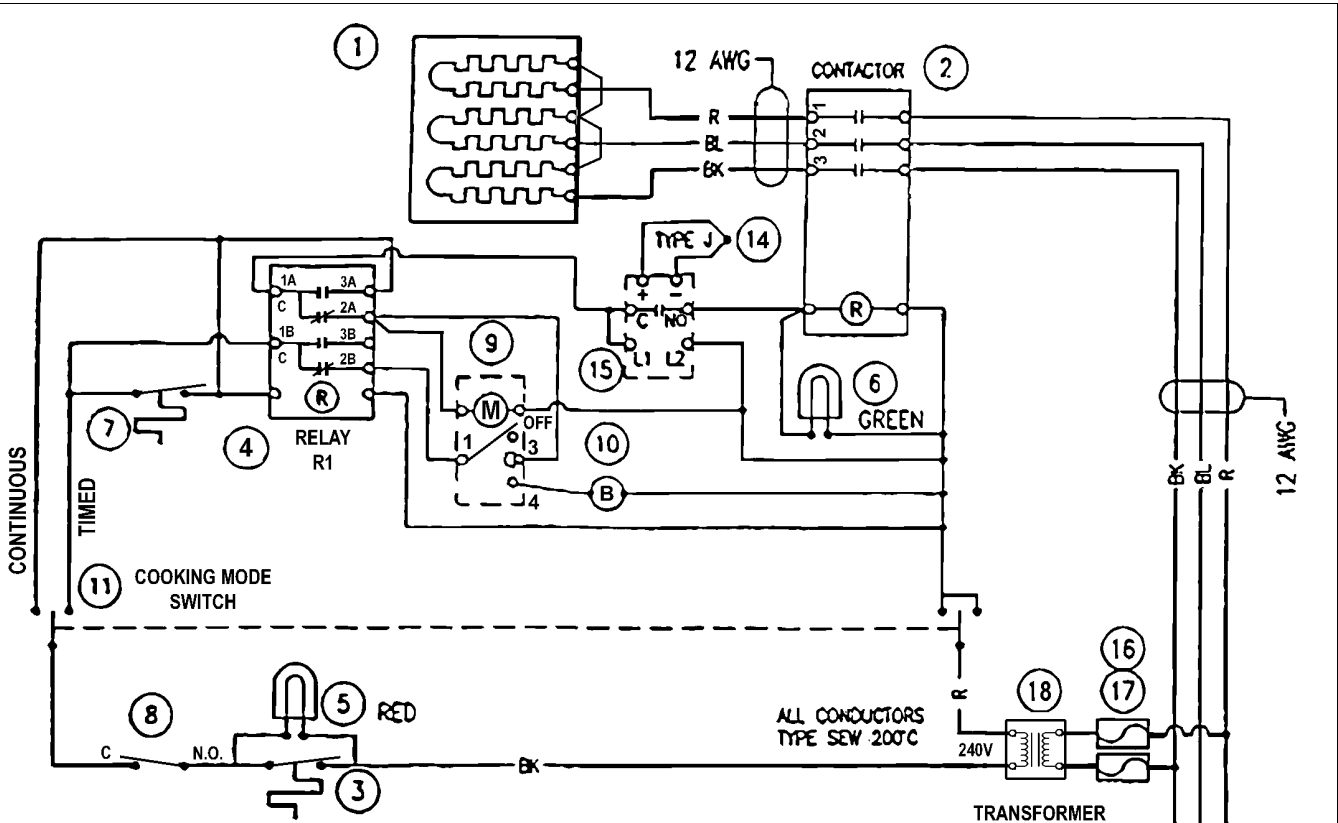

*SELECT AS REQUIRED.

ITEM	DESCRIPTION
1	ELEMENT ASSEMBLY, 480V 9kW ELEMENT ASSEMBLY, 480V 15kW
2	CONTACTOR
3	HIGH LIMIT THERMOSTAT
4	RELAY, DPDT
5	PILOT LAMP, RED (LOW WATER)
6	PILOT LAMP, GREEN (HEATER)
7	THERMOSTAT, STAND-BY, 168°F +5/-8
8	SWITCH SPOT, DOOR INTERLOCK
9	TIMER, 60 MIN@60HZ
10	BUZZER
11	SWITCH, ON/OFF, DPDT (COOKING MODE)
12	TERMINAL SECTION
13	TERMINAL END PIECE
14	THERMOCOUPLE
15	TEMPERATURE CONTROL
16	FUSE, 1A, 480V
17	FUSE HOLDER
18	TRANSFORMER, 480/240V, 100VA

AMPS	
Volts-kw	3-PH
480 -9	10.9
480 -15	18.1

DERIVED FROM:
3E-15028 REV 1

VPX3 & VPX5
COUNTERTOP STEAMER
480V

7265

TROUBLESHOOTING

WARNING: CERTAIN PROCEDURES IN THIS SECTION REQUIRE ELECTRICAL TESTS OR MEASUREMENTS WHILE POWER IS APPLIED TO THE MACHINE. EXERCISE EXTREME CAUTION AT ALL TIMES. IF TEST POINTS ARE NOT EASILY ACCESSIBLE, DISCONNECT POWER, ATTACH TEST EQUIPMENT AND REAPPLY POWER TO TEST.

SYMPTOM	POSSIBLE CAUSES
Compartment leaks water around door.	<ol style="list-style-type: none"> 1. Steamer not level. 2. Steamer overfilled.
Steam leaks around door.	<ol style="list-style-type: none"> 1. Worn gasket. See "DOOR" in "SERVICE PROCEDURES AND ADJUSTMENTS". 2. Damaged gasket. 3. Steam vent pipe blocked.
Steam generated inside compartment when timer is off.	<ol style="list-style-type: none"> 1. Timer malfunction. 2. Contactor malfunction. 3. Temperature control malfunction (heater light on).
Steamer will not heat (heat light off).	<ol style="list-style-type: none"> 1. Line voltage incorrect. 2. Control circuit fuse(s) open. 3. High limit thermostat open (low water light off). 4. Door open or door switch malfunction. 5. Cooking mode switch off or inoperative. 6. Relay R1 malfunction. 7. Timer malfunction (timed mode only). 8. Temperature probe malfunction. 9. Temperature control malfunction.
Steamer will not heat (heat light on).	<ol style="list-style-type: none"> 1. Line voltage incorrect. 2. Heating element malfunction. 3. Contactor malfunction.
Timer motor does not run.	<ol style="list-style-type: none"> 1. Door open or door switch malfunction. 2. Relay R1 malfunction. 3. Timer inoperative.
Door not closing properly.	<ol style="list-style-type: none"> 1. Door latch assembly. 2. Striker adjustment. 3. Steamer pan not inserted properly.
Door won't open.	<ol style="list-style-type: none"> 1. Latch won't release. See "DOOR LATCH ADJUSTMENT" in "SERVICE PROCEDURES AND ADJUSTMENTS".
Buzzer not operating.	<ol style="list-style-type: none"> 1. Timer malfunction. 2. Buzzer malfunction.
Water spraying out of steam vent pipe during a "cook" cycle.	<ol style="list-style-type: none"> 1. Temperature control calibration to high. See "TEMPERATURE CONTROL CALIBRATION - ADJUSTMENT FOR ELEVATION" in "SERVICE PROCEDURES AND ADJUSTMENTS". 2. Temperature probe malfunction. 3. Temperature control malfunction. 4. Contactor malfunction.
High water usage.	<ol style="list-style-type: none"> 1. Temperature control calibration to high. See "TEMPERATURE CONTROL CALIBRATION - ADJUSTMENT FOR ELEVATION" in "SERVICE PROCEDURES AND ADJUSTMENTS". 2. Temperature probe malfunction. 3. Temperature control malfunction. 4. Steamer operating in "continuous" mode.
Excessive or inconsistent "cook" times.	<ol style="list-style-type: none"> 1. Door left open between loads. 2. Temperature control calibration to low. 3. Heating element malfunction. 4. Standby thermostat malfunction.

CONDENSED SPARE PARTS LIST

VPX3 & VPX5		
PART NUMBER	DESCRIPTION	NOTES
844385	Door Gasket (VPX5)	
844196	Door Gasket (VPX3)	
843811	Door Switch	
853928	Thermostat - Temperature Control	
853956	Thermostat - Standby	
853948	Thermocouple Sensor, J-Type	
853957	Fuse Block	
851929	Fuse, 1Amp 250v (208/240v)	
853270	Contactactor (208/240v)	
853493	High Limit Thermostat	
844422	Power Switch (cooking mode switch)	
853946	Element assy. 208v 9kW	
853945	Element assy. 208v 15kW	
853212	Element assy. 240v 9kW	
853213	Element assy. 240v 15kW	
411690-2	Timer, 60 min.	

Free Manuals Download Website

<http://myh66.com>

<http://usermanuals.us>

<http://www.somanuals.com>

<http://www.4manuals.cc>

<http://www.manual-lib.com>

<http://www.404manual.com>

<http://www.luxmanual.com>

<http://aubethermostatmanual.com>

Golf course search by state

<http://golfingnear.com>

Email search by domain

<http://emailbydomain.com>

Auto manuals search

<http://auto.somanuals.com>

TV manuals search

<http://tv.somanuals.com>