

VULCAN

INSTALLATION & OPERATION MANUAL

GAS RESTAURANT RANGES 90 SERIES AND VG SERIES

MODEL

24L	ML-52947
36L	ML-52948
481L	ML-52950
148L	ML-52951
60L	ML-52952
260L	ML-52954
VG24	ML-114553
VG36	ML-114554
VG60	ML-114555
VG260	ML-114557

PRIOR MLS COVERED IN THE CATALOG

48L	ML-52949
160L	ML-52953
VG48	ML-114957
VG160	ML-114556



For additional information on Vulcan-Hart or to locate an authorized parts and service provider in your area, visit our website at www.vulcanhart.com

VULCAN-HART
DIVISION OF ITW FOOD EQUIPMENT GROUP, LLC

P.O. BOX 696, LOUISVILLE, KY 40201-0696
TEL. (502) 778-2791

F-31055 Rev. D (02-04)

IMPORTANT FOR YOUR SAFETY

THIS MANUAL HAS BEEN PREPARED FOR PERSONNEL QUALIFIED TO INSTALL GAS EQUIPMENT, WHO SHOULD PERFORM THE INITIAL FIELD START-UP AND ADJUSTMENTS OF THE EQUIPMENT COVERED BY THIS MANUAL.

POST IN A PROMINENT LOCATION THE INSTRUCTIONS TO BE FOLLOWED IN THE EVENT THE SMELL OF GAS IS DETECTED. THIS INFORMATION CAN BE OBTAINED FROM THE LOCAL GAS SUPPLIER.

IMPORTANT

IN THE EVENT A GAS ODOR IS DETECTED, SHUT DOWN UNITS AT MAIN SHUTOFF VALVE AND CONTACT THE LOCAL GAS COMPANY OR GAS SUPPLIER FOR SERVICE.

FOR YOUR SAFETY

DO NOT STORE OR USE GASOLINE OR OTHER FLAMMABLE VAPORS OR LIQUIDS IN THE VICINITY OF THIS OR ANY OTHER APPLIANCE.

WARNING

IMPROPER INSTALLATION, ADJUSTMENT, ALTERATION, SERVICE OR MAINTENANCE CAN CAUSE PROPERTY DAMAGE, INJURY OR DEATH. READ THE INSTALLATION, OPERATING AND MAINTENANCE INSTRUCTIONS THOROUGHLY BEFORE INSTALLING OR SERVICING THIS EQUIPMENT.

IN THE EVENT OF A POWER FAILURE, DO NOT ATTEMPT TO OPERATE THIS DEVICE.

TABLE OF CONTENTS

GAS RESTAURANT RANGE MODELS	4
OPTIONAL FIELD INSTALLABLE ACCESSORIES	5
GENERAL	6
INSTALLATION	6
Uncrating	6
Location	6
Installation Codes and Standards	7
Assembly	7
Ranges Mounted on Casters	7
Bumper Bars (Convection Oven Ranges Only)	8
Installation of Broiler/Griddle Bricks	8
Installation of Standard Griddle Top Bricks	8
Installation of Hot Top Bricks	11
Backsplash	11
Leveling	14
Gas Connections	14
Testing the Gas Supply System	15
Flue Connections	16
Electrical Connections	16
OPERATION	17
Controls	17
Before First Use	17
Lighting and Shutting Down Pilots	17
Rack Arrangement - Standard Oven	22
Rack Arrangement - Convection Oven	22
Inserting and Removing Standard and Convection Oven Racks	23
Preheating	24
Loading and Unloading Standard and Convection Ovens	24
Cooking Chart	25
Cleaning	28
MAINTENANCE	31
Lubrication	31
Oven Door Gasket Replacement - Convection Oven Only	31
Vent	31
Service and Parts Information	31
TROUBLESHOOTING GUIDE	32

GAS RESTAURANT RANGE MODELS

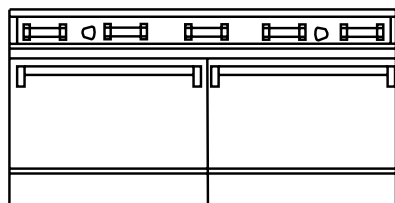

**60L, 60LC, 60LCC
VG60**

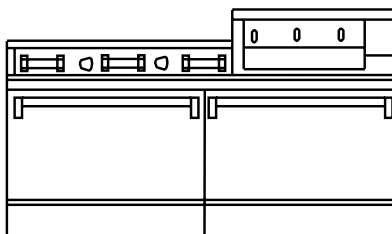

**260L, 260LC, 260LCC
VG260**

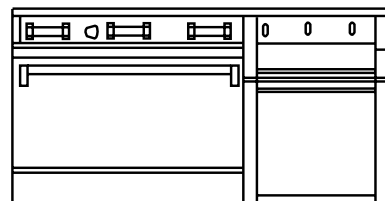

*** 160L, 160LC
VG160**

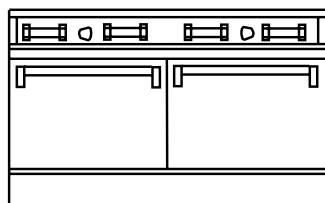

*** 48L/VG48**

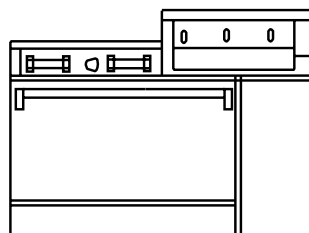

148L, 148LC

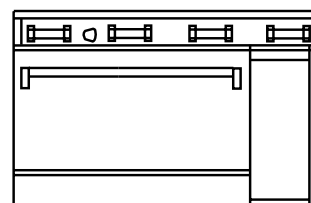

481L, 481LC

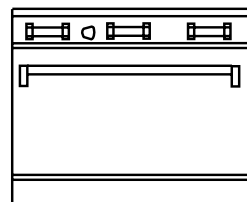

**36L, 36LC
VG36**

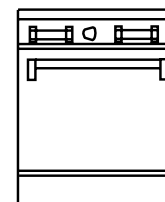

**24L
VG24**

PL-53007

NOTE: References to 90 Series Convection Ovens will include only the following models: 36LC, *148LC, 481LC, 60LC, 60LCC, *160LC, 260LC or 260LCC.

** Indicates discontinued model.*

OPTIONAL FIELD INSTALLABLE ACCESSORIES

DESCRIPTION	OPTIONS
Flue Devices	<ol style="list-style-type: none">1. Stainless steel backsplash with plate shelf.2. Stainless steel 11" (27.9 cm) low riser.
Flex Hose and Quick Disconnects	<ol style="list-style-type: none">1. $\frac{3}{4}$" (19 mm) flex hose/disconnect – 3 ft. (914.4 mm) long.2. $\frac{3}{4}$" (19 mm) flex hose/disconnect – 4 ft. (1219.2 mm) long.3. $\frac{3}{4}$" (19 mm) flex hose/disconnect – 5 ft. (1524 mm) long.
Oven Racks	<ol style="list-style-type: none">1. 1 extra rack – standard oven style.2. 1 extra rack – convection oven style.

Installation, Operation and Care of GAS RESTAURANT RANGES 90 SERIES AND VG SERIES

PLEASE KEEP THIS MANUAL FOR FUTURE REFERENCE

GENERAL

Vulcan ranges and ovens are produced with quality workmanship and material. Proper installation, usage and maintenance of your range will result in many years of satisfactory performance.

Vulcan-Hart suggests that you thoroughly read this entire manual and carefully follow all of the instructions provided.

INSTALLATION

UNCRATING

This range was inspected before leaving the factory. The transportation company assumes full responsibility for safe delivery upon acceptance of the shipment. Immediately after unpacking, check for possible shipping damage. If the range is found to be damaged, save the packaging material and contact the carrier within 15 days of delivery.

Uncrate unit carefully and place in a work-accessible area as near to its final installed position as possible. Remove all shipping wire and wood blocking.

Before installing, check the electrical service (convection oven series ranges only) and type of gas supply (natural or propane) to make sure they agree with the specifications on the rating plate located on the inside of the lower kick panel. If the supply and equipment requirements do not agree, do not proceed with the installation. Contact your dealer or Vulcan-Hart Company immediately.

LOCATION

The equipment area must be kept free and clear of combustible substances.

The range, when installed, must have a minimum clearance from combustible construction of 6" (152.4 mm) at the sides and 6" (152.4 mm) at the rear. Clearance from non-combustible construction is 0" at the sides and 6" (152.4 mm) at the rear.

The installation location must allow adequate clearances for servicing and proper operation. A minimum front clearance of 40" (101.6 cm) is required.

The range must be installed so that the flow of combustion and ventilation air will not be obstructed. Adequate clearance for air openings into the combustion chamber must be provided. Make sure there is an adequate supply of air in the room to allow for combustion of the gas at the burners.

INSTALLATION CODES AND STANDARDS

Ranges must be installed in accordance with:

In the United States of America

1. State and local codes.
2. National Fuel Gas Code, ANSI-Z223.1 (latest edition). Copies may be obtained from The American Gas Association, Inc., 1515 Wilson Blvd., Arlington, VA 22209.
3. National Electrical Code ANSI/NFPA-70 (latest edition). Copies may be obtained from The National Fire Protection Association, Batterymarch Park, Quincy, MA 02269.

In Canada

1. Local codes.
2. CAN/CGA-B149.1 Natural Gas Installation code (latest edition).
3. CAN/CGA-B149.2 Propane Installation Code (latest edition). Copies may be obtained from The Canadian Standards Association, 178 Rexdale Blvd., Etobicoke, Ontario, Canada M9W 1R3.
4. Canadian Electrical Code, CSA Standard C22.2, Part 3 (latest edition). Copies may be obtained from The Canadian Standards Association, 178 Rexdale Blvd., Etobicoke, Ontario, Canada M9W 1R3.

ASSEMBLY

Ranges Mounted on Casters

NOTICE: When the range is mounted on casters, it must be installed with the casters supplied, a connector (not supplied by Vulcan-Hart) complying with either ANSI-Z21.69 (latest edition) or CAN/CGA-6.16 (latest edition), and a quick-disconnect device complying with either ANSI-Z21.41 (latest edition) or CAN1-6.9 (latest edition). It must also be installed with restraining means to guard against transmission of strain to the connector, as specified in the appliance manufacturer's instructions. Attach the restraining device at the rear of the oven (Fig. 1).

Provide a gas line strain relief to limit movement of the range without depending on the connector and/or any quick-disconnect device or its associated piping to limit movement of the range. Attach the gas line strain relief to the rear of the range (Fig. 1).

Should it be necessary to disconnect the restraint, turn off the gas supply before disconnection. Reconnect the restraint before turning the gas supply on and returning the range to its installation position.

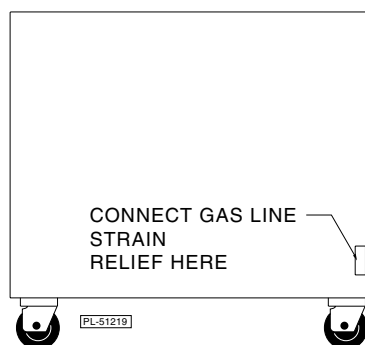

Fig. 1

Bumper Bars (Convection Oven Ranges Only)

CAUTION: Failure to install bumper bars may cause motor damage and will void the warranty.

Remove existing #10 screws. Position bumper bars (supplied) as shown. Replace #10 screws and secure bumper bars (Fig. 2).

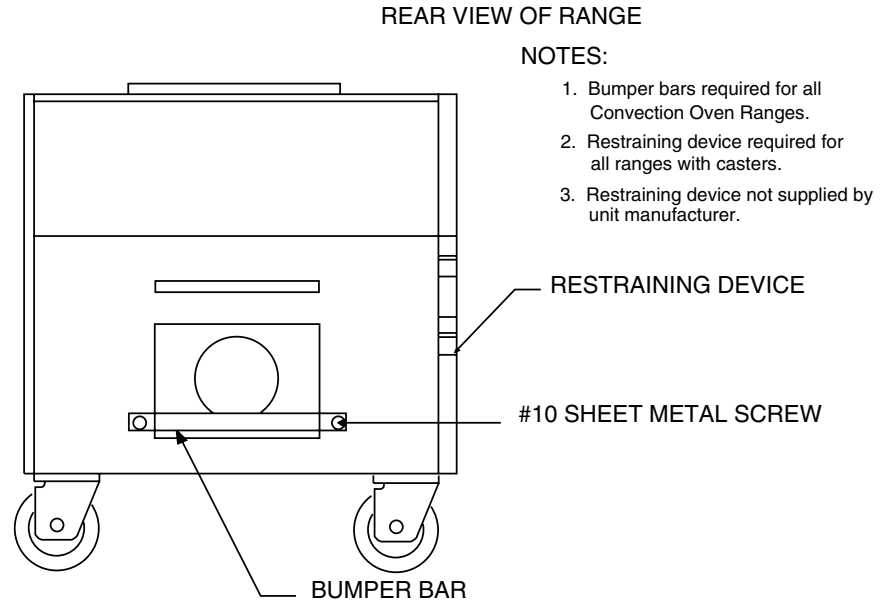

Fig. 2

Installation of Broiler/Griddle Bricks

The Restaurant Range broiler/griddle utilizes ceramic fire bricks for heat radiation of the burners. Install the broiler bricks before connecting the gas supply line.

1. Remove the six $5\frac{1}{4}$ " (133.4 mm) x $2\frac{1}{4}$ " (57 mm) and (6) $5\frac{1}{4}$ " (133.4 mm) x $5\frac{1}{16}$ " (128.6 mm) bricks from the shipping box.
2. Install the six $5\frac{1}{4}$ " (133.4 mm) x $2\frac{1}{4}$ " (57 mm) bricks to the left- and right-hand sides of the burner. To install the bricks, insert them one at a time through the opening in the front of the broiler. Angle the brick sideways so that it will slip between the burner edges. Set the bricks flat in place resting on these edges. Push each brick installed as far to the rear of the burner as possible so that the last brick will install easily (Fig. 3).
3. Install the six $5\frac{1}{4}$ " (133.4 mm) x $5\frac{1}{16}$ " (128.6 mm) bricks to the center burners as described in Step 2.

Installation of Standard Griddle Top Bricks

The griddle top section is extremely heavy. It will require three people to install the griddle and griddle brick — two people to lift the griddle plate and one person to set the bricks and griddle thermostat capillary bulb(s) in place.

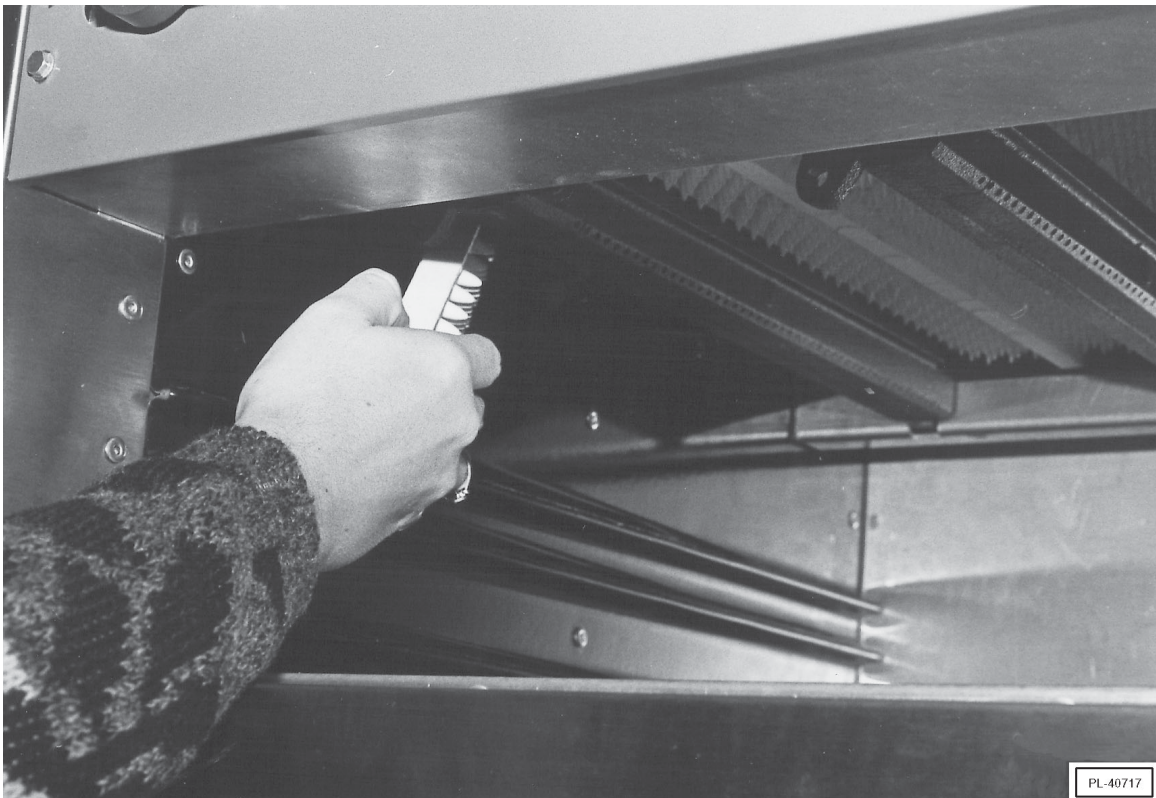

Fig. 3

The Restaurant Range griddle top section utilizes a two-fold baffle assembly to support the composite/mortar fire bricks. There will always be only one small 6 $\frac{1}{2}$ " (165 mm) wide baffle assembly with every griddle top order. There will be at least one 9 $\frac{7}{8}$ " (251 mm) wide baffle assembly per griddle, possibly more, depending on the griddle width.

The 6 $\frac{1}{2}$ " (165 mm) wide baffle will utilize two 10" x 4" (254 x 101.6 mm), and two 7" x 4" (177.8 x 101.6 mm) brick sets.

The 9 $\frac{7}{8}$ " (251 mm) wide baffle assembly will utilize two 10" x 4" (254 x 101.6 mm), and two 7" x 4" (177.8 x 101.6 mm) brick sets.

1. The griddle bricks are shipped in a rectangular cardboard box. Locate the box and carefully inspect quantities as explained above.

NOTE: If a brick has been broken into two pieces, it can still be used. Just place the pieces into position as shown in Fig. 4. However, if a brick is broken into more than two pieces, it will need to be replaced. Contact your local Vulcan servicer.

2. Clean anti-rust coating from top of griddle, following the procedures described in the CLEANING - GRIDDLE PLATE section of this manual.
3. Remove griddle plate. With one person at either side of the griddle, gently lift griddle straight up. **DO NOT** pull griddle forward until the third person has checked to ensure that the capillary bulb(s) (thermostatically controlled models only) are freed from the underside of the griddle plate. If bulb(s) are still attached to the griddle, pull capillary bulb(s) wire gently through the "V" shields until the bulb(s) are free. Rest the griddle plate in a secure place.

4. Exercise caution when placing brick in a thermostatically controlled griddle section. **DO NOT** hit thermostat bulb while installing bricks. The thermostat bulb is a sensitive device and may be easily knocked out of adjustment.

Into the 6 $\frac{1}{2}$ " (165 mm) wide baffle, install:

- a. Two 10" x 4" (254 x 101.6 mm) bricks, placing the miter edge, one to each side of the front burner baffle area (Fig. 4).
- b. Two 7" x 4" (177.8 x 101.6 mm) bricks, one to each side of the rear burner baffle area (Fig. 4).

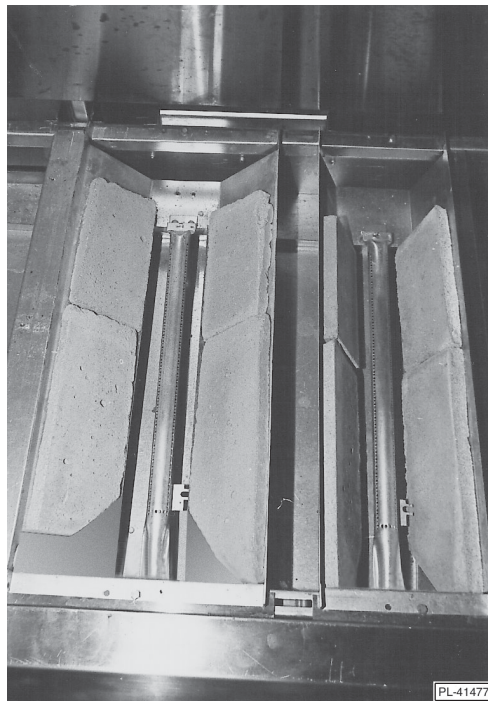

Fig. 4

5. Into the 9 $\frac{7}{8}$ " (251 mm) wide baffle, install:
 - a. Two 10" x 4" (254 x 101.6 mm) bricks, placing the miter edge, one to each side of the front burner baffle area (see Fig. 4).
 - b. Two 7" x 4" (177.8 x 101.6 mm) bricks, one to each side of the rear burner baffle area (see Fig. 4).
6. If burner has been strapped down, remove the wire strapping device, using wire cutters.

7. Check to ensure that all bricks and burners are secure. Carefully replace the griddle top section. When replacing griddle top section, be sure that the griddle capillary and bulb(s) are not in a position to be crushed. Gently pull the griddle capillary towards the front of the range and out from under the griddle area. While two people (one on each side of the griddle) are lowering the griddle into place, the third person must gently feed the griddle thermostat bulb(s) through the "V" shield(s) until completely covered. Also ensure that the capillary is not positioned over the burner flame pattern. Continue to lower the plate into place until it is resting evenly on top of the range.

Installation of Hot Top Bricks

The Restaurant Range hot top sections utilize composite/mortar fire bricks for heat distribution of the burners. Install these bricks before connecting the gas supply line or installing the back riser.

1. The composite/mortar bricks are shipped in a rectangular cardboard box. Locate box and carefully remove two 10" x 4" (254 x 101.6 mm), and two 7" x 4" (177.8 x 101.6 mm) bricks. There should be one box of bricks per hot top section ordered.

NOTE: If a brick has been broken into two pieces, it can still be used. Just place the pieces into position as shown in Fig. 4. However, if a brick is broken into more than two pieces, it will need to be replaced. Contact your local Vulcan servicer.

2. Rest the hot top plate in a secure area.
3. Install two 10" x 4" (254 x 101.6 mm) composite/mortar bricks, placing the miter edge, one to each side of the front burner baffle area (see Fig. 4).
4. Install two 7" x 4" (177.8 x 101.6 mm) bricks, one to each side of rear burner baffle area (see Fig. 4).
5. If burner has been strapped down, remove the wire strapping device, using wire cutters.
6. Check to ensure that all bricks and the burner are secure. Carefully replace the hot top section on top of the range.

Backsplash

The standard Restaurant Range is equipped with a 23" (58.4 cm) high backsplash and shelf.

1. Remove the backsplash components from the crating materials.
2. Check the backsplash component parts against the list on page 12 to ensure that all the required parts for the backsplash installation have been obtained. (See Fig's. 5 & 6.) If any parts are missing, contact your dealer or closest parts depot immediately.
3. Assemble the required components as shown in Fig's. 5 and 6.
4. Lift the assembly up, sliding the channels into the space provided at the rear of the range (this may require two people).

Backsplash Component Parts

MODELS				
24L/VG24	36L/VG36	*48L, 481L, & *148L *VG48	60L & *160L VG60/*160	260L/VG260
Std. 23" (58.4 cm) High Backsplash (1)	Std. 23" (58.4 cm) High Backsplash (1)	Std. 23" (58.4 cm) High Backsplash (1)	Std. 23" (58.4 cm) High Backsplash (1)	Std. 23" (58.4 cm) High Backsplash (1)
Backsplash Channel (2)	Backsplash Channel (2)	Backsplash Channel (2)	Riser Channel (1)	Backsplash Channel (2)
Heat Shield (1)	Heat Shield (1)	Heat Shield (48L) (1) Heat Shield (481L) (1)	Heat Shield (1)	Heat Shield (1)
#10 Sht. Metal Screw (16)	#10 Sht. Metal Screw (16)	#10 Sht. Metal Screw (16)	#10 Sht. Metal Screw (20)	#10 Sht. Metal Screw (4)
1/4"-20 x 2 ⁵ / ₁₆ " (58.7 mm) Lg. Machine Screw (4)	1/4"-20 x 2 ⁵ / ₁₆ " (58.7 mm) Lg. Machine Screw (4)	1/4"-20 x 2 ⁵ / ₁₆ " (58.7 mm) Lg. Machine Screw (4)	1/4"-20 x 2 ⁵ / ₁₆ " (58.7 mm) Lg. Machine Screw (4)	1/4"-20 x 2 ⁵ / ₁₆ " (58.7 mm) Lg. Machine Screw (6)
Shelf Assembly (1)	Shelf Assembly (1)	Shelf Assembly (1)	Shelf Assembly (1)	Shelf Assembly (1)

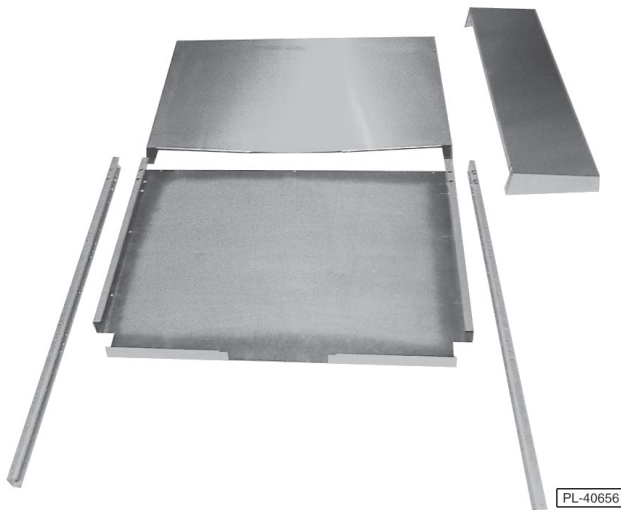

Fig. 5

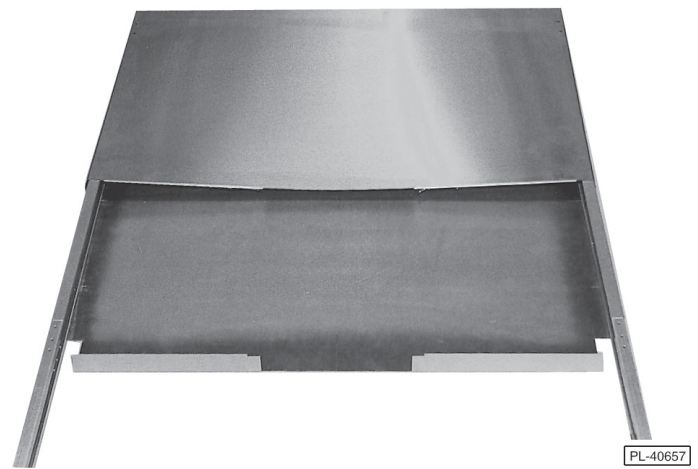

Fig. 6

* Indicates discontinued model.

5. It may be necessary to pull the heat shield bottom out slightly in order to clear the oven flue box area. Be sure the backsplash is resting evenly and the channel holes are lining up with the holes provided in the right- and left-hand body side (Fig's. 7 & 8).

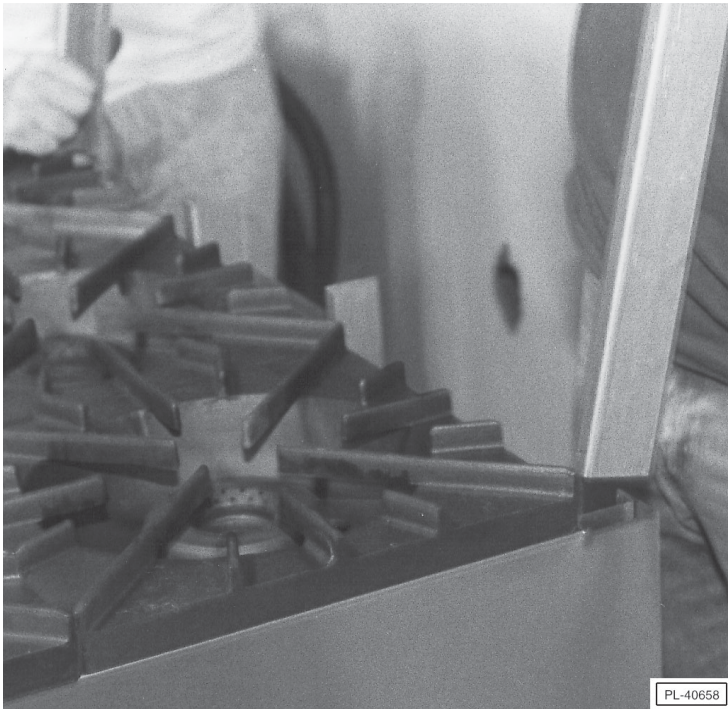

Fig. 7

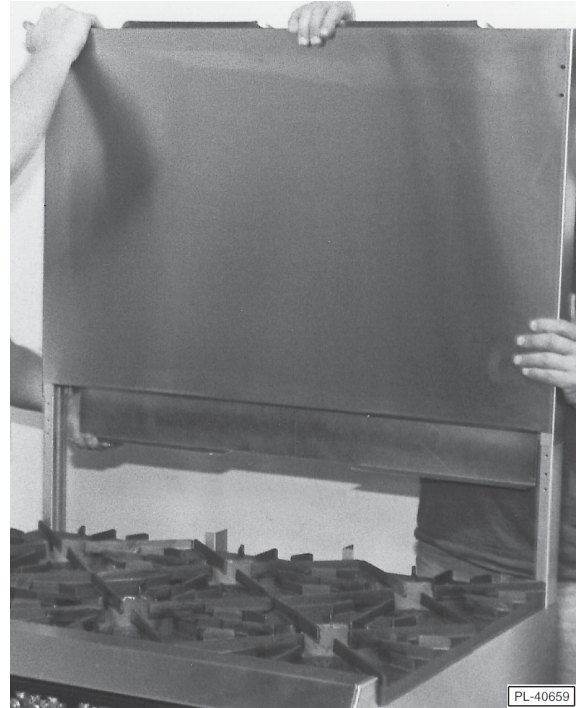

Fig. 8

6. Install eight #10 sheet metal screws (4 to each channel leg) (Fig. 9).

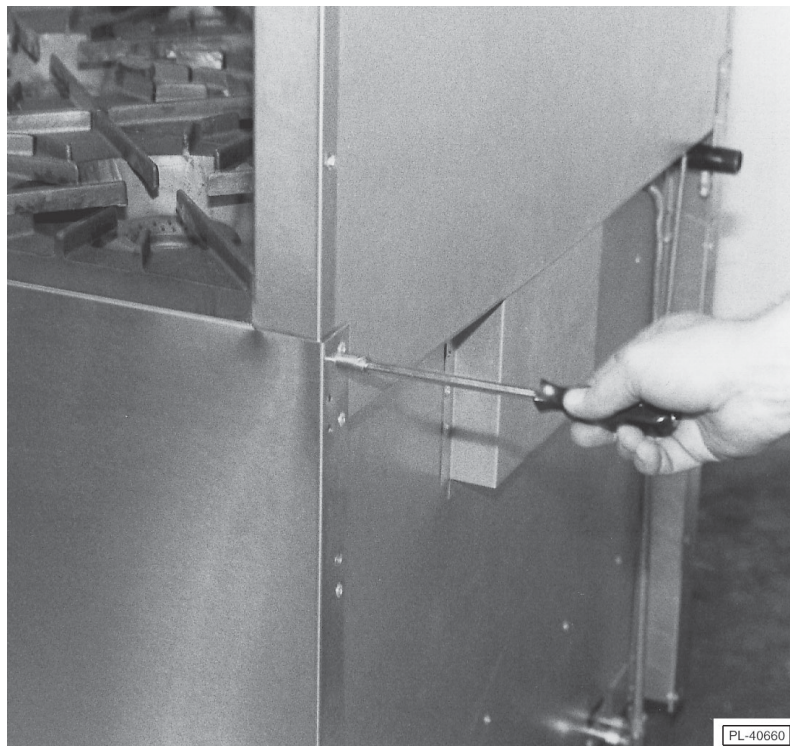

Fig. 9

7. From the front, install four $\frac{1}{4}$ -20 x $2\frac{5}{16}$ " (58.7 mm) long machine screws and secure bolts with locknuts. Do not tighten the screws all the way down. Leave about $\frac{1}{4}$ " (6.3 mm) of play in each screw (Fig. 10).
8. Lift the shelf up and slide the shelf into position over the screw heads (Fig. 11).
9. Tighten the four screws to secure the shelf.



Fig. 10

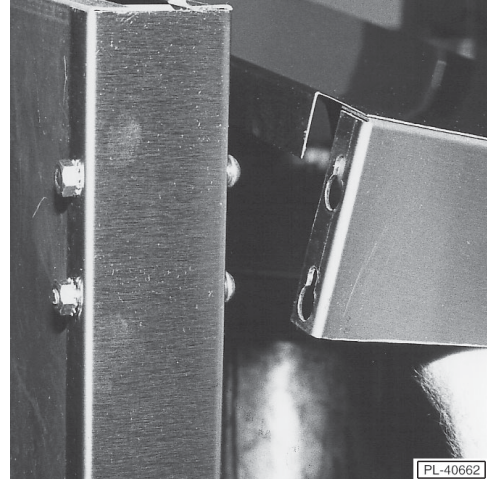

Fig. 11

LEVELING

Check the leveling of the range. Place a carpenter's level inside the oven cavity across the oven rack(s). Level front-to-back and side-to-side.

To adjust the leveling, tilt the range to one side and, using channel locks, unscrew the adjustable leg insert as required. Repeat this procedure as necessary for each leg.

Casters for this range are of the non-adjustable type. Therefore, the floor must be level. If floor surface is not level, the range will experience cooking problems.

GAS CONNECTIONS

CAUTION: All gas supply connections and any pipe joint compound used must be resistant to the action of propane gases.

Each range is factory-equipped for the type gas specified on the rating plate. The installation gas connection is a $\frac{3}{4}$ " (19 mm) 14 FPT ANSI schedule #40 standard pipe.

Connect gas supply. Make sure the pipes are clean and free of obstructions.

Codes require that a gas shutoff valve be installed in the gas line ahead of the range.

Standard ranges are equipped with fixed burner orifices which coincide with installation elevation.

Install the gas pressure regulator.

Before installing, ensure that regulator supplied agrees with rating plate gas supply.

As of 7/11/90, the gas pressure regulator is **NOT** factory installed. The regulator for this gas type is sealed within a plastic bag attached to the oven rack inside the oven cavity. This regulator must be field installed by a qualified installer.

Natural gas regulators are preset for 3.7" W.C. (Water Column) (.92 kPa); propane gas regulators for 10.0" W.C. (2.5 kPa)

1. Locate $\frac{3}{4}$ " (19 mm) gas connection pipe extending from rear of range.
2. Cover pipe threads with leak sealant.
3. Screw regulator hand-tight onto pipe with regulator arrow pointing towards range body back (Fig. 12).
4. Using pipe wrench, tighten regulator securely in an upright position (Fig. 12).

The arrow on the regulator shows the direction of the gas flow (Fig. 12). The pressure regulator must be mounted horizontally to ensure proper preset outlet pressure. If the regulator is installed in any other position, the outlet pressure must be reset for proper operation.

A leak limiter is supplied with every regulator to allow excess gas pressure to escape. Do not obstruct leak limiter on gas pressure regulator, as obstruction may cause regulator to malfunction.



Fig. 12

WARNING: PRIOR TO LIGHTING, CHECK ALL JOINTS IN THE GAS SUPPLY LINE FOR LEAKS. USE SOAP AND WATER SOLUTION. DO NOT USE AN OPEN FLAME.

After piping has been checked for leaks, all piping receiving gas should be fully purged to remove air.

Before operation, verify thermocouple is securely seated in the safety valve. The thermocouple should be tightened a $\frac{1}{4}$ turn past finger tight. **DO NOT OVERTIGHTEN.** Overtightening may damage the thermocouple or safety magnet.

TESTING THE GAS SUPPLY SYSTEM

When gas supply pressure exceeds $\frac{1}{2}$ psig (3.45 kPa), the range and its individual shutoff valve must be disconnected from the gas supply piping system.

When gas supply pressure is $\frac{1}{2}$ psig (3.45 kPa) or less, the range should be isolated from the gas supply system by closing its individual manual shutoff valve until the range is ready for start-up.

FLUE CONNECTIONS

DO NOT obstruct the flow of flue gases from the flue located on the rear of the range. It is recommended that the flue gases be ventilated to the outside of the building through a ventilation system installed by qualified personnel.

From the termination of the flue to the filters of the hood venting system, a minimum clearance of 18" (457 mm) must be maintained.

Information on the construction and installation of ventilating hoods may be obtained from the standard for the "Removal of Vapors from Commercial Cooking Equipment", NFPA No. 96 (latest edition), available from The National Fire Protection Association, Batterymarch Park, Quincy, MA 02269.

ELECTRICAL CONNECTIONS (CONVECTION OVEN MODELS [90 SERIES] ONLY)

WARNING: ELECTRICAL AND GROUNDING CONNECTIONS MUST COMPLY WITH THE APPLICABLE PORTIONS OF THE NATIONAL ELECTRICAL CODE AND/OR OTHER LOCAL ELECTRICAL CODES.



WARNING: DISCONNECT THE ELECTRICAL POWER TO THE MACHINE AND FOLLOW LOCKOUT / TAGOUT PROCEDURES.

WARNING: APPLIANCES EQUIPPED WITH A FLEXIBLE ELECTRIC SUPPLY CORD ARE PROVIDED WITH A THREE-PRONG GROUNDING PLUG. IT IS IMPERATIVE THAT THIS PLUG BE CONNECTED INTO A PROPERLY GROUNDED THREE-PRONG RECEPTACLE. IF THE RECEPTACLE IS NOT THE PROPER GROUNDING TYPE, CONTACT AN ELECTRICIAN. DO NOT REMOVE THE GROUNDING PRONG FROM THIS PLUG.

The range is designed for 120 volt power supply or an optional 240 volt single-phase 15 Amp power supply.

All 120 volt ranges are supplied with a flexible electric supply cord and plug and must be plugged into the proper receptacle before turning on gas. If the appliance is not equipped with a grounding plug and electric supply is needed, ground the appliance by using the ground lug provided. All 240 volt electric systems are manufactured for hard wire installation connections. (Refer to the wiring diagram inserted into this manual.) An electrical diagram is attached to the back near the motor mounting area.

Do not connect the range to electrical supply until after gas connections have been made.

OPERATION

WARNING: THE RANGE AND ITS PARTS ARE HOT. BE VERY CAREFUL WHEN OPERATING, CLEANING OR SERVICING THE RANGE.

CONTROLS

- THERMOSTAT DIAL - STANDARD OVEN — Allows operator to regulate oven temperature from low to 500°F (260°C).
- THERMOSTAT DIAL - CONVECTION OVEN — Snap-acting type control which allows operator to regulate oven temperature from 150°F to 500°F (65.5°C to 260°C).
- OPEN TOP BURNER KNOB -
STANDARD AND CONVECTION OVENS — Regulates gas flow to top burners. To increase heat, turn knob counterclockwise; to decrease, turn knob clockwise.
- POWER SWITCH - CONVECTION OVEN — ON-OFF switch controls power supply to convection oven control.
- HEATING LIGHT - CONVECTION OVEN — When lit, indicates that the oven thermostat is calling for heat to the oven.
- GRIDDLE BURNER KNOB -
STANDARD AND CONVECTION OVENS — Regulates gas flow to the griddle or hot top burner. To increase heat, turn knob counterclockwise; to decrease, turn knob clockwise.

BEFORE FIRST USE

Griddle Seasoning

CAUTION: This griddle plate is steel, but the surface is relatively soft and can be scored or dented by the careless use of a spatula or scraper. Be careful not to dent, scratch, or gouge the plate surface. Do not try to knock off loose food that may be on the spatula by tapping the corner edge of the spatula on the griddle surface.

A new griddle surface must be seasoned to do a good cooking job. The metal surface of the griddle is porous. Food tends to get trapped in these pores and stick; therefore, it is important to “season” or “fill up” these pores with cooking oil before cooking. Seasoning gives the surface a slick, hard finish from which the food will release easily.

To season, heat griddle top section at a low burner setting. Pour one ounce of cooking oil per square foot of surface over the griddle top section. With an insulated cloth, spread the oil over the entire griddle surface to create a thin film. Wipe off any excess oil with an insulated cloth.

Repeat this procedure 2 to 3 times until the griddle has a slick surface.

LIGHTING AND SHUTTING DOWN PILOTS

All adjustment procedures associated with pilot lighting must be performed **by an authorized Vulcan-Hart installation or service person.**

Hot Top and Griddle Top Burners

1. Turn main gas supply ON.
2. Wait 30 seconds and, using a taper, light the hot top or griddle top pilot (Fig. 13).

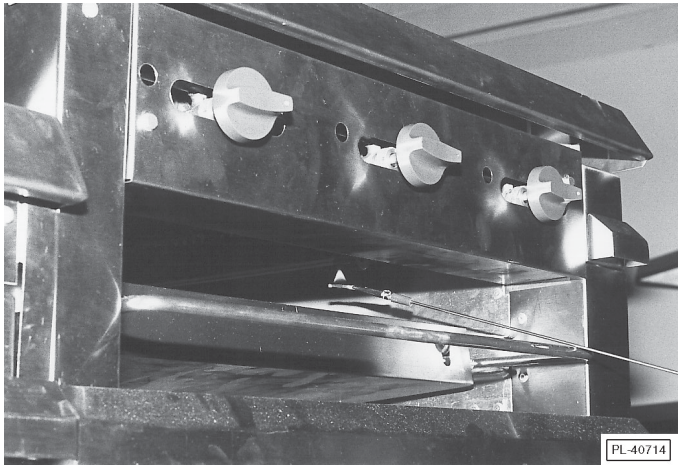

Shown with old style burner knobs

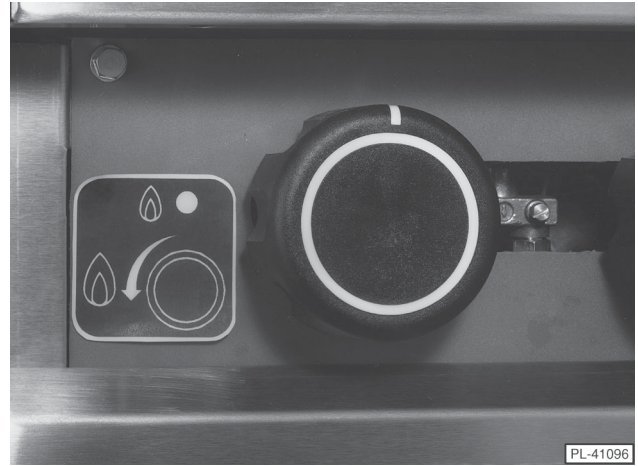

New style burner knobs effective 1/98

Fig. 13

3. If pilot fails to light, turn main gas supply OFF. Wait 5 minutes and repeat the above procedures.
4. Turn one hot top or griddle top burner valve ON to remove air from the gas line. Turn burner valve OFF when gas begins to flow.

Nightly Shutdown: Turn burner valve OFF; pilot will remain lit.

Complete Shutdown

1. Turn burner valve OFF; pilot will remain lit.
2. Turn main gas supply OFF.

Open Top Burners

1. Turn main gas supply ON.
2. Wait 30 seconds and, using a taper, light the open top pilot (Fig. 14).

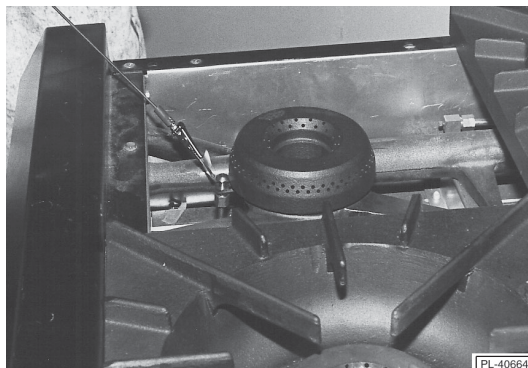

Fig. 14

3. If pilot fails to light, turn main gas supply OFF. Wait 5 minutes and repeat the above procedures.
4. Turn one open top burner valve ON to remove air from the gas line. Turn burner OFF when gas begins to flow.

Nightly Shutdown: Turn burner valve OFF; pilot will remain lit.

Complete Shutdown

1. Turn burner valve OFF; pilot will remain lit.
2. Turn main gas supply OFF.

Broiler/Griddle

1. Turn main gas supply ON.
2. Wait 30 seconds and, using a taper, light broiler/griddle pilot (see Fig. 13).
3. If pilot fails to light, turn main gas supply OFF. Wait 5 minutes and repeat Steps 1 and 2.
4. Turn burner valve ON to purge air from the lines. Turn burner valve OFF when gas begins to flow.

Nightly Shutdown: Turn burner valve OFF; pilot will remain lit.

Complete Shutdown

1. Turn burner valve OFF; pilot will remain lit.
2. Turn main gas supply OFF.

Standard Oven

Light open top/griddle pilots before lighting oven pilot.

1. Open kick panel and lift up the pilot lighting hole cover (Fig. 15).



Fig. 15

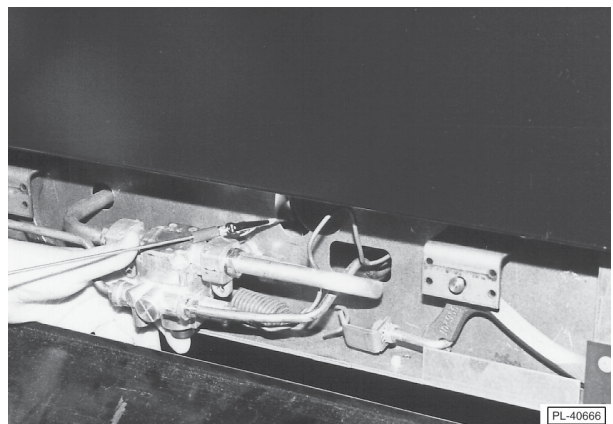

Fig. 16

2. Light pilot by depressing the reset button located behind the kick panel (Fig. 16). Continue to hold reset button in for 1 minute. If pilot fails to light, turn main gas supply OFF and wait 5 minutes before repeating Step 2.

3. After pilot is lit, turn the thermostat to the desired setting.

Nightly Shutdown: Turn oven thermostat OFF.

Complete Shutdown

1. Turn oven thermostat OFF.
2. Turn main gas supply OFF.

Standard Oven with Spark Ignition (Fig. 17)

1. Move toggle switch to ON position. Oven On Light will illuminate. The oven pilot will automatically light.
2. Once the oven pilot is established, the oven READY light will illuminate.
3. Set oven thermostat to desired temperature.

Nightly Shutdown: Push toggle switch to OFF position.

Complete Shutdown

1. Push toggle switch to OFF position.
2. Turn main gas supply OFF.

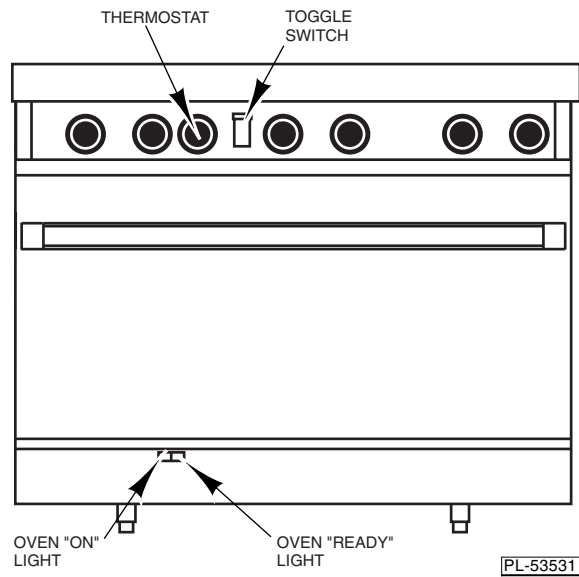

Fig. 17

Convection (Snorkel®) Oven (90 Series Only)

Light open top/griddle pilots before lighting oven pilot.

1. Open the kick panel and lift up the pilot lighting hole cover (see Fig. 15).
2. Turn red gas valve ON (located behind the kick panel), purging the gas line of all air (Fig. 18). Turn gas valve and power switch OFF. Close oven door.
3. Light oven pilot by depressing the reset button (Fig. 19) and, using a taper, ignite the pilot. Hold reset button in for 30 seconds or until pilot remains lit. Turn gas valve ON.

4. If pilot fails to light, turn main gas supply OFF. Wait 5 minutes and repeat Steps 2 and 3.
5. After pilot is lit, push the power switch ON and turn the thermostat to the desired setting.

Nightly Shutdown: Turn the power switch OFF and the thermostat to 0 degrees.

Complete Shutdown

1. Push power switch OFF.
2. Turn red gas valve OFF (behind kick panel).
3. Turn main gas supply OFF.
4. Disconnect electrical supply cord.

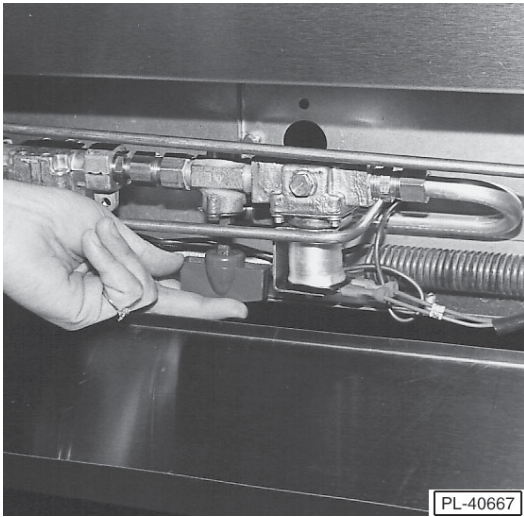

Fig. 18

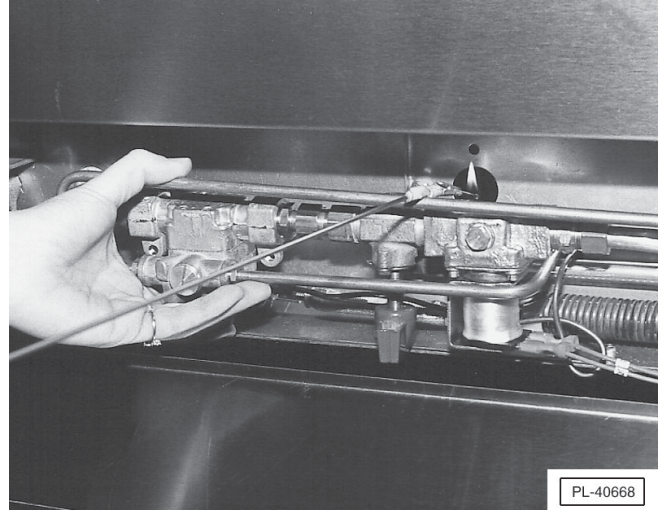

Fig. 19

Convection (Snorkel®) Oven With Spark Ignition (Fig. 20)

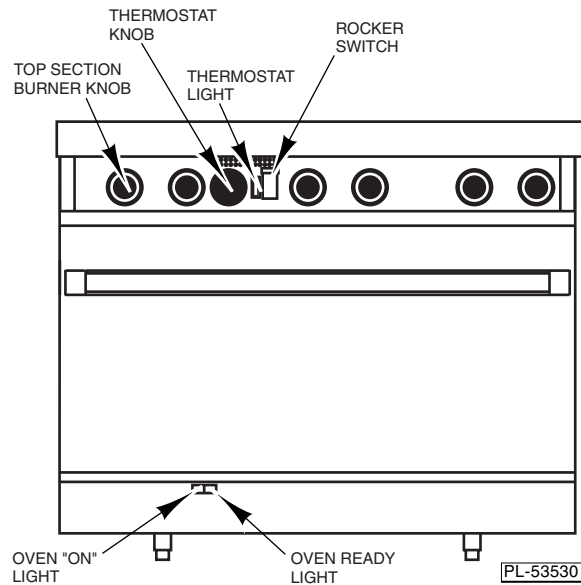

Fig. 20

1. Move rocker switch to ON position (oven ON light will illuminate). The oven pilot will automatically light.
2. Once the oven pilot is established, the oven READY light will illuminate.
3. Set oven thermostat to desired temperature. (The thermostat light will illuminate. This indicates that the thermostat is calling for heat.)

The convection oven thermostat must be ON and calling for heat for the oven pilot to light.

Nightly Shutdown: Push rocker switch and turn all knobs to the OFF position.

Complete Shutdown

1. Push rocker switch and turn all knobs to the OFF position.
2. Turn main gas supply OFF.

RACK ARRANGEMENT - STANDARD OVEN

The standard oven has two rack positions and is supplied with one oven rack. Additional racks may be obtained through a Vulcan-Hart parts depot.

For best results when baking cakes and pastries, it is recommended that only a single rack position be utilized. However, proper rack usage and positioning is really determined by the individual cooking needs of the operator. If you are cooking a large roast, the entire oven cavity may be utilized. Remove the oven rack completely from the range and place the roasting pan directly on the oven bottom.

RACK ARRANGEMENT - CONVECTION OVEN (90 SERIES ONLY)

The convection (Snorkel®) oven is supplied with three oven racks (maximum capacity). The oven cavity provides a 5-position rack support for maximum cooking flexibility. The arrangements described below are the most commonly recommended. The rack positions are numerically sequenced starting at the bottom.

Arrangement #1

Three racks in Positions 1, 3, and 5 for oven broiling, baking cookies, or reconstitution of frozen meals. This is also the recommended position arrangement for general baking in sheet pans with products not over 2½" (63.5 mm) high.

Arrangement #2

Two racks in Positions 2 and 4 for general baking in sheet pans, muffin pans, pie or cake tins and pudding pans 3½" (88.9 mm) high with products not over 4" (101.6 mm) high. This arrangement may also be used for casseroles or meat dishes in #200 series food service pans 12" x 20" x 2½" (304.8 x 508 x 63.5 mm).

Arrangement #3

Two racks in Positions 1 and 4 for baking breads or cakes in loaf or tube pans and high meringue pies. This arrangement may also be used for casseroles, meat dishes or roasting in pans up to 4½" (114.3 mm) deep with products up to 5" (127 mm) high.

When mix loading of food products is a regular kitchen practice, some operators have developed other rack position arrangements to suit their particular needs.

INSERTING AND REMOVING STANDARD AND CONVECTION OVEN RACKS

The oven rack has a stop to keep the rack from being pulled all the way out when unloading product. To install rack, place rack along side of top of side liner runners and slide rack completely to the rear of the oven compartment until rack drops into place (Fig's. 21 & 22).

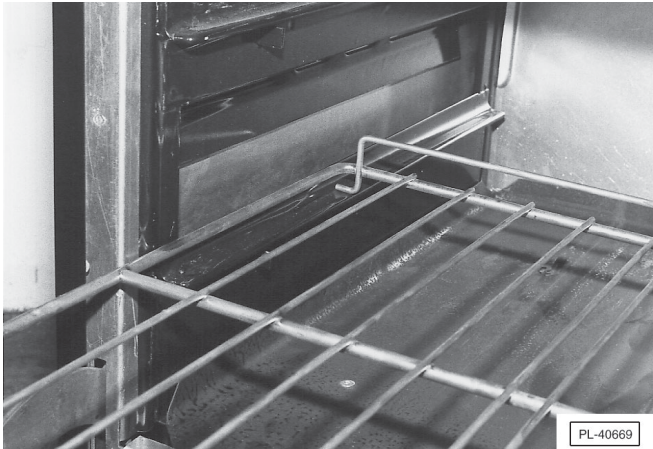

Fig. 21

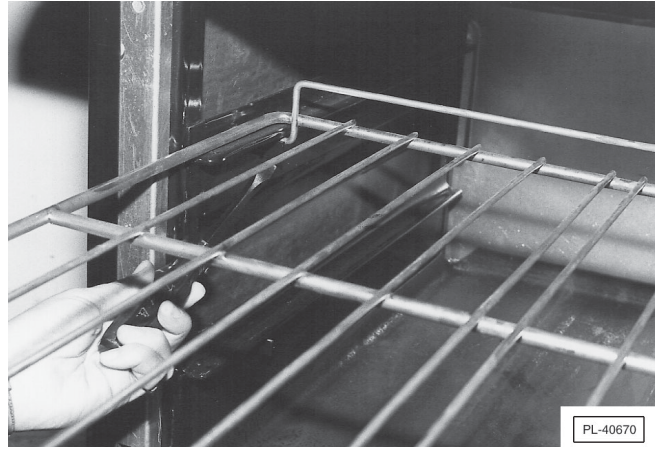

Fig. 22

To remove rack, reverse the procedure above by raising rear of oven rack stop above runner and pulling rack forward (Fig. 23).



Fig. 23

PREHEATING

Standard Oven

Turn thermostat control to the desired cooking temperature and preheat oven for 25 minutes. To save on gas consumption, do not operate oven at maximum heat when it is not necessary. Turn thermostat down to 250°F (121°C) or OFF when oven is not in use or during idle cooking periods.

Convection Oven (90 Series Only)

With power switch in the ON position, turn oven thermostat knob to the proper cooking temperature and allow oven to preheat for 15 minutes. To save on gas and electrical consumption, turn thermostat to one-half the cooking temperature or completely OFF during idle cooking periods.

Hot Top Burners

Turn burner ON to highest heat to heat hot top section quickly. Hot top will be ready to cook on in about 10 minutes. After top section has reached operation temperature, turn some of the burners down. You will save as much as 80% of gas consumption and notice very little difference in cooking performance as long as you have allowed the entire hot top section to preheat properly.

Open Top Burners

Open top burners ignite quickly and do not require any preheating time. When food comes to a rolling boil, cut back to slower boil to conserve energy, yet continue boiling. Turn burners ON only when in use.

Broiler/Griddle

Turn the three manual gas valve knobs to full ON. After preheating for 5 minutes, turn valves down until desired flame or heating level is achieved. Position the removable broiler grid into one of the two slide positions, depending on which will achieve the proper product results.

LOADING AND UNLOADING STANDARD AND CONVECTION OVENS

WARNING: WHEN USING CONVECTION OVENS, DO NOT STAND DIRECTLY IN FRONT OF THE OVEN WHILE OPENING THE OVEN DOOR. ALTHOUGH OPENING THE OVEN DOOR WILL AUTOMATICALLY SHUT THE FAN OFF, SOME HEAT ESCAPES. STEP AWAY TO AVOID HOT AIR.

Open the door and load as quickly as practical to conserve heat. Take care to avoid spilling liquids while loading. Close the door and refer to recipe for cooking time.

Provide adequate space for product unloading. Rapid unloading will conserve heat and reduce preheating for the next load.

COOKING CHART

Recommended temperatures and times are intended as a guide only. Adjustments must be made to compensate for elevation, variations in recipes, ingredients, preparation and personal preference on product appearance.

Meat roasting is most satisfactory at temperatures of 225°F to 325°F (107°C to 162.7°C) for beef, lamb, poultry and ham, and 325°F (162.7°C) for fresh pork as recommended by USDA and American Meat Institute.

A pan, approximately 12" x 20" x 1" (304.8 x 508 x 25.4 mm), full of water may be placed in the oven bottom to supply humidity; this will reduce shrinkage. Water should be added if necessary during roasting.

Roasting pans should be no deeper than necessary to hold drippings, usually 2" to 2½" (50.8 to 63.5 mm).

Cooking time and shrinkage may vary with roasting temperature, cut, grade of meat and degree of doneness. Smaller cuts will generally show greater time savings than larger cuts at a given temperature.

ROASTING TEMPERATURES AND TIMES

PRODUCT	TEMPERATURE	APPROXIMATE TIME
Standing Rib Roast Oven Ready - 15 lbs. (6.8 kg)	250°F/121°C	3-4 Hrs. - Rare 4-4½ Hrs. - Med.
Rolled Rib Roast - 20-22 lbs. (9.1-10 kg)	275°F/135°C	4 Hrs. - Med.
Veal Roast - 15 lbs. (6.8 kg)	300°F/148.9°C	3 Hrs. - Med. Well
Turkey - 15-20 lbs. (6.8-9.1 kg)	300°F/148.9°C	3 Hrs.
Meat Loaf - 8-10 lbs. (3.6-4.5 kg)	350°F/176.7°C	45 to 60 Min.

RECOMMENDED TEMPERATURES, TIMES AND LOADS FOR BAKING

PRODUCT	TEMPERATURE	APPROXIMATE TIME (MIN.)
Cakes (Standard Oven)		
3½ lbs. Sheet Cakes - 18 x 26 x 1"	350°F/176.7°C	45 Min.
3½ lbs. Sheet Cakes - 12 x 18 x 2"	350°F/176.7°C	1 Hr. and 15 Min.

PRODUCT	TEMPERATURE	APPROXIMATE TIME (MIN.)
Angel or Sponge Cakes Sheet pans 18 x 26 x 1" (457 x 661 x 25.4 mm) Scaled 5-6 lbs. (2.3-2.7 kg) per pan	300 to 325°F/148.9 to 162.8°C	15 to 20
Loaf or Tube Pans	315 to 340°F/157.2 to 171°C	20 to 30
Cup Cakes	350 to 400°F/176.7 to 204.4°C	6 to 12
Frozen Fruit Pies	350 to 375°F/176.7 to 190.5°C	30 to 45
Pumpkin or Custard Pies	300 to 350°F/148.9 to 176.7°C	30 to 45
Cobblers 12 x 18 x 2" or 12 x 20 x 2½" pans (304.8 x 661 x 50.8 mm or 304.8 x 508 x 63.5 mm)	350 to 400°F/176.7 to 204.4°C	30 to 45
Meringue Pies	350 to 425°F/176.7 to 218.3°C	6 to 10
Fruit Turnovers Sheet pans	350 to 375°F/176.7 to 190.5°C	15 to 25
NOTE: Cobblers, fruit, custard and pumpkin pies should be placed on sheet pans for baking.		
Cookies Rolled or Pressed Drop	350 to 400°F /176.7 to 204.4°C 350 to 400°F/176.7 to 204.4°C	6 to 12 6 to 15
Brownies	350°F/176.7°C	12 to 20
Yeast Breads		
NOTE: Yeast breads should be fully proofed for best results.		
Rolls - 1 oz. (.28 grams) 1½ to 2½ oz. (42.5 to 70.8 grams)	350 to 400°F/176.7 to 204.4°C 350 to 400°F/176.7 to 204.4°C	5 to 10 8 to 15
Loaf Bread - 1 lb. (0.5 kg)	325 to 375°F/162.8 to 190.5°C	20 to 40
Sweet Rolls and Pastries	325 to 375°F/162.8 to 190.5°C	5 to 15
Biscuits - Rolled ½" (12.7 mm) thick	350 to 400°F/176.7 to 204.4°C	5 to 15
Muffins	325 to 375°F/162.8 to 190.5°C	6 to 18
Corn Bread 18 x 26 x 1" (457 x 661 x 25.4 mm) pan, 5-7 lbs. (2.3-3 kg) per pan 18 x 26 x 2" (457 x 661 x 50.8 mm) pan, 8-20 lbs. (3.6-9.1 kg) per pan	335 to 400°F/168.3 to 204.4°C 335 to 400°F/168.3 to 204.4°C	10 to 20 15 to 25
Corn Muffins	335 to 385°F/168.3 to 196°C	10 to 20

OVEN BROILING OR FRYING

PRODUCT	TEMPERATURE	APPROXIMATE TIME (MIN.)
Hamburger Patties		
8 per lb. (0.5 kg) - Med. well done	400 to 450°F/204.4 to 232.2°C	5 to 6
6 per lb. (0.5 kg)	400 to 450°F/204.4 to 232.2°C	7 to 10
4 per lb. (0.5 kg)	375 to 385°F/190.5 to 196°C	8 to 12
Fish Sticks & Portions		
Frozen bread. - 1 oz. (28.3 grams)	350 to 400°F/176.7 to 204.4°C	6 to 10
2½ to 3 oz. (70.8 to 85 grams)	350 to 375°F/176.7 to 190.5°C	8 to 15
Chicken Pieces		
Broiled or Oven Fried		
2 to 2½ lbs. (0.9 to 1.1 kg)	375 to 425°F/190.5 to 218.3°C	8 to 15
2½ to 3 lbs. (1.1 to 1.4 kg)	350 to 400°F/176.7 to 204.4°C	15 to 25
Lobsters		
1 to 1½ lbs. (0.5 to 0.6 kg)	400 to 450°F/204.4 to 232.2°C	12 to 16
Lobster Tails		
Frozen, ½ to 1 lb. (0.2 to 0.5 kg)	350 to 400°F/176.7 to 204.4°C	16 to 20

REHEATING PREPARED FOODS

Frozen French Fries	400 to 450°F/204.4 to 232.2°C	6 to 8
Frozen TV Dinners	350 to 400°F/176.7 to 204.4°C	10 to 12
Frozen Entrees - 1" (25.4 mm) thick	300 to 350°F/148.9 to 176.7°C	10 to 20
Frozen Meals		
8 oz. (0.2 kg) foil package	350 to 400°F/176.7 to 204.4°C	20 to 30

CASSEROLES

Food Service Pans		
2" to 3" (50.8 to 76.2 mm) deep	325 to 375°F/162.8 to 190.5°C	15 to 25
3" to 4" (76.2 to 101.6 mm) deep	325 to 375°F/162.8 to 190.5°C	20 to 35
Ramekins or Foil Pans		
Up to 1½" (38 mm) Deep	350 to 400°F/176.7 to 204.4°C	5 to 6
Frozen	350 to 400°F/176.7 to 204.4°C	10 to 15

MISCELLANEOUS PRODUCTS

PRODUCT	TEMPERATURE	APPROXIMATE TIME (MIN.)
Baked Potatoes		
120 count per 50 lbs (22.7 kg)	400 to 450°F/204.4 to 232.2°C	25 to 35
100 count per 50 lbs. (22.7 kg)	400 to 450°F/204.4 to 232.2°C	35 to 45
80 count per 50 lbs. (22.7 kg)	400 to 450°F/204.4 to 232.2°C	40 to 60
Pizzas		
Frozen or with prebaked crust	425 to 475°F/218.3 to 246°C	5 to 10
Grilled Cheese Sandwiches	400 to 425°F/204.4 to 218.3°C	8 to 10

SPECIAL BAKING PROCEDURES

YEAST BREADS: Cooking starts immediately in the convection oven. Yeast breads do not usually rise as much in the convection oven as in a conventional oven. Therefore, it is necessary to allow 2½ to 3 times longer for the dough to reach its proofing capacities.

PIES: When baking pies in your convection oven, 3 or 4 pies should be put on an 18 x 26" (457 x 661 mm) sheet or bun pan. This procedure helps the bottom crust to bake, makes handling easier and reduces the possibility of boil-over, spoiling the appearance of the pies on the lower racks.

CLEANING

Do not use Dawn® dish detergent to clean the exterior or interior components of the range.

Do not use scouring powder. It is extremely difficult to remove completely. It can build up accumulations that will damage the oven.

Vulcan painted surfaces may be cleaned using a soft cloth and mild detergent solution.

RANGES

Daily:

Remove nickel-plated racks and clean in a sink.

While still warm, wipe top with a soft cloth or other grease absorbing material to remove spillovers, grease, etc., before they burn in. A crust on top of the hot top range looks unsightly and slows down cooking speed because it reduces the flow of heat to the utensil.

Clean oven and oven door daily, especially if fruit pies or tomato sauces were baked, meats roasted, and if there have been spillovers.

After processing some foods at low temperatures, odors may linger in the oven. These odors may be cleared by setting the thermostat at 500°F (260°C) and allowing the oven to operate unloaded for 30 to 45 minutes.

Empty the broiler grease pan/trough daily or as often as necessary. **CAUTION: Remove the grease pan/trough slowly and be careful of liquid wave action.** It is recommended that the grease pan/trough be emptied whenever it is $\frac{3}{4}$ filled. The drip shield, grids and grease pan/trough should be washed with a mild grease-dissolving solution. Some chefs scrape the grid with a three-cornered metal scraper. Scrub the broiler chamber and body front frequently and you will have less smoking.

Clean cast iron open top grates with a mild soap and water solution. Rinse thoroughly and dry with a clean, water-absorbent towel. Immediately after drying (with grates still removed from the range top), season grates lightly with liquid vegetable or Pam spray-type cooking oil.

After seasoning, replace grates onto the range. Turn all open top sections ON LOW and allow them to burn for at least 15 minutes before using pots or pans on the range top.

Season the open top grates after each cleaning. Failure to season grates will cause grates to rust.

Weekly:

Boil burners in a solution of washing soda. Rinse and dry parts thoroughly. Flash rusting may occur. This is a normal condition and will not affect the performance or the product prepared.

When reinstalling the burner back onto the range, be sure the burner heads are properly connected. Do not light the pilot or turn burner valve ON with the burner head removed.

CONVECTION OVENS (90 SERIES) ONLY

The Snorkel tube opening must be kept clear from blockage. If usage of aluminum foil is a common practice during the operation of this oven, be sure to periodically check the Snorkel tube for foil particles. Clean this tube with standard oven cleaner at least once a week. Be sure to thoroughly clean all cleansing solution off the tube before using oven again. It is also recommended that the oven be run at 400°F (204°C) for 20 minutes to burn off any cleaning solution that was not thoroughly rinsed from the tube.

Oven Door Gasket: (90 Series Connection Ovens Only)

To clean the oven door gasket, use a soft cloth or sponge and a mild cleanser. **DO NOT USE STRONG OVEN CLEANERS SUCH AS EASY OFF® OR MR. MUSCLE®.** Cleaners of this nature will destroy the gasket material.

GRIDDLE PLATE

Cleaning the griddle section will produce evenly cooked, perfectly browned griddle products and will keep the cooking surface free from carbonized grease. Carbonized grease on the surface hinders the transfer of heat to the food. This results in loss of cooking efficiency and spotty browning which gives foods an unappetizing appearance. To keep the griddle clean and operating at peak efficiency, follow these simple instructions:

After Each Use:

Carefully clean griddle with wire brush or flexible spatula.

Daily:

Thoroughly clean backsplash, sides and front. Remove grease pan, empty and wash out in the same manner as any ordinary cooking utensil.

Clean griddle surface thoroughly. If necessary, use a griddle stone, wire brush or steel wool over the surface. Rub with the grain of the metal while still warm. A detergent may be used on the plate surface to help clean it, but the cleaner must be thoroughly removed. After removal of detergent, the surface of the plate must be reseasoned with a thin film of oil to prevent rusting and food sticking.

If the griddle is to be shut down for an extended period, put a heavy coat of grease over the griddle plate.

MAINTENANCE

WARNING: THE RANGE AND ITS PARTS ARE HOT. BE VERY CAREFUL WHEN OPERATING, CLEANING OR SERVICING THE RANGE.

LUBRICATION

All Vulcan convection oven motors are permanently lubricated and require no additional maintenance.

OVEN DOOR GASKET REPLACEMENT - CONVECTION OVEN (90 SERIES) ONLY

To remove the old gasket, gently pry the arrow-like gasket pins from the oven front frame using a standard screwdriver.

Install new gasket by aligning and inserting the arrow-like pins into the holes provided in the front frame (Fig's. 24 & 25).



Fig. 24

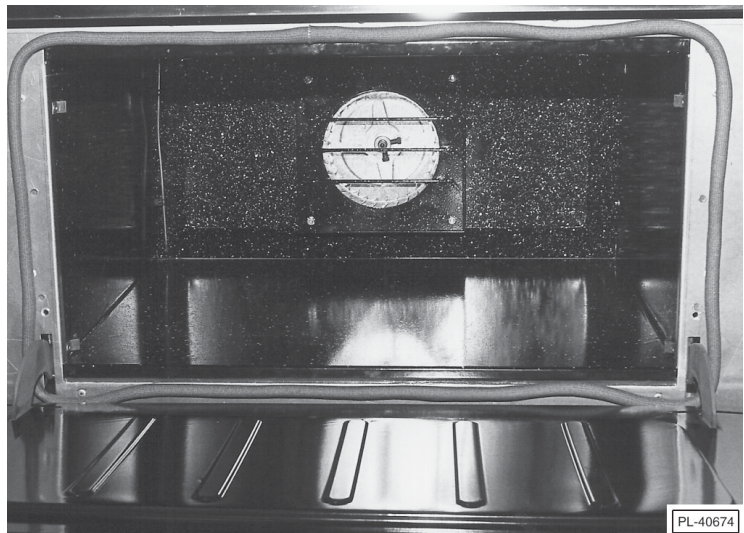

Fig. 25

VENT

When cool, the vent should be checked every six months for obstructions.

SERVICE AND PARTS INFORMATION

To obtain service and parts information concerning this range, contact the Vulcan-Hart Service Depot in your area (refer to listing supplied with the range), or Vulcan-Hart Company Service Department at the address or phone number shown on the front cover of this manual.

TROUBLESHOOTING GUIDE

STANDARD AND CONVECTION OVEN RESTAURANT RANGE

OVEN

PROBLEM	CAUSES
1. Too much bottom heat 1a. Too low temperature 1b. Side burning 1c. Too much top heat	a) Insufficient ventilation b) Improper fluing c) Improper thermostat bypass setting d) Thermostat out of calibration e) Fluctuating gas pressure
2. Uneven bake side to side	a) Not level side to side b) Oven burner, bottom or baffles improperly installed c) Warped pans
3. Uneven bake front to rear	a) Overactive flue b) Not level front to back; check casters and legs c) Door not closing properly
4. Dried out products	a) Too low temperature (overcooking) b) Too long baking time c) Thermostat calibration
5. Pilot outage	a) Pilot flame too low b) Restriction in pilot orifice c) Problem with shutoff valve d) Possible fluing problems e) Low pressure f) Improper gas line sizing g) Burner box cover not properly installed h) Oven cavity requires resealing

TOP BURNER OPERATION

1. Improper burner combustion Excessive valve handle temperatures Sticking top burner valves	a) Improper ventilation b) Poor door fit c) Oven door left open d) Improper use of excessively large pans or pots
2. Poor ignition	a) Insufficient input b) Poor air-gas adjustment c) Restriction in pilot orifice d) Restriction in main burner ignition port

Free Manuals Download Website

<http://myh66.com>

<http://usermanuals.us>

<http://www.somanuals.com>

<http://www.4manuals.cc>

<http://www.manual-lib.com>

<http://www.404manual.com>

<http://www.luxmanual.com>

<http://aubethermostatmanual.com>

Golf course search by state

<http://golfingnear.com>

Email search by domain

<http://emailbydomain.com>

Auto manuals search

<http://auto.somanuals.com>

TV manuals search

<http://tv.somanuals.com>