



BAMBOO™



User's manual for Windows® & Macintosh®

Bamboo Touch (CTT-460)

Bamboo Pen (CTL-460)

Bamboo & Bamboo Fun (CTH-460, CTH-461, CTH-661)

Setting up

Navigate with touch

Customize touch

ExpressKeys

Use a pen

Customize a pen

Troubleshooting

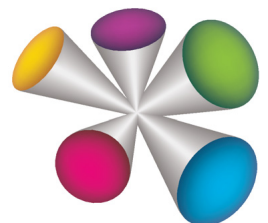



Bamboo

User's Manual for Windows® & Macintosh®

Version 1.0, Rev E1209

Copyright © Wacom Co., Ltd., 2009

All rights reserved. No part of this manual may be reproduced except for your express personal use. Wacom reserves the right to revise this publication without obligation to provide notification of such changes. Wacom does its best to provide current and accurate information in this manual. However, Wacom reserves the right to change any specifications and product configurations at its discretion, without prior notice and without obligation to include such changes in this manual.

The above year indicates when this manual was prepared. However, the date of release to the users of the "manual" is simultaneous with the introduction into the market of the applicable Wacom product.



Reuse, recycling, and recovery. You are urged to recycle this product when replacing it with a newer product or when it has outlived its useful life by bringing it to an appropriate collection point for recyclable materials in your community or region. By doing this, you can help improve the environment of your community as well as minimize the potential negative effects created should any hazardous substance that may possibly be present within waste material reach the environment during the disposal process.

Within the European Union, users are required not to dispose of Waste Electrical and Electronic Equipment (WEEE) as unsorted municipal waste, according to the Directive 2002/96/EC of the European Parliament and of the Council of 27 January 2003, or the corresponding local laws of the Member States. Products for which this is applicable will be marked with the WEEE symbol shown at the beginning of this note unless this is not feasible because of the size or the function of the product. Wacom products are subject to the Directive 2002/96/EC and therefore you should always collect them separately and bring them to the appropriate collection point in your community or region.

Wacom tablet products comply with the European Union RoHS Directive 2002/95/EC (RoHS Directive).

Bamboo is a trademark and Wacom is a registered trademark of Wacom Co., Ltd.

Adobe, Photoshop, and Reader are either registered trademarks or trademarks of Adobe Systems Incorporated in the United States and/or other countries. Microsoft, Windows, and Vista are either registered trademarks or trademarks of Microsoft Corporation in the United States and/or other countries. Apple, the Apple logo, and Macintosh are registered trademarks of Apple Computer, Inc., registered in the U.S. and other countries. Any additional company and product names mentioned in this documentation may be trademarked and/or registered as trademarks.

Mention of third-party products is for information purposes only and constitutes neither an endorsement nor a recommendation. Wacom assumes no responsibility with regard to the performance or use of these products.

ExpressKey is a registered trademark of Ginsan Industries, Inc., and is used with permission.





TABLE OF CONTENTS

About the manual	5	Customize your touch experience	37
Navigating the manual	6	Setting the touch speed	37
YOUR BAMBOO	7	Setting the touch functions	38
Identify your tablet model	7	Setting tablet and ExpressKey functions	39
Bamboo Touch tablet	8	Disabling touch	40
Bamboo & Bamboo Fun tablets	9	Customize your pen experience	41
Bamboo Pen tablet	10	Setting the tip and eraser feel, and double-click distance	42
Pen	11	Setting the pen button functions	43
Pen holder	11	Setting the tablet mapping	44
SETTING UP YOUR BAMBOO	12	Portion of screen area	46
Ergonomics	12	Portion of tablet area	47
Configuring the tablet orientation	14	Setting the pen speed in mouse mode	48
Understanding the tablet active area	15	Customizing the Pop-up Menu	49
Working with multiple monitors	17	Button functions	50
Control panel basics	17	PROBLEMS WITH YOUR BAMBOO?	54
USING YOUR BAMBOO	18	Testing your tablet	55
The touch experience with Bamboo	18	Testing a pen	56
Navigating with touch	19	Troubleshooting tables	57
Customizing touch	25	General problems	57
ExpressKey basics	26	Touch input problems	58
Customizing the ExpressKeys	26	Pen input problems	59
The pen experience with Bamboo	27	Windows-specific problems	60
Holding the pen	27	Mac-specific problems	61
Using the pen on the tablet	28	Technical support options	63
Positioning	28	Obtaining driver downloads	64
Clicking	30	APPENDIX	65
Dragging	30	Caring for Bamboo	66
Using the pen buttons	31	Replacing the pen nib	66
Writing and drawing with pressure sensitivity	32	Uninstalling the software	67
Erasing	33	Pen and digital ink capabilities in Windows Vista	68
Eye-hand coordination exercise	34	About the Windows Vista Tablet PC Input Panel	69
Customizing pen input	34	Product specifications	70
CUSTOMIZING YOUR BAMBOO	35	General specifications	70
Opening the control panel	35	Bamboo Touch tablet (model CTT-460)	70
Control panel overview	36	Bamboo tablet (model CTH-460)	70





Pen (model LP-160E), for Bamboo	71	License and Warranties	
Bamboo Fun small tablet (model CTH-461)	71	(Worldwide, except for Europe, Africa and Middle East)	78
Bamboo Fun medium tablet (model CTH-661)	71	Software License	78
Pen (model LP-161E), for Bamboo Fun	71	Limited Warranty	78
Bamboo Pen tablet (model CTL-460)	72	Warranty Service in the U.S.A. and Canada	79
Pen (model LP-160), for Bamboo Pen	72	Warranty on Sales outside of the U.S.A. and Canada	80
Product information	73	Licence warranty conditions (Europe, Africa and Middle East)	81
Ordering parts and accessories	73	Software Licence Agreement	81
Radio and television interference	74	Limited Warranty	82
FCC notice	74	GLOSSARY	84
Industry Canada (Canada only)	75	INDEX	87
CE declaration	75		
Precautions	76		
Warnings	76		
Cautions	77		





ABOUT THE MANUAL

This manual provides quick access to information about [Bamboo](#). The information is common to Windows and Macintosh computers and Windows screen captures are shown, unless otherwise noted.

- Go directly to [table of contents](#) or [index](#) topics by clicking on them.
- [Your Bamboo](#) introduces you to the many features of the Bamboo tablet.
- [Setting up your Bamboo](#) is a quick guide to understanding how the tablet works.
- [Using your Bamboo](#) gives you the basics on working with your tablet. It describes how to use Bamboo, and includes exercises for new users.
- [Customizing your Bamboo](#) describes how to optimize Bamboo for the way you like to work.
- [Problems with your Bamboo?](#) Then check this section for test and troubleshooting guidelines, and find answers to most common questions.
- The [appendix](#) includes tips on product care, a how-to on uninstalling the software, your license and warranty, and more. Also included is an overview of the pen and [digital inking](#) capabilities found in Microsoft Windows Vista.

Note: This manual does not describe how to install your Wacom tablet. Please refer to your product Quick Start Guide and to the automated software installer (located on the Bamboo Installation CD) for details.

If you are new to electronic documentation, be sure to read [navigating the manual](#).

- SMALL CAPITAL LETTERS are used to identify the names of keyboard keys, dialog boxes, and control panel options.
- You can use your viewer zoom-in tool to increase the size of the manual on your display screen.
- The following information is not included with this product: information about your specific computer hardware or operating system, or information about your application software. Your best source for this information is the set of manuals and discs that came with your hardware, operating system, or application.
- Pen-equipped models: In addition to the built-in inking support found within Microsoft Windows Vista, many graphics applications also support pressure sensitivity and the pen eraser (when equipped). You can find a listing of applications that support these features on Wacom's web site (see [product information](#)).
- For information on how best to use Bamboo features within a specific application, see the instructions in that application's manuals.

Wacom's philosophy is to continually improve all of its products. As a result, engineering changes and improvements are made from time to time. Therefore, some changes, modifications, and improvements may not be covered in this manual.





NAVIGATING THE MANUAL

Use the navigation controls to move through the manual:



Go to front page.

Contents

Go to table of contents.

Index

Go to index.



Go back to previous view.



Page back, or page forward.

[topic](#)

Go to topic.



Topic continued.

Adobe® Reader® provides additional tools for using and printing the manual. See the Adobe Reader help for more information.



YOUR BAMBOO

This section introduces you to Bamboo. The quickest way to learn about your Bamboo tablet is to become familiar with its appearance and features.

- Not all product models are available in all regions.
- Your Bamboo tablet cannot be used with other Wacom pens or input devices, including those from a previous version Bamboo tablet. Nor can a pen from your new Bamboo tablet be used with other Wacom tablets or a previous version Bamboo tablet.

[Identify your tablet model](#)

[Bamboo Touch tablet](#)

[Bamboo & Bamboo Fun tablets](#)

[Bamboo Pen tablet](#)

[Pen](#)

[Pen holder](#)

IDENTIFY YOUR TABLET MODEL

Each tablet model within the Bamboo family has a specific feature set.

TABLET MODEL	TOUCH INPUT	PEN INPUT	EXPRESSKEYS
Bamboo Touch (model CTT-460)	X		X
Bamboo (model CTH-460)	X	X	X
Bamboo Fun small (model CTH-461)	X	X	X
Bamboo Fun medium (model CTH-661)	X	X	X
Bamboo Pen (model CTL-460)		X	

Icons are located near some of the topic headings in this manual to help you quickly identify sections that have information specific to touch or pen input.

- Touch input is identified by this icon: 

- Pen input is identified by this icon: 

Icons do not appear in common sections that may apply to all Bamboo tablet models.

Model-specific notes may be used as necessary.

BAMBOO TOUCH TABLET

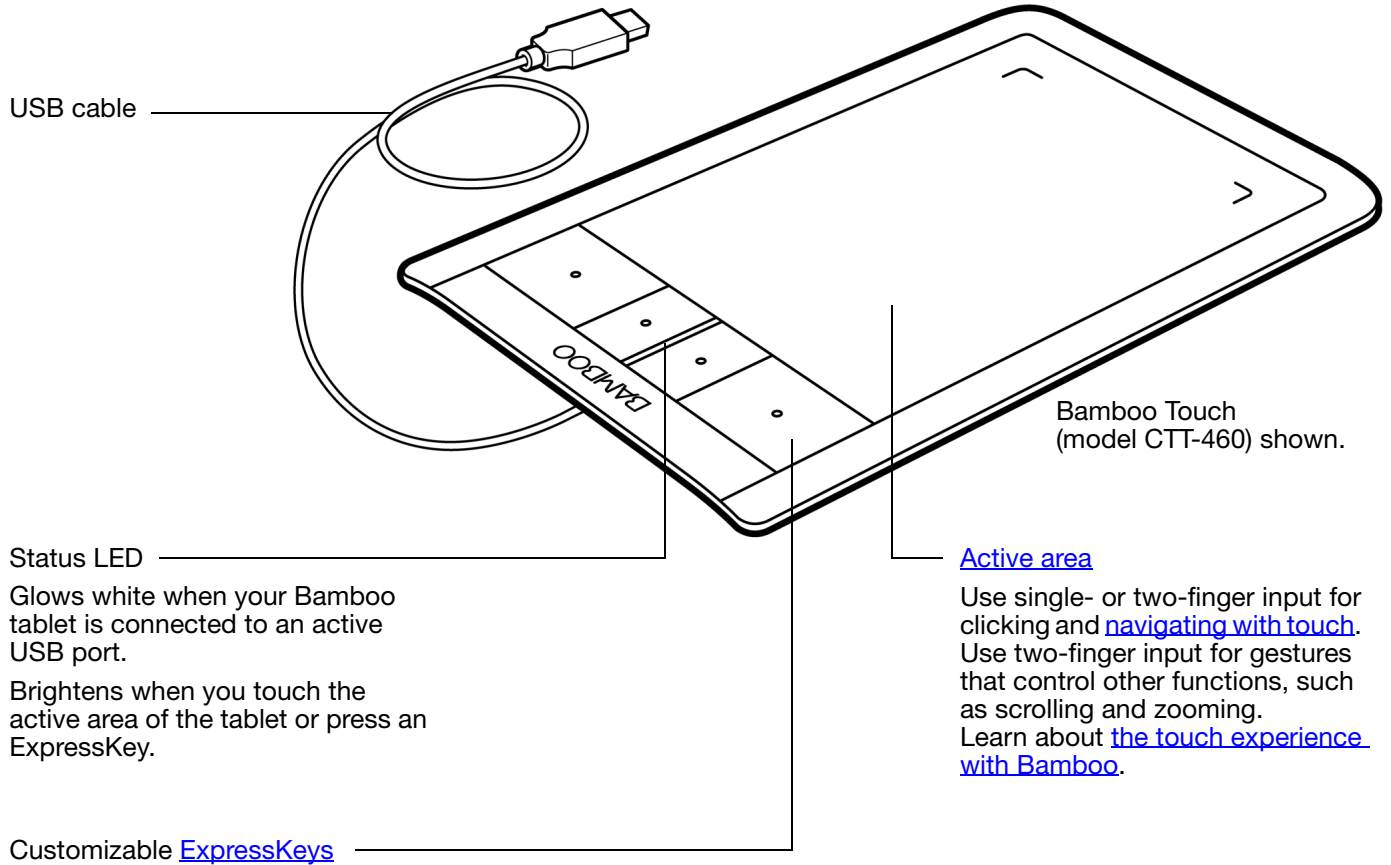

BAMBOO & BAMBOO FUN TABLETS

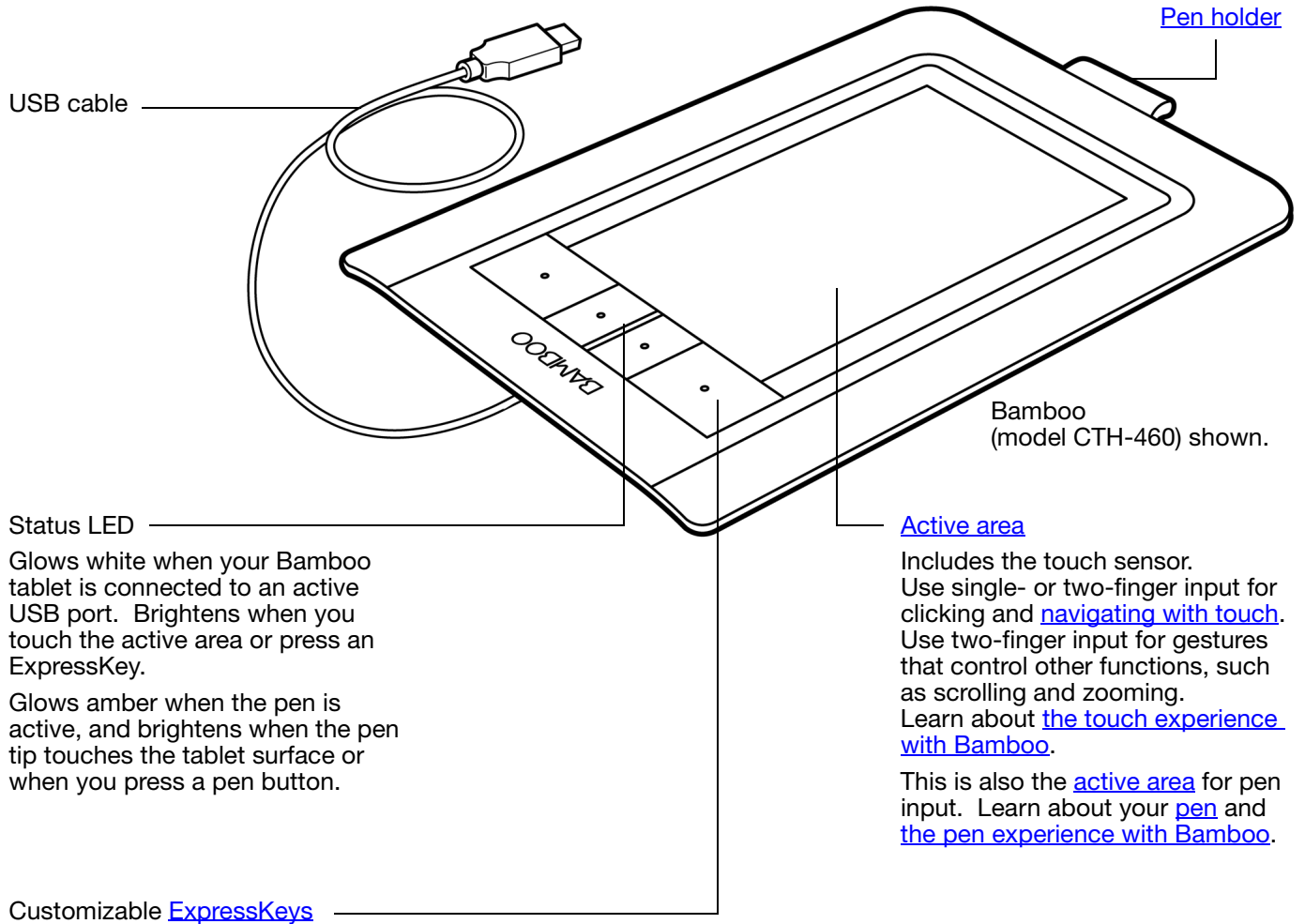
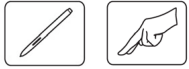

Glow white when your Bamboo tablet is connected to an active USB port. Brightens when you touch the active area or press an ExpressKey.

Glow amber when the pen is active, and brightens when the pen tip touches the tablet surface or when you press a pen button.

Includes the touch sensor. Use single- or two-finger input for clicking and [navigating with touch](#). Use two-finger input for gestures that control other functions, such as scrolling and zooming. Learn about [the touch experience with Bamboo](#).

This is also the [active area](#) for pen input. Learn about your [pen](#) and [the pen experience with Bamboo](#).

BAMBOO PEN TABLET

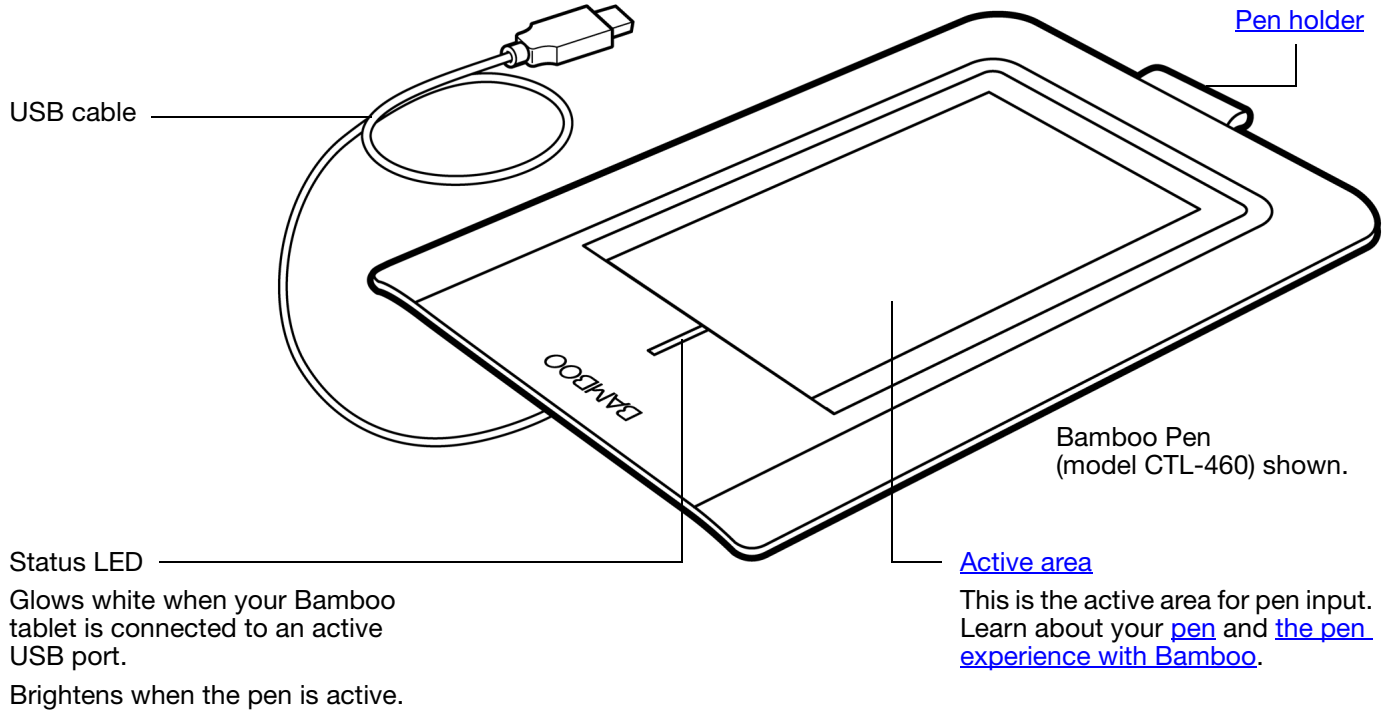

PEN



[Eraser](#) (when equipped)

[Pen buttons](#)

[Replaceable nib](#)
(pen tip)

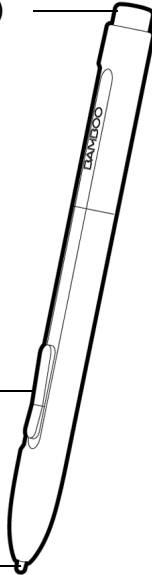

[Pen](#) (when equipped)

A pressure-sensitive freehand tool for image editing and creating natural-looking pen strokes. It is also efficient for document annotation and taking notes in applications that support handwriting recognition.

The pen is cordless and battery free. It is ideally suited to enhance your workflow by enabling the pen and digital ink features found within Microsoft Windows Vista and Office 2007. Take advantage of digital mark-up for collaborative editing and use digital ink to take notes in applications that support handwriting recognition.

Important: When not in use, place the pen into the pen holder or lay it flat on your desk. The eraser end of the pen should be inserted first into the loop. To maintain the sensitivity of your pen, do not store the pen in a container where it will rest on the tip or eraser.

Leaving the pen on the tablet may interfere with screen cursor positioning when using other pointing devices, or may prevent your computer from going to sleep.

PEN HOLDER



Use the pen holder (when equipped) to store the pen when it is not in use. The pen holder does not apply to Bamboo Touch.

Insert the pen into the pen holder as shown.

- The eraser end of the pen should be inserted first into the loop.
- Do not wedge the pen buttons inside the loop, otherwise they may be continually depressed and possibly fail.

Important: You can also lay the pen flat on your desk. Leaving the pen on the tablet may interfere with screen cursor positioning when using other pointing devices, or may prevent your computer from going to sleep.

Wacom recommends that you do not store the pen in a stand or holder other than the one provided with your Bamboo tablet. The pen may be damaged if it falls out of an unsuitable stand. The sensitivity of your pen may be affected if the pen is stored in a container where it rests on the tip or eraser.

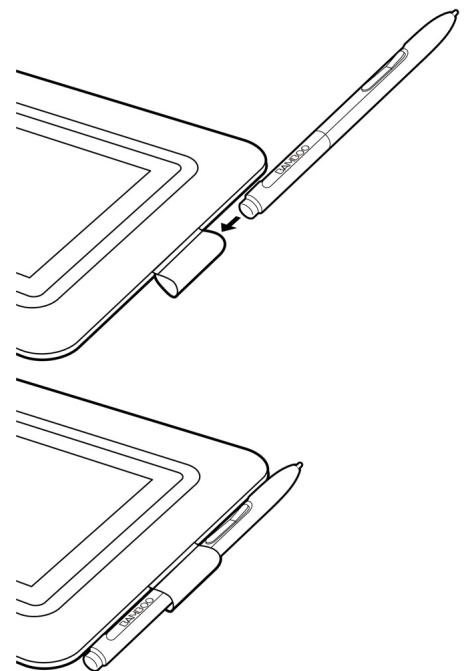

SETTING UP YOUR BAMBOO

To minimize fatigue, comfortably organize your work area. Position your tablet, pen (if equipped), and keyboard for easy access without unnecessary reaching. Adjust your monitor so you can view it comfortably with a minimum of eyestrain. For best results, position the tablet so the screen cursor follows the same direction as your hand movements on the tablet.

[Ergonomics](#)

[Configuring the tablet orientation](#)

[Understanding the tablet active area](#)

[Working with multiple monitors](#)

[Control panel basics](#)

ERGONOMICS



- Take short breaks between tasks to stretch and relax your muscles.
- Use a gentle grip when working with the pen.
- When not actively working with touch, you can rest your fingers and palm on the tablet. Touch data will not be sent when you touch the tablet [active area](#) with more than two fingers.
- Alternate tasks and tools throughout the day.
- Maintain a good posture at all times. Minimize awkward postures and repetitive movements that cause discomfort.
- Change your position if you feel any discomfort due to your work position.
- For right-handed use, position the tablet so the input (active) area is located to the right of the ExpressKeys. If using the tablet as a primary pointing device and mouse replacement, consider placing it to the right of your keyboard.
- For left-handed use, position the tablet with the input area to the left of the ExpressKeys. See [configuring the tablet orientation](#) for details. If using the tablet as a primary pointing device and mouse replacement, consider placing it to the left of your keyboard.
- If using the tablet primarily as a creative tool, consider placing the tablet below the keyboard, centered with respect to your monitor.

Note regarding RSI: Wacom makes no representation, promise or guarantee that Wacom products will cure or prevent, in whole or in part, mouse-induced repetitive stress symptoms, injuries or conditions. Individual results may vary. Always obtain competent medical advice to determine the most appropriate treatment for your specific situation.



As you work, you will discover many ways of interacting with your Bamboo tablet. For example:

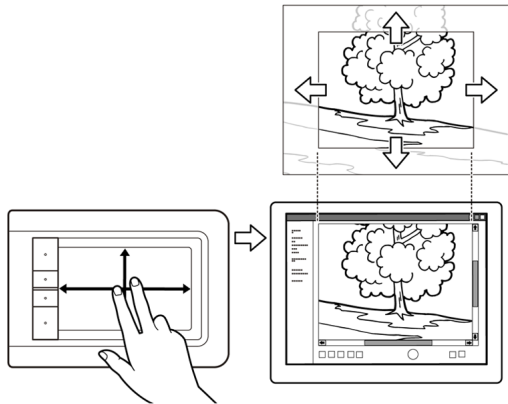

Visual browsing

Use two fingers on the tablet surface to scroll through and navigate visual media within an application.

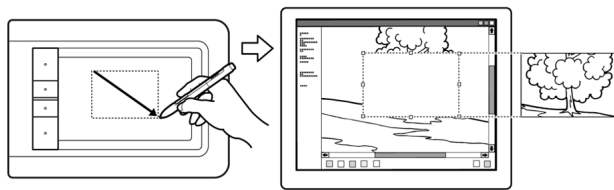
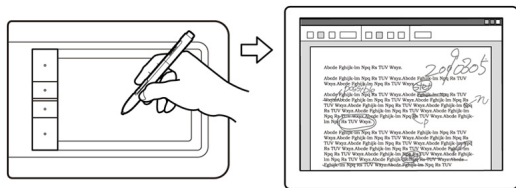

Photo editing

Use the pressure-sensitive pen (when equipped) to edit images within a photo or image editing application.



Annotation

Simplify document reviews by using the pen (when equipped) to digitally mark-up and annotate documents.

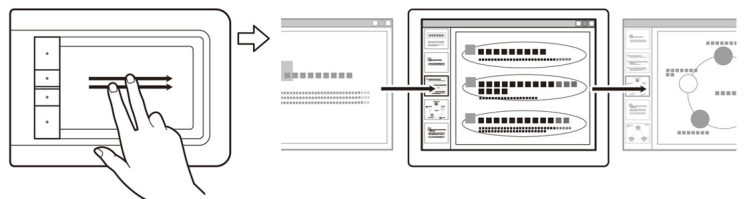

Presentation

Quickly swipe (flick) two fingers across the tablet surface to quickly move between slides in a presentation.

For details on these and other ways to work with your tablet, see [the touch experience with Bamboo](#) or [the pen experience with Bamboo](#).

CONFIGURING THE TABLET ORIENTATION

You are prompted to choose a default tablet orientation during the initial installation process using the Bamboo Installation CD. At the log-in and user switching screens, the tablet orientation will use the default orientation that was selected when the driver was installed. To change the default orientation, reinstall the driver using the Bamboo Installation CD and when prompted select a new default orientation.

You can also change how your tablet is oriented using the following procedure. However, the default orientation used at the log-in screen will not be affected.

To set up your Bamboo for right-handed operation:

- [Open the Bamboo control panel](#) and select the TABLET tab. Choose the RIGHT HANDED option. The tablet driver automatically configures all aspects of the tablet for correct right-handed use.
- Next, physically rotate your tablet so the tablet ExpressKeys are positioned to the left.

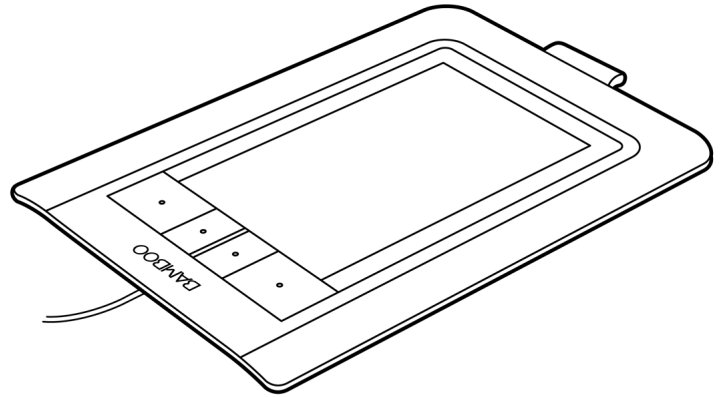

To set up your Bamboo for left-handed operation:

- [Open the control panel](#) and select the TABLET tab. Choose the LEFT HANDED option. The tablet driver automatically configures all aspects of the tablet for correct left-handed use.
- Next, physically rotate your tablet so the tablet ExpressKeys are positioned to the right.

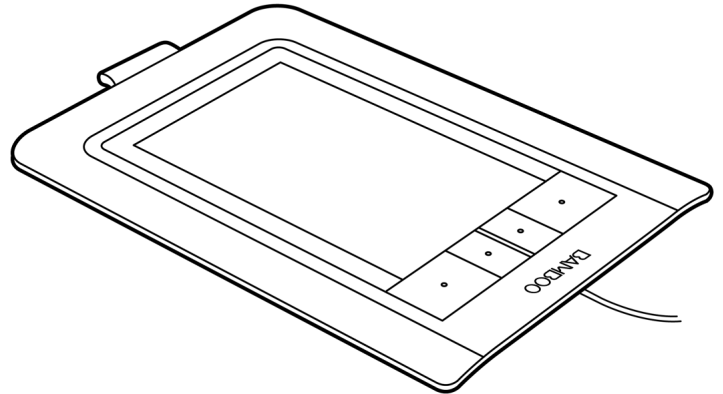

UNDERSTANDING THE TABLET ACTIVE AREA

Depending on your tablet model, Bamboo can accept touch input, pen input, or both. Note, however, that pen and touch input cannot be used at the same time.

Touch input

On touch-sensitive tablet models, slide your finger across the active area to position the screen pointer.

Use single- or two-finger input for clicking and navigating.

Use two-finger input for gestures that control other functions, such as scrolling and zooming.

Learn about [the touch experience with Bamboo](#).

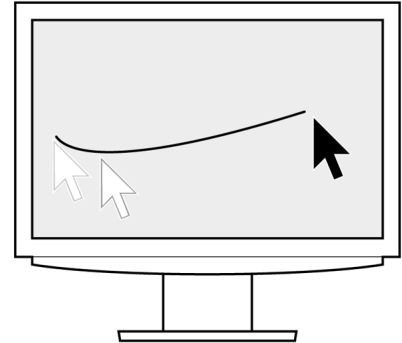

Tablet active area

The area of your Bamboo tablet that senses touch or pen input.

For tablet models that support both pen and touch input:

- Touch input is disengaged whenever the pen tip or eraser is within the tablet [proximity range](#). Lift the pen and your hand away from the tablet active area to re-enable touch input.
- The [pen input area](#) is slightly larger than the touch sensor area.

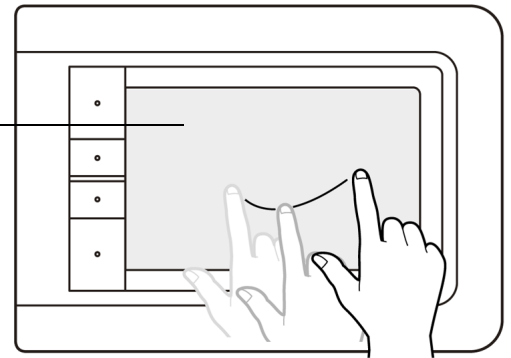

Pen input

The pen works only on the active area of tablet models that support pen input.

Wherever you place the pen on the tablet, the screen pointer will jump to the corresponding point on the screen. The screen pointer indicates pen position, and follows the movement of the pen across the tablet surface.

Learn about [the pen experience with Bamboo](#).

Note: For tablets that support pen input, the active area is a mapped representation of your computer screen(s). By default it uses the entire screen or all screens if you have multiple displays. You can customize the mapping relationship for pen input by [setting the tablet mapping](#).

Tablet active area

The area of your Bamboo tablet that senses touch or pen input.

For tablet models that support both pen and touch input:

- Touch input is disengaged whenever the pen tip or eraser is within the tablet [proximity range](#). Lift the pen and your hand away from the tablet active area to re-enable touch input.
- The pen input area is slightly larger than the touch sensor area.

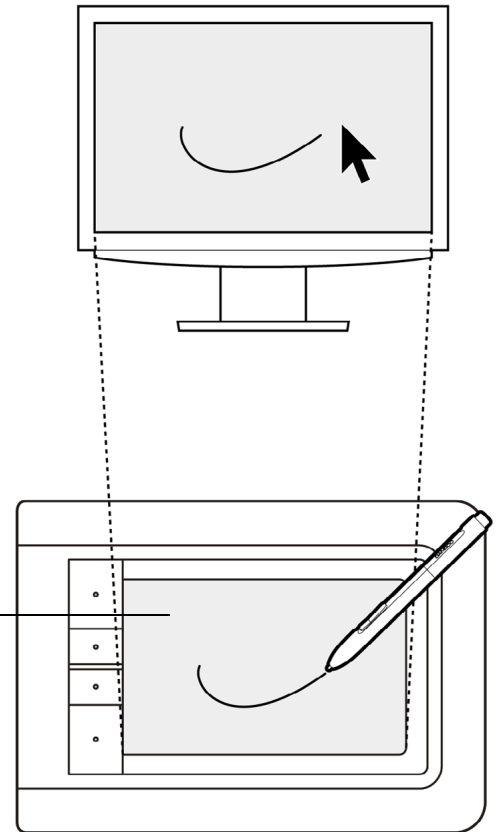

WORKING WITH MULTIPLE MONITORS

If your computer is equipped with more than one monitor, Bamboo will map to your monitors based upon how they are configured in the display properties control panel.

- If more than one monitor is in use and you are in extended monitor mode, the tablet maps to all monitors as if they were one large display. The below image illustrates a tablet mapping to the entire system desktop, which is displayed on the two monitors.

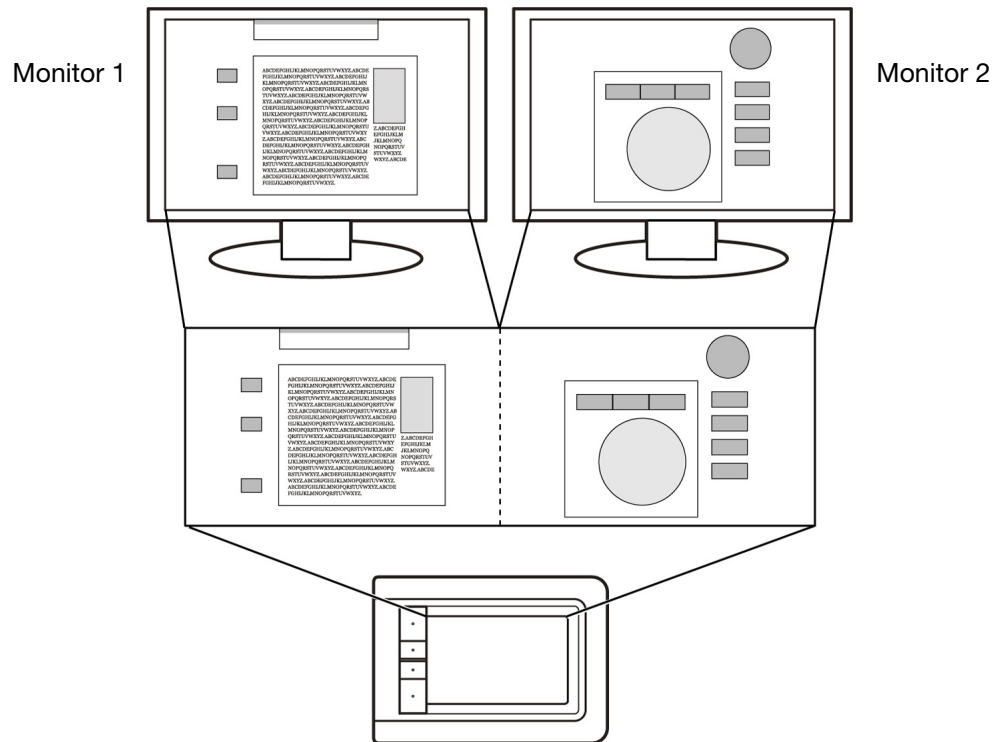

- If your monitors are in mirror mode (both monitors display the same content), the tablet maps to the entire space on each monitor and the screen cursor is displayed on each monitor simultaneously.

See your hardware and operating system documentation for details on configuring your computer and operating system for use with multiple monitors.

Note: The pen can also be customized to map to a single monitor, or to a portion of the monitor area. See [setting the tablet mapping](#).

CONTROL PANEL BASICS

After mastering the basics of using your Bamboo tablet, you may want to customize the way touch or pen input works. The Bamboo control panel is where you customize your Bamboo tablet settings.

[Opening the control panel](#)

[Control panel overview](#)



USING YOUR BAMBOO

If you are new to using Bamboo, read the following sections.

[The touch experience with Bamboo](#)

[The pen experience with Bamboo](#)

THE TOUCH EXPERIENCE WITH BAMBOO



Bamboo is designed to enhance the way you work. Touch input enables you to interact with a computer using only your fingertips on the Bamboo tablet.

First learn the basic actions to navigate and perform typical mouse operations. Then learn the gestural movements to control other functions such as scrolling, zooming, and rotating.

Touch input is activated whenever you touch the tablet's [active area](#).

- One- and two-finger input only is recognized by the tablet. When not actively working with touch, you can rest your fingers and palm on the tablet. Touch data will not be sent when you touch the tablet active area with more than two fingers.
- When using two-finger input methods, you can generally position your fingers as far apart as you find comfortable. However, be aware that touching the tablet with your fingers set too closely together may be interpreted as coming from a single finger, or confused with which finger initiated or performed an action or gesture.
- As you learn the different input methods, experiment with what works best for you. Take care to prevent accidental touch input. For example, if your small finger or the palm of your hand touches the active area of the tablet while you are navigating or performing a touch action, then your input may be interrupted or you may trigger an unanticipated right-click.

Note: For tablet models that support both pen and touch input, the pen disengages touch input whenever the pen tip or eraser is within the tablet [proximity range](#). Lift the pen and your hand away from the tablet active area to re-enable touch input.

[Navigating with touch](#)

[Customizing touch](#)

[ExpressKey basics](#)

[Customizing the ExpressKeys](#)



NAVIGATING WITH TOUCH



The touch input feature of your Bamboo tablet enables you to control a computer using only your fingertips on the tablet surface. See [understanding the tablet active area](#).

Before learning how to control your computer with touch input, familiarize yourself with the following concepts:

CONCEPT	DESCRIPTION
Track	Touch and move a single finger across the tablet surface.
Tap	Touch and lift a single finger from the tablet.
Pan	Touch the tablet surface with two fingers and move them in the same direction.
Swipe	Touch the tablet surface with two fingers and move them in the same direction at a relatively high speed.
Pinch	Touch the tablet with two fingers spaced slightly apart. While still touching the tablet surface, move or 'pinch' your fingers together.
Expand	Touch the tablet with two fingers spaced closely together. While still touching the tablet surface, move your fingers apart.
Twist	Touch the tablet with two fingers spaced slightly apart and move (rotate) them in a circular fashion, or move them in opposing directions. You can also hold one finger stationary and track your other finger around the stationary finger.

You can [customize your touch experience](#) and also [use the ExpressKeys](#) to perform some touch functions.



Touch input options can be enabled or disabled within the Bamboo control panel and are dependent upon application support. Touch actions and gestures are available when selected in the TOUCH FUNCTIONS tab.

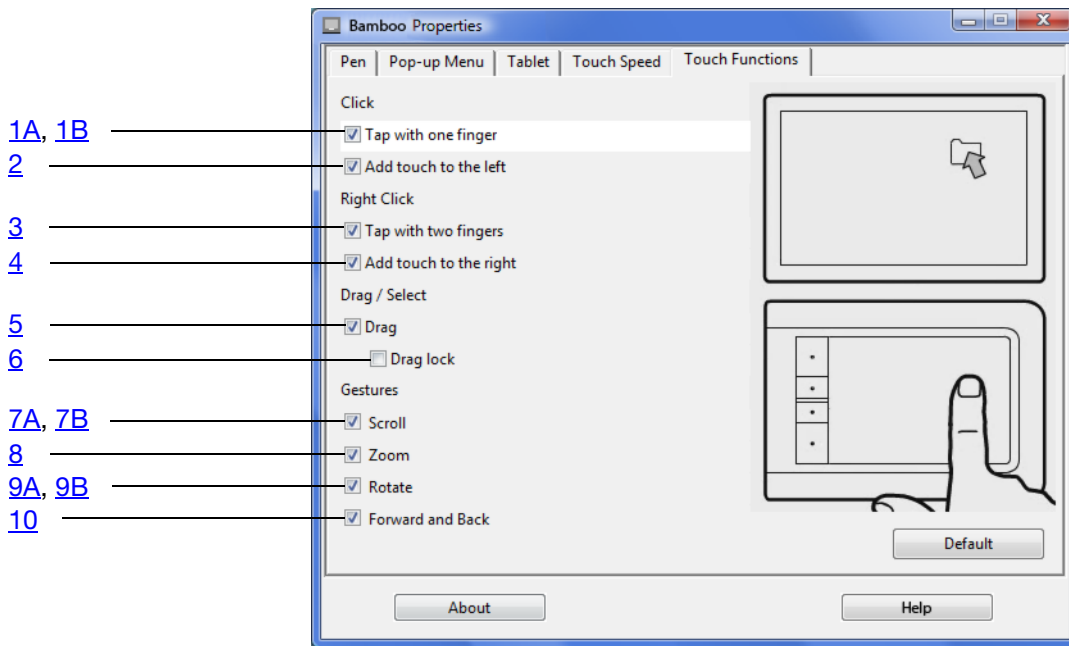

BASIC ACTIONS enable you to navigate and perform typical mouse operations.

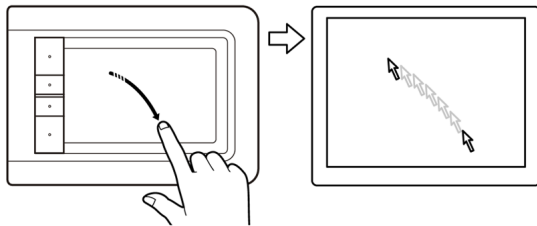

Track

Use a single finger to move the screen cursor. Touch and slide your finger across the tablet surface.

1A TAP WITH ONE FINGER

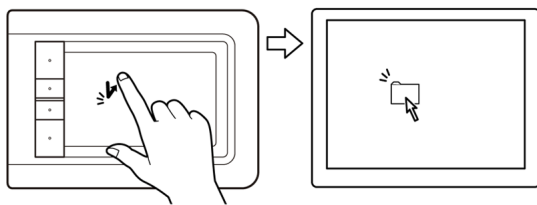

Click (single-finger tap)

Using a single finger, track to an item. Lift your finger and tap to select.

Alternatively, you can track to an item and then press an ExpressKey set to CLICK.

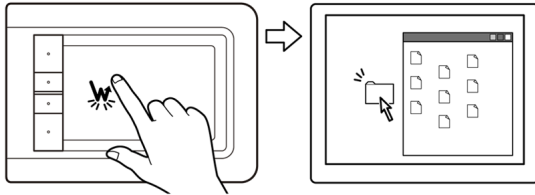

1B TAP WITH ONE FINGER

Double-click

Using a single finger, track to an item. Lift your finger and tap twice.

2 ADD TOUCH TO THE LEFT

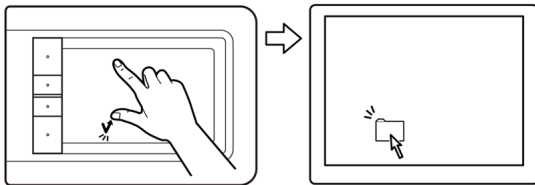
Select and drag (add touch to left)

Using a single finger, track to an item. Select by touching your thumb or a second finger to the left of that finger. (If you will be dragging an item or selecting blocks of text, we recommend using two fingers instead of your finger and thumb).

- To move the selected item, continue moving both fingers across the tablet.
- To highlight a text block, continue moving both fingers across the tablet as you select text.
- You can also extend a drag without releasing the selection. To do this, lift the first finger and move your second finger to a new position. Then again touch the first finger to the tablet and continue to drag with both fingers.

Lift your thumb or second finger to release.

Note: If the tablet is set for left-handed orientation, touch to the right of the primary finger.

3 TAP WITH TWO FINGERS

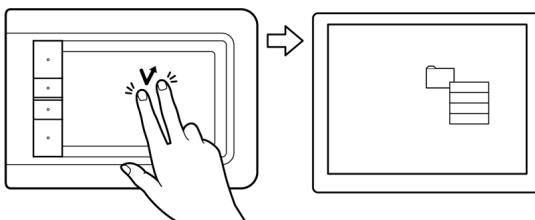
Right-click (two-finger tap)

To right-click and bring up a context menu at the screen cursor position, tap the tablet surface with two fingers spaced slightly apart. Use a quick tapping motion with both fingers at the same time.

You can then track to an option in the menu and select it by tapping your finger.

Alternatively, you can open a context menu by tracking to an item and then pressing an ExpressKey set to RIGHT CLICK.

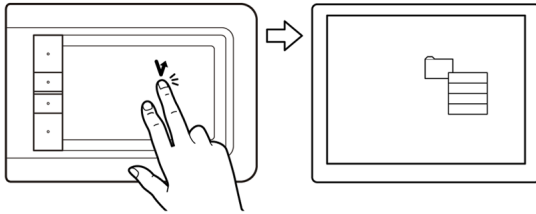

4 ADD TOUCH TO THE RIGHT

Right-click (add touch to right)

Using a single finger, track to an item. Then with a second finger touch and release to the right of that finger. Releasing your finger issues a right-click and brings up a context menu at the screen cursor position.

You can then track to an option in the menu and select it by tapping your finger.

Note: If the tablet is set for left-handed orientation, touch to the left of the primary finger.

5 DRAG

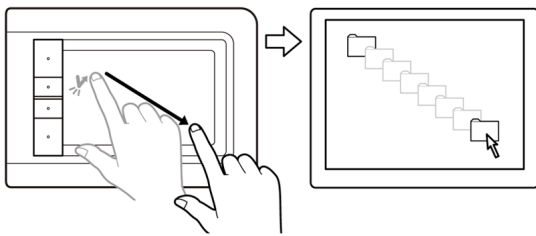
Select and drag (DRAG LOCK disabled)

Using a single finger, tap on an item to select. Then track (slide) your finger across the tablet to drag. Lift your finger to release the item. You can also [select and drag](#) with two fingers.

Alternatively, you can drag by tracking to an item, pressing an ExpressKey set to CLICK, and then continuing to move your finger across the tablet surface. Release the ExpressKey to release the item.

Tip: You can select and drag multiple items on the system desktop.

- For Windows, press the CTRL or SHIFT key as you tap to select multiple items.
- For Macintosh, press the SHIFT or COMMAND key as you tap to select multiple items.

6 DRAG LOCK

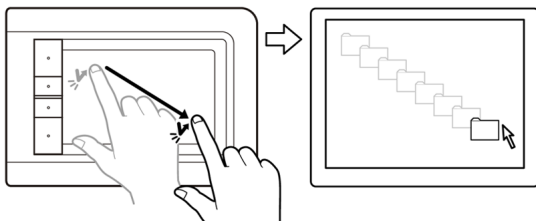
Drag lock (DRAG LOCK enabled)

Using a single finger, tap on an item to select. Then track (slide) your finger across the tablet to drag. Tap again to release the item.



GESTURES enable you to control functions such as scroll, zoom, and rotation.

7A GESTURES SCROLL

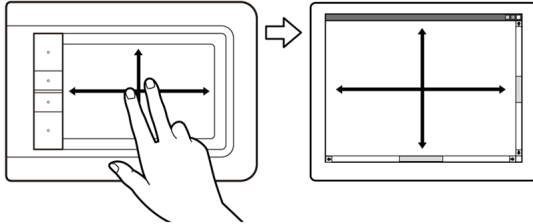

Scroll

Place two fingers on the tablet surface. Using a smooth motion, move your fingers together in parallel.

- Scroll up by moving your fingers in an upward motion.
- Scroll down by moving your fingers in a downward motion.
- Scroll left by moving your fingers in a leftward motion.
- Scroll right by moving your fingers in a rightward motion.

Tips:

Flick your fingers at the end of the gesture to continue scrolling for a short time after your fingers leave the tablet.

For windows that scroll vertically and horizontally, move your fingers in any direction and the document view will follow.

7B GESTURES SCROLL

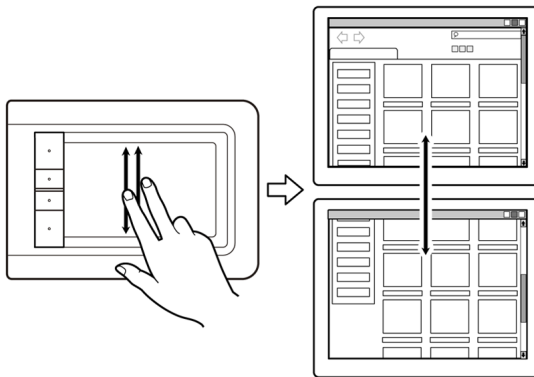

Fast scroll

Quickly move (or flick) two fingers together, lifting your fingers at the end of the motion.

- Fast scroll up by flicking your fingers in an upward motion.
- Fast scroll down by flicking your fingers in a downward motion.

Note: Fast scrolling works only for vertical scrolling.

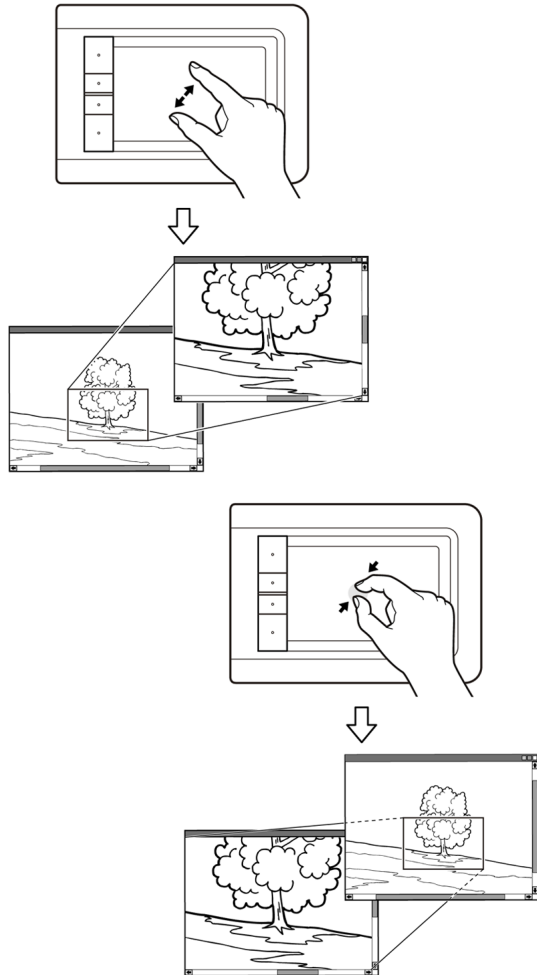

8 GESTURES ZOOM

Zoom

First place two fingers on the tablet surface.

- Zoom-in by moving (expanding) your fingers away from one another.
- Zoom-out by moving (pinching) your fingers toward one another.

Note: If zoom functions do not operate correctly within Adobe Photoshop®, verify that the ZOOM WITH SCROLL WHEEL function is selected within the Photoshop PREFERENCES options.

9A GESTURES ROTATE

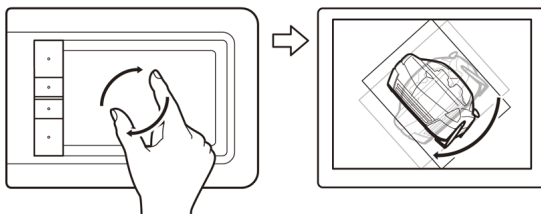
Rotate (two finger rotate)

Place two fingers diagonally on the tablet surface and then rotate them clockwise or counter-clockwise.

For best recognition of this gesture, start with your fingers positioned diagonally on the tablet surface and keep them at least 25 mm (1 inch) apart.

Note: The rotation gesture may work differently depending on the application you are working with. For example, rotation may work smoothly, in 90-degree increments, or not at all.

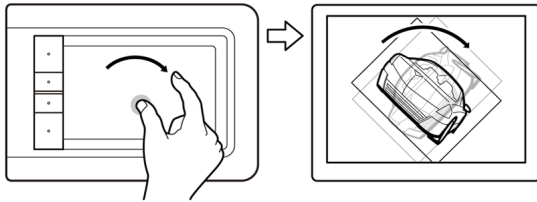

9B GESTURES ROTATE

Rotate (rotate around finger)

Place two fingers diagonally on the tablet surface. Keep one finger stationary and move the other finger around it.

For best recognition of this gesture, start with your fingers positioned diagonally on the tablet surface and keep them at least 25 mm (1 inch) apart.

Note: The rotation gesture may work differently depending on the application you are working with. For example, rotation may work smoothly, in 90-degree increments, or not at all.

10 GESTURES FORWARD & BACK

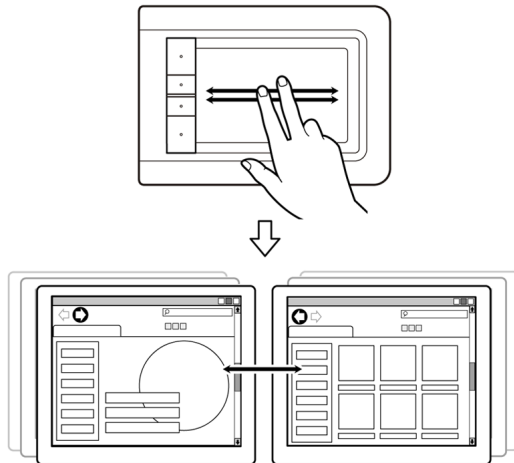
Forward or Back (swipe right or left)

Quickly swipe (or flick) two fingers together, lifting your fingers at the end of the motion.

- Send a 'Forward' command in most browsers and picture viewers by flicking your fingers in a generally rightward motion.
- Send a 'Back' command in most browsers and picture viewers by flicking your fingers in a generally leftward motion.

Tips:

Swiping is similar to using the right and left arrow keys in document viewers.

Use the swipe gestures to page forward or back in most web browsers.

CUSTOMIZING TOUCH



Use the Bamboo control panel to customize the touch input options for the way you like to interact with your tablet and computer.

[Opening the control panel](#)

[Control panel overview](#)

[Customize your touch experience](#)

EXPRESSKEY BASICS

Most Bamboo tablet models feature customizable ExpressKeys. Note that ExpressKeys are not available for Bamboo Pen (model CTL-460).

ExpressKeys

Press individual keys to perform frequently used functions or keystrokes. ExpressKeys can also be used to modify touch or pen input properties as you work.

Consider some of these alternate ways of using the keys:

- Set a key to a commonly used keyboard shortcut.
- Set a key to launch a commonly used file or application, such as your email program.
- Choose from any of the other available [functions](#).

Note: The ExpressKeys can be operated in combination with one another. For example, if you program one key to simulate the CTRL key and another to simulate an ALT keystroke, when you press both keys at the same time a CTRL+ALT is simulated.

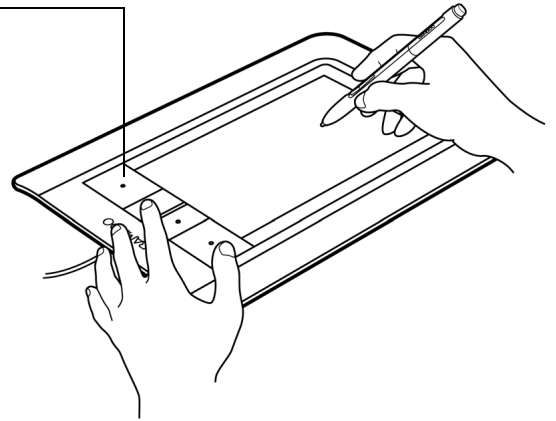

ExpressKeys configuration when positioned on the left side of the tablet (RIGHT HANDED orientation)

ExpressKey default settings:

TOUCH TOGGLE
(FORWARD for Bamboo Touch)

BACK

RIGHT CLICK

CLICK

ExpressKeys configuration when positioned on the right side of the tablet (LEFT HANDED orientation)

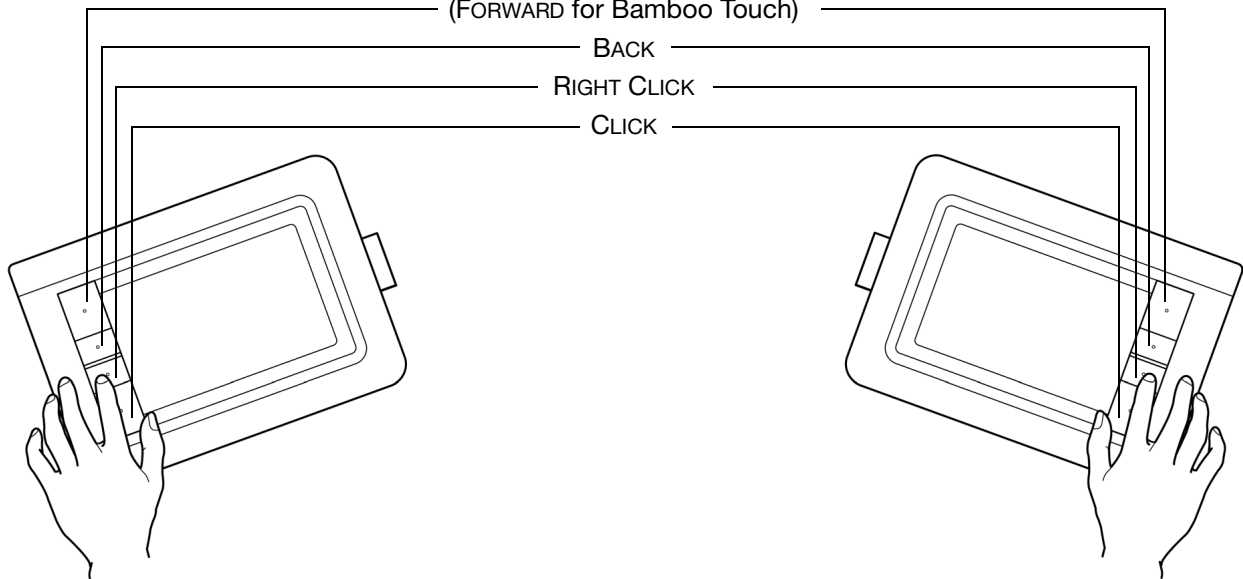

CUSTOMIZING THE EXPRESSKEYS

Use the Bamboo control panel to customize the ExpressKey options.

[Opening the control panel](#)

[Control panel overview](#)

[Setting tablet and ExpressKey functions](#)

THE PEN EXPERIENCE WITH BAMBOO



Bamboo is designed to enhance the way you work. Bamboo tablet models equipped for pen input enable you to interact with a computer using the pen on the [active area](#) of the tablet. The pen is cordless, battery free, and pressure-sensitive.

Note: For Bamboo tablets that support both pen and touch input, the pen disengages touch input whenever the pen tip or eraser is within the tablet [proximity range](#). Lift the pen and your hand away from the tablet active area to re-enable touch input. If you experience unintended touch input from your hand, manually disable touch by pressing an Expresskey set to Touch Toggle. After you are done working with the pen, press the ExpressKey again to re-enable touch. See also [setting tablet and ExpressKey functions](#).

[Holding the pen](#)

[Using the pen on the tablet](#)

[Customizing pen input](#)

[ExpressKey basics](#)

[Customizing the ExpressKeys](#)

[Customizing the Pop-up Menu](#)

HOLDING THE PEN



Hold the pen like you would hold a normal pen or pencil. Make sure the pen buttons are in a convenient location where you can toggle them with your thumb or forefinger, but not accidentally press them while drawing or positioning with the pen. Tilt the pen in any way that feels most comfortable.

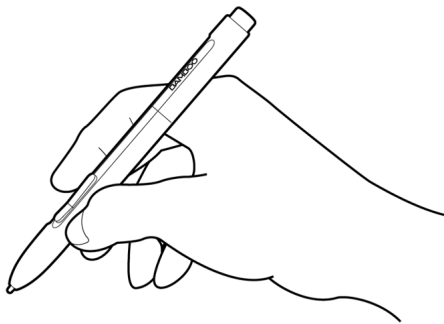

Position for drawing and navigation

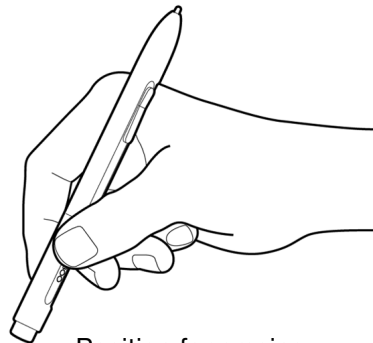

Position for erasing

When you are not using the pen, store it in the [pen holder](#). The eraser end of the pen should be inserted first into the loop.

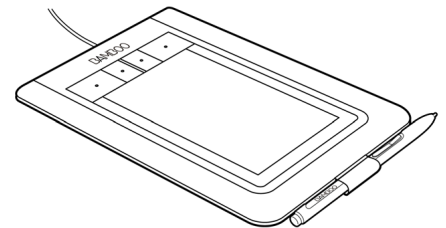

Important: When not in use, place the pen in the pen holder or lay it flat on your desk. To maintain the sensitivity of your pen, do not store the pen in a container where it will rest on the tip or eraser (when equipped). Leaving the pen on the tablet may interfere with screen cursor positioning when using other pointing devices, or may prevent your computer from going to sleep.

USING THE PEN ON THE TABLET



There are four basic techniques for using the pen: positioning, clicking, double-clicking, and dragging. If you are unfamiliar with using the pen, try the exercises on the following pages.

[Positioning](#)

[Clicking](#)

[Dragging](#)

[Using the pen buttons](#)

[Writing and drawing with pressure sensitivity](#)

[Erasing](#)

[Eye-hand coordination exercise](#)

POSITIONING



The pen is used to position the pointer (or cursor) on your screen.

Lift the pen and place the pen tip on the tablet [active area](#). The cursor instantly jumps to the new location.

Move the screen cursor by moving the pen across the tablet surface. Do this without touching the tablet surface, but while still keeping the pen tip within [proximity](#) of the tablet.

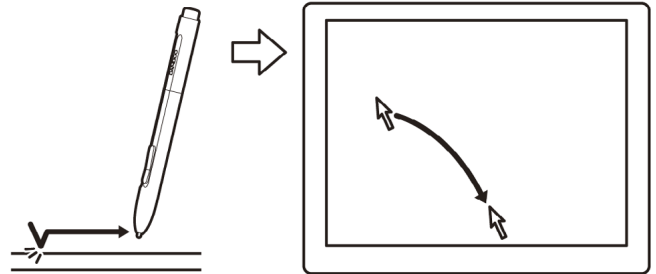

To select an icon or folder, use your pen to position the screen cursor over the object. Press down to select.

Tips:

If you find that using a pen is somewhat difficult, try the [eye-hand coordination exercise](#).

Pointing is easier when you orient the tablet square to the computer monitor so the screen cursor follows the same direction as your hand movements on the tablet.

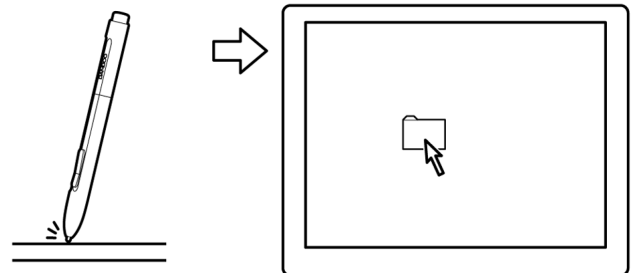

You can set the pen to position the screen cursor two different ways (see [setting the tablet mapping](#)).

- In [PEN MODE](#), wherever you place the pen on the tablet, the screen cursor will jump to a corresponding point on the display screen. The screen pointer indicates pen position, and follows the movement of the pen across the tablet surface. This is the default setting for the pen.

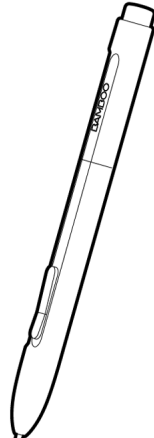

16 mm (0.63 inch) proximity range

7 mm (0.28 inch) proximity

When positioning the screen cursor and operating a pen button, the pen tip needs to be within 7 mm (0.28 inch) of the tablet surface. The pen tip does not need to touch the tablet in order to move the screen cursor or use a pen button.

- In [MOUSE MODE](#) you move the cursor with a “pick up and slide” motion similar to using a mouse.

CLICKING



Click to highlight or select an item on the screen. Double-click to open it.

Clicking. Tap the pen tip once on the tablet, or press the pen tip on the tablet with enough force to register a click. (If **CLICK SOUND** is selected in the Bamboo control panel and your computer speakers are on, then you will hear a “click” sound when the pen tip is pressed hard enough to generate a button click. Adjust your speaker volume as necessary.) Try clicking on a folder icon by moving the screen cursor over the icon and pressing down on the pen tip. The folder should highlight when you press.

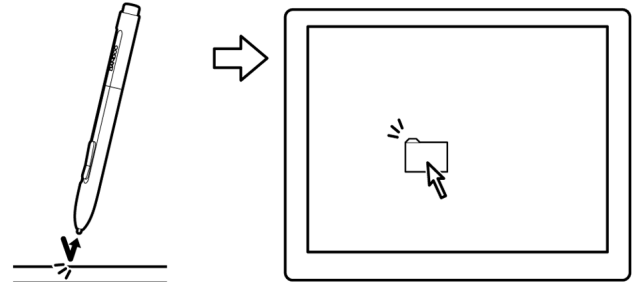

Tip: You can configure Windows to select when the pen is over an icon and to launch the icon with a single click. To turn on this feature, first open a folder.

- **For Windows Vista,** from the **ORGANIZE** pull-down menu choose **FOLDER AND SEARCH OPTIONS....** From the **GENERAL** tab select **SINGLE-CLICK TO OPEN AN ITEM (POINT TO SELECT)**.
- **For other Windows versions,** from the **TOOLS** pull-down menu choose **FOLDER OPTIONS....** From the **GENERAL** tab select **SINGLE-CLICK TO OPEN AN ITEM (POINT TO SELECT)**.

Double-clicking. Quickly tap the tablet twice in the same place with the pen tip. This is like clicking twice with a mouse button. Try double-clicking on a folder icon to open it.

Tip: Set a pen button to **DOUBLE CLICK**. This is easier than tapping twice with the pen tip, and is the preferred method of double-clicking with a pen.

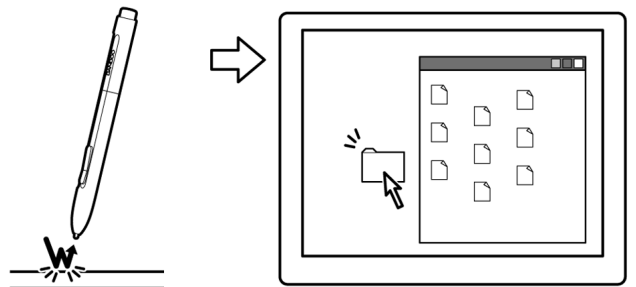

DRAGGING



Dragging is used to select and move objects on the monitor screen.

First point to an object. Then press the pen tip to the tablet and slide it across the tablet surface. The selected object will move across the display screen.

To select text within a document, move the screen cursor to the beginning of a text line, then drag the pen across the tablet to highlight the text.

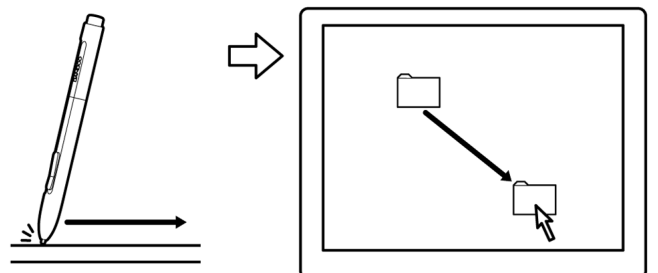

USING THE PEN BUTTONS



The pen is equipped with two buttons. Each button has a programmable [function](#) that is selected when you press the button. You can use a pen button whenever the pen tip is within 7 mm (0.28 inch) of the tablet active area. You do not have to touch the pen tip to the tablet in order to use a button.

The default button positions are:

Upper: RIGHT CLICK

Lower: PAN/SCROLL

Tip: Set a pen button to DOUBLE CLICK. This is easier than tapping twice with the pen tip.

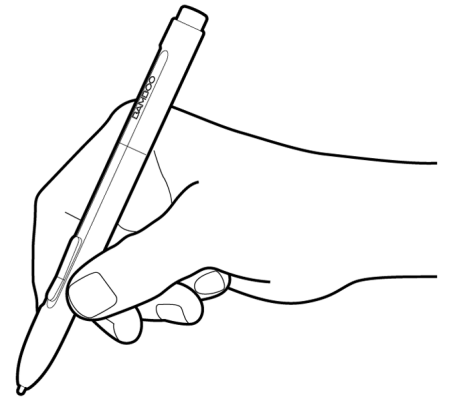

Use RIGHT CLICK to bring up application-specific or icon-specific menus.

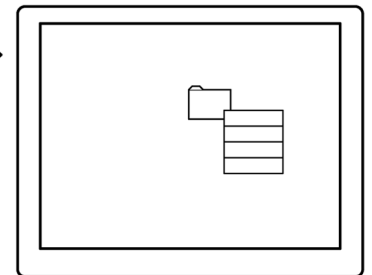
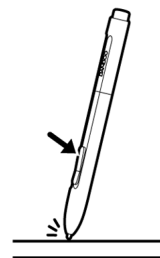

PAN/SCROLL lets you position a document or image in any direction within the active window simply by pressing the pen button and moving the pen tip across the tablet's active area. As you move the pen tip, the document or image is repositioned to follow the direction of pen movement on the tablet. Release the pen button or lift the pen tip from the tablet surface when you are done.

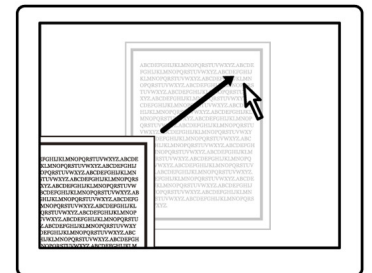
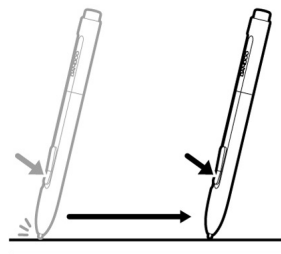

In some application windows the document will precisely follow the screen cursor as you move the pen tip, while in others it will simply move in the same general direction as the screen cursor.

To assign new button functions, see [setting the pen button functions](#).

WRITING AND DRAWING WITH PRESSURE SENSITIVITY



The pen responds to your hand movements, enabling you to create natural-looking pen and brush strokes. The [digital ink](#) tools in Microsoft Windows Vista and Office 2007, as well as the drawing tools in many graphics applications, respond to the pressure you place on the pen. For example, sliders are used in some applications to vary line characteristics (width, color, and opacity). These characteristics can be controlled much better by the pen's pressure sensitivity – you can vary line width, blend colors, and change opacity with the pressure you exert upon the pen.

To write, ink, or draw with pressure sensitivity, move the pen along the surface of the tablet while applying various amounts of pressure downward on the tip of the pen. Press hard for thick lines or dense color. Press gently for thin lines or softer color. Note that some applications require you first select a pressure-sensitive tool from the application's tool palette.

To adjust the tip feel, see [setting the tip and eraser feel, and double-click distance](#).

Visit our web site for a list of applications that support pressure. See [product information](#).

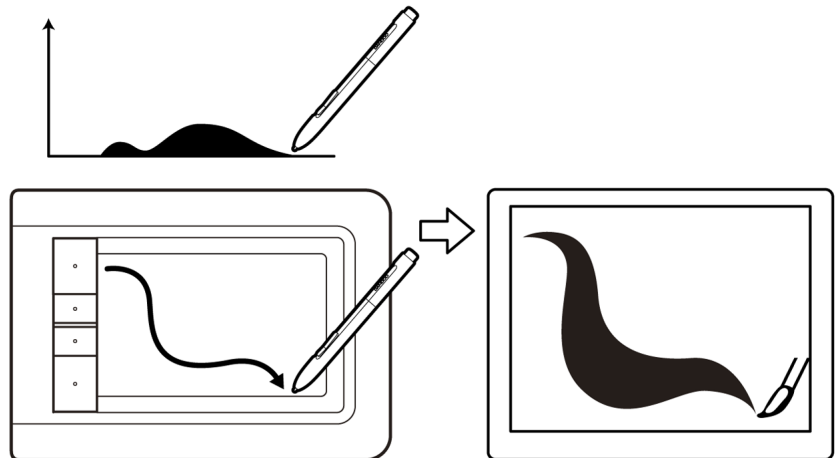

ERASING



The pen eraser (when equipped) works like the eraser on a pencil.

You can erase intuitively and naturally in graphics applications that support the pen eraser. When you use the pen eraser, the application will automatically switch to the eraser tool.

In applications that support pressure sensitivity, you can select pressure-sensitive tools in an application's tool palette to vary the width and depth of your erasures as you change the amount of pressure you exert upon the pen.

See [setting the tip and eraser feel, and double-click distance](#) for more information.

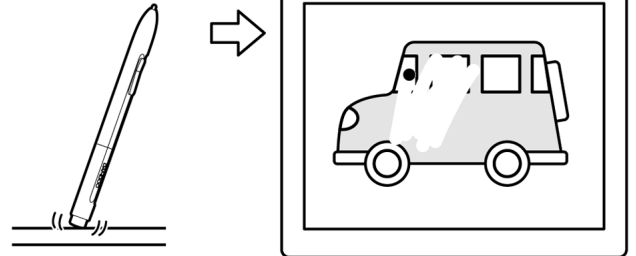

Use the pen eraser in Microsoft Windows Vista and Office 2007 to erase notes or sketches made with [digital ink](#), and to select and delete text or spreadsheet cells within an application.

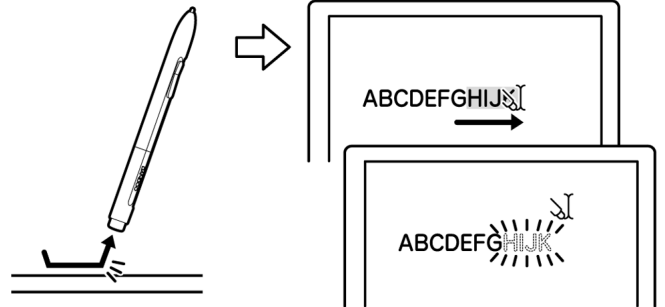

Visit our web site for a list of graphics applications that support the eraser (see [product information](#)). If the eraser is not supported in an application, you can still use the eraser for positioning, drawing, or annotation.

EYE-HAND COORDINATION EXERCISE



This exercise is designed to retrain your eye-hand coordination for using the pen:

1. Open any graphics application. Use the line tool to draw a rectangular grid with line spacings of about 20-25 mm (3/4 to 1 inch). You can use your traditional mouse to do this.
2. Choose a free-hand tool in your application and use the pen to draw a dot at each grid intersection.
3. Draw an X at each grid intersection.
4. Clear your screen and make a simple drawing of your own. The more you use your pen, the easier writing, drawing, and navigation will become.

CUSTOMIZING PEN INPUT



Customizing your pen is easy. Use the pen to open the Bamboo control panel. Then select the PEN tab to choose from the available options.

[Opening the control panel](#)

[Control panel overview](#)

[Customize your pen experience](#)



CUSTOMIZING YOUR BAMBOO

Use the Bamboo control panel to customize Bamboo for the way you like work.

[Opening the control panel](#)

[Control panel overview](#)

[Customize your touch experience](#)

[Customize your pen experience](#)

[Button functions](#)

OPENING THE CONTROL PANEL

To open the control panel:

- Windows. Click on the Windows START button and choose ALL PROGRAMS. Then select BAMBOO and choose the BAMBOO PROPERTIES option.
- Macintosh. Open SYSTEM PREFERENCES from either the Dock, the Apple menu, or from the APPLICATIONS folder. Then click on the BAMBOO icon.

The control panel displays only those tabs and options that apply to your tablet model and configuration.

Note: When more than one Wacom tablet is installed on a single computer, any changes made in the Bamboo control panel will be applied only to the tablet that was last used before opening the control panel.



CONTROL PANEL OVERVIEW

After opening the control panel, you can begin customizing Bamboo.

Customizable settings are found on each tab.

The tabs that apply to your tablet model and configuration are displayed when you open the control panel.

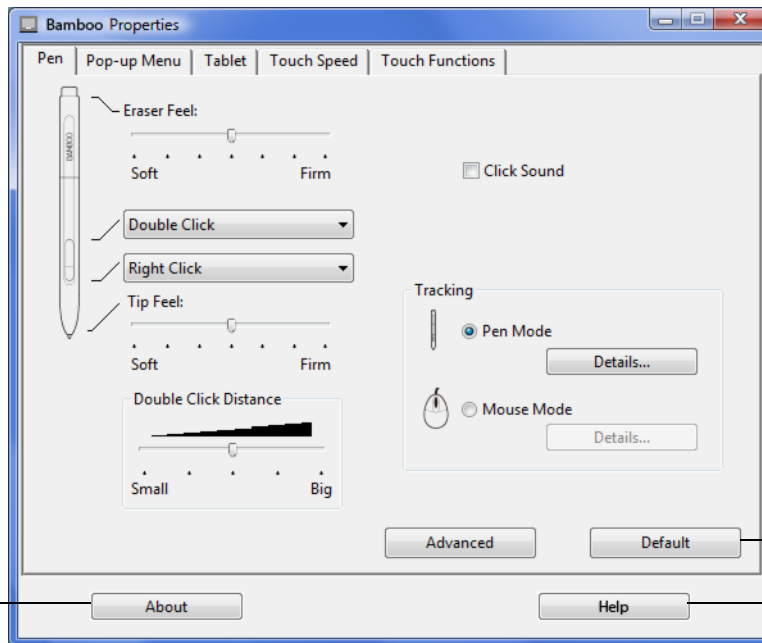

Closes the control panel.

Displays information about the control panel and driver.

Resets the selected tab to its default settings.

Displays this manual.

Experiment with different settings to find what works best for you. Any changes you make will take effect immediately. Click DEFAULT to return a tab to the factory settings.

Tool Tips are available for most control panel items. Position the screen cursor over an item and let it rest there; in a few moments the Tool Tip will pop up.

Your keyboard tab and arrow keys can also be used to navigate the control panel.

The following sections provide detailed information about each control panel tab and some of the more advanced concepts. Many of the sections also contain useful customizing tips.

[Customize your touch experience](#)

[Customize your pen experience](#)

[Button functions](#)

CUSTOMIZE YOUR TOUCH EXPERIENCE



The control panel touch options enable you to customize Bamboo for the way you like to interact with your tablet and computer when using touch input.

[Setting the touch speed](#)

[Setting the touch functions](#)

[Setting tablet and ExpressKey functions](#)

[Disabling touch](#)

SETTING THE TOUCH SPEED



Select the TOUCH SPEED tab. The touch speed options determine how fast you must move or tap your fingers in order for an action or gesture to be recognized.

Adjusts the screen pointer for speed of tracking and navigating. Choose a SLOW speed if you like to move the screen cursor at a slower rate using more finger motion. Choose a FAST speed to move the screen cursor quickly with less motion.

POINTER ACCELERATION sets the acceleration level of the screen pointer. Choose a LOW setting for a slower response to your finger motion on the tablet. Choose a HIGH setting for a quicker response.

The DOUBLE-TAP TIME adjusts how fast you must tap to register a double-click. To test your setting, position the screen cursor over the TEST area and tap twice.

Sets the scrolling speed of the SCROLL touch gesture.

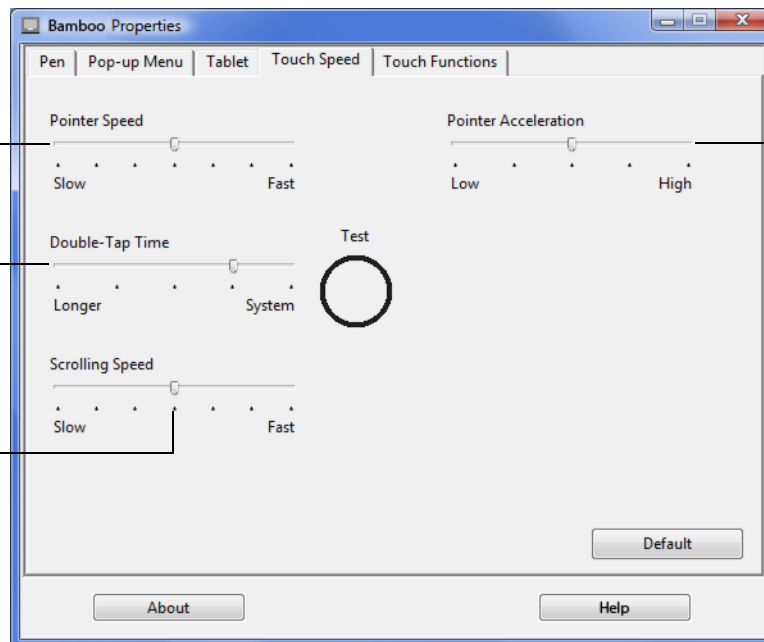

See also [navigating with touch](#).

Note: Touch speed and acceleration settings are independent of system settings. Changes you make to these settings in the Bamboo control panel do not affect similar system settings. However, changes made to similar system settings may affect your Bamboo tablet settings.

SETTING THE TOUCH FUNCTIONS



Select the TOUCH FUNCTIONS tab.

Touch [input options](#) can be enabled or disabled and are dependent upon application support.

Change the settings to customize how touch input works. Touch actions and gestures are available when selected.

So that you may work in different ways, some functions (such as a right-click) can be performed using different actions or gestures.

See also [navigating with touch](#).

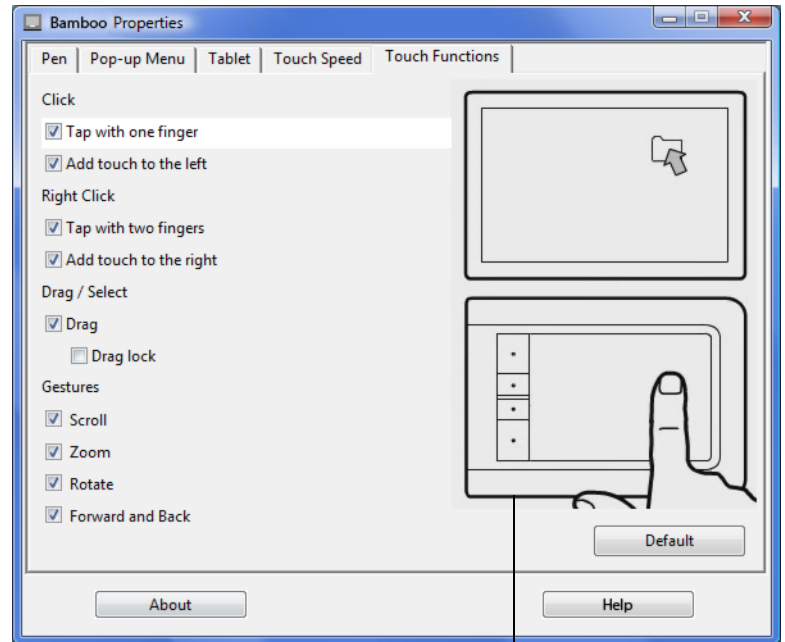

Position the screen cursor over an option to see an animated demonstration of that function.

If you do not choose a specific option to view, then the control panel animation will demonstrate each option sequentially, from top to bottom.

SETTING TABLET AND EXPRESSKEY FUNCTIONS

Choose the TABLET tab to set the tablet orientation and to customize the ExpressKeys.

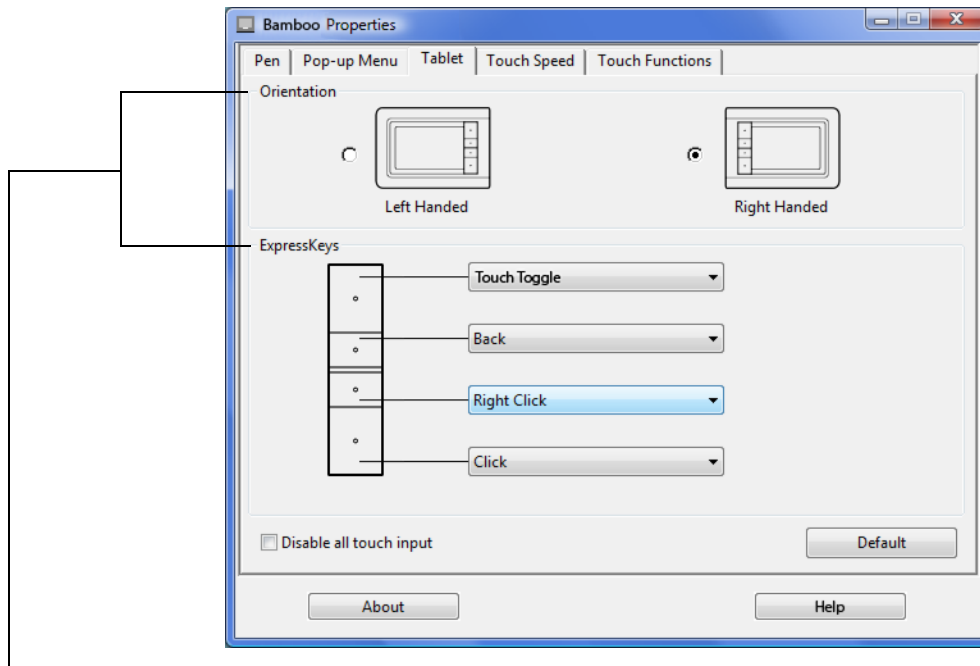

Tablet orientation

Change how your tablet is oriented by selecting RIGHT HANDED or LEFT HANDED input. The tablet driver automatically configures all aspects of the tablet for the selected option. Next, physically rotate the tablet to match your selection.

Note: At the log-in and user switching screens, the tablet orientation will use the default orientation that was selected when the driver was installed. If you want to change the default orientation, you must reinstall the driver using the Bamboo Installation CD. See [configuring the tablet orientation](#).

ExpressKey functions

Use the pull-down menus to choose a [function](#) that will be performed when the key is pressed. Your choice will be displayed either within the pull-down menu or beneath the menu.

- By default the upper key is set to TOUCH TOGGLE, allowing you to temporarily disable touch input when you press the ExpressKey. Press the ExpressKey again to re-enable touch input. (For Bamboo Touch, the default setting enables you to move FORWARD within Internet browsers.)
- You can use the 2nd from top key to move BACK within Internet browsers.
- The lower button default conditions are CLICK (bottom key) and RIGHT CLICK (2nd key up).

Note: Pen-only tablet models do not include ExpressKeys.

DISABLING TOUCH

Choose the **TABLET** tab to disable and enable touch input.

Available for tablet models configured for pen and touch input.

- Select to **DISABLE ALL TOUCH INPUT** and work with the ExpressKeys and pen only.
- Deselect to activate touch input.
- This option can also be changed by pressing an ExpressKey to which the **TOUCH TOGGLE** function has been assigned.

Note: When you disable touch, the **TOUCH SPEED** and **TOUCH FUNCTIONS** tabs will no longer be visible in the control panel. Re-enable touch to again access these tabs.

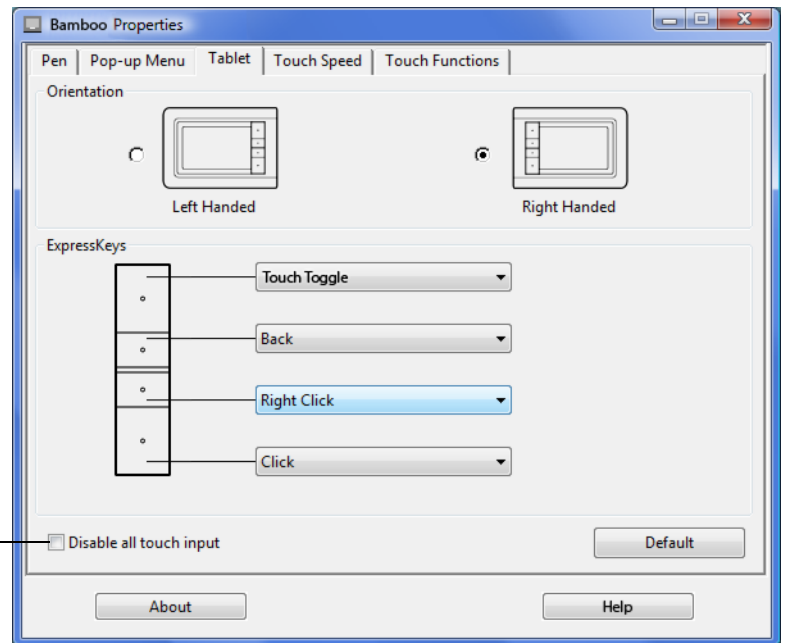

CUSTOMIZE YOUR PEN EXPERIENCE



Customizing your pen is easy. Use the pen to open the Bamboo control panel. You can then customize Bamboo for the way you like to interact with your tablet and computer when using pen input.

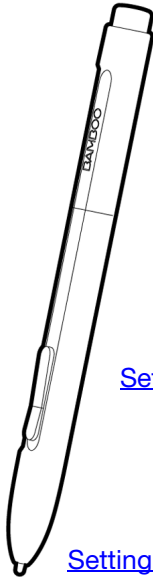

[Setting eraser feel](#)

[Setting the pen button functions](#)

[Setting tip feel and double-click](#)

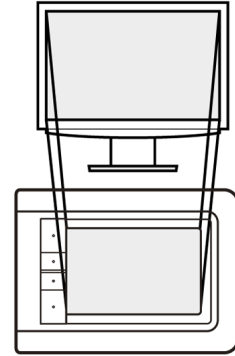

[Setting the tablet mapping](#)

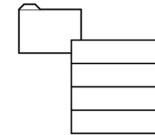

[Customizing the Pop-up Menu](#)

SETTING THE TIP AND ERASER FEEL, AND DOUBLE-CLICK DISTANCE



Select the PEN tab. To create broad brush strokes or to click with a light touch, use a soft tip setting. For maximum control while drawing thin lines, use a firm tip setting. To erase with a broad stroke or to click with a light touch, use a soft eraser setting. For maximum control while erasing, use a firm eraser setting.

Customizes the amount of pressure needed to erase. Drag the slider to a softer or firmer setting.

Customizes the amount of pressure needed to click, draw, or ink. Drag the slider to a softer or firmer setting.

Adjusts the size of the double-click area and the double-click speed. A larger setting makes double-clicking easier.

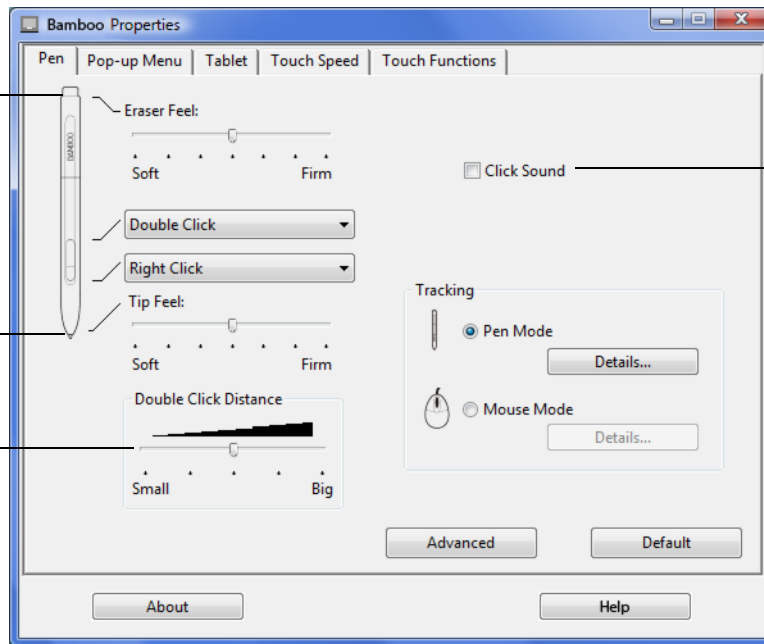

When checked, an audible “click” sound will be heard whenever a pen click occurs and your computer speakers are turned on.

Tips:

Use a soft TIP FEEL to reach the full pressure range with a lighter touch. In some applications, a soft pressure setting can make the pen overreact – any small press on the pen is magnified on the screen. If you experience this, try a firmer TIP FEEL setting.

To make double-clicking easier, expand the tap area that accepts a double-click (the double-click distance).

Note: A large double-click distance may cause a delay at the beginning of brush strokes in some drawing applications. This may also cause a delay at the beginning of a drag action or inking stroke. If you notice such effects, try setting a smaller double-click distance and using a pen button set to double-click (see [using the pen buttons](#)).

SETTING THE PEN BUTTON FUNCTIONS



Select the PEN tab to change the functions assigned to the buttons on your pen. Each pen button can be set to simulate a variety of mouse functions.

Select the [function](#) to perform when pressing the upper or lower pen button.

When you bring the pen tip within 7 mm (0.28 inch) of the tablet surface without touching the tablet and press the upper or lower pen button, the selected function occurs.

Tip: To make double-clicking easier, set a pen button to double-click automatically by selecting DOUBLE CLICK.

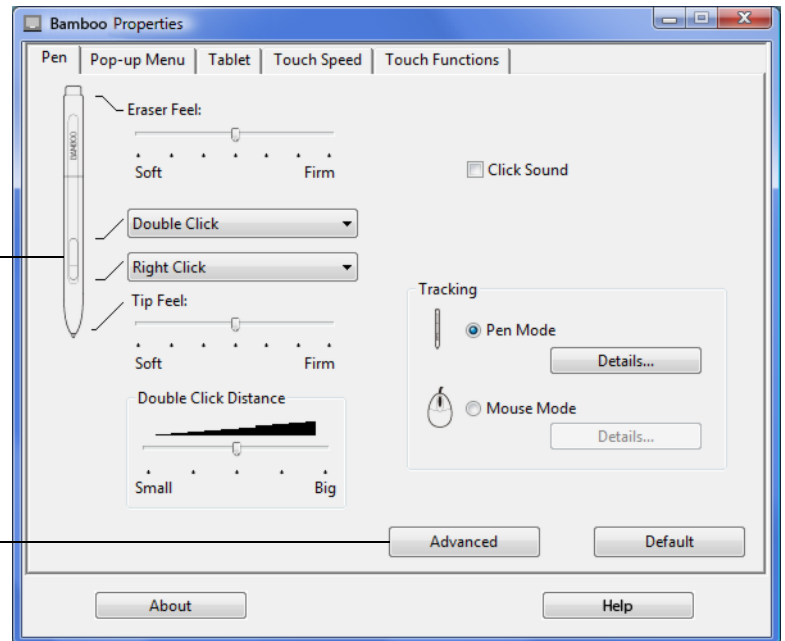

You can change the SIDE SWITCH MODE to best fit the way you like to use the pen when making right-clicks or other click functions. Click on the ADVANCED button to access the SIDE SWITCH MODE settings.

- HOVER CLICK to perform click functions without touching the pen tip to the tablet surface.
- CLICK & TAP to enable the precise placement of click functions. When selected, you must first press the pen button and then touch the pen tip to the tablet surface in order to perform the click function. This is the default setting for Tablet PCs.

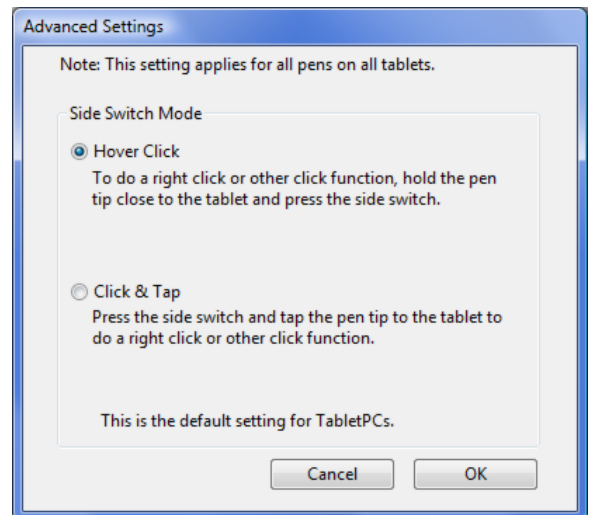
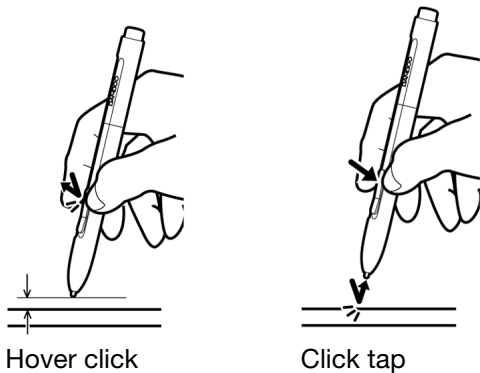

SETTING THE TABLET MAPPING



Select the PEN tab to set the tablet mapping. The tablet TRACKING options enable you to define the relationship between pen movement on the tablet surface and cursor movement on the monitor screen.

By default the entire active area of the tablet maps to the entire monitor. If more than one monitor is in use the tablet will map to all monitors. See [working with multiple monitors](#).

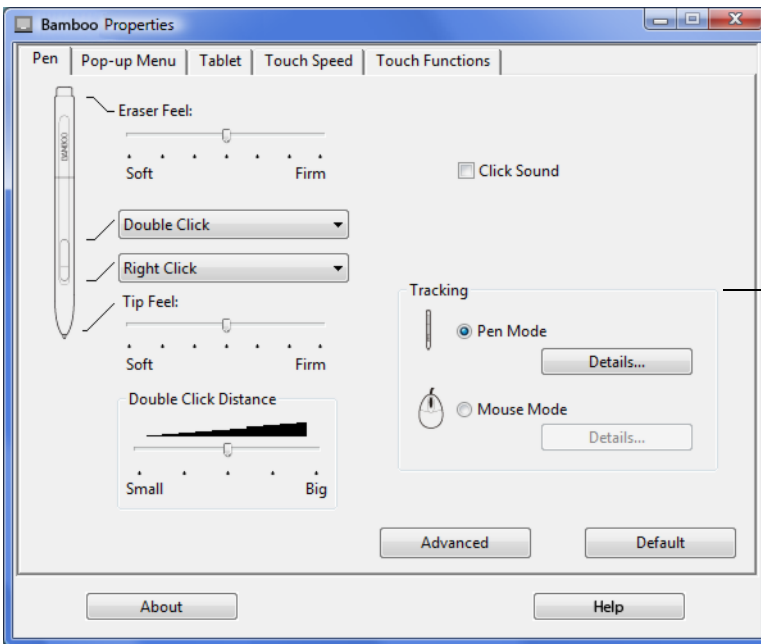

TRACKING options control how the screen cursor moves:

- Select PEN MODE to set the cursor so that its movement corresponds with the position of your pen on the tablet – wherever you place your pen on the tablet, the cursor will jump to a corresponding point on the screen. This is known as absolute positioning, and is the default setting for the pen. Click DETAILS... to customize the [tablet mapping](#).
- Select MOUSE MODE to move the screen cursor with a “pick up and slide” motion similar to using a traditional mouse. Click DETAILS... for [setting the pen speed in mouse mode](#).

Note: If you frequently switch between PEN MODE and MOUSE MODE, you can assign the MODE TOGGLE... function to one of your pen buttons or ExpressKeys.



When you click on the PEN MODE DETAILS... button, the PEN MODE DETAILS dialog box is displayed.

Use the SCREEN AREA options to select a screen area for tablet to screen mapping.

- ALL SCREENS. The entire monitor(s) area is mapped; this is the default setting. See [working with multiple monitors](#) for more information.
- MONITOR. The entire area of a single monitor that you choose is mapped.
- PORTION. A portion of the desktop area is mapped. Click SET... to open a dialog box where you can set the [portion of screen area](#).

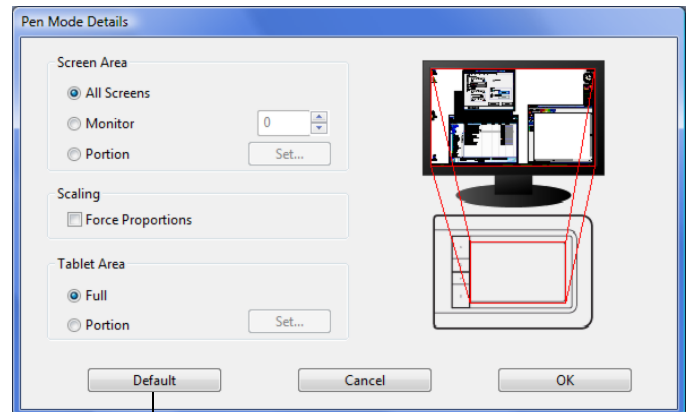

Returns settings to their factory defaults.

When FORCE PROPORTIONS is unchecked, the correct scale or proportions are not maintained. The selected tablet area is mapped to the selected display area. Drawing a circle on the tablet may create an ellipse on the display screen. This is the default setting.

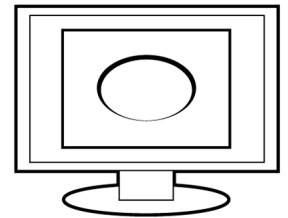

When FORCE PROPORTIONS is checked, the correct vertical and horizontal proportions are maintained. Drawing a circle on the tablet results in a circle on the display screen. Depending on your settings, some portions of the tablet active area may no longer be usable when this option is selected.

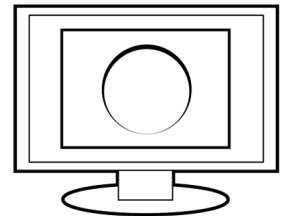

Use the TABLET AREA options to select a tablet area for tablet to screen mapping.

- FULL. The entire active area of the tablet is mapped. This is the default setting.
- PORTION. A portion of the tablet area is mapped. Click SET... to open a dialog box where you can set the [portion of tablet area](#).

Note: Although Bamboo is optimized for use with 16 : 10 aspect ratio displays, the default settings automatically adjust for use with other aspect ratio displays.

PORTION OF SCREEN AREA



The tracking options in the PEN MODE DETAILS dialog box allow you to define which portion of the display screen your tablet will map to:

ALL SCREENS

Maps the entire monitor(s) area. This is the default setting. See [working with multiple monitors](#).

MONITOR

Maps the entire area of a single monitor that you choose.

PORTION

Allows you to select a portion of the display for tablet to screen mapping. Click SET... to open the PORTION OF SCREEN dialog box.

Choose a method for defining a portion of the display:

- Drag corners of the foreground graphic to select the screen area.
- Select the **CLICK TO DEFINE SCREEN AREA** button and move the screen cursor to select the screen area. Be sure to follow any MESSAGE prompts.

After defining a portion of the screen, you may need to use a different input device to access other portions of the screen area.

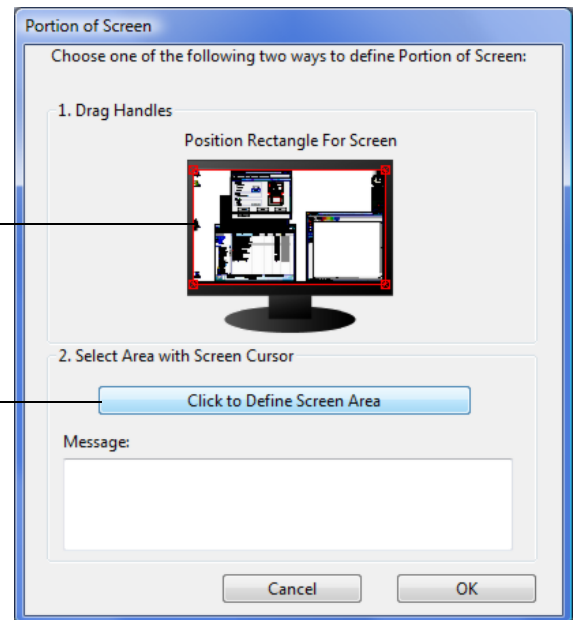

PORTION OF TABLET AREA



The tracking options in the PEN MODE DETAILS dialog box allow you to define the tablet area that will be mapped to the screen area:

FULL

The entire active area of the tablet is mapped. This is the default setting.

PORTION

Allows you to select a portion of the tablet active area for tablet to screen mapping. Click SET... to open the PORTION OF TABLET dialog box.

Choose a method for defining a portion of the tablet:

- Drag corners of the foreground graphic to select the tablet area that will be mapped to your selected screen area.
- Select the CLICK TO DEFINE TABLET AREA button and use your pen on the tablet to select the tablet area. Be sure to follow any MESSAGE prompts.

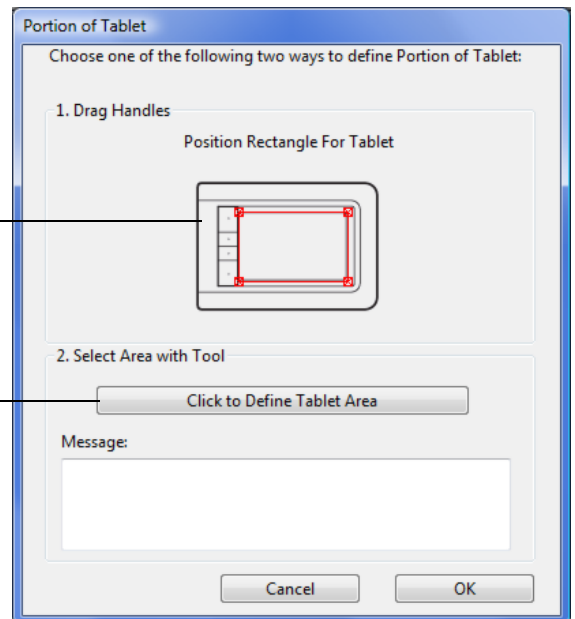

SETTING THE PEN SPEED IN MOUSE MODE



To change the screen cursor acceleration and speed when using the pen in MOUSE MODE, click on the MOUSE MODE DETAILS... button (located on the PEN tab). A dialog box will be displayed where you can make your adjustments.

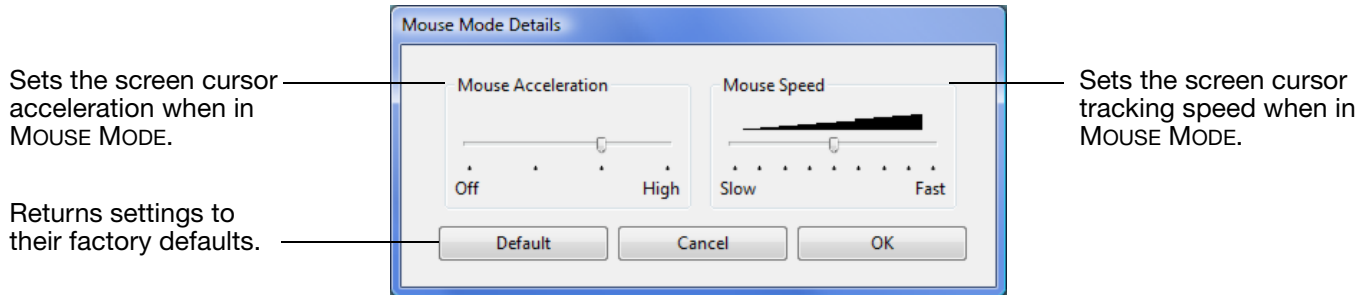

Notes:

The dialog box will also appear when you set a button to MODE TOGGLE.... Note that only one ACCELERATION and SPEED setting can be made.

The mouse mode acceleration and speed settings are independent of system settings. Changes you make to these settings in the Bamboo control panel do not affect similar system settings. However, changes made to similar system settings may affect your Bamboo tablet settings.

CUSTOMIZING THE POP-UP MENU

The Pop-up Menu is available for tablet models that are configured for both pen and touch input. Select the POP-UP MENU tab to create the custom menu and define the available functions that will appear in the menu.

To display the Pop-up Menu, set a pen button to the POP-UP MENU function. Whenever you press that button, the Pop-up Menu is displayed at the screen cursor position.

Choose from available options in the menu by clicking on them. To close the Pop-up Menu without making a selection, click outside of the menu.

Select a [button function](#) to add to the Pop-up Menu list.

Displays a list of functions that have been added to the Pop-up Menu. To change the order of an item, drag it to a new location. Double-click on an item to make edits.

Removes the selected item from the list.

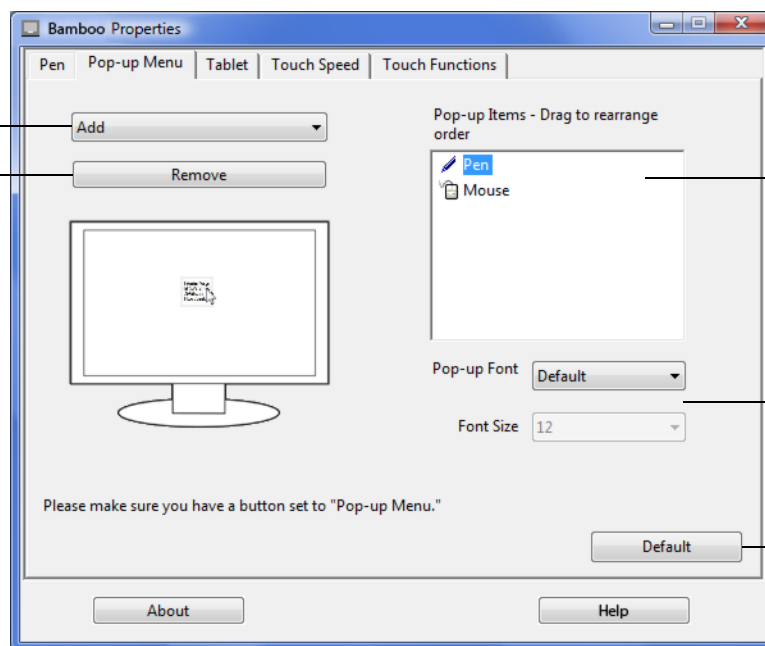

Sets the FONT and FONT SIZE of the Pop-up Menu.

Returns the tab settings to the default values.

Important: This action will delete all Pop-up Menu items that have been defined.

BUTTON FUNCTIONS

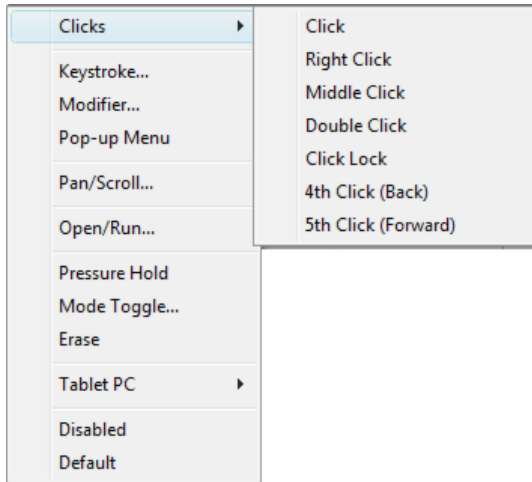

The following options are available for ExpressKey and pen button settings. Not all options are available for all controls.

FUNCTION	DESCRIPTION
CLICKS	
<ul style="list-style-type: none"> • CLICK 	Simulates a primary mouse button click. Default setting for the pen tip.
<ul style="list-style-type: none"> • RIGHT CLICK 	Simulates a right mouse button click, which displays a context menu.
<ul style="list-style-type: none"> • MIDDLE CLICK 	Simulates a middle mouse button click.
<ul style="list-style-type: none"> • DOUBLE CLICK 	Simulates a double-click. For easier double-clicking, use this function instead of tapping twice with the pen tip.
<ul style="list-style-type: none"> • CLICK LOCK 	Simulates holding down the primary mouse button. Press the tool button once to initiate click lock. Press the button again to release click lock. Click lock is useful for dragging objects or selecting blocks of text.
<ul style="list-style-type: none"> • 4TH CLICK 	Simulates a 4th mouse button click.
<ul style="list-style-type: none"> • 5TH CLICK 	Simulates a 5th mouse button click.
BACK	Simulates the BACK command in browser applications.
FORWARD	Simulates the FORWARD command in browser applications.
ERASE	Pen only. Sets a button so that when the button is pressed, the pen tip will act like the eraser in applications that support the ERASE function. See erasing for information on using the eraser.



FUNCTION

DESCRIPTION

KEYSTROKE...

Enables you to simulate keystrokes. Select this option to display the DEFINE KEYSTROKE dialog box.

Enter a keystroke or keystroke combination in the KEYS entry box. Keystroke combinations can include letters, numbers, function keys (such as F3) and modifier keys (such as SHIFT, ALT, or CTRL for Windows, or SHIFT, OPTION, COMMAND, and CONTROL for Macintosh).

You can also select special keystrokes or keystroke combinations from the ADD SPECIAL pull-down menu.

After defining a keystroke sequence, click OK.

Important: Because the ENTER (Windows) and RETURN (Macintosh) keys can be selected as a defined keystroke, they cannot be used to select OK. You must use your pen to click on the OK button.

If prompted, enter a name for the keystroke definition. The name will be displayed with the respective control or in the Pop-up Menu list, as applicable.

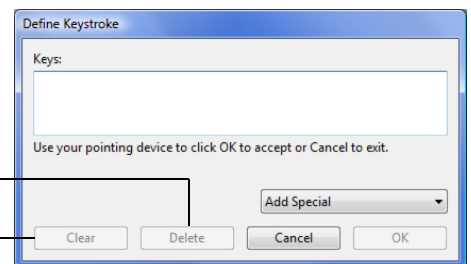

Deletes only the last entry in the keystroke entry box.

Clears the keystroke entry box.

To learn which keystroke shortcuts are supported by a particular application, see the documentation that came with the application.

MODIFIER...

Enables you to simulate modifier key(s) (such as SHIFT, ALT, or CTRL for Windows, or SHIFT, OPTION, COMMAND, and CONTROL for Macintosh). Many applications use modifier keys to constrain the size or placement of objects.

Choose one or more modifier key options. Select the CLICK box if you want a mouse click to occur whenever you press the tool button.

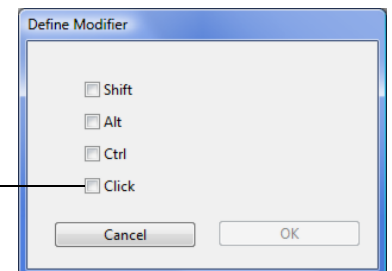

FUNCTION	DESCRIPTION
POP-UP MENU	Displays a Pop-up Menu on your screen. See customizing the Pop-up Menu for more information.

PAN/SCROLL	Pen only. Enables you to position a document or image in any direction within the active pane by pressing a pen button set for PAN/SCROLL and then dragging with the pen tip across the tablet's active area.
------------	---

When you select PAN/SCROLL, the PEN SCROLL SPEED dialog box prompts you to set a scrolling speed that will be used in applications that do not support grabber hand (pixel-level) panning within a document or image.

A slower setting reduces the scroll rate and is useful for close-up and detail work where you need precise control of the image.

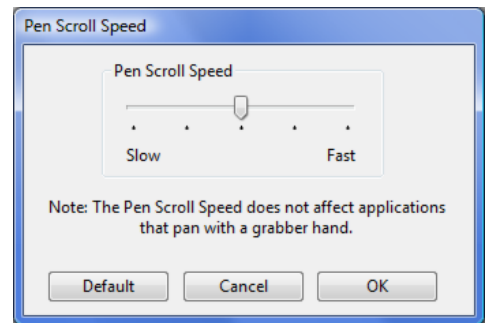

As you move the pen tip, the document or image is repositioned to follow the direction of pen movement on the tablet.

Release the button or lift the pen tip from the tablet surface when you are done.

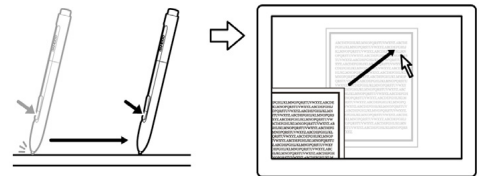

SHOW DESKTOP	Minimizes all open windows to display a clean desktop.
SWITCH APPLICATIONS	Brings up the application switching dialog with focus on the next open application. On Windows Vista systems running Aero, Flip 3D will be activated with focus on the next open application.

OPEN/RUN...	Opens a dialog box where you can select a specific application, file, or script to launch.
-------------	--

Click BROWSE... to locate an application, file, or script to launch. The selection you make appears in the APPLICATION TO RUN box. Click OK to accept the selection.

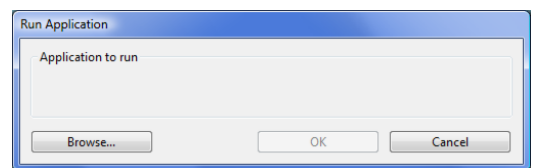

The dialog box will close and the OPEN/RUN... option you have selected will be assigned as your tool button option. Simply press the tool button to launch the assigned option.

If your selection is for the Pop-up Menu, it will be displayed in the Pop-up Menu list.





FUNCTION	DESCRIPTION
TOUCH TOGGLE	Available for Bamboo and Bamboo Fun. TOUCH TOGGLE is useful when you are working with the pen and want to prevent accidental touch input (e.g., to prevent an accidental right-click). Temporarily disable touch by pressing an ExpressKey to which you have assigned the TOUCH TOGGLE function. Press the ExpressKey again to re-enable touch input. See also setting tablet and ExpressKey functions .
INK TOGGLE	(Macintosh.) Toggles the INK ANYWHERE function of Inkwell on and off. Inkwell automatically recognizes and converts your handwriting into text and inserts it into a document. Note that Ink must be turned on for this function to work. See your Macintosh help for information on working with Inkwell.
TABLET PC	
<ul style="list-style-type: none"> TABLET PC INPUT PANEL 	(Tablet PCs and Windows Vista systems that support the Tablet PC Input Panel.) Opens the Tablet PC Input Panel when you press a tool button set to this function.
<ul style="list-style-type: none"> JOURNAL 	(Windows Vista and Tablet PC systems that include Microsoft Journal.) Opens Microsoft Journal.
EXPOSÉ	(Macintosh.) Tiles all open windows.
PRESSURE HOLD	Locks the pressure at the current pressure level until the button is released. For example, you can paint with pressure sensitivity until you reach the brush size that you like. You can then press the button and continue painting with the same size brush until the button is released.
MODE TOGGLE...	Toggles pen input between PEN MODE and MOUSE MODE. See setting the pen speed in mouse mode for details.
DISABLED	Disables the button function.
DEFAULT	Returns a button to its default setting.





PROBLEMS WITH YOUR BAMBOO?

Most of the time your tablet will work flawlessly. But if you are having trouble, Wacom recommends you do the following:

1. If the tablet driver failed to load properly, first perform the recommended action in any error message that may appear on your screen. If that does not solve the problem, review the troubleshooting procedures in this chapter.
2. Look in the [troubleshooting tables](#). Your problem may be described there and you can try the solution offered.
3. Open the tablet Read Me file and look for any information updates.
4. Test your tablet and pen (if equipped). See [testing your tablet](#).
5. If you are having a compatibility conflict between Bamboo and a new hardware or software product, see [obtaining driver downloads](#) for information on downloading an updated software driver. Wacom periodically updates the software driver to maintain compatibility with new products.
6. Check the FAQs (Frequently Asked Questions) on the Wacom web site for your region.
7. If you have tried the suggestions in this manual and still cannot resolve the problem, then contact Wacom for technical support. See [technical support options](#) and the Read Me file for information on where to obtain support for your region.

[Testing your tablet](#)

[Testing a pen](#)

[Troubleshooting tables](#)

[Technical support options](#)

[Obtaining driver downloads](#)





TESTING YOUR TABLET

1. Turn on your computer and wait until the system has fully loaded.
2. Check the connection. The tablet status LED should glow whenever the tablet is properly connected and your computer has registered it as a USB device. If not:
 - Make sure the tablet USB cable is securely connected to an active USB port on your computer.
 - Check the tablet USB cable for damage.
 - If you are connecting the tablet to a USB hub (or hub device such as a keyboard with USB ports), be sure the USB hub is properly connected to your computer and is active.
 - If the status LED does not illuminate after your computer is on and has finished booting up, your USB port may be disabled. Verify that you have connected the tablet to an active USB port.
 - Connect the tablet to a different USB port or try connecting to the USB port on another computer.
3. Check touch and pen input:
 - Check touch input. Attempt to move the screen cursor by tracking your finger across the tablet surface. Then tap to select an item. The status LED should brighten when you touch the active area of the tablet.

If the tablet driver does not load properly, basic touch movement will be recognized but other actions and gestures will not. If the driver does not properly load, the lower two ExpressKeys only will function at their default settings of CLICK (bottom key) and RIGHT CLICK (2nd key up). If gestures are not recognized and ExpressKeys do not function, insert the Bamboo Installation CD into your computer and install the driver software for the tablet.
 - Check pen input. If your tablet is equipped with a pen and the tablet driver does not load properly, pen input will not be available. (If you have a pen-only tablet model, you will be able to use the pen tip to move the screen cursor and click. You will also be able to use the pen buttons to CLICK (lower button) and RIGHT CLICK (upper button), but there will be no other pen functionality.) Insert the Bamboo Installation CD into your computer and install the driver software for the tablet. See also [testing a pen](#).
4. Check the ExpressKeys (if equipped). Do a quick check by pressing each key in turn. The status LED should brighten each time you press a key when there is no touch or pen input. Then open the Bamboo control panel and select the TABLET tab. Click on the DEFAULT button to return to the tablet default settings.
 - Press the upper ExpressKey to toggle touch input off and on. (For Bamboo Touch: Open your Internet browser and click on a couple of links. Next click on the appropriate browser button to move backwards. Then press the upper ExpressKey to move forward within the browser.)
 - Open your Internet browser and click on a couple of links. Press the second from top key to move back within the browser.
 - Position the screen cursor over an item, such as an empty folder on your desktop, and press the bottom ExpressKey to perform a click.
 - Position the screen cursor over an item, such as an empty folder on your desktop, and press the second up from bottom ExpressKey to perform a right-click.
5. If any of these tests fail you may have defective hardware. See [technical support options](#).
6. After testing, use the Bamboo control panel to reconfigure your tablet for any custom settings you may originally have been using.





TESTING A PEN



1. First perform the procedures for [testing your tablet](#).
2. Check the pen by opening the Bamboo control panel and selecting the PEN tab. Click on the DEFAULT button to return the pen to its default settings. Next:
 - Touch the pen tip and then the eraser (when equipped) to the tablet active area. The status LED should brighten each time the tip or eraser makes contact with the tablet surface.
 - Without applying pressure to the pen tip, hold the pen tip within approximately 7 mm (0.28 inch) of the tablet surface and press each pen button in turn. The status LED should brighten each time a pen button is pressed.
 - While still within proximity, but without touching the tablet surface, move your pen across the active area of the tablet. The screen cursor should move in the corresponding direction on your monitor or display screen.
3. If any of these tests fail you may have defective hardware. See [technical support options](#).
4. After testing, use the Bamboo control panel to reconfigure your tablet and pen for any custom settings you may originally have been using.





TROUBLESHOOTING TABLES

If you encounter problems with your Bamboo tablet or pen (when equipped), refer to the following tables. Your problem may be described here, and you can try the solution offered. Be sure to check the Read Me file for the latest information updates.

For additional information, visit Wacom's web site at <http://www.wacom.com/productsupport>.

[General problems](#)

[Touch input problems](#)

[Pen input problems](#)

[Windows-specific problems](#)

[Mac-specific problems](#)

GENERAL PROBLEMS

The computer does not have an available USB port.	Check if there is an available USB port on a USB hub device. If not available you will need to add a USB hub or USB card.
The tablet status LED does not illuminate.	Verify that your tablet's USB cable is properly connected to an active USB port. If you are connecting to a USB hub device, make sure the hub is connected to an active USB port and that the hub is active.
The computer does not go to sleep when using a tablet configured for pen input.	When you are not using the pen, remove it from the tablet surface or the tablet will continue to send data, keeping the computer awake. Note: Because some metallic or other conducting objects can also cause the tablet to send data, it is best to keep the tablet surface clear of all objects when not in use.
The screen cursor is very erratic or jumps around when using the tablet.	On rare occasions the tablet may receive interfering radio frequencies from a computer monitor or nearby AM radio station. If you notice interference from a monitor, try moving the tablet at least six (6) inches away from the monitor, or change the monitor refresh rate or monitor resolution.
The tablet is set for RIGHT HANDED (or LEFT HANDED), but at the log-in screen the tablet seems to work upside down.	Reinstall the tablet driver from the Bamboo Installation CD and change the default orientation of the tablet. See configuring the tablet orientation for details.



TOUCH INPUT PROBLEMS



Touch input does not work.	Re-enable touch input by pressing an ExpressKey that is set to TOUCH TOGGLE. Otherwise, open the Bamboo control panel and go to the TABLET tab. Be sure the DISABLE ALL TOUCH INPUT option is deselected.
Touch input does not seem to fully work. The screen cursor can be moved, but more complex actions or gestures do not work.	If the tablet driver does not load properly, basic touch movement will be recognized but other actions and gestures will not. If the driver does not properly load, the lower two ExpressKeys only will function at their default settings of CLICK (bottom key) and RIGHT CLICK (2nd key up). Insert the Bamboo Installation CD into your computer and install the driver software for the tablet.
The tablet does not reliably recognize two fingers.	If you hold your fingers too close together, the tablet may not recognize them as being separate. Try moving your fingers a little further apart.
Cannot zoom-in or zoom-out when working with Adobe Photoshop.	If zoom functions do not operate correctly within Photoshop, verify that the ZOOM WITH SCROLL WHEEL function is selected within the Photoshop PREFERENCES options.
Scrolling and panning gestures do not function correctly when working with Adobe Photoshop.	If touch input gestures do not operate correctly within Photoshop, verify that the ZOOM WITH SCROLL WHEEL function is selected within the Photoshop PREFERENCES options.
Rotation gestures do not seem to work consistently, or not at all.	<p>Rotation may work differently depending on the application you are working with. For example, rotation may work smoothly, in 90-degree increments, or not at all.</p> <p>For best recognition of this gesture, start with your fingers positioned diagonally on the tablet surface and keep them at least 25 mm (1 inch) apart.</p>
The TOUCH SPEED and TOUCH FUNCTIONS tabs are not visible in the control panel.	Go to the TABLET tab and uncheck the DISABLE ALL TOUCH INPUT option. If you have assigned TOUCH TOGGLE to an ExpressKey, you can press the ExpressKey to toggle the tabs back on.

PEN INPUT PROBLEMS



The pen does not position the screen cursor, or otherwise work.

If the tablet driver does not load properly, pen input will not be available.

- For tablet models that combine pen and touch input, basic touch movement will continue to be recognized but other actions and gestures will not. If the driver does not properly load, the lower two ExpressKeys only will function at their default settings of CLICK (bottom key) and RIGHT CLICK (2nd key up).
- If you have a pen-only tablet model, you will be able to use the pen tip to move the screen cursor and click. You will also be able to use the pen buttons to CLICK (lower button) and RIGHT CLICK (upper button), but there will be no other pen functionality.

Insert the Bamboo Installation CD into your computer and install the driver software for the tablet.

The pen does not draw or ink with pressure sensitivity.

Some applications require that you turn on the pressure capabilities within the application or the selected tool before the pen will respond as a pressure-sensitive tool.

Clicking is difficult.

Open the Bamboo control panel and go to the PEN tab. Try using a lighter TIP FEEL.

Select the CLICK SOUND option (the check box should be checked). This will enable you to hear when the pen registers a mouse click. Your computer speakers must be turned on and the volume audible before you can hear CLICK SOUND.

Double-clicking is difficult.

Be sure you are quickly tapping the tablet twice in the same place on the tablet active area.

Using a pen button set to double-click is recommended (review the techniques in [clicking](#)).

Open the Bamboo control panel and go to the PEN tab.

- Try increasing the DOUBLE CLICK DISTANCE.
- Try using a lighter TIP FEEL.

For Windows, try setting your system to launch programs with a single click. See [clicking](#).

The pen selects everything, will not stop selecting.

Open the Bamboo control panel and go to the PEN tab. Move the TIP FEEL slider toward FIRM. If this does not help, see [testing a pen](#).

The eraser (when equipped) selects everything or will not stop erasing.

Open the Bamboo control panel and go to the PEN tab. Move the ERASER FEEL slider toward FIRM. If this does not help, see [testing a pen](#).

You notice a screen delay at the beginning of pen or inking strokes.

Open the Bamboo control panel and go to the PEN tab. Try decreasing the DOUBLE CLICK DISTANCE.





You have to press hard with the pen when clicking, drawing, or writing.

Open the Bamboo control panel and go to the PEN tab. Move the TIP FEEL slider toward SOFT.

The pen tip does not function.

Be sure you are using the pen that originally came with your tablet. Other pens may not function properly on the Bamboo tablet.

See [testing a pen](#) to verify pen operation. If any of the tests fail you may have defective hardware.

The screen cursor jumps back.

Do not place the pen on the tablet when it is not in use or when you are using another pointing device. Leaving your pen on the tablet may interfere with screen cursor positioning when using other input devices.

The upper or lower pen button does not work.

Be sure you press the pen button when the pen tip is within 7 mm (0.28 inch) of the tablet active area – do this without pressing down on the pen tip.

In the Bamboo control panel, click on the PEN tab ADVANCED button. If CLICK & TAP is selected, you will need to first press the pen button and then touch the pen tip to the tablet surface in order to perform a click function. See [setting the pen button functions](#).

From the Bamboo control panel, verify that the pen button is set to the function you are expecting to occur.

See [testing a pen](#) to verify pen operation. If any of the tests fail you may have defective hardware.

Cannot move the cursor where you want to on the screen, or the line you are drawing does not line up with the location of the pointer in paint applications.

Open the Bamboo control panel. Verify that PEN MODE is selected. If this does not help, click on the DEFAULT button to reestablish the default tablet to screen mapping. If you are still having difficulty, remove the tablet preferences (see [Windows-specific problems](#) or [Mac-specific problems](#) for details).

WINDOWS-SPECIFIC PROBLEMS

You suspect the tablet preferences may be corrupted, or want to make certain that all settings are at their factory defaults.

Delete the tablet preferences as follows:

First close any open applications. Then click the START icon and select ALL PROGRAMS. Select BAMBOO and BAMBOO PREFERENCE FILE UTILITY. In the dialog box that appears, click on the REMOVE My Preferences button to delete the preferences for the current user.

To delete preferences for multiple users on Windows Vista or XP systems, click the REMOVE button under All User Preferences.

Note that administrator rights are required to delete preferences for all users. Relaunch any currently open tablet-aware applications that you may be running.

If you had previously backed up your preference file, you can quickly restore the tablet preferences by clicking on the RESTORE... button under My Preferences.





MAC-SPECIFIC PROBLEMS

At startup, a dialog box appears telling you that either the driver failed to load or the tablet preferences have not yet been created.

The tablet was not detected at startup. Make sure the USB interface cable is securely connected to an active USB port on your computer. Make sure also that the tablet status LED is illuminated. If your tablet is plugged into a USB hub, make sure the hub is connected and active.

From the GO menu, select the UTILITIES folder and launch the SYSTEM PROFILER. Select USB from the HARDWARE section of the CONTENTS list. A Wacom USB tablet model should be listed. If a tablet model is not listed, check the USB tablet cable connection or try plugging the tablet into a different USB port.

If this does not help, contact Wacom for technical support. See [technical support options](#).

You suspect the tablet preferences may be corrupted, or want to make certain that all settings are at their factory defaults.

Delete the tablet preferences. First open the main APPLICATIONS folder. Then open the TABLET folder and run the REMOVE BAMBOO utility.

- **Single user.** When the utility starts, select CURRENT USER and click on the REMOVE button. Log out, then log back in. When the tablet driver loads it will create a new preferences file with the factory defaults.
- **Multiple users.** When the utility starts, select ALL USERS and click on the REMOVE button. Log out, then log back in. When the tablet driver loads it will create new preferences files with the factory defaults.

If you had previously backed up your preference file, you can quickly restore the tablet preferences for the CURRENT USER or ALL USERS by clicking on the RESTORE... button within the utility.

Note: Do not manually remove the BAMBOO.PREFPANE file from the main LIBRARY PREFERENCEPANES folder. This file is only to be removed when uninstalling the tablet software driver, and then only when using the REMOVE BAMBOO utility.





Inkwell does not work correctly with the tablet.

There may be a problem with the Inkwell preferences. Remove the damaged preference files as follows. They will be recreated when you enable handwriting recognition.

1. From the Apple menu, choose SYSTEM PREFERENCES. From the System Preferences menu, choose SHOW ALL and select INK. Then turn off handwriting recognition.
2. From the GO menu, choose your HOME. Open the LIBRARY and PREFERENCES folders. Then remove the following preferences:
 - com.apple.ink.framework.plist
 - com.apple.ink.inkpad.plist
 - com.apple.ink.inkpad.sketch
3. Go back to SYSTEM PREFERENCES and INK, and then enable handwriting recognition.
4. Test the Inkwell function using your tablet and pen.
5. If this procedure does not resolve your problem with Inkwell, contact Apple Support for further assistance. Wacom is not the software manufacturer for Inkwell and we are limited in our abilities to support a third party software application.





TECHNICAL SUPPORT OPTIONS

If you have a problem with your tablet, first check the tablet installation guide to be sure the unit is installed correctly. Then review the [troubleshooting](#) procedures.

If you cannot find the answer in this manual, you may find updated information about your problem in the Read Me file for your platform (located on the Bamboo Installation CD). You can also check the product FAQs (Frequently Asked Questions) on the Wacom web site for your region.

If you have an Internet connection you can download the latest software drivers from the Wacom web site for your region. See [obtaining driver downloads](#).

If you cannot solve the problem and you think your tablet is not working properly, contact the Wacom support staff for the area where your product was purchased. See the tablet Read Me file, located on the Bamboo Installation CD, for contact information.

When you call, you should be at your computer with the following information available:

- This manual.
- Tablet serial and model number. (Look on the bottom of the tablet.)
- Driver version number. (See the Bamboo Installation CD or the Bamboo control panel.)
- The make and model of your computer, and operating system version number.
- A list of peripheral devices attached to your computer.
- The software application and version you were using when the problem occurred.
- The exact wording of any error message that appeared on your screen.
- What happened and what you were doing when the problem occurred.
- How you tried to solve the problem.





OBTAINING DRIVER DOWNLOADS

Wacom periodically updates the tablet software driver to maintain compatibility with new products. If you are having a compatibility problem between Bamboo and a new hardware or software product, it may be helpful to download a new Wacom tablet software driver (when available) from the Internet.

USA, Canada, Central and South America

Worldwide Web: <http://www.wacom.com/productsupport> Software updates.

Europe, Middle East and Africa

Worldwide Web: <http://www.wacom.eu/downloads> Software updates.

Japan

Worldwide Web: <http://tablet.wacom.co.jp/download/down1.html> Software updates. (Japanese)

Asia Pacific (English)

Worldwide Web: <http://www.wacom-asia.com> Software updates. (English)

China

Worldwide Web: <http://www.wacom.com.cn> Software updates.
(Simplified Chinese)

Korea

Worldwide Web: <http://www.wacomkorea.com> Software updates. (Korean)

Taiwan

Worldwide Web: <http://www.wacom.com.tw> Software updates.
(Traditional Chinese)





APPENDIX

This section contains tips on caring for Bamboo, instructions on how to uninstall the tablet software, information about digital inking, your license and warranty, and more.

[Caring for Bamboo](#)

[Replacing the pen nib](#)

[Uninstalling the software](#)

[Pen and digital ink capabilities in Windows Vista](#)

[About the Windows Vista Tablet PC Input Panel](#)

[Product specifications](#)

[Product information](#)

[Ordering parts and accessories](#)

[Radio and television interference](#)

[Precautions](#)

[License and Warranties \(Worldwide, except for Europe, Africa and Middle East\)](#)

[Licence warranty conditions \(Europe, Africa and Middle East\)](#)



CARING FOR BAMBOO

Keep your Bamboo tablet surface and pen (when equipped) clean. Dust and dirt particles can stick to the pen and cause excessive wear to the tablet surface. Regular cleaning with a soft, damp cloth will help to prolong the life of your tablet surface and pen; you can also dampen the cloth using a very mild soap diluted with water. Do not use volatile liquids, such as paint thinner or benzene, as they may damage the plastic case.

Keep Bamboo in a clean, dry place and avoid extremes in temperature. Room temperature is best. Also, your Bamboo tablet and pen (when equipped) are not made to come apart. Twisting the pen case can break the pen. Taking apart the product will void your warranty.

Important: Take care to never spill liquids onto the tablet or pen. Be especially careful of getting the tablet ExpressKeys or pen buttons, tip, and eraser (when equipped) wet – they contain sensitive electronic parts that will fail if liquid enters them.

REPLACING THE PEN NIB



The pen nib (tip) will wear with normal use. Excessive pressure will cause it to wear sooner. Replace the nib when it gets too short – less than 1 mm (0.4 inch) – or develops a flat point.

1. Clasp the old nib with the nib extractor, pair of tweezers, needle-nosed pliers, or similar instrument and pull it straight out of the pen.

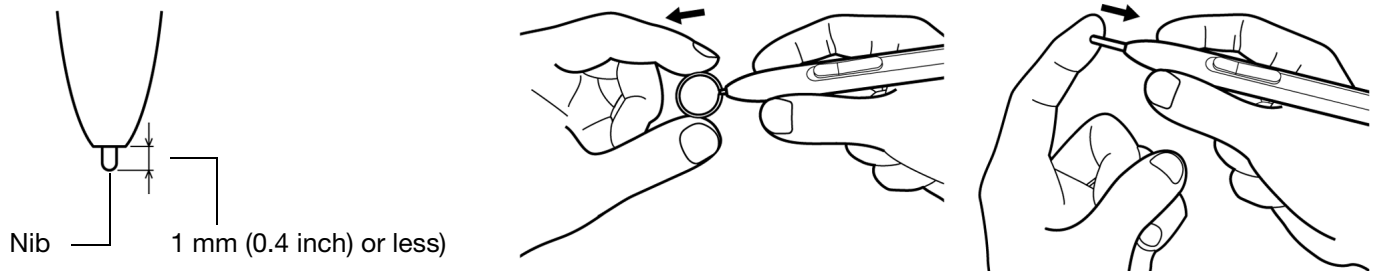

2. Slide the end of the new nib straight into the barrel of the pen. Firmly push the nib until it stops.

Warning: Choking hazard. Prevent children from swallowing the pen nib or button part. The pen nib or button part may accidentally be pulled out if children are biting on them.

To order replacement parts, see [ordering parts and accessories](#).

Important: When the pen is not in use, place it in the pen holder or lay it flat on your desk. The eraser end of the pen should be inserted first into the loop. To maintain the sensitivity of your pen, do not store the pen in a container where it will rest on the tip or eraser (when equipped).



UNINSTALLING THE SOFTWARE

Follow the appropriate procedure below to remove the tablet driver software from your system.

Important: When you remove the tablet software from your system, your tablet will no longer operate with full tablet functionality but will continue to function as a mouse device.

Windows Vista: Click on the Windows START button and choose CONTROL PANEL. In the CONTROL PANEL window, click on UNINSTALL A PROGRAM. In the dialog box that appears, choose the BAMBOO option. Click UNINSTALL and follow the prompts to remove the tablet driver. (If prompted, enter your administrator login name and password.)

Windows XP or XP x64: Click START. In the start menu, select CONTROL PANEL. Then select ADD OR REMOVE PROGRAMS. In the ADD OR REMOVE PROGRAMS window, choose BAMBOO and click on the REMOVE button. Follow the prompts to remove the tablet driver.

Macintosh: From the GO menu, choose APPLICATIONS and open the BAMBOO folder. Double-click on the REMOVE BAMBOO icon and select the REMOVE TABLET SOFTWARE button. Enter your administrator login name and password. After the removal is completed, click OK.





PEN AND DIGITAL INK CAPABILITIES IN WINDOWS VISTA



Microsoft Windows Vista provides extensive support for pen* input. When using Bamboo with a computer running Windows Vista, your experience is enhanced by powerful note taking, handwriting recognition, fast navigation, and other digital inking options designed to give you quick, intuitive results with the pen.

- **Note taking.** Use the pen to jot notes and capture quick sketches in Microsoft Journal. Journal simulates a physical notebook, but with the advantages of digital note taking – you can choose from a variety of pen, marker, and highlighter tools, plus an eraser that is easily activated by the eraser (when equipped) of the pen. Journal also includes a powerful search engine that can even locate your handwritten content.
- **Handwriting recognition.** Because Windows Vista includes powerful handwriting recognition capabilities, you can use the pen to quickly enter handwritten information anywhere the computer accepts typed input. You can convert your handwritten content to typed text at any time.
- **Gestures.** Use your pen to make simple gestural movements on the tablet to trigger customizable actions for navigation, editing, and other functions. To customize your gestures, select the FLICKS tab in the PEN AND INPUT DEVICES control panel.
- **Digital Ink in Microsoft Office 2007.** Use the pen to full advantage with the enhanced digital mark-up and inking tools available in Microsoft Office 2007 applications running on Windows Vista. Found on the REVIEW tab within applicable applications, these tools provide a consistent set of inking options. For quick access, you can add specific inking tools to the Quick Access Toolbar located at the top of each application.

To make the most of the pen in Microsoft Windows Vista, be sure to study the documentation that came with your system, including the Windows Vista training tools and Tablet PC tutorial. You can access the Tablet PC Pen Training from the Vista START menu by choosing ALL PROGRAMS, TABLET PC, and TABLET PC PEN TRAINING.

Note: The following workarounds in the Wacom tablet driver improve drawing performance in Vista:

- The Vista Pen Flicks and ‘press-and-hold-to-right-click’ features are disabled in graphics applications using the Wintab API.
- There is no pressure sensitivity in Journal and other Vista Ink features when both the Flicks and ‘press-and-hold-to-right-click’ features are disabled in the Vista PEN AND INPUT DEVICES control panel.

* Pen features supported in all versions of Windows Vista except Vista Home Basic.





ABOUT THE WINDOWS VISTA TABLET PC INPUT PANEL



The Input Panel enables you to use handwriting or an on-screen keyboard to directly enter text. There are a number of ways to launch the Input Panel:

- Click on the Input Panel icon which appears when you move the screen cursor into a text entry area.
- Click on the Input Panel tab, located by default on the left edge of the display screen.
- Click on the Tablet PC Input Panel icon located on the Windows taskbar. If the icon is not visible, right-click on the taskbar, select TOOLBARS, and TABLET PC INPUT PANEL.

To customize the Input Panel:

1. First open the Input Panel and then click on TOOLS in the menu bar.
2. Select OPTIONS to open the Input Panel Options dialog box.
3. Customize the Input Panel settings for the way you like to work.

To learn more about using Bamboo in Microsoft Windows Vista and Office 2007, study the documentation that came with your system and Microsoft Office applications. Be sure to take advantage of the Windows Vista training tools, including the Tablet PC tutorial, available from Microsoft.

You can visit also the Wacom web site at www.wacom.com/vista for more information on working with the pen in Windows Vista.



PRODUCT SPECIFICATIONS

GENERAL SPECIFICATIONS

Aspect ratio	16 : 10
Coordinate resolution, pen	100 lpmm (2540 lpi)
Touch input resolution	4 lpmm (101.6 lpi)
Accuracy, pen	+/- 0.25 mm (0.01 in)
Accuracy, touch	+/- 2.0 mm (0.08 in)
Pen detection height	16 mm (0.63 in)
Reading height with pen, average	7 mm (0.28 in)
Report rate, pen	133 points per second, maximum
Report rate, touch	50 points per second, maximum
ExpressKeys stroke	0.25 mm (0.01 in), approximately, when equipped
Communication interface	USB
Connector	USB Type A
Cable length	1.5 m (4.9 ft)
Power requirements	DC 5V, 70 mA or less, from USB port
Operating temperature	5 to 40 degrees C (41 to 104 degrees F)
Storage temperature	-15 to +55 degrees C (5 to 131 degrees F)
Operating relative humidity	30% to 80% non-condensing
Storage relative humidity	30% to 85% non-condensing
Certifications and compliance	FCC Class B, Industry Canada Class B, CE, VCCI Class B, BSMI, C-Tick, MIC, GOST-R, The European Union RoHS Directive 2002/95/EC, Chinese RoHS

BAMBOO TOUCH TABLET (MODEL CTT-460)



Touch active area (W x D)	125.0 x 85.0 mm (4.92 x 3.35 in)
Physical size (W x D x H)	208.4 x 137.6 x 7.5 mm (8.21 x 5.42 x 0.30 in), approximately, excluding rubber feet
Weight	210 g (0.46 lb), approximately

BAMBOO TABLET (MODEL CTH-460)



Touch active area (W x D)	125.0 x 85.0 mm (4.92 x 3.35 in)
Pen active area (W x D)	147.2 x 92.0 mm (5.80 x 3.62 in)
Physical size (W x D x H)	248.2 x 176.1 x 8.5 mm (9.78 x 6.94 x 0.33 in), approximately, excluding pen holder and rubber feet
Weight	360 g (0.79 lb), approximately

PEN (MODEL LP-160E), FOR BAMBOO



Pen tip travel	1.0 mm (0.04 in) or less
Pressure levels	1024 levels
Eraser tip travel	1.0 mm (0.04 in) or less
Physical size (L x D)	154.0 x 11.8 mm (6.06 x 0.46 in)
Weight	15 g (0.53 oz), approximately
Pen tip type	Polyacetal (Part No. PSI-A057-01), black

BAMBOO FUN SMALL TABLET (MODEL CTH-461)



Touch active area (W x D)	125.0 x 85.0 mm (4.92 x 3.35 in)
Pen active area (W x D)	147.2 x 92.0 mm (5.80 x 3.62 in)
Physical size (W x D x H)	248.2 x 176.1 x 8.5 mm (9.78 x 6.94 x 0.33 in), approximately, excluding pen holder and rubber feet
Weight	420 g (0.92 lb), approximately, including cable

BAMBOO FUN MEDIUM TABLET (MODEL CTH-661)



Touch active area (W x D)	190.0 x 130.0 mm (7.48 x 5.12 in)
Pen active area (W x D)	216.48 x 137.0 mm (8.53 x 5.40 in)
Physical size (W x D x H)	336.8 x 223.0 x 8.5 mm (13.27 x 8.79 x 0.33 in), approximately, excluding pen holder and rubber feet
Weight	740 g (1.63 lb), approximately, including cable

PEN (MODEL LP-161E), FOR BAMBOO FUN



Pen tip travel	1.0 mm (0.04 in)
Pressure levels	1024 levels
Eraser tip travel	1.0 mm (0.04 in) or less
Physical size (L x D)	154.0 x 11.8 mm (6.06 x 0.46 in)
Weight	15 g (0.53 oz), approximately
Pen tip type	Polyacetal (Part No. PSI-A057), white



BAMBOO PEN TABLET (MODEL CTL-460)



Pen active area (W x D)	147.2 x 92.0 mm (5.80 x 3.62 in)
Physical size (W x D x H)	248.2 x 176.1 x 8.5 mm (9.78 x 6.94 x 0.33 in), approximately, excluding pen holder and rubber feet
Weight	360 g (0.79 lb), approximately

PEN (MODEL LP-160), FOR BAMBOO PEN



Pen tip travel	1.0 mm (0.04 in) or less
Pressure levels	512 levels
Physical size (L x D)	149.0 x 11.8 mm (5.87 x 0.46 in)
Weight	13 g (0.46 oz), approximately
Pen tip type	Polyacetal (Part No. PSI-A057-01), black





PRODUCT INFORMATION

To learn more about Bamboo and how to take full advantage of the many pen and [digital inking](#) features in Microsoft Windows Vista, visit the Wacom web site for your region:

USA, Canada, Central and South America	http://www.wacom.com/productinfo
Europe, Middle East and Africa	http://www.wacom.eu
Japan	http://tablet.wacom.co.jp
Asia Pacific (English)	http://www.wacom-asia.com
China (Simplified Chinese)	http://www.wacom.com.cn
Korea	http://www.wacomkorea.com
Taiwan	http://www.wacom.com.tw
Thailand	http://www.wacom-thai.com

ORDERING PARTS AND ACCESSORIES

To purchase parts and accessories, refer to the Wacom tablet Read Me file and see who to call for your region.

You can also do the following:

- To purchase parts and accessories in the USA or Canada, call 1.888.884.1870 (toll-free) or visit Wacom's web site at <http://www.WacomDirect.com> (USA only).
- To purchase parts and accessories in Europe, call +49 (0)180.500.03.75 or send an email to spareparts@wacom.eu. Or, visit the Wacom web site at <http://www.wacom-shop.net>. You can also contact your local dealer, distributor, or technical support using the appropriate number for your region.
- To purchase parts and accessories in Australia, Singapore, Taiwan and Korea, please visit: www.BuyWacom.com.au, www.BuyWacom.com.sg, www.BuyWacom.com.tw and www.BuyWacom.co.kr, respectively.
- To purchase parts and accessories in other countries, please contact your local dealer or distributor.

Please note that not all parts and accessories are available in all regions.





RADIO AND TELEVISION INTERFERENCE

The equipment described in this manual generates, uses, and can radiate radio-frequency energy. If it is not installed and used properly—that is, in strict accordance with Wacom instructions—it may cause interference with radio and television reception.

FCC NOTICE

This device complies with Part 15 of the FCC Rules. Operation is subject to the following two conditions: (1) this device may not cause harmful interference, and (2) this device must accept any interference received, including interference that may cause undesired operation.

This equipment has been tested and found to comply with the limits for a Class B digital device, pursuant to Part 15 of FCC Rules. These limits are designed to provide reasonable protection against harmful interference in a residential installation.

This equipment generates, uses and can radiate radio frequency energy and, if not installed and used in accordance with the instructions, may cause harmful interference to radio communications. However, there is no guarantee that interference will not occur in a particular installation.

You can determine whether the equipment is causing interference by disconnecting it from your computer. If the interference stops, it was probably caused by the equipment.

If the equipment does cause interference to radio or television reception, you may be able to correct the interference by using one or more of the following measures:

- Rotate the television or radio antenna until the interference stops.
- Move the equipment farther away from the television or radio.
- Plug the equipment and computer into an outlet that is on a different circuit from the television or radio.

If necessary, consult your Wacom dealer or an experienced radio/television technician for help.

Changes or modifications to this product not authorized by Wacom could void the FCC Certification and negate your authority to operate the product.

See also [Industry Canada \(Canada only\)](#) and [CE declaration](#).





INDUSTRY CANADA (CANADA ONLY)

Industry Canada, Class B

“This Class (B) digital apparatus complies with Canadian ICES-003”

“Cet appareil numérique de la classe (B) est conforme a la norme NMB-003 du Canada.”

CE DECLARATION

The Wacom Bamboo™ digitizing tablet, models CTT-460, CTH-460, CTH-461, CTH-661, and CTL-460, has been tested and found to comply with the following harmonized European Norms:

- EN55022 : 2006, Class B
- EN55024 : 1998+A1:2001+A2:2003

Based on the results of these tests, Wacom declares that the above mentioned device conforms to Directive 2004/108/EC and indicates this conformity by the CE-sign on each device.

The device must be installed and operated always in strict accordance with the instructions given in this handbook. Any changes or modifications to this product that were not specifically authorized will invalidate this declaration.





PRECAUTIONS

WARNINGS

Do not place or leave the tablet or pen (when equipped) within reach of children. If your product is used improperly there is a potential for accident or human injury. Prevent children from swallowing the pen nib or button part. The pen nib, button part, or other movable parts may accidentally be pulled out if children are biting on them. Small parts, such as the pen nib or nib refills, or pen button part can be removed and accidentally swallowed by children.

Do not use the tablet in a facility control system that requires extremely high reliability. It may cause other electronic devices to malfunction, or other devices may cause the tablet to malfunction.

Power off your tablet in locations where/when electronic devices are not allowed. Because the tablet may cause other electronic devices to malfunction in some locations where/when the use of electronic devices is not allowed, such as within an airplane, be sure to turn off the tablet by unplugging the USB connector of this product from your computer.

Do not disassemble the tablet or pen (when equipped). Do not disassemble or otherwise modify the tablet or pen. Such action may cause heat generation, ignition, electrical shock, or other damage, including human injury. Disassembly of the product will void your warranty.

Take note of damaged cabling. If you notice that your tablet cabling is torn or otherwise damaged, there is a potential for product malfunction, electrical shock, or fire. Stop using the product and contact your local distributor or the Wacom customer support center for your region.

Do not expose this product to water or other liquids. Take care to never spill liquids onto the tablet or pen (when equipped). Exposing this product to water or other liquids may cause product malfunction or electrical shock. If the product is exposed to water or other liquids, unplug the USB connector. If your product is equipped with a power cord, unplug the cord from the wall outlet. Power down your computer. Then disconnect any other cables that may remain between the tablet and your computer. Stop using the product and contact your local distributor or the Wacom customer support center for your region.

Do not insert foreign material into the USB plug end or any other opening of this product. If a metal object or foreign material is inserted into the USB plug or other opening of this product, it may cause the product to malfunction or burn out, or cause electrical shock.

See also [cautions](#).





CAUTIONS

Do not place or use this product on an unstable surface or workspace. Do not place this product on a shaky, inclined, or vibrating surface. It may drop or fall off, causing damage to the product or human injury.

When cleaning your tablet, power off the unit by unplugging the USB connector from between the tablet and your computer. Electrical shock may occur if you attempt to clean this product when it is connected to your computer.

Further precautions regarding your tablet:

- If equipped with a pen, do not apply heavy stress to the pen tip, eraser, or button part. It may shorten pen tip life or may cause the pen to malfunction.
- If equipped with a pen and a distorted or bent pen nib is used, the pen tool may operate improperly. Therefore, do not apply excessive force when using the pen.
- If equipped with a pen, using a pen nib other than one specifically designed by Wacom for your pen input tool may cause product malfunction.
- When using the pen holder and to avoid damaging the pen (if equipped), do not use excessive force when inserting or removing the pen from the holder. Also, do not store the pen within the pen holder in such a way that the pen tip, buttons, or eraser are continually depressed.
- Do not excessively rub, abrade, or apply liquid to the pen holder (if equipped). These actions may cause threading frays or discoloration of the pen holder.
- Do not place metal objects on this product when it is in use. Metal objects placed on the tablet during use may cause interference, improper operation, or product malfunction.

See also [warnings](#).





LICENSE AND WARRANTIES

(WORLDWIDE, EXCEPT FOR EUROPE, AFRICA AND MIDDLE EAST)

SOFTWARE LICENSE

This legal document is an agreement between you, the end-user, and Wacom Technology Corporation (Wacom).

1. **Grant of License.** The enclosed product includes computer programs embedded in firmware and accompanying diskette or CD-ROM (the "Software"). The Software is licensed, not sold, to you for use only with Wacom products upon the terms of this license, and Wacom reserves any rights not expressly granted to you. Wacom grants to you a non-exclusive right to use this copy of the Software in conjunction with a Wacom product at a single location.
2. **Ownership of Software.** Although you may own the product in which the Software is originally recorded, Wacom retains ownership of the Software itself. You acknowledge that the Software is Wacom's property, and contains valuable confidential, unpublished information developed or acquired by Wacom at great expense, including data processing algorithms, innovations and concepts. The Software is protected by copyright and other federal and state laws. You agree to use your reasonable best efforts to protect the Software from unauthorized reproduction, distribution, disclosure, use, or publication.
3. **Copy Restrictions.** Unauthorized copying of the Software is expressly forbidden.
4. **Use Restrictions.** You may not decompile, reverse assemble, disassemble or reverse engineer the Software.
5. **Termination.** This License is effective until terminated. This License will terminate automatically without notice from Wacom if you fail to comply with any provisions of the License.
6. **Miscellaneous.** This License is governed by the laws of the United States of America and the state of Washington except in Asia Pacific and by the laws of Japan for Asia Pacific.

LIMITED WARRANTY

Wacom warrants the product, to the original consumer purchaser, except for the Software, pen holder and consumable items such as the pen nibs, to be free from defects in materials and workmanship under normal use and service for a period of one (1) year, from the date of original retail purchase, as evidenced by a copy of the receipt and registration with Wacom within 30 days of purchase.

The Software is licensed "as is." Wacom makes no warranty with respect to its quality or performance. Wacom cannot guarantee you uninterrupted service or the correction of any errors.

Upon discovery of a defect in the product, except in the Software, within the Warranty Period, you should contact Wacom Technical Support via telephone, email, or fax to obtain an RMA (Return Merchandise Authorization) number and instructions for shipping the product to a service location designated by Wacom. You should send the product, shipping charges prepaid, to the designated service location, accompanied by the return authorization number, your name, address and telephone number, proof of purchase date, and a description of the defect. Wacom will pay for return shipping by United Parcel Service or by an equivalent service as chosen by Wacom.





Wacom's sole obligation and entire liability under this warranty shall be, at Wacom's option, either the repair or replacement of the defective product or parts thereof of which Wacom is notified during the Warranty Period; provided, however, that you are responsible for (i) the cost of transportation of the product to the designated service location and (ii) any loss or damage to the product resulting from such transportation.

Wacom shall have no responsibility to repair or replace the product if the failure of the product has resulted from accident, abuse, misuse, negligence, or unauthorized modification or repair, or if it has been handled or stored other than in accordance with Wacom's storage instructions.

Any descriptions, drawings, specifications, samples, models, bulletins, or similar material, used in connection with the sale of the product, shall not be construed as an express warranty that the product will conform or comply with your requirements.

EXCEPT FOR THE LIMITED WARRANTY DESCRIBED ABOVE, THERE ARE NO OTHER WARRANTIES MADE BY WACOM ON THIS PRODUCT. NO ORAL OR WRITTEN INFORMATION OR ADVICE GIVEN BY WACOM, ITS DEALERS, DISTRIBUTORS, AGENTS, OR EMPLOYEES SHALL CREATE A WARRANTY OR IN ANY WAY INCREASE THE SCOPE OF THIS WARRANTY, AND YOU MAY NOT RELY ON ANY SUCH INFORMATION OR ADVICE. THIS WARRANTY GIVES YOU SPECIFIC LEGAL RIGHTS, AND YOU MAY ALSO HAVE OTHER RIGHTS WHICH VARY FROM STATE TO STATE.

WACOM LIMITS THE DURATION OF ANY LEGALLY IMPLIED WARRANTIES INCLUDING IMPLIED WARRANTIES OF MERCHANTABILITY OR FITNESS FOR A PARTICULAR PURPOSE, TO THE DURATION OF WACOM'S EXPRESS WARRANTY. SOME STATES DO NOT ALLOW LIMITATIONS ON HOW LONG AN IMPLIED WARRANTY LASTS, SO THE ABOVE LIMITATION MAY NOT APPLY TO YOU.

NEITHER WACOM NOR ANYONE ELSE WHO HAS BEEN INVOLVED IN THE CREATION, PRODUCTION, OR DELIVERY OF THIS PRODUCT SHALL BE LIABLE FOR ANY DIRECT, CONSEQUENTIAL, OR INCIDENTAL DAMAGES (INCLUDING DAMAGES FOR LOSS OF BUSINESS PROFITS, BUSINESS INTERRUPTION, LOSS OF BUSINESS INFORMATION AND THE LIKE) ARISING OUT OF THE USE OF OR INABILITY TO USE SUCH PRODUCT, EVEN IF WACOM HAS BEEN ADVISED OF THE POSSIBILITY OF SUCH DAMAGES. SOME STATES DO NOT ALLOW THE EXCLUSION OR LIMITATION OF INCIDENTAL OR CONSEQUENTIAL DAMAGES, SO THE ABOVE LIMITATION OR EXCLUSION MAY NOT APPLY TO YOU.

In the event that any of the above limitations are held unenforceable, Wacom's liability for any damages to you or any party shall not exceed the purchase price you paid, regardless of the form of any claim.

This Limited Warranty is governed by the laws of the United States of America and the state of Washington.

This Limited Warranty is valid for and only applies to products purchased and used inside the United States (and its territories or possessions) and Canada.

WARRANTY SERVICE IN THE U.S.A. AND CANADA

To obtain Warranty service within the U.S. or Canada contact:

Wacom Customer Care Center

Phone: 1.360.896.9833

Email inquiry form: <http://www.wacom.com/productsupport/email.cfm>





WARRANTY ON SALES OUTSIDE OF THE U.S.A. AND CANADA

For products purchased or used outside of the United States and Canada, upon discovery of a defect in the product, except in the Software, within the Warranty Period you should contact your local dealer or distributor. In all other respects the terms of the warranty as set forth above apply to such sales.

Wacom Technical Support in Asia Pacific (except Japan and China)

Detailed Asia Pacific Limited Warranty policy and product registration may be found online at <http://www.wacom-asia.com>

To obtain technical support or Warranty service within Southeast Asia, Oceania and Taiwan, please contact the Wacom Customer Support Service.

Phone numbers can be found here: <http://www.wacom-asia.com/support/contact>

Should you have any questions about this Agreement, or if you desire to contact Wacom for any reason, please contact in writing:

IN NORTH AND SOUTH AMERICA CONTACT:

Wacom Technology Corporation
1311 S.E. Cardinal Court
Vancouver, Washington 98683
U.S.A.

IN ASIA PACIFIC CONTACT:

Wacom Co., Ltd.
Asia Pacific Office
Harmony Tower 18F, 1-32-2 Hon-Cho,
Nakano-Ku, Tokyo 164-0012
Japan

IN JAPAN CONTACT:

Wacom Co., Ltd.
2-510-1 Toyonodai
Otone-Machi, Kitasaitama-Gun
Saitama, 349-1148
Japan

IN MAINLAND CHINA (EXCEPT HONG KONG) CONTACT:

Wacom China Corporation
Unit 2807, 28th Floor, SK Tower
No 6 Jia, Jianguomenwai Avenue,
Beijing, 100022, China
E-mail: support@wacom.com.cn



LICENCE WARRANTY CONDITIONS

(EUROPE, AFRICA AND MIDDLE EAST)

SOFTWARE LICENCE AGREEMENT

Important customer information

The scope of delivery of this product covers copyright-protected computer programs ("software"), which are the inalienable intellectual property of WACOM Europe GmbH ("WACOM"). This software is an integral component of the product and is also held on the associated data carrier. The software of WACOM and the associated rights of use are not included with the purchase of this product from your retailer. WACOM grants you-the user-the right to use the software exclusively in accordance with the conditions stipulated in this licence agreement. By purchasing this product, you agree to the following licence conditions.

Conditions for using the software

WACOM issues the user with a personal, non-exclusive licence to use the software solely in connection with this product and for the correct operation of the product. This licence may only be assigned to a third party in connection with this product.

Use of this software includes the creation of permanent or temporary copies of the software by means of loading, displaying, exporting, transferring or saving, for the purposes of exporting the commands and the data they contain or for observing, researching or testing the software functions.

The customer may not license the software to a third party, lease, lend or in any other way provide access to the software. The customer may not copy, change, transfer or edit the software without prior written agreement from WACOM. The only exceptions to this are necessary procedures for creating a back-up copy and the scenarios outlined in section 2.

The customer may not carry out any "reverse engineering", decompile or depacketise the software, or try by any other means to discover the source code of the software. This restriction shall continue to apply after the termination of this agreement. If the software contains interfaces to other programs that are not supported by WACOM, WACOM shall provide the customer with the necessary information on request, as long as the customer can prove his right to use the software and agrees to bear the copying and postage costs.

WACOM AND ITS SUPPLIERS CANNOT OFFER ANY GUARANTEE FOR THE PERFORMANCE OF THE SOFTWARE OR FOR THE RESULTS PRODUCED THERE FROM. WACOM AND ITS SUPPLIERS OFFER NO GUARANTEES OR ASSURANCES (EITHER EXPRESSLY OR IMPLICITLY, INCLUDING THOSE THAT MAY BE DERIVED FROM A BUSINESS RELATIONSHIP OR FROM TRADE PRACTICE, OR FROM LEGAL PROVISIONS OR CUSTOMARY LAW) WITH REGARD TO THE MARKETABILITY, FREEDOM FROM DEFECTS OF TITLE OR USEFULNESS OF THE SOFTWARE.

WACOM AND ITS SUPPLIERS ACCEPT NO LIABILITY FOR DAMAGES, CLAIMS OR COSTS OF ANY KIND, NOR FOR CONSEQUENTIAL DAMAGES, SECONDARY, ACCIDENTAL, INDIRECT OR PENAL DAMAGES, PARTICULAR OR MISCELLANEOUS DAMAGES OR FOR DEMANDS OR INDEMNITY CLAIMS FOR REDUCED PROFITS OR LOSSES. THIS SHALL ALSO APPLY IN THE CASE OF A REPRESENTATIVE OF WACOM BEING PREVIOUSLY AWARE OF THE POSSIBILITY OF SUCH LOSSES, DAMAGES, CLAIMS OR COSTS, OR DEMANDS FROM THIRD PARTIES.





The existing limitations on liability shall not apply in the case of the assumption of explicit guarantees, or in case of fraudulent behaviour on the part of WACOM, nor for damages arising from wilful or grossly negligent behaviour on the part of WACOM, from damages leading to loss of life, personal injury or sickness or in the case of binding legal provisions. For slight negligence, WACOM and its suppliers shall only be liable in the event of a breach of essential contractual obligations. Liability when such an essential contractual obligation is breached is, however, limited to damages typical to this type of contract, which WACOM must have determined at the conclusion of the contract based on the known risks and circumstances at that time. Claims for reduced profits or expenses saved, indemnity claims from third parties or claims for any other direct or consequential damages still cannot be asserted in this case.

The laws of the Federal Republic of Germany shall apply to this agreement. However, the applicability of the United Nations Convention on Contracts for the International Sale of Goods is explicitly excluded. Krefeld is the sole place of jurisdiction for all claims arising from this contractual relationship and all disputes between the parties resulting from the formation, handling or termination of the contractual relationship, provided that the customer is a trader, a legal entity under public law or a special fund under public law.

The jurisdiction agreement shall also apply for customers who do not have a general place of jurisdiction in Germany. The jurisdiction agreement shall not apply if, due to legal provisions, a different sole place of jurisdiction must be established for the case. Furthermore, WACOM is authorised to file a lawsuit against the headquarters of the customer.

This licence constitutes the entire contractual agreement between the parties. It overrides all other verbal and written contracts and agreements and may only be altered by means of a written and signed contract. Should one of the provisions of these licence conditions be or become void, the validity of the other provisions shall not be affected, in full or in part. Should a provision be invalid, the legally permissible regulation most closely resembling the invalid regulation shall apply in its place.

LIMITED WARRANTY

WACOM guarantees to you, as the initial purchaser, that the product hardware, when used as intended, will remain free from material defects and processing errors for a warranty period of TWO (2) YEARS and Cintiq products shall be guaranteed for a warranty period of THREE (3) YEARS, commencing from the purchase date and provided that the product was unused at the time of purchase. Defects in wear parts (e.g. pen tips) resulting from normal wear and tear are exempt from the warranty. Furthermore, WACOM guarantees that the data carriers delivered with the product are free from material defects and processing errors for a period of SIX (6) MONTHS from the date of purchase.

If the product-excluding any software-is discovered to be faulty it must be returned immediately to the place of purchase in its original packaging within the warranty period together with your name, address and telephone number, a description of the problem and a copy of the original receipt. The customer shall be liable for any possible damage or loss of the product during transit for this purpose. Under the provisions of this warranty, WACOM only undertakes to repair or replace the faulty product or parts at its own discretion, in cases where defects are proven and the product is sent within the warranty period.

WACOM is not obligated to repair or replace the product if: (a) the damage to the product results from any accident, misuse, improper use, negligence or unauthorised alteration or repair; (b) the product was not handled or stored according to the instructions provided by WACOM; (c) the damage resulted from normal wear and tear; or d) the serial number affixed by WACOM has been removed or rendered unintelligible.

If, when a claim made under this warranty is checked, it emerges that it is outside the permitted time period or is not covered by the warranty or that the product is not faulty, the costs of any checks or repairs must be borne by the customer.





Any descriptions, drawings, specifications, samples, models, notifications or similar material provided in connection with the purchase of the product cannot be taken as an explicit guarantee that the product corresponds to or fulfils the customer's requirements.

If this product is faulty, the purchaser shall be entitled to assert legal claims against the vendor for liability due to defects. These legal rights against the vendor are not limited by the existing warranty. The warranty grants the customer many additional rights under the conditions stipulated in this text.

This limited warranty shall apply if the registered office of the vendor is in the EU or in Iceland, Norway, Jersey, Switzerland, Russia, Ukraine, Croatia, Serbia, Tunisia, Turkey, Syria, Lebanon, Jordan, Israel, Egypt, United Arab Emirates, Iran or South Africa.

The granting of this limited warranty is subject to the laws of the Federal Republic of Germany. However, the applicability of the United Nations Convention on Contracts for the International Sale of Goods is explicitly excluded. Krefeld is the sole place of jurisdiction for all claims arising from this contractual relationship and all disputes between the parties resulting from the formation, handling or termination of the contractual relationship, provided that the customer is a trader, a legal entity under public law or a special fund under public law.

The jurisdiction agreement shall also apply for customers who do not have a general place of jurisdiction in Germany. The jurisdiction agreement shall not apply if, due to legal provisions, a different sole place of jurisdiction must be established for the case. Furthermore, WACOM is authorised to file a lawsuit against the headquarters of the customer.

Should one of the provisions of these limited warranty conditions be or become void, the validity of the other provisions shall not be affected, in full or in part. Should a provision be invalid, the legally permissible regulation most closely resembling the invalid regulation shall apply in its place.

If you have any questions about this agreement, or would like to contact WACOM for another reason, please contact us by post at this address:

WACOM Europe GmbH
Europark Fichtenhain A9
47807 Krefeld
GERMANY





GLOSSARY

Active area. The navigation and drawing area of your Bamboo tablet where touch or pen input is detected. See [touch sensor](#).

Aspect. The ratio between the vertical and horizontal dimension of the tablet or display.

Click force. The amount of force you must apply to the tip of the pen for a click to occur.

Digital Ink. A broad category that typically describes handwritten content which has been created using pen-based input on a computer. This handwritten content takes the form of sketches, ink mark-up, or handwriting. The handwriting can optionally be converted to typewritten text or simply left alone for use in its original format. Depending on your system and application settings, the handwritten text you make with digital ink can be converted on-the-fly or at another time.

Double-click distance. The maximum distance (in screen pixels) that the screen cursor can move between clicks and still be accepted as a double-click. Increasing the double-click distance makes double-clicking easier, but may cause a delay in line strokes in some applications.

Eraser-aware application. A software application that has built-in support for the pen eraser. These applications take advantage of the eraser in different ways, depending on what makes sense for the application.

Expand. A motion used when [navigating with touch](#). Touch the tablet with two fingers spaced closely together. Then while still touching the tablet surface, move your fingers apart.

ExpressKeys. The customizable control keys located on your Bamboo tablet.

ExpressKeys, LEFT HANDED. A tablet setting where the ExpressKeys are oriented to the right of the tablet.

ExpressKeys, RIGHT HANDED. A tablet setting where the ExpressKeys are oriented to the left of the tablet.

Journal. A Microsoft Windows application that electronically simulates a physical journal pad, but with the advantages of digital note-taking. For example, you can create quick sketches and jot handwritten notes that can be converted to text and sent on to colleagues for digital mark-up. Journal includes a variety of pen, marker, and highlighter tools, plus an eraser that is easily activated by the eraser end (when equipped) of the pen. Additionally, your handwritten content is searchable within Journal.

Mapping. The relationship between the pen position on your Bamboo tablet and the cursor position on the monitor screen.

Modifier. Modifier keys include SHIFT, ALT, and CTRL for Windows, or SHIFT, CONTROL, COMMAND, and OPTION for Macintosh. You can customize your Bamboo tablet or pen buttons to simulate a modifier key.





Mouse acceleration. A setting that allows you to adjust the screen cursor acceleration when your pen is in mouse mode.

Mouse mode. A method for positioning the screen cursor. When you place the pen on your Bamboo tablet, you can move the screen cursor with a “pick up and slide” motion similar to using a traditional mouse. This is known as relative positioning. See also pen mode.

Mouse speed. A setting that allows you to adjust the speed at which your screen cursor moves when your pen is in mouse mode.

Nib. The replaceable pen tip.

Pan. A motion used when [navigating with touch](#). Touch the tablet surface with two fingers and move them in the same direction.

Pinch. A motion used when [navigating with touch](#). Touch the tablet with two fingers spaced slightly apart. Then while still touching the tablet surface, move or ‘pinch’ your fingers together.

Pen mode. A pen input method of positioning the screen cursor. Wherever you place the pen on your Bamboo tablet, the screen cursor will jump to the same corresponding point on the screen. This is known as absolute positioning, and is the default setting for the pen. Also, PEN MODE allows you to quickly position the screen cursor without having to first find it and then move it across the desktop. See also mouse mode.

Pixel. The smallest unit of measure on your monitor screen.

Pen input. A method of controlling a computer using the pen on your Bamboo tablet.

Pop-up Menu. A user-defined menu that displays a list of keystroke functions and other actions you can perform. You can customize the buttons of your pen to display this menu. Available for tablet models that are configured for both pen and touch input.

Pressure-sensitive. A quality of the pen tip and eraser (when equipped) that senses the amount of pressure being applied. This is used to create natural-looking pen, brush, and eraser strokes in applications that are pressure-sensitive.

Pressure-sensitive application. Any application that supports pressure-sensitive input.

Proximity. The height above the tablet [active area](#) where the pen is detected. See also [positioning](#).

Screen cursor. The pointer on the display screen. Screen cursors come in different shapes (such as an I-beam, arrow, or box), depending on which application you are running.

Swipe. A motion used when [navigating with touch](#). Touch the tablet surface with two fingers and move them in the same direction at a relatively high speed.





Tablet PC Input Panel (TIP). The Microsoft Windows Vista Tablet PC Input Panel enables you to use your pen to create handwritten notes or work with an on-screen keyboard. The Input Panel dynamically converts your handwriting to text. The information you create can then be inserted into other documents, spreadsheets, or illustrations. See also [pen and digital ink capabilities in Windows Vista](#).

Touch input. A method of interacting with a computer using only your fingertips on the Bamboo tablet.

Touch sensor. The navigation area of your Bamboo tablet where touch input is detected. The touch sensor resides within the active area, and does not accept pen input.

Tap. A motion used when [navigating with touch](#). Touch and lift a single finger from the tablet.

Track. A motion used when [navigating with touch](#). Touch and move a single finger across the tablet surface.

Twist. A motion used when [navigating with touch](#). Touch the tablet with two fingers spaced slightly apart and move (rotate) them in a circular fashion, or move them in opposing directions. Alternatively, hold one finger stationary and track your other finger around the stationary finger.

USB. Universal Serial Bus. A hardware interface standard for connecting computer peripheral devices. USB ports support hot-plugging, which allows you to connect or disconnect a USB device without turning off your computer.

Wintab. An interface standard used by Windows applications for receiving tablet information. Bamboo supports all Wintab-compatible applications under Windows.





INDEX

About the manual	5	Pop-up Menu	49
Accessories and parts, ordering	73	tablet orientation	39
Active area, understanding	15	tip feel	42
Bamboo		touch	
caring for	66	functions	38
customizing	35	input	37
Expresskey basics	26	Digital inking capabilities	68
pen input	27	Disabling touch input	40
problems with	54	Double-click distance, customizing	42
product features	7	Double-clicking, how to	30
tablets matrix	7	Dragging, with pen	30
the pen experience	27	Drawing with pressure	32
the touch experience	18	Driver downloads, obtaining	64
touch input	18	Environmental conditions	66
troubleshooting	54	Eraser Feel, customizing	42
using	18	Erasing, with pen	33
Button functions	50	Ergonomics	12
Care, for Bamboo	66	ExpressKeys	
Cautions	77	basics	26
CE declaration	75	customizing	26
Click sound	30	setting functions	39
Clicking, with pen	30	using	26
Control panel		Eye-hand coordination exercise	34
basics	17	FCC notice	74
opening	35	Features	
overview	36	pen	11
Customizing		pen & touch models	9
Bamboo	35	pen holder	11
button functions	50	pen models	10
double-click distance	42	touch models	8
eraser feel	42	Functions, button	50
ExpressKeys	26	General problems, troubleshooting	57
functions	39	Holding the pen	27
pen	41	Industry Canada notice	75
acceleration in mouse mode	48	Information, product	73
buttons	43	Interference, radio and television	74
input	34	Macintosh-specific problems, troubleshooting	61
speed in mouse mode	48		





Manual		Pop-up Menu, customizing	49
about	5	Positioning, with pen	28
navigating	6	Precautions	76
Mapping		Pressure	
tablet	44	drawing with	32
to multiple monitors	17	writing with	32
Monitors, working with multiple	17	Problems, with Bamboo	54
Navigating the manual	6	Product	
Navigation, customizing for touch input	37	features	7
Nib, replacing	66	information	73
Ordering parts and accessories	73	specifications	70
Orientation		Proportions and scale	45
configuring for tablet	14	Radio and television interference	74
setting for tablet	39	Scale and proportions	45
Overview, control panel	36	Settings, control panel	36
Parts and accessories, ordering	73	Software	
Pen		driver downloads	64
buttons		uninstalling	67
customizing	43	Specifications	
using	31	Bamboo Fun medium tablet	71
clicking with	30	Bamboo Fun small tablet	71
customizing	41	Bamboo Pen tablet	72
double-clicking with	30	Bamboo tablet	70
dragging with	30	Bamboo Touch tablet	70
drawing with pressure	32	general	70
erasing with	33	Pen, for Bamboo	71
features	11	Pen, for Bamboo Fun	71
holding	27	Pen, for Bamboo Pen	72
input problems, troubleshooting	59	product	70
input, customizing	34	Tablet	
nib, replacing	66	configuring orientation	14
pointing with	28	ExpressKeys	26
positioning with	28	features matrix	7
speed, setting	48	mapping	44
testing	56	area	45
the experience	27	for portion of screen area	46
tip, replacing	66	for portion of tablet area	47
using	27	to multiple monitors	17
on tablet	28	orientation, setting	39
pen buttons	31	pen & touch model features	9
writing with pressure	32	pen model features	10
Pen holder	11	scale and proportions	45
Pointing, with pen	28	storing	66





testing	55	options	19
touch model features	8	setting navigation features	37
tracking	44	setting touch functions	38
Tablet PC Input Panel, about	69	speed, adjusting	37
Technical support options	63	the experience	18
Testing		Tracking, tablet	44
pen	56	Troubleshooting	54
tablet	55	general problems	57
Tip		Macintosh-specific problems	61
customizing feel	42	pen input problems	59
replacing	66	tables	57
Touch		touch input problems	58
adjusting touch speed	37	Windows-specific problems	60
basic actions	20	Uninstalling tablet software	67
customizing	25	Using Bamboo	18
disabling	40	Warnings	76
gestures	23	Windows-specific problems, troubleshooting	60
input problems, troubleshooting	58	Work area, setting up	12
input, customizing	37	Writing with pressure	32
navigating with	19		





WACOM INTERNATIONAL OFFICES

WACOM TECHNOLOGY CORPORATION

1311 S.E. Cardinal Court
Vancouver, WA 98683
U.S.A.

Telephone: +1.360.896.9833

Fax: +1.360.896.9724

WACOM EUROPE GMBH

Europark Fichtenhain A9
47807 Krefeld
Germany

Telephone: +49.(0)2151.3614.0

Fax: +49.(0)2151.3614.111

WACOM CO., LTD.

Japan Marketing and Sales Division

Harmony Tower 21F, 1-32-2 Hon-Cho,
Nakano-Ku, Tokyo 164-0012

Japan

Internet: <http://tablet.wacom.co.jp>

WACOM CO., LTD.

Asia Pacific Marketing and Sales Division

Harmony Tower 18F, 1-32-2 Hon-Cho,
Nakano-Ku, Tokyo 164-0012

Japan

Telephone: +81.3.5309.1513

Fax: +81.3.5309.1514

WACOM CHINA CORPORATION

Unit 2807, 28th Floor, SK Tower
No 6 Jia, Jianguomenwai Avenue,
Beijing, 100022, China

Internet: <http://www.wacom.com.cn>

WACOM KOREA CO., LTD.

25th Floor DMC iaan Sangam 2nd Complex, 1653
Sangam-dong, Mapo-gu, Seoul, Korea, 121-270
Korea

Telephone: +82.2.557.3894

Fax: +82.2.557.3895

WACOM AUSTRALIA PTY. LTD.

Unit 8, Stage 1 Cumberland Green
2-8 South Street Rydalmere
NSW 2116 Australia

Telephone: +61.2.9422.6700

Fax: +61.2.9420.2272

WACOM SINGAPORE PTE. LTD.

3 Bishan Place,
CPF Bishan Building #06-08
Singapore 579838

Telephone: +65.6258.8640

Fax: +65.6258.8697

WACOM TAIWAN INFORMATION CO., LTD.

Suite 605, 6th floor, No. 205 Tun-Hwa North Road
Taipei, 105 Taiwan

Telephone: +886.2.2712.2675

Fax: +886.2.2712.9789



Free Manuals Download Website

<http://myh66.com>

<http://usermanuals.us>

<http://www.somanuals.com>

<http://www.4manuals.cc>

<http://www.manual-lib.com>

<http://www.404manual.com>

<http://www.luxmanual.com>

<http://aubethermostatmanual.com>

Golf course search by state

<http://golfingnear.com>

Email search by domain

<http://emailbydomain.com>

Auto manuals search

<http://auto.somanuals.com>

TV manuals search

<http://tv.somanuals.com>