



Cintiq[®] 13HD

interactive pen display



User's manual

[Cintiq 13HD \(DTK-1300\)](#)

[Your Cintiq: Parts and Accessories](#)

[Installation](#)

[Calibrating the Cintiq](#)

[Customizing your Cintiq](#)

[Pen features](#)

[Working with Display Toggle](#)

[Using the ExpressKeys, Rocker Ring and Home Button](#)

[Working with multiple monitors](#)

[Troubleshooting](#)

[Technical support options](#)

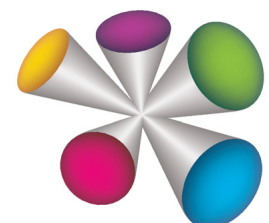



Cintiq 13HD

User's Manual

Version 1.0, Rev C0413

Copyright © Wacom Co., Ltd., 2013

All rights reserved. No part of this manual may be reproduced except for your express personal use.

Wacom reserves the right to revise this publication without obligation to provide notification of such changes.

Wacom does its best to provide current and accurate information in this manual. However, Wacom reserves the right to change any specifications and product configurations at its discretion, without prior notice and without obligation to include such changes in this manual.

The above year indicates when this manual was prepared. However, the date of release to the users of the "manual" is simultaneous with the introduction into the market of the applicable Wacom product.

Cintiq and Wacom are registered trademarks of Wacom Co., Ltd.

Adobe and Photoshop are either registered trademarks or trademarks of Adobe Systems Incorporated in the United States and/or other countries. Microsoft and Windows are either registered trademarks or trademarks of Microsoft Corporation in the United States and/or other countries. Apple, the Apple logo, and Mac are trademarks of Apple, Inc., registered in the U.S. and other countries.

Any additional company and product names mentioned in this documentation may be trademarked and/or registered as trademarks. Mention of third-party products is for informational purposes only and constitutes neither an endorsement nor a recommendation. Wacom assumes no responsibility with regard to the performance or use of these products.

ExpressKey is a registered trademark of Ginsan Industries, Inc., and is used with permission.

Front cover image courtesy of www.daniellieske.com





CONTENTS

CONTENTS	3	Adjusting tip feel and double-click	35
About the manual	5	Adjusting eraser feel	36
YOUR CINTIQ: PARTS AND ACCESSORIES	6	Advanced tip and eraser pressure settings	36
Cintiq location	7	Customizing pen buttons	37
Adjusting the display incline	7	Customizing tilt sensitivity	38
GETTING TO KNOW YOUR CINTIQ	8	Customizing the ExpressKeys	39
SETTING UP YOUR CINTIQ	9	Customizing the Rocker Ring and Home Button	40
System requirements	9	Button functions	41
INSTALLATION	10	Using and customizing the Radial Menu	48
Step 1: Hardware installation	10	Working with Display Toggle	49
Step 2: Software installation	13	Application-specific settings	50
CINTIQ FEATURES	14	Creating an application-specific setting	51
Rocker RingFront view	15	Changing application-specific settings	52
Rear view	15	Removing application-specific settings	52
Pen features	16	Working with multiple tools	52
WORKING WITH YOUR CINTIQ	17	Renaming the tablet in the tablet list	53
Setting up your work area	17	TROUBLESHOOTING	54
Configuring Cintiq for handedness	19	Testing Cintiq	55
Using the Grip Pen	19	Testing controls and input tools	56
Holding the pen	20	Testing the ExpressKeys, Rocker Ring and Home Button	57
Positioning	21	Testing a pen	57
Clicking	21	Troubleshooting	59
Dragging	22	General problems	59
Using the side switch	22	Pen tablet troubleshooting	61
Working with pressure sensitivity	22	Windows-specific problems	65
Drawing with tilt	23	Mac-specific problems	66
Erasing	23	Technical support options	68
Using the ExpressKeys, Rocker Ring and Home Button	24	Obtaining software updates	68
Working with multiple monitors	25	FREQUENTLY ASKED QUESTIONS	69
Adjusting the display	25	CARE AND MAINTENANCE	71
Factory presets, auto-sync, and user settings	25	Caring for Cintiq	71
Wacom Display settings	25	Replacing the pen nib	72
Power saving	27	OTHER USEFUL INFORMATION	73
CUSTOMIZING YOUR CINTIQ	28	Uninstalling Cintiq	74
Manage your control panel settings	29	Managing preferences	75
Viewing Settings and Express View	29	Installing multiple tablets	76
Control panel overview	30	Using applications integrated for tablet control	77
Customizing Cintiq functions	32	Importing expert settings	78
Calibrating the Cintiq	33	Pen and digital ink capabilities in Windows	79
Customizing the pen	34	Product information	80
		Product specifications	80







Warranty Service in the U.S.A. and Canada	81
Warranty Service Outside of the U.S.A. and Canada	81
Ordering parts and accessories	82
GLOSSARY	83
INDEX	85
Wacom international offices	87



ABOUT THE MANUAL

This manual provides quick access to information about your Cintiq. The information is common to Windows and Mac computers. Windows screen captures are shown unless otherwise noted.

- Go directly to [Contents](#) or [Index](#) topics by clicking on them.
- Use the navigation controls to move through the manual.

			Go to front page.
Contents	Go to table of contents.	 	Page back, or page forward.
Index	Go to index.		Go back to previous view.

- Use your .pdf viewer zoom-in tool to increase the size of the manual on your screen. See the viewer application help for information on any additional tools that help you use and print the manual.
- SMALL CAPITAL LETTERS are used to identify the names of keyboard keys, dialog boxes, and control panel options.
- Be sure to see also the Important Product Information (IPI) guide for Cintiq, located on the Installation CD. The guide includes product safety precautions, specifications, and your license agreement.
- The following information is not included with this product: information about your specific computer hardware or operating system, or information about your application software. Your best source for this information is the set of manuals and discs that came with your hardware, operating system, or application.

Wacom's philosophy is to continually improve all of its products. As a result, engineering changes and improvements are made from time to time. Therefore, some changes, modifications, and improvements may not be covered in this manual.



YOUR CINTIQ: PARTS AND ACCESSORIES

Your Cintiq 13HD interactive pen display can be used while lying flat on your desk or lap, or it can be placed in one of three different inclined positions to accommodate your work preferences.

The Cintiq and supplied accessories are shown below. Carefully unpack and place all items on a level, stable surface. Save the packing materials and package box for use when shipping or storing Cintiq.

- Remove any packing materials from the back of the Cintiq and the cabling.
- After unpacking, inventory the items and ensure the box contents are complete.

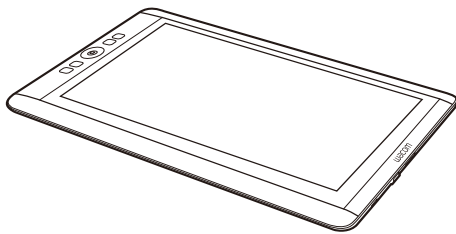

Cintiq13HD interactive pen display

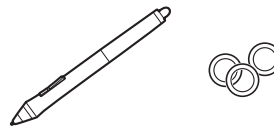

Pen, with personalization rings
To personalize, unscrew the tip cone and replace the ring with a preferred color.

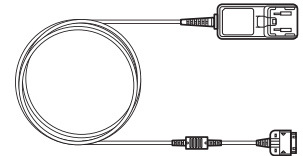

AC power adapter and cable

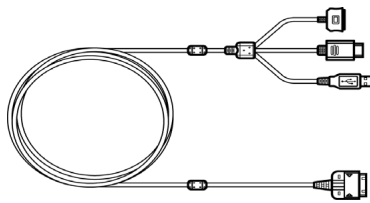

3-in-1 cable

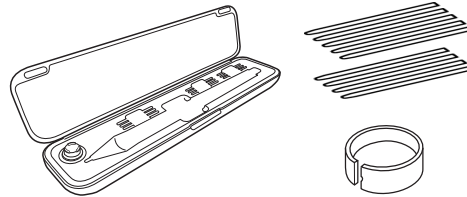

Pen case, replacement nibs and nib extraction tool

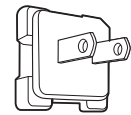

Plug for AC power adapter



Pen stand



Quick Start Guide
Warranty card included with some configurations.

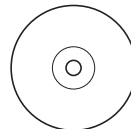

Installation CD
Includes the software driver and Important Product Information guide.



Cloth

Note: Some configurations may not include all shown items. Check the product listing.

Some configurations may include additional CDs or DVDs containing application software. To install, see the instructions for those CDs or DVDs.



CINTIQ LOCATION

Select a location on your desktop or other work surface that is level and stable. Make sure the surface is flat, clean, and dry.

Note: If you place the Cintiq face-down for any reason, use a soft, clean cloth or pad under the front of the display to make sure it will not be damaged through contact with another surface.

See the [Rocker Ring Front view](#) and [Rear view](#) of the Cintiq for locate its controls and features.

ADJUSTING THE DISPLAY INCLINE

You can adjust the Cintiq's height and incline to best meet your needs. You can use the Cintiq flat on the desk in front of you, or in one of three different inclined positions.

To set the display incline or viewing angle:

- Place the Cintiq on a desk, table, or other stable surface.
- Locate the stands for the three inclined positions and the slot for the stand on the back of your Cintiq.
- Decide which of the incline position you want to use. Refer to [Your Cintiq: Parts and Accessories](#), or the Quick Start Guide you received with your Cintiq, to see the inclined positions.
- Hold the Cintiq in front of you so you can see the back.
- Place the tab for the stand into the slot in the lower edge of the Cintiq.
- Pull out the stand for the desired incline using the side notches on the stand.
- Tilt the Cintiq toward the stand until you can insert the stand's tab into the slot. Make sure the tab is fully inserted into the slot.

Before installing, take some time to learn about your Cintiq. See [Getting to know your Cintiq](#).

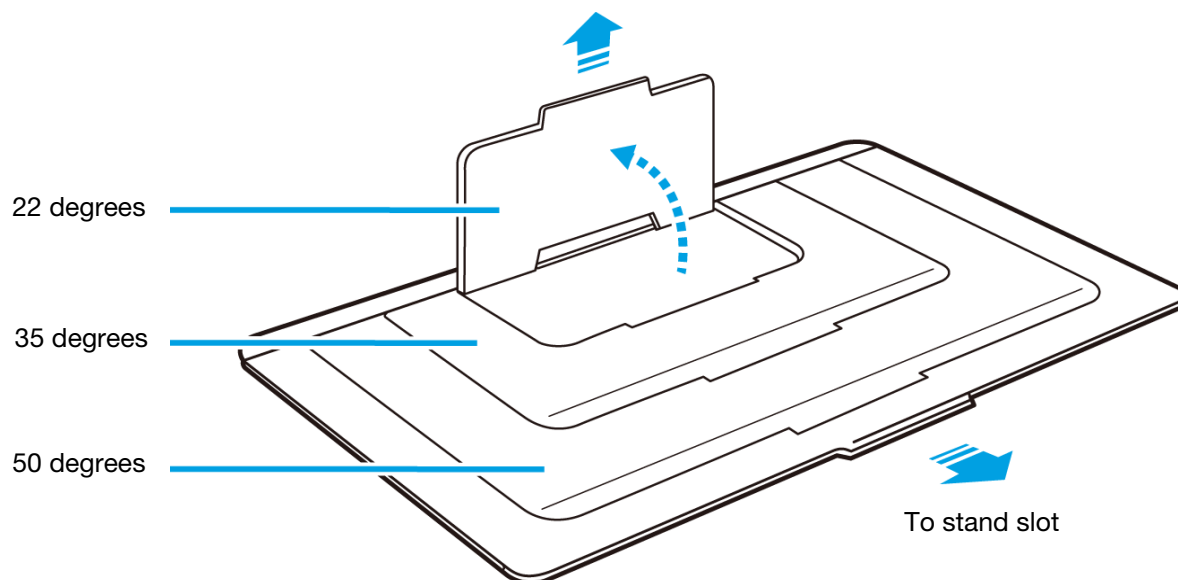



GETTING TO KNOW YOUR CINTIQ

The Cintiq 13HD combines the benefits of a Liquid Crystal Display (LCD) with the control, comfort, and productivity of Wacom's cordless, battery-free pen technology. This gives you a direct pen-on-screen interface for your computer.

The basic components of your Cintiq include a Wacom pen tablet internally mounted behind a high quality color display, and the Wacom Grip Pen, pen case and pen stand.

Your Cintiq can be used in either one of two landscape orientations, for either right-handed or left-handed use.

This manual describes how to set up and use your Cintiq. The Wacom Tablet control panel enables you to customize your pen and Cintiq settings. To learn more, see [Customizing your Cintiq](#).

Note: Not all product models are available in all regions.

[Cintiq features](#)

[Pen features](#)





SETTING UP YOUR CINTIQ

Your Cintiq 13HD functions as both a display and a pen tablet. Follow the instructions below to complete the hardware and software installation.

Important: You **MUST** install the Wacom driver software for correct pen-on-screen functionality.

[System requirements](#)

[Installation](#)

[Step 1: Hardware installation](#)

[Step 2: Software installation](#)

SYSTEM REQUIREMENTS

Make sure your computer meets the following minimum system requirements:

- **PC.** Windows 8 or Windows 7, 32 or 64-bit configurations. One available USB and interface port, and CD-ROM drive. HDMI port or other port to connect a display adapter. AC adapter (provided).
- **Mac.** OS X, v10.6 or later. Intel-based platforms only are supported. One available USB port and interface port, and CD-ROM drive. HDMI port or other port to connect a display adapter. AC adapter (provided).

A 3-in-1 cable and an AC adapter for connecting the Cintiq to your computer and to a power source is provided.

Note: If your computer does not have an HDMI port, you will need an HDMI adapter to connect your computer to the Cintiq.





INSTALLATION

STEP 1: HARDWARE INSTALLATION

In this step, connect the USB, interface, power, and adapter cables. Refer to the cabling diagram, or [Getting to know your Cintiq](#).

Important: Never connect or disconnect the video or power cables while your computer or Cintiq are powered on. This can damage the display or video card.

1. Turn off your computer.
2. Connect the interface and video plugs of the 3-in-1 cable to the available USB and HDMI ports on your computer. Note: Wacom recommends connecting the USB cable directly to your computer, and not to a USB hub attached to your computer.
3. Connect the adapter plug of the 3-in-1 cable to the power adapter.
4. Connect the remaining end of the 3-in-1 cable to the Cintiq.
5. Install the wall plug on the power adapter. Note that the plug can be reversed to accommodate different outlets.
6. Plug the power adapter into an AC outlet.
7. Turn on the Cintiq by pressing and holding the power button for 3-4 seconds.

When the Cintiq is receiving a video signal, the status LED on your pen tablet will glow white. When you touch the pen to the tablet surface, the white light will brighten. When the Cintiq is connected to your computer but no video signal is being received, the status LED will show a blinking white light.

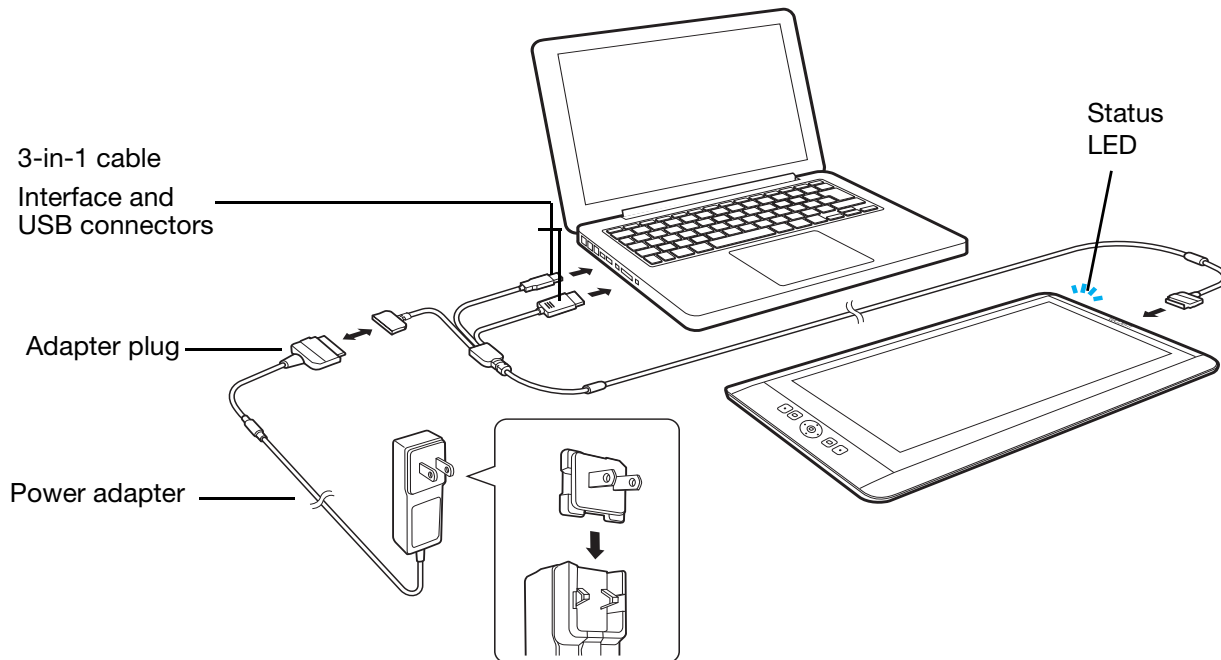

Cintiq connection diagram**⚠ Caution**

Only use a power adapter provided, or an identical adapter, for use with your Cintiq. Use of an improper power adapter may damage the Cintiq.

8. Turn on your computer. The Cintiq will install as a default monitor.
 9. As necessary, configure the display control panel settings for the proper size and color resolution. For best results, set Cintiq to the maximum (native) resolution of 1920x1080. See the Important Product Information (IPI) guide located on the Installation CD for details about resolution sizes that can be used with Cintiq. The display size and color resolution may be constrained by the capabilities of your video card.
 10. To fine-tune the Cintiq, see [adjusting the display](#).
- Windows: If you are using Cintiq as a secondary display, you may first need to enable Cintiq in your display properties control panel.

After the LCD monitor portion of the installation is working to your satisfaction, move on to [step 2: software installation](#).

Notes:

Each LCD panel is produced under very stringent quality standards. Production techniques cannot guarantee an absolutely perfect display. Wacom does not allow any pixel to be always white. A small number of subpixels are allowed to show a wrong color for some parts of the color spectrum. See the IPI guide for more information.





If an image has fine striping (such as screen stripes), it may appear to flicker or display a moiré pattern.

Do not apply excessive pressure on the screen surface, it may cause the appearance of a moiré or pooling pattern. If this occurs, use less pressure on the screen when working with the pen.

When a still image is displayed for a long period of time, an after-image may remain for a short time. To prevent this, use a screen saver or other power management feature.

To extend the life of the Cintiq backlight, set your computer's power management to turn off the display when not in use for extended periods of time.

Your eyes may feel more comfortable if you reduce the screen brightness when working with Cintiq for extended periods of time. This will also extend the life of the backlight and reduce the heat felt on the screen surface.

For troubleshooting tips, see [troubleshooting](#).





STEP 2: SOFTWARE INSTALLATION

Important: You **MUST** install the Wacom driver software for correct pen-on-screen functionality.

1. Save your work and close all open applications.
2. Temporarily disable any virus protection programs.
3. Insert the Installation CD into your computer's CD-ROM drive. If the software installer menu does not display, double-click on the INSTALL or STARTUP icon located on the CD. (When available, you can also download and install the latest software driver from the Wacom website for your region.)
4. Click INSTALL TABLET and follow the prompts to install the driver software.
5. Reactivate your virus protection program.
6. After completing the software installation, make sure you can use your pen on the Cintiq screen to move the screen cursor.

When you place the pen tip on the screen, the cursor should immediately jump to a corresponding position approximately beneath the pen tip. Lift the pen tip and place it on the screen surface in a different location. The screen cursor should again jump to the new position. This is known as absolute positioning, and enables you to position the screen cursor without having to drag your pen across the screen surface.

7. Check the Notes linked to the driver download page for updated information. Review the Important Product Information (IPI) located on the Installation CD for cautions and warnings. If you have trouble installing Cintiq, see [troubleshooting](#).
8. Next, precisely align the screen cursor with the pen tip position. See [calibrating the cintiq](#).

Notes:

User-specific preferences are supported. After logging on, each user can customize their personal settings in the Wacom Tablet control panel. Switching to another user (either by logging on or fast user switching methods) will load the settings for that user.

If the Cintiq does not respond properly or you lose cursor control, the Cintiq preferences may be corrupted. See [managing preferences](#) to delete the current preference settings and return the Cintiq to its factory default condition.

Driver installation automatically activates the pen input functions available within Microsoft Windows 8, Windows 7 (except for Windows 7 Starter and Home Basic). See [pen and digital ink capabilities in Windows](#).

To download a new software driver (when available) from the Internet, see [obtaining software updates](#).

To uninstall the software driver, see [uninstalling Cintiq](#).





CINTIQ FEATURES

After you have set up your Cintiq, take some time to familiarize yourself with the features and components. Although they will appear as separate devices to your operating system, the display and tablet sensor function as an integrated output and input device. The tablet sensor reports pen coordinates, pressure, tilt, switch, eraser, and other information.

Use the Wacom Tablet control panel to customize options for ExpressKeys, Rocker Ring, Home Button, pen settings, calibration, display toggle, and other features. See [Customizing your Cintiq](#).

To improve your workflow in graphics or other applications, Cintiq features ExpressKeys and a Rocker Ring. While using the pen with your dominant hand, you can use your other hand to operate the ExpressKeys and Rocker Ring, and Home Button. These customizable features can be used to perform frequently used functions or keystrokes, or to emulate button clicks or modifier keys. See [using the ExpressKeys](#).

A [Display Toggle](#) function enables you to toggle the screen cursor between Cintiq and your computer. For example: Cintiq can be used as a pen display where the cursor is positioned at the pen tip location, or toggled for use as a standard Wacom tablet where the cursor can be moved across the entire desktop or any display on your system.

- Many applications have built-in support for pen display features, such as pressure sensitivity, tilt, and rotation. Visit the Wacom website to learn about applications that support these features. See [product information](#).
- For information on how best to use pen display features within a specific application, see the instructions in that application's manuals.

[Manage your control panel settings](#)

[Control panel overview](#)

[Customizing the ExpressKeys](#)





ROCKER RINGFRONT VIEW

The features of your Cintiq are illustrated below and listed in the Pen Display Features box. See [Using the ExpressKeys, Rocker Ring and Home Button](#) for descriptions and a table of default ExpressKey functions.

Your Cintiq can be rotated for use in one of two landscape orientations, which allows you to use the Cintiq with the ExpressKeys on the right or left side. You can set the orientation of your Cintiq, depending on whether you are right-handed or left-handed. See [Configuring Cintiq for handedness](#).

When you are not using your pen, lay it flat on your desk, or place it in the pen storage case.

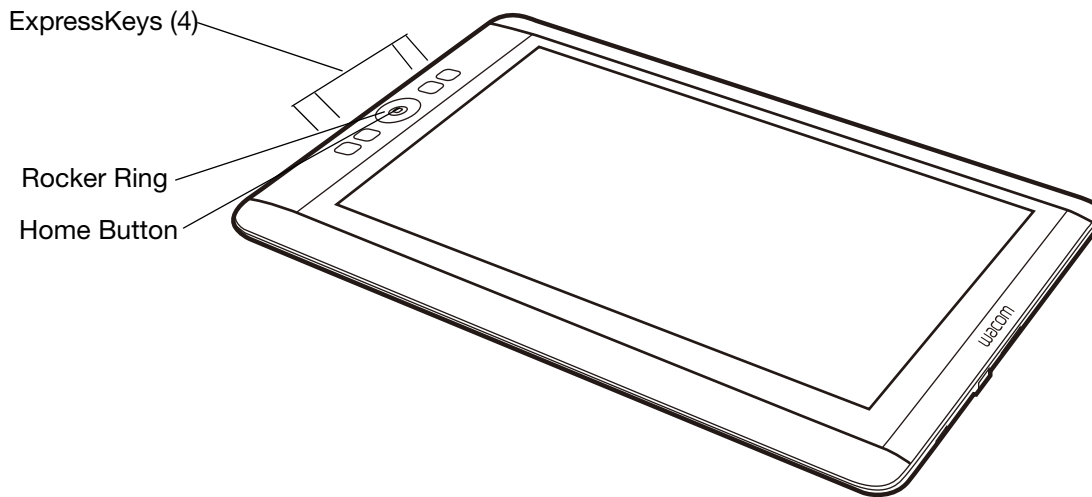

REAR VIEW

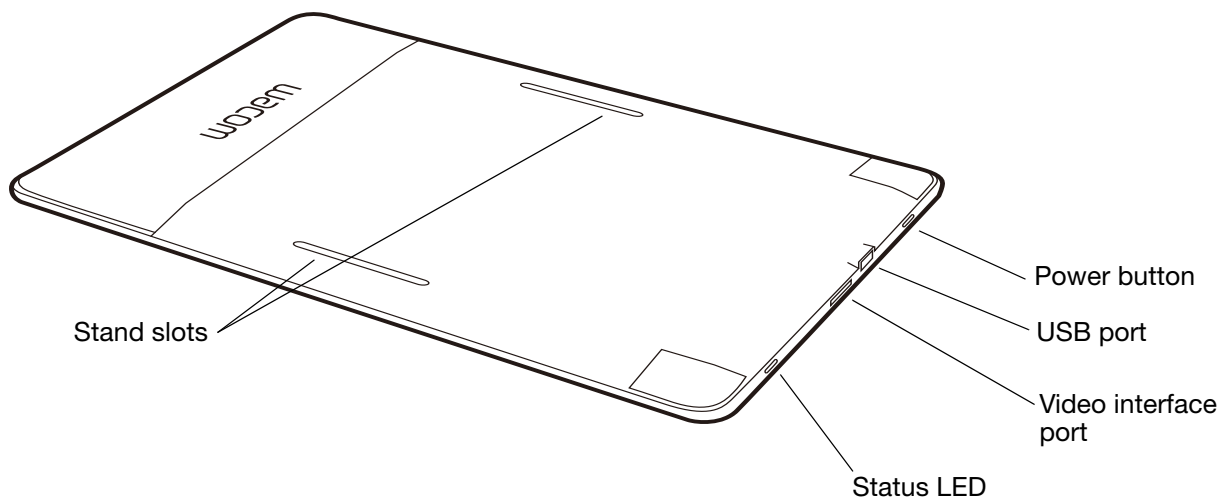



PEN FEATURES

Eraser: When brought within proximity of the Cintiq's screen, the tablet portion of the display reports the pen location. Pressure information is reported as you press down on the eraser. By default, the function is set to ERASE.

Side switch: Be sure the customizable side switch is in a convenient location where you can toggle it with your thumb or forefinger but not accidentally press it while using the pen.

You can use the switch whenever the pen tip is within proximity of the screen. You do not need to touch the pen tip to the display surface.

Toggle the switch in either direction to activate the button functions. By default, the upper switch is set to DOUBLE CLICK and the lower switch is set to RIGHT CLICK.

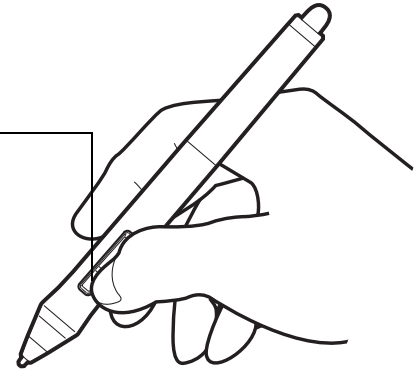

Pen tip (replaceable nib): The pen activates as soon as it is brought within proximity of the Cintiq's screen. This allows you to position the screen cursor without touching the pen tip to the screen.

When pressure is applied to the pen tip, the pen simulates a primary mouse button click. Tip click pressure can be adjusted in the Wacom Tablet control panel.

Tips:

- The pen enters proximity when the tip or eraser is brought within 5 mm (0.2 inch) of the Cintiq screen surface.
- To resume operations after the Cintiq has entered auto sleep mode, bring the pen tip within proximity or touch the pen tip on the Cintiq's screen.

Important:

- Use only the pen that came with your product, or a Wacom accessory pen specified for use with Cintiq. Other pens may not function properly. See [ordering parts and accessories](#). Also, the Cintiq pen tip is specifically designed for use with the Cintiq. The tips on other pens could damage the Cintiq screen.
- When not in use, place the pen in the pen case or pen stand, or lay it flat on your desk. To maintain the sensitivity of your pen, do not store it in a container where it will rest on the tip or eraser. Improper storage may damage pen tip pressure sensor(s).





WORKING WITH YOUR CINTIQ

The Cintiq 13HD is designed for a wide range of flexibility and an ergonomic work approach. The design allows you to quickly adjust Cintiq to a different height and position whenever the need arises. Experiment by [adjusting the display incline](#) to determine which best fits your particular working style and tasks.

As you work with Cintiq you can rest your hand lightly on the screen, just as if it were a drawing board or sheet of paper.

Because the Cintiq's surface will be a little higher than your desk, consider adjusting the height of your desk or chair to assure comfortable use of the device.

[Setting up your work area](#)

[Configuring Cintiq for handedness](#)

[Using the Grip Pen](#)

[Manage your control panel settings](#)

[Working with multiple monitors](#)

[Adjusting the display](#)

SETTING UP YOUR WORK AREA

To minimize fatigue, organize your work area to create a comfortable environment. Position Cintiq, the pen, and your keyboard for easy access without unnecessary reaching. The pen display and any other displays should be positioned so you can view them comfortably with a minimum of eyestrain.

- If you have not already done so, set up the Cintiq for your preferred handedness. See [Configuring Cintiq for handedness](#).
- If working with a keyboard, consider locating the keyboard slightly below the desk surface in an adjustable keyboard tray.
- Maintain a good posture at all times.





- Periodically shift your gaze from your computer and focus on other objects within the room. This will help to relax your eyes.
- Use a gentle grip when working with the pen. Take short breaks between tasks to stretch and relax your muscles.
- Alternate tasks throughout the day. Minimize awkward postures and repetitive movements.
- Change your position if you feel any discomfort.
- Study the rest of this chapter to learn more about working with Cintiq.
- Do not pull the cabling from their computer connections by accidentally moving the Cintiq too far from the computer.

Note regarding RSI: Wacom makes no representation, promise or guarantee that Wacom products will cure or prevent, in whole or in part, mouse-induced repetitive stress symptoms, injuries or conditions. Individual results may vary. Always obtain competent medical advice to determine the most appropriate treatment for your specific situation.





CONFIGURING CINTIQ FOR HANDEDNESS

Your Cintiq can be used in either one of two landscape orientations.

During the installation process, you were prompted to choose a default configuration for Cintiq based on whether you are right-handed or left-handed. The configuration you chose was used to determine the default settings for the ExpressKeys.

You can use the Wacom Tablet control panel to reconfigure Cintiq for left-handed or right-handed users at any time.

To reconfigure for left- or right-handed use:

1. Launch the Wacom Tablet control panel and click OPTIONS....
2. Choose the appropriate setting for your preferred handedness.
3. Click OK. The existing ExpressKey settings are swapped (or flipped) between left and right.

Note:

The handedness setting does not affect the default orientation of the Cintiq. To change the orientation of the Cintiq, modify the display settings for your operating system.

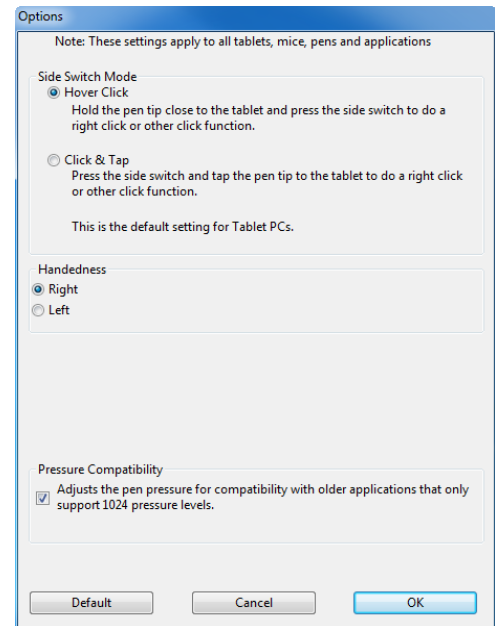

USING THE GRIP PEN

The cordless, battery-free pen senses the amount of pressure and tilt you apply to the tip. There are four basic techniques for using the pen: pointing, clicking, double-clicking, and dragging. If you are unfamiliar with using the pen, see the following pages.

[Holding the pen](#)

[Positioning](#)

[Clicking](#)

[Dragging](#)

[Using the side switch](#)

[Working with pressure sensitivity](#)

[Drawing with tilt](#)

[Erasing](#)





HOLDING THE PEN

Hold the pen like you would a normal pen or pencil. Adjust your grip so that the side switch is in a convenient location where you can toggle it with your thumb or forefinger. Be careful not to accidentally press the switch while drawing or positioning with the pen. Tilt the pen in any way that feels most comfortable. As you work with Cintiq you can rest your hand lightly on the screen.

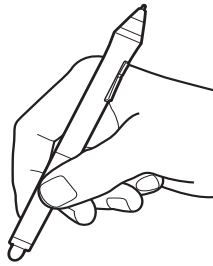
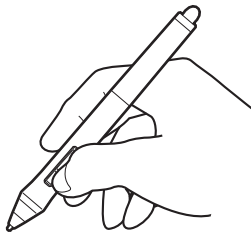

If you are working in a multi-user environment or otherwise want to personalize your pen, unscrew the tip cone and replace the colored ring with one of another color (included).

You can [customize](#) the pen settings at any time.

Place the pen within easy reach while you work. When not in use, place the pen in the pen case or pen stand, or lay it flat on your desk.

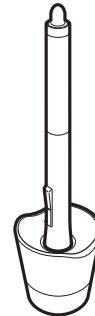
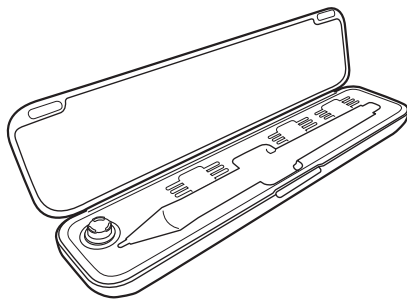

Important: To maintain the sensitivity of your input tools, do not store them in a container where they will rest on their tip or eraser. Improper storage may damage the pen tip pressure sensor(s).





POSITIONING

To position the screen cursor, move the pen slightly above the Cintiq screen without touching the screen surface. Press the pen tip on the screen to make a selection.

Note: [Calibrating the Cintiq](#) ensures correct alignment of the screen cursor with the pen tip. If the screen cursor does not jump to a position near the pen tip when you place the pen on the screen, then the Cintiq software driver may not be installed or is not loading. Install the driver software if necessary. Otherwise, see [troubleshooting](#).

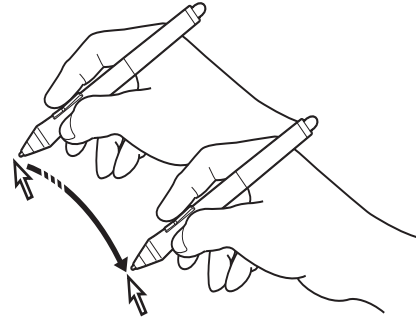

CLICKING

Tap the screen once with the pen tip, or touch the pen to the screen with enough pressure to register a click.

Tip: Configure Windows 7 to select when hovering the pen over an icon and to launch the icon with a single click. To turn on this feature, first open a folder. From the ORGANIZE pull-down menu choose FOLDER AND SEARCH OPTIONS. From the GENERAL tab select SINGLE-CLICK TO OPEN AN ITEM (POINT TO SELECT).

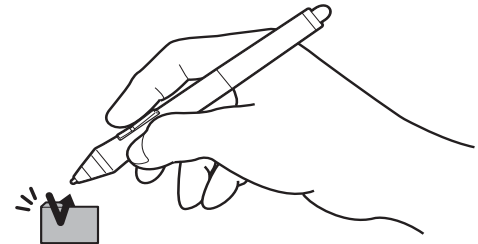

Press the upper side switch (when set to DOUBLE CLICK), or quickly tap the screen twice in the same place with the pen tip. Double-clicking is easier when using the pen perpendicular to the Cintiq's screen.

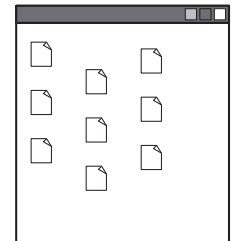
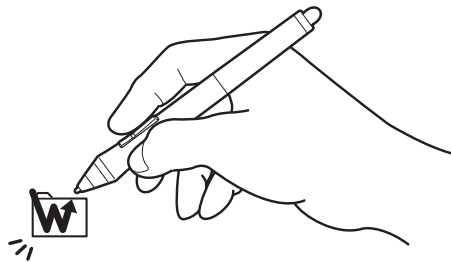



DRAGGING

Select an object, then slide the pen tip across the screen to move the object.

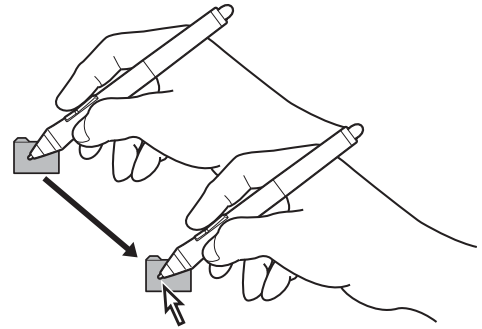

USING THE SIDE SWITCH

The pen comes equipped with a side switch. This switch has two customizable functions that can be selected by rocking the switch in either direction. You can use the side switch whenever the pen tip is within proximity (5 mm (0.2 inch)) of the screen surface. You do not need to touch the pen tip to the display surface in order to use the switch. By default, the upper switch is set to DOUBLE CLICK, and the lower switch is set to RIGHT CLICK. You can [customize](#) or disable the switch functions using the Wacom Tablet control panel.

WORKING WITH PRESSURE SENSITIVITY

The pen responds to the nuance and inflection of your hand movements, enabling you to create natural-looking pen and brush strokes within applications that support this feature.

To draw, ink, or write with pressure sensitivity, move the pen along the screen surface while applying various amounts of pressure downward on the tip of the pen. Press hard for thick lines or dense color. Press gently for thin lines or softer color. Some applications require that you first select a pressure-sensitive tool from the application tool palette.

To adjust tip feel, see [adjusting tip feel and double-click](#).

Visit the Wacom website to learn about applications that support pressure. See [product information](#).





DRAWING WITH TILT

The Cintiq recognizes when you tilt the pen from vertical to incline positions. Tilt can be used to control line shape and thickness in supporting applications.

Visit the Wacom website to learn about applications that support tilt. See [product information](#).

ERASING

In supporting applications the pen eraser works like the eraser on a pencil. In text applications, use the eraser to select text and then lift the eraser from the Cintiq screen to delete the text.

Visit the Wacom website to learn about applications that support the eraser. See [product information](#). If the eraser is not supported in an application, you can still use the eraser for positioning, drawing, or annotation.

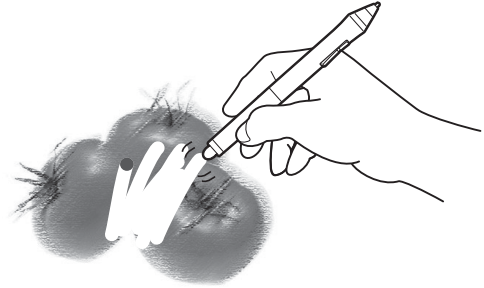



USING THE EXPRESSKEYS, ROCKER RING AND HOME BUTTON

You can use the ExpressKeys, Rocker Ring and Home Button to perform frequently used functions or keystrokes, or to modify your pen or other input tool properties as you work.

The four positions of the Rocker Ring (left, right, top and bottom) can be set and used just like ExpressKeys. The Home Button can also be programmed to perform a specific function.

Default settings for ExpressKeys, Rocker Ring and Home Button are shown below. Right-handed configuration is shown. For left-handed configuration, the ExpressKey settings are swapped (or flipped) from left to right.

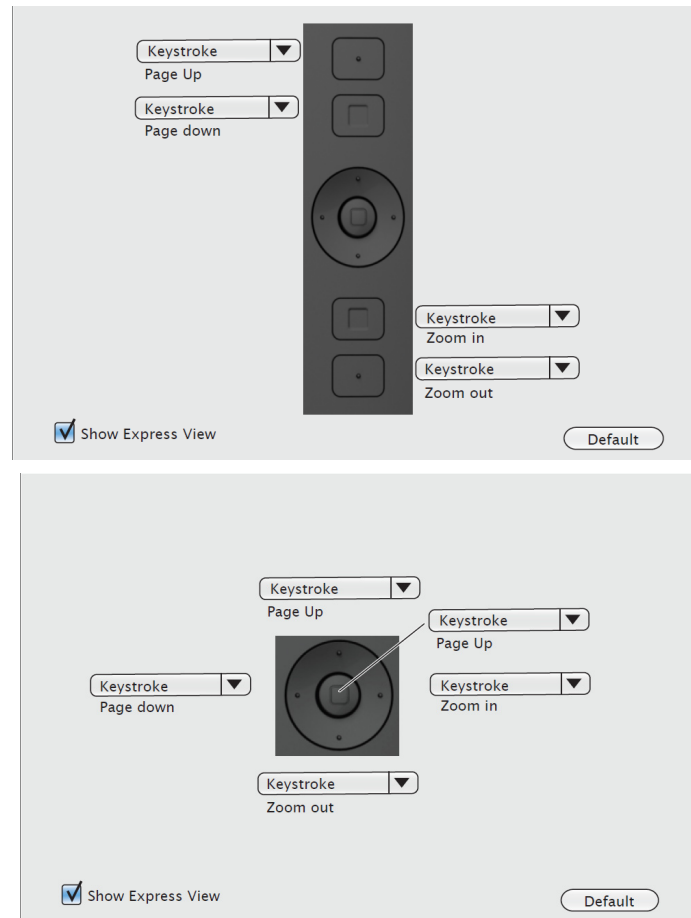

Consider some of these ways to use the ExpressKeys and Rocker Ring and Home Button:

- Set a key to a commonly used keyboard shortcut, file or application.
- If you cannot, or prefer not to, use the side switches on your Grip Pen, you can set a key to right-click or double-click.
- Choose from any of the other available [functions](#). See [customizing the ExpressKeys](#) for details.

Important: Some applications can override and control the ExpressKey or Rocker Ring functions. For details, see [using applications integrated for tablet control](#).





WORKING WITH MULTIPLE MONITORS

When working with Cintiq and additional monitors on the same system, the screen cursor movement on the standard monitors will depend on your system configuration.

If a second monitor is connected in mirror mode, both Cintiq and the other monitor will show identical images and screen cursor movement.

If you are using Cintiq with other monitors in extended monitor mode, you have several options for navigating on the other monitors:

Note: If you are using more than one monitor, your Cintiq 13HD will always be a second monitor or display.

- Set an ExpressKey, Rocker Ring or pen side switch to the DISPLAY TOGGLE function. You can then press the button to toggle the screen cursor between Cintiq and your other displays.

For example: Cintiq can be used as a pen display where the screen cursor is positioned at the pen tip location on the pen screen surface. [Display Toggle](#) enables you to use Cintiq as a standard Wacom tablet where the screen cursor can be moved across the entire desktop or additional displays.

- Set a pen side switch or an ExpressKey to MODE TOGGLE. You can then quickly switch between pen mode for working on Cintiq and mouse mode for working another monitors.

You can also purchase an Intuos5 tablet and use it to work on the other monitors in PEN mode. The pen will work on both Cintiq and the tablet.

ADJUSTING THE DISPLAY

Use the Cintiq controls to adjust a variety of display settings.

FACTORY PRESETS, AUTO-SYNC, AND USER SETTINGS

Factory presets: For optimal display quality, set your video card to a resolution of 1920x1080. This is the maximum (native) resolution that can be used with Cintiq. See the IPI for details.

Auto-sync: Cintiq automatically synchronizes to the incoming signal. The auto-sync function sets the horizontal and vertical screen position, as well as pitch and phase. Auto-sync will function between the supported horizontal and vertical frequency ranges. See the IPI for details.

Cintiq does not synchronize with the incoming signal. You can use the FACTORY RESET option to initiate display synchronization, and make other screen display adjustments using the Wacom Display Settings.

Color calibration: Changing the color, color temperature, contrast, brightness, or backlight from their default settings will override the color profile used with Cintiq.

WACOM DISPLAY SETTINGS

The Wacom Display Settings allow you to optimize a variety of Cintiq settings.

To access the settings:

- **PC:** From the Start Menu, click WACOM TABLET, then WACOM DISPLAY SETTINGS.
- **Mac:** Open Applications Folder, then click WACOM TABLET and then WACOM DISPLAY SETTINGS.



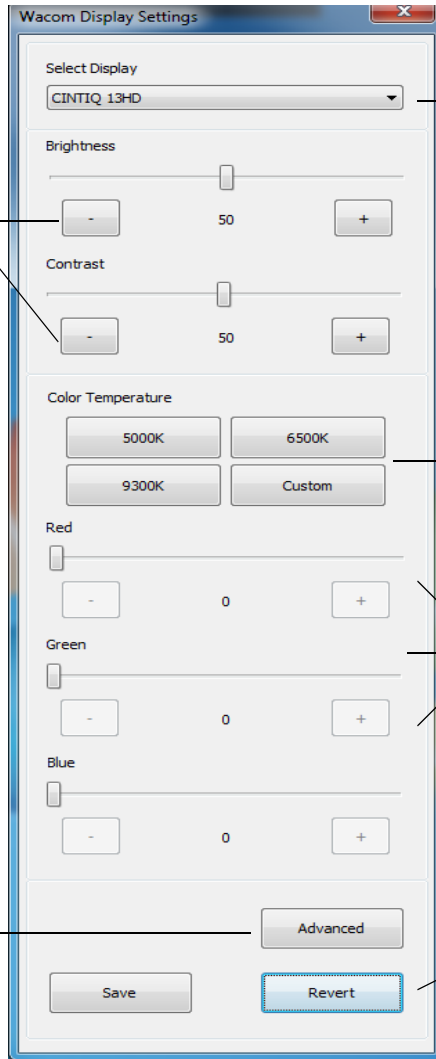

Allows you to choose a display if you are working with more than one Cintiq 13HD.

Adjusts pen display brightness and contrast.

Enables you to adjust the Cintiq color temperature, in degrees Kelvin. The default is 6500K.

Independently adjusts the red, blue, and green color values. Changes you manually make to the color settings will override the color profile settings.

Displays the Advanced dialog.

Resets Wacom Display Settings choices to their previous settings.

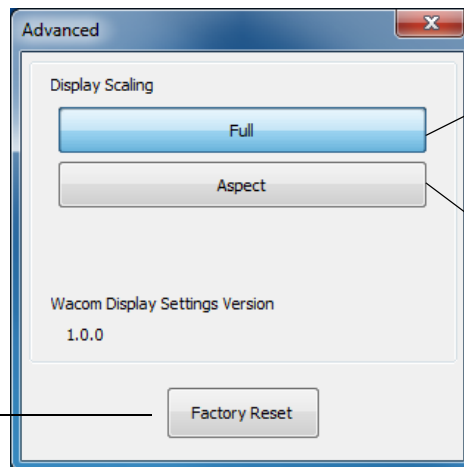

Resizes the image to fill the whole screen.

Resizes the image to fill as much of the screen as possible while maintaining the correct aspect ratio.

Returns the display parameters of the current mode to their factory default settings.



POWER SAVING

Cintiq conforms to VESA power saving guidelines.

When used with a Display Power Management Signaling (DPMS) compliant computer or video card, the display will automatically comply with the power saving parameters shown below.

COMPUTER MODE	VIDEO	Power consumption	STATUS LED
Power ON	Active	45W or less	White
Power save mode	Blanked	1W or less	Blinking white
OFF mode	Blanked	0.5W or less	Off

When power-saving functions are in effect, the screen display is darker than usual.





CUSTOMIZING YOUR CINTIQ

After mastering the basics of using your pen and Cintiq 13HD interactive Cintiq, you may want to customize the way Cintiq works. This chapter describes how to adjust your Cintiq and input tool settings.

Advanced users can learn how to further optimize Cintiq by creating [application-specific settings](#).

[Manage your control panel settings](#)

[Control panel overview](#)

[Calibrating the Cintiq](#)

[Customizing the pen](#)

[Customizing the ExpressKeys](#)

[Button functions](#)

[Using and customizing the Radial Menu](#)

[Working with Display Toggle](#)

[Application-specific settings](#)

[Working with multiple tools](#)





MANAGE YOUR CONTROL PANEL SETTINGS

Launch the Wacom Tablet control panel by using the pen on the Cintiq:

- **Windows.** Click on the Windows START button and choose ALL PROGRAMS. Then select WACOM TABLET and choose the WACOM TABLET PROPERTIES option.
- **Mac.** Open SYSTEM PREFERENCES from either the Start menu, the Apple menu, or from the APPLICATIONS folder. Then click on the WACOM TABLET icon.

You can begin customizing Cintiq after opening the control panel. See [control panel overview](#).

User-specific preferences are supported. After logging on, each user can customize their personal settings in the Wacom Tablet control panel. Switching to another user will load the settings for that user.

VIEWING SETTINGS AND EXPRESS VIEW

You can access an interactive diagram of the current Cintiq settings by assigning the Settings function to an ExpressKey or Rocker Ring position. When you click that key or position, you can click any item on the diagram to change the setting.

When you select the Show Express View checkbox on the ExpressKeys tab of the control panel, Express View allows you to see the setting for any individual ExpressKey or Rocker Ring position, or the Home Button. To see the setting, press and hold the item. You can turn off this feature by deselecting the checkbox. The Express View display closes approximately 1 second after you release the ExpressKey.

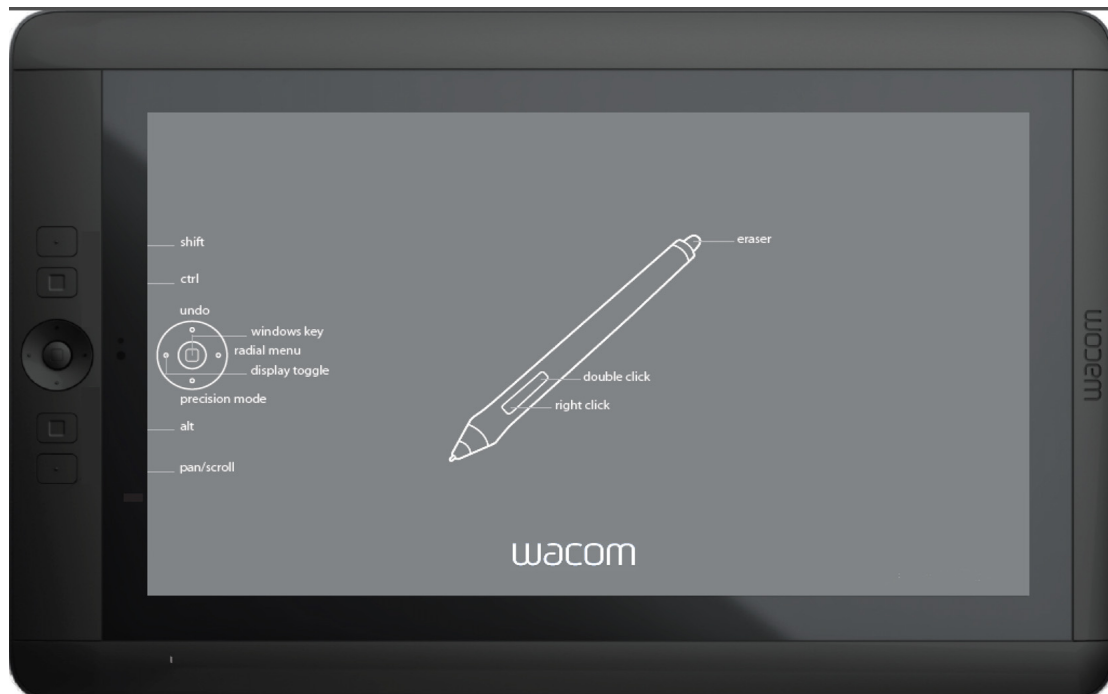



CONTROL PANEL OVERVIEW

Use the Wacom Tablet control panel to customize your Cintiq or Grip Pen. When you open the control panel, an icon for the Grip Pen or other input tool is displayed in the TOOL list. The appropriate tabs are displayed.

To open the Control Panel:

Windows 8: From the Windows 8 Start screen, click the WACOM TABLET PROPERTIES tile. If you are using the Windows 8 Classic Desktop, press the Windows key on your keyboard, or select the Windows icon in the Charms bar, to access the Start screen.

Windows 7:

Click on the Windows START button and choose ALL PROGRAMS. Then select WACOM TABLET and choose the WACOM TABLET PROPERTIES option.

Macintosh:

1. Open SYSTEM PREFERENCES from the Apple menu or from the APPLICATIONS folder.
2. Click on the WACOM TABLET icon.

Note: User-specific preferences are supported. After logging in, each user can customize their personal settings in the Wacom tablet control panel. Switching to another user will automatically load the settings for that user.





Icons represent your pen display (TABLET), TOOL, and APPLICATION settings.

Tabs display customizable settings for the selected TOOL.

Displays information dialog, and option to DIAGNOSE... your product.

Displays Advanced options

Choose FUNCTIONS to customize the ExpressKey and Radial Menu settings. Display Toggle options are available on multiple monitor systems.

Choose GRIP PEN to customize the pen settings. The icon is available after you have used a pen on the pen display.

Resets the selected tab to its default settings.

Downloads or displays this manual.

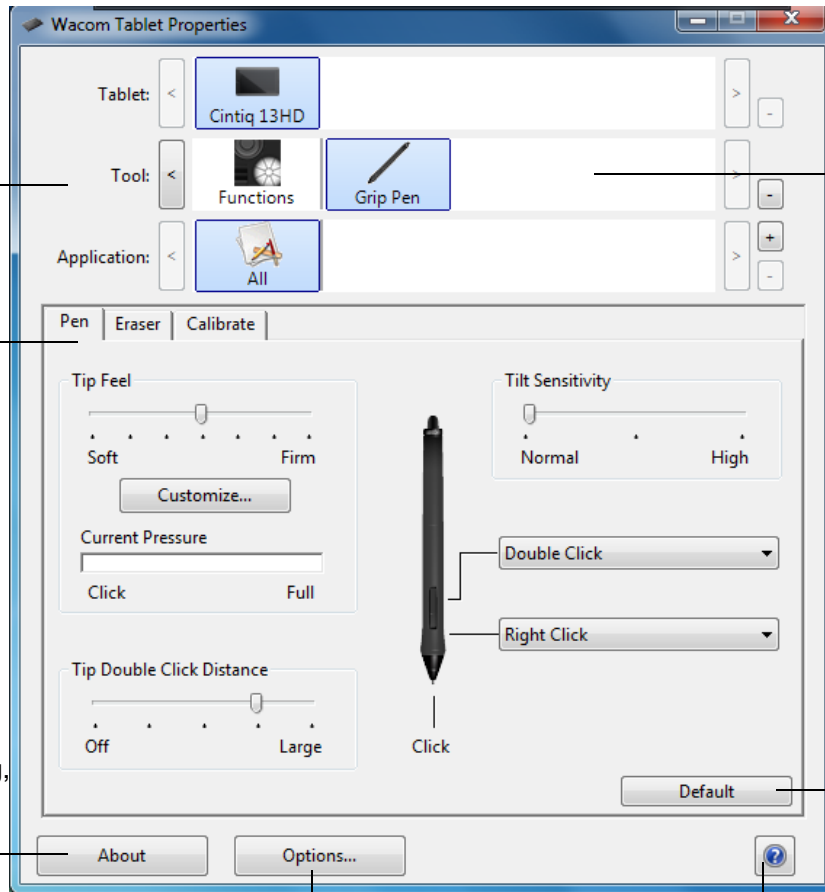

Tool Tips are available for most control panel items. Position the screen cursor over an item and let it rest there. The appropriate Tool Tip will pop up in a few moments.

Your keyboard tab and arrow keys can also be used to navigate the control panel.





Control panel lists and tabs: The control panel TABLET, TOOL, and APPLICATION lists allow you to select the display, tablet, tool, or application for which you want to change settings.

The TABLET list displays an icon for any supported pen display or tablet that has been installed on your system and is currently connected. All settings shown below the list apply to the selected pen display or tablet.

- The control panel will not launch unless a supported pen display or tablet is connected to the computer.
- Settings can only be viewed or changed for an attached pen display or tablet.
- A pen display or tablet cannot be deleted from the control panel list unless it is attached to the computer.

See also [installing multiple tablets](#) and .

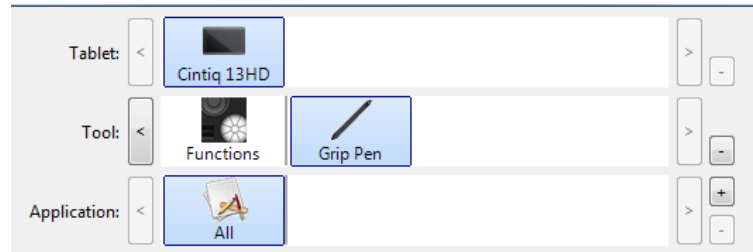

Current selections are highlighted.

The TOOL list displays icons for the Cintiq FUNCTIONS and for the different tools that have been used on the Cintiq.

To customize settings for a tool, click on its icon within the TOOL list. The appropriate tabs will be displayed. See [customizing the expresskeys](#) and [customizing the pen](#).

Note: The pen will be automatically added to the TOOL list when first used on the Cintiq, and functions using the default settings.

See also [working with multiple tools](#).

Use the APPLICATION list to define TOOL settings that apply only to a specific application. See [application-specific settings](#).

Note: The APPLICATION list is optional. It is not necessary to select or add applications in order to customize your Cintiq tool(s).

CUSTOMIZING CINTIQ FUNCTIONS

To customize the interactive Cintiq, [open](#) the Wacom Tablet control panel and select the FUNCTIONS icon in the TOOL list. Select a tab to customize, and change settings using the available options.

To customize, make changes to the tab controls. Experiment with different settings to find what works best for you. Any changes you make will take effect immediately. Click DEFAULT to return to the factory settings.





CALIBRATING THE CINTIQ

For optimum performance, you must calibrate the Cintiq to align the screen cursor with the position of the pen on the screen. This is required to compensate for viewing angle, and to adjust for [parallax](#). Set Cintiq in its working position, then follow the below procedure.

1. Open the Wacom Tablet control panel.
If more than one tablet or pen display is installed on your system, select the pen display you are working with from the TABLET list.
2. Select GRIP PEN from the TOOL list.
Then select the CALIBRATE tab.
3. If you are working with multiple monitors, select the MONITOR corresponding to your Cintiq. Only monitors that are set to one of the resolutions supported by Cintiq will appear in the list.
4. Click CALIBRATE... to activate the calibration screen.
5. Hold the pen and position yourself as you normally do when working with the Cintiq. Use the pen tip to click on the center of the crosshairs in the upper-left corner.
6. Then click on the center of the crosshairs that are displayed in the upper-right, lower left, and lower right corners.
7. Test the alignment by positioning the pen at a few different points on the display. Click OK to accept the calibration. Click TRY AGAIN to recalibrate.

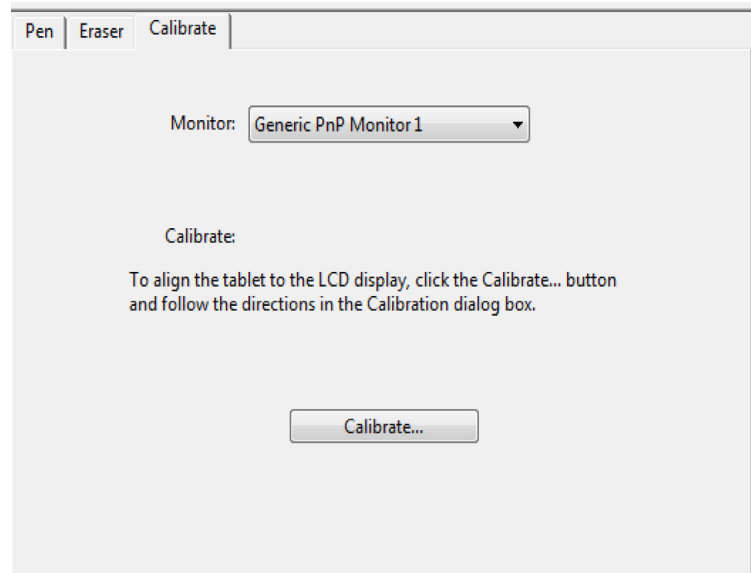

Tip: To see the screen cursor slightly offset from the actual position of the pen tip, calibrate by clicking on a spot showing that offset from the crosshairs. For example, to have the screen cursor appear 2.5 mm (1/10th of an inch) above and to the left of the pen tip, calibrate by clicking on a spot 2.5 mm (1/10th of an inch) below and to the right of the crosshairs.





CUSTOMIZING THE PEN

Use the pen when opening the Wacom Tablet control panel. The pen will be selected in the TOOL list and the appropriate tabs will be displayed. If not selected, choose the pen from the TOOL list. Select a tab and choose from the available options.

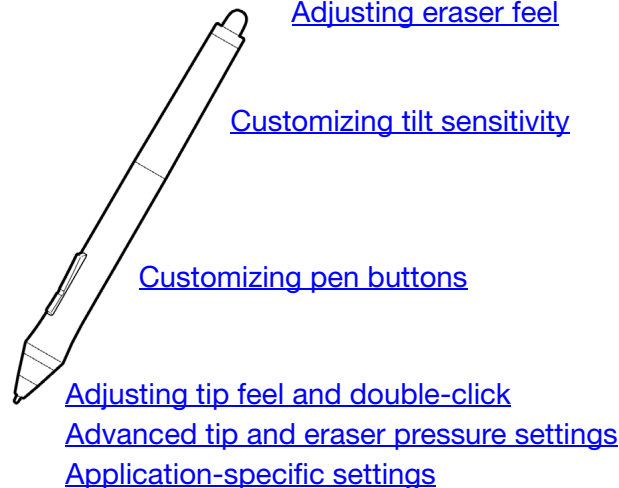

Wacom offers a number of optional pens, such as the Art Pen and Airbrush, that are compatible for use with Cintiq.

- The Art Pen features a pressure-sensitive tip and eraser, as well as sensitivity to tilt and rotation. Rotating the barrel in supporting applications creates a unique effect.
- The Airbrush is a true digital airbrush. It features a pressure-sensitive tip and eraser, tilt sensitivity, and a fingerwheel to control the application of digital paint.

These tools are fully supported in the Wacom driver software. They will appear in the TOOL list of the Wacom Tablet control panel after you touch the Cintiq's screen with the tip of the tool. The control panel will update to show the new tool and the options available for customization.

In supporting applications you can adjust the functionality of the Art Pen rotation or the Airbrush fingerwheel within the application. See the documentation that came with your application for details.

To learn more about these and other optional tools that can be used with Cintiq, visit the Wacom web site for your region. You can also learn about applications that currently support the advanced features of these tools, and find out how to order additional pens.





ADJUSTING TIP FEEL AND DOUBLE-CLICK

To adjust the tip sensitivity of your pen, select the PEN tab.

Customizes the amount of pressure needed to click, draw, or ink.

To create broad brush strokes or to click with a light touch, use a SOFT tip setting. For maximum control while drawing thin lines, use a FIRM tip setting.

Click to [further customize](#) the tip sensitivity.

With your screen cursor positioned over an empty area of the control panel, press down on the pen screen with your pen tip. Use the pressure bar to determine how hard you must press on the pen to reach maximum pressure.

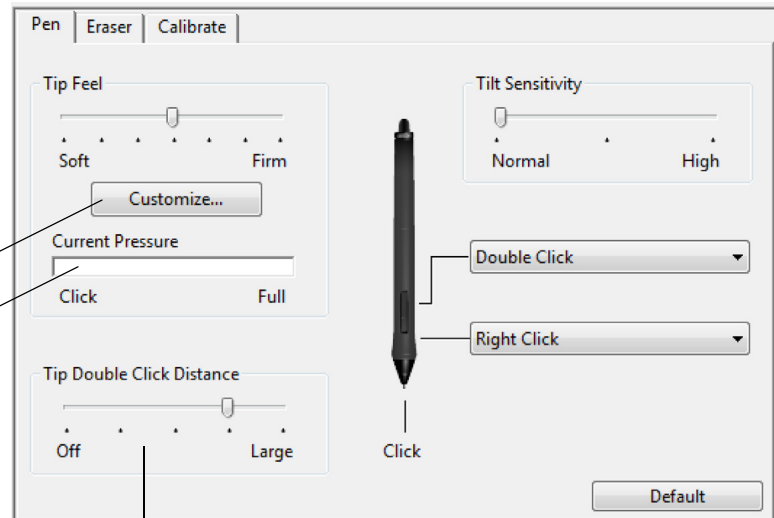

Adjusts the size of the double-click area. Drag slider to OFF if you do not want [double-click assist](#).

Tips:

- Use a soft TIP FEEL for a wider range of pressure values in most pressure-sensitive applications.
- In some applications a soft pressure setting can make the pen overreact so that slight pressure on the pen will be magnified on the screen. If you experience this, try a firmer TIP FEEL setting.
- To make double-clicking easier, expand the tap area that accepts a double-click (the double-click distance).
- A large double-click distance may cause a delay at the beginning of brush strokes in some drawing applications. This may also cause a delay at the beginning of a drag action or inking stroke. If you notice such effects, try setting a smaller double-click distance and using the side switch to double-click. You can also [set an ExpressKey to double-click](#).





ADJUSTING ERASER FEEL

To adjust the eraser sensitivity of your pen, select the ERASER tab.

Customizes the amount of pressure needed to erase.

Click to [further customize](#) the eraser sensitivity.

With your screen cursor positioned over an empty area of the control panel, press down on the Cintiq's screen with your pen eraser. Use the pressure bar to determine how hard you must press on the eraser to reach maximum pressure.

Select the [function](#) to perform when using the eraser.

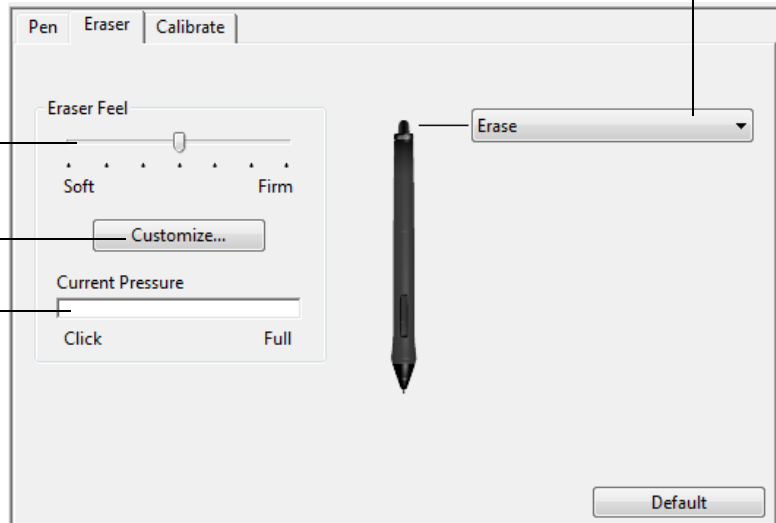

ADVANCED TIP AND ERASER PRESSURE SETTINGS

To further customize tip or eraser pressure settings, select the PEN or ERASER tab and click on the CUSTOMIZE... button. Options within the PEN FEEL DETAILS dialog box enable you to independently change the tip or eraser pressure sensitivity and click threshold settings.

Graphically displays the selected pressure sensitivity curve and click threshold settings.

Move the pressure controls to change the sensitivity curve.

- CLICK THRESHOLD determines the amount of force required to register pressure or generate a tip click.
- Use the SENSITIVITY control to change the slope of the pressure response curve.
- MAX PRESSURE determines how hard you must press the pen tip to reach maximum pressure.

A curve that increases quickly makes the pen feel more sensitive.

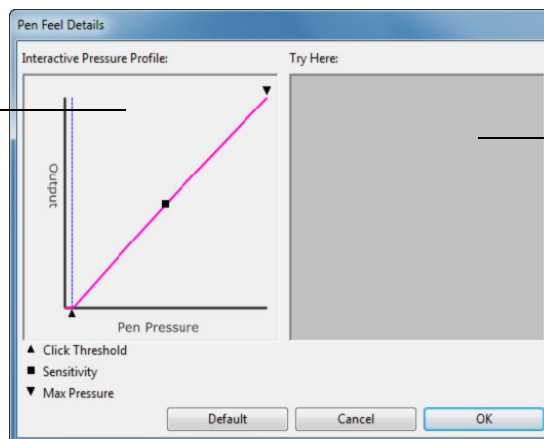

Using your pen tip or eraser, make several strokes within the box to test the results of your changes.

Important: In the PEN and ERASER tabs, these settings are adjusted simultaneously with the TIP FEEL or ERASER FEEL slider, which override the advanced pressure settings.





CUSTOMIZING PEN BUTTONS

Select the PEN tab to change the functions assigned to the side switches and tip of your pen.

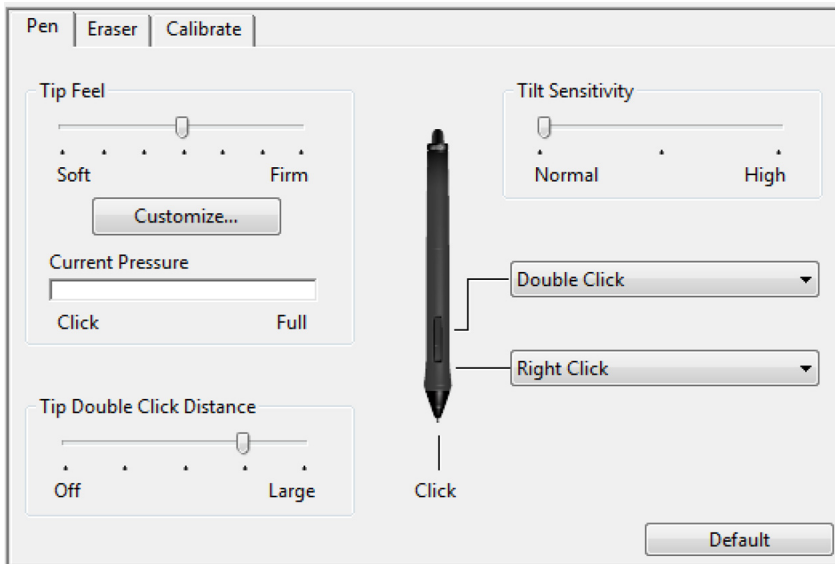

Drag to increase or decrease TILT SENSITIVITY. Test the new setting in an application that supports tilt.

The tilt setting applies to both the tip and eraser of your tool. Tilt is direction sensitive and can be used in some applications to control brush orientation or other characteristics.

When you bring the pen tip within 5 mm (0.20 inch) of the screen surface without touching the screen and press the upper or lower side switch, the selected function occurs.

Tip: To make double-clicking easier, set the side switch to double-click automatically by selecting DOUBLE CLICK.

Double-click here to change the function assigned to the pen tip. The tip must be set to CLICK in order to draw in most graphics applications.

You can change the SIDE SWITCH MODE to fit the way you like the pen to work when using click functions.

To access the SIDE SWITCH MODE settings, click on the OPTIONS... button at the bottom of the control panel. In the OPTIONS dialog box:

- Select HOVER CLICK to perform click functions without touching the pen tip to the Cintiq's screen surface.
- Select CLICK & TAP and press the side switch while touching the pen tip to the pen screen surface in order to perform a click function. CLICK & TAP enables the precise placement of your click functions, and is the default setting for Tablet PCs.
- Choose RIGHT or LEFT for right-handed or left-handed orientation.
- Check the Pressure Compatibility box as needed for use with older applications that support only 1024 pressure levels.

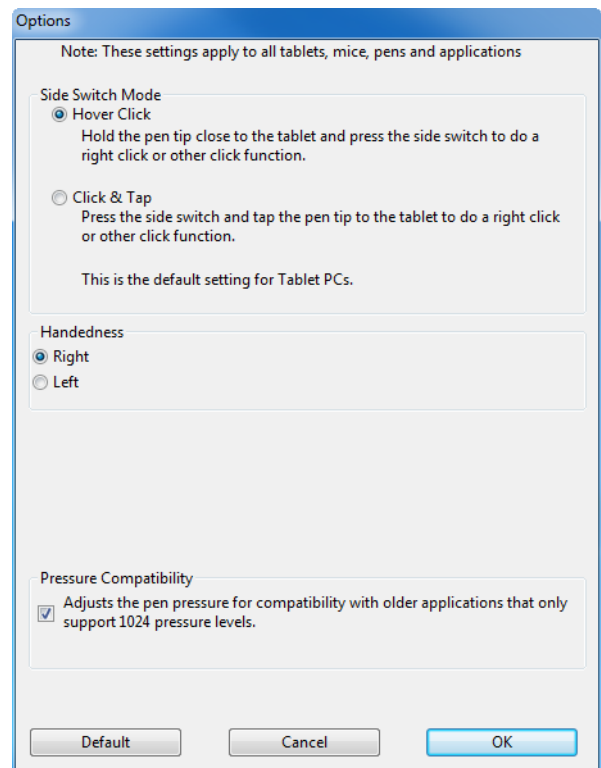



CUSTOMIZING TILT SENSITIVITY

To adjust the tilt sensitivity of your pen, select the PEN tab. Tilt sensitivity determines how far you have to tilt the tool to produce the maximum tilt effect. You need to tilt the pen less at high sensitivity than at low sensitivity.

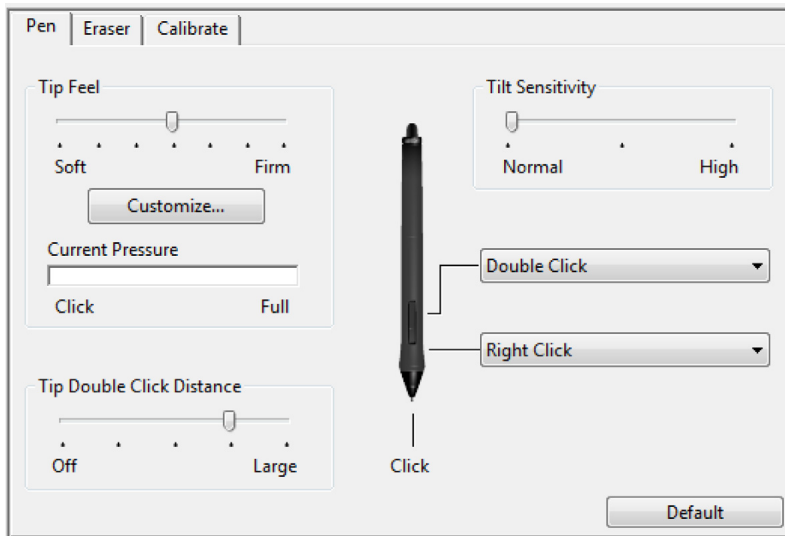

Drag to increase or decrease TILT SENSITIVITY. Test the new setting in an application that supports tilt.

The tilt setting applies to both the tip and eraser of your tool.

Tilt is direction sensitive and can be used in some applications to control brush orientation or other characteristics.

Visit the Wacom web site to learn about applications that currently support tilt.





CUSTOMIZING THE EXPRESSKEYS

To customize the ExpressKeys, select the EXPRESSKEYS tab. Each key can be customized to perform a Display Toggle, modifier, keystroke, or other function. The default ExpressKey settings are shown below.

Choose a [function](#) to perform when the key is pressed.

ExpressKey functions can be defined for use with [specific applications](#).

See [using the ExpressKeys](#) for more information.

Click Show Express View to toggle Express View on or off.

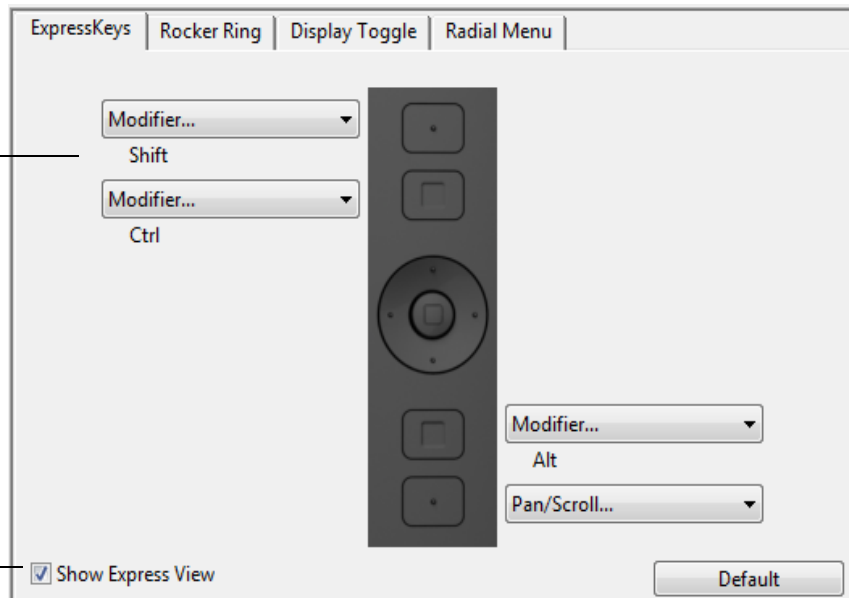

Important: Some applications can override and control the ExpressKey functions. For details, see [using applications integrated for tablet control](#).



CUSTOMIZING THE ROCKER RING AND HOME BUTTON

To customize the Rocker Ring or Home Button, select the **ROCKER RING** tab. Each position on the Rocker Ring, as well as the Home Button, can be customized to perform a Display Toggle, modifier, keystroke, or other function. The default settings for the Rocker Ring positions and Home Button are shown below.

Choose a [function](#) to perform when the Rocker Ring position or Home Button is pressed.

These functions can be defined for use with [specific applications](#).

See [Using the ExpressKeys, Rocker Ring and Home Button](#) for more information.

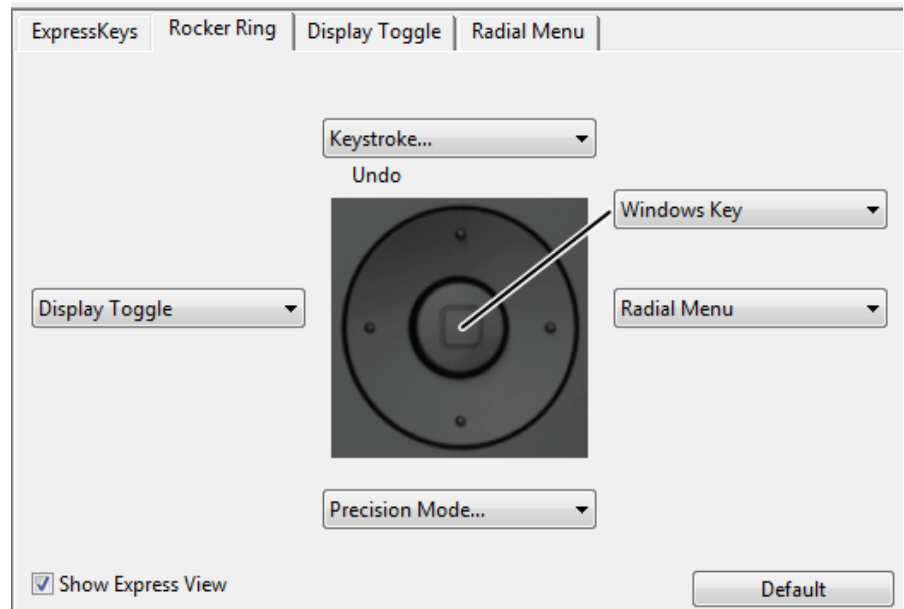



BUTTON FUNCTIONS

Customize Cintiq for the way you like to work. Simply use the Wacom Tablet control panel to change the button function that is assigned to a pen tool button, ExpressKey, or Radial Menu setting. Button function options may vary, depending on your Cintiq model. Not all options are available for all controls or Cintiq models.

FUNCTION NAME	DESCRIPTION
CLICKS	
• CLICK	Simulates a primary mouse button click. Be sure at least one button performs this function so you can always navigate and click.
• RIGHT CLICK	Simulates a right mouse button click, which displays a context menu.
• MIDDLE CLICK	Simulates a middle mouse button click.
• DOUBLE CLICK	Simulates a double-click. For easier double-clicking, use this function instead of tapping twice with the pen tip.
• CLICK LOCK	Simulates holding down the primary mouse button. Press the pen button once to initiate click lock. Press the button again to release click lock. Click lock is useful for dragging objects or selecting blocks of text.
• 4TH CLICK	Simulates a 4th mouse button click.
• 5TH CLICK	Simulates a 5th mouse button click.



FUNCTION NAME

DESCRIPTION

KEYSTROKE...

Enables you to simulate keystrokes. Select this option to display the DEFINE KEYSTROKE dialog box.

Enter a keystroke or keystroke combination in the KEYS entry box. Keystroke combinations can include letters, numbers, function keys (such as F3) and modifier keys (such as SHIFT, ALT, or CTRL for Windows, or SHIFT, OPTION, COMMAND, and CONTROL for Mac). You can also choose special keystrokes or keystroke combinations from the ADD SPECIAL drop-down menu.

After defining a keystroke or keystroke sequence, click OK.

Important: Because the ENTER (Windows) and RETURN (Mac) keys can be selected as a defined keystroke, they cannot be used to select OK. You must use your pen to click on the OK button.

Enter a name for the keystroke definition. The name will be displayed with the respective control or in the Radial Menu, as applicable.

You can create different keystroke functions for different applications. See [application-specific settings](#).

Deletes the last entry in the keystroke entry box.

Clears the entry box.

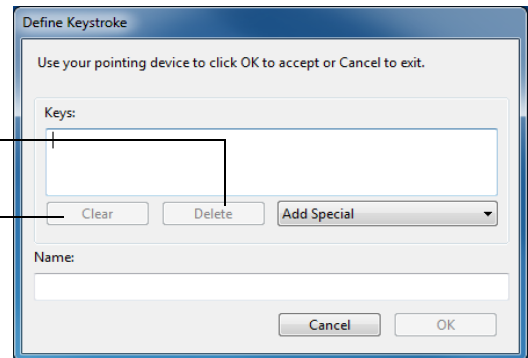

To learn which keystroke shortcuts are supported by a particular application, see the documentation that came with the application.

MODIFIER...

Enables you to simulate modifier key(s) such as SHIFT, ALT, or CTRL for Windows, or SHIFT, OPTION, COMMAND, and CONTROL for Mac. Many applications use modifier keys to constrain the size or placement of objects.

Choose one or more modifier options.

Choose a CLICKS option to simulate pressing a button of the selected type on a mouse.

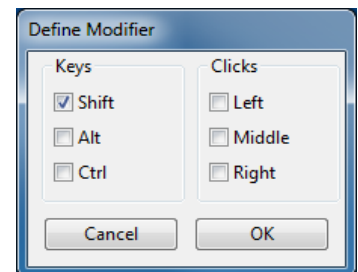



FUNCTION NAME	DESCRIPTION
RADIAL MENU	Displays the Radial Menu on your screen. Each level of the hierarchical menu consists of eight menu slices which may contain various features and options to choose from.
BACK	Simulates the BACK command in browser applications.
FORWARD	Simulates the FORWARD command in browser applications.
PAN/SCROLL...	<p>Enables you to position a document or image in any direction within the active pane. Do this by pressing a pen button set for PAN/SCROLL and then dragging with the pen tip across the Cintiq's screen.</p> <p>When you select PAN/SCROLL, you are prompted to set a scrolling speed for use in applications that do not support grabber hand (pixel-level) panning.</p> <ul style="list-style-type: none"> • A slower setting reduces the scroll rate and is useful for close-up and detail work where you need precise control of the image. • As you move the pen tip, the document or image is repositioned to follow the direction of pen movement on the Cintiq's screen surface. • Release the button or lift the pen tip from the screen surface when you are done. • In some application windows the document will precisely follow the screen cursor as you move the pen tip, while in others it will simply move in the same general direction as the screen cursor.
SHOW DESKTOP	Minimizes all open windows to display a clean desktop.
SWITCH APPLICATION	Brings up the application switching dialog box with focus on the next open application. On Windows 8, Windows 7 systems running Aero, Flip 3D will be activated with focus on the next open application.

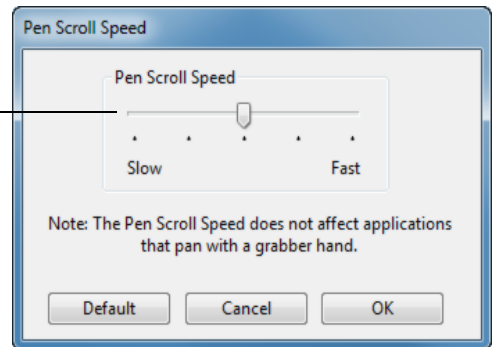

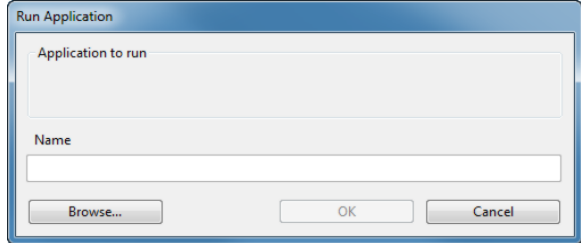

FUNCTION NAME	DESCRIPTION
OPEN/RUN...	<p>Opens a dialog box where you can select a specific application, file, or script to launch.</p> <p>Click BROWSE... to locate an application, file, or script to launch. The selection you make appears in the NAME box.</p> <p>Click OK to accept the selection.</p>  <p>The dialog box will close and the OPEN/RUN... option you have selected will be assigned as the pen button option. Simply press the pen button to launch the assigned option.</p> <p>If your selection is for the Radial Menu, it will be displayed in the Radial Menu.</p>
INK TOGGLE	<p>(Mac only.) Toggles the “ink in any application” function of Ink on and off. Ink recognizes and converts your handwriting into text and inserts it into a document. Handwriting recognition must be turned on for this function to work. See your Mac help for information on working with Ink.</p>
ON SCREEN KEYBOARD	<p>Launches the on-screen keyboard when you press the button to which this function is assigned. Press the button to close the keyboard when open.</p>
EXPOSÉ	<p>(Mac only.) Tiles all open windows. To access this option, first choose KEYSTROKE... and then click on the ADD SPECIAL menu within the dialog box.</p>
PRESSURE HOLD	<p>Locks the pressure at the current pressure level until the button is released. For example, you can paint with pressure sensitivity until you reach the brush size that you like. You can then press the button and continue painting with the same size brush until the button is released.</p>





FUNCTION NAME	DESCRIPTION
PRECISION MODE	<p>Changes the mapping around the current pen tip position so that you must move the pen farther for the screen cursor to cover a specific distance on the screen. This feature can be very useful for the precise control of pen or brush strokes.</p> <p>You can adjust the precision setting when assigning this function to a tool button.</p> <p>To activate:</p> <ul style="list-style-type: none"> • <u>For extensive use</u>, toggle on PRECISION MODE by pressing a tool button to which the function has been assigned. Return to normal mapping by again pressing the tool button. • <u>For quick edits</u>, press and hold a tool button to which the function has been assigned. Normal mapping returns when you release the button. <p>When using a tool in mouse mode, screen cursor movement is adjusted to act as if acceleration were off and speed set to slow.</p>
DISPLAY TOGGLE	<p>Available when Cintiq is connected as part of a multiple monitor system. Enables you to toggle the screen cursor between the Cintiq and your other displays. For example: Cintiq can be used as a pen display where the screen cursor is positioned at the pen tip location on the Cintiq's screen surface. Display Toggle enables you to cycle between pen control for Cintiq and your other displays. This is like using Cintiq as a standard Wacom Tablet where the screen cursor can be moved across the entire desktop or additional displays.</p>

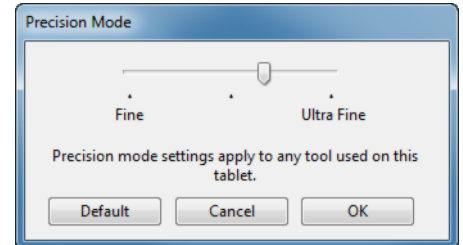



FUNCTION NAME	DESCRIPTION
MODE TOGGLE...	<p>Toggles between pen mode and mouse mode. When using Cintiq on a multiple monitor system, this enables you to use your pen to control the other monitors in mouse mode.</p> <p>When first setting a pen button to MODE TOGGLE..., the MOUSE MODE dialog box is displayed where you can adjust the mouse acceleration and speed.</p> <p>Sets the screen cursor tracking speed when in mouse mode.</p> <p>Sets the screen cursor acceleration when in mouse mode.</p>
ERASE	<p>Pen only. Sets a button so that when the button is pressed, the pen tip will act like the eraser in applications that support the ERASE function. Default setting for the eraser. See erasing.</p>

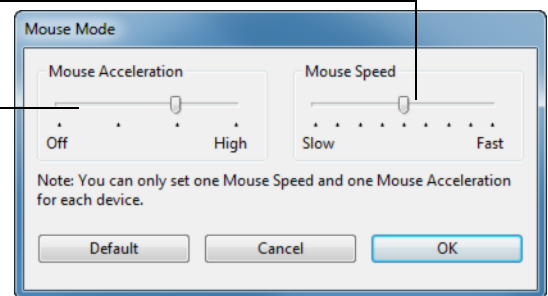

Mouse mode settings can be accessed from a number of different locations within the control panel. However, only one MOUSE ACCELERATION and SPEED setting can be made for each pen and application that you are customizing.

The mouse mode settings are independent of system settings. Changes you make to these settings in the Wacom Tablet control panel do not affect similar system settings. However, changes made to similar system settings may affect your pen display settings.





FUNCTION NAME

DESCRIPTION

SETTINGS

Activates (on your screen) an interactive diagram of the current ExpressKey, Rocker Ring, Home Button, and pen settings. The current functions for each control are shown.

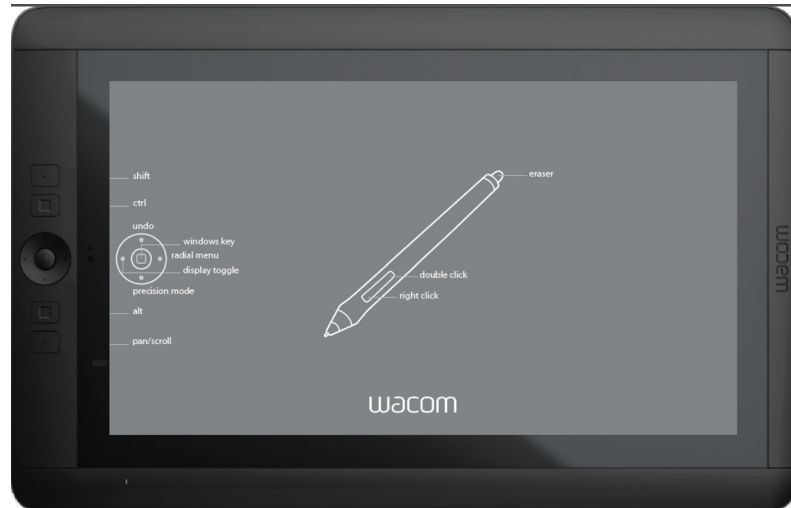

Click on any section of the diagram to change the settings or to open the appropriate Wacom Tablet control panel tab to adjust the settings.

Dismiss the diagram by again pressing the ExpressKey or other tool button to which this function is assigned, or by clicking anywhere outside of the diagram.

Settings may vary depending on your product model.

TABLET PC

- TABLET PC INPUT PANEL (Tablet PCs and Windows systems that support the Tablet PC Input Panel.) Opens the Tablet PC input panel when you press a tool button set to this function.
- JOURNAL (Windows 8, Windows 7 and Tablet PC systems that include Microsoft Journal.) Opens Microsoft Journal.
- TABLET PC DEFINED (Tablet PCs and Windows systems that support the Tablet PC Input Panel.) Sets the button function according to settings found in the Windows TABLET PC SETTINGS and PEN AND INPUT DEVICES control panels.

DISABLED

Disables the button function.

APPLICATION DEFINED

Reports only the button number to the application. This is for applications, such as CAD programs, that have built-in tablet support.

DEFAULT

Returns a button to its default setting.





USING AND CUSTOMIZING THE RADIAL MENU

The Radial Menu is a pop-up menu that provides quick access to editing, navigation, media control functions, and more.

- Set a tool button or ExpressKey to the RADIAL MENU function. Press the button to display the Radial Menu centered at the screen cursor position.
- The hierarchical Radial Menu appears in circular format. Each level of the menu consists of eight control slices which may contain various features and options to choose from.
- Click to select an option. Some selections may display a submenu for additional options.
- The menu closes after you make a selection.
To close without making a selection, click on the 'X' located at the center of the Radial Menu or on a control slice that has no function assigned to it. You can also again press the button used to display the menu.
- To make a selection without closing the Radial Menu, hold down the button that opens the Radial Menu.

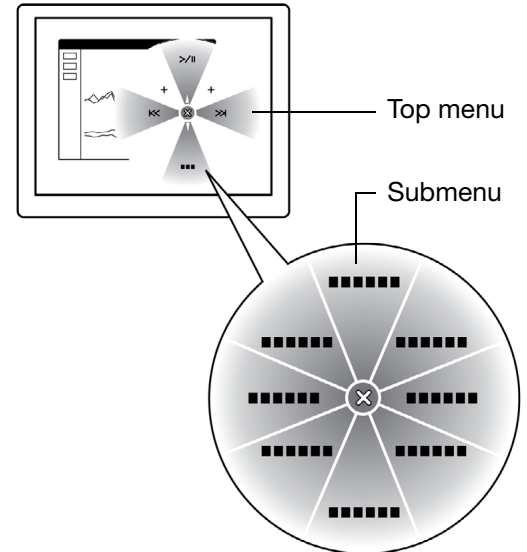

In the Wacom Tablet control panel, use the RADIAL MENU tab to customize the available Radial Menu functions.

1. Select a control slice.
2. Assign a control FUNCTION to the slice. If desired, change the LABEL name.
3. Select a menu or submenu to further customize.

Tips:

- In the FUNCTION menu, choose SUBMENU to create custom submenus for a control slice.
- Press the ENTER (RETURN) key to add multiple lines of LABEL text.

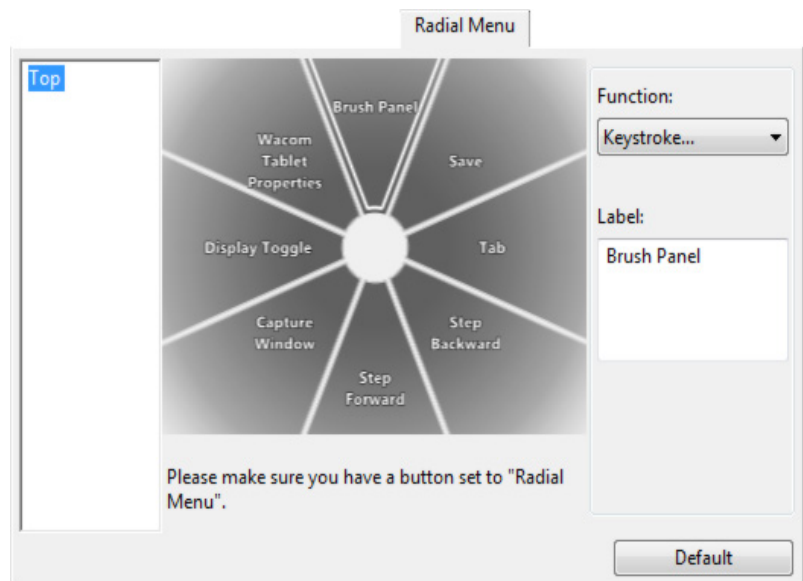



WORKING WITH DISPLAY TOGGLE

A Display Toggle feature is available only on multiple monitor systems. Set an ExpressKey or pen side switch to the DISPLAY TOGGLE function. Then press that button to toggle the screen cursor between Cintiq and your other displays. For example, Cintiq can be used as a pen display where the cursor is positioned at the pen tip location, or toggled for use as a standard Wacom Tablet where the cursor can be moved across the entire desktop or any display on your system.

Open the Wacom Tablet control panel and make sure Cintiq is the selected TABLET. The DISPLAY TOGGLE tab will be available if the system has two or more displays. The options on this tab define how the tablet mapping is applied to each toggled display.

- PEN DISPLAY TO DESKTOP toggles the screen cursor from Cintiq to the entire system desktop. Press the button a second time to return the cursor to Cintiq.
- PEN DISPLAY TO OTHER DISPLAYS toggles the screen cursor from Cintiq to another active pen display or monitor. The cursor toggles to each connected display in turn until it returns to the Cintiq from where the initial toggle began.

Important: When using application-specific settings with Display Toggle, be sure each customized application (including ALL OTHER) has a tool button to which DISPLAY TOGGLE has been assigned. The easiest way to do this is to assign DISPLAY TOGGLE to an ExpressKey before creating any application-specific settings.

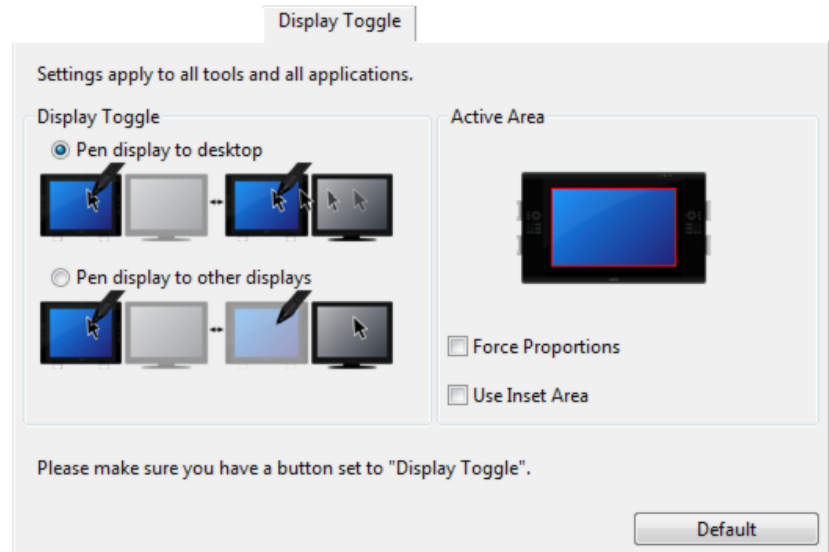

ACTIVE AREA options determine the size of the area where the pen will function on the pen display.

- FORCE PROPORTIONS adjusts the size of the active area to maintain correct vertical and horizontal proportions between Cintiq and the entire desktop or newly mapped-to display. Depending on your settings, some portions of the active area may no longer be usable when this option is selected. When deselected, the correct scale or proportions are not maintained. For example, drawing a circle on the pen display may create an ellipse on a mapped-to screen.
- USE INSET AREA limits the active area to a sizing of 6 x 8 inches. If FORCE PROPORTIONS is also selected, this sizing may be less. When deselected, as much of the active area as possible will be used for tablet-to-display mapping.

Your selection is shown by the red box in the ACTIVE AREA diagram.





APPLICATION-SPECIFIC SETTINGS

You can customize your tools for use with a particular application. For example, you may prefer a firm pen tip pressure setting in one application and a soft pressure setting in another. The APPLICATION list enables you to add an individual application to the list and then customize your tool settings for that application.

- When no application-specific settings have been created and a tool is selected from the TOOL list, the APPLICATION list displays the ALL icon which contains tool settings that apply to all of your applications. In the example below, no application-specific settings have been added for the GRIP PEN. The ALL icon is displayed and the GRIP PEN will have the same settings in all applications.

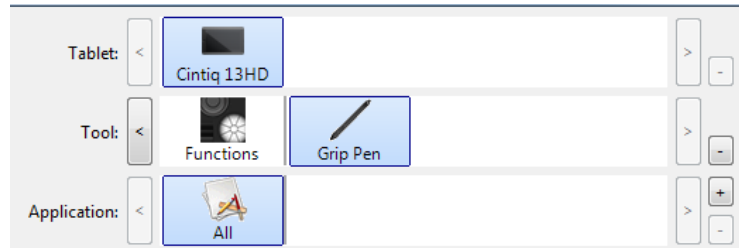

- When application-specific settings are added, the ALL icon changes to ALL OTHER and an application icon is displayed for the newly added application(s).

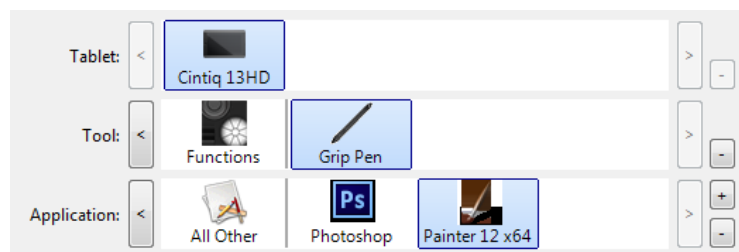

In the above example, application-specific settings have been added for the GRIP PEN. If you select the ALL OTHER icon and make changes to the GRIP PEN settings, your changes will apply to the GRIP PEN in all applications except those which you have added to the APPLICATION list. If you select an application icon and make changes to the GRIP PEN settings, your changes will apply to the GRIP PEN while you are using that application only.

When you create application-specific settings, you are creating a separate group of settings for the selected tool and application. See the following sections for more details:

[Creating an application-specific setting](#)

[Changing application-specific settings](#)

[Removing application-specific settings](#)

Tip: To review ExpressKey, Rocker Ring, or pen function settings for the front-most application, set the ExpressKey or Rocker Ring to SETTINGS and press the key at any time.





CREATING AN APPLICATION-SPECIFIC SETTING

First choose the product and input tool for which you want to create an application-specific setting.

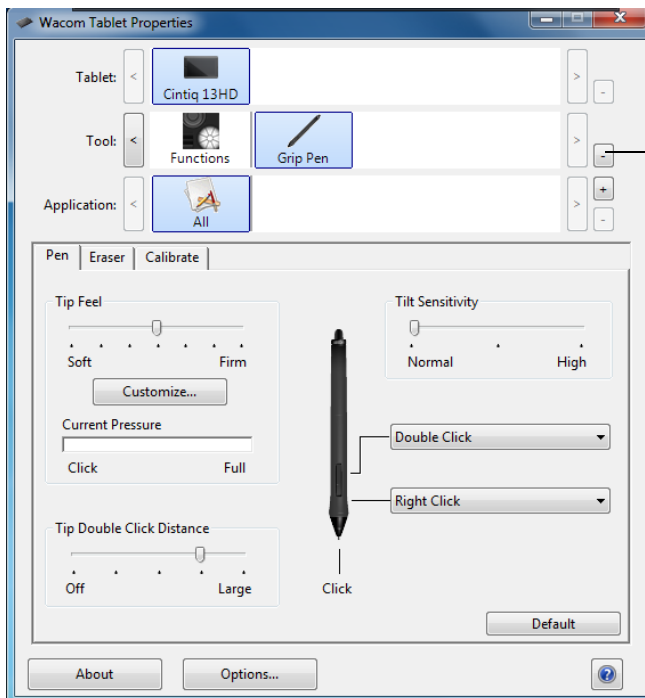

Click on the APPLICATION list [+] button.

Choose a method to select an application:

- Open the application for which you want to create custom settings, and then select that application from the CURRENTLY OPEN APPLICATIONS box.
- BROWSE to select the executable file of any application installed on your computer.

The name of your selected application is displayed.

Click OK to complete the process.

Note: If two programs have the same executable file name, they will share the same customized settings.

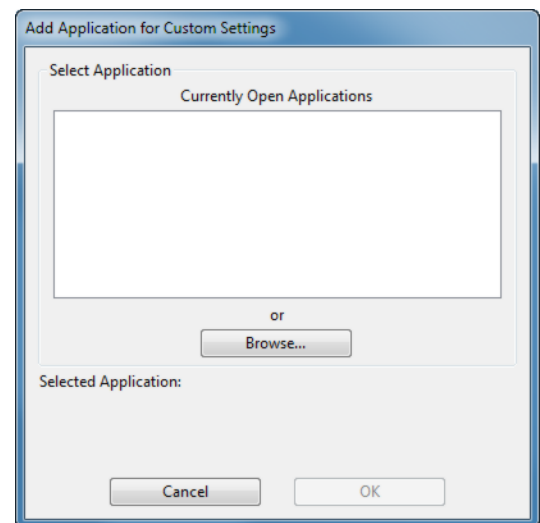

After adding an application, its icon appears in the APPLICATION list whenever the respective tool is selected in the TOOL list. Select the application and then customize the control panel tab settings for your tool and selected application.

Once you have created application-specific settings, applications that have not been customized in this manner will use the tool settings for ALL OTHER.

Tip: First customize settings for one application. When you feel comfortable with the process, you can create more application-specific settings.





CHANGING APPLICATION-SPECIFIC SETTINGS

To change tool settings for a specific application, select the tool and the application. Then customize the tab settings.

REMOVING APPLICATION-SPECIFIC SETTINGS

To remove an application-specific setting:

1. In the TOOL list, select the tool from which you want to remove the application-specific setting. Then, in the APPLICATION list select the application you want to remove from the list.
2. Click on the APPLICATION list [-] button. In the dialog box that appears, click DELETE to confirm your selection. The selected application is removed from the list, along with any custom tool settings.

Tip: To quickly remove all application-specific settings from a single tool, remove it from the TOOL list. Then place the tool back on the list. The tool will be added back to the TOOL list using the default settings. This method cannot be used to remove custom FUNCTIONS settings. See [working with multiple tools](#).

WORKING WITH MULTIPLE TOOLS

The Wacom Tablet control panel is designed to help you customize and keep track of the settings for your Cintiq tools. The tool you use to open the control panel is automatically selected, and the appropriate tabs for that tool are displayed.

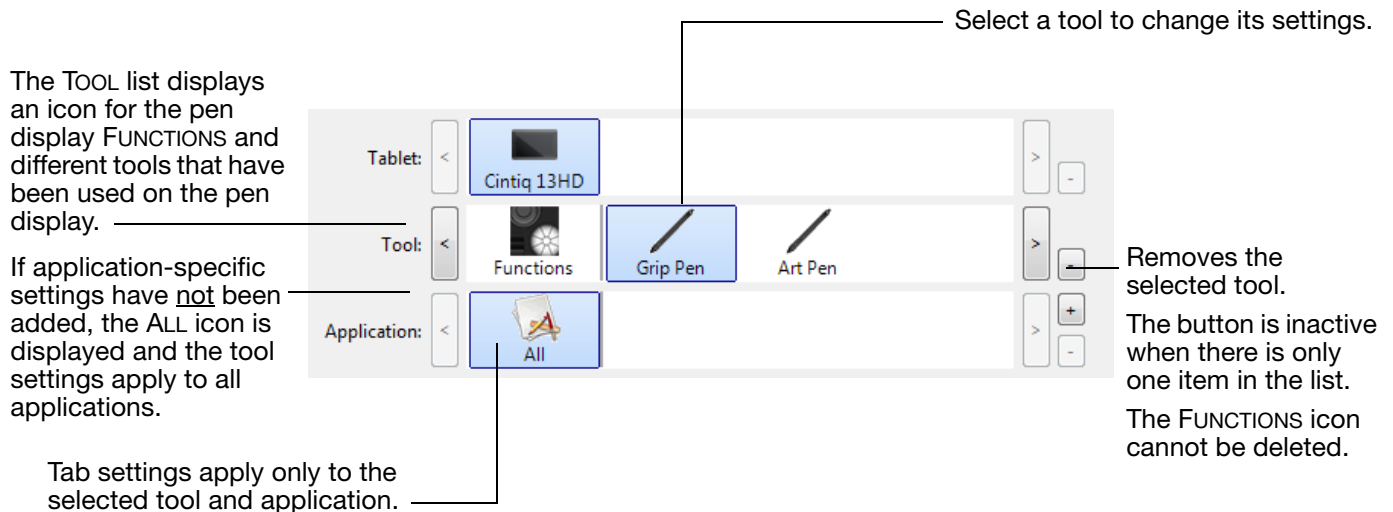

To add a different tool to the TOOL list, simply use the tool on your Cintiq.

- When you select a tool that has been added to the TOOL list, the appropriate tab settings for that tool are displayed. Any changes you make to the tab settings will then apply to the tool. Your changes take effect immediately.

If a similar tool was previously added, the new tool will inherit the settings of the previously added tool. These settings can then be customized for the newly added tool.

- Identical tools will use the same settings.

To remove a selected tool from the TOOL list, click on the TOOL list [-] button. In the dialog box that appears, click DELETE to confirm your selection. The selected tool is removed from the list, along with any custom settings you may have created for it. A removed tool can be added back to the TOOL list by placing it back onto the pen screen.





RENAMING THE TABLET IN THE TABLET LIST

Within the control panel TABLET list, double-click on the pen display icon.

If desired, enter a new name to be used for the pen display icon.

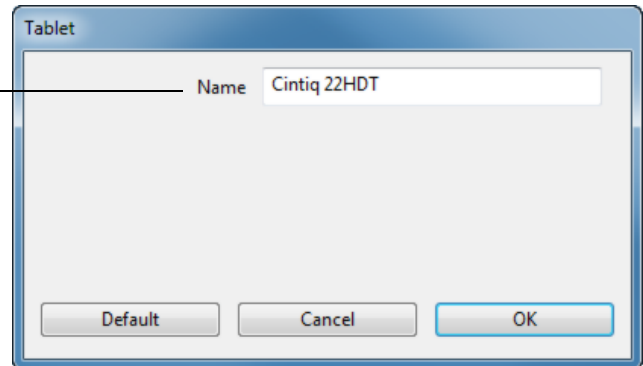



TROUBLESHOOTING

If you are having trouble, Wacom recommends you do the following:

1. If the Wacom driver failed to load properly, first perform the recommended action in any error message that may appear on your screen. If that does not solve the problem, review the troubleshooting procedures in this chapter.
2. If the Cintiq does not function properly, refer to [troubleshooting](#) or [pen tablet troubleshooting](#). Your problem may be described there and you can try the solution offered.
3. Check the Notes linked to the driver download screen on the CD for any updates.
4. Visit www.wacom.com and choose the Wacom website for your region where you can check the product FAQs ([Frequently Asked Questions](#)).
5. If you are having a compatibility conflict between Cintiq and a new hardware or software product, see [obtaining software updates](#) for information on downloading an updated software driver. Wacom periodically updates the software driver to maintain compatibility with new products.
6. Try [Testing Cintiq](#).
7. If you have tried the suggestions in this manual and still cannot resolve the problem, then contact Wacom for Technical Support. See the [technical support options](#) for information on where to obtain support for your region.

[Testing Cintiq](#)

[Testing controls and input tools](#)

[Troubleshooting](#)

[Pen tablet troubleshooting](#)

[Technical support options](#)

[Obtaining software updates](#)





TESTING CINTIQ

1. If the Cintiq status LED does not light, check the following:
 - First verify that the light on the power adapter is on. If the light is not on, check that the power cable is properly connected between the power adapter and an active AC outlet.
 - Check that the power adapter cable is securely connected to the Cintiq power cable, and that the Cintiq is turned on. The status LED will glow white whenever the Cintiq is turned on. The dimmer light indicates that a video signal is being received. The light will brighten when you touch the pen to the display surface.

Important: Use only an AC adapter specified for use with your Cintiq. Other adapters may cause damage to your product.
2. If there is no display:
 - Make sure that your computer is turned on. The status LED will glow white when the proper video signal is received.
 - Verify that the Cintiq is connected to an active digital video port.
 - Check that your video card has been properly installed and is functional. If you have another display that is compatible with your video card, you can connect that display to the card in order to verify that the video card is operating correctly.
3. Verify that the pen and the tablet portion of your Cintiq are working:
 - Press the pen tip against the display and verify that the status LED lights white.
 - If the LED does not light, verify that the USB cable is plugged into an active USB port. If the Cintiq is plugged into a USB hub, try plugging it directly into the USB port on your computer.
 - Be sure that the USB port to which you are connecting has not been disabled. It may be necessary to check your system BIOS setting to verify that you have connected the Cintiq to an active USB port.
 - The status LED will light white when Cintiq is registered as a USB device and the pen tip is pressed against the display.
4. Check the pen. If you cannot make a selection on the screen with the pen:
 - Test the pen by pressing the pen tip or eraser against the surface of the Cintiq. The status LED should light white.
 - Now, without applying pressure to the pen tip but keeping the pen within 5 mm (0.2 inch) of the Cintiq surface, press the side switch. The status LED should again light white.
 - If the status LED does not light for these tests, be sure you are using a pen specified for use with your product.
 - See [testing controls and input tools](#) and [testing a pen](#) for more information.
5. Check the ExpressKeys and Rocker Ring. See [testing controls and input tools](#) and [Testing the ExpressKeys, Rocker Ring and Home Button](#).
6. Check any other tool(s), such as the optional Airbrush. See [testing controls and input tools](#).

If you are still having problems, you may have a defective pen or Cintiq.

After testing, use the Wacom Tablet control panel to reconfigure your tablet and tools for any custom settings you may originally have been using.





TESTING CONTROLS AND INPUT TOOLS

If the Grip Pen or the Cintiq controls do not work as you expect, it is a good idea to first check the assigned functions or reset them to their default conditions.

A quick way to return a pen to its default condition is to remove it from the control panel TOOL list. Do this by selecting the pen and clicking on the TOOL list [-] button. After the pen has been removed, place it back onto the screen surface. The pen will be added back to the TOOL list with its default settings.

- Open the Wacom Tablet control panel and click on the ABOUT button. In the dialog box that appears, click DIAGNOSE.... The DIAGNOSTICS dialog box shows dynamic information about the Cintiq and your input tool(s).

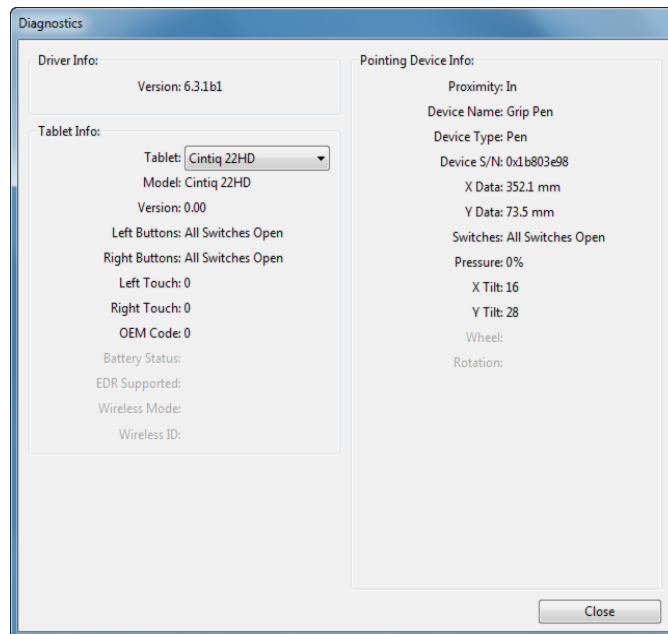

- If more than one Cintiq or tablet is connected to your system, select the product you are testing in the TABLET INFO column .
- Use the information shown in the DIAGNOSTICS dialog box when testing your Cintiq and pen.

Note: If a tool button is set to RADIAL MENU or OPEN/RUN..., that function will occur when the button is pressed. In this case you may want to change the button function before testing.

[Testing the ExpressKeys, Rocker Ring and Home Button](#)

[Testing a pen](#)





TESTING THE EXPRESKEYS, ROCKER RING AND HOME BUTTON

1. With the DIAGNOSTICS dialog box open, observe the TABLET INFO column as you test each ExpressKey or Rocker Ring position. Be sure to select the pen display you are testing from the TABLET INFO column.
2. Test the ExpressKeys, Rocker Ring positions or Home Button by pressing them one at a time. Each time you press a key, position or button, its number is shown next to either the LEFT BUTTONS or RIGHT BUTTONS category, depending on which key or position you are testing.
3. When you are done, click the CLOSE button to exit the dialog box.

Important: Some applications can override and control the ExpressKey or Rocker Ring functions. Consider closing any open applications except the Wacom Tablet control panel when testing the ExpressKeys or Rocker Ring. For details, see [using applications integrated for tablet control](#).

TESTING A PEN

1. With the DIAGNOSTICS dialog box open, and while observing the POINTING DEVICE INFO column, bring your pen within 5 mm (0.2 inch) of the screen. A value for PROXIMITY, the DEVICE NAME, DEVICE TYPE, and a DEVICE S/N (serial number) should be displayed. Be sure to select the pen display you are testing from the TABLET INFO column.
2. Move your tool along the pen screen surface. The X and Y DATA values should change to reflect the tool position.
3. Test your pen switches. The Cintiq status LED should light white each time you click with the tool tip, press the side switch, or press the tool eraser to the screen.
 - Press on the screen surface with the tool tip. The SWITCHES state and PRESSURE value should change. PRESSURE should change from approximately 0% with no pressure applied to approximately 100% when full pressure is applied.
 - Next, press the side switch without pressing the tip to the tablet. The SWITCHES state should change. For the Grip Pen, do this for both positions of the switch.

Pen	Tip = 1
SWITCHES states	Side switch (lower position) = 2
	Side switch (upper position) = 3
	Eraser = 1
<hr/>	
Airbrush	Tip = 1
SWITCHES states	Side switch = 2
	Eraser = 1

- Press the eraser to the screen. The SWITCHES state and PRESSURE value should change. PRESSURE should change from approximately 0% with no pressure applied to approximately 100% when full pressure is applied.
- For the optional Airbrush, move the fingerwheel forward. The WHEEL value should decrease to a value of approximately 0 when the fingerwheel is all the way forward. Move the fingerwheel backward. The WHEEL value should increase to approximately 1000 when the fingerwheel is all the way back.





4. Test tilt for the x-axis by moving the pen from a vertical position toward the right; the X TILT value should change from approximately 0 to +60. Now move the tool to the left of vertical; the X TILT value should change from approximately 0 to - 60.
5. Test the tilt for the y-axis by moving the pen from a vertical position toward the bottom of the tablet; the Y TILT value should change from approximately 0 to +60. Now move the tool toward the top of the tablet; the Y TILT value should change from approximately 0 to - 60.
6. For the optional Art Pen, test the rotation feature by placing the pen tip on the screen surface and slowly rotating the pen on its axis. The ROTATION value should change as you rotate the pen.
7. When you are done, click on the CLOSE button to exit the dialog box.





TROUBLESHOOTING

If you encounter problems with the display portion of your Cintiq, refer to the following tables. Your problem may be described here and you can try the solution offered. For more information about color issues, see the documentation that came with your operating system or applications.

GENERAL PROBLEMS

No display. The status LED does not light.	<ul style="list-style-type: none"> • Verify that the AC power cable is connected, and that the Cintiq is turned on. • In the Wacom Display Settings dialog, adjust the contrast and brightness controls, or choose ADVANCED and then FACTORY RESET to return the Cintiq to its original settings.
The status LED is blinking.	<ul style="list-style-type: none"> • Your computer may be in a power management mode. Touch the pen tip to the screen, move the mouse, or depress any key on your keyboard. • Turn off both your computer and the Cintiq. Check the video cable for bent or broken connector pins. Then properly connect the video cable and turn on the Cintiq and your computer. • Verify that the video card and cable are properly installed.
A 'cable disconnect go to power save' message appears briefly on the screen.	<ul style="list-style-type: none"> • Check that your computer is turned on. • Verify that you are using the video cable that came with the Cintiq. • Check that the video cable is fully connected. • Turn off both your computer and the Cintiq. Check the video cable and any video adapters for bent or broken connector pins. Then properly connect the video cable and any necessary adapters.
An 'out of range' message appears briefly on the screen.	<ul style="list-style-type: none"> • The input signal frequency is incorrectly set or not compatible with the Cintiq. Set the refresh rate to a vertical frequency that is compatible with your Cintiq. If your video card driver supports adjustment of the horizontal frequency, make sure it is also set to a compatible value. See the IPI for frequency range details. • The resolution or refresh rate is set too high. See the IPI for details about the maximum (native) resolution, refresh rate, and other resolution sizes that can be used with your Cintiq. • Set the display properties to detect plug and play monitors.
A 'set refresh range' message appears briefly on the screen.	<ul style="list-style-type: none"> • Set the refresh rate to a vertical frequency that is compatible with your Cintiq. See the IPI for frequency range details.
The image appears multiple times on the display.	Do not extend the video cable or use an input selector switch box.
When a still image is displayed for a long period of time without refreshing the screen, an after-image remains for a short period of time.	Use a screen saver or other power management feature.





Color quality is inaccurate.

- In the Wacom Display Settings dialog, choose **ADVANCED** and then **FACTORY RESET** to return the display to its original settings.
- Check the color profile settings that you are using with Cintiq.
- Make any changes to the contrast settings in small increments, as changes in contrast may affect color accuracy.

The color white does not display as white.

- Check the color profile settings that you are using with Cintiq.
- Verify that the display is operating at the factory default settings. If that is not sufficient, adjust the color as necessary. For details on color management, refer to your operating system and application documentation.
- Verify the video cable and port are fully connected.





PEN TABLET TROUBLESHOOTING

If you encounter problems with the tablet portion of the Cintiq, see the following tables. Your problem may be described here, and you can try the solution offered. Also check the Notes linked to the driver download screen for the latest information updates.

For additional information, visit the Wacom website at <http://www.wacom.com>.

[Windows-specific problems](#)

[Mac-specific problems](#)

The computer does not have an available USB port.	Check if there is an available USB port on a USB hub. If not you will need to add a USB hub or USB card.
A USB device plugged into the Cintiq USB accessory port does not function.	<ul style="list-style-type: none"> • Make sure the Cintiq itself is properly connected to a working USB port on your computer. • Be sure the Cintiq is powered on and that the status LED lights white. The Cintiq contains a powered USB hub and the accessory port will not work when the power is off. • If the USB device does not work, try plugging it into a USB port directly on your computer. • If the USB device still does not function properly, contact the manufacturer for that particular device.
The status LED is off.	<ul style="list-style-type: none"> • Make sure the Cintiq is turned on. • Check that the AC power adapter is plugged into both the Cintiq and an active power outlet. • Use only a power adapter specified for use with your Cintiq. Other adapters may cause damage to your product.
The pen works only in mouse mode, and does not draw or write with pressure sensitivity.	<p>The driver software for the tablet portion of the Cintiq was not installed or did not load properly.</p> <ul style="list-style-type: none"> • Make sure the driver software is installed and functioning. • Install the driver software in accordance with step 2: software installation.
The pen does not draw or write with pressure sensitivity.	<p>Some applications require that you turn on the pressure capabilities within the application or selected tool before the pen will respond as a pressure-sensitive tool.</p> <p>Verify also that your application supports pressure sensitivity.</p>
Clicking is difficult.	Open the Wacom Tablet control panel and go to the PEN tab. Try using a lighter TIP FEEL.
The pen selects everything or will not stop drawing.	Open the Wacom Tablet control panel and go to the PEN tab. Move the TIP FEEL slider toward FIRM, or select CUSTOMIZE... and increase the CLICK THRESHOLD setting. If this does not help, see testing controls and input tools .





Double-clicking is difficult.	<ul style="list-style-type: none"> • Be sure you are quickly tapping the screen twice in the same place. Wacom recommends using the side switch to double-click. • Open the Wacom Tablet control panel and go to the PEN tab. Try increasing the TIP DOUBLE CLICK DISTANCE or using a lighter TIP FEEL. • Set an ExpressKey to DOUBLE CLICK. • Windows: Try setting your system to launch programs with a single click. See clicking.
The eraser selects everything or will not stop erasing.	Open the Wacom Tablet control panel and go to the ERASER tab. Move the ERASER FEEL slider toward FIRM, or select CUSTOMIZE... and increase the CLICK THRESHOLD setting. If this does not help, see testing controls and input tools .
You notice a delay at the beginning of pen or inking strokes.	Open the Wacom Tablet control panel and go to the PEN tab. Try decreasing the TIP DOUBLE CLICK DISTANCE. If that does not work, move the TIP DOUBLE CLICK DISTANCE slider to the OFF position in order to turn off double-click assist.
You have to press hard with the pen when clicking, drawing, or writing.	Open the Wacom Tablet control panel and go to the PEN tab. Move the TIP FEEL slider toward SOFT, or select CUSTOMIZE... and decrease the SENSITIVITY and CLICK THRESHOLD settings.
The pen tip does not function.	<ul style="list-style-type: none"> • Be sure you are using only the pen that came with your product, or a Wacom accessory pen specified for use with the Cintiq 13HD. Other pens may not function properly on the Cintiq. • Check the Wacom Tablet control panel PEN tab and verify that a CLICK function is assigned to the pen tip. • Make sure the status LED lights white when the tip is pressed. If the LED does not light, verify that the USB cable is plugged into an active port on your computer or on a USB hub. • If the LED still does not light, you may have defective hardware (see troubleshooting).
The pen tip and screen cursor do not properly line up.	Open the Wacom Tablet control panel and select the CALIBRATE tab. Continue with calibrating the cintiq .
Changing the function settings for an input tool has no effect.	Make sure you change the settings for the tool and application that you are using. See application-specific settings and working with multiple tools .





The pen side switch does not work.

- Be sure you are using only the pen that came with your product, or a Wacom accessory pen specified for use with the Cintiq 13HD. Other pens may not function properly on the Cintiq.
- Be sure to press the side switch when the pen tip is within 5 mm (0.2 inch) of the Cintiq active area. Do this without pressing down on the pen tip.
- In the Wacom Tablet control panel, verify that the side switch is set to the proper function you are expecting to occur for the application and tool you are using.
- Check the SIDE SWITCH MODE. If CLICK & TAP is selected, you will need to first press the side switch, then touch the pen tip to the pen screen surface in order to perform a click function.
- Make sure the status LED lights white when you press the side switch. If it does not, verify that the USB cable is plugged into an active USB port on your computer or on a USB hub. The LED will not light if the USB cable is not plugged into an active port.
- If the LED does not light, you may have defective hardware (see [troubleshooting](#)).

The screen cursor moves but it does not jump to the pen tip location when placed on the screen, and it does not follow the pen tip when moving the pen across the display.

- Make sure the Wacom driver has loaded properly by opening the Wacom Tablet control panel. If the driver did not load you will see an error message. If an error message appears, reboot your computer. If the problem persists, refer to [step 2: software installation](#) and reinstall the Wacom driver software. (For Mac, you must restart your computer after installing the Wacom driver for proper operation.)
- If you have customized the side switch on your pen to toggle between pen mode and mouse mode, make sure that your Cintiq is operating in pen mode.

When using Cintiq on a multiple monitor system, you cannot use the pen to control the other monitor(s).

- Cycle between pen control for Cintiq and your other displays by pressing an ExpressKey or pen button that is set to [Display Toggle](#).
- You can also use your pen to control the other monitors in mouse mode. To use mouse mode, first set a pen button to MODE TOGGLE.... Then use the button to toggle between pen mode and mouse mode.

The line you are drawing does not line up with the location of the screen cursor.

- To function properly, some applications require that the pen be set to pen mode. Make sure the pen has not been toggled to mouse mode.
- If you have set the pen to pen mode and the problem still exists, then you may have a corrupted preferences file. Follow the instructions in [Windows-specific problems](#) or [Mac-specific problems](#) to create a new preferences file.

The computer does not go to sleep.

When you are not using the pen, remove it from the Cintiq surface or Cintiq will continue to send data, keeping the computer awake.

The screen cursor jumps back when using your regular mouse or trackball.

When not in use, place the pen in the pen case, pen stand, or some other location near the Cintiq. Do not leave the pen on the display. Leaving your pen on the display may interfere with screen cursor positioning when using other input devices.





The screen cursor moves erratically or jumps around on the screen when another tablet is connected to your computer.

The tablet portion of Cintiq emits electromagnetic waves at a certain frequency. If another tablet is placed too close to the Cintiq it may interfere with screen cursor positioning. If this occurs, move the tablet further away from the Cintiq.

When working in some applications, the ExpressKeys, Rocker Ring or Home Button perform a different function than what is set in the Wacom Tablet control panel.

- Some applications can override and control the ExpressKey, Rocker Ring or Home Button functions. See [using applications integrated for tablet control](#).
- If you are using application-specific settings, be sure you have updated the settings for the application you are working with.

The ExpressKeys, Rocker Ring or Home Button do not perform the correct functions to which they are set.

Check to be sure that Cintiq is correctly configured for your preferred handedness. See [Configuring Cintiq for handedness](#).

Some defaults for control panel, ExpressKeys, Rocker Ring or Home Button may be different from those shown in the manual.

In some regions the control panel defaults may vary, depending on application and operating system differences.





WINDOWS-SPECIFIC PROBLEMS

You suspect the Cintiq preferences may be corrupted, or want to make certain that all settings are at their factory defaults.

Use the Wacom Tablet Preference File Utility to work with preferences. Close any open applications. Click the START icon and select ALL PROGRAMS. Then select WACOM TABLET and WACOM TABLET PREFERENCE FILE UTILITY.

Windows 8: From the Windows 8 Start screen, click the WACOM TABLET PREFERENCE FILE UTILITY tile. If you are using the Windows 8 Classic Desktop, press the Windows key on your keyboard, or select the Windows icon in the Charms bar, to access the Start screen.

Windows 7: Open the utility by clicking the START icon and selecting ALL PROGRAMS. Select WACOM TABLET and WACOM TABLET PREFERENCE FILE UTILITY.

- It is a good idea to first back up your tablet preferences. In the TABLET PREFERENCE FILE UTILITY dialog box, click BACKUP... and follow the prompts.
- Use the Tablet Preference File Utility to delete the tablet preferences as follows:

Single user. Under MY PREFERENCES, click REMOVE to delete the preferences for the current user.

Multiple users. Under ALL USER PREFERENCES, click REMOVE to delete preferences for multiple users. Administrator rights are required to delete preferences for all users. Relaunch any currently open tablet-aware applications that you may be running.

You can restore tablet preferences that have been backed up by clicking RESTORE... under MY PREFERENCES.

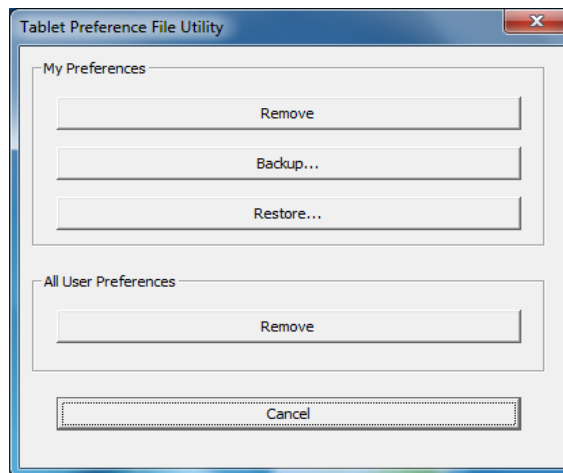



MAC-SPECIFIC PROBLEMS

At startup, a dialog box appears telling you that either the driver failed to load or the Cintiq preferences have not yet been created.

The tablet portion of the Cintiq was not detected at startup. Make sure the USB cable is securely connected to an active USB port on your computer or USB hub. Make sure that the Cintiq status LED is on and is glowing white. If this does not correct the problem, see [troubleshooting](#).

From the GO menu, select UTILITIES and launch the SYSTEM PROFILER. Select USB from the HARDWARE section of the CONTENTS list. A Wacom USB Cintiq model should be listed. If a model is not listed, check the Cintiq USB cable connection or try plugging the Cintiq into a different USB port.

If this does not help, contact Wacom for Technical Support. See [technical support options](#).

You suspect the Cintiq preferences may be corrupted, or want to make certain that all settings are at their factory defaults.

Use the Wacom Tablet Utility to work with preferences. Close any open applications. Open the main APPLICATIONS folder. Then open the WACOM TABLET folder and run the WACOM TABLET UTILITY.

- It is a good idea to first back up your tablet preferences. In the Wacom Tablet Utility, select CURRENT USER or ALL USERS. Then click BACKUP... and follow the prompts.

- Delete the tablet preferences as follows:

Single user. When the utility starts, select CURRENT USER and click REMOVE. Log out, then log back in. When the Cintiq driver loads it will create a new preferences file with the factory defaults.

Multiple users. When the utility starts, select ALL USERS and click REMOVE. Log out, then log back in. When the Cintiq driver loads it will create new preferences files with the factory defaults.

You can quickly restore tablet preferences that have been backed up for the CURRENT USER or ALL USERS by clicking RESTORE... within the utility.

Note: Do not manually remove the WACOMTABLET.PREFPANE file from the main LIBRARY PREFERENCEPANES folder. This file is only to be removed when uninstalling the Wacom software driver, and then only when using the Wacom Tablet Utility.

Recalibrate the Cintiq. See [calibrating the cintiq](#).





Ink does not work correctly with the Cintiq.

There may be a problem with the Ink preferences. Remove the damaged preference files as follows. They will be re-created when you enable handwriting recognition.

1. Open SYSTEM PREFERENCES, choose SHOW ALL and select INK. Then turn off handwriting recognition.
2. From the GO menu, choose your HOME. Open the LIBRARY and PREFERENCES folders. Remove the following preferences:
 - COM.APPLE.INK.FRAMEWORK.PLIST
 - COM.APPLE.INK.INKPAD.PLIST
 - COM.APPLE.INK.INKPAD.SKETCH
3. Go back to SYSTEM PREFERENCES and INK, and then enable handwriting recognition.
4. Test the Ink function using your Cintiq and Wacom pen.

If this procedure does not resolve your problem with Ink, contact Apple Support for further assistance. Wacom is not the software manufacturer for Ink and we are limited in our abilities to support a third party software application.





TECHNICAL SUPPORT OPTIONS

If you have a problem with your Cintiq, check the appropriate [installation](#) section in this manual to make sure the Cintiq is installed correctly. Then review the [troubleshooting](#) procedures.

If you cannot find the answer in this manual, you may find updated information about your problem in the Notes linked to the driver download screen (located on the Installation CD). You can also check the product FAQs ([Frequently Asked Questions](#)).

If you have an Internet connection, you can download the latest software drivers from the Wacom website for your region. See [obtaining software updates](#).

Check the Customer Care options on the Wacom website for your region. You may find answers to your questions without having to make a phone call.

If you cannot solve the problem and you think your Wacom product is not working properly, contact the Wacom support staff for the area where your product was purchased. You can find contact information by checking the Wacom website for your region.

When you call, you should be at your computer with the following information available:

- This manual.
- Serial number. (See the label on the back of the Cintiq.)
- Driver version number. (See the Installation CD or click on the Wacom Tablet control panel ABOUT button.)
- The make and model of your computer, and operating system version number.
- The make, model, and connection type of your video card.
- A list of peripheral devices attached to your computer.
- The software application and version you were using when the problem occurred.
- The exact wording of any error message that appeared on your screen.
- What happened and what you were doing when the problem occurred.
- How you tried to solve the problem.

You can also contact the Wacom Customer Care Center by visiting the Wacom website for your region and completing an Email Inquiry form.

OBTAINING SOFTWARE UPDATES

Wacom periodically updates the tablet software driver to maintain compatibility with new products. If you are having a compatibility problem between Cintiq and a new hardware or software product, it may be helpful to download a new software driver (when available) from the Internet.

Visit the Wacom website at www.wacom.com for Customer Care and product drivers or other software updates.





FREQUENTLY ASKED QUESTIONS

This section provides answers to some of the more commonly asked questions about Cintiq. To browse more FAQs, visit the Wacom website for your region.

[Will Cintiq work in all applications?](#)

[What software applications support Cintiq features?](#)

[Can I have Cintiq and a mouse connected to my computer at the same time?](#)

[Can I use older Wacom input tools with Cintiq?](#)

[The installer is asking for a password. What is the password?](#)

[The pen and screen cursor do not line up. Why?](#)

[How do I reset my Cintiq preferences to the default settings?](#)

[Can I delete all Cintiq preferences at one time?](#)

[What is the best way to clean Cintiq?](#)

[How do I change the nib \(tip\) of my pen?](#)

[Where can I obtain spare parts and accessories?](#)

[How do I find the product model and serial number?](#)

Will Cintiq work in all applications?

Cintiq supports general mouse input functions in all applications. Assuming the product driver is installed and functioning properly, pressure sensitivity and eraser functions are also supported in many graphic applications.

What software applications support Cintiq features?

Many applications support pressure sensitivity and eraser input from your Wacom product.

Visit www.wacom.com and search software applications. If you do not find your application listed, try using it with Cintiq to determine if you experience pressure variance when you paint or draw with the pen. Your software manufacturer will be able to provide the best information about which pen input features the application supports.

Can I have Cintiq and a mouse connected to my computer at the same time?

Yes. You can use your system mouse in conjunction with your Wacom product. Only one device at a time can control the screen cursor. You can change back and forth between your Cintiq input tools and a system mouse at your convenience.





Can I use older Wacom input tools with Cintiq?

Pens and accessories are generally specific to the product model they come with, so they may not be interchangeable. Visit the Wacom website for your region and check the Customer Care Knowledge Base for details.

The installer is asking for a password. What is the password?

The computer is looking for a password that is either your personal password or the administrative password to log into the computer. If your personal password does not work and you are in a business environment you will need to ask the system administrator to install the tablet for you. The operating system requires the user to have administrative access to install a hardware device.

The pen and screen cursor do not line up. Why?

The Cintiq needs to be calibrated. This should be done each time you reinstall the tablet driver or delete the Cintiq preference file. See [calibrating the cintiq](#).

How do I reset my Cintiq preferences to the default settings?

See [managing preferences](#).

Can I delete all Cintiq preferences at one time?

Yes. See [managing preferences](#).

What is the best way to clean Cintiq?

See [Caring for Cintiq](#).

How do I change the nib (tip) of my pen?

See [replacing the pen nib](#).

Where can I obtain spare parts and accessories?

See [ordering parts and accessories](#).

How do I find the product model and serial number?

These are labeled on the back of the Cintiq. The model number is typically located above the bar code, and the serial number just below the barcode. The model number and serial number is needed for all Customer Care support requests.





CARE AND MAINTENANCE

This section provides tips for the care and maintenance of your Cintiq 13HD.

[Caring for Cintiq](#)

[Replacing the pen nib](#)

CARING FOR CINTIQ

Keep the Grip Pen and the Cintiq LCD screen surface clean. Dust and dirt particles can stick to the pen and cause excessive wear to the screen surface. Regular cleaning will help prolong the life of your LCD screen surface and pen.

Keep Cintiq and the Grip Pen in a clean, dry place and avoid extremes in temperature. Room temperature is best. To protect your pen, store it in the pen case or pen stand if you will not be using it.

Cintiq and the Grip Pen are not made to come apart. Taking apart the product will void your warranty.

Important: Take care to never spill liquids onto the Cintiq or the pen. Be especially careful of getting the display, Rocker Ring, ExpressKey or pen buttons and tip wet as they contain sensitive electronic parts that will fail if they are exposed to liquids.

Prevent scratching by replacing your pen nibs frequently. When the nibs are worn or pointed they can damage your Cintiq. See [replacing the pen nib](#).

To clean the Cintiq casing or the Grip Pen, use a soft, damp cloth; you can also dampen the cloth using a very mild soap diluted with water. Do not use paint thinner, benzene, alcohol, or other solvents to clean the product casing or pen.

To clean the screen, use an anti-static cloth or a slightly damp cloth. When cleaning, apply only a light amount of pressure to the screen and do not make the surface wet. Do not use detergent to clean the screen as this may damage the Cintiq's screen. Damage of this kind is not covered by the manufacturer's warranty.





REPLACING THE PEN NIB

To protect your Cintiq from damage and for best performance, periodically replace your pen nibs.

Important: Replace the pen nib before or when it looks like this:.

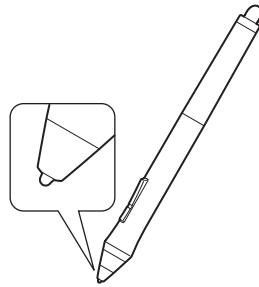
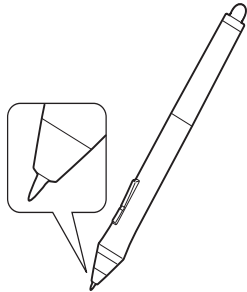

The pen nib (tip) will wear with normal use.

Excessive pressure will cause it to wear more quickly.

Replace the nib when it gets too short or develops a flat edge.

1. To replace your pen nib, use the nib removal tool, a pair of tweezers, needle-nosed pliers, or similar instrument to pull the nib straight out of the pen.
2. Use the same tool to grasp the new nib and place it into the end of the pen.
3. Slide the end of the new nib straight into the barrel of the pen. Firmly push the nib until it stops.

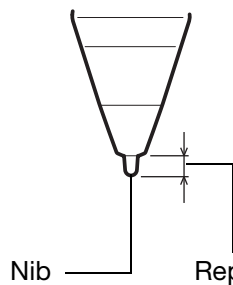

Replace when 1 mm
(0.04 inch) or less.

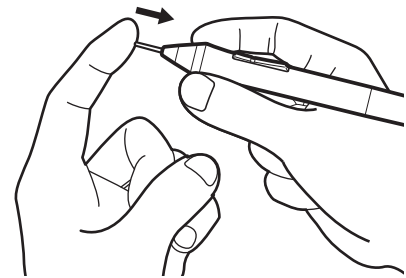
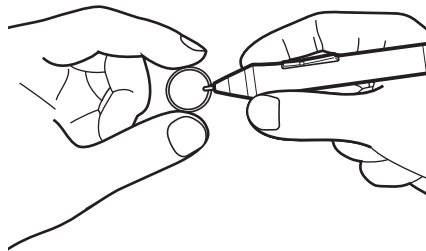

Warning

Choking hazard. Prevent children from swallowing the pen nib or side switch. The pen nib or side switch may accidentally be pulled out if children are biting on them.

For replacement parts, see [ordering parts and accessories](#).

Important:

- When not in use, place the pen in the pen case or pen stand, or lay it flat on your desk.
- When the optional Airbrush is not in use, lay it flat on your desk.
- To maintain the sensitivity of your input tools, do not store them in a container where they will rest on their tip or eraser. Improper storage may damage the pen tip pressure sensor(s).





OTHER USEFUL INFORMATION

This section includes instructions on how to manage your Cintiq preferences, uninstall the product software, and more.

[Uninstalling Cintiq](#)

[Managing preferences](#)

[Installing multiple tablets](#)

[Using applications integrated for tablet control](#)

[Importing expert settings](#)

[Pen and digital ink capabilities in Windows](#)

[Product information](#)

[Ordering parts and accessories](#)





UNINSTALLING CINTIQ

Follow the appropriate procedure below to remove the Wacom driver software and the Cintiq from your system.

Important: When you remove the Wacom driver software, your Cintiq will no longer operate with full tablet functionality but will continue to function as a mouse device.

Windows 8:

1. From the Windows 8 Start screen, right-click in the screen's bottom left corner and chose CONTROL PANEL from the pop-up menu. If you are using the Windows 8 Classic Desktop, press the Windows key on your keyboard, or select the Windows icon in the Charms bar, to access the Start screen.
2. Choose UNINSTALL A PROGRAM or ADD OR REMOVE PROGRAMS.
3. Select WACOM TABLET and click on the REMOVE button.

Windows 7:

1. Click START and choose CONTROL PANEL.
2. Click UNINSTALL A PROGRAM or ADD OR REMOVE PROGRAMS.
3. Select WACOM TABLET and click on the REMOVE button.

Note: You may need to reboot your computer for the uninstall to take effect.

Mac:

1. From the GO menu, choose APPLICATIONS and open the WACOM TABLET folder.
2. Double-click on the WACOM TABLET UTILITY icon. Click on the TABLET SOFTWARE: REMOVE button. Enter your administrator log on name and password.
3. After the removal is completed, click OK.
4. Shut down your computer and turn off the Cintiq. When your computer and Cintiq are off, disconnect the Cintiq from your computer.

See [obtaining software updates](#) for information on downloading a new software driver (when available) from the Internet.





MANAGING PREFERENCES

Use the Wacom Tablet preferences utility to manage your Cintiq preferences for single or multiple users.

Close any open applications.

Windows 8: From the Windows 8 Start screen, click the WACOM TABLET PREFERENCE FILE UTILITY tile. If you are using the Windows 8 Classic Desktop, press the Windows key on your keyboard, or select the Windows icon in the Charms bar, to access the Start screen.

Windows 7:

1. Click the START icon and select ALL PROGRAMS.
2. Select WACOM and WACOM TABLET PREFERENCE FILE UTILITY.

Set your preferences in all Windows systems as follows:

- To remove preferences for the current user, click REMOVE under MY PREFERENCES.
- To delete preferences for multiple users, click REMOVE under ALL USER PREFERENCES. Administrator rights are required to delete preferences for all users. Relaunch any currently open tablet-aware applications that you may be running.
- To back up your preferences, click BACKUP... under MY PREFERENCES.
- To restore preferences that you had previously backed up, click RESTORE... under MY PREFERENCES.
- Carefully follow any prompts that may appear.

Mac: Open the main APPLICATIONS folder. Then open the WACOM TABLET folder and run the WACOM TABLET UTILITY.

- To remove preferences, select CURRENT USER or ALL USERS. Then click REMOVE. Log out, then log back in. When the software driver loads it will create a new preferences file with the factory defaults.
- To back up your preferences, select CURRENT USER or ALL USERS. Then click BACKUP....
- To restore preferences that you had previously backed up, select CURRENT USER or ALL USERS. Then click RESTORE....
- Carefully follow any prompts that may appear.





INSTALLING MULTIPLE TABLETS

Any Cintiq or tablet that has been detected on your system will appear as an icon within the Wacom Tablet control panel TABLET list.

Select a pen display or tablet icon for which to customize tool and application settings.

- The control panel will not launch unless a supported pen display or tablet is connected to the computer.
- Settings can only be viewed or changed for an attached pen display or tablet.

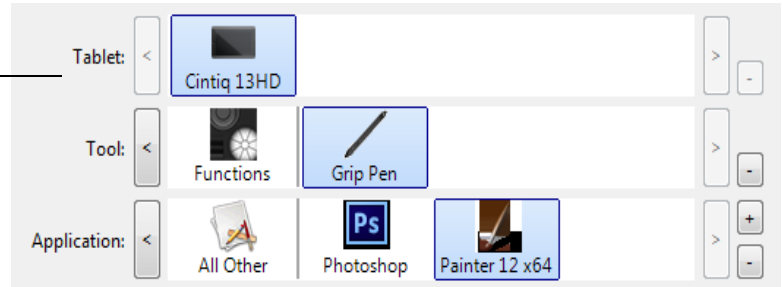

To add a new pen display or tablet, connect it to your computer. The system will automatically find the pen display or tablet and initialize it. An icon for the pen display or tablet will then appear in the control panel.

Important: When installing additional pen display units or tablets on Windows systems, the eraser function may not work in some applications when using the additional pen display(s) or tablet(s). The eraser function will continue to work correctly using the first pen display or tablet that was added to the control panel.

To remove one of multiple pen displays or tablets from the driver, select the pen display or tablet to be deleted and click on the [-] button next to the TABLET list.

- A pen display or tablet must be attached to the computer before it can be deleted from the control panel list.
- You will need to restart your computer before you can again add the tablet to the driver.





USING APPLICATIONS INTEGRATED FOR TABLET CONTROL

Some software applications may be designed to directly control ExpressKey or Rocker Ring functions. When working in an application that has been integrated in this manner, the ExpressKeys or Rocker Ring may perform differently than the function that is set in the Wacom Tablet control panel.

- When an ExpressKey is overridden by an application, the ExpressKey setting will automatically update, using either “Application Defined” or the new function name. Some or all of the ExpressKeys or Rocker Ring, or Home Button may be overridden, depending on the application.
- An integrated application will control the ExpressKeys, Rocker Ring or Home Button only when that application is active and in the foreground. When you close the application or select a new application pane to work in, your Wacom Tablet control panel settings are returned to their previous state.
- To review ExpressKey, Rocker Ring, Home Button or pen function settings for the current front-most application, set an ExpressKey to SETTINGS and press the key at any time.

Applications that have been integrated in this manner will typically provide you with the opportunity to opt-out or disable this functionality when first using your Wacom product with the application. See the documentation provided with your application for any specific details on functionality and how to customize or disable this feature.

If an automatic prompt or the application’s documentation do not describe how to disable this behavior, you can use the Wacom Tablet control panel to create [application-specific settings](#) that will override the behavior of the integrated application. See also [managing preferences](#).

Important: If an application-specific setting has been created for an integrated application, setting an ExpressKey function to APPLICATION DEFINED will still allow the integrated application to control the function.





IMPORTING EXPERT SETTINGS

The import expert settings feature enables you to import customized Wacom Tablet control panel settings that have been specified in an XML (Extensible Markup Language) file.

- Some software developers may create custom settings files which are specifically designed to provide optimum performance when using your Wacom product with their applications.
- Visit the Wacom website for your region to choose from a variety of custom settings files that may be available for your product.
- Each XML file may include customized settings for one or more applications. These settings may apply to the ExpressKeys or Rocker Ring, Home Button, Radial Menu, or pen button and eraser functions.

To import expert settings:

1. Choose an XML file with settings for use with a particular application. Double-click on your file selection.
2. Carefully read and follow the instructions in the confirmation dialog.
 - The utility will import settings for one or more applications. Any previous settings for those applications may be overridden.
 - You are encouraged to back up any existing control panel settings before importing the expert settings.
 - You can cancel, or continue to import the settings.
3. When you choose to import settings, only the settings specified in the XML file will be imported. Any corresponding settings will be overridden with the new values. All other existing settings will remain unchanged.
4. After the import process is completed you will have an opportunity to view the new settings within the Wacom Tablet control panel.





PEN AND DIGITAL INK CAPABILITIES IN WINDOWS

Microsoft Windows 8 and Windows 7 provide extensive support for pen input. Pen features are supported in all versions of Windows 8 and Windows 7 except Windows 7 Starter and Home Basic. Use Cintiq and your Wacom pen for quick, intuitive results.

- **Note taking.** Jot notes and capture quick sketches in Windows Journal. Use the Journal search engine to locate your handwritten content.
- **Handwriting recognition.** Quickly enter handwritten information anywhere the computer accepts typed input. Convert your handwritten content to typed text at any time.
- **Digital Ink in Microsoft Office 2007.** Utilize the enhanced digital mark-up and inking tools found on the REVIEW tab within applicable applications.

The Windows Input Panel enables you to use handwriting or an on-screen keyboard to directly enter text with your Wacom pen.

There are different ways to launch the Input Panel:

- Click on the Input Panel icon which appears when you move the screen cursor into a text entry area.
- Click on the Input Panel tab, located by default on the left edge of the screen.
- Click on the Tablet PC Input Panel icon located on the Windows Taskbar. If the icon is not visible, right-click on the Taskbar, select TOOLBARS, and TABLET PC INPUT PANEL.

To disable the Input Panel:

1. Open the Tablet PC Input Panel.
2. Select TOOLS and OPTIONS.
3. Choose the OPENING tab and uncheck the following boxes:
 - FOR TABLET PEN INPUT, SHOW THE ICON NEXT TO THE TEXT BOX
 - SHOW THE INPUT PANEL TAB.
4. Click OK.

For details, study the documentation that came with your system, including the Windows training tools and Tablet PC tutorial. To access the Tablet PC Pen Training, from the START menu choose ALL PROGRAMS, TABLET PC, and TABLET PC PEN TRAINING. Search the Windows help system for training tools if they are not available from the START menu.





Search the Microsoft website for enhanced information about digital inking in Windows. You can also visit the Wacom website at www.wacom.com and search digital inking in Windows.

Note: The following workaround in the Wacom software driver improves performance in Windows 7:

- To improve performance, the Pen Flicks and 'press-and-hold-to-right-click' features are disabled in some graphics applications such as Photoshop.

PRODUCT INFORMATION

To learn more about your Cintiq, visit the Wacom website for your region. You can also discover which software applications are currently tablet enhanced to support the pressure sensitivity and other special functionality of your Cintiq by searching software applications.

USA, Canada, Central and South America	http://www.wacom.com
Europe, Middle East and Africa	http://www.wacom.eu
Japan	http://wacom.jp
Asia Pacific (English)	http://www.wacom.asia
China (Simplified Chinese)	http://www.wacom.com.cn
Hong Kong (Traditional Chinese)	http://www.wacom.com.hk
Korea	http://www.wacom.asia/kr
Taiwan	http://www.wacom.asia/tw
Thailand	http://www.wacom.asia/th

PRODUCT SPECIFICATIONS

Specifications for your Cintiq are provided in the Important Product Information (IPI) document included on your product CD.





WARRANTY SERVICE IN THE U.S.A. AND CANADA

The full product warranty and licensing agreement is provided in the Important Product Information (IPI) document that is included on your product CD.

To obtain Warranty service within the U.S. or Canada contact:

Wacom Customer Care Center

Phone: 1.360.896.9833

Email Inquiry form: <http://www.wacom.com/support/email.cfm>

WARRANTY SERVICE OUTSIDE OF THE U.S.A. AND CANADA

For products purchased or used outside the United States and Canada, the warranty period may be determined by regional requirements. The warranty period for your pen display is described on the Support page of the Wacom web site for your region, or contact Wacom Technical Support.

Wacom Technical Support in Asia Pacific (except Japan and China)

Detailed Asia Pacific Limited Warranty policy and product registration may be found online at <http://www.wacom-asia.com>.

To obtain technical support or Warranty service within Southeast Asia, Oceania and Taiwan, please contact the Wacom Customer Support Service.

Phone numbers can be found here: <http://www.wacom-asia.com/support/contact>.

Should you have any questions about this Agreement, or if you desire to contact Wacom for any reason, please contact in writing:

IN NORTH AND SOUTH AMERICA CONTACT:

Wacom Technology Corporation
1311 SE Cardinal Court
Vancouver, Washington 98683
U.S.A.

IN JAPAN CONTACT:

Wacom Co., Ltd.
2-510-1 Toyonodai
Otone-Machi, Kitasaitama-Gun
Saitama, 349-1148
Japan

IN ASIA PACIFIC CONTACT:

Wacom Co., Ltd.
Asia Pacific Office
Harmony Tower 18F, 1-32-2 Hon-Cho,
Nakano-Ku, Tokyo 164-0012
Japan

IN MAINLAND CHINA (EXCEPT HONG KONG) CONTACT:

Wacom China Corporation
Unit 2807, 28th Floor, SK Tower
No 6 Jia, Jianguomenwai Avenue,
Beijing, 100022, China
E-mail: support@wacom.com.cn





ORDERING PARTS AND ACCESSORIES

For a list of available parts and accessories, visit the Wacom website for your region.

You can also do the following:

- In the USA or Canada, call 1.888.884.1870 (toll-free) or visit Wacom's website at <http://direct.wacom.com> (USA only).
- In Europe, call +49 (0)180.500.03.75 or send an email to spareparts@wacom.eu. Or, visit <http://shop.wacom.eu>. You can also contact your local dealer, distributor, or technical support using the appropriate number for your region.
- In Australia, Singapore, Taiwan and Korea, please visit: www.BuyWacom.com.au, www.BuyWacom.com.sg, www.BuyWacom.com.tw and www.BuyWacom.co.kr, respectively.
- In other countries, please contact your local dealer or distributor.

Some parts and accessories may not be available in all regions.





GLOSSARY

Active area. The area of the Cintiq where your tools are detected.

Application-specific settings. Cintiq tool and Cintiq settings that have been customized for individual applications. The Wacom Tablet control panel enables you to customize a tool to behave uniquely in different applications. [Application-specific settings](#) are in effect whenever you use the application.

Aspect. The ratio between the vertical and horizontal dimension of the active area on the Cintiq.

Click force. The amount of force you must apply to the pen tip for a click to occur.

Double-click assist. A function of the Wacom Tablet control panel that makes it easier to double-click by setting the size of the double-click distance.

Double-click distance. The maximum distance (in screen pixels) that the screen cursor can move between clicks and still be accepted as a double-click. Increasing the double-click distance makes double-clicking easier, but may cause a delay in brush strokes in some graphics applications.

Eraser-aware application. A software application that has built-in support for the pen eraser. These applications take advantage of the eraser in different ways, depending on what makes sense for the application.

ExpressKeys. The customizable control keys located on the Cintiq. See [using the ExpressKeys](#).

Fingerwheel. The control wheel on the optional Airbrush.

Hardware control buttons. The function buttons on the Cintiq. See [using the expresskeys, rocker ring and home button](#).

Journal. A Microsoft Windows application that electronically simulates a physical journal pad, but with the advantages of digital note taking. For example, you can create quick sketches and jot handwritten notes that can be converted to text and sent on to colleagues for digital mark-up. Journal includes a variety of pen, marker, and highlighter tools, plus an eraser that is easily activated by the eraser end of your Wacom pen. Additionally, your handwritten content is searchable within Journal.

LED. Light-Emitting Diode. Used as pen display indicator light(s).

Modifier. Modifier keys include SHIFT, ALT, and CTRL for Windows, or SHIFT, CONTROL, COMMAND, and OPTION for Mac. You can customize your Cintiq tool buttons or ExpressKeys to simulate a modifier key.

Mouse acceleration. A setting that allows you to adjust the screen cursor acceleration when using mouse mode.

Mouse mode. A method for positioning the screen cursor. When you place a Cintiq tool on the tablet, you can move the screen cursor with a “pick up and slide” motion similar to using a traditional mouse. This is known as relative positioning. See also [pen mode](#).

Nib. The replaceable pen tip.

Parallax. The angular distortion of an object’s position when viewed through glass or other medium. You must calibrate the Cintiq to compensate for this effect, and to align the screen cursor with the position of the pen on the screen.



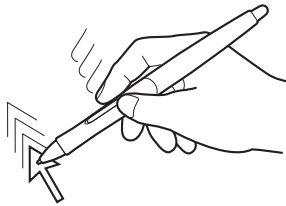

No parallax. The pen tip and screen cursor are aligned.

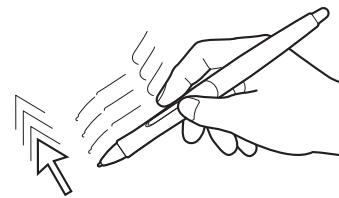

Parallax effect caused by screen glass. Note how the position of the pen tip and screen cursor are not aligned.

Pen mode. A method of positioning the screen cursor. Wherever you place your input tool on the Cintiq, the screen cursor will jump to the corresponding point on the screen. This is known as absolute positioning, and is the default setting for the pen. Pen mode allows you to quickly position the screen cursor without having to first find it and then move it across the desktop. See also [mouse mode](#).

Pixel. The smallest unit of measure on your screen.

Pressure sensitive. A quality of the Wacom pen tip and eraser that senses the amount of pressure being applied. This is used to create natural-looking pen, brush, and eraser strokes in applications that are pressure sensitive.

Pressure-sensitive application. Any application that supports pressure-sensitive input.

Proximity. The height above the Cintiq [active area](#) where the input tools are detected. See also [pen features](#).

Radial Menu. A hierarchical menu (in radial format). Each level of the menu consists of eight menu slices which may contain various features and options to choose from. You can customize the buttons of your input tools or Cintiq to display this menu.

Screen cursor. The pointer on the screen. Screen cursors come in different shapes (such as an I-beam, arrow, or box), depending on which application you are running.

Tablet PC Input Panel (TIP). The Microsoft Windows Tablet PC Input Panel enables you to use your Wacom pen to create handwritten notes or work with an on-screen keyboard. The Input Panel dynamically converts your handwriting to text. The information you create can then be inserted into other documents, spreadsheets, or illustrations.

Tilt sensitive. A quality of the pen tip and eraser that senses the amount of tilt between the tool and tablet. This is used to create natural-looking pen, brush, and eraser strokes in applications that are tilt sensitive.

USB. Universal Serial Bus. A hardware interface standard for connecting computer peripheral devices. USB ports support hot-plugging, which allows you to connect or disconnect a USB device without turning off your computer.

Wintab. An interface standard used by Windows applications for receiving tablet information. Cintiq supports all Wintab-compatible applications under Windows.





INDEX

About the manual	5	manage settings	29
Accessories		opening	29
ordering	82	overview	30
Adding a new tool	52	tabs	32
Applications, integrated for tablet control	77	Controls, testing	56
Application-specific settings		Customizing	28
changing settings	52	eraser feel	36
creating	51	ExpressKeys	39
removing	52	pen	34
working with	50	pen display functions	32
Auto-sync	25	Radial Menu	48
Button functions	41	Rocker Ring and Home Button	40
Calibrating, pen display	33	tilt sensitivity	38
Care and maintenance	71	tool buttons	37
Cintiq		Digital ink, capabilities in Windows	79
about	8	Display Toggle, working with	49
adjusting display	25	Double-click, adjusting	35
caring for	71	Dragging, with pen	22
Control Panel overview	30	Eraser feel, customizing	36
customizing	28	Eraser pressure setting, advanced	36
features	14	Ergonomics	17
front view	15	Expert settings, importing	78
incline, adjusting	7	ExpressKeys	
installation	9	using	24
hardware	10	Factory presets	25
locating	7	FAQs (Frequently Asked Questions)	69
overview	8	Front view, Cintiq	15
pen features	16	Functions, button	41
setting up	9	General problems	59
software installation	13	General problems, troubleshooting	61
testing	55	Glossary	83
troubleshooting	54	Handedness, configuring for	19
uninstalling	74	Hardware installation	10
working with	17	Home Button	24, 40
Cintiq stand		Incline, adjusting	7
adjusting incline	7	Information, product	80
Cleaning		Input tools, testing	56
display stand	71	Installation	9
pen	71	software	13
pen display	71	Mac-specific problems, troubleshooting	66
Clicking, with pen	21	Maintenance and care	71
Control panel		Manual, about	5
lists	32	Monitors, using Cintiq with others	25





Multiple tablets, installing	76	updates	68
Multiple tools, working with	52	Specifications	
New tool, adding	52	product	80
Ordering, parts and accessories	82	System requirements	9
Parts		Tablet, renaming in Tablet list	53
ordering	82	Technical support, options	68
Pen	16	Testing	
clicking with	21	Cintiq	55
customizing	34	controls	56
dragging with	22	ExpressKeys, Rocker Ring and Home Button	57
eraser	16	input tools	56
erasing, with	23	pen	57
holding	20	Tilt	
nib, replacing	72	drawing with	23
positioning with	21	sensitivity, customizing	38
pressure sensitivity, working with	22	Tip feel, adjusting	35
side switch	16	Tip pressure setting, advanced	36
testing	57	Tool buttons, customizing	37
tilt, drawing with	23	Troubleshooting	54, 59
tip	16	general problems	61
using	19	Mac-specific problems	66
using side switch	22	tablet portion	61
Pen display		testing controls	56
calibrating	33	testing input tools	56
configuring handedness	19	Windows-specific problems	65
customizing functions	32	Uninstalling	74
installation	9	User settings	25
setting up	9	Using	
Pen nib, replacing	72	ExpressKeys, Rocker Ring and Home Button	24
Pens, optional	34	pen	19
Positioning, with pen	21	Wacom display settings	25
Power saving	27	Warranty	81
Preferences, managing	75	Windows-specific problems, troubleshooting	65
Pressure sensitivity, working with	22	Work area, setting up	17
Product information	80		
Radial Menu			
customizing	48		
using	48		
Requirements, system	9		
Rocker Ring	24		
Setting up	9		
Settings			
changing for specific application and tool	52		
removing	52		
user	25		
Settings and Express View	29		
Side switch, using	22		
Software			
installation	13		





WACOM INTERNATIONAL OFFICES

WACOM TECHNOLOGY CORPORATION

1311 SE Cardinal Court
Vancouver, WA 98683
U.S.A.

Telephone: +1.360.896.9833

Fax: +1.360.896.9724

WACOM CO., LTD. JAPAN TABLET SALES DIVISION

Sumitomo Fudosan Shinjuku Grand Tower 31F
8-17-1 Nishi-Shinjuku, Shinjuku-ku
Tokyo 160-6131,
Japan

Internet: <http://wacom.jp>

WACOM CHINA CORPORATION

1103, Beijing IFC West Tower
No. 8 Jianguomenwai Street
Chaoyang District, Beijing, 100022
China

Internet: <http://www.wacom.com.cn>

WACOM AUSTRALIA PTY. LTD.

Unit 8, Stage 1 Cumberland Green
2-8 South Street Rydalmere
NSW 2116 Australia

Telephone: +61.2.9422.6700

Fax: +61.2.9420.2272

WACOM TAIWAN INFORMATION CO., LTD.

Suite 605, 6th floor, No. 205 Tun-Hwa North Road
Taipei, 105 Taiwan

Telephone: +886.2.2712.2675

Fax: +886.2.2712.9789

WACOM INDIA PVT. LTD.

2nd Floor, Elegance Tower
District Centre, Mathura Road
New Delhi 110025, India

Telephone: +91.11.40601200

Fax: +91.11.40601235

WACOM EUROPE GMBH

Europark Fichtenhain A9
47807 Krefeld
Germany

Internet: <http://www.wacom.eu>

WACOM CO., LTD. ASIA PACIFIC DIVISION

Sumitomo Fudosan Shinjuku Grand Tower 31F
8-17-1 Nishi-Shinjuku, Shinjuku-ku
Tokyo 160-6131,
Japan

Telephone: +81.3.5337.6709

Fax: +81.3.5337.6514

WACOM KOREA CO., LTD.

#1211, 12F, KGIT Sangam Center,
1601 Sangam-dong, Mapo-gu, Seoul 121-913, Korea

Telephone: +82.2.557.3894

Fax: +82.2.557.3895

WACOM SINGAPORE PTE. LTD.

5 Temasek Boulevard
#12-09 Suntec Tower Five
Singapore 038985

Telephone: +65.6258.8640

Fax: +65.6258.8697

WACOM HONG KONG LIMITED

Room 1201, Tai Tung Building
8 Fleming Road
Wanchai, Hong Kong

Telephone: +852.25739322

Fax: +852.25739500



Free Manuals Download Website

<http://myh66.com>

<http://usermanuals.us>

<http://www.somanuals.com>

<http://www.4manuals.cc>

<http://www.manual-lib.com>

<http://www.404manual.com>

<http://www.luxmanual.com>

<http://aubethermostatmanual.com>

Golf course search by state

<http://golfingnear.com>

Email search by domain

<http://emailbydomain.com>

Auto manuals search

<http://auto.somanuals.com>

TV manuals search

<http://tv.somanuals.com>