

Cintiq[®] 21UX

interactive pen display

Installation Guide & Hardware Manual

Model: DTK-2100



Wacom Cintiq® 21UX
Installation Guide & Hardware Manual
Version 1.0, Rev A1910
Copyright © Wacom Co., Ltd., 2010

All rights reserved. No part of this manual may be reproduced except for your express personal use. Wacom reserves the right to revise this publication without obligation to provide notification of such changes. Wacom does its best to provide current and accurate information in this manual. However, Wacom reserves the right to change any specifications and product configurations at its discretion, without prior notice and without obligation to include such changes in this manual.

The above year indicates when this manual was prepared. However, the date of release to the users of the “manual” is simultaneous with the introduction into the market of the applicable Wacom product.

DuoSwitch is a trademark, and Cintiq and Wacom are registered trademarks of Wacom Co., Ltd.

Adobe, Reader, and Photoshop are either registered trademarks or trademarks of Adobe systems Incorporated in the United States and/or other countries. Microsoft, Windows, and Vista are either registered trademarks or trademarks of Microsoft Corporation in the United States and/or other countries. Apple, the Apple logo, and Macintosh are trademarks of Apple Computer, Inc., registered in the U.S. and other countries.

Any additional company and product names mentioned in this documentation may be trademarked and/or registered as trademarks. Mention of third-party products is for informational purposes only and constitutes neither an endorsement nor a recommendation. Wacom assumes no responsibility with regard to the performance or use of these products.

ExpressKey is a registered trademark of Ginsan Industries, Inc., and is used with permission.

INTRODUCTION AND OVERVIEW

The Wacom® Cintiq® interactive pen display combines the benefits of a Liquid Crystal Display (LCD) with the control, comfort, and productivity of Wacom's cordless, battery-free pen technology. This gives you a direct pen-on-screen interface for your computer.

The basic components of your Cintiq include a Wacom pen tablet internally mounted behind a TFT color display, the Wacom Grip Pen, and a modular display stand.

This manual describes the installation and use of your Cintiq, Grip Pen, and display stand.

- See “Unpacking your Cintiq” on page 9 before setting up the Cintiq stand or unpacking the Cintiq pen display.
- The display stand allows you to easily rotate the pen display to any orientation, and to adjust the incline of the working surface. See “Setting up the Cintiq stand” on page 10 to learn more.
- To learn about the many features of your product, see “Your Cintiq interactive pen display” on page 14.
- Follow all instructions carefully when installing your product. See “Installation” on page 17.
- There are many ways to use Cintiq. See “Working with your Cintiq” on page 24 for details.
- Use the Wacom Tablet control panel to customize your pen and pen display settings. To learn more, see “Customizing” on page 34.

The following information is not included with this product: information about your specific computer hardware or operating system, or information about your application software. Your best source for this information is the set of manuals and discs that came with your hardware, operating system, or application.

Wacom's philosophy is to continually improve all of its products. As a result, engineering changes and improvements are made from time to time. Therefore, some changes, modifications, and improvements may not be covered in this document.

PRECAUTIONS ON USE AND HANDLING

To ensure the safe usage of your product, be sure to follow all instructions, cautions, and warnings found within this manual. Failure to do so could cause the loss of data or damage to your computer. Failure to do so could also void your warranty, in which case Wacom shall have no responsibility to repair or replace the product.

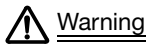

This symbol indicates an item that, if disregarded, may lead to loss of human life or serious injury.

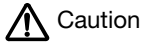

This symbol indicates an item that, if disregarded, may lead to human injury or damage to personal property.

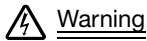

This symbol indicates an item that, if disregarded, may lead to loss of human life or serious injury.

Exercise due care and diligence whenever engaging in a described action.

PHYSICAL LOCATION

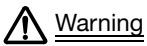

The interactive pen display is solely applicable in normal office environments but may be used also as center consoles in climate controlled environments. The product was tested by Wacom for the usage in a normal office environment only and there was no particular inspection with regards to its compatibility in medical and military application areas. In addition, the interactive pen display is neither waterproofed nor explosion-resistant. It serves and can be used solely as a passive display and input device. In all applications that are not designated for its sole usage, no information on the functionality and possible malfunctions of the interactive pen display can be supplied due to inadequate execution of tests. The adoption of the interactive pen display in other application areas than normal office environments is at the user's risk.

ENVIRONMENT

Temperature and humidity

- Operating temperature and humidity: 5° to 35°C, 20 to 80% RH
- Storage temperature and humidity: -10° to 60°C, 20 to 90% RH

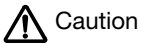

Do not use or store Cintiq where:

- Temperature changes are severe or exceed specifications (e.g., outdoors or inside a vehicle).
- The pen display, the Grip Pen, and the Cintiq stand are exposed to direct sunlight or heat from an appliance, or are exposed to water or any other kind of liquid.

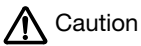

Do not use Cintiq in a dusty environment; this may damage the unit.

USAGE

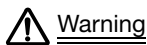

Warning

Only use a power adapter specified for use with your Cintiq. If a different type of power adapter is used, Cintiq will not work properly or may be damaged. Using a different type of power adapter also has the potential to result in fire. Use of a different power adapter will void your warranty.

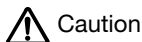

Caution

Be sure to use a grounded power source when applying power to Cintiq.



Caution

Do not connect or disconnect the video or power cables while Cintiq or your computer are turned on; this may damage the display or computer video card. In this case, Wacom shall have no responsibility to repair or replace the product.

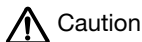

Caution

This product is for use with a DVI or VGA video card; using an inappropriate video card may damage Cintiq.

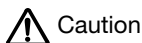

Caution

Do not block the rear panel ventilation holes; this may overheat and damage the unit.

When not using Cintiq for long periods of time, unplug the power adapter from the AC outlet.

HANDLING

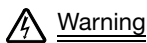

Warning

High Voltage. Do not open or disassemble the Cintiq interactive pen display. There is a risk of electrical shock when the casing is open. This will also void your warranty and Wacom shall have no responsibility to repair or replace the product.

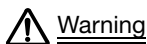

Warning

Do not operate the display stand incline adjustment levers when Cintiq is not mounted on the stand, and do not lift the stand by the adjustment levers; the stand is spring-loaded and may cause injury or damage if released without the weight of Cintiq on the stand. Improper operation may lead to physical injury or damage to the stand.

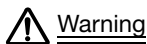

Warning

When moving Cintiq to a different location, either:

- remove the display unit from the stand and then move both items separately (see “Removing Cintiq from the display stand” on page 13),
- or use the lock screws to fix Cintiq to the stand (see “Optional display configurations” on page 61).

Before moving Cintiq, first adjust the stand to its full upright position; this will reduce the spring tension so that the stand will not accidentally release and snap shut. If the display unit is in landscape orientation, use one hand to grasp the bottom of the display and with your other hand grasp the back of the stand. Be sure to lift on both the display and the stand so that the stand will not separate from the display when moving Cintiq.

If Cintiq is in portrait orientation or has been locked to the stand with the rotation lock screws, the stand will not separate from the display unit and Cintiq can be safely lifted by grasping the display unit with both hands.

Always follow the instructions in “Removing Cintiq from the display stand” on page 13 to remove the display unit from the stand.

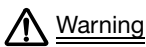

Warning

If the LCD screen has been damaged, DO NOT touch any liquid that may be leaking from it; this liquid is an irritant. In case of contact with skin, eyes, or mouth, rinse immediately with running water for at least 15 minutes or more. If contact is made with the eyes or mouth, also consult a physician.



Warning



– LAMP(S) INSIDE THIS PRODUCT CONTAIN MERCURY AND MUST BE RECYCLED OR DISPOSED OF ACCORDING TO LOCAL, STATE OR FEDERAL LAWS.

The pen display has a backlight which contains mercury (Hg). Be sure to dispose of properly, and to manage any disposal of this unit in accordance with your local ordinances and laws.

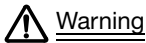

Warning

Do not disassemble the Cintiq stand. Improper disassembly could result in physical injury or damage to the stand. In this case, Wacom shall have no responsibility to repair or replace the product.

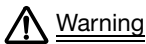

Warning

Choking hazard. Prevent children from swallowing the pen tip or side switch. The pen tip or side switch may accidentally be pulled out if children are biting on them.

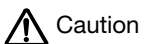

Caution

Do not disassemble the Grip Pen. This may cause the device to malfunction. In this case, Wacom shall have no responsibility to repair or replace the product.

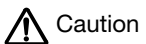

Caution

Do not scratch the display screen. Avoid placing sharp objects on the display screen surface.

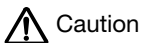

Caution

Avoid intensive shock or vibration to Cintiq, the Cintiq stand, or the Grip Pen. Hitting or dropping Cintiq may damage the display screen or other components.

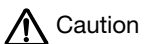

Caution

Do not put heavy articles on the pen display or push against it with a strong force; this may damage the display screen or break the Cintiq stand locking mechanism.

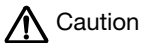

Caution

Do not place heavy articles on the pen display cabling, repeatedly bend the cables sharply, or apply heavy stress to the cable connectors; this may damage the unit or cabling.

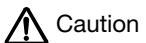

Caution

Do not store the pen display on a surface that would excessively bend or crimp the cable.

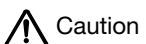

Caution

If your pen display has a coated surface, a worn pen nib that is sharp or angular may cause damage. Replace the pen tip if necessary.

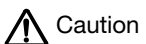

Caution

Do not use any organic solvent (e.g., alcohol) or even mild detergent to clean the display screen. Use of these cleaners can damage the display screen. Damage of this kind is not covered by the manufacturer's warranty.

- Before cleaning, always disconnect your product from the AC power source.
- To clean the display screen, use an anti-static cloth or a slightly damp cloth. When cleaning, apply only a light amount of pressure to the display screen and do not make the surface wet.
- To clean the Cintiq casing, Cintiq stand, or Grip Pen, use a soft cloth with mild detergent (such as dish washing liquid) diluted with water.

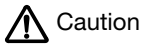

Caution

Do not expose Cintiq to high voltage electrostatic discharges or to a build-up of an electrostatic charge on the LCD screen. This may result in a temporary discoloration and blotching of the display. If discolorations occur, leave the display on and the discolorations should disappear within a few hours.



Reuse, recycling and recovery. You are urged to recycle this product when replacing it with a newer product or when it has outlived its useful life by bringing it to an appropriate collection point for recyclable materials in your community or region. By doing this, you can help improve the environment of your community as well as minimize the potential negative effects created, should any hazardous substance that may possibly be present within waste material reach the environment during the disposal process.

Within the European Union, users are required not to dispose of Waste Electrical and Electronic Equipment (WEEE) as unsorted municipal waste, according to the Directive 2002/96/EC of the European Parliament and of the Council of 27 January 2003, or the corresponding local laws of the Member States. Products for which this is applicable will be marked with the WEEE symbol shown at the beginning of this note unless this is not feasible because of the size or the function of the product. Wacom products are subject to the Directive 2002/96/EC and therefore you should always collect them separately and bring them to the appropriate collection point in your community or region.

Wacom pen display products comply with the European Union RoHS Directive 2002/95/EC (RoHS Directive).

TABLE OF CONTENTS

INTRODUCTION AND OVERVIEW1
PRECAUTIONS ON USE AND HANDLING2
Physical location2
Environment2
Usage3
Handling3
UNPACKING YOUR CINTIQ9
Setting up the Cintiq stand10
Unpacking and mounting the Cintiq pen display11
Adjusting the display incline12
Adjusting rotation13
Removing Cintiq from the display stand13
YOUR CINTIQ INTERACTIVE PEN DISPLAY14
Front view14
Rear view15
Pen features16
INSTALLATION17
System requirements17
Step 1: display installation18
Step 2: pen tablet installation22
USB cable installation22
Software installation23
WORKING WITH YOUR CINTIQ24
Setting up your work area24
Using the Grip Pen26
Holding the pen26
Positioning27
Clicking27
Dragging28
Using the side switch28
Working with pressure sensitivity28
Drawing with tilt28
Erasing28
Using the pen holder29
Pen display controls30
Using the ExpressKeys31
Using the Touch Strips32

CUSTOMIZING	34
Opening the control panel	34
Learning more about Cintiq	34
Customization basics	35
Calibrating Cintiq	36
Adjusting pitch and phase (VGA only)	37
Adjusting the display	38
Factory presets, auto-sync, and user settings	38
On Screen Display (OSD) settings	38
Power saving	41
TROUBLESHOOTING	42
Testing Cintiq	42
Testing controls and input tools	44
Testing the ExpressKeys	44
Testing the Touch Strips	45
Testing a pen	46
Display troubleshooting	47
General display problems	47
VGA problems	49
Pen tablet troubleshooting	50
General problems	50
Windows-specific problems	54
Macintosh-specific problems	55
Technical support options	57
Obtaining driver downloads	58
APPENDIX	59
Caring for Cintiq	59
Replacing the pen tip	60
Optional display configurations	61
Using an alternate mount or stand	62
Pen and digital ink capabilities in Windows	65
About the Windows Tablet PC Input Panel	66
Uninstalling Cintiq	67
Product specifications	68
General specifications	68
Display	69
Pen tablet	70
Display stand	70
Power adapter	70
Grip pen (Model KP-501E-01)	70
Product information	71

Ordering parts and accessories71
Available parts and accessories72
Radio and television interference74
FCC notice74
Industry Canada (Canada only)75
CE declaration75
Warranty (Worldwide, except for Europe, Africa and Middle East)76
Limited Warranty76
Warranty Service in the U.S.A. and Canada77
Warranty Service Outside of the U.S.A. and Canada77
Licence warranty conditions (Europe, Africa and Middle East)78
Software Licence Agreement78
Limited Warranty79
Cintiq exchange policy (Europe, Africa and Middle East)81
GLOSSARY82
INDEX84

UNPACKING YOUR CINTIQ

Carefully unpack and place all items on a stable surface. Verify that contents are complete. The product parts and accessories are packed together in the accessories box. To avoid damage, see the instructions on the following pages before setting up and using Cintiq or the Cintiq stand.

Cintiq interactive pen display,
with attached cabling

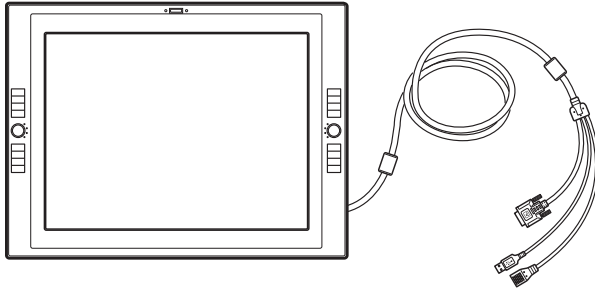

Cintiq stand (MST-A155)
*Patented

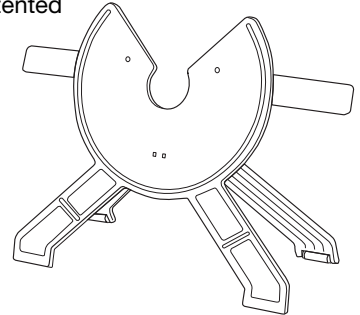

Pen stand, includes replacement nibs and
nib extraction tool (PST-A042-02)

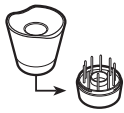

Grip Pen, pen personalization rings
(KP-501E-01, FUZ-A157)



Rotation lock screws, qty 2 (MNE-A185)

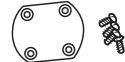

Bearing hub recess cover plate and
screws (PPL-A274 and MNE-A186)

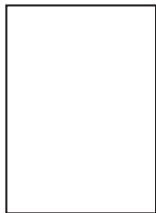

User's manual (this manual)

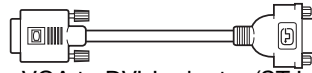

VGA to DVI-I adapter (STJ-A291)



DVI-D to DVI-I adapter (STJ-A292)

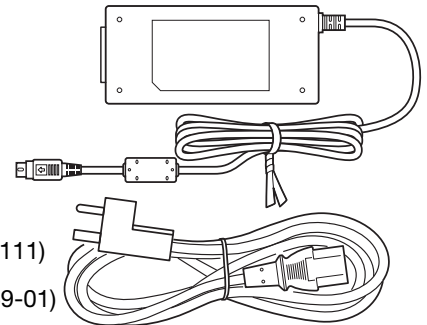

Power supply (POW-A111)
and
power cable (SCD-A069-01)

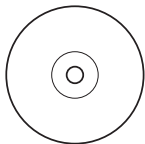

Installation CD

Note: Some configurations may include additional CDs or DVDs containing application software. To install, see the instructions for those CDs or DVDs. Retain the package box for use when storing or shipping Cintiq.

Next step: Set up the Cintiq stand. See page 10.

SETTING UP THE CINTIQ STAND

Place the stand on your desktop or work surface. Make sure the stand is stable and will not tip or fall when the pen display is mounted on it. Then familiarize yourself with the stand components.

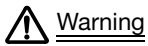

Warning

Do not operate the incline adjustment levers when Cintiq is not mounted on the stand, and do not lift the stand by the adjustment levers. The stand is spring-loaded and may cause injury or damage if released without the weight of Cintiq on the stand. Improper operation may lead to physical injury or damage to the stand. Be careful to avoid catching your finger in the gap of the movable portion of the stand.

Incline adjustment levers

When Cintiq is mounted on the stand, use these levers to adjust the display incline, as described in "Adjusting the display incline" on page 12.

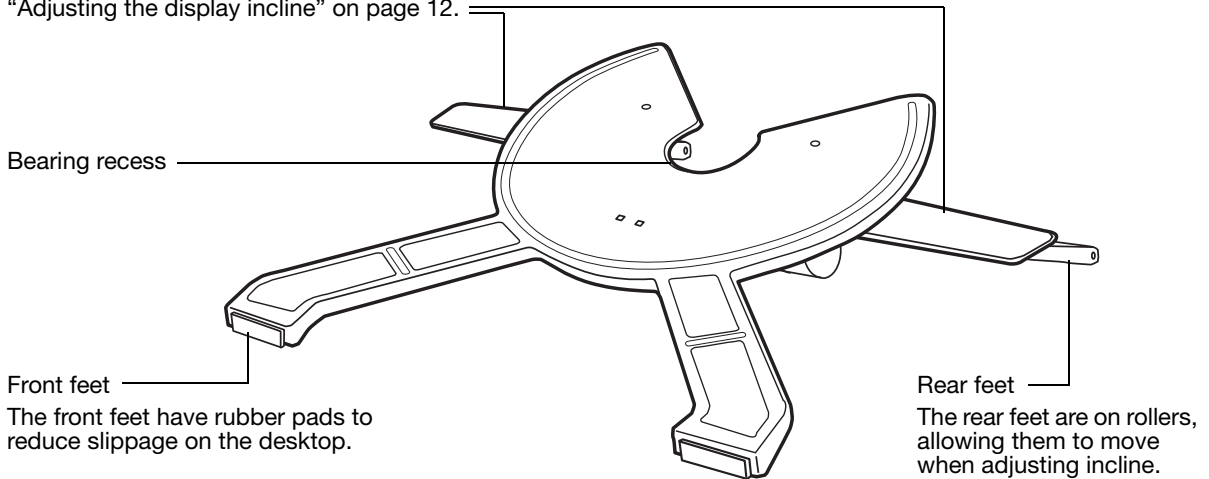

Next step: Unpack the pen display and mount it on the Cintiq stand. See page 11.

UNPACKING AND MOUNTING THE CINTIQ PEN DISPLAY

Remove any packing materials from the back of the display unit and cabling.

Mount Cintiq on the stand:

- Make sure the stand is placed in a stable position on your desktop or other work surface so that it will not tip or fall when Cintiq is mounted on it. Securely grasp Cintiq with both hands; the display should face toward you, with the power switch and LEDs located at the top.
- Align Cintiq parallel to the front of the stand so the bearing hub is located between the V-shaped upper edges of the stand's bearing recess. The V-shaped edges will serve as a guide for positioning the bearing hub. See – A – below.
- With the back of Cintiq resting against the stand, lower Cintiq until the bearing hub rests securely in the bearing recess. See – B – on the following page. The display unit will be held in place by gravity; there will be no audible 'snap' to indicate a mechanical lock.

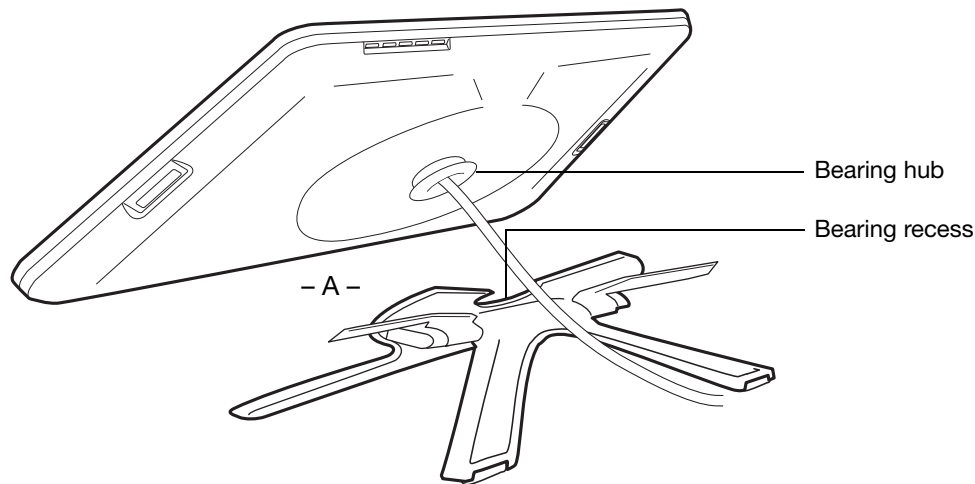

If you do not need to rotate the Cintiq pen display, you can secure it to the stand with the rotation lock screws. See “Optional display configurations” on page 61.

To learn about other mounting options, see “Using an alternate mount or stand” on page 62.

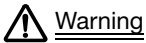

Warning

When operating the incline adjustment levers, Cintiq must be mounted on the stand with the stand feet resting on a stable, flat surface. The stand is spring-loaded and can snap back quickly, causing injury or damage if not operated properly.

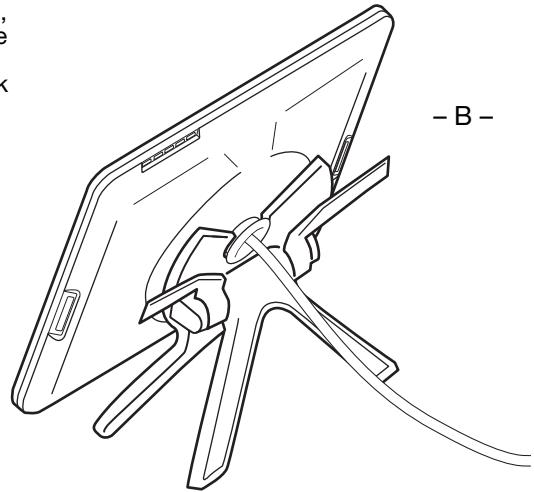

After the display unit has been mounted on the stand, remove the foam blocks that lock the adjustment levers in place. Save these blocks with the other packaging materials; you will need them if in the future you want to ship Cintiq.

ADJUSTING THE DISPLAY INCLINE

To adjust the display incline, face the front of the Cintiq pen display and grasp it on the left and right side at approximately the same height as the Cintiq stand adjustment levers. Use your fingertips to gently pull the incline adjustment levers toward the display unit; this will release the stand's clutch mechanism. Tilt the display to adjust the incline setting.

- To lower Cintiq, pull the left incline adjustment lever toward Cintiq and gently lower Cintiq to the desired incline angle. Release the lever to lock the stand in place.
- To raise Cintiq, pull the right incline adjustment lever toward Cintiq and gently raise Cintiq to the desired incline angle. Release the lever to lock the stand in place.

Note: The stand adjustment levers exhibit some natural play before the clutch mechanism engages. When adjusting the stand incline, set it slightly higher than you plan to work with, then lower the display to the desired position.

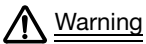

Warning

Before moving Cintiq, first adjust the stand to its full upright position; this will reduce the spring tension so the stand will not accidentally release and snap shut. If the display unit is in landscape orientation, use one hand to grasp the bottom of the display and with your other hand grasp the back of the stand. Be sure to lift on both the display and the stand so the stand will not separate from the display when moving Cintiq. If Cintiq is in portrait orientation or has been locked to the stand with the rotation lock screws (see page 61), the stand will not separate from the display unit and Cintiq can be safely lifted by grasping the display unit with both hands.

Next step: Go to page 14 and familiarize yourself with the pen display.

ADJUSTING ROTATION

To adjust rotation, grasp Cintiq by the main body and rotate the unit to the desired position; it will move on the bearing hub. Cintiq can be rotated on the display stand when the incline is less than or equal to 25 degrees. You can only rotate the pen display 180 degrees in either direction. If you do not plan to rotate the pen display, use the rotation lock screws and fasten the display to the stand in a horizontal position. See “Optional display configurations” on page 61.

REMOVING CINTIQ FROM THE DISPLAY STAND

To remove Cintiq from the display stand:

- If the rotation lock screws are attached, remove them from the back of Cintiq.
- Position the pen display to landscape orientation before removing it from the display stand. The stand will not release unless Cintiq is in landscape orientation.
- Next, raise the stand incline to the highest position. See “Adjusting the display incline” on page 12.
- Firmly grasp the pen display on both the left and right sides of the unit, and lift out of the display stand.

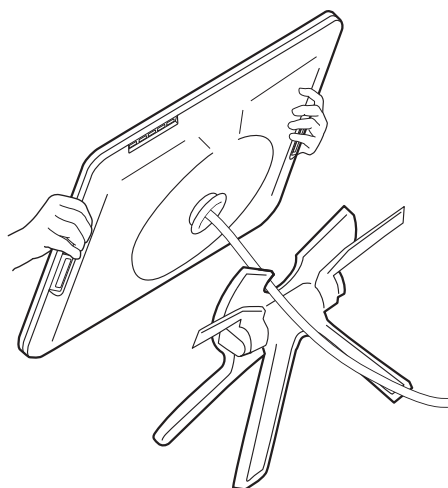

Important: When removing Cintiq from the display stand, always lift Cintiq in a direction parallel to the front of the stand. You may also need to slightly rotate Cintiq so the stand will release.

Note: When packing Cintiq for transport, first adjust the stand to its lowest position and place the foam packing blocks under the incline adjustment levers before removing Cintiq from the stand. The foam blocks will keep the stand from snapping shut while in its packaging. Always pack Cintiq and its stand in their original containers and protective cushions. Never pack Cintiq while it is mounted on the stand; this may damage the unit or stand during transport.

YOUR CINTIQ INTERACTIVE PEN DISPLAY

After the Cintiq pen display is safely mounted on the Cintiq stand, take some time to familiarize yourself with the features and components of your product.

The display and tablet sensor function as an integrated output and input device. The tablet sensor reports pen coordinates, pressure, tilt, switch, eraser, and other information.

FRONT VIEW

Status LED

Lights blue when pen is in active area of the pen display and the pen tip, eraser, or side switch are pressed.

LED will not light unless the USB cable connector is plugged into an active USB port and a video signal is present.

Power switch

Turns unit on or off.

Power LED

Lights blue when power has been supplied to Cintiq and a video signal is present.

Glow orange when no video signal is detected. (e.g., Your computer is turned off, starting up, or has entered a power management mode in which video signals are not sent.)

Touch Toggle button

ExpressKeys

Touch Toggle button

Press to toggle between Touch Strip functions. See "Pen display controls" on page 30. LEDs indicate which of the four Touch Strip functions are active.

ExpressKeys

These customizable keys simulate modifier keys, keystrokes, and other frequently used functions. A Display Toggle function is also available, enabling you to toggle the screen cursor between the Cintiq pen display and your other displays. See "Pen display controls" on page 30.

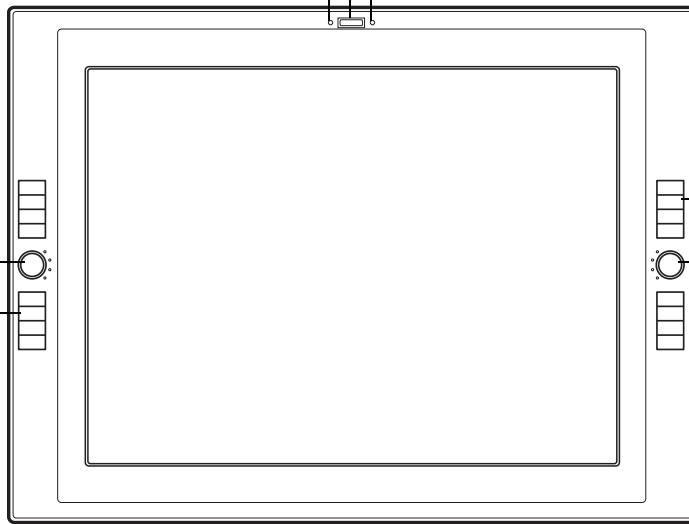

REAR VIEW

On Screen Display (OSD) controls

Use these controls to adjust a variety of display settings. See “Adjusting the display” on page 38.

Digital/Analog (DVI/VGA) switch

Set this switch for the video connection you will be using.

Bearing hub

Fits into the bearing recess on the Cintiq stand. Allows rotation of Cintiq, and easy mounting and removal from the stand.

Touch Strip

Security slot

Integrated pen holder and alternate cable exit

The pen can be stored here. If you are not using the Cintiq stand supplied with the unit, you can route the cable to exit from this location. See “Using an alternate mount or stand” on page 62.

Touch Strip

Slide your finger over the Touch Strips to zoom, scroll, or perform custom keystroke actions. See “Pen display controls” on page 30.

Pen tether attachment point

One located on each side of unit.

Cabling and connectors

The connectors on the integrated cable are for DVI-I video, USB data, and power.

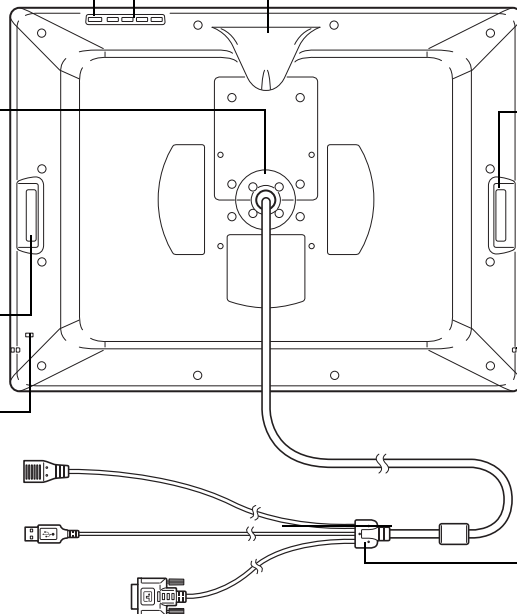

Important: Always store the interactive pen display on the Cintiq display stand or in its original packing carton when not in use. Do not store the display unit on a surface that would excessively bend or crimp the cable.

Next step: See “Installation” on page 17.

PEN FEATURES

Eraser: When brought within proximity of the pen display (5 mm (0.2 inch)), the tablet portion of the display reports the pen location. Pressure information is reported as you press down on the eraser. By default, the eraser function is set to ERASE.

DuoSwitch: Be sure the programmable switch is in a convenient location where you can toggle it with your thumb or forefinger but not accidentally press it while using the pen. You can use the switch whenever the pen tip is within proximity of the display screen surface; you do not need to touch the pen tip to the display surface. Toggle the switch in either direction to activate the button functions. By default, the upper switch is set to DOUBLE CLICK and the lower switch is set to RIGHT CLICK.

Pen tip (replaceable nib): The pen is activated as soon as it is brought within proximity (5 mm (0.2 inch)) of the pen display screen. This allows you to position the screen cursor without touching the pen tip to the display screen.

When pressure is applied to the pen tip, the pen simulates a primary mouse button click. Tip click pressure can be adjusted in the Wacom Tablet control panel.

Important: Only use a pen that is compatible with Cintiq, such as the pen that shipped with the unit, or pens from the Intuos4 product line which have a part number ending in “-01”. Other pens may not function properly. See “Available parts and accessories” on page 72. Also, the Cintiq pen tip is specifically designed for use with the Cintiq pen display. The tips on other pens could damage the Cintiq display screen.

When the pen is not in use, place it in the pen stand, the pen holder, or lay it flat on your desk. To maintain the sensitivity of your pen, do not store it in a container where it will rest on its tip or eraser.

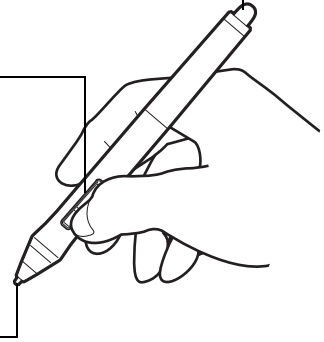

INSTALLATION

The computer treats the interactive pen display as two separate devices (the display and the pen tablet). Therefore, the installation process is completed in two stages:

- First install as a display.
- Then install as a pen tablet.

Both stages require hardware and software installations and adjustments. Carefully follow ALL instructions.

Important: You MUST install the Wacom driver software for correct pen-on-screen functionality.

SYSTEM REQUIREMENTS

Make sure your computer meets the following minimum system requirements:

- PC. Windows 7, Vista™, XP (32 and 64 bit). DVI or VGA connector, available USB port, and CD-ROM drive.
- Macintosh. OS X, v10.4 or greater. DVI or VGA connector, available USB port, and CD-ROM drive.

Cintiq supports both digital (DVI) and analog (VGA) video signals. If updating your video card, first complete the video card installation before connecting Cintiq. If you have another display that is compatible with your video card, you can use that display to verify the video card is operating correctly.

Although you can connect Cintiq to either a DVI or VGA video card, connecting to a DVI video card generally results in optimum performance.

Notes:

Cintiq can be used alone or with another display, such as a CRT monitor or LCD projector. To use Cintiq with another display, you will need two video cards or a video card with dual output.

You may be able to set up Cintiq as a mirrored, extended, or independent display. When working with more than one monitor, Cintiq will map to the monitors based upon how your system is configured. By default, if you are in mirror mode, the pen display will map to the entire space on each monitor. See your hardware and operating system documentation for details on configuring your system for use with multiple monitors.

A Display Toggle function is available for use with multiple display systems. This enables you to toggle the screen cursor between Cintiq and your other displays.

STEP 1: DISPLAY INSTALLATION

In this step, Cintiq is installed as a display on your system.

Important: Never connect or disconnect the video or power cables while your computer or pen display are powered on. This can damage the display or video card.

1. Turn off your computer.
2. If your computer has only one video connector, unplug your previous monitor or add a second video card. Determine if your computer has a digital (DVI) or analog (VGA) connector, and set the DVI/VGA switch located on the back of Cintiq for the video connection you are using. Move the switch toward the tablet edge for Digital (DVI-I or DVI-D), and move it toward the OSD buttons for Analog (VGA). See – A – in the connection diagram on page 19.
3. Making sure to tighten the connector thumbscrews, follow the below instructions for your video connector. See – B – in the connection diagram.



DVI-I connector

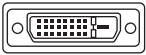

DVI-D connector



VGA connector

For DVI-I operation, plug the Cintiq video cable into the DVI-I connector of your video card.

For DVI-D operation, plug the Cintiq video cable into the DVI-D to DVI-I adapter supplied with Cintiq, and then plug the adapter into the DVI-D connector on your video card.

For VGA operation, plug the Cintiq video cable into the VGA to DVI-I adapter supplied with Cintiq, and then plug the adapter into the VGA connector on your video card.

If connecting to a Mac Mini DisplayPort, you will need to obtain an appropriate adapter. For best results the Apple Mini DisplayPort to Dual-Link DVI Adapter is recommended. Adapters can be purchased at various retail outlets and through the online Apple Store.

Connect the adapter between the Cintiq video cable and your Macintosh.

4. Connect the power adapter to Cintiq. See – C – on the next page.
5. Connect the adapter power cable and plug into an AC outlet. See – D – in the connection diagram.
6. Turn on Cintiq. The power LED will light orange.

DISPLAY CABLING DIAGRAM

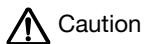
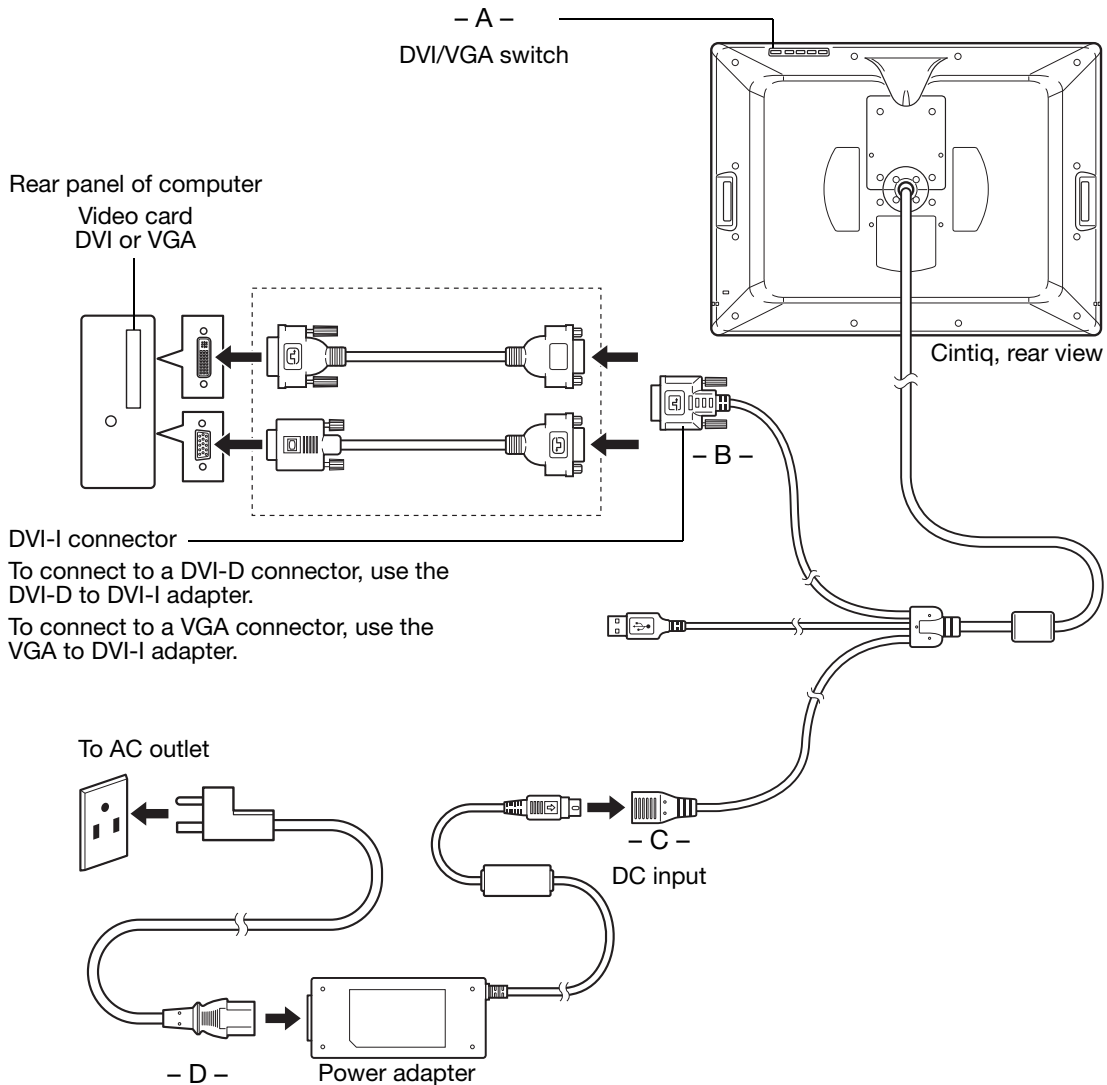

Caution

Make sure your video card has a DVI or VGA connector, and that you correctly set the Cintiq DVI/VGA switch for the video connector you are using.

Use only a power adapter specified for use with Cintiq; use of an improper power adapter may damage the unit.

Do not connect or disconnect the video or power cables while Cintiq or your computer are turned on. This can damage the display or computer video card.

Make sure the display refresh rate does not exceed the maximum vertical frequency that Cintiq can support. See the "Product specifications" on page 68 for details.

7. Next, turn on your computer.

For Windows: The interactive pen display will automatically install as a default monitor. To identify the unit as a pen display and install the color calibration profile:

A) Open the system CONTROL PANEL folder.

- For Windows 7 and Vista, under APPEARANCE AND PERSONALIZATION select ADJUST SCREEN RESOLUTION.
- For Windows XP, open the DISPLAY PROPERTIES control panel and select the SETTINGS tab.

If you have more than one monitor, click IDENTIFY MONITORS to determine which display corresponds to the pen display. Select the number corresponding to the pen display.

B) Click ADVANCED SETTINGS....

C) Select the MONITOR tab and click PROPERTIES.

D) Select the DRIVER tab and click UPDATE DRIVER... An update driver dialog or Wizard will appear.

E) Insert the Installation CD. If the Wacom Tablet installation menu displays, close it.

Windows 7 and Vista:

- Select BROWSE MY COMPUTER FOR DRIVER SOFTWARE.
- Enter the drive letter for the Installation CD and click NEXT.
- After installation is complete, close any open control panel windows.

Windows XP:

- The Wizard will ask if Windows can search for software. Choose NO, NOT THIS TIME and click NEXT.
- Select INSTALL FROM A LIST OR SPECIFIC LOCATION (ADVANCED), and click NEXT.
- Select DON'T SEARCH. I WILL CHOOSE THE DRIVER TO INSTALL and click NEXT.
- Select the pen display option and click HAVE DISK.... Enter the letter of your CD-ROM drive (e.g., E:\), and click OK.
- Follow the prompts. (If the HARDWARE INSTALLATION dialog box displays, click CONTINUE ANYWAY.) After installation is complete, click FINISH and close any open control panel windows.

For Macintosh, a color profile is added to your color management system during the driver software installation process. To activate this color profile for use with Cintiq, you may need to select the Cintiq profile in the system's ColorSync Utility control panel. For details, see the color management information in your operating system and application documentation.

8. As necessary, configure the display control panel settings for the proper size and color resolution. See the “Product specifications” on page 68 for details about the maximum (native) resolution and other resolution sizes that can be used with Cintiq. The display size and color resolution may be constrained by the capabilities of your video card.

Windows: If you are using Cintiq as a secondary display, you may first need to enable the unit in your display properties control panel.

To fine-tune the display, see “Adjusting the display” on page 38. If using analog (VGA) mode, see also “Adjusting pitch and phase (VGA only)” on page 37.

9. After the LCD monitor portion of the installation is working to your satisfaction, move on to Step 2: pen tablet installation.

For troubleshooting tips, see “Troubleshooting” on page 42.

Notes:

Each interactive pen display LCD panel is produced under very stringent quality standards. Production techniques cannot guarantee an absolutely perfect display, and some panels may exhibit a certain number of pixels that show an incorrect color. See the “Product specifications” on page 68 for more information.

If an image has fine striping (such as screen stripes), it may appear to flicker or display a moiré pattern.

Do not apply excessive pressure on the display screen surface, it may cause the appearance of a moiré or pooling pattern. If this occurs, use less pressure on the display screen when working with the pen.

When a still image is displayed for a long period of time, an after-image may remain for a short time. To prevent this, use a screen saver or other power management feature.

To extend the life of the pen display backlight, set your computer’s power management to turn off the display when it is not in use for extended periods of time.

STEP 2: PEN TABLET INSTALLATION

In this step, Cintiq is installed as a pen tablet.

USB CABLE INSTALLATION

Plug the USB connector into an available USB port on your computer or into a USB hub attached to your computer.

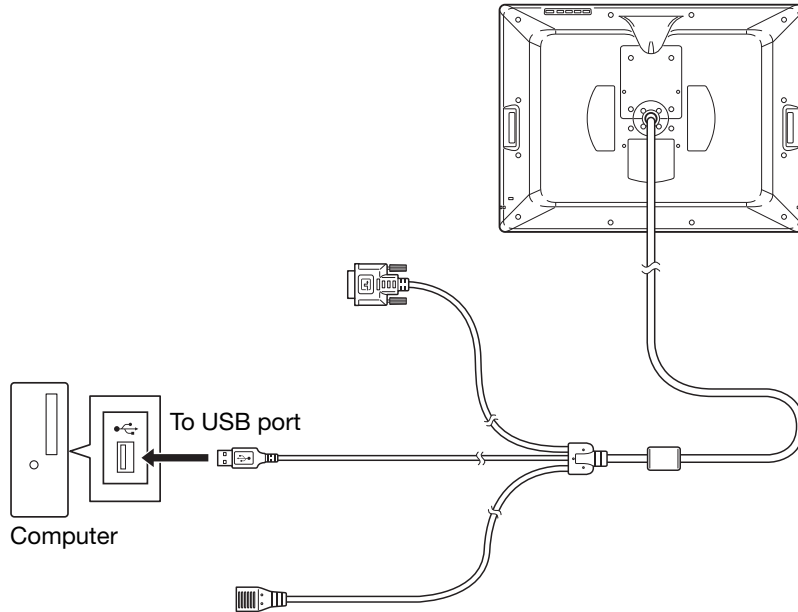

Next, install the pen tablet software. See "Software installation" on page 23.

SOFTWARE INSTALLATION

Important: You MUST install the Wacom driver software for correct pen-on-screen functionality.

Save your work and close all open applications. Temporarily disable any virus protection programs.

- Insert the Installation CD into your computer's CD-ROM drive. If the software installer menu does not automatically display, double-click on the INSTALL icon located on the CD.
- Click INSTALL TABLET and follow the prompts to install the driver software.
- Reactivate your virus protection program.
- After completing the software installation, make sure you can use your pen on the Cintiq display screen to move the screen cursor.

When you place the pen tip on the display screen, the screen cursor should immediately jump to a corresponding position approximately beneath the pen tip. Lift the pen tip and place it on the display screen surface in a different location. The screen cursor should again jump to the new position. This is known as absolute positioning, and enables you to position the screen cursor without having to drag your pen across the display screen surface.

- Be sure to check the Read Me file for updated information. If you have trouble installing Cintiq, see "Troubleshooting" on page 42.

Notes:

Driver installation automatically activates the new pen input functions available within Microsoft Windows 7, Vista, and Office 2007 or later (except for Windows 7 Starter and Home Basic, and Windows Vista Home Basic). Visit the Wacom web site at www.wacom.com/vista for additional information on using your Wacom pen in Windows.

User-specific preferences are supported. After logging in, each user can customize their personal settings in the Wacom Tablet control panel. Switching to another user will automatically load the settings for that user.

If the pen display does not respond properly or you lose cursor control, the pen display preferences may be corrupted. You can delete the current preference settings and return the pen display to its factory default condition. See the Software User's Manual for details on managing preferences.

To uninstall the software driver, see "Uninstalling Cintiq" on page 67.

Next, see "Calibrating Cintiq" on page 36 to precisely align the screen cursor to the pen tip.

WORKING WITH YOUR CINTIQ

As you work with Cintiq, you can rest your hand lightly on the display screen, just as if it were a drawing board or sheet of paper.

Because the Cintiq pen display surface will be a little higher than your desk, consider adjusting the height of your desk or chair to assure comfortable use of the device.

SETTING UP YOUR WORK AREA

The Cintiq interactive pen display and stand were designed to provide you with the widest possible range of flexibility and ergonomic work approach. The design allows you to quickly adjust Cintiq to a different position whenever the need arises. Experiment with different height and position adjustments to determine which best fits your particular working style and tasks.

To minimize fatigue, organize your work area so you can work comfortably. Position Cintiq, the pen, and your keyboard for easy access without unnecessary reaching. The pen display and any other displays should be positioned so you can view them comfortably with a minimum of eyestrain.

- Take short breaks between tasks to stretch and relax your muscles.
- Use a gentle grip when working with the pen.
- Alternate tasks throughout the day.
- Maintain a good posture at all times. Minimize awkward postures and repetitive movements that cause discomfort.
- Change your position if you feel any discomfort due to your work position.
- Alternate between different modes of use.

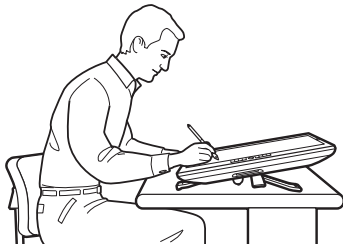

To emulate a traditional animator's table, adjust the stand to its lowest position. Cintiq can be freely rotated to any angle without touching the desktop for the greatest comfort and accuracy of stroke while drawing or editing images.



Adjustment of the stand to its highest position is common when your work requires a large amount of keyboard input. This position is also useful when presenting your work to co-workers or clients.

Note regarding RSI: Wacom makes no representation, promise or guarantee that Wacom products will cure or prevent, in whole or in part, mouse-induced repetitive stress symptoms, injuries or conditions. Individual results may vary. Always obtain competent medical advice to determine the most appropriate treatment for your specific situation.

Tips:

If the rotation lock screws are attached to the back of Cintiq, they must be removed before Cintiq can be rotated.

Before rotating the display unit, be sure the cable is freely rotating behind the unit.

Do not pull the cable out of its computer connections by accidentally moving the pen display too far from the computer.

Cintiq can also be mounted to articulated arms or other third-party stands meeting the VESA 100 specification for monitor stands. See “Using an alternate mount or stand” on page 62 for details.

Next step: If you have not already done so, learn about the basics of customizing your product for the way you like to work. See “Customizing” on page 34.

USING THE GRIP PEN

The pen is cordless, battery-free, and senses the amount of tilt and pressure you exert upon it.

HOLDING THE PEN

Hold the pen like you would a normal pen or pencil. Make sure the DuoSwitch is in a convenient location where you can toggle it with your thumb or forefinger, but not accidentally press it while drawing. As you work with Cintiq you can rest your hand lightly on the display screen. You can tilt the pen in any way that feels most comfortable.

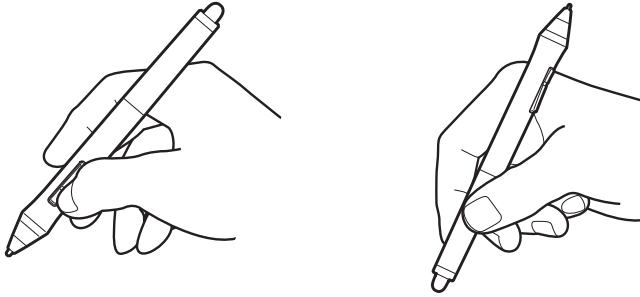

To personalize your pen, unscrew the tip cone and replace the colored ring with one of another color (included).

Refer to “Customizing” on page 34 and to the electronic Software User’s Manual for information on customizing the pen settings.

Place the pen stand within easy reach. When the pen is not in use, place it in the pen stand, the pen holder, or lay it flat on your desk. The stand allows for vertical or horizontal placement of the pen. To maintain the sensitivity of your pen, do not store it in a container where it will rest on its tip or eraser.

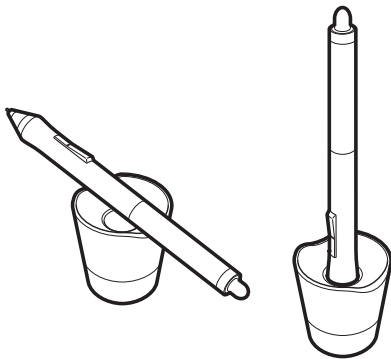

Unscrew the base of the pen stand to access a nib extraction tool and assorted replacement nibs.

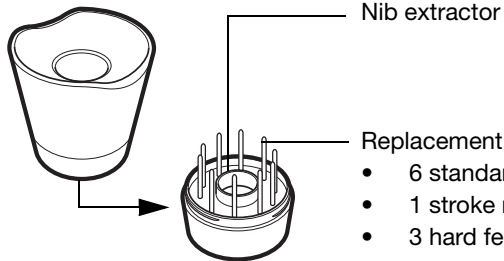

- 6 standard nibs, black
- 1 stroke nib, white
- 3 hard felt nibs, gray

POSITIONING

To position the screen cursor, move the pen slightly above the Cintiq display screen without touching the screen surface. Press the pen tip on the display screen to make a selection.

Note: You must calibrate the pen display to correctly align the screen cursor with the pen tip. (See “Calibrating Cintiq” on page 36.) If the screen cursor does not jump to a position near the pen tip when you place the pen on the display screen, then the pen display software driver may not be installed or is not loading. Install the driver software if necessary. Otherwise, see “Troubleshooting” on page 42.

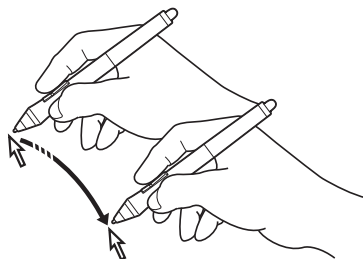

CLICKING

Tap the display screen once with the pen tip, or touch the pen to the display screen with enough pressure to register a click.

Tip: To make navigating with the pen easier, configure Windows to select when the pen is over an icon and to launch the icon with a single click. To turn on this feature, first open a folder.

For Windows 7 and Vista, from the ORGANIZE pull-down menu choose FOLDER AND SEARCH OPTIONS. From the GENERAL tab select SINGLE-CLICK TO OPEN AN ITEM (POINT TO SELECT).

For Windows XP, from the TOOLS pull-down menu choose FOLDER OPTIONS.... From the GENERAL tab select SINGLE-CLICK TO OPEN AN ITEM (POINT TO SELECT).

Press the upper side switch (when set to DOUBLE CLICK), or quickly tap the display screen twice in the same place with the pen tip. Double-clicking is easier when the pen is perpendicular to the pen display screen.

To fine-tune the double-click area, see the electronic Software User’s Manual.

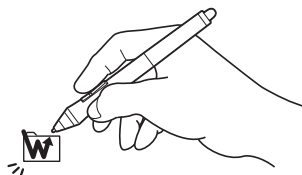
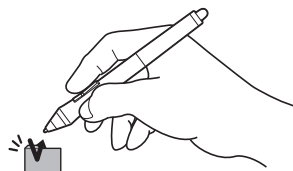

DRAGGING

Select an object, then slide the pen tip across the display screen to move the object.

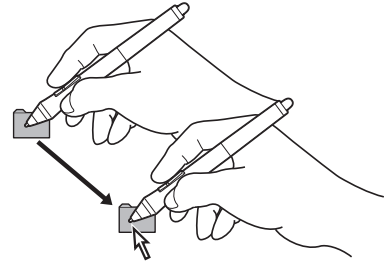

USING THE SIDE SWITCH

The pen is equipped with a DuoSwitch. This switch has two programmable functions that can be selected by rocking the switch in either direction. You can use the DuoSwitch whenever the pen tip is within proximity (5 mm (0.2 inch)) of the display screen surface. You do not need to touch the pen tip to the display surface in order to use the switch. By default, the upper switch is set to **DOUBLE CLICK**, and the lower switch is set to **RIGHT CLICK**. Switch functions can be modified or disabled using the Wacom Tablet control panel. See the electronic Software User's Manual for details.

WORKING WITH PRESSURE SENSITIVITY

The pen responds to the nuance and inflection of your hand movements, enabling you to create natural-looking pen and brush strokes within applications that support this feature. To draw and write with pressure, select a pressure-sensitive tool from your application's tool palette. As you work on the screen surface, use various amounts of downward pressure on the tip of the pen. Press lightly for thin lines or softer color. Press harder for thick lines or dense color.

DRAWING WITH TILT

The pen display recognizes when you tilt the pen from vertical to incline positions. In supporting applications, tilt can be used to control line shape and thickness.

ERASING

In supporting applications, the pen eraser works like the eraser on a pencil. In text applications, use the eraser to select text, then lift the eraser from the pen display screen to delete the text.

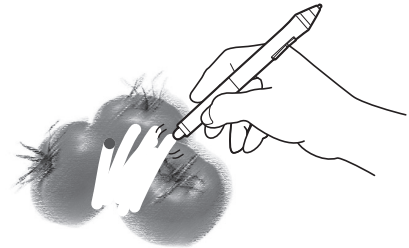

USING THE PEN HOLDER

An integrated pen holder is located at the back of the pen display. The pen holder is a handy feature for those times when it is inconvenient to use the desktop pen stand.

Note: The pen holder is not available for use when routing the cable to exit through the top cable opening.

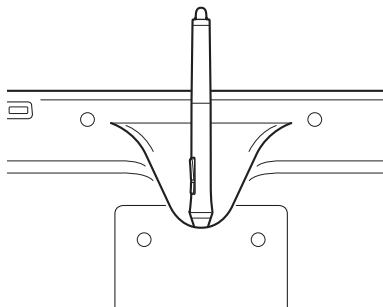

PEN DISPLAY CONTROLS

To improve your workflow in graphics or other applications, the Cintiq pen display features ExpressKeys and Touch Strips. While using the pen with your dominant hand, you can simultaneously use your other hand to operate the ExpressKeys or Touch Strip.

Touch Strips (located on back of unit, one on each side)

Slide your finger over the Touch Strip to zoom, scroll, or issue an assigned keystroke function. By default, the Touch Strips enable you to zoom in most graphics applications and to scroll in other applications. You can also set them to issue custom keystrokes. For example, you might set a Touch Strip function to change brush sizes when working in Photoshop. See “Using the Touch Strips” on page 32.

Touch Toggle button

Press to toggle between Touch Strip functions. The left button toggles the left Touch Strip functions, and the right button toggles the right Touch Strip.

LEDs indicate which of four available Touch Strip functions are active.

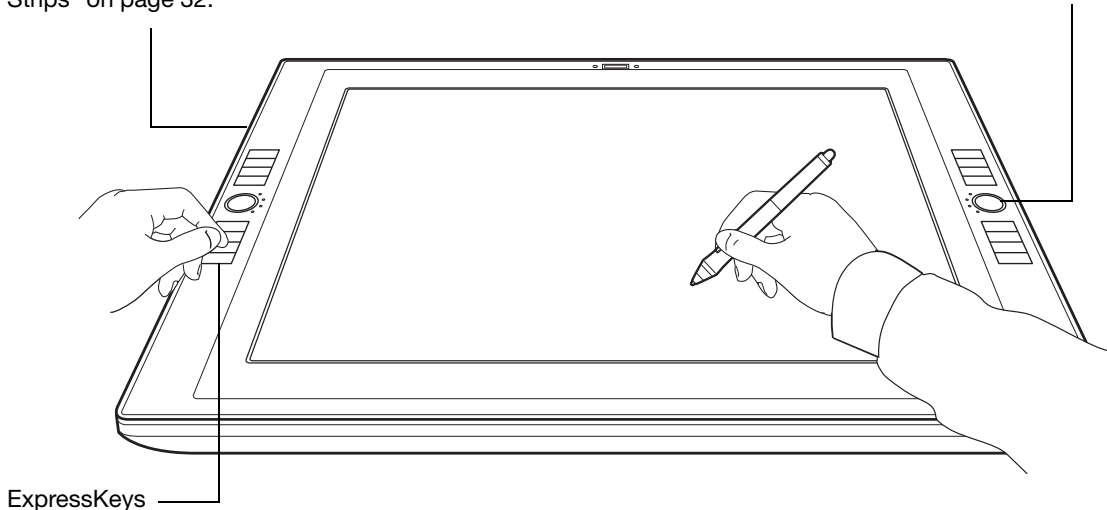

Press the customizable ExpressKeys to perform frequently used functions or keystrokes, or to emulate button clicks or modifier keys. See “Using the ExpressKeys” on page 31.

A Display Toggle function is also available for use on multiple monitor systems. This feature allows you to use your pen on the Cintiq pen display to navigate the screen cursor to any display on your system.

USING THE EXPRESSKEYS

Press individual keys to perform frequently used functions or keystrokes. ExpressKeys can also be used to modify your pen or other input tool properties as you work. The ExpressKeys can also be operated in combination with one another. For example, if you program one key to simulate the CTRL key and another to simulate an ALT keystroke, when you press both keys at the same time a CTRL+ALT is simulated.

From top to bottom, the ExpressKey default settings are as listed below. See the electronic Software User's Manual for details on other available key settings. The defaults are the same for the left- and right-side ExpressKey sets.

- **HELP.** Displays a diagram of the Cintiq ExpressKeys and Touch Strips, showing the current function settings for each control.
- **RADIAL MENU.** Displays a Radial Menu. Each level of the hierarchical menu consists of eight menu slices which may contain various features and options to choose from.
- **PRECISION MODE.** Changes the mapping around the current pen tip position such that you must move the pen twice as far for the screen cursor to cover the same distance on the display screen. To activate, press and hold the tool button to which this function has been assigned. Releasing the button returns to normal mapping.
- **DISPLAY TOGGLE.** For multiple monitor systems. Enables you to toggle the screen cursor between the Cintiq pen display and your other displays. When selected, Cintiq can be used either as a pen display (the screen cursor is positioned at the pen tip location) or as a standard Wacom tablet (the screen cursor can be moved across the entire desktop or additional displays).
- **SHIFT** modifier key.
- **CTRL/CMD** modifier key.
- **ALT/OPT** modifier key.
- **PAN/SCROLL.** Enables you to position a document or image in any direction within the active pane by pressing a button set for PAN/SCROLL and then dragging with the pen tip across the pen display screen active area.

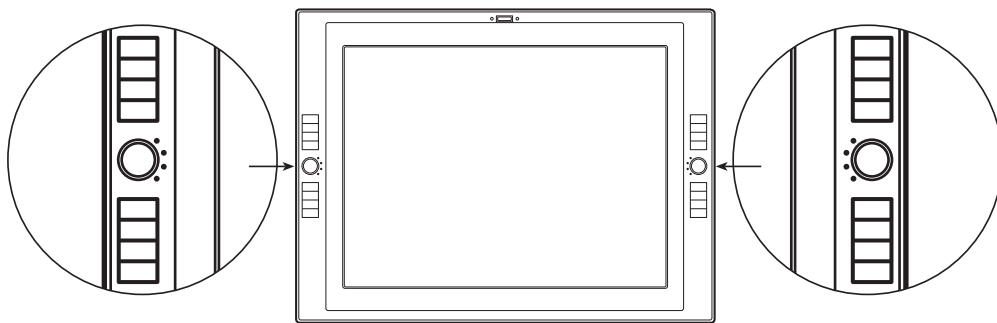

Here are a few ideas for using the ExpressKeys:

- Set a pair of keys to commonly used keystrokes, such as [and] to decrease and increase your brush size in Photoshop.
- Set a key to a commonly used keyboard shortcut in order to open files or start an application.
- If you prefer not to (or cannot) use the side switches on your Grip Pen, then set a key to right- or double-click.
- Choose from any of the other available functions.

Important: Some applications can override and control the ExpressKey functions. For details, see the section on using applications integrated for tablet control in the Software User's Manual.

USING THE TOUCH STRIPS

Slide your finger over the Touch Strip to quickly zoom in or out, scroll up or down, or perform other functions with your secondary hand while using your primary hand to work with the Grip Pen. You can also set each Touch Strip to issue custom keystrokes. For example, you might set a Touch Strip action to cycle through layers when working in Photoshop. The Touch Strips can be operated in three different ways:

- Standard operation: Slide your finger up or down to zoom, scroll, or issue an assigned keystroke function.
- Continuous operation: Press and hold your finger at either end of the Touch Strip to continuously scroll. This is useful for scrolling through long documents or web pages.
- Single step operation: Press and release your finger at either end of the Touch Strip to zoom, scroll, or issue the assigned keystroke function one step at a time.

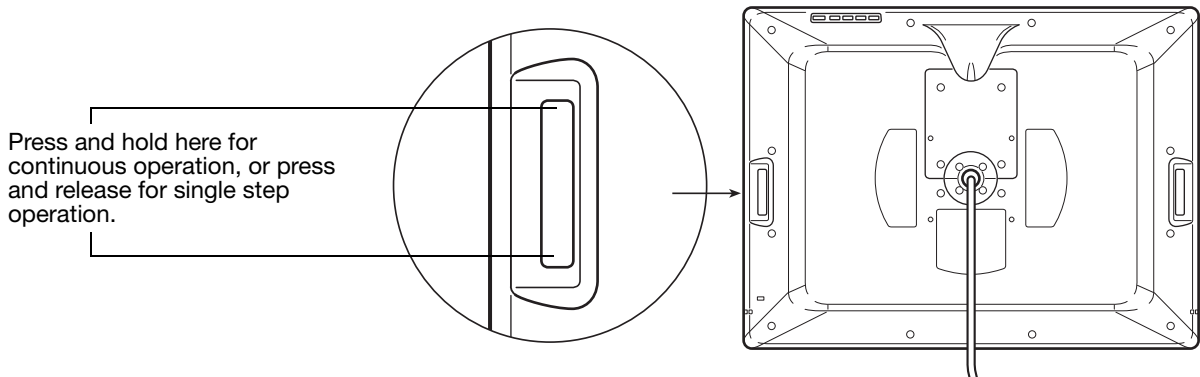

Press the Touch Toggle button (located on front of unit) to toggle between four customizable Touch Strip functions. The left button toggles the left Touch Strip functions, and the right button toggles the right Touch strip.

As you toggle between settings, a corresponding status LED illuminates. Any disabled settings are skipped in the toggle sequence.

Tip: Press an ExpressKey set to the HELP function to display a diagram of the Cintiq ExpressKeys and Touch Strips, showing the current function settings for each control.

The Touch Strip default setting states are as listed below. See the electronic Software User's Manual for details on other available settings. The defaults are the same for the left and right side Touch Strips.

- **AUTO SCROLL/ZOOM.** Sets the Touch Strip to zoom in most graphics applications and scroll in most other applications. Page scrolling is not supported. Some applications may interpret zoom events as scroll events, or may completely ignore zooming. Likewise, scroll events may be interpreted as zoom events, or ignored completely.
- **KEYSTROKE... CYCLE LAYERS.** Enables you to cycle up or down through a stack of layers when working in Adobe Photoshop. Move your finger up along the Touch Strip to cycle up through layers.
- **KEYSTROKE... BRUSH SIZE.** Sets the Touch Strip to increase or decrease the brush size of your drawing tool when working in Adobe Photoshop.
- **KEYSTROKE... CANVAS ROTATION.** Enables you to rotate or flip an entire image when working in Adobe Photoshop CS4 or later.

Important: Some applications can override and control the Touch Strip functions. For details, see the section on using applications integrated for tablet control in the Software User's Manual.

Tip: Photoshop users who frequently change brush sizes may want to assign the [and] keys to a Touch Strip. Sliding your finger up or down the Touch Strip will then change the brush size without the need to reach for the keyboard or access the Photoshop Brushes palette.

See the electronic Software User's Manual for detailed information on customizing the way your pen display Touch Strips work.

CUSTOMIZING

After mastering the basics of using your Grip Pen on the Cintiq interactive pen display, you may want to customize the way your product works. The Wacom Tablet control panel make it easy to adjust your Cintiq and pen settings.

OPENING THE CONTROL PANEL

To open the Wacom Tablet control panel, use the pen on the pen display:

Windows. Click on the Windows START button and choose ALL PROGRAMS. Then select WACOM TABLET and choose the WACOM TABLET PROPERTIES option.

Macintosh. Open SYSTEM PREFERENCES from either the Dock, the Apple menu, or from the APPLICATIONS folder. Then click on the WACOM TABLET icon.

You can begin customizing the pen display after opening the control panel. See “Customization basics” on page 35.

Note: User-specific preferences are supported. After logging in, each user can customize their personal settings in the Wacom Tablet control panel. Switching to another user will automatically load the settings for that user.

LEARNING MORE ABOUT CINTIQ

See the electronic Software User’s Manual for detailed information on customizing Cintiq.

To view the manual, open the Wacom Tablet control panel and click on the HELP button.

To read the Software User’s Manual before installing Cintiq, first insert the Installation CD into your computer’s CD-ROM drive. When the software menu appears, select the USER’S MANUAL option.

You will need Adobe Reader or another .pdf viewer to view the manual.

CUSTOMIZATION BASICS

This manual covers only the basics of customizing Cintiq. For detailed information see the Software User's Manual.

Open the Wacom Tablet control panel to customize Cintiq. When you open the control panel, an icon for the GRIP PEN is displayed in the TOOL list and the appropriate tabs are displayed. To customize the pen and pen display, make your changes to the tab controls. Experiment with different settings to find what works best for you. Any changes you make will take effect immediately. Click DEFAULT to return to the factory settings.

Note: Application-specific settings are for advanced users. This topic is covered in the Software User's Manual.

The upper portion of the control panel displays icons representing your pen display (TABLET), TOOL, and APPLICATION settings.

Closes the control panel.

Tabs display customizable settings for the selected TOOL.

Displays an information dialog, and an option to access the DIAGNOSTICS dialog.

Displays advanced options.

Choose FUNCTIONS to customize your ExpressKeys, Touch Strips, and Radial Menu settings.

Choose GRIP PEN to customize your pen settings.

Resets the selected tab to its default settings.

Displays the Software User's Manual.

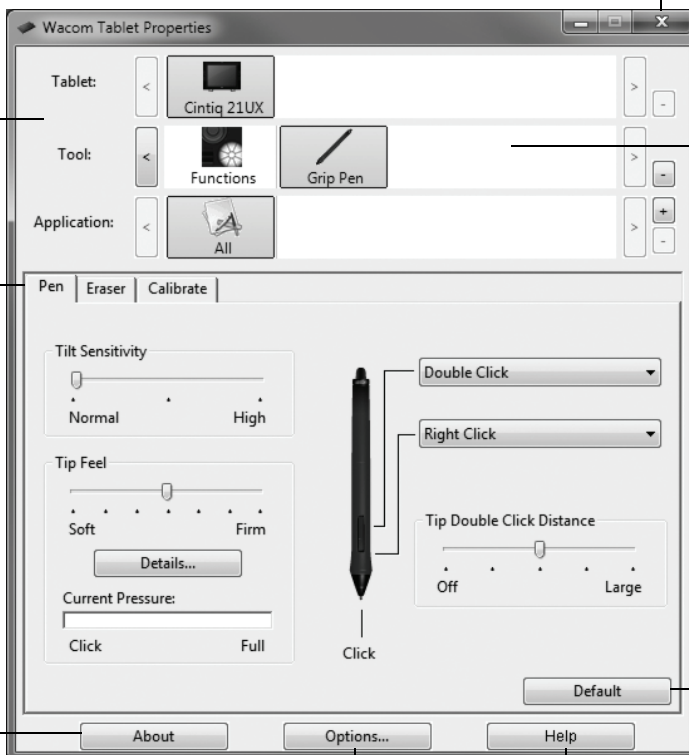

CALIBRATING CINTIQ

You must calibrate the pen display to align the screen cursor with the position of the pen on the display screen. This is required to compensate for viewing angle, and to adjust for parallax caused by the display screen cover glass. Set Cintiq in its working position, then follow the below procedure.

Important: When using a VGA connection, make sure the Cintiq is properly adjusted before calibrating. See “Adjusting the display” on page 38 and “Adjusting pitch and phase (VGA only)” on page 37.

1. Open the Wacom Tablet control panel.
If more than one pen display is installed on your system, select the unit you are working with from the TABLET list.
2. Select GRIP PEN from the TOOL list.
Then select the CALIBRATE tab.
3. If you are working with multiple monitors, select the MONITOR corresponding to the pen display. (Only monitors that are set to one of the resolutions supported by the unit will appear in the list.)
4. Click CALIBRATE... to activate the calibration screen.
5. Hold the pen and position your head as you normally do when working with the pen display. Use the pen tip to click on the center of the crosshairs in the upper-left corner.
6. Then click on the center of the crosshairs that are displayed in the lower-right corner.
7. Test the alignment by positioning the pen at a few different points on the display. Click OK to accept the calibration. Click TRY AGAIN to recalibrate.

Note: Read the directions in the calibration screen for detailed instructions and additional options. The calibration setting applies to all applications.

Tip: To see the screen cursor slightly offset from the actual position of the pen tip, calibrate by clicking on a spot showing that offset from the crosshairs. For example, to have the screen cursor appear 2.5 mm (1/10th of an inch) above and to the left of the pen tip, calibrate by clicking on a spot 2.5 mm (1/10th of an inch) below and to the right of the crosshairs.

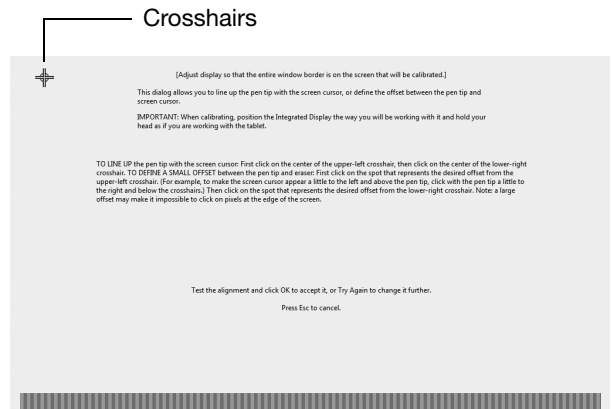
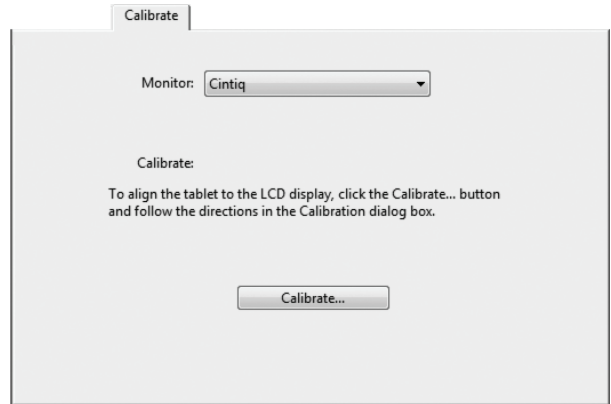

Adjustment pattern for pitch and phase. See “Adjusting pitch and phase (VGA only)” on page 37.

ADJUSTING PITCH AND PHASE (VGA ONLY)

Some computers and video cards may not allow the auto-sync function to fully work when Cintiq is first connected. If some portion of text appears blurred, use the AUTO ADJUST option to automatically synchronize to the incoming signal (see “Factory presets, auto-sync, and user settings” on page 38). If the image is still blurred, adjust pitch and phase by following the below procedure. For optimal display quality, set your video card to the maximum (native) resolution that can be used with Cintiq. See the “Product specifications” on page 68 for details.

1. In the Wacom Tablet control panel, select the CALIBRATE tab.
2. If you are working with multiple displays, be sure the option corresponding to Cintiq is selected in the MONITOR menu.
3. Click on the CALIBRATE... button to activate the calibration screen.
4. Using the OSD controls, open the OSD menu and select the PITCH option. Then adjust the pitch level so the pattern of fine vertical stripes displays evenly. (For details on changing the OSD settings, see “On Screen Display (OSD) settings” on page 38.)
5. In the OSD menu select the PHASE option. Adjust the phase level so that the adjustment pattern shows clearly.
6. After completing these adjustments, press the ENTER and MENU buttons to exit the OSD menu.
7. Click on the CANCEL button or press ESC to exit the calibration screen.

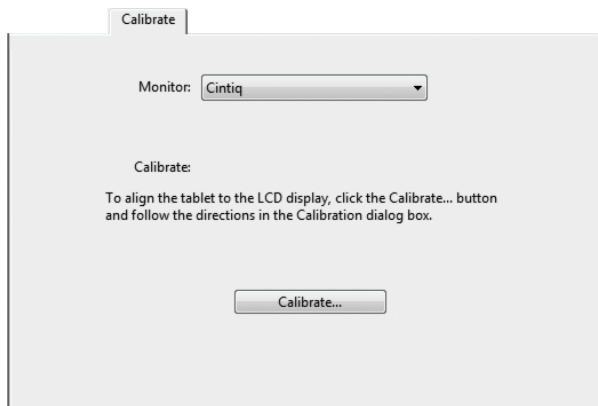

Adjustment pattern for pitch and phase.

ADJUSTING THE DISPLAY

FACTORY PRESETS, AUTO-SYNC, AND USER SETTINGS

Factory presets: For optimal display quality, set your video card to the maximum (native) resolution that can be used with Cintiq. See the “Product specifications” on page 68 for details.

Auto-sync: Cintiq automatically synchronizes to the incoming signal. The auto-sync function sets the horizontal and vertical screen position, as well as pitch and phase. Auto-sync will function between the supported horizontal and vertical frequency ranges. See the “Product specifications” on page 68 for details.

If Cintiq does not automatically synchronize with the incoming signal, you can use the OSD AUTO ADJUST option to initiate display synchronization. Further screen display adjustments can be manually made using the On Screen Display (OSD) controls.

Color calibration: Changing the color, color temperature, contrast, brightness, or backlight from their default settings will invalidate the ICC color profile that was included on the Installation CD.

ON SCREEN DISPLAY (OSD) SETTINGS

The OSD function enables you to optimize a variety of display settings at the touch of a button. Make adjustments using the OSD controls located on the back of the unit. Reach over the top of the display to locate the buttons.

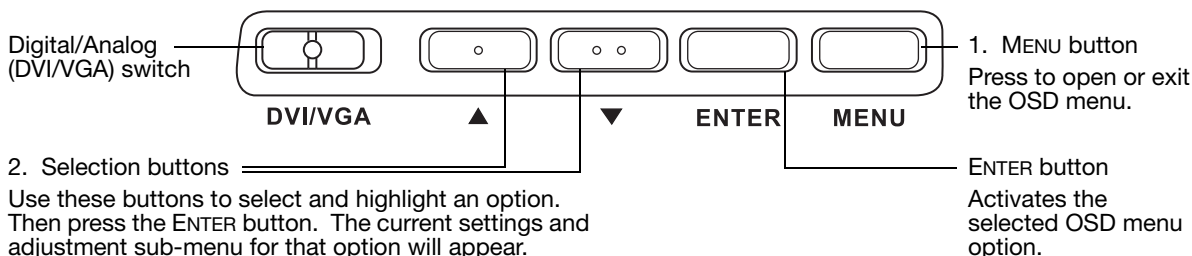

Use these buttons to select and highlight an option. Then press the ENTER button. The current settings and adjustment sub-menu for that option will appear. Some settings may not be available when in DVI mode.

Use the buttons to select and adjust the option settings. (Press the up button to increase a selected item value. Press the down button to decrease it.)

After making changes, press the ENTER button to save.

See the following pages for a detailed description of menu options.

Note: After changing a setting, the OSD menu will automatically close after a few moments of inactivity. You can also press the MENU button to close the OSD menu. All settings are automatically saved when the OSD menu closes and will be used the next time the unit receives a similar video signal. This is applicable to all display modes. If you make changes to the display appearance and cannot return to the original settings, use the RESET option to return the pen display to its original factory defaults.

Menu options are available when you open the On Screen Display (OSD).



LANGUAGE options allow you to choose the language in which to display the OSD menu.

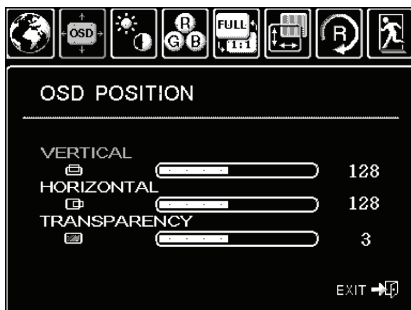

OSD POSITION options include:

- VERTICAL. Adjusts the vertical position of the OSD menu window.
- HORIZONTAL. Adjusts the horizontal position of the OSD menu window.
- TRANSPARENCY. Changes the opaqueness of the OSD menu background.



DISPLAY options include:

- CONTRAST. Increases or decreases image contrast. Changes in contrast may affect color accuracy.
- BRIGHTNESS. Increases or decreases the image brightness.
- BACKLIGHT. Increases or decreases the backlight brightness level.



COLOR options include:

- 5000K, 6500K, 9300K. Enables you to adjust the pen display color temperature, in degrees Kelvin.
- DIRECT displays the colors directly from the video card without any adjustment. When selected, contrast or brightness cannot be adjusted.
- CUSTOM enables you to independently adjust the RED, GREEN, and BLUE display colors.

Note: Any changes you manually make to the color settings will invalidate the color profile.



SCALING options include:

FULL. Resizes the image to fill the whole screen.

ASPECT. Resizes the image to fill as much of the screen as possible while maintaining the correct aspect ratio.

1:1. Displays the image at the actual resolution.



OTHER options include:

- **PHASE.** (VGA only.) Synchronizes the signal timing of the pen display to that of your graphics card. Use when you experience an unstable or flickering image, or horizontal distortion lines.
- **PITCH.** (VGA only.) Changes the display data frequency to match that of your graphics card. Use when you experience an unstable or flickering image, or vertical distortion lines.
- **VERTICAL.** (VGA only.) Changes the vertical position of the image. To automatically adjust, use the AUTO ADJUST option.
- **HORIZONTAL.** (VGA only.) Changes the horizontal position of the image. To automatically adjust, use the AUTO ADJUST option.
- **AUTO ADJUST.** (VGA only.) Choose this function to automatically optimize the display screen image.



RESET returns the display parameters of the current mode to their factory default settings.



EXIT dismisses the OSD without making changes.

POWER SAVING

Cintiq conforms to VESA power saving guidelines.

When used with a Display Power Management Signaling (DPMS) compliant computer or video card, the display will automatically comply with the below power saving parameters.

When these power-saving functions are in effect, the screen display is darker than usual.

Computer mode	H-sync	V-sync	Video	Power consumption	Power lamp
Power ON	Yes	Yes	Active	54 W, max.	Blue
Standby mode	No	Yes	Blanked	2 W, max.	Blue/Orange*
Suspend mode	Yes	No	Blanked	2 W, max.	Blue/Orange*
OFF mode	No	No	Blanked	1 W max.	Off

* Depending on the specifications and settings of your computer and video card, the power light may only show orange when in standby and suspend modes.

TROUBLESHOOTING

Most of the time your interactive pen display will work flawlessly. But if you are having trouble, Wacom recommends you do the following:

1. If the Wacom driver failed to load properly, first perform the recommended action in any error message that may appear on your screen. If that does not solve the problem, review the troubleshooting procedures in this chapter.
2. If Cintiq does not function properly, refer to the troubleshooting sections on the following pages. See also “Display troubleshooting” on page 47, or look in the “Pen tablet troubleshooting” on page 50. Your problem may be described there and you can try the solution offered.
3. Open the Wacom pen display Read Me file for any information updates. You can also check the product FAQs (Frequently Asked Questions) on the Wacom web site for your region.
4. If you are having a compatibility conflict between Cintiq and a new hardware or software product, consider downloading an updated software driver. Wacom periodically updates the software driver to maintain compatibility with new products. See “Obtaining driver downloads” on page 58.
5. If you have tried the suggestions in this guide and still cannot resolve the problem, then contact Wacom for Technical Support. See the “Technical support options” on page 57 and the Read Me file for information on where to obtain support for your region.

TESTING CINTIQ

1. If Cintiq’s power LED does not light, check the following:
 - First verify that the light on the power adapter is on. If the light is not on, check that the power cable is properly connected to the power adapter and to an active AC outlet.
 - Check that the power adapter cable is securely connected to the Cintiq power cable and that the Cintiq power switch is turned on. The Cintiq power LED will glow orange or blue whenever Cintiq is on.

Important: Use only an AC adapter specified for use with your pen display. Other adapters may cause damage to your product.
2. If there is no display:
 - Make sure that your computer is turned on. The power LED will light blue when the proper video signal is received. It will glow orange if there is no video signal or if the computer is in a power saving mode.
 - Verify that Cintiq is connected to an active DVI or VGA connector and that the DVI/VGA switch is set to the correct video setting.
 - Check that your video card has been properly installed and is functional. If you have another display that is compatible with your video card, you can connect that display to the card in order to verify that the video card is operating correctly.

3. Verify that the tablet portion of Cintiq and the Grip Pen are working:
 - Press the pen tip against the display and verify that the status LED lights blue.
 - If the LED does not light, verify that the Cintiq USB cable is plugged into an active USB port. If Cintiq is plugged into a USB hub, try plugging it directly into the USB port on your computer.
 - Be sure the USB port to which you are connecting has not been disabled. It may be necessary to check your system BIOS setting to verify that you have connected Cintiq to an active USB port.
 - The status LED will light blue when Cintiq is registered as a USB device and the pen tip is pressed against the display.
4. Check the Grip Pen. If you cannot make a selection on the display screen with the pen:
 - Test the pen by pressing the pen tip or eraser against the surface of the pen display. The pen display status LED should light blue.
 - Now, without applying pressure to the pen tip but keeping the pen within proximity (5 mm (0.2 inch)) of the pen display surface, press the side switch. The status LED should again light blue.
 - If the status LED does not light blue for these tests, be sure you are using a pen specified for use with Cintiq.
 - See “Testing controls and input tools” on page 44 and “Testing a pen” on page 46 for more information.
5. Check the ExpressKeys. See “Testing controls and input tools” on page 44 and “Testing the ExpressKeys” on page 44 for more information.
6. Check the Touch Strips. See “Testing controls and input tools” on page 44 and “Testing the Touch Strips” on page 45 for more information.

If you are still having problems, you may have a defective pen or pen display.

After testing, use the Wacom Tablet control panel to reconfigure your tablet and tools for any custom settings you may originally have been using.

TESTING CONTROLS AND INPUT TOOLS

If the Grip Pen, or the Cintiq ExpressKeys or Touch Strips do not work as you expect, it is a good idea to first check the assigned functions or reset them to their default conditions. A quick way to return a pen to its default settings is to remove it from the TOOL list by clicking on the control panel list's [-] button. After the pen has been removed, place it back onto the display screen surface. The pen will be added back to the TOOL list with its default settings.

- Open the Wacom Tablet control panel and click on the ABOUT button. In the dialog box that appears, click on the DIAGNOSE... button. The DIAGNOSTICS dialog box displays to show dynamic information about the Cintiq pen display and pen. This information is used when testing Cintiq and your input tool.
- If more than one Cintiq unit is connected to your system, in the TABLET INFO column select the unit for which you are testing.
- Use the information presented in the DIAGNOSTICS dialog box when testing your pen display and pen.

Note: When testing your tool buttons, if a button is set to RADIAL MENU or OPEN/RUN..., that function will occur when the button is pressed. In this case you may want to change the button function before testing.

TESTING THE EXPRESSKEYS

1. With the DIAGNOSTICS dialog box open, observe the TABLET INFO column as you test each ExpressKey. If more than one Cintiq unit is connected to your system, be sure you have selected the unit you are testing from the TABLET INFO column.
2. Test the keys by clicking them one at a time. Each time you press a key, its number will be displayed next to either the LEFT KEYS or RIGHT KEYS category, depending on which keys group you are testing.
3. When you are done, click the CLOSE button to exit the dialog box.

Important: Remember that some applications can override and control the ExpressKey functions. Consider closing any open applications except the Wacom Tablet control panel when testing the ExpressKeys.

TESTING THE TOUCH STRIPS

1. With the **DIAGNOSTICS** dialog box open, observe the **TABLET INFO** column as you test each Touch Strip. If you have more than one Cintiq unit connected to your system, be sure you have selected the unit you are testing from the **TABLET INFO** column.
2. Slide your finger up or down along the entire length of the Touch Strip you want to test. As you touch and move your finger along the Touch Strip, a number will indicate the current finger position for the respective Touch Strip next to **LEFT TOUCH STRIP** or **RIGHT TOUCH STRIP**.
3. Press the corresponding Touch Toggle button for the Touch Strip you are testing. This will toggle between the four customizable states of the Touch Strip. As you cycle between settings, a corresponding LED should illuminate. Within the **DIAGNOSTICS** dialog box, the button state should also be shown.

If any of the functions are set to **SKIP**, the corresponding LED will be skipped in the toggle sequence.

4. When you are done, click the **CLOSE** button to exit the dialog box.

Important: Remember that some applications can override and control the Touch Strip functions. Consider closing any open applications except the Wacom Tablet control panel when testing the Touch Strips.

TESTING A PEN

1. While observing the POINTING DEVICE INFO column, bring your pen within 5 mm (0.2 inch) of the display screen. A value for PROXIMITY, the DEVICE NAME, DEVICE TYPE, and a DEVICE S/N (serial number) should be displayed. If you have more than one Cintiq unit connected to your system, be sure you have selected the unit for which you are testing a pen in the TABLET INFO column.
2. Move your tool along the pen display screen surface. The X and Y DATA values should change to reflect the tool position.
3. Test your pen switches. The Cintiq status LED should light blue each time you click with the tool tip, press the side switch, or press the tool eraser to the display screen.

- Press on the display screen surface with the tool tip. The SWITCHES state and PRESSURE value should change. (PRESSURE should change from approximately 0% with no pressure applied to approximately 100% when full pressure is applied.)
- Next, press the side switch without pressing the tip to the tablet. The SWITCHES state should change. (For the Grip Pen, do this for both positions of the DuoSwitch.)

Pen	Tip = 1, DuoSwitch (lower position) = 2, DuoSwitch (upper position) = 3, Eraser = 1
-----	--

Airbrush	Tip = 1, Side switch = 2, Eraser = 1
----------	--------------------------------------

- Press the tool's eraser to the display screen. The SWITCHES state and PRESSURE value should change. (PRESSURE should change from approximately 0% with no pressure applied to approximately 100% when full pressure is applied.)
 - For the optional Airbrush, move the fingerwheel forward. The WHEEL value should decrease to a value of approximately 0 when the fingerwheel is all the way forward. Move the fingerwheel backward. The WHEEL value should increase to approximately 1000 when the fingerwheel is all the way back.
4. Test tilt for the x-axis by moving the pen from a vertical position toward the right; the X TILT value should change from approximately 0 to +60. Now move the tool to the left of vertical; the X TILT value should change from approximately 0 to - 60.
 5. Test the tilt for the y-axis by moving the pen from a vertical position toward the bottom of the tablet; the Y TILT value should change from approximately 0 to +60. Now move the tool toward the top of the tablet; the Y TILT value should change from approximately 0 to - 60.
 6. For the optional Art Pen, test the rotation feature by placing the pen tip on the display screen surface and slowly rotating the pen on its axis. The ROTATION value should change as you rotate the pen.
 7. When you are done, click on the CLOSE button to exit the dialog box.

DISPLAY TROUBLESHOOTING

If you encounter problems with the display portion of your Cintiq, refer to the following tables; your problem may be described here and you can try the solution offered. For additional information about color issues, see the documentation that came with your operating system or applications.

GENERAL DISPLAY PROBLEMS

No display. Power LED is off.	Verify that the light on the AC power adapter is on and the power cable is securely plugged into Cintiq's power receptacle. Check that the Cintiq power switch is turned on.
No display. Power LED is lit blue.	Check the contrast, brightness, and backlight controls. Adjust as necessary. Or, open the OSD menu and select the RESET option.
The power LED is lit orange. A 'no signal go to power save' message appears briefly on your display screen.	<ul style="list-style-type: none">• Your computer may be in a power management mode. Touch the pen tip to the Cintiq display screen, move the mouse, or depress any key on your keyboard.• Turn off both your computer and the pen display. Check the video cable for bent or broken connector pins. Then properly connect the video cable and turn on the pen display and your computer.• Verify that the DVI/VGA switch is properly set. Restart your computer after changing the position of the switch.• Verify that the video card is properly installed.
A 'cable disconnect go to power save' message briefly appears on your display screen.	<ul style="list-style-type: none">• Check that your computer is turned on.• Verify that the video cable is properly connected.• Turn off both your computer and the Cintiq pen display. Check the video cable and any video adapters for bent or broken connector pins. Then properly reconnect the cables and turn on Cintiq and your computer.

An 'out of range' message appears briefly on your display screen.

- The input signal frequency is incorrectly set or not compatible with Cintiq. Set the refresh rate to a vertical frequency that is compatible with Cintiq. If your video card driver supports adjustment of the horizontal frequency, make sure it is set to a compatible value. See the "Product specifications" on page 68 for frequency range details. On a single monitor system you will need to connect a different display to change the refresh rate.
- The resolution or refresh rate is set too high. See the "Product specifications" on page 68 for details about the maximum (native) resolution, refresh rate, and other resolution sizes that can be used with Cintiq.
- Set the display properties to detect plug and play monitors.

A 'set refresh range' message appears briefly on your display screen.

Set the refresh rate to a vertical frequency that is compatible with Cintiq. See the "Product specifications" on page 68 for frequency range details.

The image appears multiple times on the display.

Do not extend the video cable or use an input selector switch box.

When a still image is displayed for a long period of time without refreshing the screen, an after-image remains for a short period of time.

Use a screen saver or other power management feature.

Color quality is inaccurate.

- Open the OSD menu and select the RESET option.
- Be sure the Cintiq color profile has been installed and is selected as the profile for use with your operating system and applications.
- Any changes to the contrast setting should be made in small increments as changes in contrast may affect color accuracy.

The color white does not display as white.

- Be sure the Cintiq color profile has been installed and is selected as the profile for use with your operating system and applications.
- Verify also that the display is operating at the factory default settings. If that is not sufficient, then adjust color as necessary. For details on color management, refer to your operating system and application documentation.
- Verify that the video cable and connector are fully connected.

VGA PROBLEMS

The display ripples or flickers.

- Open the OSD menu and select the AUTO ADJUST option. Then, if necessary, manually adjust pitch and phase.
- Verify that the display adapter or video card matches the specifications for Cintiq.
- Adjust the refresh rate in the display properties control panel.

The display is not clear. Text or other portions of the screen appear blurred.

- Set the display resolution of your video card to the maximum (native) resolution that can be used with Cintiq. See the “Product specifications” on page 68 for details.
- Turn off the Cintiq, then turn it back on.
- Open the OSD menu and select the AUTO ADJUST option. If necessary, manually adjust the brightness, pitch, and phase settings.

The display and LCD panel are not lined up. The display size is not correct.

- Open the OSD menu and select the AUTO ADJUST option.
- As necessary adjust pitch and phase, and horizontal and vertical position. Note that some video cards may not show the display in proper sizing.

The display ripples or shows a moiré pattern. The display color is not even.

- Open the OSD menu and select the AUTO ADJUST option. If this does not solve the problem, select the RESET option to set the display back to the factory default settings.
- As necessary, adjust pitch and phase.

PEN TABLET TROUBLESHOOTING

If you encounter problems with the tablet portion of your Cintiq, see the following tables. Your problem may be described here, and you can try the solution offered. Be sure to see the Cintiq Read Me file for the latest information.

For additional information, visit the Wacom web site at <http://www.wacom.com/productsupport>.

GENERAL PROBLEMS

The computer does not have an available USB port.	Check if there is an available USB port on a USB hub. If not available, you will need to add a USB hub or USB card.
The pen display power LED is off.	Make sure the pen display power switch is turned on. Check that the AC power adapter is plugged into both the pen display and an active power outlet. Use only a power adapter specified for use with your Cintiq; other adapters may cause damage to your product.
The pen works only in mouse mode, and does not draw with pressure sensitivity.	The driver software for the tablet portion of the pen display was not installed or did not load properly. Make sure the tablet driver software is installed and functioning. Install the pen tablet driver software in accordance with the instructions found in the Installation section of this manual.
The pen does not draw with pressure sensitivity.	Some applications require that you turn on the pressure capabilities within the application or selected tool before the pen will respond as a pressure-sensitive tool. Verify also that your application supports pressure sensitivity.
Clicking is difficult.	Open the Wacom Tablet control panel and go to the PEN tab. Try using a lighter TIP FEEL.
The pen selects everything or will not stop drawing.	Open the Wacom Tablet control panel and go to the PEN tab. Move the TIP FEEL slider toward FIRM, or select the DETAILS... button and increase the CLICK THRESHOLD setting. If this does not help, see "Testing Cintiq" on page 42.
Double-clicking is difficult.	Be sure you are quickly tapping the display screen twice in the same place. Wacom recommends using the side switch to double-click. Open the Wacom Tablet control panel and go to the PEN tab. Try increasing the TIP DOUBLE CLICK DISTANCE or using a lighter TIP FEEL. Set an ExpressKey to DOUBLE CLICK and use it to issue double-clicks. <u>Windows:</u> Try setting your system to launch programs with a single click. See "Clicking" on page 27.

The eraser selects everything or will not stop erasing.	Open the Wacom Tablet control panel and go to the ERASER tab. Move the ERASER FEEL slider toward FIRM, or select the DETAILS... button and increase the CLICK THRESHOLD setting. If this does not help, see “Testing Cintiq” on page 42.
You notice a delay at the beginning of pen or inking strokes.	Open the Wacom Tablet control panel and go to the PEN tab. Try decreasing the TIP DOUBLE CLICK DISTANCE. If that does not work, try dragging the TIP DOUBLE CLICK DISTANCE slider to the OFF position in order to turn off double-click assist.
You have to press hard with the pen when clicking, drawing, or writing.	Open the Wacom Tablet control panel and go to the PEN tab. Move the TIP FEEL slider toward SOFT, or select the DETAILS... button and decrease the SENSITIVITY and CLICK THRESHOLD settings.
The pen tip does not function.	<p>Be sure you are using the pen that originally came with your interactive pen display, or an Intuos4 pen which has a part number ending in “-01”. Other pens may not function properly on the pen display.</p> <p>Check the control panel’s PEN tab and verify that the tip is assigned to a CLICK function.</p> <p>Make sure the status LED lights blue when the pen tip is pressed. If the LED does not light, verify that the USB cable is plugged into an active USB port on your computer or on a USB hub.</p> <p>If the LED still does not light, you may have defective hardware (see “Troubleshooting” on page 42).</p>
Changing the function settings for an input tool has no effect.	Make sure that you change the settings for the tool and application that you are using. See the electronic Software User’s Manual for details on working with multiple tools and with application-specific settings.

The pen side switch does not work. Be sure you are using the pen that originally came with your interactive pen display, or an Intuos4 pen which has a part number ending in “-01”. Other pens may not function properly on the pen display.

Be sure you press the side switch when the pen tip is within proximity (5 mm (0.2 inch)) of the pen display active area. Do this without pressing down on the pen tip.

In the Wacom Tablet control panel, verify that the side switch is set to the proper function you are expecting to occur for the application and input tool you are using.

Check also the SIDE SWITCH MODE. If CLICK & TAP is selected, you will need to first press the side switch then touch the pen tip to the pen display screen surface in order to perform a click function.

Make sure the status LED lights blue when you press the side switch. If the LED does not light, verify that the USB cable is plugged into an active USB port on your computer or on a USB hub.

If the LED still does not light, you may have defective hardware (see “Troubleshooting” on page 42).

The pen tip and screen cursor do not properly line up.

Open the Wacom Tablet control panel and select the CALIBRATE tab. Continue with “Calibrating Cintiq” on page 36.

The screen cursor moves but it does not jump to the pen tip location when the pen is placed on the display screen, and it does not follow the pen tip when the pen is moved across the display.

Make sure the Wacom driver has loaded properly by opening the Wacom Tablet control panel. If the driver did not load you will see an error message. If an error message appears, reboot your computer. If the problem persists, refer to the Installation instructions and reinstall the Wacom driver software. (For Macintosh, you must restart your computer after installing the Wacom driver for proper operation.)

If you have customized the side switch on your pen to toggle between PEN mode and MOUSE mode, make sure that your pen display is operating in PEN mode.

When using Cintiq on a multiple monitor system, you cannot use the pen to control the other monitor(s).

Press an ExpressKey that is set to DISPLAY TOGGLE in order to cycle between pen control for Cintiq and your other displays. See the Software User’s Manual for details on working with Display Toggle.

You can also use your pen to control the other monitors in MOUSE mode. To use MOUSE mode, first set a pen button to MODE TOGGLE.... Then use the button to toggle between PEN mode and MOUSE mode.

The line you are drawing does not line up with the location of the screen cursor.

To function properly, some applications require that the pen is set to PEN mode. Make sure the pen has not been toggled to MOUSE mode.

If the pen is set to PEN mode and the problem still exists, then you may have a corrupted preferences file. Follow the instructions in the Windows or Macintosh troubleshooting sections to create a new preferences file.

The computer does not go to sleep.

When you are not using the pen, remove it from the pen display surface or the Cintiq will continue to send data, keeping the computer awake.

The screen cursor jumps back when using your regular mouse or trackball.

When the pen is not in use, place it in the pen holder, or at some location near the pen display – but not on the display. Leaving your pen on the display may interfere with screen cursor positioning when using other input devices.

The screen cursor moves erratically or jumps around on the display screen when another tablet is connected to your computer.

The tablet portion of Cintiq emits electromagnetic waves at a certain frequency. If another tablet is too closely placed to Cintiq it may interfere with screen cursor positioning. If this occurs, move the tablet further away from Cintiq.

When working in some applications, the ExpressKeys or Touch Strips perform a different function than what is set in the Wacom Tablet control panel.

Some applications can override and control the ExpressKey and Touch Strip functions. See the Software User's manual for information on using applications integrated for tablet control.

If you use application-specific settings, be sure you have updated the settings for the correct application.

Touch Strip functions do not toggle properly, or toggle erratically when pressing the Touch Toggle button.

As you press the Touch Toggle button, be sure you are not inadvertently touching the Touch Strip on the back of the unit. The toggle function will not activate if you are using (or touching) a Touch Strip at the same time you press the Touch Toggle button.

WINDOWS-SPECIFIC PROBLEMS

You suspect the Cintiq preferences may be corrupted, or want to make certain that all settings are at their factory defaults.

Use the Wacom Tablet Preference File Utility to work with your preferences. Close any open applications. Click the START icon and select ALL PROGRAMS. Then select WACOM TABLET and WACOM TABLET PREFERENCE FILE UTILITY.

- It is a good idea to first back up your tablet preferences. In the TABLET PREFERENCE FILE UTILITY dialog box, click BACKUP... and follow the prompts.
- Then, delete the tablet preferences as follows:

Single user. In the TABLET PREFERENCE FILE UTILITY dialog box, click the REMOVE button under MY PREFERENCES to delete the preferences for the current user.

Multiple users. Click the REMOVE button under ALL USER PREFERENCES to delete preferences for multiple users. Note that administrator rights are required to delete preferences for all users. Relaunch any currently open tablet-aware applications that you may be running.

You can quickly restore tablet preferences that have been backed up by clicking RESTORE... under MY PREFERENCES.

After changing right- and left-handed settings in the computer's mouse control panel, the pen tip no longer functions properly.

Restart Windows for your Wacom tool settings to be correctly recognized.

MACINTOSH-SPECIFIC PROBLEMS

At startup, a dialog box appears telling you that either the driver failed to load or the pen display preferences have not yet been created.

The tablet portion of the pen display was not detected at startup. Make sure the USB interface cable is securely connected to an active USB port on your computer or to a USB hub. Make sure that the Cintiq power LED is on and is glowing blue. If this does not correct the problem, see “Troubleshooting” on page 42.

From the GO menu, select the UTILITIES folder and launch the SYSTEM PROFILER. Select USB from the HARDWARE section of the CONTENTS list. A Wacom USB pen display model should be listed. If a pen display model is not listed, check the pen display USB cable connection or try plugging the pen display into a different USB port.

If this does not help, contact Wacom for Technical Support. See “Technical support options” on page 57.

You suspect the pen display preferences may be corrupted, or want to make certain that all settings are at their factory defaults.

Use the Wacom Tablet Utility to work with your preferences. Close any open applications. Open the main APPLICATIONS folder. Then open the WACOM TABLET folder and run the WACOM TABLET UTILITY.

- It is a good idea to first back up your tablet preferences. In the WACOM TABLET UTILITY dialog box, select CURRENT USER or ALL USERS. Then click BACKUP... and follow the prompts.

- Then, delete the tablet preferences as follows:

Single user. When the utility starts, select CURRENT USER and click on the REMOVE button. Log out, then log back in. When the pen display driver loads it will create a new preferences file with the factory defaults.

Multiple users. When the utility starts, select ALL USERS and click on the REMOVE button. Log out, then log back in. When the pen display driver loads it will create new preferences files with the factory defaults.

You can quickly restore tablet preferences that have been backed up for the CURRENT USER or ALL USERS by clicking on the RESTORE... button within the utility.

Note: Do not manually remove the WACOM TABLET.PREFPANE file from the main LIBRARY PREFERENCEPANES folder. This file is only to be removed when uninstalling the Wacom software driver, and then only when using the WACOM TABLET UTILITY.

Recalibrate the pen display.

Ink does not work correctly with the pen display.

There may be a problem with the Ink preferences. Remove the damaged preference files as follows. They will be re-created when you enable handwriting recognition.

1. Open the SYSTEM PREFERENCES pane, choose SHOW ALL and select INK. Then turn off handwriting recognition.
2. From the Go menu, choose your HOME. Open the LIBRARY and PREFERENCES folders. Remove the following preferences:
 - COM.APPLE.INK.FRAMEWORK.PLIST
 - COM.APPLE.INK.INKPAD.PLIST
 - COM.APPLE.INK.INKPAD.SKETCH
3. Go back to SYSTEM PREFERENCES and INK, and then enable handwriting recognition.
4. Test the Ink function using your Wacom pen display and pen.

If this procedure does not resolve your problem with Ink, contact Apple Support for further assistance. Wacom is not the software manufacturer for Ink and we are limited in our abilities to support a third party software application.

TECHNICAL SUPPORT OPTIONS

If you have a problem with your Cintiq pen display, first check the Installation section in this guide to make sure the unit is installed correctly. Then review the Troubleshooting procedures.

If you cannot find the answer in this guide, you may find updated information about your problem in the appropriate Read Me file for your platform (located on the Installation CD). You can also check the product FAQs (Frequently Asked Questions) on the Wacom web site for your region.

If you have an Internet connection you can download the latest software drivers from the Wacom web site for your region. See "Obtaining driver downloads" on page 58.

If you cannot solve the problem and you think your Wacom product is not working properly, contact the Wacom support staff for the area where your product was purchased. See the Wacom tablet Read Me file, located on the Installation CD, for contact information.

When you call, you should be at your computer with the following information available:

- This manual.
- Pen display serial number. (See the label on the back of the unit. You may have to rotate the unit in order to see the serial number label.)
- Driver version number. (See the Installation CD or click on the Wacom Tablet control panel ABOUT button.)
- The make and model of your computer, and operating system version number.
- The make, model, and connection type of your video card.
- A list of peripheral devices attached to your computer.
- The software application and version you were using when the problem occurred.
- The exact wording of any error message that appeared on your screen.
- What happened and what you were doing when the problem occurred.
- How you tried to solve the problem.

OBTAINING DRIVER DOWNLOADS

Wacom periodically updates the software driver for the tablet portion of the interactive pen display to maintain compatibility with new products. If you are having a compatibility problem between your interactive pen display and a new hardware or software product, it may be helpful to download a new Wacom software driver (when available) from the Internet.

USA, Canada, Central and South America

Worldwide Web: <http://www.wacom.com/productsupport> Software updates

Europe, Middle East and Africa

Worldwide Web: <http://www.wacom.eu/downloads> Software updates

Japan

Worldwide Web: <http://tablet.wacom.co.jp/download> Software updates
(Japanese)

Asia Pacific (English)

Worldwide Web: <http://www.wacom-asia.com> Software updates
(English)

China

Worldwide Web: <http://www.wacom.com.cn> Software updates
(Simplified Chinese)

Korea

Worldwide Web: <http://www.wacomkorea.com> Software updates
(Korean)

Taiwan

Worldwide Web: <http://www.wacom.com.tw> Software updates
(Traditional Chinese)

APPENDIX

This section contains tips on caring for your Cintiq, instructions on how to uninstall the software, your license and warranty, and more.

CARING FOR CINTIQ

Keep the Grip Pen and the Cintiq LCD screen surface clean. Dust and dirt particles can stick to the pen and cause excessive wear to the display screen surface. Regular cleaning will help prolong the life of your LCD screen surface and pen.

Keep Cintiq, the Cintiq stand, and the Grip Pen in a clean, dry place and avoid extremes in temperature. Room temperature is best. Cintiq, the Cintiq stand, and the Grip Pen are not made to come apart. Taking apart the product will void your warranty.

Important: Take care to never spill liquids onto the pen display or pen. Be especially careful of getting the display, ExpressKeys, Touch Strips, or pen buttons and tip wet as they contain sensitive electronic parts that will fail if liquids enter them.

To clean the Cintiq casing, the Cintiq display stand, or the Grip Pen, use a soft, damp cloth; you can also dampen the cloth using a very mild soap diluted with water. Do not use paint thinner, benzine, alcohol, or other solvents to clean the unit casing or pen.

To clean the display screen, use an anti-static cloth or a slightly damp cloth. When cleaning, apply only a light amount of pressure to the display screen and do not make the surface wet. Do not use detergent to clean the display screen; this may damage the pen display screen. Damage of this kind is not covered by the manufacturer's warranty.

REPLACING THE PEN TIP

The pen tip (nib) will wear with normal use. Excessive pressure will cause it to wear sooner. If your interactive pen display has a coated surface a worn nib may cause damage. To avoid this, periodic tip replacement is recommended.

1. Unscrew the pen stand base to access the nib extraction tool and replacement nibs.

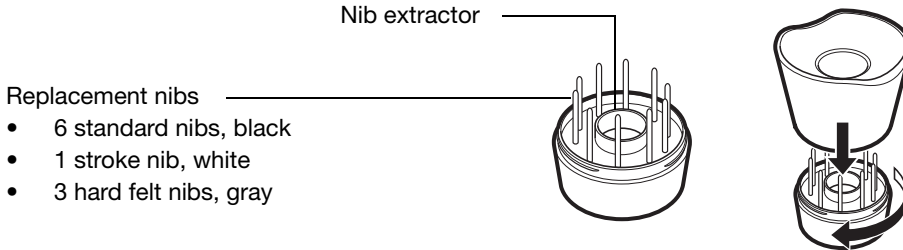

2. Clasp the old nib with the nib extraction tool, pair of tweezers, needle-nosed pliers, or similar instrument and pull it straight out of the pen.
3. Slide the end of the new nib straight into the barrel of the pen. Firmly push the nib until it stops.

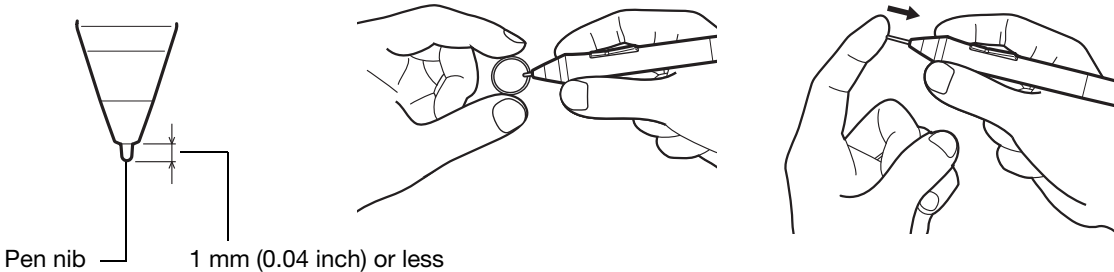

Note: Stroke nibs are spring-loaded, providing additional tactile feedback when you are working with the pen or optional airbrush. They are installed in the same manner as a standard pen nib.

Warning Choking hazard. Prevent children from swallowing the pen nib or side switch. The pen nib or side switch may accidentally be pulled out if children are biting on them.

To order replacement parts, see "Available parts and accessories" on page 72.

Important: When the pen is not in use, place it in the pen stand, the pen holder, or lay it flat on your desk. When the optional Airbrush is not in use, lay it flat on your desk. To maintain the sensitivity of your input tools, do not store them in a container where they will rest on their tip or eraser.

OPTIONAL DISPLAY CONFIGURATIONS

After mounting the pen display unit on the Cintiq stand, you can rotate the pen display to a variety of positions. If you do not plan to rotate the Cintiq and want to fasten it more securely to the stand, install the rotation lock screws as shown below.

To lock Cintiq to the display stand:

- Rotate the pen display to the standard landscape position (with power switch located at top of unit).
- Two holes in the stand will line up with two screw holes on the Cintiq unit.
- Use a Phillips-head screw driver to insert the lock screws and hand-tighten them.

 **Caution** Avoid placing excess physical pressure on the Cintiq stand; doing so can damage the stand.

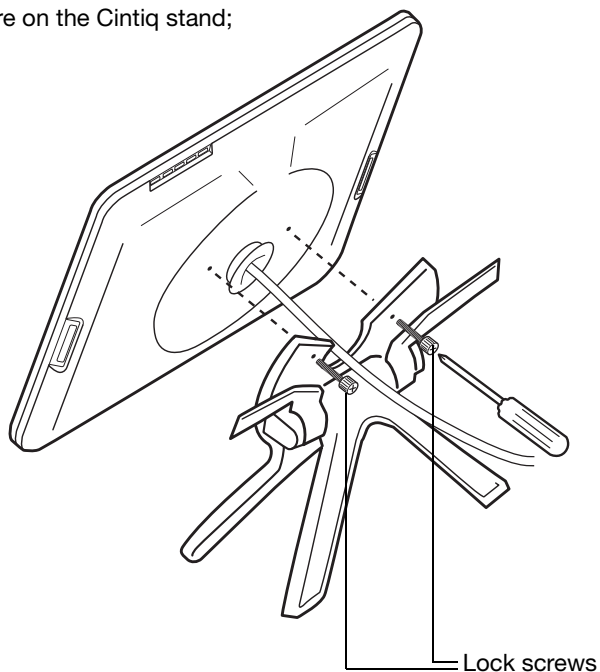

USING AN ALTERNATE MOUNT OR STAND

Cintiq can be attached to any mount arm or stand conforming to the VESA 100 standard.

Mounting screws that are 4 mm wide with a 0.7 mm pitch (M4 Regular), with a screw clearance depth from 13 – 18 mm are required.

To attach Cintiq to a VESA 100 mounting platform:

1. Turn off your computer and power off Cintiq. Then disconnect all cables from between the unit and your computer.
2. Remove Cintiq from its stand and place it face down on a flat, soft surface (such as a cloth spread across a desktop).
3. Remove the bearing hub by unscrewing the four bearing hub attachment screws. Then carefully separate the bearing halves and remove the bearing stopper to free up the cabling. Take care not to lose the small bearing stopper found within the inner groove of one of the hub sections.

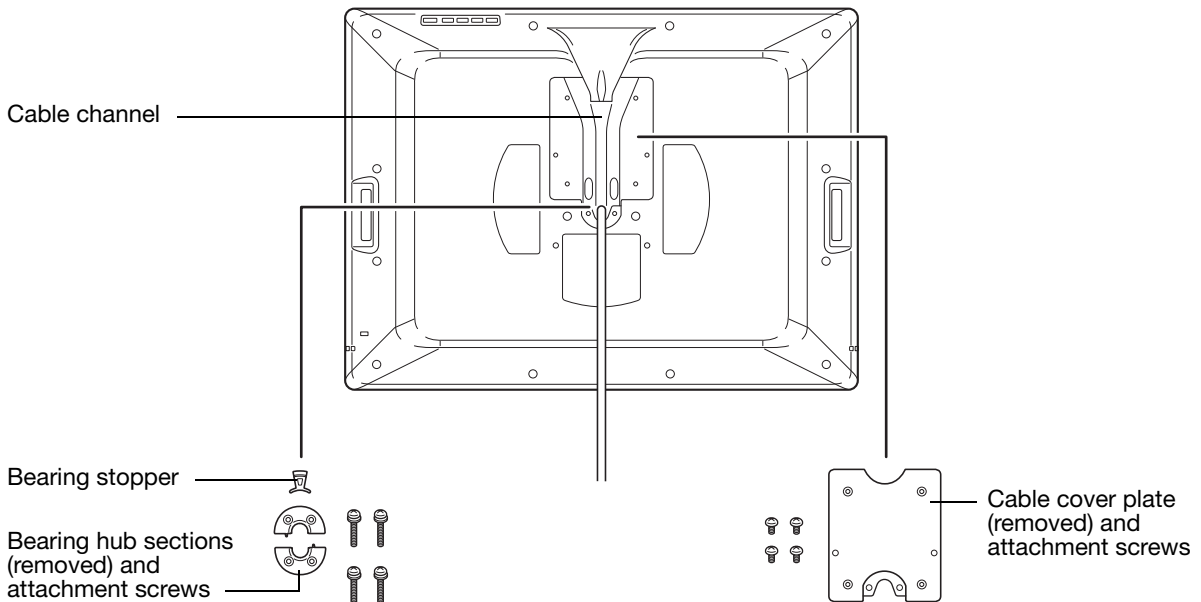
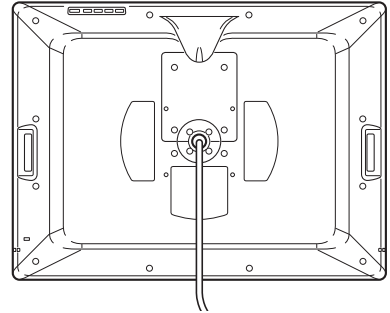

4. Next remove the four attachment screws from the cable cover plate and lift the plate away from the pen display unit.
5. Place the cable into the cable exit channel. Then reattach the cable cover plate making sure to use the correct screws for reattachment. (The cable cover plate screws are shorter than the bearing hub attachment screws.)
6. Using the screws that came with the bearing cover plate, install the cover plate to protect the interior of the unit from dust particles.
7. Now, using the appropriate VESA mounting screws, firmly attach Cintiq to the alternate mounting platform.



Caution When attaching Cintiq onto an alternate mounting platform, be sure to follow all instructions in the documentation supplied by the platform manufacturer. If improperly installed, the unit could fall, resulting in damage to the unit or physical injury.

8. Reattach the cabling to your computer. As necessary, refer to “Step 1: display installation” on page 18.

To remove Cintiq from an alternate mounting platform:

1. Turn off your computer and power off Cintiq. Then disconnect all cables from between the unit and your computer.
2. Remove Cintiq from the alternate mounting platform.
3. Place the pen display unit face down on a flat, soft surface (such as a cloth spread across a desktop). Remove the bearing cover plate.
4. Remove the cable cover plate and lift the cable out of the cable channel. After freeing up the cable, replace the cable cover plate.
5. Lay out and study the bearing hub components – you should have two bearing hub sections, a bearing stopper, and four screws. Locate the bearing stopper within one of the bearing hub sections. (Either hub section can be used, as they are identical parts.) When correctly placed, the bearing stopper will shift smoothly from side to side within the stopper groove. The stopper will also sit flush with the rear hub surface.

Illustrates correct location of bearing stopper within bearing hub section.

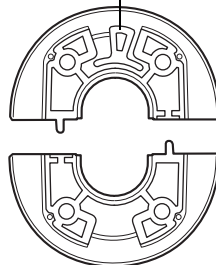

6. Taking care not to dislodge the bearing stopper from the hub section, position the two halves of the bearing hub together around the pen display cable and over their attachment points.

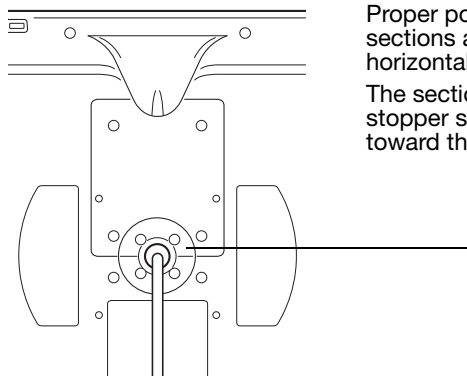

Proper positioning shows the hub sections aligned along the horizontal axis of the pen display. The section containing the bearing stopper should be positioned toward the top of the pen display.

7. Attach the bearing hub sections to the unit making sure to use the correct screws for reattachment. (The bearing hub screws are longer than the cable cover plate screws.)

PEN AND DIGITAL INK CAPABILITIES IN WINDOWS

Microsoft Windows 7 and Vista provide extensive support for pen* input. When using the interactive pen display with a computer running Windows 7 or Vista, your experience is enhanced by powerful note taking, handwriting recognition, fast navigation, and other digital inking options designed to give you quick, intuitive results with the Wacom pen.

- **Note taking.** Use your Wacom pen to jot notes and capture quick sketches in Windows Journal. Journal simulates a physical notebook, but with the advantages of digital note taking. You can choose from a variety of pen, marker, and highlighter tools, plus an eraser that is easily activated by the eraser of your Wacom pen. Journal also includes a powerful search engine that can even locate your handwritten content.
- **Handwriting recognition.** Because Windows 7 and Vista include powerful handwriting recognition capabilities, you can use your Wacom pen to quickly enter handwritten information anywhere the computer accepts typed input. You can convert your handwritten content to typed text at any time.
- **Gestures.** Use your Wacom pen to make simple gestural movements on the pen display to trigger customizable actions for navigation, editing, and other functions. To customize your gestures, select the FLICKS tab in the PEN AND INPUT DEVICES control panel.
- **Digital Ink in Microsoft Office 2007.** Use your Wacom pen to full advantage with the enhanced digital mark-up and inking tools available in Microsoft Office 2007 or later applications running on Windows 7 or Vista. Found on the REVIEW tab within applicable applications, these tools provide a consistent set of inking options. For quick access, you can add specific inking tools to the Quick Access Toolbar located at the top of each application.

To make the most of the pen in Microsoft Windows, be sure to study the documentation that came with your system, including the Windows training tools and Tablet PC tutorial. You can access the Tablet PC Pen Training from the START menu by choosing ALL PROGRAMS, TABLET PC, and TABLET PC PEN TRAINING.

Note: The following workarounds in the software driver for the tablet portion of the pen display improve performance in Windows 7 and Vista:

The Pen Flicks and 'press-and-hold-to-right-click' features are disabled in graphics applications using the Wintab API.

There is no pressure sensitivity in Journal and other Ink features when both the FLICKS and 'press-and-hold-to-right-click' features are disabled in the PEN AND INPUT DEVICES control panel.

* Pen features supported in all versions of Windows 7 and Vista except Windows 7 Starter and Home Basic, and Windows Vista Home Basic.

ABOUT THE WINDOWS TABLET PC INPUT PANEL

The Windows 7 or Vista Input Panel enables you to use handwriting or an on-screen keyboard to directly enter text with your Wacom pen. There are different ways to launch the Input Panel:

- Click on the Input Panel icon which appears when you move the screen cursor into a text entry area.
- Click on the Input Panel tab, located by default on the left edge of the display screen.
- Click on the Tablet PC Input Panel icon located on the Windows taskbar. If the icon is not visible, right-click on the taskbar, select TOOLBARS, and TABLET PC INPUT PANEL.

To customize the Input Panel:

1. First open the Input Panel and then click on TOOLS in the menu bar.
2. Select OPTIONS to open the Input Panel Options dialog box.
3. Customize the Input Panel settings for the way you like to work.

To learn more about using your Wacom pen in Microsoft Windows and Office 2007 or later, study the documentation that came with your system and Microsoft Office applications. Be sure to take advantage of the Windows training tools, including the Tablet PC tutorial, available from Microsoft.

You can visit also the Wacom web site at www.wacom.com/vista for additional information on working with your Wacom pen in Windows.

UNINSTALLING CINTIQ

Follow the appropriate procedure below to remove the Wacom driver software and Cintiq interactive pen display from your system.

Important: When you remove the Wacom driver software from your system, your Wacom interactive pen display will no longer operate with full tablet functionality but will continue to function as a mouse device.

Windows:

1. Click on the Windows START button and open the CONTROL PANEL.
2. In the CONTROL PANEL window for
 - Windows 7 and Vista: click on UNINSTALL A PROGRAM. In the dialog box that appears, choose WACOM TABLET and click on the UNINSTALL button.
 - Windows XP or XP x64: select ADD OR REMOVE PROGRAMS. In the ADD OR REMOVE PROGRAMS window, choose WACOM TABLET and click on the REMOVE button.
3. Follow the prompts to remove the software driver. (If prompted, enter your administrator login name and password.)
4. When the driver has been removed, shut down your system, power off your computer, and turn off the pen display. When your computer and pen display are off, disconnect the pen display from your computer.

Macintosh:

1. From the GO menu, choose APPLICATIONS and open the WACOM TABLET folder.
2. Double-click on the WACOM TABLET UTILITY icon and select the TABLET SOFTWARE: REMOVE button. Enter your administrator login name and password.
3. After the removal is completed, click OK.

Shut down your computer and turn off the pen display. When your computer and pen display are off, disconnect the pen display from your computer.

PRODUCT SPECIFICATIONS

GENERAL SPECIFICATIONS

Dimensions (W x D x H)	561 x 421 x 47.8 mm (22.10 x 16.59 x 1.88 in), excluding center bearing and stand
Weight	8.7 kg (19.14 lb), excluding stand 10.4 kg (22.88 lb) with stand
Input voltage	12 VDC
Power consumption, with AC adapter	54 W max. 2 W or less in sleep modes 1 W or less in off mode
Power management	VESA DPMS
Plug and Play	DDC 2B, DDC/CI
Compatibility	Windows: 7, Vista, XP (32 and 64 bit) Macintosh: OS X, v10.4 or later
Cover plate	Tempered etched glass with AR film
Cable, integrated	DVI-I, USB, DC power
Operating temperature and humidity	5° to 35° C, Humidity: 20% to 80% (non-condensing)
Storage temperature and humidity	-10° to 60° C, Humidity: 20% to 90% (non-condensing) (maximum storage humidity is 38% at a temperature of 60° C, and maximum storage temperature is 42° C at a humidity of 90%)
Certification and compliance	FCC Part 15 Subpart B (Class B) and C, CE, VCCI Class B, C-tick, BSMI, KCC, CCC, GOST-R, CB, The European Union RoHS Directive 2002/95/EC, Chinese RoHS, Korean RoHS

DISPLAY

Display panel	a-Si active matrix TFT LCD (IPS type)
Screen size	21.3 in, 432 x 324 mm (17.0 x 12.8 in)
Aspect ratio	4 : 3
Number of pixels	1600 x 1200
Input video signal	Digital: DVI 1.0 compliance / Analog RGB
Supported resolution	1600 x 1200, 1280 x 1024, 1024 x 768, 800 x 600, 640 x 480
White luminance uniformity	72% (typ.) center
Synchronization range	50 to 75 Hz vertical, 30 to 80 kHz horizontal (UXGA: 60 Hz vertical, 75 kHz horizontal)
Timing modes	5 preset modes + 24 user modes
Pixel pitch	0.270 (H) x 0.270 (V) mm (0.011 x 0.011 in)
Viewing angles @ CR10:1 (horizontal/vertical)	170(85/85) / 170(85/85) (typ.)
Display colors	16.7 million colors
Contrast ratio	550 : 1 (typ.)
Response time (Tr+Tf)	20 ms (typ.)
Luminance	220 cd/m2 (typ.), LCD panel only 200 cd/m2 (typ.), with protection glass
OSD manual control	Brightness, contrast, pitch, phase, vertical position, horizontal position, transparency, auto adjust, language, back light, menu position, reset, scaling, color temperature (9300K/6500K/5000K/Custom/User/Direct)
Plug and Play	DDC 2B, DDC/CI
LCD quality	Each LCD panel is produced under very stringent quality standards. Production techniques cannot guarantee an absolutely perfect TFT display. Wacom does not allow any pixel to be always white or always black. A small number of pixels are allowed to show a wrong color for some parts of the color spectrum. This does not mean the display is defective.

PEN TABLET

Reading technology	Electro-magnetic resonance technology
Active area	432.0 x 324.0 mm (17.0 x 12.8 in)
Resolution	0.005 mm/point (5080 lpi)
Accuracy	±0.5 mm (±0.02 in), center Edge area 1 (20 mm wide from edge of display area) to be ±2.0 mm (±0.08 in) Edge area 2 (3 mm wide from edge of display area) to be ±4.0 mm (±0.16 in)
Maximum pen tilt range	40 degrees from vertical (except for corners)
Pen tilt levels	±60 levels
Reading height	5 mm (0.2 in) or more, center
Maximum report rate	133 points/sec.
Pressure levels	2048 levels
Communication interface	USB

DISPLAY STAND

*Patented	Patent no. 6,874,744
Physical dimensions (W x D x H)	329 x 299 x 165 mm (13.0 x 11.8 x 6.5 in)
Weight	1.7 kg (3.74 lb)
Rotation	±180°
Incline	30° to 80° from vertical
Primary orientation	Landscape, lockable

POWER ADAPTER

Input voltage	100 to 240 VAC, 50/60 Hz
Output voltage	12 VDC, 6.0A (max.)

GRIP PEN (MODEL KP-501E-01)

Pressure levels	2048 levels
Pen tip travel	1.0 mm (0.04 in), max.
Eraser tip travel	2.0 mm (0.08 in), max.
Physical dimensions (L x D)	156.5 x 14.9 mm (6.17 x 0.59 in)
Weight	17 g (0.60 oz), approximately
Side switch type	Rocker switch

PRODUCT INFORMATION

To learn more about your interactive pen display and how to take full advantage of the many pen and digital inking features in Microsoft Windows 7 and Vista, visit the Wacom web site for your region:

USA, Canada, Central and South America	http://www.wacom.com/productinfo
Europe, Middle East and Africa	http://www.wacom.eu
Japan	http://tablet.wacom.co.jp
Asia Pacific (English)	http://www.wacom-asia.com
China (Simplified Chinese)	http://www.wacom.com.cn
Korea	http://www.wacomkorea.com
Taiwan	http://www.wacom.com.tw
Thailand	http://www.wacom-thai.com

ORDERING PARTS AND ACCESSORIES

To purchase parts and accessories, refer to the Wacom pen display Read Me file and see who to call for your region.

You can also do the following:

To purchase parts and accessories in the USA or Canada, call 1.888.884.1870 (toll-free) or visit Wacom's web site at <http://www.WacomDirect.com> (USA only).





To purchase parts and accessories in Europe, call +49 (0)180.500.03.75 or send an email to spareparts@wacom.eu. Or, visit <http://shop.wacom.eu>. You can also contact your local dealer, distributor, or technical support using the appropriate number for your region.

To purchase parts and accessories in Australia, Singapore, Taiwan and Korea, please visit: www.BuyWacom.com.au, www.BuyWacom.com.sg, www.BuyWacom.com.tw and www.BuyWacom.co.kr, respectively.

To purchase parts and accessories in other countries, please contact your local dealer or distributor.

Please note that not all parts and accessories may be available in all regions.

AVAILABLE PARTS AND ACCESSORIES

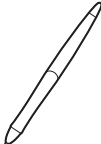
DESCRIPTION		PART NUMBER
<p>Grip Pen. Sensitive to pressure and tilt, the Grip Pen is an all-purpose tool for drawing, erasing, and mouse operations. The easy-to-use DuoSwitch gives you two programmable switch functions. The pressure-sensitive pen has an ergonomically waisted grip area, optimum weight and balance, and superior tip sensitivity, making it the most natural freehand tool. Includes the following accessories: Pen stand, standard nib (qty 1), stroke nib (qty 1), hard felt nib (qty 1), and flex nib (qty 1).</p>		KP-501E-01
<p>Airbrush. A true digital airbrush incorporating a pressure-sensitive tip and eraser, tilt sensitivity, and a fingerwheel that provides an additional degree of control over the application of digital paint. This tool also has a programmable top button. Includes the following accessories: Pen stand, standard nib (qty 1), stroke nib (qty 1), hard felt nib (qty 1), and flex nib (qty 1).</p>		KP-400E-01
<p>Art Pen. This specialty pen provides 360 degrees of barrel rotation and, like the Grip Pen, is pressure and tilt sensitive. Combining these features with a unique chisel-shaped nib makes the Art Pen the most realistic tool for emulating brushes, markers, and calligraphic pens. Includes the following accessories: Pen stand, chisel tipped nibs (qty 2), chisel tipped felt nibs (qty 2), bullet tipped nibs (qty 3), and bullet tipped felt nibs (qty 3).</p>		KP-701E-01
<p>Classic Pen. This pen has the same feature set as the Grip Pen, but with a slimmer profile that does not include a rubberized grip. Includes the following accessories: Pen stand, standard nib (qty 1), stroke nib (qty 1), hard felt nib (qty 1), and flex nib (qty 1).</p>		KP-300E-01
<p>Inking Pen. This pressure- and tilt-sensitive drawing pen was created to provide immediate feedback at your pen tip on the drawing as well as on your computer screen. The pressure-sensitive Inking Pen comes with inking cartridges and two polyacetal tips for inkless drawing. It has a pressure-sensitive tip, but no eraser and no side switches. Includes the following accessories: Pen stand, standard nibs (qty 2), inking nibs (qty 3).</p> <p>Note: When you purchase an Inking Pen, it comes with a polyacetal nib in the pen. Use the nib extractor (silver ring) to gently remove the polyacetal nib from the pen. Then insert one of the silver-colored cartridges that come with the Inking Pen. The cartridge tip has a waxy coating that you will need to rub off before you can begin inking.</p>		KP-130-01

DESCRIPTION	PART NUMBER
Replacement nibs for Grip Pen, Airbrush, or Classic Pen	
Standard nib – firm, plastic nib, black, qty 5	ACK-20001
Stroke nib – spring loaded nib, more of a “brush-like” feel, qty 5	ACK-20002
Hard felt nib – softer nib for a “pencil or marker on paper” feel, qty 5	ACK-20003
Flex nib – a flexible, elastomeric nib, that provides a “higher friction” feel, qty 5	ACK-20004
Felt nib, chisel tip, qty 5	ACK-20005
Nib set, for Art Pen	ACK-20006
Grip Pen, professional accessory kit	ACK-40001
Pen grip, standard	ACK-30001
Pen grip, thick bodied for pen use without side switch	ACK-30002
Pen grip, standard for pen use without side switch	ACK-30003

For a list of other available parts and accessories, visit the Wacom web site for your region. For order information see “Ordering parts and accessories” on page 71.

RADIO AND TELEVISION INTERFERENCE

The equipment described in this manual generates, uses, and can radiate radio-frequency energy. If it is not installed and used properly – that is, in strict accordance with applicable instructions – it may cause interference with radio and television reception.

FCC NOTICE

This device complies with Part 15 of the FCC Rules. Operation is subject to the following two conditions: (1) this device may not cause harmful interference, and (2) this device must accept any interference received, including interference that may cause undesired operation.

This equipment has been tested and found to comply with the limits for a Class B digital device, pursuant to Part 15 of FCC Rules. These limits are designed to provide reasonable protection against harmful interference in a residential installation.

This equipment generates, uses and can radiate radio frequency energy and, if not installed and used in accordance with the instructions, may cause harmful interference to radio communications. However, there is no guarantee that interference will not occur in a particular installation.

You can determine whether the equipment is causing interference by powering it off. If the interference stops, it was probably caused by the equipment.

If the equipment does cause interference to radio or television reception, you may be able to correct the interference by using one or more of the following measures:

- Rotate the television or radio antenna until the interference stops.
- Move the equipment farther away from the television or radio.
- Plug the equipment and computer into an outlet that is on a different circuit from the television or radio.

If necessary, consult your Wacom dealer or an experienced radio/television technician for help.

Changes or modifications to this product not authorized by Wacom could void the FCC Certification and negate your authority to operate the product.

INDUSTRY CANADA (CANADA ONLY)

Industry Canada, Class B

“This Class (B) digital apparatus complies with Canadian ICES-003”

“Cet appareil numérique de la classe (B) est conforme à la norme NMB-003 du Canada.”

CE DECLARATION

The DTK-2100 interactive pen display has been tested and found to comply with the following harmonized European Norms:

- IEC 60950-1:2005 (2nd Edition)
- EN 60950-1:2006 + A11:2009
- EN 55022: 2006+A1:2007
- EN 61000-3-2: 2006
- EN 61000-3-3: 1995+A1:2001+A2:2005
- EN 55024: 1998+A1:2001+A2:2003
 - IEC61000-4-2:2008
 - IEC61000-4-3: 2008
 - IEC61000-4-4:2004+Corr.1:2006+Corr.2:2007
 - IEC61000-4-5: 2005
 - IEC61000-4-6: 2008
 - IEC61000-4-8: 2001
 - IEC61000-4-11: 2004

Based on the results of these tests, Wacom declares that the above mentioned device conforms to the EMC Directive 2004/108/EC.

Based on the results of these tests, Wacom declares that the above mentioned device conforms to the Safety Directive 2006/95/EC.

The device must be installed and operated always in strict accordance to the instructions given in this manual. Any changes or modifications to this product that were not specially authorized by Wacom will invalidate this declaration.

COMMISSION REGULATION (EC) No 1275/2008 of 17 December 2008 implementing Directive 2005/32/EC of the European Parliament and of the Council with regard to ecodesign requirements for standby and off mode electric power consumption of electrical and electronic household and office equipment.

WARRANTY

(WORLDWIDE, EXCEPT FOR EUROPE, AFRICA AND MIDDLE EAST)

LIMITED WARRANTY

Wacom warrants the product, to the original consumer purchaser, except for the Software and consumable items such as the pen nibs, to be free from defects in materials and workmanship under normal use and service for a period of two (2) years, from the date of original retail purchase, as evidenced by a copy of the receipt and registration with Wacom within 30 days of purchase.

The Software is licensed "as is." Wacom makes no warranty with respect to its quality or performance. Wacom cannot guarantee you uninterrupted service or the correction of any errors.

Upon discovery of a defect in the product, except in the Software, within the Warranty Period, you should contact Wacom Technical Support via telephone, email, or fax to obtain an RMA (Return Merchandise Authorization) number and instructions for shipping the product to a service location designated by Wacom. You should send the product, shipping charges prepaid, to the designated service location, accompanied by the return authorization number, your name, address and telephone number, proof of purchase date, and a description of the defect. Wacom will pay for return shipping by United Parcel Service or by an equivalent service as chosen by Wacom.

Wacom's sole obligation and entire liability under this warranty shall be, at Wacom's option, either the repair or replacement of the defective product or parts thereof of which Wacom is notified during the Warranty Period; provided, however, that you are responsible for (i) the cost of transportation of the product to the designated service location and (ii) any loss or damage to the product resulting from such transportation.

Wacom shall have no responsibility to repair or replace the product if the failure of the product has resulted from accident, abuse, misuse, negligence, or unauthorized modification or repair, or if it has been handled or stored other than in accordance with Wacom's storage instructions.

Any descriptions, drawings, specifications, samples, models, bulletins, or similar material, used in connection with the sale of the product, shall not be construed as an express warranty that the product will conform or comply with your requirements.

EXCEPT FOR THE LIMITED WARRANTY DESCRIBED ABOVE, THERE ARE NO OTHER WARRANTIES MADE BY WACOM ON THIS PRODUCT. NO ORAL OR WRITTEN INFORMATION OR ADVICE GIVEN BY WACOM, ITS DEALERS, DISTRIBUTORS, AGENTS, OR EMPLOYEES SHALL CREATE A WARRANTY OR IN ANY WAY INCREASE THE SCOPE OF THIS WARRANTY, AND YOU MAY NOT RELY ON ANY SUCH INFORMATION OR ADVICE. THIS WARRANTY GIVES YOU SPECIFIC LEGAL RIGHTS, AND YOU MAY ALSO HAVE OTHER RIGHTS WHICH VARY FROM STATE TO STATE.

WACOM LIMITS THE DURATION OF ANY LEGALLY IMPLIED WARRANTIES INCLUDING IMPLIED WARRANTIES OF MERCHANTABILITY OR FITNESS FOR A PARTICULAR PURPOSE, TO THE DURATION OF WACOM'S EXPRESS WARRANTY. SOME STATES DO NOT ALLOW LIMITATIONS ON HOW LONG AN IMPLIED WARRANTY LASTS, SO THE ABOVE LIMITATION MAY NOT APPLY TO YOU.

NEITHER WACOM NOR ANYONE ELSE WHO HAS BEEN INVOLVED IN THE CREATION, PRODUCTION, OR DELIVERY OF THIS PRODUCT SHALL BE LIABLE FOR ANY DIRECT, CONSEQUENTIAL, OR INCIDENTAL DAMAGES (INCLUDING DAMAGES FOR LOSS OF BUSINESS PROFITS, BUSINESS INTERRUPTION, LOSS OF BUSINESS INFORMATION AND THE LIKE) ARISING OUT OF THE USE OF OR INABILITY TO USE SUCH PRODUCT, EVEN IF WACOM HAS BEEN ADVISED OF THE POSSIBILITY OF SUCH DAMAGES. SOME STATES DO NOT ALLOW THE EXCLUSION OR LIMITATION OF INCIDENTAL OR CONSEQUENTIAL DAMAGES, SO THE ABOVE LIMITATION OR EXCLUSION MAY NOT APPLY TO YOU.

In the event that any of the above limitations are held unenforceable, Wacom's liability for any damages to you or any party shall not exceed the purchase price you paid, regardless of the form of any claim.

This Limited Warranty is governed by the laws of the United States of America and the state of Washington.

This Limited Warranty is valid for and only applies to products purchased and used inside the United States (and its territories or possessions) and Canada.

WARRANTY SERVICE IN THE U.S.A. AND CANADA

To obtain Warranty service within the U.S. or Canada contact:

Wacom Customer Care Center

Phone: 1.360.896.9833

Email Inquiry form: <http://www.wacom.com/productsupport/email.cfm>

WARRANTY SERVICE OUTSIDE OF THE U.S.A. AND CANADA

For products purchased or used outside of the United States and Canada, the warranty period is one (1) year from the date of original purchase. Upon discovery of a defect in the product, except in the Software, within the Warranty Period you should contact your local dealer or distributor. If an authorized Wacom repair center is not available in your local country you will be responsible for all transportation costs including duties and taxes to and from the Wacom repair center. In all other respects, the terms of the warranty as set forth above apply to such sales.

Wacom Technical Support in Asia Pacific (except Japan and China)

Detailed Asia Pacific Limited Warranty policy and product registration may be found online at <http://www.wacom-asia.com>

To obtain technical support or Warranty service within Southeast Asia, Oceania and Taiwan, please contact the Wacom Customer Support Service.

Phone numbers can be found here: <http://www.wacom-asia.com/support/contact>

Should you have any questions about this Agreement, or if you desire to contact Wacom for any reason, please contact in writing:

IN NORTH AND SOUTH AMERICA CONTACT:

Wacom Technology Corporation
1311 SE Cardinal Court
Vancouver, Washington 98683
U.S.A.

IN JAPAN CONTACT:

Wacom Co., Ltd.
2-510-1 Toyonodai
Otone-Machi, Kitasaitama-Gun
Saitama, 349-1148
Japan

IN ASIA PACIFIC CONTACT:

Wacom Co., Ltd.
Asia Pacific Office
Harmony Tower 18F, 1-32-2 Hon-Cho,
Nakano-Ku, Tokyo 164-0012
Japan

IN MAINLAND CHINA (EXCEPT HONG KONG) CONTACT:

Wacom China Corporation
Unit 2807, 28th Floor, SK Tower
No 6 Jia, Jianguomenwai Avenue,
Beijing, 100022, China
E-mail: support@wacom.com.cn

LICENCE WARRANTY CONDITIONS (EUROPE, AFRICA AND MIDDLE EAST)

SOFTWARE LICENCE AGREEMENT

Important customer information

The scope of delivery of this product covers copyright-protected computer programs ("software"), which are the inalienable intellectual property of WACOM Europe GmbH ("WACOM"). This software is an integral component of the product and is also held on the associated data carrier. The software of WACOM and the associated rights of use are not included with the purchase of this product from your retailer. WACOM grants you-the user-the right to use the software exclusively in accordance with the conditions stipulated in this licence agreement. By purchasing this product, you agree to the following licence conditions.

Conditions for using the software

WACOM issues the user with a personal, non-exclusive licence to use the software solely in connection with this product and for the correct operation of the product. This licence may only be assigned to a third party in connection with this product.

Use of this software includes the creation of permanent or temporary copies of the software by means of loading, displaying, exporting, transferring or saving, for the purposes of exporting the commands and the data they contain or for observing, researching or testing the software functions.

The customer may not license the software to a third party, lease, lend or in any other way provide access to the software. The customer may not copy, change, transfer or edit the software without prior written agreement from WACOM. The only exceptions to this are necessary procedures for creating a back-up copy and the scenarios outlined in section 2.

The customer may not carry out any "reverse engineering", decompile or depacketise the software, or try by any other means to discover the source code of the software. This restriction shall continue to apply after the termination of this agreement. If the software contains interfaces to other programs that are not supported by WACOM, WACOM shall provide the customer with the necessary information on request, as long as the customer can prove his right to use the software and agrees to bear the copying and postage costs.

WACOM AND ITS SUPPLIERS CANNOT OFFER ANY GUARANTEE FOR THE PERFORMANCE OF THE SOFTWARE OR FOR THE RESULTS PRODUCED THERE FROM. WACOM AND ITS SUPPLIERS OFFER NO GUARANTEES OR ASSURANCES (EITHER EXPRESSLY OR IMPLICITLY, INCLUDING THOSE THAT MAY BE DERIVED FROM A BUSINESS RELATIONSHIP OR FROM TRADE PRACTICE, OR FROM LEGAL PROVISIONS OR CUSTOMARY LAW) WITH REGARD TO THE MARKETABILITY, FREEDOM FROM DEFECTS OF TITLE OR USEFULNESS OF THE SOFTWARE.

WACOM AND ITS SUPPLIERS ACCEPT NO LIABILITY FOR DAMAGES, CLAIMS OR COSTS OF ANY KIND, NOR FOR CONSEQUENTIAL DAMAGES, SECONDARY, ACCIDENTAL, INDIRECT OR PENAL DAMAGES, PARTICULAR OR MISCELLANEOUS DAMAGES OR FOR DEMANDS OR INDEMNITY CLAIMS FOR REDUCED PROFITS OR LOSSES. THIS SHALL ALSO APPLY IN THE CASE OF A REPRESENTATIVE OF WACOM BEING PREVIOUSLY AWARE OF THE POSSIBILITY OF SUCH LOSSES, DAMAGES, CLAIMS OR COSTS, OR DEMANDS FROM THIRD PARTIES.

The existing limitations on liability shall not apply in the case of the assumption of explicit guarantees, or in case of fraudulent behaviour on the part of WACOM, nor for damages arising from wilful or grossly negligent behaviour on the part of WACOM, from damages leading to loss of life, personal injury or sickness or in the case of binding legal provisions. For slight negligence, WACOM and its suppliers shall only be liable in the event of a breach of essential contractual obligations. Liability when such an essential contractual obligation is breached is, however, limited to damages typical to this type of contract, which WACOM must have determined at the conclusion of the contract based on the known risks and circumstances at that time. Claims for reduced profits or expenses saved, indemnity claims from third parties or claims for any other direct or consequential damages still cannot be asserted in this case.

The laws of the Federal Republic of Germany shall apply to this agreement. However, the applicability of the United Nations Convention on Contracts for the International Sale of Goods is explicitly excluded. Krefeld is the sole place of jurisdiction for all claims arising from this contractual relationship and all disputes between the parties resulting from the formation, handling or termination of the contractual relationship, provided that the customer is a trader, a legal entity under public law or a special fund under public law.

The jurisdiction agreement shall also apply for customers who do not have a general place of jurisdiction in Germany. The jurisdiction agreement shall not apply if, due to legal provisions, a different sole place of jurisdiction must be established for the case. Furthermore, WACOM is authorised to file a lawsuit against the headquarters of the customer.

This licence constitutes the entire contractual agreement between the parties. It overrides all other verbal and written contracts and agreements and may only be altered by means of a written and signed contract. Should one of the provisions of these licence conditions be or become void, the validity of the other provisions shall not be affected, in full or in part. Should a provision be invalid, the legally permissible regulation most closely resembling the invalid regulation shall apply in its place.

LIMITED WARRANTY

WACOM guarantees to you, as the initial purchaser, that the product hardware, when used as intended, will remain free from material defects and processing errors for a warranty period of TWO (2) YEARS and Cintiq products shall be guaranteed for a warranty period of THREE (3) YEARS, commencing from the purchase date and provided that the product was unused at the time of purchase. Defects in wear parts (e.g. pen tips) resulting from normal wear and tear are exempt from the warranty. Furthermore, WACOM guarantees that the data carriers delivered with the product are free from material defects and processing errors for a period of SIX (6) MONTHS from the date of purchase.

If the product-excluding any software-is discovered to be faulty it must be returned immediately to the place of purchase in its original packaging within the warranty period together with your name, address and telephone number, a description of the problem and a copy of the original receipt. The customer shall be liable for any possible damage or loss of the product during transit for this purpose. Under the provisions of this warranty, WACOM only undertakes to repair or replace the faulty product or parts at its own discretion, in cases where defects are proven and the product is sent within the warranty period.

WACOM is not obligated to repair or replace the product if: (a) the damage to the product results from any accident, misuse, improper use, negligence or unauthorised alteration or repair; (b) the product was not handled or stored according to the instructions provided by WACOM; (c) the damage resulted from normal wear and tear; or d) the serial number affixed by WACOM has been removed or rendered unintelligible.

If, when a claim made under this warranty is checked, it emerges that it is outside the permitted time period or is not covered by the warranty or that the product is not faulty, the costs of any checks or repairs must be borne by the customer.

Any descriptions, drawings, specifications, samples, models, notifications or similar material provided in connection with the purchase of the product cannot be taken as an explicit guarantee that the product corresponds to or fulfils the customer's requirements.

If this product is faulty, the purchaser shall be entitled to assert legal claims against the vendor for liability due to defects. These legal rights against the vendor are not limited by the existing warranty. The warranty grants the customer many additional rights under the conditions stipulated in this text.

This limited warranty shall apply if the registered office of the vendor is in the EU or in Iceland, Norway, Jersey, Switzerland, Russia, Ukraine, Croatia, Serbia, Tunisia, Turkey, Syria, Lebanon, Jordan, Israel, Egypt, United Arab Emirates, Iran or South Africa.

The granting of this limited warranty is subject to the laws of the Federal Republic of Germany. However, the applicability of the United Nations Convention on Contracts for the International Sale of Goods is explicitly excluded. Krefeld is the sole place of jurisdiction for all claims arising from this contractual relationship and all disputes between the parties resulting from the formation, handling or termination of the contractual relationship, provided that the customer is a trader, a legal entity under public law or a special fund under public law.

The jurisdiction agreement shall also apply for customers who do not have a general place of jurisdiction in Germany. The jurisdiction agreement shall not apply if, due to legal provisions, a different sole place of jurisdiction must be established for the case. Furthermore, WACOM is authorised to file a lawsuit against the headquarters of the customer.

Should one of the provisions of these limited warranty conditions be or become void, the validity of the other provisions shall not be affected, in full or in part. Should a provision be invalid, the legally permissible regulation most closely resembling the invalid regulation shall apply in its place.

If you have any questions about this agreement, or would like to contact WACOM for another reason, please contact us by post at this address:

WACOM Europe GmbH
Europark Fichtenhain A9
47807 Krefeld
GERMANY

CINTIQ EXCHANGE POLICY (EUROPE, AFRICA AND MIDDLE EAST)

Should your Cintiq Interactive Pen Display become defective during the warranty period, Wacom Europe GmbH offers an exchange program. Please follow the procedure described below and note the restrictions:

- Note: The Cintiq exchange program can only be offered for countries of the European Union with the exception of Malta, Cyprus, the Canary Islands, and the French Overseas Territories.
- Note: You must have registered your Cintiq Interactive Pen Display at Wacom Europe GmbH if you want to take advantage of the exchange program.
- If you believe your Cintiq Interactive Pen Display is defective, please contact our Technical Support Staff (see section Support Staff in this manual). Please have the serial number of the defective unit, an error description and a copy of your original invoice at hand.
- If our support staff agrees that your Cintiq is defective, you will be asked to give your address for picking up the defective unit.
- You will receive a refurbished Cintiq display unit in exchange for your defective unit.
- Note: The delivery time for the exchange unit varies between 2 and 5 work days, depending on the country it is shipped to. Pick-up service of the defective unit may be separate from the delivery of the exchange unit!
- Note: You will not get back the very same unit that you handed in! Should you prefer to get back the very same unit, please send in your defective Cintiq directly to your nearest Wacom office, or ask your local dealer or distributor.
- Note: Wacom Europe GmbH reserves the right to invoice for shipping, checking and refurbishing the sent-in Cintiq unit if a copy of the original invoice or the error description is missing, or if they do not correspond with the sent-in unit.
- Note: Wacom Europe GmbH reserves the right to invoice for the exchange unit if the defective unit has not arrived at Wacom Europe GmbH headquarters within 7 days after delivery of the exchange unit.

In any case you can send in your defective Cintiq to any Wacom office for repair, either directly or through your dealer or distributor, however the fast exchange program is only available as described above.

Note: Wacom Europe GmbH reserves the right to change or cancel this service for all or some regions without further notice.

GLOSSARY

Active area. The area of the pen display where your pen is detected.

Application-specific settings. Pen display tool and tablet settings that have been customized for individual applications. The Wacom Tablet control panel enables you to customize the pen to behave uniquely in different applications. Your application-specific settings are in effect whenever you use the application.

Aspect. The ratio between the vertical and horizontal dimension of the active area on the pen display.

Click force. The amount of force you must apply to the tip of your pen for a click to occur.

Double-click assist. A function of the Wacom Tablet control panel that makes it easier to double-click by setting the size of the double-click distance.

Double-click distance. The maximum distance (in screen pixels) that the cursor can move between clicks and still be accepted as a double-click. Increasing the double-click distance makes double-clicking easier, but may cause a delay in brush strokes in some graphics applications.

Double-click speed. The maximum time that can pass between clicks and still be accepted as a double-click.

Eraser-aware application. A software application that has built-in support for the pen eraser. These applications take advantage of the eraser in different ways, depending on what makes sense for the application.

Journal. A Microsoft Windows application that electronically simulates a physical journal pad, but with the advantages of digital note taking. For example, you can create quick sketches and jot handwritten notes that can be converted to text and sent on to colleagues for digital mark-up. Journal includes a variety of pen, marker, and highlighter tools, plus an eraser that is easily activated by the eraser end of your Wacom pen. Additionally, your handwritten content is searchable within Journal.

Modifier. Modifier keys include SHIFT, ALT, and CTRL for Windows, or SHIFT, CONTROL, COMMAND, and OPTION for Macintosh. You can customize your pen functions to simulate a modifier key.

Mouse acceleration. A setting that allows you to adjust the screen cursor acceleration when using mouse mode.

Mouse mode. A method for positioning the screen cursor. When you place the pen on the pen display, you can move the screen cursor with a “pick up and slide” motion similar to using a traditional mouse. This is known as relative positioning. See also “pen mode” in this glossary.

Mouse speed. A setting that allows you to adjust the speed at which your screen cursor moves when using mouse mode.

Nib. The replaceable pen tip.

Pen mode. A method of positioning the screen cursor. Wherever you place your pen on the interactive pen display, the screen cursor will jump to the corresponding point on the screen. This is known as absolute positioning, and is the default setting for the pen. Also, pen mode allows you to quickly position the screen cursor without having to first find it and then move it across the desktop. See also “mouse mode” in this glossary.

Pixel. The smallest unit of measure on your display screen.

Pressure sensitive. A quality of the Wacom pen tip and eraser that senses the amount of pressure being applied. This is used to create natural-looking pen, brush, and eraser strokes in applications that are pressure sensitive.

Pressure-sensitive application. Any application that supports pressure-sensitive input.

Proximity. The height above the pen display active area where the pen is detected.

Radial Menu. A hierarchical menu (in radial format). Each level of the menu consists of eight menu slices which may contain various features and options to choose from. You can customize the buttons of your pen to display this menu.

Screen cursor. The pointer on the display screen. Screen cursors come in different shapes (such as an I-beam, arrow, or box), depending on which application you are running.

Tablet PC Input Panel (TIP). The Microsoft Windows Vista Tablet PC Input Panel enables you to use your Wacom pen to create handwritten notes or work with an on-screen keyboard. The Input Panel dynamically converts your handwriting to text. The information you create can then be inserted into other documents, spreadsheets, or illustrations.

USB. Universal Serial Bus. A hardware interface standard for connecting computer peripheral devices. USB ports support hot-plugging, which allows you to connect or disconnect a USB device without turning off your computer.

Wintab. An interface standard used by Windows applications for receiving tablet information. The pen display supports all Wintab-compatible applications under Windows.

INDEX

- Accessories
 - available 72
 - ordering 71
- Auto-sync 38
- Calibration, of pen display 36
- CE declaration 75
- Cintiq
 - caring for 59
 - uninstalling 67
 - working with 24
- Cleaning
 - pen 59
 - pen display 59
- Clicking 27
- Control panel, opening 34
- Controls, testing 44
- Customizing 34
 - basics 35
 - learning more 34
 - opening control panel 34
- Digital ink, capabilities in Windows 65
- Display
 - installation 18
 - problems, troubleshooting 47
- Display stand
 - adjusting incline 12
 - mounting the pen display 11
 - removing pen display from 13
 - setting up 10
- Dragging 28
- Driver downloads, obtaining 58
- Erasing 28
- Ergonomics 24
- ExpressKeys 30
 - testing 44
 - using 31
- FCC notice 74
- Front view, pen display 14
- Industry Canada statement 75
- Information, product 71
- Input tools, testing 44
- Installation 17
 - software 23
 - step 1, display installation 18
 - step 2, pen tablet installation 22
 - system requirements 17
 - USB cable 22
- Interference, radio and television 74
- On Screen Display (OSD) 38
- Ordering, parts and accessories 71
- Parts
 - available 72
 - ordering 71
- Pen
 - clicking with 27
 - dragging with 28
 - erasing with 28
 - features 16
 - holding 26
 - positioning with 27
 - pressure sensitivity, working with 28
 - testing 46
 - tilt, drawing with 28
 - tip, replacing 60
 - using 26
 - using side switch 28
- Pen display
 - adjusting display settings 38
 - adjusting rotation 13
 - auto-sync 38
 - controls 30
 - factory presets 38
 - front view 14
 - mounting on stand 11
 - optional configurations 61
 - rear view 15

- troubleshooting 47
- uninstalling 67
- user settings 38
- using an alternate mount 62
- working with 24
- Pen holder, using 29
- Pen tablet
 - general problems 50
 - installation 22
 - Macintosh-specific problems 55
 - troubleshooting 50
 - Windows-specific problems 54
- Pen tip, replacing 60
- Pitch and phase, adjusting for VGA 37
- Positioning 27
- Power saving, functions 41
- Precautions 2
 - environment 2
 - handling 3
 - physical location 2
 - usage 3
- Presets, factory 38
- Pressure sensitivity, working with 28
- Rear view, pen display 15
- Rotation, adjusting 13
- settings, user 38
- Side switch, using 28
- Software, installation 23
- Specifications
 - display 69
 - display stand 70
 - general 68
 - pen 70
 - pen tablet 70
 - power adapter 70
 - product 68
- System requirements 17
- Tablet PC Input Panel, about 66
- Technical support, options 57
- Testing
 - Cintiq 42
 - controls 44
 - Expresskeys 44
 - input tools 44
 - pen 46
 - Touch Strips 45
- Tilt, drawing with 28
- Touch Strips 30
 - testing 45
 - using 32
- Troubleshooting 42
 - general display problems 47
 - pen display 47
 - pen tablet 50
 - testing Cintiq 42
 - testing controls 44
 - testing input tools 44
 - VGA problems 49
- Uninstalling 67
- Unpacking
 - Cintiq pen display 11
 - product contents 9
- USB cable, installation 22
- User settings 38
- VGA mode, troubleshooting 49
- Work area, setting up 24
- Working, with Cintiq 24

This page intentionally left blank.

This page intentionally left blank.

This page intentionally left blank.

WACOM TECHNOLOGY CORPORATION

1311 SE Cardinal Court
Vancouver, WA 98683
U.S.A.

Telephone: +1.360.896.9833
Fax: +1.360.896.9724

**WACOM CO., LTD.
JAPAN MARKETING AND SALES DIVISION**

Harmony Tower 21F, 1-32-2 Hon-Cho
Nakano-Ku, Tokyo 164-0012
Japan

Internet: <http://tablet.wacom.co.jp>

WACOM CHINA CORPORATION

Unit 2807, 28th Floor, SK Tower
No 6 Jia, Jianguomenwai Avenue,
Beijing, 100022, China

Internet: <http://www.wacom.com.cn>

WACOM AUSTRALIA PTY. LTD.

Unit 8, Stage 1 Cumberland Green
2-8 South Street Rydalmere
NSW 2116 Australia

Telephone: +61.2.9422.6700
Fax: +61.2.9420.2272

WACOM TAIWAN INFORMATION CO., LTD.

Suite 605, 6th floor, No. 205 Tun-Hwa North Road
Taipiei, 105 Taiwan

Telephone: +886.2.2712.2675
Fax: +886.2.2712.9789

WACOM EUROPE GMBH

Europark Fichtenhain A9
47807 Krefeld
Germany

Telephone: +49.(0)2151.3614.0
Fax: +49.(0)2151.3614.111

**WACOM CO., LTD.
ASIA PACIFIC MARKETING
AND SALES DIVISION**

Harmony Tower 18F, 1-32-2 Hon-Cho,
Nakano-Ku, Tokyo 164-0012
Japan

Telephone: +81.3.5309.1513
Fax: +81.3.5309.1514

WACOM KOREA CO., LTD.

25th Floor DMC iaan Sangam 2nd Complex, 1653
Sangam-dong, Mapo-gu, Seoul, Korea, 121-270

Telephone: +82.2.557.3894
Fax: +82.2.557.3895

WACOM SINGAPORE PTE. LTD.

3 Bishan Place,
CPF Bishan Building #06-08
Singapore 579838

Telephone: +65.6258.8640
Fax: +65.6258.8697



Installation Guide & Hardware Manual

Free Manuals Download Website

<http://myh66.com>

<http://usermanuals.us>

<http://www.somanuals.com>

<http://www.4manuals.cc>

<http://www.manual-lib.com>

<http://www.404manual.com>

<http://www.luxmanual.com>

<http://aubethermostatmanual.com>

Golf course search by state

<http://golfingnear.com>

Email search by domain

<http://emailbydomain.com>

Auto manuals search

<http://auto.somanuals.com>

TV manuals search

<http://tv.somanuals.com>