



Dear VIZIO Customer,

Congratulations on your new VIZIO VO32L FHDTV10A High Definition LCD Television purchase. Thank you for your support. For maximum benefit of your set, please read these instructions before making any adjustments, and retain them for future reference. We hope you will experience many years of enjoyment from your new VIZIO VO32L FHDTV10A High Definition Television.

For assistance, please call (877) 698-4946 or e-mail us at techsupport@vizio.com.

To purchase or inquire about accessories and installation services for your VIZIO LCD HDTV, please visit our website at www.vizio.com or call toll free at (888) 849-4623.

We recommend you register your VIZIO VO32L FHDTV10A either at our website www.VIZIO.com or fill in your registration card and mail it in. For peace of mind and to protect your investment beyond the standard warranty, VIZIO offers on-site extended warranty service plans. These plans give additional coverage during the standard warranty period. Visit our website or call us to purchase a plan.

Write down the serial number located on the back of your VO32L FHDTV10A.

Purchase Date _____



VIZIO is a registered trademark of VIZIO, Inc. dba V, Inc.

HDMI logo and "High Definition Multimedia Interface" are registered trademarks of HDMI Licensing LLC.

Manufactured under license from Dolby Laboratories.

Dolby and the double-D symbol are trademarks of Dolby Laboratories.

THE TRADEMARKS SHOWN HEREIN ARE THE PROPERTY OF THEIR RESPECTIVE OWNERS; IMAGES USED ARE FOR ILLUSTRATION PURPOSES ONLY. BRAVO, VIZIO AND THE V LOGO AND WHERE VISION MEETS VALUE AND OTHER VIZIO TRADEMARKS ARE THE INTELLECTUAL PROPERTY OF VIZIO INC. PRODUCT SPECIFICATIONS ARE SUBJECT TO CHANGE WITHOUT NOTICE OR OBLIGATION. © 2008 VIZIO INC. ALL RIGHTS RESERVED.



Important Safety Instructions

Your HDTV is designed and manufactured to operate within defined design limits, and misuse may result in electric shock or fire. To prevent your HDTV from being damaged, the following rules should be observed for the installation, use, and maintenance of your HDTV. Read the following safety instructions before operating your HDTV. Keep these instructions in a safe place for future reference.

- To reduce the risk of electric shock or component damage, switch off the power before connecting other components to your HDTV.
- Unplug the power cord before cleaning your HDTV. A damp cloth is sufficient for cleaning your HDTV. Do not use a liquid or a spray cleaner for cleaning your HDTV. Do not use abrasive cleaners.
- Always use the accessories recommended by the manufacturer to insure compatibility.
- When moving your HDTV from an area of low temperature to an area of high temperature, condensation may form in the housing. Wait before turning on your HDTV to avoid causing fire, electric shock, or component damage.
- Use only with the cart, stand, tripod, bracket, or table specified by manufacturer or sold with your HDTV. When a cart is used, use caution when moving the cart/HDTV combination to avoid injury from tip-over. Do not place your HDTV on an unstable cart, stand, or table. If your HDTV falls, it can injure a person and cause serious damage to your HDTV. Use only a cart or stand recommended by the manufacturer or sold with your HDTV.
- A distance of at least 3 feet should be maintained between your HDTV and any heat source, such as a radiator, heater, oven, amplifier etc. Do not install your HDTV close to smoke. Operating your HDTV close to smoke or moisture may cause fire or electric shock.
- Slots and openings in the back and bottom of the cabinet are provided for ventilation. To ensure reliable operation of your HDTV and to protect it from overheating, be sure these openings are not blocked or covered. Do not place your HDTV in a bookcase or cabinet unless proper ventilation is provided.
- Never push any object into the slots and openings on your HDTV cabinet. Do not place any objects on the top of your HDTV. Doing so could short circuit parts causing a fire or electric shock. Never spill liquids on your HDTV.
- Your HDTV should be operated only from the type of power source indicated on the label. If you are not sure of the type of power supplied to your home, consult your dealer or local power company.
- Do not apply pressure or throw objects at your HDTV. This may compromise the integrity of the display. The manufacturer's warranty does not cover user abuse or improper installations.
- The power cord must be replaced when using different voltage than the voltage specified. For more information, contact your dealer.
- Your HDTV is equipped with a **three-pronged grounded plug (a plug with a third grounding pin)**. This plug will fit only into a grounded power outlet. This is a safety feature. If your outlet does not accommodate the three-pronged, have an electrician install the correct outlet, or use an adapter to ground your HDTV safely. **Do not defeat the safety purpose of the grounded plug.**
- When connected to a power outlet, power is always flowing into your HDTV. To totally disconnect power, unplug the power cord.



- The lightning flash with arrowhead symbol within an equilateral triangle is intended to alert the user to the presence of un-isolated, dangerous voltage within the inside of your HDTV that may be of sufficient magnitude to constitute a risk of electric shock to persons.



- The exclamation point within an equilateral triangle is intended to alert the user to the presence of important operating and servicing instructions in the literature accompanying your HDTV.



- Do not overload power strips and extension cords. Overloading can result in fire or electric shock.
- The wall socket should be installed near your HDTV and easily accessible.
- Only power of the marked voltage can be used for your HDTV. Any other voltage than the specified voltage may cause fire or electric shock
- Do not touch the power cord during lightning. To avoid electric shock, avoid handling the power cord during electrical storms.
- Unplug your HDTV during a lightning storm or when it will not be used for long period of time. This will protect your HDTV from damage due to power surges.
- Do not attempt to repair or service your HDTV yourself. Opening or removing the back cover may expose you to high voltages, electric shock, and other hazards. If repair is required, contact your dealer and refer all servicing to qualified service personnel.
- Keep your HDTV away from moisture. Do not expose your HDTV to rain or moisture. If water penetrates into your HDTV, unplug the power cord and contact your dealer. Continuous use in this case may result in fire or electric shock.
- Do not use your HDTV if any abnormality occurs. If any smoke or odor becomes apparent, unplug the power cord and contact your dealer immediately. Do not try to repair your HDTV yourself.
- Avoid using dropped or damaged appliances. If your HDTV is dropped and the housing is damaged, the internal components may function abnormally. Unplug the power cord immediately and contact your dealer for repair. Continued use of your HDTV may cause fire or electric shock.
- Do not install your HDTV in an area with heavy dust or high humidity. Operating your HDTV in environments with heavy dust or high humidity may cause fire or electric shock.
- Follow instructions for moving your HDTV. Ensure that the power cord and any other cables are unplugged before moving your HDTV.
- When unplugging your HDTV, hold the power plug, not the cord. Pulling on the power cord may damage the wires inside the cord and cause fire or electric shock. When your HDTV will not be used for an extended period of time, unplug the power cord.
- To reduce risk of electric shock, do not touch the connector with wet hands.
- Insert batteries in accordance with instructions. Incorrect polarities may cause the batteries to leak which can damage the remote control or injure the operator.
- If any of the following occurs, contact the dealer:
 - The power cord fails or frays.
 - Liquid sprays or any object drops into your HDTV.
 - Your HDTV is exposed to rain or other moisture.
 - Your HDTV is dropped or damaged in any way.
 - The performance of your HDTV changes substantially.



Television Antenna Connection Protection

External Television Antenna Grounding

If an outside antenna/satellite dish or cable system is to be connected to the TV, make sure that the antenna or cable system is electrically grounded to provide some protection against voltage surges and static charges.

Article 810 of the National Electrical Code, ANSI/NFPA 70, provides information with regard to proper grounding of the mast and supporting structure, grounding of the lead-in wire to an antenna discharge unit, size of the grounding conductors, location of antenna discharge unit, connection to grounding electrodes, and requirements of the grounding electrode.

Lightning Protection

For added protection of the TV during a lightning storm or when it is left unattended or unused for long periods of time, unplug the TV from the wall outlet and disconnect the antenna or cable system.

Power Lines

Do not locate the antenna near overhead light or power circuits, or where it could fall into such power lines or circuits.

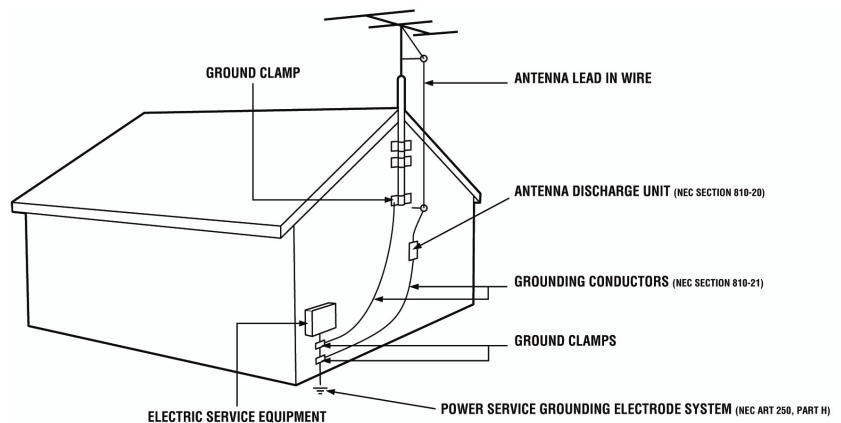

Remember, the screen of the coaxial cable is intended to be connected to earth in the building installation.

FCC Bulletin for New TV Owners

After February 17, 2009, a television receiver with only an analog broadcast tuner will require a converter box to receive full power over-the-air broadcasts with an antenna because of the Nation's transition to digital broadcasting. Analog-only TVs should continue to work as before to receive low power, Class A or translator television stations and with cable and satellite TV services, gaming consoles, VCRs, DVD players, and similar products.

Information about the DTV transition is available from <http://www.DTV.gov> or this manufacturer at 877 MY VIZIO (877-698-4946), and from <http://www.dtv2009.gov> or 1-888-DTV-2009 for information about subsidized coupons for digital-to-analog converter boxes.

Your HDTV comes with a built-in tuner capable of processing digital broadcasts, making it easier for you to receive this type of signal without the need of an extra converter box.



Opening the Package

Your VIZIO VO32L FHDTV10A and accessories are carefully packed in a cardboard carton that has been designed to protect it from transportation damage. Now you have opened the carton check that the VO32L FHDTV10A is in good condition and that all of the accessories are included.

The VO32L FHDTV10A weighs approximately 28 lbs and is about 32" wide; please exercise care when unpacking the HDTV.

The screen can easily be scratched or broken so please handle the product gently and never place the HDTV with the glass facing downwards on a surface without protective padding.

IMPORTANT: Save the carton and packing material for future shipping.

Package Contents

VIZIO VO32L FHDTV10A

VIZIO Remote Control VR3P

VIZIO Removable Stand
and Instructions

Power Cord

Premium Size Screen Cleaning Cloth

This User Manual

Quick Setup Guide

Registration Card

VIP Services Brochure

2 AA Batteries for the Remote Control

HDMI Cable



Caution: Do not apply pressure or throw objects at your HDTV. This may compromise the integrity of the display. The manufacturer's warranty does not cover user abuse or improper installations.



Additional Certified Accessories for the VIZIO VO32L FHDTV10A are sold separately

Wall Mounts

High Definition Cables

Extra or replacement Remote

VIZIO also offers Installation Services and Extended Warranty Services for your VIZIO VO32L FHDTV10A

To purchase or inquire about additional accessories and services for your VIZIO product, visit our web site at www.VIZIO.com or call us toll free at 888-VIZIOCE (888-849-4623)

Installation Preparation

Please read this user manual carefully before installing your VIZIO HDTV.

The power consumption of the TV is up to 110W, please use the power cord designated for TV. When an extension cord is required, use one with the correct power rating. The cord must be grounded and the grounding feature must not be defeated.

The TV should be installed on a flat surface to avoid tipping. For proper ventilation, you must allow space between the back of the TV and the wall. If you would like to mount your TV on the wall, please see below 'Preparing Your LCD HDTV for Wall Mounting' for additional information. Avoid installing the TV in places with high humidity, dust or smoke so as not to shorten the service life of the electronic components. Install the TV in landscape orientation; any 90° clockwise or counter-clockwise installation may induce poor ventilation and excessive component damage.

The VIZIO VO32L FHDTV10A can either be kept on the stand base or mounted on the wall for viewing. If you choose to mount the VO32L FHDTV10A on the wall, please refer to "Preparing your LCD HDTV for Wall Mounting" on page 7.

VIZIO offers professional installation services. Please contact VIZIO for more information on these services at 888-VIZIOCE (888-849-4623) or www.VIZIO.com.



TV Setup and Stand Assembly

Note: We strongly recommend that two people perform the setup and assembly due to the weight and size of the TV.

To unpack the TV and stand base:

1. Remove the remote control, batteries, and power cord from the foam end caps.
2. Remove the two top foam end caps.
3. Remove the stand base under foam end cap.
4. Remove the TV from the box and lay it face down on a clean, flat surface.

Note: Make sure that the surface is free of debris to prevent the TV screen from getting scratched.

To attach the TV stand base:

1. Line up the arrows on the stand neck (attached to the TV) with the arrows on the stand base.
2. Push the stand base onto the stand neck.
3. On the bottom of the base, insert the four included screws and tighten.
4. Move the TV into an upright position.

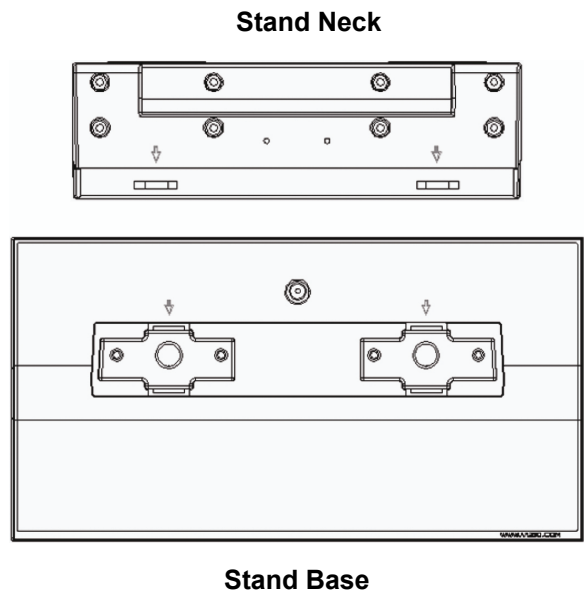

Preparing Your LCD HDTV for Wall Mounting

To remove the stand base

5. Unplug all of the cables and cords from your VO32L FHDTV10A.
6. Place the VO32L FHDTV10A face down on a soft and flat surface (blanket, foam, cloth, etc) to prevent any damage to the TV.
7. Push up the plastic panel on the back of the stand and lift it away once to release.



8. Remove the eight (8) screws that were hidden by the panel, while holding the base.
9. Carefully remove the stand base.

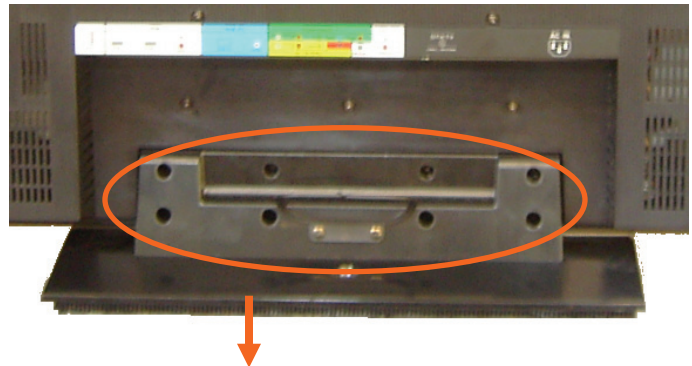

Now, the VO32L FHDTV10A can fit securely to a mount (sold separately) by utilizing the mounting holes in the center of the back panel of the TV. Please make sure to read the instructions of your specific mount to properly hang the VO32L FHDTV10A.

The pitch of the mounting holes is 400mm horizontally and 200mm vertically.

The screw type required is metric M6, 1.00mm pitch. The length of the screws will depend on the thickness plate being attached to TV set, our brackets come with different length screws.

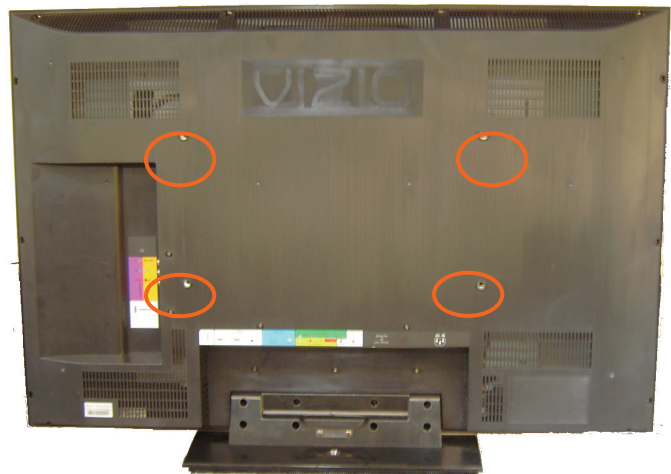

To find the perfect mount for the VIZIO VO32L FHDTV10A, browse VIZIO's certified mount selection at www.VIZIO.com or call directly 888-VIZIOCE (888-849-4623).



Table of Contents

Chapter 1 Basic Controls and Connections	11
Front Panel.....	11
Side Panel Controls.....	11
Rear Panel Connections	12
Right-Side Panel Connection	13
VIZIO Remote Control.....	14
Insertion of Batteries in the Remote Control	16
Remote Control Range.....	16
VIZIO Remote Control Precautions	16
Chapter 2 Connecting Equipment	17
Which Video Connection Should I Use?.....	17
Connecting Coaxial (RF).....	18
Using Your Antenna or Digital Cable for DTV.....	18
Using the Antenna or Cable through your VCR.....	18
Connecting Your HDTV Set-Top Box.....	19
Using HDMI Input.....	19
Using Component Video.....	21
Connecting Your Basic Set-Top Box.....	22
Using Composite Video	22
Using Coax (RF).....	22
Connecting Your DVD Player.....	23
Using HDMI Input	23
Using Component Video.....	25
Using S-Video (AV1/S-VIDEO).....	26
Using Composite (AV) Video Input.....	26
Connecting Your VCR or Video Camera.....	27
Connecting an external Receiver/Amp.....	28
Optical Output of Audio received	29
Connecting a PC Computer	30
Preset PC Resolutions	31
Resolution (1920x1080) through RGB (15-Pin VGA) Input.....	31
Chapter 3 Setting Up to Watch Television	32
Basic LCD HDTV Start Up	32
Watching a TV Program.....	38
Adjusting Basic HDTV Settings	39
Program Information.....	40
Information on HDTV Status	40
Chapter 4 Advanced Adjustment of HDTV	41
Using the On Screen Display (OSD).....	41
DTV / TV Input Picture Adjustment.....	42
Picture Mode	42
Backlight.....	42
Brightness.....	43
Contrast.....	43
Color.....	43
Tint	44
Sharpness	44
Advanced Video Features	44
Reset Picture Mode	46
DTV / TV Input Audio Adjustment	46
Audio Mode	46
Equalizer.....	47
Balance.....	47
SRS TSXT.....	47
Digital Audio Out.....	48
Speakers	48
Analog Audio Out	48
Lip Sync.....	48
Reset Audio Mode.....	49
DTV / TV Tuner Setup.....	49



Tuner Mode	49
Auto Search	49
Partial Channel Search	50
Skip Channel	50
MTS	50
Time Zone	50
Daylight Saving	51
DTV / TV Input Setup	51
Language	51
PIP (Picture-in-Picture)	51
Sleep Timer	53
Wide	53
Input Naming	54
CC (Closed Caption)	55
H/V Position	56
DTV / TV Input Parental Control	57
Rating Enable	57
Channel Block	58
US TV Rating	58
US Movie Rating (For US)	59
Canadian English Rating	59
Canadian French Rating	60
DTV Rating	60
Blocked Unrated Programming	61
Change the Password	61
System Reset	62
HDMI Input Picture Adjustment	62
HDMI Input Audio Adjustment	63
HDMI Input Setup	63
Video Input Picture Adjustment	63
Video Input Audio Adjustment	64
Video Input Setup	64
Video Input Parental Control	65
PC Input Picture Adjustment	65
Auto Adjust	65
Backlight	65
Brightness	66
Contrast	66
Color Temperature	67
H-SIZE	68
H-Position	68
V-Position	68
Fine Tune	68
PC Input Audio Adjustment	69
PC Input Setup	69
Understanding Viewing Features	70
Viewing Modes	70
Chapter 5 Maintenance and Troubleshooting	71
Maintenance	71
Troubleshooting Guide	72
Telephone & Technical Support	74
Compliance	75
FCC Class B Radio Interference Statement	75
Chapter 6 Miscellaneous Information	76
Specifications	76
Glossary – Standard Definitions	77



Chapter 1 Basic Controls and Connections

Front Panel

POWER 'VIZIO' LIGHT– The VIZIO name lights white when powered on and orange when powered off.

REMOTE CONTROL SENSOR – This is the window through which all of the remote control signals pass to the sensor. Point the remote control directly at this window for the best response to the remote signal.



Side Panel Controls

POWER () – Switch the VO32L FHDTV10A on by pressing the button once. Press the button again to the VO32L FHDTV10A off.

MENU – This button activates the On Screen Display (OSD). If a sub-menu is active, pressing this button will proceed to the next menu level.

CH + / - – Use these buttons to step up or down the TV channels. While the OSD is active, these buttons function as up and down controls in the OSD menus.

Input
TV
AV1
AV2
COMPONENT1
COMPONENT2
RGB
HDMI1
HDMI2
HDMI3

VOL + / - – Use these buttons to increase or decrease to the speaker volume. While the OSD is active, these buttons function as left and right controls in the OSD menus.

INPUT – Repeated pressing of this buttons steps through the input sources in the following sequence: TV, AV1/S-Video, AV2, Component1, Component2, RGB, HDMI 1, HDMI 2 and HDMI 3. Once you have stepped through the entire sequence, you will return to the beginning. If a sub-menu is active, pressing this button will return to the previous menu level.

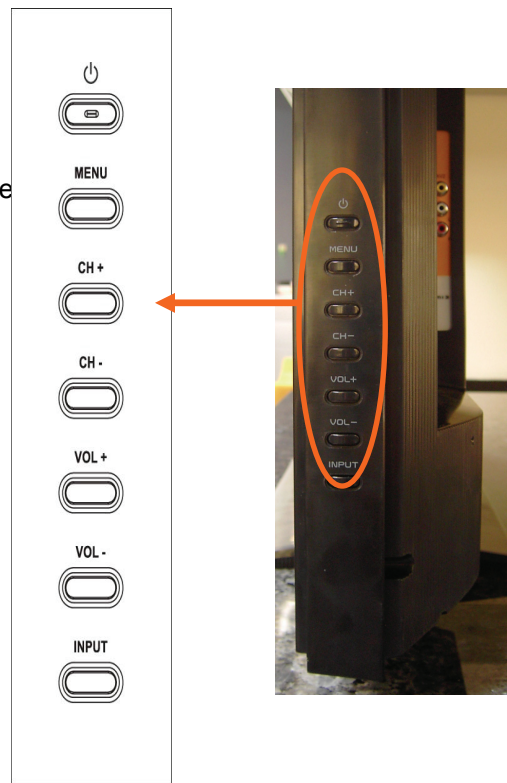

Additionally, when the OSD is active, this button confirms the menu function to be adjusted. When the OSD is not active, pressing this button will display the current input mode.



Rear Panel Connections

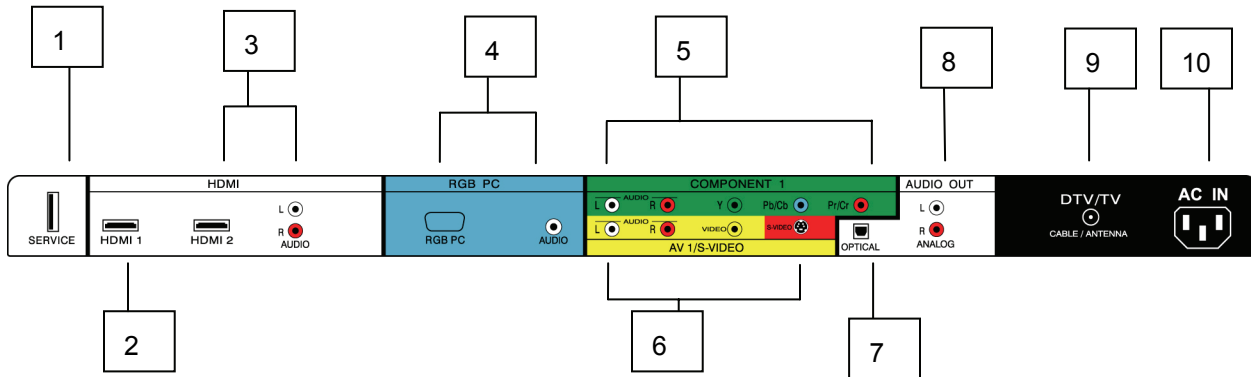

1. **SERVICE** – This custom communication port is for factory service only. **Use of this input for any purpose other than factory authorized service will void the manufacturer’s warranty of this equipment.**
2. **HDMI 1** – Connect the primary source for digital video such as a DVD multimedia player or set top box through this all digital connector. The white color band on the rear of the TV indicates this connection.
3. **HDMI 2** – Connect a secondary source for digital video such as a DVD multimedia player or set top box through this all digital connector. The white color band on the rear of the TV indicates this connection. For users who want to connect to a DVI enabled device, use a DVI-HDMI cable and connect the Analog Audio output of the device to the L+R AUDIO here. . Your VIZIO Certified HDMI and HDMI-DVI cables are available for purchase from www.VIZIO.com or by calling 888-VIZIOCE (888-849-4623).
4. **RGB PC** – Connect the video and audio from a computer here. The blue color band on the rear of the TV indicates this connection. A 1/8” plug stereo cable is needed to connect the audio out from the computer to the connector in the rear of the TV for audio from computer.
5. **COMPONENT1 (YPb/CbPr/Cr with Audio L/R)** – Connect the source for component video devices such as a DVD Player or set top box here. From left to right, use white for left audio and red for right audio inputs, green for Y, blue for Pb (or Cb) and red for Pr (or Cr). The green color band on the rear of the TV indicates this connection.
6. **AV1/S-VIDEO IN** – Connect the primary source for composite video devices, such as a VCR or video game. Use the white and red connectors to connect the external audio from the same source, then use the S-Video or yellow connector to connect the external video from the same source. The S-Video, if connected, will take priority over AV RCA (yellow) connector. The yellow color band on the rear of the TV indicates this connection.
7. **OPTICAL DIGITAL AUDIO OUT** – When a digital audio signal is associated with an input which is selected for viewing, the digital audio associated with digital programming will be available on this SPDIF Optical connector for connection to your home theatre system. The white color band on the rear of the TV indicates this connection.
8. **ANALOG AUDIO OUT** – Connect the audio from the LCD HDTV to an external device, such as a home theater system, external amplifier or stereo. Speakers cannot be connected directly to here. The white color band on the rear of the TV indicates this connection.
9. **DTV** – Connect to an antenna or digital cable (out-of-the-wall, not from Cable Box) for Digital TV.*
10. **AC IN** – Plug-in the supplied AC Power Cord here.

* For digital TV stations in your area visit www.antennaweb.org.



Right-Side Panel Connection

1. **HEADPHONE** – Connect your headphone here for personalized listening without disturbing others.
2. **AV2** – Connect the secondary source for composite video devices, such as a VCR or video game. Use the white and red connectors to connect the external audio from the same source, then use the yellow connector to connect the external video from the same source. The orange color band on the side of the TV indicates this connection. *Note: The red and white audio connectors are shared between AV2 and COMPONENT2.*
3. **COMPONENT2 (YPb/CbPr/Cr with Audio L/R)** - Connect the source for component video devices such as a DVD Player or set top box here. From top to bottom, left to right, use green for Y, blue for Pb (or Cb), red for Pr (or Cr), then connect white for left audio and red for right audio inputs under the orange band. The purple color band on the side of the TV indicates this connection. *Note: The red and white audio connectors are shared between AV2 and COMPONENT2.*
4. **HDMI 3** - Connect the third source for digital video such as a DVD multimedia player or set top box through this all digital connector. The white color band on the side of the TV indicates this connection.

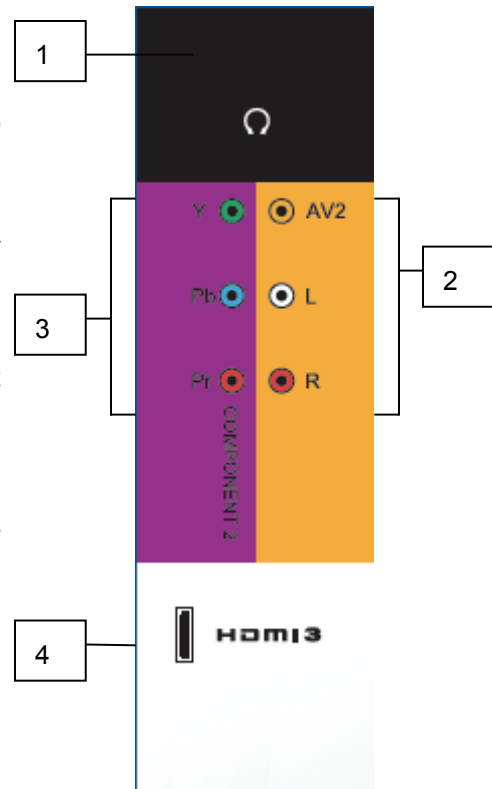

VIZIO Remote Control

GUIDE – This button displays program information. Press this button once when in TV mode and the information of the program being viewed is shown. Press it a second time and the Electronic Programming Guide will appear in the screen. In any other mode when this button is pressed, the screen will display the selected input plus the definition of the signal; i.e. HDMI 720p, HDMI 1080i, etc.

 **POWER** – Press this button to turn the TV on from the Standby mode. Press it again to return to the Standby mode.

HDMI – Press this button to select the HDMI input.

MUTE – This button turns the sound on and off.

TV – Press this button to select TV.

COMPONENT – Press this button to select the Component (YPbPr) input.

LAST – This button recalls the previously viewed channel. If the On-Screen Display (OSD) menu is being used, this button will allow you to get back to previous menu screen or out to your program when you press it repeatedly.

AV – Press this button to select AV (either Composite or S-Video) input.

 **(MENU)** – Use this button for the On-Screen Display (OSD) menu. When it is used within a menu selection, the **V** ball key will help you to make the selection of the feature to be adjusted after it has been highlighted.

 -These labeled buttons are used to navigate the OSD menu.

 When navigating the OSD menu, the arrows control the direction up and down or left and right. They will also be used as value settings when the slide bar is shown on the screen and option settings to turn a feature off or on. During regular TV watching these keys will provide us with the control functions of Volume (up or down) and Channel (up or down).

Channel up or down will not function when a cable box or satellite receiver is being used as the source of the signal.

PIP – Use this button to activate the Picture-in-Picture mode.

SWAP – Used to swap the inputs from the main screen and the sub-screen while in PIP mode.

FREEZE – Press this button to “freeze-frame” the current screen. Press this button again to continue playing.

NUMBER BUTTON PAD – Use these buttons to select a channel or enter a password.



INPUT – This button allows the user to cycle through the inputs. Repeatedly pressing of this button will step you through the input sources in the following sequence: TV, AV1/S-VIDEO, AV2, Component 1, Component 2, RGB, HDMI 1, HDMI 2 and HDMI 3. Once you have stepped through the entire sequence, you will return to the beginning.

- **(DASH)** – When selecting a digital channel directly use this button for the separation of main and sub-channels. For example, channel 28-2 would be selected by the button sequence 2 8 ENTER 2.

Input
TV
AV1
AV2
COMPONENT1
COMPONENT2
RGB
HDMI1
HDMI2
HDMI3



Insertion of Batteries in the Remote Control

Insert two AA batteries into the remote control. Make sure that you match the (+) and (-) symbols on the batteries with the (+) and (-) symbols inside the battery compartment. Re-attach the battery cover.

Precautionary Tips for Inserting the Batteries:

Only use the specified AA batteries.

Do not mix new and old batteries. This may result in cracking or leakage that may pose a fire risk or lead to personal injury.

Inserting the batteries incorrectly may also result in cracking or leakage that may pose a fire risk or lead to personal injury.

Dispose of the batteries in accordance with local laws and regulations.

Keep the batteries away from children and pets.

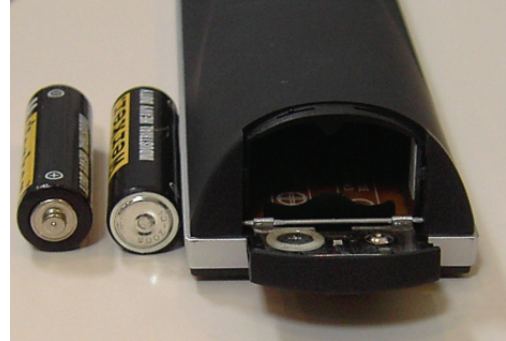

Remote Control Range

Point the remote control at the remote control sensor to transmit the commands.

Do not place any obstacles between the remote control and the receiver window.

The effective range of the remote control is approximately 30 feet (10 meters) from the front of the receiver window, 30° to the left and right, 20° up and down.

VIZIO Remote Control Precautions

The remote control should be kept dry and away from heat sources. Avoid humidity.

If the TV responds erratically to the remote control or does not respond at all, check the batteries. If the batteries are low or exhausted, replace them with fresh batteries.

When not using the remote control for a long period of time, remove the batteries.

Do not take the batteries apart, heat them, or throw them into a fire.

Do not subject the remote control to undue physical stress, such as striking or dropping it.





Do not attempt to clean the remote control with a volatile solvent. Wipe it with a clean, damp cloth.



Chapter 2 Connecting Equipment

Which Video Connection Should I Use?

The VIZIO VO32L FHDTV10A has six different ways to connect your video equipment from a basic connection to the most advanced for digital displays.

Connection Quality (type)	Connector	Rear and Side Panel Color Codes	Description
Best (digital)		White	HDMI (High-Definition Multimedia Interface) - It is the first and only industry-supported, uncompressed, all-digital audio/video interface. HDMI provides an interface between any audio/video source, such as a set-top box, DVD player, or A/V receiver and an audio and/or video monitor, such as a digital television (DTV), over a single cable.
Best (digital) ----- -- Good (analog)		Black	DTV Coaxial RF. When used for MPEG2 encoded bit streams from ATSC broadcast programming, this input takes advantage of the High Definition content. ----- TV Coaxial RF. This is the connection for standard NTSC TV using antenna or cable.
Best (analog)		Blue	RGB PC (VGA) – This video input has separate red, green and blue color components. The signal carries horizontal and vertical sync information on the green signal. This is most commonly used for PC input.
Better (analog)		Green and Purple	Component1/2 - The video signal is separated into three signals, one containing the black-and-white information and the other two containing the color information. This enhancement over S-Video takes advantage of the superior picture provided by progressive scan DVD players and HDTV formats.
Good (analog)		Yellow, Orange and Red	S-Video (AV1) - The video signal is separated into two signals, one containing the black-and-white information and the other containing the color information. Separating the color in this way avoids 'cross color' effects where closely spaced black and white lines are erroneously displayed in color. It also enables text to be displayed more sharply. Composite (AV1/2) - The complete video signal is carried through this single pin connector. This is the most commonly used video connection.

Note: For more info refer to the Quick Start Guide



Connecting Coaxial (RF)

Using Your Antenna or Digital Cable for DTV

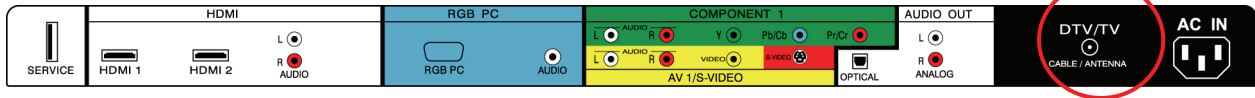

1. Turn off the power to the HDTV.
2. Connect the coaxial (RF) connector from your antenna or digital cable (out-of-the-wall, not from the Cable Box) to the DTV/TV CABLE/ANTENNA connector on the rear of the HDTV.
3. Turn on the power to the HDTV.
4. Select DTV using the INPUT button on the remote or side of the HDTV, or directly by pressing the TV button on the Remote Control.



Note:

- a) Not all digital TV broadcasts are High Definition (HD). Refer to the program guides, or consult your cable, satellite or TV station operator.
- b) Digital broadcasts are not available in all areas. Refer to www.antennaweb.org for detailed information.
- c) Make sure the antenna and coaxial cable are correctly grounded.

Using the Antenna or Cable through your VCR

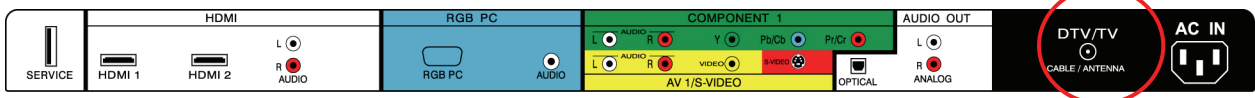

1. Turn off the power to the HDTV and VCR.
2. Connect the "Output to TV", "RF Out" or "Antenna Out" connector on the rear of your VCR to the DTV/TV CABLE/ANTENNA connector at the rear of the HDTV.
3. Turn on the power to the HDTV and VCR.
4. Select TV using the INPUT button on the remote or side of the HDTV, or directly by pressing the TV button on the Remote Control.



Note: If you have an off-air antenna or cable TV, connect it to the "Antenna In" connector on the rear of your VCR.



Connecting Your HDTV Set-Top Box

Using HDMI Input

HDTV Set-Top Boxes that have a HDMI digital interface should be connected to the HDMI input of the LCD HDTV for optimal results.

Note: To maintain the display quality, use a VIZIO certified HDMI cable. Length is available up to 10 meters. See www.VIZIO.com or call 1-888-VIZIOCE (1-888-849-4623) for details.

Connecting your HDTV Set-Top Box (Best):

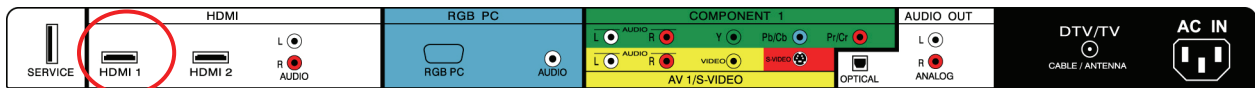

1. Turn off the power to the HDTV and HDTV Set-Top Box.
2. Connect a HDMI cable to the HDMI output of your HDTV Set-Top Box and the other end to the HDMI Input (white color area) at the rear of the HDTV.
3. Turn on the power to the HDTV and HDTV Set-Top Box.
4. Select HDMI using the INPUT button on the remote or side of the HDTV, or directly by pressing the HDMI button on the Remote Control.

Note:

- a) The HDMI input on the HDTV supports High-bandwidth Digital Content Protection (HDCP). HDCP encrypts the transmission between the video source and the digital display for added security and protection.
- b) Refer to your HDTV Set-Top Box user manual for more information about the video output requirements of the product or consult your cable or satellite operator.



For HDTV Set-Top Boxes with DVI:

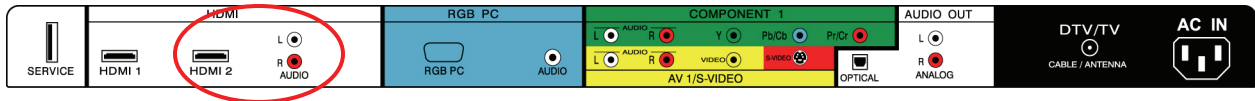

1. Turn off the power to the HDTV and HDTV Set-Top Box.
2. Using a HDMI-DVI cable, connect the DVI end to your HDTV Set-Top Box and the HDMI end to the HDMI 2 Input (white color area) at the rear of the HDTV.
3. Using an audio cable (white and red connectors), connect the cable to the audio output connectors associated with the DVI output on your HDTV Set-Top Box and connect the other end to the audio connectors associated with the HDMI input (white area) at the rear of the HDTV.
4. Turn on the power to the HDTV and HDTV Set-Top Box.
5. Select HDMI 2 using the INPUT button on the remote or side of the HDTV, or directly by pressing the HDMI button on the Remote Control.

Note:

- a) The HDMI input on the HDTV supports High-bandwidth Digital Content Protection (HDCP). HDCP encrypts the transmission between the video source and the digital display for added security and protection.
- b) Refer to your HDTV Set-Top Box user manual for more information about the video output requirements of the product or consult your cable or satellite operator.



Using Component Video

Connecting your HDTV Set-Top Box (Better):

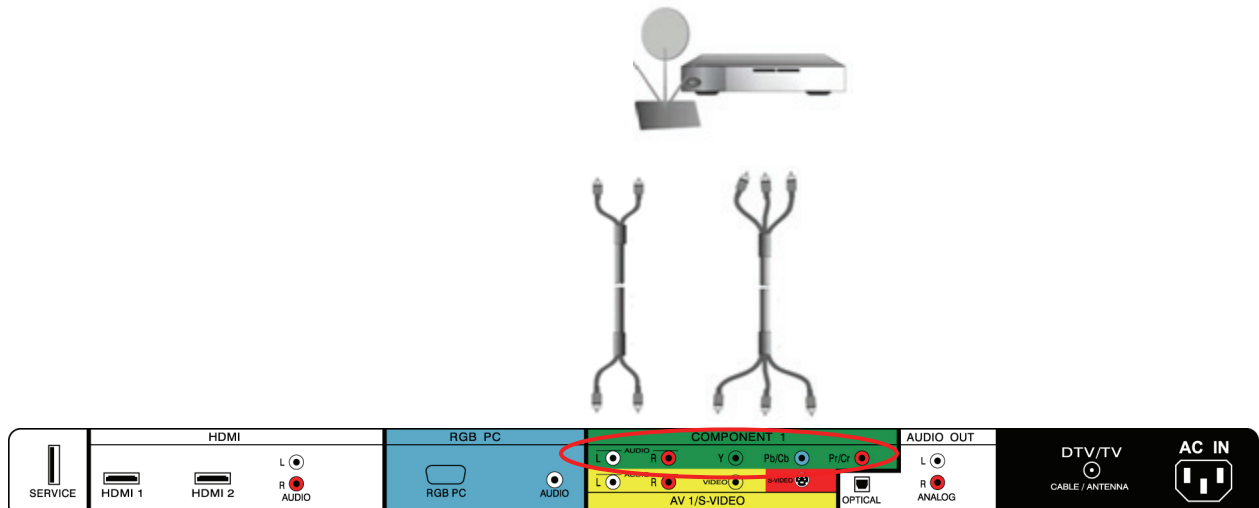

1. Turn off the power to the HDTV and HDTV Set-Top Box.
2. Connect the Y (green color) connector on your HDTV Set-Top Box to the corresponding Y (green color) connector in the Component1 group (green color area - row of connectors nearest to you when viewing from the rear of the TV) at the rear of the HDTV.
3. Connect the Pb (blue color) connector on your HDTV Set-Top Box to the corresponding Pb (blue color) connector in the Component1 input (green color area - row of connectors nearest to you when viewing from the rear of the TV) at the rear of the HDTV.
4. Connect the Pr (red color) connector on your HDTV Set-Top Box to the corresponding Pr (red color) connector in the Component1 input (green color area - row of connectors nearest to you when viewing from the rear of the TV) at the rear of the HDTV.
5. Using an audio cable (white and red connectors), connect the cable to the audio output connectors associated with the Component output on your HDTV Set-Top Box and connect the other end to the audio connectors associated with the Component1 input (green color area) at the rear of the HDTV.
6. Turn on the power to the HDTV and HDTV Set-Top Box.
7. Select Component1 using the INPUT button on the remote or side of the HDTV, or directly by pressing the Component button on the Remote Control.

Note:

- a) Refer to your HDTV Set-Top Box user manual for more information about the video output requirements of the product or consult your cable or satellite operator.
- b) If Component1 is already connected to another device, or you do not wish to use Component1, connect the green, blue and red video adapters into Component2 connectors (purple color) and the audio connectors into the AV2 connectors (orange color).



Connecting Your Basic Set-Top Box

Using Composite Video



1. Turn off the power to the HDTV and Set-Top Box.
2. Using the AV Cable, connect the Video (yellow color) connector on your Set-Top Box to the corresponding Video (yellow color) connector in the AV1 input (yellow color area) at the rear of the HDTV.
3. Using the white and red connectors, connect the cable to the audio output connectors associated with the Video output on your Set-Top Box and connect the other end to the audio connectors associated with the AV input (yellow color area) at the rear of the HDTV.
4. Turn on the power to the HDTV and Set-Top Box.
5. Select AV1 using the INPUT button on the remote or side of the HDTV, or directly by pressing the AV button on the Remote Control.



Using Coax (RF)

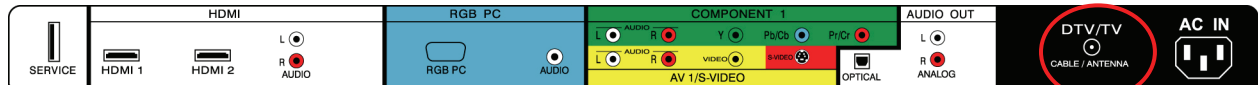

1. Turn off the power to the HDTV and Set-Top Box.
2. Using a Coax (RF) cable, connect one end to the TV OUT (RF) on your Set Top Box and the other end to the DTV/TV input at the rear of the HDTV.
3. Turn on the power to the HDTV and Set-Top Box.
4. Select TV using the INPUT button on the remote or side of the HDTV, or directly by pressing the TV button on the Remote Control.

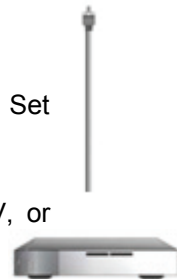

Note: Refer to your Set Top Box user manual for more information about selecting the video or RF output of the product.



Connecting Your DVD Player

You have several options for connecting your DVD player to your VO32L FHDTV10A; HDMI, Component, AV (S-Video or Composite) inputs. Based on your configuration, you can decide which option is right for you.

Using HDMI Input

DVD players that have a digital interface such as HDMI (High Definition Multimedia Interface) should be connected to the HDMI input of the VIZIO VO32L FHDTV10A for optimal results.

Note: To maintain the display quality, use a VIZIO certified HDMI cable. Length is available up to 10 meters. See www.VIZIO.com or call 1-888-VIZIOCE (1-888-849-4623) for details.

Connecting your DVD Player (Best):



1. Turn off the power to the HDTV and DVD player.
2. Connect a HDMI cable to the HDMI output of your DVD player and the other end to the HDMI1 Input (white color area) at the rear of the HDTV.
3. Turn on the power to the HDTV and DVD player.
4. Select HDMI1 using the INPUT button on the remote or side of the HDTV, or directly by pressing the HDMI button on the Remote Control.



For DVD Players with DVI:

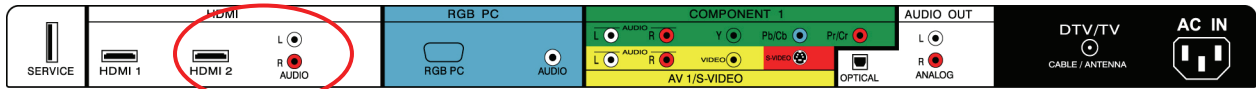

1. Turn off the HDTV and DVD player.
2. Using a HDMI-DVI cable, connect the DVI end to your DVD player and the HDMI2 end to the HDMI Input (white color area) at the rear of the HDTV.
3. Connect an audio cable (white and red connectors) to the audio output connectors associated with the DVI output of the DVD player and connect the other end to the audio connectors by the HDMI input (white area) at the rear of the HDTV.
4. Turn on the power to the HDTV and your DVD player.
5. Select HDMI 2 using the INPUT button on the remote or side of the HDTV, or directly by pressing the HDMI button on the Remote.

Note: Refer to your DVD player user manual for more information about the video output requirements of the product.



Using Component Video

Connecting your DVD Player (Better):

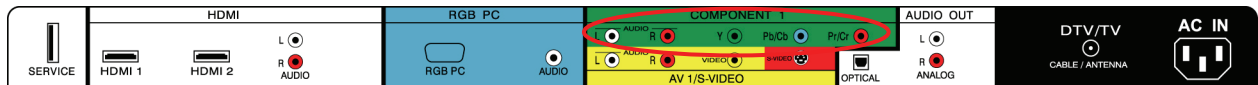

1. Turn off the power to the HDTV and DVD player.
2. Connect the Y (green color) connector on your DVD player to the corresponding Y (green color) connector in the Component1 input (green color area - row of connectors nearest to you when viewing from the rear of the TV) at the rear of the HDTV.
3. Connect the Pb (blue color) connector on your DVD player to the corresponding Pb (blue color) connector in the Component1 input (green color area - row of connectors nearest to you when viewing from the rear of the TV) at the rear of the HDTV.
4. Connect the Pr (red color) connector on your DVD player to the corresponding Pr (red color) connector in the Component1 input (green color area - row of connectors nearest to you when viewing from the rear of the TV) at the rear of the HDTV.
5. Using an audio cable (white and red connectors), connect the cable to the audio output connectors associated with the Component1 output on your DVD player and connect the other end to the audio connectors associated with the Component input (green color area) at the rear of the HDTV.
6. Turn on the power to the HDTV and DVD player.
7. Select Component1 using the INPUT button on the remote or side of the HDTV, or directly by pressing the Component1 button on the Remote Control.

Note:

- a) Refer to your DVD player user manual for more information about the video output requirements of the product.
- b) If Component1 is already connected to another device, or you do not wish to use Component1, connect the green, blue and red video adapters into Component2 connectors (purple color) and the audio connectors into the AV2 connectors (orange color).



Using S-Video (AV1/S-VIDEO) Connecting your DVD Player (Good):

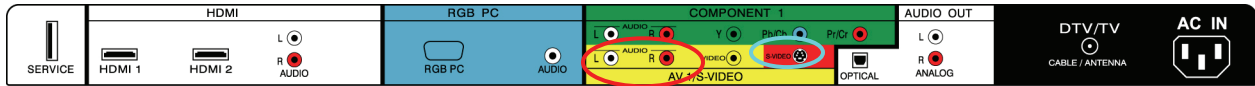

1. Turn off the power to the HDTV and DVD player.
2. Connect the S-Video jack on the rear of your DVD player to the S-Video jack in the AV1/S-VIDEO input (yellow/red area) at the rear of the HDTV.
3. Connect an audio cable (white and red connectors) to the audio output connectors associated with the S-Video output on your DVD player and connect the other end to the audio connectors associated with the AV input (yellow/red area) at the rear of the HDTV.
4. Turn on the power to the HDTV and DVD player.
5. Select AV using the INPUT button on the remote or side of the HDTV, or directly by pressing the AV button on the Remote Control.



Using Composite (AV) Video Input Connecting your DVD Player (Good) :

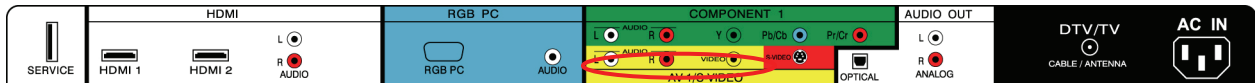

Turn off the power to the HDTV and DVD player.

1. Connect the Video (yellow color) connector on your DVD player to the Video (yellow color) connector in the AV1/S-VIDEO input (yellow/red color area - row of connectors furthest from you when viewing from the rear of the HDTV) at the rear of the HDTV.
2. Connect the R (red color) and L (white color) audio connectors on your DVD player to the corresponding R (red color) and L (white color) audio input connectors in the AV1 input (yellow/red color area - row of connectors furthest from you when viewing from the rear of the TV) on the rear of the HDTV.
3. Turn on the power to the HDTV and DVD Player.
4. Select AV using the INPUT button on the remote or side of the HDTV, or directly by pressing the AV button on the Remote Control.



Note: Refer to your DVD player user manual for more information about the video output requirements of the product.



Connecting Your VCR or Video Camera

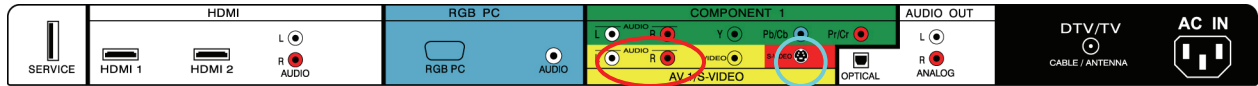

1. Turn off the HDTV and VCR or Video Camera.
2. Connect the S-Video jack on the rear of your VCR or Video Camera to the S-Video jack in the AV input (yellow/red area) at the rear of the HDTV.
3. Connect an audio cable (white and red connectors) cable to the audio output connectors associated with the S-Video output on your VCR or Video Camera and connect the other end to the audio connectors associated with the AV input (yellow/red area) at the rear of the HDTV.
4. Turn on the power to the HDTV and VCR or Video Camera.
5. Select AV using the INPUT button on the remote or side of the HDTV, or directly by pressing the AV button on the Remote Control.

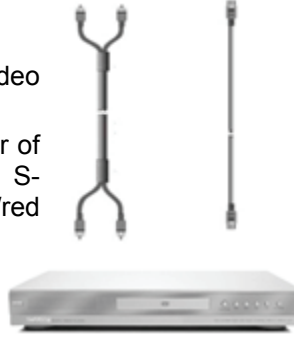



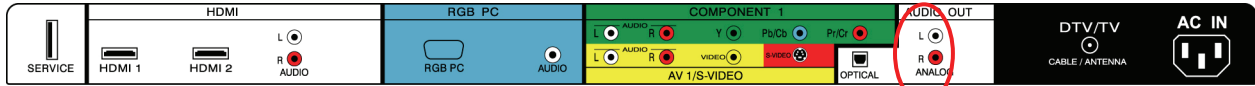

Note: Refer to your VCR or Video Camera user manual for more information about the video output requirements of the product.

Connecting an external Receiver/Amp



1. Turn off the power to the LCD HDTV and Receiver/Amp.
2. Using an audio cable (white and red connectors), connect the cable to the audio input connectors on the Receiver/Amp and connect the other end to the ANALOG OUT (white area) audio connectors at the rear of the LCD HDTV.
3. Turn on the power to the LCD HDTV and Receiver/Amp.







4. Then press the  button on the remote control to open the On-Screen Display (OSD) menu.
5. Press the  on the remote control to select the Audio Adjust menu.
6. Press the  on the remote control to select SPEAKERS.
7. Press the  on the remote control to select OFF so that the sound from the LCD HDTV will now be routed through your Receiver/Amp system.

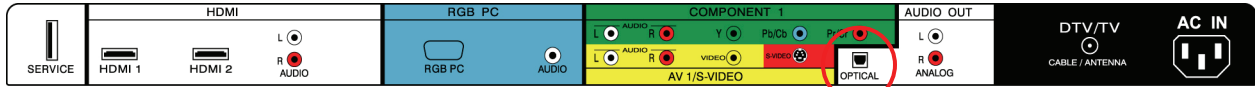

Optical Output of Audio received

If your sound system has a SPDIF (optical) digital audio input you can connect it to the optical AUDIO OUT (white area) at the rear of the VO32L FHDTV10A.



1. Turn off the power to the LCD HDTV and Receiver/Amp.
2. Using an SPDIF cable, connect the cable to the audio input connector on the Receiver/Amp and connect the other end to the OPTICAL OUT (white area) audio connectors at the rear of the LCD HDTV.
3. Turn on the power to the LCD HDTV and Receiver/Amp.
4. Then press the  button on the remote control to open the On-Screen Display (OSD) menu.
5. Press the  on the remote control to select the Audio Adjust menu.
6. Press the  on the remote control to select SPEAKERS.
7. Press the  on the remote control to select OFF so that the sound from the LCD HDTV will now be routed through your Receiver/Amp system.

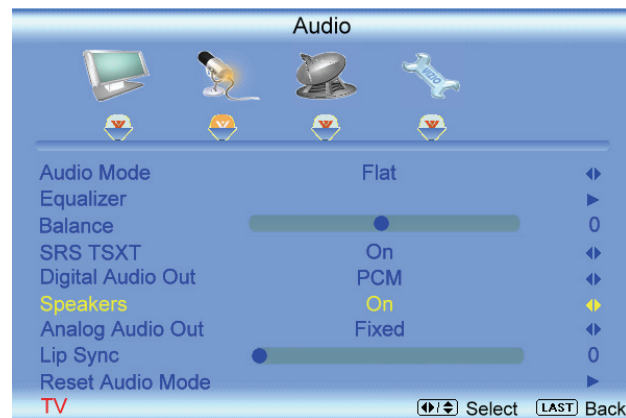

Press the **LAST** key once to return to the previous screen or repeatedly to return to your program if task has been completed.

Note:

- a) Refer to your Receiver/Amp user manual to select the corresponding audio input.
- b) The audio output is not amplified and cannot be connected directly to external speakers.



Connecting a PC Computer

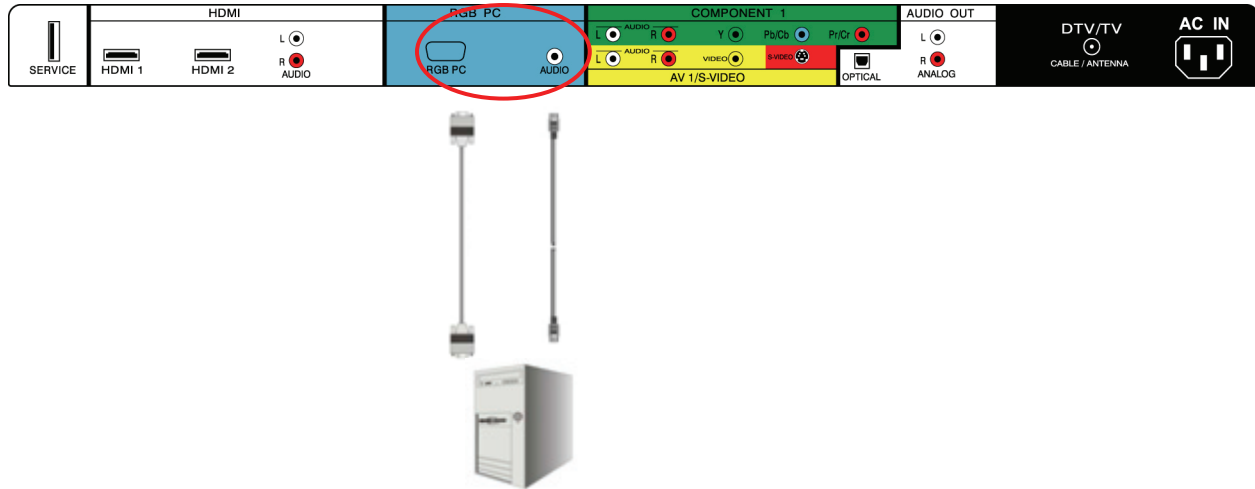

1. Turn off the power to the HDTV and PC Computer.
2. Connect a 15-pin D-Sub RGB (VGA) cable to the RGB output of your pc computer and the other end to the RGB PC input (blue area) at the rear of the HDTV.
3. Connect the Audio Out on your pc computer to the RGB PC Audio input (blue area) at the rear of the HDTV.
4. Turn on the HDTV and PC Computer.
5. Select RGB using the INPUT button on the remote or side of the HDTV.

Note:

- a) For the best picture quality when connecting a pc computer through RGB PC, set your pc computer timing mode to VESA 1920x1080 at 60Hz. Please refer to the pc or graphic card's user guide for additional information on how to set the timing mode and the video output requirements of the product.
- b) A RGB (VGA) cable and stereo mini jack cable are not included and can be purchased at an electronics store.



Preset PC Resolutions

If connecting to a PC through the RGB PC input, set the TV timing mode to VESA 1920x1080 at 60Hz for best picture quality (refer to the graphic card's user guide for questions on how to set this timing mode). Please see the table below for the factory preset resolutions.

Resolution	Refresh (Hz)	H.Freq (kHz)	V.Freq (Hz)	H.Sync	V.Sync	Pixel Rate (MHz)	Remark
640x480	60	31.46	59.94	N	N	25.17	Windows
640x480	75	37.5	75	N	N	31.5	Windows
800x600	60	37.87	60.31	P	P	40	Windows
800x600	72	48.07	72.18	P	P	50	Windows
800x600	75	46.87	75.00	P	P	49.5	Windows
1024x768	60	48.36	60	N	N	65	Windows
1024x768	70	56.47	70.06	N	N	75	Windows
1024x768	75	60.02	75.02	P	P	78.75	Windows
720x400	70	31.46	70.08	N	P	28.32	DOS
*1920x1080	60	66.65	60	P	P	136.5	Windows

NOTES: N = Negative, P = Positive, * = Primary (Native) Mode.

Resolution (1920x1080) through RGB (15-Pin VGA) Input

If your PC supports VESA Reduce Blanking timing via the VGA card drive program (usually offered by the VGA Card Manufacturer), your TV set is equipped to have the 1920X1080 resolution display through this connection using the following timing 136.5MHz. The following parameters are often the values required by the software or programs to set up the display:

Parameters	Horizontal Values (Pixels)	Vertical Values (Lines)
Address	1920	1080
Front Porch	32	1
Sync Width	32	3
Back Porch	64	27
Total	2048	1111
Frequency	66.7 kHz	60 Hz
Sync Polarity	P	P
Pixel Rate (MHz)	136.5	
Refresh Rate (Hz)	60	



Chapter 3 Setting Up to Watch Television

For 'Preparing Your LCD HDTV for Wall Mounting', see page 8.

Basic LCD HDTV Start Up

1. **Connecting the Power Cable**
Connect the power cord to the power cord connector on the back of the HDTV, and then plug the power cord into an AC wall socket.
2. **Connect Audio and Video Cables to the HDTV**
(see Chapter 2 for detailed steps)
3. **Turning Power On**
Once all the components are connected, press the Power ON button on the side of the HDTV, or press the Power ON (Orange) button on the remote control.
4. **Initial Setup**

After powering on the TV set, the *Initial Setup Welcome* screen will come up.

Press the  button on the remote control.

The *Language* choice screen will be displayed; the default English option is highlighted. If you wish to change the OSD language to Español or Français, press the  button on the remote control to select the language you want.

Press the  button on the remote to go to the next screen.

The next screen will display the options to select between **Home Mode** and **Retail Mode**, selecting Home Mode will give you an opportunity to save energy.

Press the  button on the remote to go to the next screen.

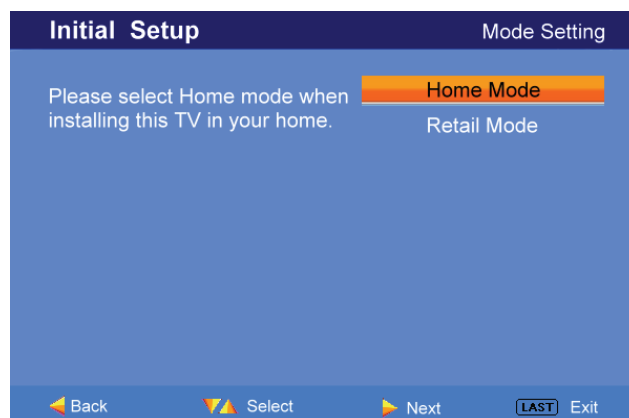
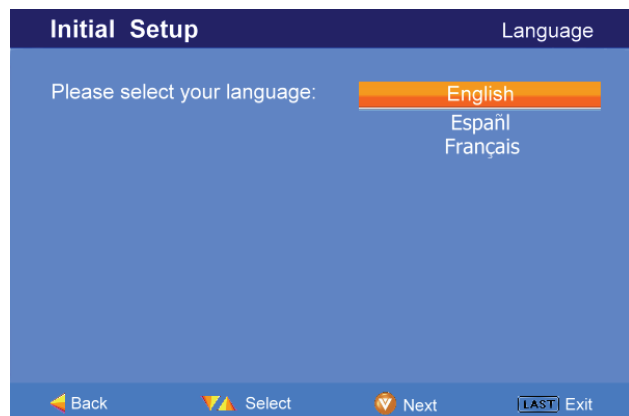
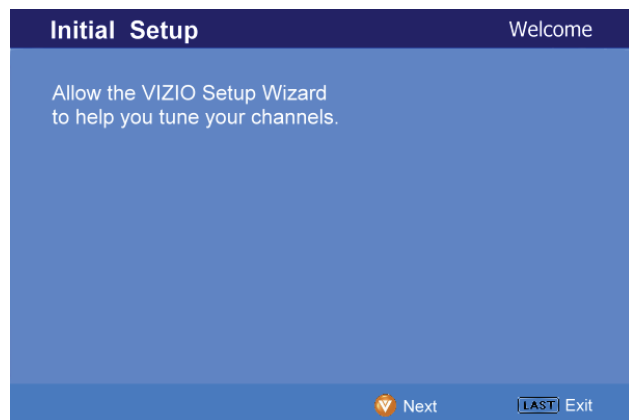

If **Retail Mode** is selected by mistake; the next option will allow you to switch your selection back to **Home Mode**.

Press the  button on the remote to go to the next screen.

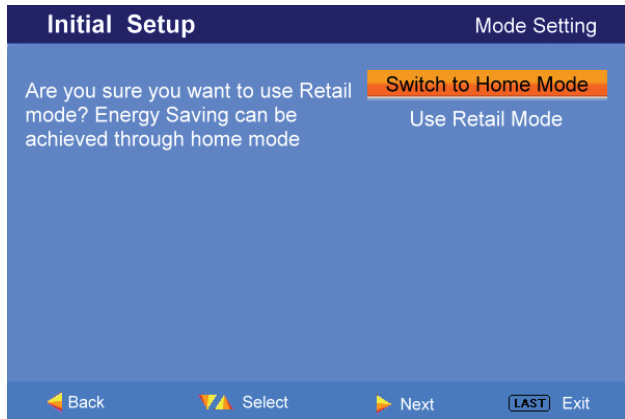

Note: At this point, if a set-top box from your cable or satellite service company is being used; please press the **LAST** button on the remote control and skip to Step 5.

Otherwise continue with next step:

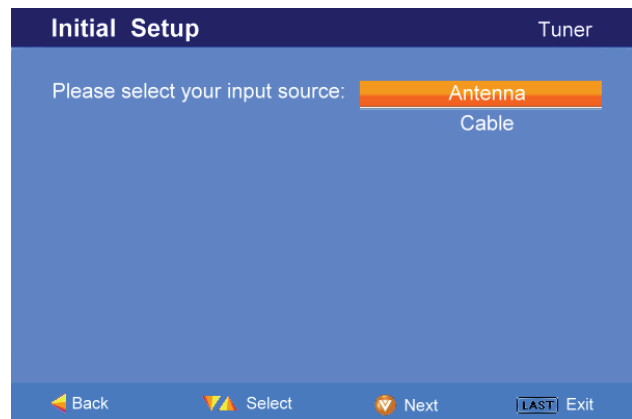

- a. The *Tuner* screen will be displayed. If you are using Cable Service (with no box), press the  button on the remote control to choose CABLE.



Press the  button on the remote to go to the next screen.

- b. The *Channel Scan* screen will be displayed; default choice is Scan.

Press the  button on the remote control to commence the search for available channels to be stored into memory.

If you do not want to scan for channels at this time, press the  button on the remote to highlight *Skip Scan* and then press the  button.

Note: If you select Skip Scan, next time that you decide to complete this procedure; you will need to select the TV as input (through the Input key) and then go through the Menu option to select the Tuner setup to get the option of scanning the channels again.



- c. The screen will now change to show the progress of the search for Analog (NTSC) and Digital (ATSC) channels.

Note: DTV digital broadcast is not available in all areas. Refer to www.antennaweb.org to get information about availability in your area, type of antenna and in which direction to point your antenna. The channel availability through cable depends upon which channels your cable operator supplies in Clear QAM; consult your cable operator for more information.

- d. When finished, the *Complete* screen will be displayed to inform you that the HDTV has completed the Initial Setup.

Press the  button on the remote control to exit and begin watching TV.

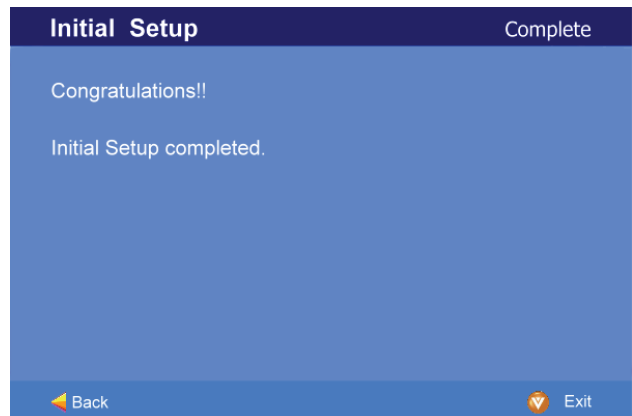
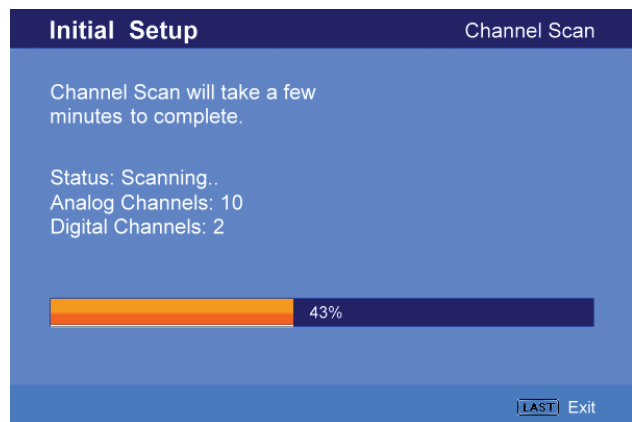
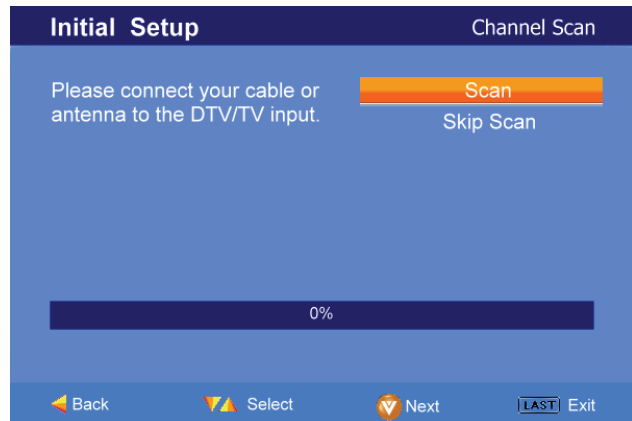

5. Select Input Source

Select the Input Source for the HDTV by pressing the INPUT button on the side of the TV or using the Input button on the remote control. Pressing this button will cycle you through the following options: TV, AV1/S-VIDEO, AV2, Component1, Component2, RGB, HDMI1, HDMI2, and HDMI3.

Now follow the procedure below to display channels from a different signal (External TV Tuner, VCR, Cable Box or Satellite Receiver) source, using different inputs at the back of you TV set.

Input
TV
AV1
AV2
COMPONENT1
COMPONENT2
RGB
HDMI1
HDMI2
HDMI3

- Select the correct input connection; RF (DTV/TV) connector, Composite (Yellow, Red and White) connectors, Component (Red, Green, Blue plus Red and White) connectors, HDMI connectors or Separate-Video (S-Video) plus Red and White connectors (if applicable). Make the physical connection or hook up.
- If you have an HD service you must use the HDMI (best) or Component connection.

Note: Composite (AV) and S-Video Cables can only be used for SD (480i) pictures.



- Turn on your Cable Box, VCR, External TV Tuner or Satellite Receiver and you will see a picture on your TV set. If there is not picture, make sure you have selected the correct input on the TV set.
- If the selected input is RF, you should be aware that the TV set needs to be on either channel 3 or channel 4 matching the channel which has been selected on the back of the VCR, Cable Box, External TV Tuner or Satellite Receiver; please refer to Owner or User's Manual of such equipment for details.

Note: The TV set will be displaying any television station or program selected by the Cable Box, VCR, External Tuner or Satellite Receiver. The TV set will not be able to change programs or channels; this is controlled by the equipment sending the signal. **If the service being used is the one which setup includes a box with two different outputs for two different (distant) rooms, then scanning channels would help you to find the signal. Be aware that the channel to be selected varies from provider to provider; meaning that, you may have to call your provider company so they could provide you the specific channel when using high definition made TV sets. Some examples of these channels are: 105, 106, 115 and 116.**









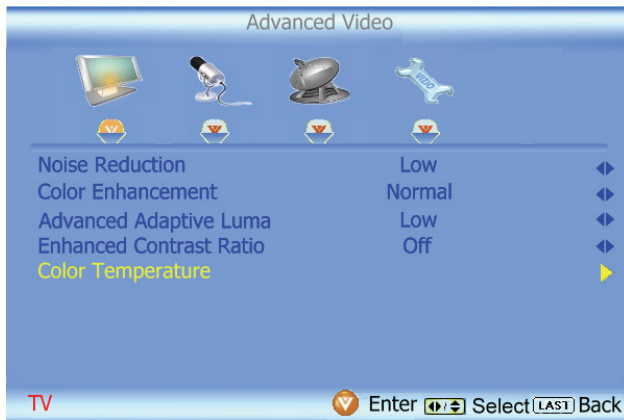

6. Fine Tuning your TV set for Home Use.

After completing Procedure 4 or Procedure 5; please follow the steps below to optimize your TV set display:



- a. Press the  key to bring up the Menu display. Use the  or  button to scroll to the Advanced Video option.

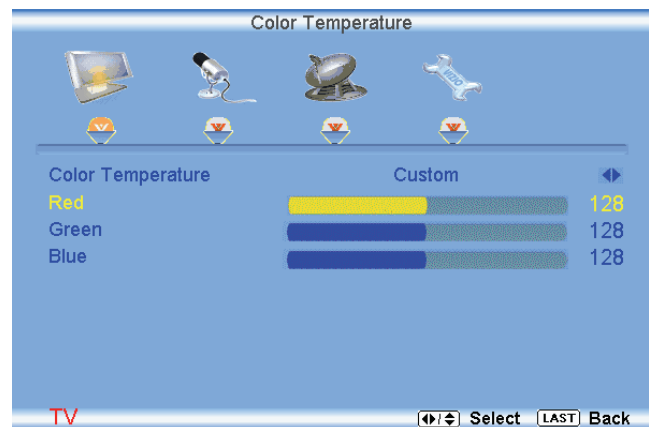

- b. Press the  button to select it.
- c. Use the  or  button to scroll to the Color Temperature option.

- d. Press the  button to select it.
- e. Press either  or  button to change setting to Normal, and then press the **LAST** key again to go back to previous screen.
- f. Press either  or  button to select the Picture Mode option.



- g. Press either  or  button to change the Picture Mode option to Standard.
- h. Press the **LAST** key to exit the on screen display Menu.





Note: If Procedure 4 had been done, you would like to do the following to ensure that the correct program times are shown when pressing the Guide key:

Press the Menu key, this will bring up the picture mode menu.

Press either  or  button scroll across to the icon showing the little satellite dish or antenna. The next screen will appear showing Time Zone.

Press either  or  button to select it.

Press either  or  button to choose the proper Time Zone of your area.

Press the **LAST** key once to return to the previous screen or repeatedly to return to your program if task has been completed.



Your new TV set is now ready to automatically reproduce the best picture quality out of the input signal which is been fed into it. Enjoy your TV watching!!



Watching a TV Program

Before you start watching TV, please make sure that any cable, satellite or off-air antenna connections are secure. Also, verify that the power cord is plugged into a correctly grounded electrical outlet or surge protector.

1. Press the power button on the remote or on the side of the HDTV. The VIZIO logo on the front will change from orange to white.
2. There are 3 options for selecting your programming:
 - a. If you are using an antenna or cable connected through the DTV/TV CABLE/ANTENNA input, you can select TV directly by pressing the TV button on the remote, or by pressing the INPUT button on the remote or on the side of the HDTV.
 - b. If you are watching broadcasts through a cable or satellite set-top box connected by an HDMI cable, select HDMI directly by pressing the HDMI button on the remote, or by pressing the INPUT button on the remote or on the side of the HDTV.
 - c. If you are watching broadcasts through a cable or satellite set-top box connected by a Component (YPbPr) cable, select Component directly by pressing the Component button on the remote, or by pressing the INPUT button on the remote or on the side of the HDTV.

Note: You should be able to see a picture. If you do not, make sure that all of the HDTV connections are secure and you have selected the correct video input source.

3. When using option 2a, press the Channel buttons on the remote or the CH +/- buttons on the side of the HDTV to change the channel. Note: The Channel buttons, on the side of the HDTV and on the remote, control will not work if you are watching a program using HDMI, Component, AV-S (S-Video) and AV-C (Composite) inputs.



Adjusting Basic HDTV Settings



Volume

To adjust the volume, press and hold the VOL+ or VOL- button on the side of the LCD HDTV or remote control until the desired level is reached.



TV Channels

To step up or down through the available TV channels, press the CH+ or CH- button once for the next or previous channel, or hold it depressed until the desired channel is reached. *Note: Channel up and down will only operate in DTV and TV modes.*



Wide

Using this feature, you can watch video content in different size modes on the HDTV.

Press the  button on the remote control to bring up the OSD screen.

Press either the  or  button to select Setup (wrench look alike icon) options.

Press the  button scroll down to Wide and select it.

Press either the  or  button to select among the modes.

Fore more information see Section 0 – Viewing Modes, on page 70.

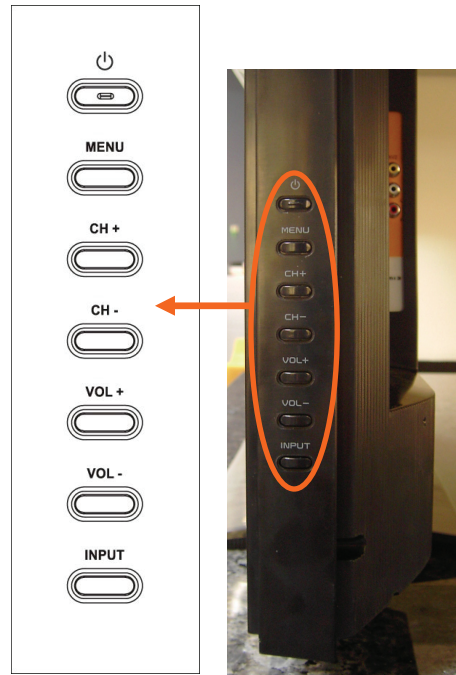

Program Information

Press the **GUIDE** button twice on the remote and program information for the channel you are watching will be displayed on the screen with the live program content in a small window in the lower left corner.

Press the **⏪** or **⏩** button to scroll up or down the channels. Each time you pause at a channel, the program list will update with the program schedule for the channel and the window will show the live program for that channel. Press the **GUIDE** button to exit this feature.



Information on HDTV Status

When you change TV channels or inputs, or press the **GUIDE** button once on the remote, an Information Banner is displayed for a few seconds to tell you the status of the LCD HDTV.

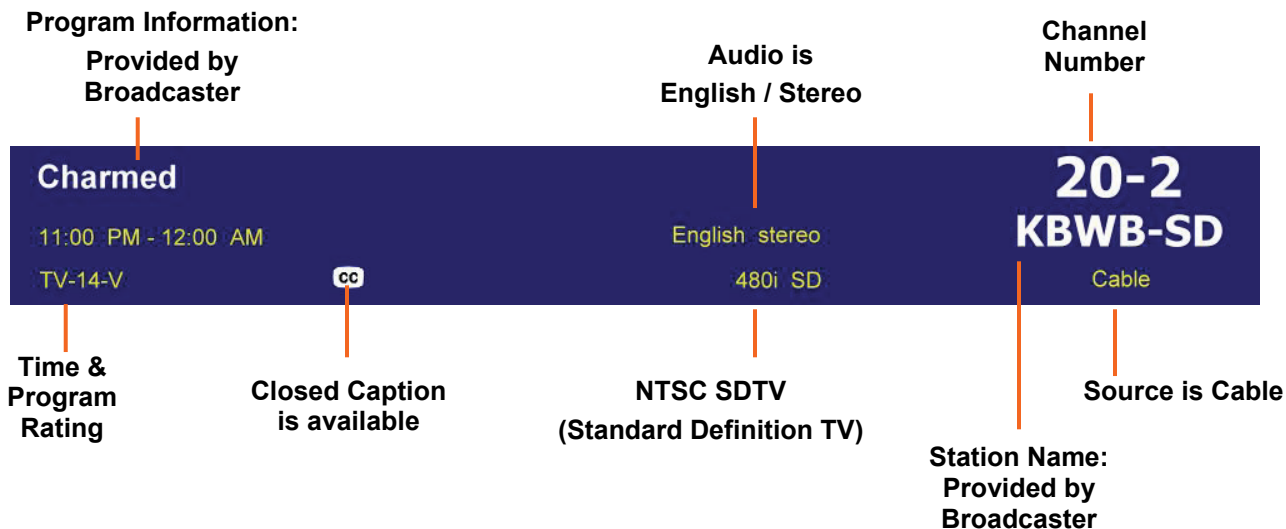

Chapter 4 Advanced Adjustment of HDTV



Using the On Screen Display (OSD)

The remote control or the control buttons on the right hand side of the TV can control all the function settings. The On Screen Display (OSD) allows you to adjust the save contrast, brightness and other settings. The TV will save changes made to the settings, even if the TV is turned off.

The OSD consists of several menu options: Picture Adjust, Audio Adjust, Setup and TV Tuner Setup. The main menu options may vary depending on your selected input source.

Note: Some of the main menu options may have additional submenus, i.e. the TV Rating submenu for Parental Controls.

Press the  button on the remote control or the side of the TV and the Picture Adjust menu will be shown on the screen.

Press the  or  button on the remote control or the VOL + or VOL – button on the side of the HDTV to select one of the other menu options.



Picture Adjust

Audio Adjust

TV Tuner Setup

Setup

Once the menu option is displayed, press the  or  button on the remote control or the CH + or CH – button on the side of the TV to select one of the items to adjust.

Press the  button on the remote control or the VOL – button on the side of the HDTV to begin adjustment of the item.

Press  when finished.

Press the **LAST** key once to return to the previous screen or repeatedly to return to your program if task has been completed.





DTV / TV Input Picture Adjustment

Picture Mode

When the  button is pressed, the On Screen Display (OSD) appears on the PICTURE adjustment page.

Press the  button to highlight the Picture Mode selection.

Use the  or  button to choose from Custom, Standard, Movie, Game, Vivid, Football, Golf, Basketball and Baseball.

Picture Adjustments are available for you to set them to your preferred settings.



Once the adjustments are completed press the **LAST** button repeatedly to exit the OSD completely.

Backlight

Press the  button to highlight the Backlight selection.

Press the  button to start adjusting the brightness of the Backlight and the menu page will disappear and be replaced by a small Backlight Indicator Bar so you can see the light level between the minimum and maximum available levels.

Use the  or  button to adjust the level.

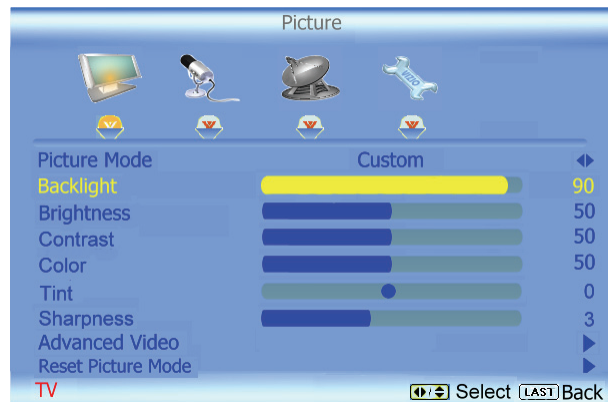

The Backlight level does not affect the Brightness (black level) or Contrast (white level) of the picture, it adjusts the lamp current and this affects the overall brilliance of the picture.

Once the adjustments are completed press the **LAST** button repeatedly to exit the OSD completely.

Note: This setting will be disabled and disappear if Enhanced Contrast Ratio is turned on.



Brightness

Press the  button to highlight the Brightness selection.

Press the  button to start adjusting the brightness and the menu page will disappear and be replaced by a small Brightness Indicator Bar so you can see the brightness level between the minimum and maximum available levels.

Use the  or  button to adjust the level.



The Brightness adjusts the black levels in the picture. If the brightness is too low you will not be able to see the detail in darker parts of the picture and if the brightness is too high the picture will look washed out.

Once the adjustments are completed press the **LAST** button repeatedly to exit the OSD completely.

Contrast

Press the  button to highlight the Contrast selection.

Press the  button to start adjusting the contrast and the menu page will disappear and be replaced by a small Contrast Indicator Bar so you can see the contrast level between the minimum and maximum available levels.

Use the  or  button to adjust the level.



The Contrast adjusts the white levels in the picture. If the contrast is too low the picture will look washed out and if the contrast is too high you will not be able to see any detail in the bright parts of a picture.

Once the adjustments are completed press the **LAST** button repeatedly to exit the OSD completely.

Color

Press the  button to highlight the Color selection.

Press the  button to start adjusting the color and the menu page will disappear and be replaced by a small Color Indicator Bar so you can see the color level between the minimum and maximum available levels.

Use the  or  button to adjust the level.



The Color adjusts the amount of color in the picture.

Once the adjustments are completed press the **LAST** button repeatedly to exit the OSD completely.



Tint

Press the  button to highlight the Tint selection.

Press the  button to start adjusting the tint and the menu page will disappear and be replaced by a small Tint Indicator Bar so you can see the tint adjustment to the left or right of the nominal position.

Use the  or  button to adjust the level.





The Tint adjusts the hue of the picture. The easiest way to set tint is to look at flesh tones and adjust for a realistic appearance. In most cases, the default middle position is correct. If people's faces look too orange try reducing the level of color first as the case of this is often too much color.

Once the adjustments are completed press the **LAST** button repeatedly to exit the OSD completely.

Sharpness

Press the  button to highlight the Sharpness selection.



Press the  button to start adjusting the sharpness and the menu page will disappear and be replaced by a small Sharpness Indicator Bar so you can see the sharpness level between the minimum and maximum available levels. Use the  or  button to adjust the level.





The Sharpness adjusts the sharpness of the picture.

Once the adjustments are completed press the **LAST** button repeatedly to exit the OSD completely.

Advanced Video Features

Press the  button to highlight the option for Advanced Video selection and press either the  button to select it. A new menu will be displayed showing the advanced functions available for fine tuning of the picture.

Noise Reduction (NR)

Press the  button to highlight Noise Reduction (NR). Use this feature to diminish picture artifacts caused by the digitizing of image motion content that may be present in the picture. Press the  or  button to choose from the Off, Low, Medium or Strong setting.

Once the adjustments are completed press the **LAST** button repeatedly to exit the OSD completely.



Color Enhancement

Press the **CH** button to highlight Color Enhancement. Use this feature to increase the picture reproduction performance of the picture.

Press the **<P>** or **>P>** button to choose from Off, Normal, Rich Color, Green/Flesh and Green/Blue setting. Once the adjustments are completed press the **LAST** button repeatedly to exit the OSD completely.

Advanced Adaptive Luma

Press the **CH** button to highlight Advanced Adaptive Luma. Large areas of darkness in a picture will result in a lower Average Picture Level (APL) and the overall picture will look too dark; activation of this feature will raise the APL to counteract this effect.

Press the **<P>** or **>P>** button to choose from the Off, Low, Medium, Strong, or Extend setting. Once the adjustments are completed press the **LAST** button repeatedly to exit the OSD completely.

Enhanced Contrast Ratio

Press the **CH** button to highlight Enhanced Contrast Ratio. This feature can be set to On or OFF to allow the TV set to adjust its backlight to display dark and bright scenes with a more vivid or intense quality.

Press the **<P>** or **>P>** button to turn this feature On or Off. Note: Backlight setting would be disabled if this option is set to On.

Once the adjustments are completed press the **LAST** button repeatedly to exit the OSD completely.

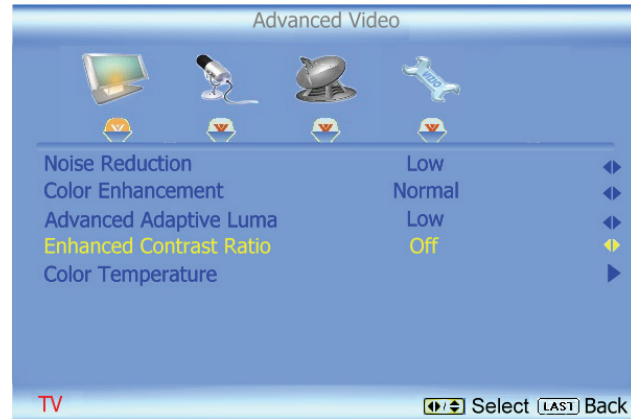

Color Temperature

Press the **CH** button to highlight the option for Color Temperature selection.

The default is COOL; this is the 9300K setting.

Press the **<P>** or **>P>** button if you want to choose the Normal, Warm or Custom option.

If you choose the Custom option, then a new menu will be displayed showing the primary color items, Red, Green and Blue.

Press the **CH** button to highlight the color you wish to adjust.

Press the **>P>** button to start adjusting the color and the menu page will disappear and be replaced by a small Color (Red, Green or Blue) Indicator Bar as before.

Use the **<P>** or **>P>** button to adjust the color.

Press the **DOWN** button when finished. Repeat the procedure to adjust the other colors if desired.

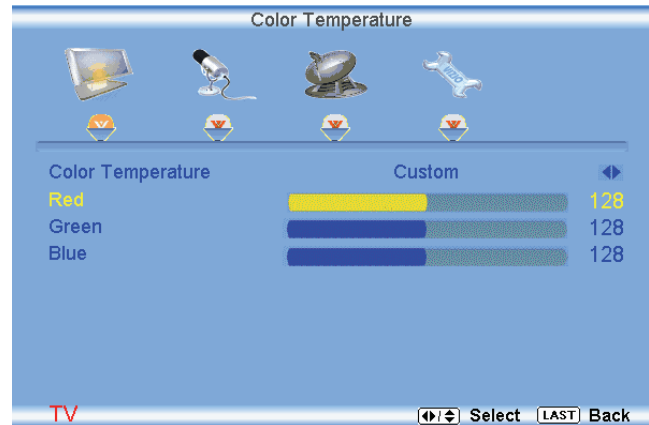

Reset Picture Mode

Press the  button to highlight the option for Reset Picture Mode selection

Press the  button to return on Picture settings to factory default.

Once the adjustments are completed press the **LAST** button repeatedly to exit the OSD completely.

Note: Only settings under the pictures adjustment tab will be reset.





DTV / TV Input Audio Adjustment

Audio Mode

When the  button is pressed, the On Screen Display (OSD) appears on the PICTURE adjustment page.

Press the  button to display the AUDIO ADJUST page.

Press the  button to highlight the Audio Mode selection.

Use the  or  button to choose from Flat, Rock, Pop, Classic or Jazz.

Equalizer adjustments are available for you to set them to your preferred settings.



Once the adjustments are completed press the **LAST** button repeatedly to exit the OSD completely.



Equalizer



Press the  button to highlight the Equalizer selection.

Press the  button to start adjusting

A new menu will be displayed showing volumes of different frequencies (pitches).

Starting from lowest to the highest pitch, they are 120 Hz, 500Hz, 1.5 kHz, 5 kHz and 10 kHz.

Press the  button to highlight the frequency you wish to adjust.

Use the  or  button to adjust for boost or attenuation. For example if you want to boost the bass you would highlight 120Hz and turn it up.





Once the adjustments are completed press the **LAST** button repeatedly to exit the OSD completely.

Balance

Press the  button to highlight the Balance selection.

Press the  button to start adjusting the balance and the menu page will disappear and be replaced by a small Balance Indicator Bar, as before, so you can see the balance adjustment to the left or right of the nominal position.

Use the  or  button to adjust the left/right balance.



Once the adjustments are completed press the **LAST** button repeatedly to exit the OSD completely.

SRS TSXT

Press the  button to highlight the SRS TSXT selection.



Press the  button to select for the simulated surround sound feature to be On or Off.

Once the adjustments are completed press the **LAST** button repeatedly to exit the OSD completely.





Digital Audio Out

Press the  button to highlight the Digital Audio Out selection.

Press the  or  button to make the proper selection. The options are OFF, Dolby Digital and PCM. Once the adjustments are completed press the **LAST** button repeatedly to exit the OSD completely.

Speakers



Press the  button to highlight the Speakers selection.

Press either  or  button to turn the internal speakers On or Off. You may want to turn-off the internal speakers when listening to the audio through your Home Theatre System.

Press the **LAST** key once to return to the previous screen or repeatedly to return to your program if task has been completed.

Analog Audio Out

Press the  button to highlight the Analog Audio Out selection.



Press either  or  button to turn the audio out signal to Fixed or Variable. When it is set to variable, volume from the external speakers will change according to the volume setting on the TV. If it is fixed, the volume can only be changed by the settings on the external stereo system.

Press the **LAST** key once to return to the previous screen or repeatedly to return to your program if task has been completed.

Lip Sync

Included with the advanced technology of your TV, a feature which will compensate the shortcomings of signal transmission called audio sync (Lip Sync). Lip Sync is designed to adjust the audio of the program being viewed so that it matches the movement of the lips of someone talking on the screen. This feature is built into your set, and it can be applied to all inputs. To use this feature, follow the steps below.

Press the  key to bring up the OSD.

Using either the  or  button scroll across to the microphone icon, the Audio menu will be displayed.

Press either  or  button to scroll either up or down to Lip Sync.

Press either  or  button to make the appropriated adjustment.

Press the **LAST** key once to return to the previous screen or repeatedly to return to your program if task has been completed.



Reset Audio Mode

Press the **CH** button to highlight the option for Reset Audio Mode selection

Press **↵** button to return on Audio settings to factory default.

Once the adjustments are completed press the **LAST** button repeatedly to exit the OSD completely.

Note: Only settings under the audio adjustment tab will be reset.



DTV / TV Tuner Setup

When you first used your HDTV you will have setup your TV for DTV / TV channels using the Initial Setup screens. If you did not do this or if your setup has changed, you can do this from the TV TUNER SETUP menu.

Once the adjustments are completed press the **LAST** button repeatedly to exit the OSD completely.

Tuner Mode

When the **TV** button is pressed, the On Screen Display (OSD) appears on the PICTURE adjustment page. Press the **↵** button to display the TV page.

Press the **CH** button to highlight the Tuner Mode selection.

Press the **↵** button to choose Cable or Air (Antenna) depending upon which equipment you have attached to the DTV / TV Input.

Once the adjustments are completed press the **LAST** button repeatedly to exit the OSD completely.



Auto Search

Press the **CH** button to highlight the Auto Search selection.

Press the **↵** button to Auto Search for TV channels available. The TV will automatically search for analog and digital channels.

Once the adjustments are completed press the **LAST** button repeatedly to exit the OSD completely.

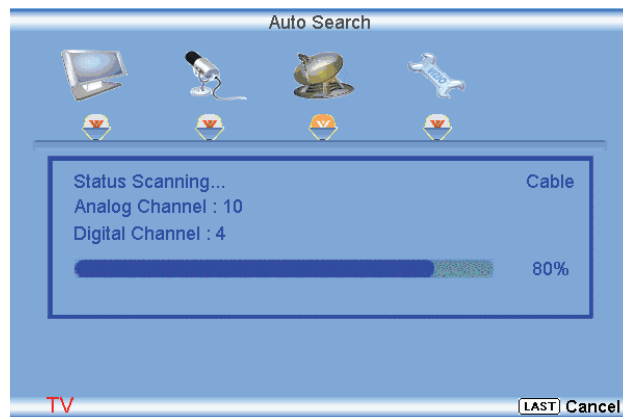

Partial Channel Search

If you believe channels are missed from the auto search, you can do a partial channel search to look for channel in a certain channel range again. Press the **CH-** button to highlight the Partial Channel Search selection.

Press the **CH-** button to enter the submenu.

Press the **CH-** button to select scan mode to look for Analog, Digital, or both Analog/Digital channels.

Press the **CH-** button to highlight the “To” and “From” selection. Press the **CH-** button to select the range of channel numbers you want to start searching in.

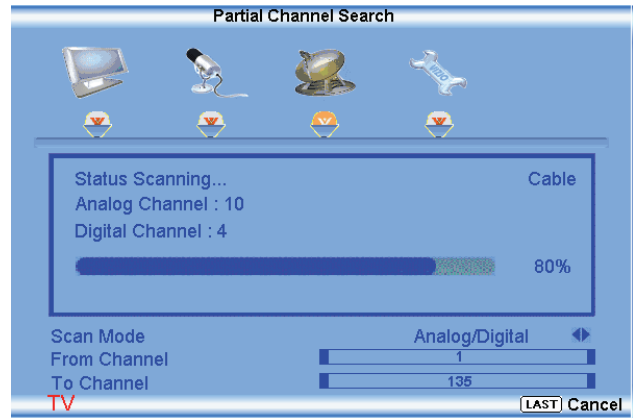

Press **CH-** to start channel search.

Once the adjustments are completed press the **LAST** button repeatedly to exit the OSD completely.

Skip Channel

After the TV has stored all of the available DTV channels in memory you will find that some channels will be too weak to watch comfortably or they may be channels you do not want to see. Select the channel you wish to remove, press **CH-** and **CH-** buttons to open the TV TUNER SETUP menu and then press the **CH-** button to highlight SKIP CHANNEL. Press the **CH-** button to select this channel to be skipped when using the CH+ or CH- button. You will still be able to select this channel using the number buttons on the remote control.

MTS

This feature allows you, the user to select the different languages in which the signal provider or broadcaster is transmitting the audio with the program you are watching. This signal is usually or in most cases Spanish language.

Press the **CH-** button as many times as it takes to scroll down to this option and get it highlighted.

Press either **CH-** or **CH-** button to go through the settings of this feature to make your selection.

Once the adjustments are completed press the **LAST** button repeatedly to exit the OSD completely.

Time Zone

Setting the correct Time Zone for your area will ensure that the correct program times are shown after pressing the GUIDE button on the remote control.

Press the **CH-** button to highlight the Time Zone selection.

Press the **CH-** or **CH-** button to select your area.

Once the adjustments are completed press the **LAST** button repeatedly to exit the OSD completely.



Daylight Saving

As for Time Zone, setting the daylight saving time for your area will ensure that the correct program times are shown after pressing the GUIDE button on the remote control.

Press the button to highlight the Daylight Saving selection.

Press the or button to select On or Off.

Once the adjustments are completed press the **LAST** button repeatedly to exit the OSD completely.

DTV / TV Input Setup

Language

When the button is pressed, the On Screen Display (OSD) appears on the PICTURE adjustment page. Press the button until the SETUP page is displayed.

Press the button to highlight the Language selection. The default is English.

Press the or button to select Español or Français.

Once the adjustments are completed press the **LAST** button repeatedly to exit the OSD completely.



PIP (Picture-in-Picture)

Press the button to highlight the PIP(Picture-in-Picture) selection.

Press the button. A separate menu will appear with the following PIP settings.

PIP Mode

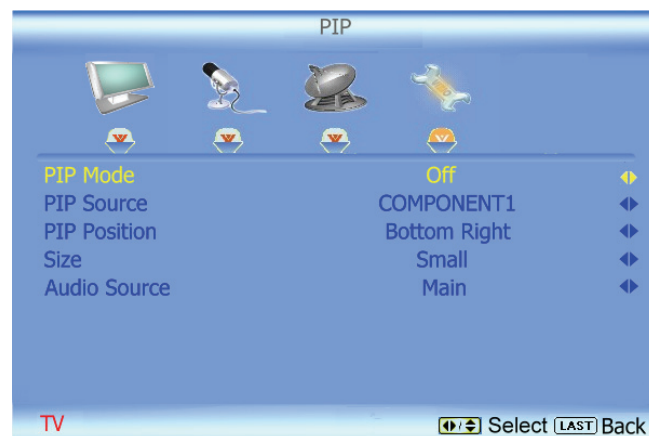

Press the button to highlight the PIP mode selection.

Press the or button to select Off, PIP or POP(Picture-outside picture). In the PIP mode a smaller sub screen will be displayed on top of the main screen. For the POP mode the main screen and sub screen will be of equal size and be positioned side by side.



PIP Input

When PIP or POP is selected, Press the  button to highlight the PIP input selection.

Press the  or  button to choose the input source for the sub screen. The input sources available will vary according to which input is used for the main screen; see the table below to find which inputs can PIP/POP with each other.



See below for detailed information regarding the PIP sources.

MAIN \ SUB	DTV / TV	AV	Component	RGB	HDMI
DTV / TV			✓	✓	✓
AV			✓	✓	✓
Component	✓	✓			✓
RGB	✓	✓			✓
HDMI	✓	✓	✓	✓	

“✓” – Indicates which inputs are available for PIP mode.



PIP Position

When PIP is selected, Press the  button to highlight the PIP position selection.

Press the  or  button to choose where on the picture you want the PIP screen positioned over the main screen.



PIP Size

When PIP is selected, Press the  button to highlight the PIP size selection.

Press the  or  button to choose Small, Medium or Large.

PIP Audio Source

When PIP or POP is selected, Press the  button to highlight the PIP audio source selection.

Press the  or  button to choose the audio source from the main screen or the sub screen.

Once the adjustments are completed press the **LAST** button repeatedly to exit the OSD completely.



Sleep Timer

Press the  button to highlight the Sleep Timer selection.

Press the  button to select the timer to turn-off the TV in 30, 60, 90 or 120 minutes.



Once the adjustments are completed press the **LAST** button repeatedly to exit the OSD completely.



Wide

The Wide option is the feature which allows you to select how your display would be size wise. When in TV mode; the selections are Normal, Wide, Stretch and Panoramic views.

Press the  button as many times as it takes to scroll down to this option and highlight it.

Press either  or  button to make the correct selection, you will see the screen adjusting to the different sizes which apply to this feature.

Once the adjustments are completed press the **LAST** button repeatedly to exit the OSD completely.



Input Naming

This feature has been added to facilitate you, the user in identifying or label the input and signal which is being watched. You could use up to 8 characters; either letters or numbers or combinations of both.



Press  button to highlight this option.

Press  button to obtain the next screen which shows the different inputs.

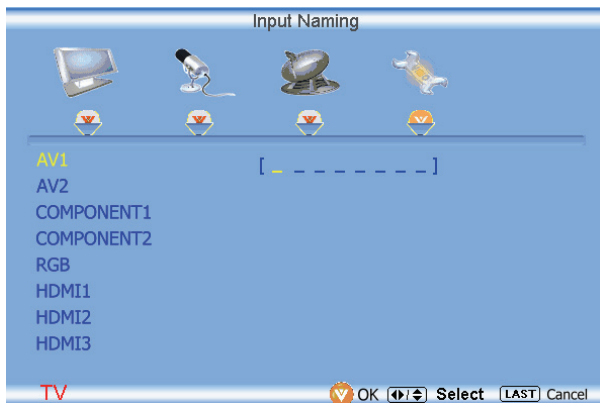
Press  button to select the desired input which you want to label or name (Examples: VCR, DVD,..., etc.) it with any name which will make easier for you to recognize it.



Press the  key to go to the first space () in the bracket.

Press either the  or  button and select either the letter or number belongs to this place.

Press the  button to go to the next space () and again

Using either the  or  button select the second character of the name given to this Input.

Repeat the last previous two steps until the name of the input is completed.

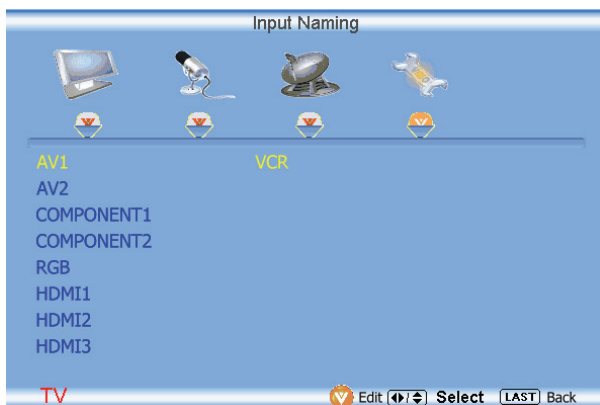

Press the  key to accept the name of the input or the **LAST** key to cancel the setting. .

Press the **LAST** key when you have finished to go to the previous menu.

Since you are already in this feature; it is recommendable to name all the Inputs which are being used as well as these for which you have an idea what their name is going to be.

Press the **LAST** key once to return to the previous screen or repeatedly to return to your program if task has been completed.



CC (Closed Caption)

Press the  button to highlight the CC (Closed Caption) selection.

Press the  button. A separate menu will appear with the following CC settings

CC

When watching regular analog (NTSC) TV, the CC feature is available in the Setup menu.

Press the  button to highlight the CC selection.

Press the  button to select CC1, CC2, CC3 or CC4.

Once the adjustments are completed press the **LAST** button repeatedly to exit the OSD completely.



Closed Caption for regular TV is usually CC1 or CC2.

Digital Closed Caption Style

When watching DTV, the Digital CC Style feature is available in the Setup menu.

Press the  button to highlight the Digital CC Style selection.

Press the  button to go to the next screen.

Press either  or  button to toggle between the two options; As Broadcaster and Custom.

If Custom is selected then you will have the way of customize the way Closed Caption will be displayed by changing these different parameters to your like: **Font Size** (letters size), **Font Color** (letters color) **Font Opacity** (transparency of the letters), **Background Color** (color of the background area where Closed Caption is going to be displayed), **Background Opacity** (allows to either see through at the scene being played or it could be a solid screen), **Window Color** (it gives the color to the area where characters will be displayed on) and finally **Window Opacity** (allows the area of the characters to be changed) .

There are no recommendations of setting these parameters since you, the user would have your own taste or like of them.

Press the key labeled **LAST** as many times as it takes to exit the menu screens.



H/V Position

Press the  button to highlight the H/V Position selection.



Press the  button. A separate menu will appear with the following H/V Position settings



H-Position

Press the  button to highlight the Horizontal Shift selection.

Press the  button to start adjusting the horizontal position of the picture.



Use the  or  button to adjust the horizontal position.

Once the adjustments are completed press the **LAST** button repeatedly to exit the OSD completely.

V-Position

Press the  button to highlight the Vertical Shift selection.

Press the  button to start adjusting the vertical position of the picture.

Use the  or  button to adjust the vertical position.

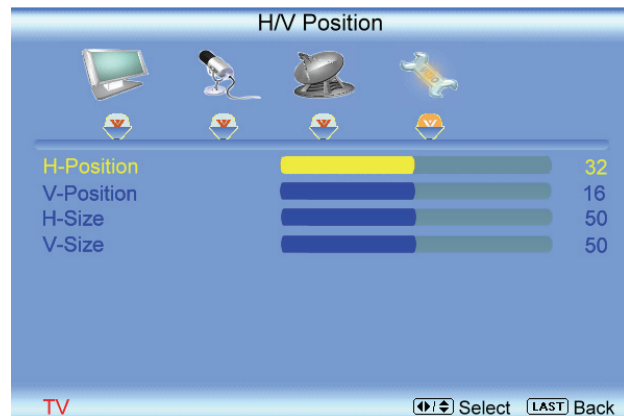

Once the adjustments are completed press the **LAST** button repeatedly to exit the OSD completely.



H-SIZE

Press the  button to highlight the H-Size selection.

Press the  button to start adjusting the horizontal size of the picture.



Use the  or  button to adjust the horizontal size.

Once the adjustments are completed press the **LAST** button repeatedly to exit the OSD completely.

V-SIZE

Press the  button to highlight the V-Size selection.

Press the  button to start adjusting the vertical size of the picture.

Use the  or  button to adjust the vertical size.

Once the adjustments are completed press the **LAST** button repeatedly to exit the OSD completely.





DTV / TV Input Parental Control

If you want to restrict certain channel and program viewing, you can do this by turning on the Parental Control. Selected programs, movies and channels can then be made available only after an authorized password has been entered and accepted by the TV.

When the  button is pressed, the On Screen Display (OSD) appears on the PICTURE adjustment page.

Press the  button to display the SETUP page.

Press the  button to highlight Parental, then press the  button.

The Password must be entered before the TV will continue with Parental settings. The default password set in the factory is 0 0 0 0. If you are going to use the Parental Control feature you should change the password.





Note: Make sure you write down and store the new password in a secure place. The System Reset feature (see page 62) does NOT reset the password.

Rating Enable

Turning this feature on will allow the end user to prevent their children to watch blocked programs when using the PIP feature. The PIP screen will display a blue or blank screen.

Press  to scroll down to Rating Enable, and select it.

Press either  or  button to turn feature ON or Off.

Press the **LAST** to exit the OSD screen.



Channel Block

Press the **CH** button to highlight the Channel Block selection.

Press the **RIGHT** button to go to the next screen.

Press the **DOWN** button to highlight the channel you want to block.

Press the **ENTER** button to block the highlighted channel.

Once the adjustments are completed press the **LAST** button repeatedly to exit the OSD completely.



US TV Rating

Follow the procedure in the previous section to display the Parental Control menu and then press the **CH** button to highlight the US TV Rating selection.

Press the **RIGHT** button and the Block TV Rating panel will be displayed.

In the Block TV Rating panel you can customize the program blocking of the following TV ratings:

Y – All children

Y7 – Older children

G – General audience

PG – Guidance suggested

14 – Strongly cautioned

MA – Mature audience

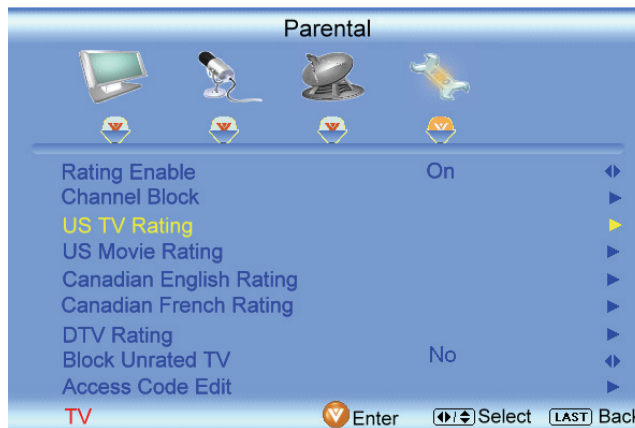

You can also customize the TV ratings for the following content:

A – All subratings

D – Sexual dialog

L – Adult language

S – Sexual situations

V - Violence

FV – Fantasy violence





Press the **UP** or **DOWN** button to navigate through the TV rating options.

Press the **ENTER** button to block (locked) or allow (unlocked).



US Movie Rating (For US)

Press the  button to highlight the US Movie Rating selection.

Press the  button and the Block Movie Rating panel will be displayed.

In the Block Movie Rating panel you can customize the program blocking of the following Movie ratings:

- G – General audience
- PG – Parental guidance suggested
- PG-13 – Recommended for children 13 years of age or older
- R – Mature audience
- NC-17 – No one under 17 years of age
- X – No one under 17 years of age

Press the  or  button to navigate through the Movie rating options.

Press the  button to block (locked) or allow (unlocked).





Canadian English Rating

Press the  button to highlight the Canadian English Rating selection.

Press the  button and the Block Canadian English Rating panel will be displayed.

In the Block Canadian English Rating panel you can customize the program blocking of the following ratings:

- C – Children
- C8+ – Children 8 years or older
- G – General Programming, suitable for all audiences
- PG – Parental guidance
- 14+ – Viewers 14 years or older
- 18+ – Adult programming

Press the  or  button to navigate through the Movie rating options.

Press the  button to block (locked) or allow (unlocked).



Canadian French Rating

Press the button to highlight the Canadian French Rating selection.

Press the button and the Block Canadian French Rating panel will be displayed.

In the Block Canadian French Rating panel you can customize the program blocking of the following ratings:

- G – General audience
- 8 ans+ – General – not recommended for young children
- 13 ans+ – Not suitable for children under 13 years of age
- 16 ans+ – Not suitable for under 16 years of age
- 18 ans+ – Adults only



Press the or button to navigate through the Movie rating options.

Press the button to block (locked) or allow (unlocked).

DTV Rating

This option is designed to update the TV or Movie table of different ratings for programs being viewed in your local or regional area. It will allow the parental guidance control feature in your TV to have the most current parental control database for a digital signal. This option may be available in the future for activation. This option works as follows: Whenever you decide to use the Parental Control feature and this option has been activated in your area, the DTV Rating will be a solid color indicating that an update is available for any rating tables. After entering the password, the Parental menu will appear on the screen, and then do the following.

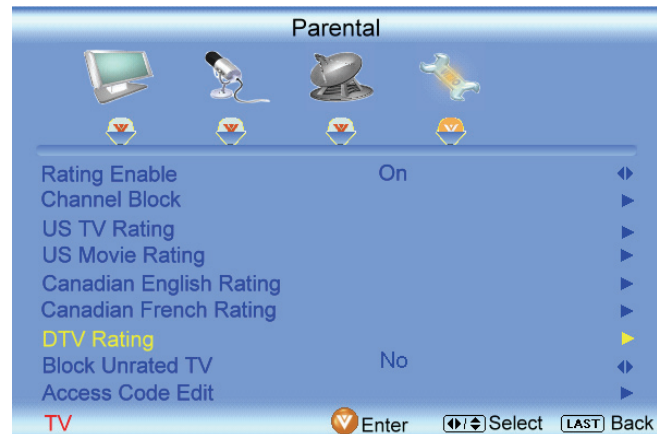

Observe the status of the **DTV Rating**. If option is faded out, no update is available (the option is not activated in your area).

If it is not faded out, press either or button to select this option.

Press button to execute this operation. Please follow the on screen instructions to complete this procedure.

Press either or to select and then adjust any other option in this menu.

Press the **LAST** key once to return to the previous screen or repeatedly to return to your program if task has been completed.



Blocked Unrated Programming

Follow the procedure in the previous section 0 to display the Parental Control menu and then press the  button to highlight the Block Unrated TV selection.

Press the  button to turn-on or turn-off the blocking of programming that does not have a rating.

Once the adjustments are completed press the **LAST** button repeatedly to exit the OSD completely.

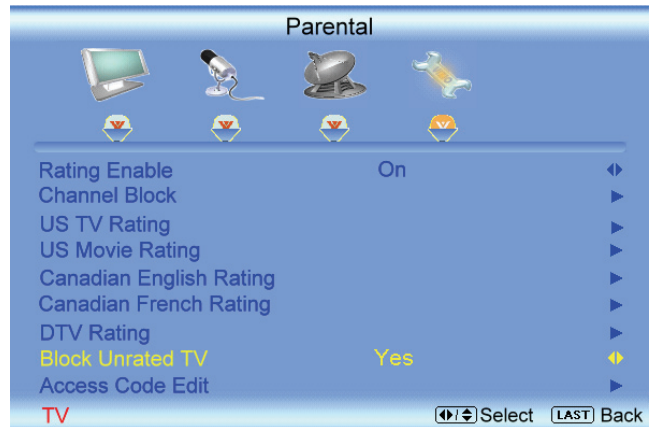

Change the Password

Press the  button to highlight the Access Code Edit selection.

Press the  button and the new Password panel will be displayed.

Enter the new, 4-digit password using the number buttons on the remote. Enter it a second time to confirm you entered it correctly.

Once the adjustments are completed press the **LAST** button repeatedly to exit the OSD completely.

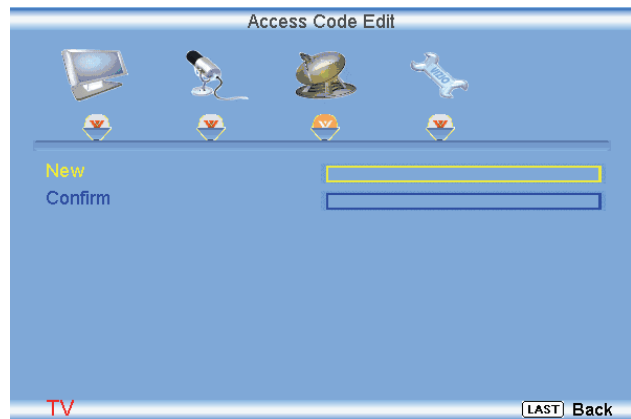
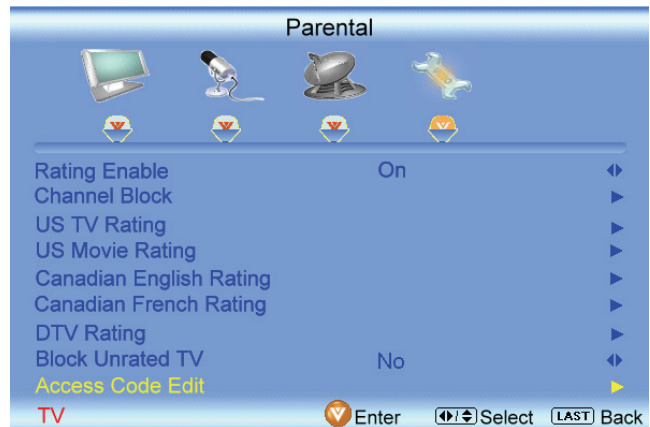

Note: Make sure you write down and store the new password in a secure place. The System Reset feature (see page 62) does NOT reset the password.



System Reset

Press the  button to highlight **System Reset**.

Press the  button. A new menu will appear.

Setup Wizard

Use this function to return to the Initial Setup when the TV was used for the first time. Use this function if you wish to have a guided setup when you relocate your TV. Please refer to Basic LCD HDTV Start Up on page 32 for more information.

Note: Previously scanned channels will be removed.

Reset All Settings

Use this function to reset the TV to the default factory settings.

Press either the **MENU** button to return to the previous menu display or the **LAST** key to return to your program if task has been completed.

Note: This does **NOT** reset the Parental Control Password.

HDMI Input Picture Adjustment

The Picture Adjust menu operates in the same way for the HDMI Input as for the DTV / TV input in section 0. Once the adjustments are completed press the **LAST** button repeatedly to exit the OSD completely.



HDMI Input Audio Adjustment

The Audio Adjust menu operates in the same way for the HDMI Input as for the DTV / TV input in section 0.



HDMI Input Setup

The Setup menu operates in the same way for the HDMI Input as for the TV input in section 0. The menu difference is that there is no DTV / TV or Parental Control adjustments.



Video Input Picture Adjustment

The Picture Adjust menu operates in the same way for Video Inputs (Component and AV) as for the DTV / TV input in section 0. The menu difference is that there is no icon along the top for DTV / TV adjustments.



Video Input Audio Adjustment

The Audio Adjust menu operates in the same way for Video Inputs (Component and AV) as for the DTV / TV input in section 0. The menu difference is that there is no icon along the top for DTV / TV adjustments.



Video Input Setup

The Setup menu operates in a similar way for Video Inputs (Component and AV) as for the TV input in section 0. The menu difference is that there is an auto phase setting under the H/V Position submenu when using Component input.

Auto Phase (for Component input)

Press the button to highlight the H/V Position.

Press the button and the new H/V Position submenu will be displayed.

Press the button to highlight Auto Phase.

Press the button to execute this option. The TV will automatically look for the phase of the signal to fine tune the picture.

Once the adjustments are completed press the **LAST** button repeatedly to exit the OSD completely.

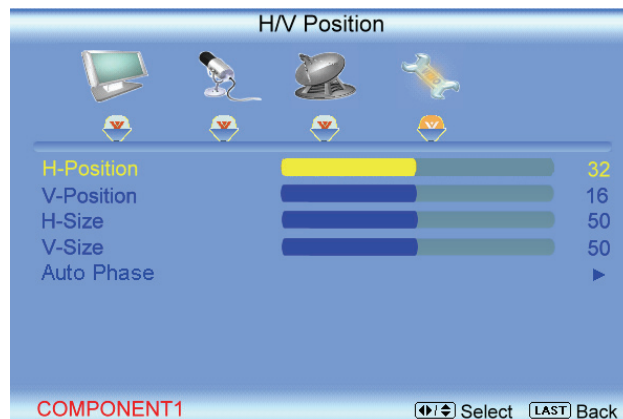

Video Input Parental Control

The Parental Control menu operates in the same way for Video Inputs (Component and AV) as for the DTV / TV input in section 0. The menu difference is that there is no icon along the top for DTV / TV adjustments.

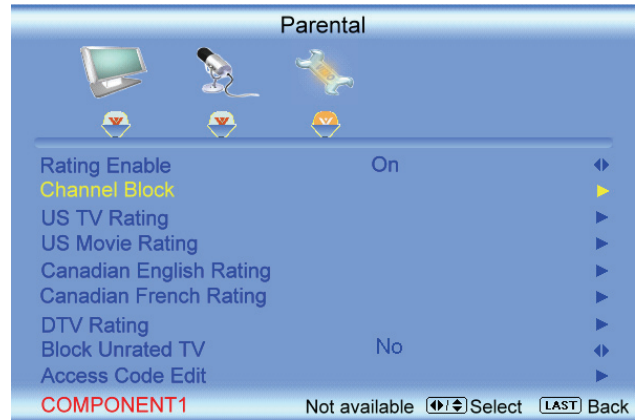



PC Input Picture Adjustment

The Picture Adjust menu operates in the same way for the PC Input as for the DTV / TV input in section 0 for Backlight, Contrast, Brightness and Color Temperature.

Auto Adjust

When the  button is pressed, the On Screen Display (OSD) appears on the PICTURE adjustment page.

Press the  button to highlight the Auto Adjust selection.

Press the  button for the LCD HDTV to adjust to the PC signal timing automatically.

Once the adjustments are completed press the **LAST** button repeatedly to exit the OSD completely.

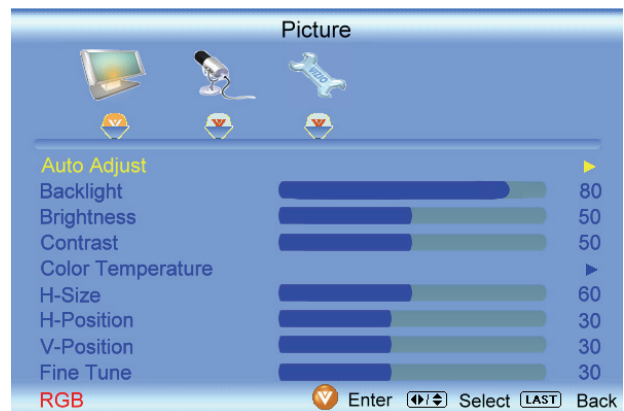

Backlight

Press the  button to highlight the Backlight selection.

Press the  button to start adjusting the brightness of the Backlight and the menu page will disappear and be replaced by a small Backlight Indicator Bar so you can see the light level between the minimum and maximum available levels.

Use the  or  button to adjust the level.



The Backlight level does not affect the Brightness (black level) or Contrast (white level) of the picture, it adjusts the lamp current and this affects the overall brilliance of the picture.

Once the adjustments are completed press the **LAST** button repeatedly to exit the OSD completely.



Brightness

Press the  button to highlight the Brightness selection.

Press the  button to start adjusting the brightness and the menu page will disappear and be replaced by a small Brightness Indicator Bar so you can see the brightness level between the minimum and maximum available levels.

Use the  or  button to adjust the level.



The Brightness adjusts the black levels in the picture. If the brightness is too low you will not be able to see the detail in darker parts of the picture and if the brightness is too high the picture will look washed out.

Once the adjustments are completed press the **LAST** button repeatedly to exit the OSD completely.

Contrast

Press the  button to highlight the Contrast selection.

Press the  button to start adjusting the contrast and the menu page will disappear and be replaced by a small Contrast Indicator Bar so you can see the contrast level between the minimum and maximum available levels.

Use the  or  button to adjust the level.



The Contrast adjusts the white levels in the picture. If the contrast is too low the picture will look washed out and if the contrast is too high you will not be able to see any detail in the bright parts of a picture.

Once the adjustments are completed press the **LAST** button repeatedly to exit the OSD completely.



Color Temperature

Press the **CH** button to highlight the option for Color Temperature selection.

The default is the 9300K (Cool) setting.

Press the **<F** or **>F** button if you want to choose the 9300, 6500 or Custom option.

Once the adjustments are completed press the **LAST** button repeatedly to exit the OSD completely.

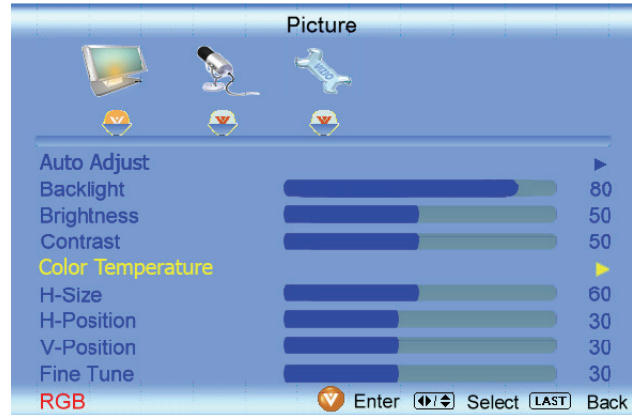

If you choose the Custom option, then a new menu will be displayed showing the primary color items, Red, Green and Blue. Press the **CH** button to highlight the color you wish to adjust.

Press the **>F** button to start adjusting the color and the menu page will disappear and be replaced by a small Color (Red, Green or Blue) Indicator Bar as before. Use the **<F** or **>F** button to adjust the color.

Press the **Enter** button when finished. Repeat the procedure to adjust the other colors if desired.

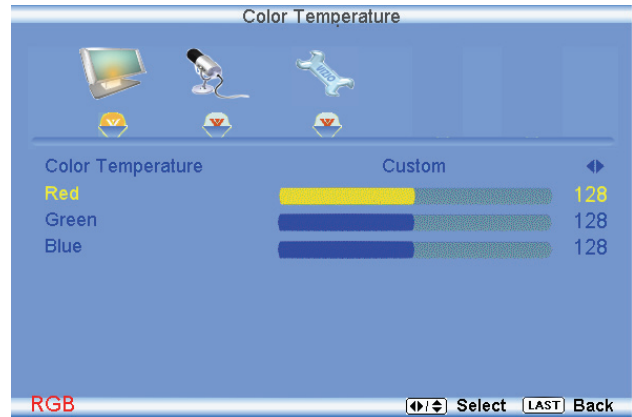

Once the adjustments are completed press the **LAST** button repeatedly to exit the OSD completely.



H-SIZE

Press the  button to highlight the H-Size selection.

Press the  button to start adjusting the horizontal size of the picture.



Use the  or  button to adjust the horizontal size.

Once the adjustments are completed press the **LAST** button repeatedly to exit the OSD completely.

H-Position

Press the  button to highlight the Horizontal Shift selection.

Press the  button to start adjusting the horizontal position of the picture.

Use the  or  button to adjust the horizontal position.

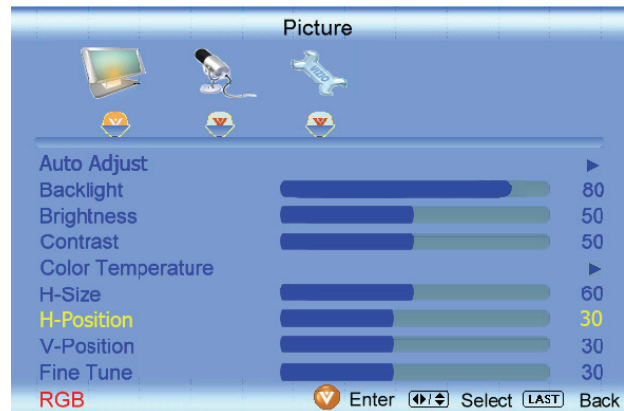

Once the adjustments are completed press the **LAST** button repeatedly to exit the OSD completely.



V-Position

Press the  button to highlight the Vertical Shift selection.

Press the  button to start adjusting the vertical position of the picture.

Use the  or  button to adjust the vertical position.

Once the adjustments are completed press the **LAST** button repeatedly to exit the OSD completely.

Fine Tune

Press the  button to highlight the Fine Tune selection.

Press the  button to start tuning the to the PC signal.

Use the  or  button to adjust the tuning.

Once the adjustments are completed press the **LAST** button repeatedly to exit the OSD completely.



PC Input Audio Adjustment

The Audio Adjust menu operates in the same way for the PC Input as for the DTV / TV input in section 0. The menu difference is that there are no icons along the top for DTV / TV and Parental Control adjustments.



PC Input Setup

The Setup menu operates in the same way for the PC Input as for the DTV / TV input in section 0. The menu difference is that there is no icon along the top for TV adjustments and no Closed Caption.



Understanding Viewing Features

Your HDTV features the following viewing modes. You can switch viewing modes using the remote control, please follow the instructions in page 39.

Viewing Modes

Normal Mode

The original 4:3 aspect ratio (1.33:1 source) is preserved, so black bars are added to the left and right of the display image. Standard TV broadcasts are displayed with a 4:3 Aspect Ratio. Movies in 4:3 Aspect Ratio may be referred to as pan-and-scan or full frame. These movies were originally filmed in 16:9 (widescreen), and then modified to fit a traditional TV screen (4:3).

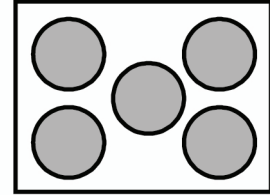

Wide Mode

When watching a standard broadcast or full-frame movie in this mode, the display image is stretched proportionately to fill the TV screen. When watching a widescreen (1.78:1 source) program or movie, the display image fills the TV screen. If you are watching a widescreen (1.85:1 or 2.35:1 source) program or movie, there will still be black bars at the top and bottom.

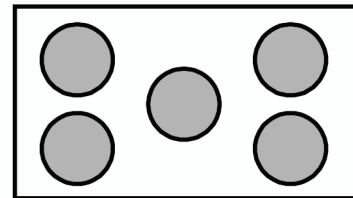

Stretch Mode

When watching a widescreen program (1.78:1 source) with black bars on the sides, the display image will stretch to fill the TV screen. People will appear wider than they really are. If you are watching a widescreen (1.85:1 or 2.35:1 source) program or movie, there will still be black bars at the top and bottom. This mode is available only when watching a widescreen program.

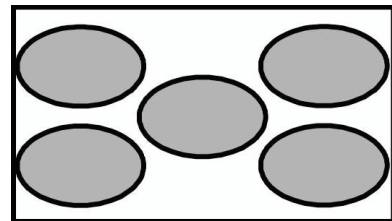

Panoramic Mode

When watching a standard broadcast or full frame movie in this mode, the 4:3 Aspect Ratio (1.33:1 source) display image is stretched horizontally on the left and right sides to fill the TV screen. The center of the image is not stretched.

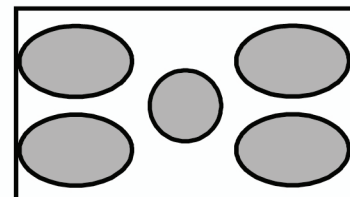

Chapter 5 Maintenance and Troubleshooting

Maintenance

Important

1. Make sure that the power cable is removed from the socket before cleaning the TV.
2. Do not use volatile solvent (such as toluene, rosin and alcohol) to clean the TV. Such chemicals may damage the housing, screen glass and remote control, and cause paint to peel.

Cleaning the Housing and Remote Control

1. Use a soft cloth for cleaning.
2. If the housing or remote control is seriously contaminated, use a soft cloth moistened with diluted neutral cleaner to clean the display. Wring water out of the cloth before cleaning to prevent water from penetrating into the housing. Wipe the display with a dry cloth after cleaning.

Cleaning the Screen

1. Use a soft cloth to gently clean the screen.
2. The screen glass is very fragile. Do not scrape it with any sharp object. Do not press or tap the screen to avoid cracking. When the screen is seriously contaminated, use a soft cloth moistened with diluted neutral cleaner to clean the display. Wring water out of the cloth before cleaning to prevent water from penetrating into the housing. Wipe the display with a dry cloth after cleaning.



Troubleshooting Guide

If the TV fails or the performance changes dramatically, check the display in accordance with the following instructions. Remember to check the peripherals to pinpoint the source of the failure. If the display still fails to perform as expected, contact the VIZIO for assistance by calling 1-877-MYVIZIO (698-4946) or e-mail us at techsupport@vizio.com.

Problem	Solution
No power.	<p>Make sure the power button is ON (White VIZIO Logo).</p> <p>Make sure AC power cord is securely connected to the AC socket.</p> <p>Plug another electrical device (like a radio) to the power outlet to verify that the outlet is supplying the proper voltage.</p>
No sound.	<p>Check your audio connection</p> <p>Press MUTE on the remote control again, so that MUTE disappears from the screen</p> <p>Check your audio settings, your TV audio may be set to SAP, min or speakers off</p> <p>Press the Volume + (Up) key on your remote control</p> <p>Make sure that headphones are not connected</p>
If the screen is black.	<p>Check your input connections.</p>
Power is ON but no screen image.	<p>Make sure the video cable supplied with the TV is secured to the correct video output port on the back of the VCR and the TV. Make any cable you have attached to the TV is secured to the correct output your Set-Top Box, DVD, etc.</p> <p>Adjust brightness and contrast.</p> <p>Check Source settings.</p>
Wrong or abnormal colors appear.	<p>If any colors (red, green, or blue) are missing, check the video cable to make sure it is securely connected.</p>
Control buttons do not work.	<p>Press only one button at a time.</p>
Remote Control does not work.	<p>Make sure batteries are inserted correctly</p> <p>Batteries could be weak.</p> <p>Make sure you have selected TV on the remote.</p>
There appears to be image quality issues.	<p>For best image quality, view HD wide screen programs where possible. If HD content is not available view "Standard Definition" from a digital source. Standard, analog TV will always be noticeably inferior to HD because your digital flat panel TV has video that is many times better than old TV's and so you can see interference and deficiencies you did not know you had.</p>
You cannot see a picture.	<p>Make sure that the power cord is plugged into a grounded electrical outlet.</p> <p>Make sure that the power button is turned on.</p> <p>Make sure that the selected input source is connected to a working input source.</p> <p>If your TV is connected to your computer in RGB or HDMI mode, press any key on your keyboard to "wake" your computer.</p>
You see a distorted picture or hear unusual sound.	<p>You may be getting interference from electrical appliances, cars, motorcycles, or fluorescent lights. If you have not mounted it on the wall, try moving your TV to another location to see if this is the cause of the problem.</p>
The picture has abnormal patterns.	<p>Make sure that the input source cable is attached securely and correctly to the back of your TV.</p> <p>Make sure that the video input source is within the range of your TV. Compare the video input source's specifications with your TV specifications.</p>



Problem	Solution
The display image does not cover the entire screen.	If you are using RGB mode, make sure that H Size and V Position in the On Screen Display (OSD) are set correctly. If you are using TV, AV-C (Composite), AV-S (S-Video) or Component with 480i input, follow instructions in page 53 to obtain the desired screen mode.
You can see a picture but you cannot hear sound.	Make sure that the volume is not turned down. Make sure that the sound is not muted. Make sure that your audio input source cables are connected securely and correctly.
The TV has pixels that are always dark or colored.	Your LCD HDTV is manufactured using an extremely high level of precision technology, however, sometimes some pixels of your LCD HDTV may not display. Pixel defects within industry specifications are inherent to this type of product and do not constitute a defective product.
You see "noise" or "trash" on the screen.	When your LCD HDTV's digital capabilities exceed a digital broadcast signal, the signal is up-converted (increased) to match your TV's display capabilities. Up-converting can cause noise or trash.
You switch to a different input and the volume changes.	The TV remembers the volume level from the last time you adjusted it. If the sound level is higher or lower from another source, then the loudness will change.
You switch to a different input and the screen size changes.	The TV remembers the viewing mode from the last time you used a particular input (AV-C (Composite), AV-S (S-Video), Component, HDMI and TV).
Tips for High-Definition Users.	The LCD HDTV is an ideal platform for viewing High Definition Content. Best Image Quality will be achieved by the HDMI Input, then YPbPr, then RGB. However, due to variances in broadcast practices, it is possible some image distortions can occur.
Tips for Letterbox Content Users.	Letterboxed (or "Widescreen") versions of DVD movies are most commonly formatted for standard 4:3 Televisions. The LCD HDTV has the capability of expanding this content so the entire screen is filled at the expense of image accuracy. Follow the instructions in page 32.



Telephone & Technical Support

Products are often returned due to a technical problem rather than a defective product that may result in unnecessary shipping charges billed to you. Our trained support personnel can often resolve the problem over the phone. For more information on warranty service or repair, after the warranty period, please contact our Support Department at the number below.

Customer support and quality service are integral parts of VIZIO's commitment to service excellence. For technical assistance contact our VIZIO Technical Support Department via email or phone.

Email: techsupport@vizio.com

(877) 698-4946 Fax: (949) 585-9563

Hours of operation: Monday - Friday: 6 am to 9 pm

Saturday – Sunday: 8 am to 4 pm

Please have your VIZIO model number, serial number, and date of purchase available before you call.

VIZIO

Address:

39 Tesla

Irvine, CA 92618, USA

Telephone: (949) 428-2525 Fax: (949) 585-9514

Web: www.vizio.com



Compliance

Caution: Always use a power cable that is properly grounded. Please use the AC cords listed below for each area.

USA	UL
Canada	CSA
Germany	VDE
UK	BASE/BS
Japan	Electric Appliance Control Act

FCC Class B Radio Interference Statement

NOTE: This equipment has been tested and found to comply with the limits for a Class B digital device, pursuant to Part 15 of the FCC Rules. These limits are designed to provide reasonable protection against harmful interference in a residential installation. This equipment generates, uses and can radiate radio frequency energy, and if not installed and used in accordance with the instructions, may cause harmful interference to radio communications. However, there is no guarantee that interference will not occur in a particular installation. If this equipment does cause harmful interference to radio or television reception, which can be determined by turning the equipment off and on, the user is encouraged to try to correct the interference by one or more of the following measures:

1. Reorient or relocate the receiving antenna.
2. Increase the separation between the equipment and receiver.
3. Connect the equipment into an outlet on a circuit different from that to which the receiver is connected.
4. Consult the dealer or an experienced radio/TV technician for help.

Notice:

1. The changes or modifications not expressly approved by the party responsible for compliance could void the user's authority to operate the equipment.
2. Shielded interface cables and AC power cord, if any, must be used in order to comply with the emission limits.
3. The manufacturer is not responsible for any radio or TV interference caused by unauthorized modification to this equipment. It is the responsibilities of the user to correct such interference.



Chapter 6 Miscellaneous Information

Specifications

Specifications			
Panel	32" Diagonal, 16:9 Aspect Ratio		
Resolution	1920 x 1080 pixels		
Pixel (Dot) Pitch	0.36375(H) x 0.36375(V)		
Display Compatibility	FHDTV (1080P)		
Colors	16.7 Million		
Brightness cd/m ² (typical)	480nits		
Contrast	1300:1		
Contrast Ratio with DCR	6500:1		
Response Time	6.5ms (typical)		
Viewing Angle	>178° (horizontal/vertical)		
Inputs	<table border="1"> <tr> <td>1x RF (ATSC/QAM/NTSC) 2x Composite Video and stereo audio (one stereo audio shared with Component input) 1x S-Video 1x (USB service only)</td> <td>2x Component and stereo audio (one stereo audio shared with Composite input) 3x HDMI v1.3 with HDCP (with stereo audio), 1 with Stereo Audio RCA 1x RGB plus stereo audio</td> </tr> </table>	1x RF (ATSC/QAM/NTSC) 2x Composite Video and stereo audio (one stereo audio shared with Component input) 1x S-Video 1x (USB service only)	2x Component and stereo audio (one stereo audio shared with Composite input) 3x HDMI v1.3 with HDCP (with stereo audio), 1 with Stereo Audio RCA 1x RGB plus stereo audio
1x RF (ATSC/QAM/NTSC) 2x Composite Video and stereo audio (one stereo audio shared with Component input) 1x S-Video 1x (USB service only)	2x Component and stereo audio (one stereo audio shared with Composite input) 3x HDMI v1.3 with HDCP (with stereo audio), 1 with Stereo Audio RCA 1x RGB plus stereo audio		
Outputs	1x SPDIF Optical Digital Audio, 1x Stereo Audio, 1x Headphone		
Features	<p>1080P FHDTV, HDMI v1.3, 3D comb filter, Zero bright pixel guarantee, Dynamic Contrast Ratio technology, HD game port, Noise reduction, MTS stereo decoder, Digital amplifier, Dolby Digital for ATSC/QAM, Channel skip, Video/input naming capability, Closed caption, Parental control/V-Chip 2.0, Programmable Timer, Freeze, PIP/POP, SRS TSXT Audio Enhancement.</p> <p>ATSC/Clear QAM tuner, NTSC video decoding via RF or composite video, 3:2 or 2:2 reverse pull-down, Motion adaptive de-interlace, Progressive video scan via component video/VGA/HDMI, HDTV via HDMI or component video, FHDTV via HDMI or component video, Color temperature adjustments of 6500K/9300K/11000K, Independent Red/Green/Blue adjustments for color temperature fine tuning, Signal Compatibility 480i (SDTV), 480P (EDTV), 720P (HDTV), 1080i (HDTV), 1080P (FHDTV), Computer support at 640x480/800x600/1024x768/1920x1080 via VGA/HDMI.</p>		
Speakers	2xBuilt-in, 12W Speakers		
Panel Life	50,000 hours to half the original brightness		
Power			
Input	IEC Connector for direct power line connection		
Voltage Range	120Vac at 50/60Hz		
Power Consumption	110W (AVG) , 0.40W standby		
Environmental Conditions			
Operating	Temperature: 5°C~35°C, Relative Humidity: 20~80%, Altitude: 0~14,000 ft		
Non-Operating	Temperature: -20°C~50°C, Relative Humidity: 10~90%, Altitude: 0~40,000 ft		



Dimensions	31.57"W x 22.38"H x 8.58"D with stand; 31.57"W x 21.13"H x 4.13"D without stand
Net Weight	26 lbs without stand, 27.56 lbs with stand
Gross Weight	36.6 lbs
Certifications	CSA C/US, FCC Class B, BETS-7

*Product specifications may change without notice or obligation.

Glossary - Standard Definitions

Analog TV: Today's TV system using radio frequency waves to transmit and display pictures and sound.

Aspect Ratio (4x3): Traditional TV "aspect ratio", that is, the screen's width as compared to its height. For example, a "32 inch TV screen" would be 25 inches wide and 19 inches tall.

Aspect Ratio (16x9): "Wide screen TV" aspect ratio which is more like a movie screen than a traditional TV. For example, a "32 inch TV screen" would be 28 inches wide and 16 inches tall.

Digital TV (DTV): Television delivered and displayed using radio frequency waves that contain information that is digitally encoded for improved quality and efficiency.

Enhanced Definition TV (EDTV): A better digital television transmission than SDTV with at least 480P, in a 16x9 or 4x3 display and Dolby digital surround sound. 480P is the quality used by most DVD players. EDTV provides 300-400,000 pixels.

HDTV Monitor (sometimes called HDTV Ready): A set that can display HDTV programming if you have a separate HDTV tuner, HD Cable Set-Top Box or HD Satellite Set-Top-Box Receiver.

HDTV Tuner (also decoder, receiver, set-top box): A device capable of receiving and outputting HDTV signals for display. It may be stand-alone or integrated in the set.

High-Definition Television (HDTV): The best quality picture, wide screen (16x9) display with at least 720 progressively scanned lines (720P) or 1080 interlaced lines (1080i) and Dolby digital surround sound. HDTV provides 900,000-2.1 million pixels.

Integrated HDTV: An HDTV that has the digital tuner built into the set. It does not need a separate set-top box to receive over-the-air DTV signals.

Interlace Scan: A way to scan vertical lines onto a TV picture by scanning all the odd lines first, then filling the in the even lines (this happens instantaneously).

Plug-and-Play or Digital Cable Ready: A DTV or other device for digital cable consumers that plugs directly into the cable jack and does not require a separate set-top box. Plug-and-Play TV owners must obtain a CableCARD from their cable company in order to view scrambled programming services.

Progressive Scan: A way to scan vertical lines onto a TV picture by scanning all the lines consecutively (progressively).

Standard Definition TV (SDTV): Basic digital television transmission that may be displayed with fewer than 480 progressively scanned lines (480P) in 16 x 9 or 4 x 3 format. 480 interlaced (480i) is the quality of today's analog TV system.

Source: Buying a Digital Television, CEA, HDTV Guide, 2005

Note: The Federal Communications Commission (FCC), the Consumer Electronics Association (CEA) and the Consumer Electronics Retailers Coalition (CERC) have made a new tip sheet available for digital television (DTV) retailers to reproduce and distribute to consumers on the sales floor. The file may be downloaded online at www.dtv.gov. While you're there, check out the other useful information in the FCC is making available to consumers interested in learning more about the analog to digital transition.



Limited Product Warranty

VIZIO provides a "ONE-YEAR LIMITED WARRANTY" against manufacturing defects in materials and workmanship to the original purchaser of a new VIZIO display purchased from an authorized VIZIO U.S. reseller and used in the fifty (50) United States or Puerto Rico.

VIZIO's Responsibility

VIZIO displays purchased new from an authorized VIZIO U.S. reseller and that are used in the fifty (50) United States or Puerto Rico are warranted to be free from manufacturing defects in materials and workmanship for one (1) year from the date of the original retail purchase. If the display fails to conform to this limited warranty, VIZIO will, at its option and sole discretion, repair or replace the display.

Labor

During the one-year limited warranty period, VIZIO will provide, when needed, service labor to repair a manufacturing defect. Repairs required on displays which are thirty (30) inches and larger generally will be made "on-site" where the display is installed. The determination for performing the on-site repair is dependent upon the manufacturing defect and is at VIZIO's option and sole discretion. Repairs required on displays which are less than thirty (30) inches generally will be performed at a VIZIO service center.

Parts

Repairs may be made with new or recertified parts, or the entire unit may be replaced with a new or recertified unit, at VIZIO's option and sole discretion. Replacement parts or replacement units provided under this limited warranty are warranted for the remaining portion of the original warranty period, or for ninety (90) days from warranty service or replacement, whichever is later.

How to Obtain Warranty Service

To obtain warranty service, contact VIZIO Technical Support via email at TechSupport@VIZIO.com, via phone at 877-MYVIZIO (877-698-4946), or via postal mail at VIZIO Technical Support, 39 Tesla, Irvine, CA 92618. You must provide the model, serial number, and date of purchase. VIZIO Technical Support is available from 6:00AM to 9:00PM Pacific Time, Monday through Friday, and 10:00AM to 2:00PM Pacific Time, Saturday and Sunday. Please note that holiday hours may vary. For up to date information, please visit www.VIZIO.com.

VIZIO reserves the right to assess all warranty claims and to determine if defects or damages are covered by this limited warranty. In case of a claim that is not covered by this warranty, you will be contacted to determine whether VIZIO should repair the damage for a fee or whether the product should be returned to you as received by the service technician or service center.

Parts and service labor that are VIZIO's responsibility under this limited warranty will be provided without charge. All other service is at the customer's expense. VIZIO reserves the right to charge the customer for any service call for anything not covered by this limited warranty. Before you ask for warranty service, please review your User Manual. You may avoid a service call and a service charge.

Please refer to the reverse side of this page for additional information regarding how to obtain warranty service.

PLEASE DO NOT RETURN YOUR UNIT TO VIZIO WITHOUT PRIOR AUTHORIZATION.

Not Covered

This limited warranty does not cover the following: cosmetic defects; damage, malfunctions or failures resulting from shipping or transit, improper or faulty installation, abuse, operation contrary to furnished instructions, operation on incorrect power supplies, products not supplied by VIZIO, modification, alteration, improper servicing or tampering; damage from fire, water, lightning, power surges, abnormal environmental conditions or other acts of nature; normal wear and tear; unsatisfactory visual or audio performance not caused by a manufacturing defect; or displays with a missing or unreadable serial number. Operation of the display for commercial purposes or in applications or uses for which the display is not intended is not covered by this limited warranty. "Image Sticking", caused by static images on the screen for extended periods and or excessive brightness and contrast levels, is not covered by this



limited warranty. Installation, removal, transportation and reinstallation of a display, and routine maintenance and cleaning, are not covered by this limited warranty.

THERE ARE NO EXPRESS WARRANTIES OTHER THAN THOSE LISTED OR DESCRIBED ABOVE. ANY IMPLIED WARRANTIES, INCLUDING ANY IMPLIED WARRANTY OF MERCHANTABILITY AND FITNESS FOR A PARTICULAR PURPOSE, SHALL BE LIMITED IN DURATION TO THE PERIOD OF TIME SET FORTH ABOVE. VIZIO'S TOTAL LIABILITY FOR ANY AND ALL LOSSES AND DAMAGES RESULTING FROM ANY CAUSE WHATSOEVER, INCLUDING VIZIO'S NEGLIGENCE, ALLEGED DAMAGE, OR DEFECTIVE GOODS, WHETHER SUCH DEFECTS ARE DISCOVERABLE OR LATENT, SHALL IN NO EVENT EXCEED THE PURCHASE PRICE OF THE DISPLAY. VIZIO SHALL NOT BE RESPONSIBLE FOR LOSS OF USE, COMMERCIAL LOSS, LOST REVENUE OR LOST PROFITS, OR OTHER INCIDENTAL OR CONSEQUENTIAL DAMAGES. SOME STATES DO NOT ALLOW LIMITATIONS ON HOW LONG AN IMPLIED WARRANTY LASTS OR THE EXCLUSION OR LIMITATION OF INCIDENTAL OR CONSEQUENTIAL DAMAGES, SO THE ABOVE LIMITATIONS OR EXCLUSIONS MAY NOT APPLY TO YOU.

This warranty gives you specific legal rights, and you may also have other rights, which vary from state to state. This is the only warranty applicable; no one is authorized to extend or modify it or to grant any other warranty on VIZIO's behalf.

Owner's Responsibility

To ensure warranty service, keep the dated bill or sales receipt as evidence of the purchase date and location. This limited warranty applies only to original purchaser and is non-transferable.

Note: Warranty service conditions are subject to change. For the latest Warranty Terms and Conditions and additional information regarding VIZIO's Limited Product Warranty, please see complete details online at www.VIZIO.com.

VIZIO Return Policy

VIZIO's return policy allows for products purchased directly from VIZIO to be returned by the original purchaser during the initial thirty (30) day period following the date of purchase. A VIZIO return authorization number must first be obtained as provided below. The refund will be the purchase price actually paid by the purchaser less a ten percent (10%) restocking fee per each item returned. Shipping and handling are not refundable.

The return authorization number must first be obtained from VIZIO's Customer Service by emailing CustomerSupport@VIZIO.com or by calling 949-428-2525, 6:00AM to 9:00PM Pacific Time, Monday through Friday, and 10:00AM to 2:00PM Pacific Time, Saturday and Sunday. Please note that holiday hours may vary. For up to date information, please visit www.VIZIO.com.

Products must be returned to the address specified by VIZIO Customer Service and must be shipped in the original packaging, with freight prepaid to VIZIO, and must be received in new and unused condition. The return authorization number must be included in the packaging. VIZIO reserves the right to assess fees for any damaged or missing parts in addition to the ten percent (10%) restocking fee.

Return authorization numbers are valid for only fifteen (15) days from issuance. The customer is responsible for and must prepay all shipping charges and shall assume all risk of loss or damage to the product while in transit to VIZIO. If the product is returned to VIZIO (i) without a VIZIO return authorization number, and/or (ii) beyond the fifteen (15) day period, and/or (iii) without proper packaging, VIZIO retains the right to refuse delivery of such return or may return the unit to the customer at the customer's expense and with no refund issued. This return policy does not apply to defective products. Please read VIZIO's Limited Product Warranty for warranty terms and conditions.

On-Site Warranty Repair Procedure

On-Site Warranty Repair generally is performed on repairable displays which are 30 inches and larger.

If VIZIO Technical Support determines that a problem with a display unit may be within the terms and conditions of the VIZIO Limited Product Warranty and that an on-site repair may be performed, the customer will be provided with an on-site repair authorization number and on-site repair instructions. The



determination for performing the on-site repair may be dependent upon the manufacturing defect and is at VIZIO's option and sole discretion. Proof of purchase is required to confirm the product is within the one-year limited warranty period and meets the terms and conditions of the VIZIO Limited Product Warranty.

On-site repair service is requested through VIZIO's third-party service provider. After VIZIO provides the customer with the on-site repair (OSR) authorization number, the third-party service provider will contact the customer and will schedule the repair at the customer's location. The total approximate time for the repair process, which includes the repair diagnosis, dispatching the technician, shipping the replacement part(s), and arranging the appointment with the customer, is completed within approximately 3 to 5 business days, pending availability of these factors.

If it is determined the product can not be repaired on-site, the customer will be required to ship the unit to VIZIO's service center, per the below warranty replacement procedure.

VIZIO is not responsible for the de-installation or re-installation of the product. However, some standard installation may be performed during the on-site repair, at VIZIO's option and sole discretion. Please read VIZIO's Limited Product Warranty for warranty terms and conditions.

Warranty Replacement Procedure

Warranty Replacement generally is performed on displays which are determined to be economically unrepairable.

If VIZIO Technical Support determines that a problem with a display unit may be within the terms and conditions of the VIZIO Limited Product Warranty and that a repair is not economically possible, based on certain manufacturing defects in materials and/or workmanship, and/or at VIZIO's option and sole discretion, the customer will be provided with a return authorization number and replacement instructions. Proof of purchase is required to confirm the product is within the one-year limited warranty period and meets the terms and conditions of the VIZIO Limited Product Warranty.

For displays forty-two inches (42") and larger, VIZIO will generally cover the transportation charges to perform an on-site swap of the original unit with the replacement unit. For displays under forty-two inches (42"), the customer is responsible for the transportation charges to VIZIO's service center. VIZIO will be responsible for the return transportation charges from the service center to the customer. Please read VIZIO's Limited Product Warranty for warranty terms and conditions.

Mail-In Warranty Repair Procedure

Mail-In Warranty Repair generally is performed on displays which are smaller than 30 inches.

If VIZIO Technical Support determines that a problem with a display unit may be within the terms and conditions of the VIZIO Limited Product Warranty and that a mail-in repair may be performed, the customer will be provided with a return authorization number and mail-in repair instructions. Proof of purchase is required to confirm the product is within the one-year limited warranty period and meets the terms and conditions of the VIZIO Limited Product Warranty.

The customer will be provided with instructions for packing and shipping the unit to the VIZIO service center. The original carton box and packing material, or an equivalent as designated by VIZIO, must be utilized. The cost of shipping to VIZIO's service center is at the customer's expense. After the product is repaired and tested, the VIZIO service center will ship the unit back to the customer at VIZIO's expense. VIZIO is not responsible for the de-installation or re-installation of the product. Please read VIZIO's Limited Product Warranty for warranty terms and conditions.

PLEASE DO NOT RETURN YOUR UNIT TO VIZIO WITHOUT PRIOR AUTHORIZATION.



Index

A

- Accessories, 6
- Adjustments
 - Selecting the Screen Size, 70, 77
 - Stepping through TV Channels, 39
 - Volume, 11, 39, 72
- Advanced Video Features
 - Black Level Extender, 45
 - Color Temperature (Color Temperature, 45
 - CTI (Color Transient Improvement, 45
 - DNR (Dynamic Noise Reduction, 44
 - Flesh Tone, 45

C

- Cleaning your VIZIO TV, 71
- Coax (RF)
 - Connecting for DTV, 18
 - Connecting your Basic Set Top Box, 22
- Component
 - Connecting your DVD Player, 25
 - Connecting your HDTV Set-Top Box, 21
- Composite (AV)
 - Connecting your Basic Set-Top Box, 22
 - Connecting your DVD Player, 26
- Controls
 - Front Panel, 11
 - Side Panel, 11

D

- Disassembling, 9
- DTV
 - Audio Adjustment, 46
 - Parental Control, 57
 - Picture Adjustment, 42
 - Special Features, 51
 - Tuner Setup, 49
- DTV Audio Adjust
 - Analog Audio Out, 48
 - Balance, 47
 - Digital Audio Out, 48
 - Equalizer, 47
 - Lip Sync, 48
 - Reset Audio Mode, 49
 - Speakers, 48
 - SRS TSXT, 47
 - Volume, 46
- DTV Picture Adjust
 - Advanced Video, 44
 - Backlight, 42, 65
 - Brightness, 43, 66
 - Color, 43
 - Color Temperature, 67
 - Contrast, 43, 66
 - Reset Picture Mode, 46
 - Sharpness, 44
 - Tint, 44

- DTV Special Features
 - Digital Closed Caption, 55
 - Input Naming, 54
 - Language, 51
 - PIP, 51
 - Reset, 62
 - Sleep Timer, 51, 53
 - Wide, 53
- DTV Tuner Setup
 - Auto Search, 49
 - Daylight Saving, 51
 - MTS, 50
 - Partial Channel Search, 50
 - Skip Channel, 50
 - Time Zone, 50
 - Tuner Mode, 49
- DVI
 - Connecting your DVD Player, 24
 - Connecting your HDTV Set-Top Box, 20

F

- FCC Bulletin for New TV Owners, 4

G

- Glossary, 77

H

- HDMI
 - Connecting your DVD Player, 23
 - Connecting your HDTV Set-Top Box, 19
- HDMI Input
 - Audio Adjustment, 63
 - Picture Adjustment, 62
 - Setup, 63

I

- Inputs
 - Antenna, 4
 - Connectors, 17
 - Rear Label, 12
- Installation
 - Base removal, 8
 - Preparation, 6
 - Wall Mounting, 6, 8, 32

O

- OSD
 - Brightness Adjustment, 76
 - Color Adjustment, 17
 - Contrast Adjustment, 76
- Outputs
 - Using 5.1 Surround with a Home Theatre System, 29



P

- Parental Control
 - Block Unrated Programming, 61
 - Canadian English Rating, 59
 - Canadian French Rating, 60
 - Channel Block, 58
 - DTV Rating, 60
 - Movie Rating, 59
 - Password change, 61
 - Rating Enable, 57
 - TV Rating, 58
- PC Input
 - Audio Adjustment, 69
 - Auto Adjust, 65
 - Picture Adjustment, 65
 - Setup, 69
- PC Picture Adjust
 - Fine Tune, 68
 - H/V Position, 56
 - Horizontal Position, 56, 68
 - Horizontal Size, 56, 68
 - Vertical Position, 56, 68

R

- Remote, 14
 - Batteries, 16
 - Range, 16
- Remote:, 16
- RGB
 - Connecting your PC, 30

S

- safety instructions, 2
- Screen Size explanation, 70
- S-Video
 - Connecting your DVD Player, 26
 - Connecting your VCR, 27
 - Connecting your Video Camera, 27

T

- Technical Specifications, 76
- Troubleshooting Guide, 72
- TV

- Audio Adjustment, 46
- Parental Control, 57
- Picture Adjustment, 42
- Special Features, 51
- TV Picture Adjust
 - Advanced Video, 44
 - Backlight, 42, 65
 - Brightness, 43, 66
 - Color, 43
 - Color Temperature, 67
 - Contrast, 43, 66
 - Reset Picture Mode, 46
 - Sharpness, 44
 - Tint, 44
- TV Special Features
 - Closed Caption, 55
 - Input Naming, 54
 - Language, 51
 - PIP, 51
 - Reset, 62
 - Sleep Timer, 51, 53
 - Wide, 53
- TV Tuner Setup, 49
 - Auto Search, 49
 - MTS, 50
 - Partial Channel Search, 50
 - Skip Channel, 50
 - Tuner Mode, 49

V

- Video Input
 - Audio Adjustment, 64
 - Auto Phase, 64
 - Parental Control, 65
 - Picture Adjustment, 63
 - Setup, 64

W

- Warranty, 78
- Watching TV
 - Basic Adjustments, 39
 - Basic connections, 32
 - First Startup, 32
 - Getting your Programs, 38
 - Program Information, 40
 - Status Information, 40



Free Manuals Download Website

<http://myh66.com>

<http://usermanuals.us>

<http://www.somanuals.com>

<http://www.4manuals.cc>

<http://www.manual-lib.com>

<http://www.404manual.com>

<http://www.luxmanual.com>

<http://aubethermostatmanual.com>

Golf course search by state

<http://golfingnear.com>

Email search by domain

<http://emailbydomain.com>

Auto manuals search

<http://auto.somanuals.com>

TV manuals search

<http://tv.somanuals.com>