



TELEDYNE
ANALYTICAL INSTRUMENTS

OPERATING INSTRUCTIONS
Series Model 7500
Infrared Gas Analyzer

DANGER

HIGHLY TOXIC AND OR FLAMMABLE LIQUIDS OR GASES MAY BE PRESENT IN THIS MONITORING SYSTEM.

PERSONAL PROTECTIVE EQUIPMENT MAY BE REQUIRED WHEN SERVICING THIS SYSTEM.

HAZARDOUS VOLTAGES EXIST ON CERTAIN COMPONENTS INTERNALLY WHICH MAY PERSIST FOR A TIME EVEN AFTER THE POWER IS TURNED OFF AND DISCONNECTED.

ONLY AUTHORIZED PERSONNEL SHOULD CONDUCT MAINTENANCE AND/OR SERVICING. BEFORE CONDUCTING ANY MAINTENANCE OR SERVICING CONSULT WITH AUTHORIZED SUPERVISOR/MANAGER.

P/N
06/20/06
ECO #

PRELIMINARY

We are grateful for your purchase of Teledyne Analytical Instrument's Model 7500 Infrared Gas Analyzer.

- First read this instruction manual carefully until an adequate understanding is acquired, and then proceed to installation, operation and maintenance of the analyzer. Wrong handling may cause an accident or injury.
- The specifications of this analyzer are subject to change without prior notice for further product improvement.
- Modification of this analyzer is strictly prohibited unless a written approval is obtained from the manufacturer. Teledyne will not bear any responsibility for a trouble caused by such a modification.
- This instruction manual shall be stored by the person who actually uses the analyzer.
- After reading the manual, be sure to store it at a place easier to access.
- This instruction manual should be delivered to the end user without fail

Delivered Items:

Analyzer main frame (1)
Power cable (1)
Fuse (2) Rating : 1 A
Instruction manual (1)
Side rail (2) Option

- It is prohibited to transfer part or all of this manual without Teledyne's permission.
- Description in this manual is subject to change without prior notice for further improvement.

SAFETY PRECAUTIONS

Please read this section carefully to ensure using the analyzer in the correct way.

The cautionary descriptions listed here contain important information about safety, so they should always be observed. Those safety precautions are ranked in 3 levels, "DANGER", "CAUTION" and "PROHIBITED".

DANGER	Wrong handling may cause a dangerous situation, in which there is a risk of death or heavy injury.
CAUTION	Wrong handling may invite a dangerous situation, in which there is a possibility of medium-level trouble or slight injury or only physical damage is predictable.
PROHIBITED	Items which must not be done are noted.

Caution on installation and transport of gas analyzer	
DANGER	<ul style="list-style-type: none"> • This unit is not explosion-proof type. Do not use it in a place with explosive gases to prevent explosion, fire or other serious accidents.
CAUTION	<ul style="list-style-type: none"> • For installation, observe the rule on it given in the instruction manual and select a place where the weight of gas analyzer can be endured. Installation at an unsuited place may cause turnover or fall and there is a risk of injury. • For lifting the gas analyzer, be sure to wear protective gloves. Bare hands may invite an injury. • Before transport, fix the casing so that it will not open. Otherwise, the casing may be separated and fall to cause an injury. • During installation work, care should be taken to keep the unit free from cable chips or other foreign objects. Otherwise, it may cause fire, trouble or malfunction of the unit.

Caution on piping	
DANGER	<p>In piping, the following precautions should be observed. Wrong piping may cause gas leakage. If the leaking gas contains a toxic component, there is a risk of serious accident being induced. Also, if combustible gas is contained, there is a danger of explosion, fire or the like occurring.</p> <ul style="list-style-type: none"> • Connect pipes correctly referring to the instruction manual. • Exhaust should be led outdoors so that it will not remain in the locker and installation room. • Exhaust from the analyzer should be relieved in the atmospheric air in order that an unnecessary pressure will not be applied to the analyzer. Otherwise, any pipe in the analyzer may be disconnected to cause gas leakage. • For piping, use a pipe and a pressure reducing valve to which oil and grease are not adhering. If such a material is adhering, a fire or the like accident may be caused.
Caution on wiring	
CAUTION	<ul style="list-style-type: none"> • Wiring work must be performed with the main power set to OFF to prevent electric shocks. • Enforce construction of class-D rounding wire by all means. If the specified grounding construction is neglected, a shock hazard or fault may be caused. • Wires should be the proper one meeting the ratings of this instrument. If using a wire which cannot endure the ratings, a fire may occur. • Be sure to use a power supply of correct rating. Connection of power supply of incorrect rating may cause fire.
Caution on use	
DANGER	<ul style="list-style-type: none"> • For correct handling of calibration gas or other reference gases, carefully read their instruction manuals beforehand. Otherwise, carbon monoxide or other hazardous gases may cause an intoxication particularly.
CAUTION	<ul style="list-style-type: none"> • Before leaving unused for a long time or restarting after left at such a status for an extended length of time, follow the directions of each instruction manual because they are different from normal starting or shutdown. Otherwise, the performance may be poor and accidents or injuries may be caused. • Do not operate the analyzer for a long time with its door left open. Otherwise, dust, foreign matter, etc. may stick on internal walls, thereby causing faults.

Caution on use	
PROHIBITED	<ul style="list-style-type: none"> • Do not allow metal, finger or others to touch the input/output terminals in the instrument. Otherwise, shock hazard or injury may occur. • Do not smoke nor use a flame near the gas analyzer. Otherwise, a fire may be caused. • Do not allow water to go into the gas analyzer. Otherwise, hazard shock or fire in the instrument may be caused.
Caution on maintenance and check	
DANGER	<ul style="list-style-type: none"> • When doors are open during maintenance or inspection, be sure to purge sufficiently the inside of the gas analyzer as well as the measuring gas line with nitrogen or air, in order to prevent poisoning, fire or explosion due to gas leak.
CAUTION	<p>Be sure to observe the following for safe operation avoiding the shock hazard and injury.</p> <ul style="list-style-type: none"> • Remove the watch and other metallic objects before work. • Do not touch the instrument wet-handed. • If the fuse is blown, eliminate the cause, and then replace it with the one of the same capacity and type as before. Otherwise, shock hazard or fault may be caused. • Do not use a replacement part other than specified by the instrument maker. Otherwise, adequate performance will not be provided. Besides, an accident or fault may be caused. • Replacement parts such as a maintenance part should be disposed of as incombustibles. For details, follow the local ordinance.
Others	
CAUTION	<ul style="list-style-type: none"> • If the cause of any fault cannot be determined despite reference to the instruction manual, be sure to contact the factory. If the instrument is disassembled carelessly, you may have a shock hazard or injury.

CONTENTS

PREFACE	2
CAUTION ON SAFETY	3
1. OVERVIEW.....	8
2. NAME AND DESCRIPTION OF EACH PART	9
2.1 Description of each unit	9
3. INSTALLATION	10
3.1 Installation conditions	10
3.2 Installation of analyzer	11
3.3 Piping	11
3.4 Sampling	12
3.5 Wiring method	15
4. OPERATION	24
4.1 Preparation for operation	24
4.2 Warm-up operation and regular operation	24
5. DESCRIPTION OF DISPLAY AND OPERATION PANEL	25
5.1 Name and description of operation panel	25
5.2 Overview of display and operation panel	26
5.3 Overview of display screen	27
5.4 General operation.....	30
6. SETTING AND CALIBRATION.....	31
6.1 Changeover of range	31
6.2 Calibration setting	32
6.2.1 Setting of calibration concentration.....	32
6.2.2 Setting of manual zero calibration	34
6.2.3 Setting of calibration range	36
6.2.4 Setting of auto-calibration component	38
6.3 Alarm setting	40
6.3.1 Setting of alarm values	40
6.3.2 Hysteresis setting	42
6.4 Setting of auto calibration	43
6.4.1 Auto calibration	43
6.4.2 Forced stop of auto calibration	45
6.5 Setting of auto zero calibration	47
6.5.1 Auto zero calibration	47
6.5.2 Forced stop of auto zero calibration	49
6.6 Peak alarm setting	51
6.7 Parameter setting	53

6.8 Maintenance mode 57

6.9 Calibration 59

 6.9.1 Zero calibration 59

 6.9.2 Span calibration 60

7. MAINTENANCE 61

 7.1 Daily check 61

 7.2 Daily check and maintenance procedures 61

 7.3 Cleaning of measuring cell 62

 7.3.1 Disassembly and assembly of measuring cell 62

 7.3.2 How to clean cell 67

8. TROUBLESHOOTING 68

 8.1 Error message 68

9. SPECIFICATIONS 70

 9.1 Specifications 70

 9.2 Code symbols 73

 9.3 Outline diagram 78

APPENDIX 80

Drawing List 80

1. OVERVIEW

The Model 7500 infrared gas analyzer measures the concentrations of CO₂, CO, CH₄, SO₂ and O₂ contained in sample gas. CO₂, CO, CH₄ and SO₂ are measured by non-dispersion infrared method, while O₂ is measured by paramagnetic method. A maximum of 4 components including O₂ (a maximum of 3 components for other than O₂ measurement) are simultaneously measurable.

A high-sensitivity mass flow sensor is used in the detector unit of infrared method. Due to use of single beam system for measurement, maintenance is easy and an excellent stability is ensured for a long period of time.

In addition, a microprocessor is built in and a large sized liquid crystal display is provided for easier operation, higher accuracy and more functions.

This analyzer is thus optimum for combustion control of various industrial furnaces, botanical study and global atmospheric research.

2. NAME AND DESCRIPTION OF EACH PART

2.1 Description of each unit

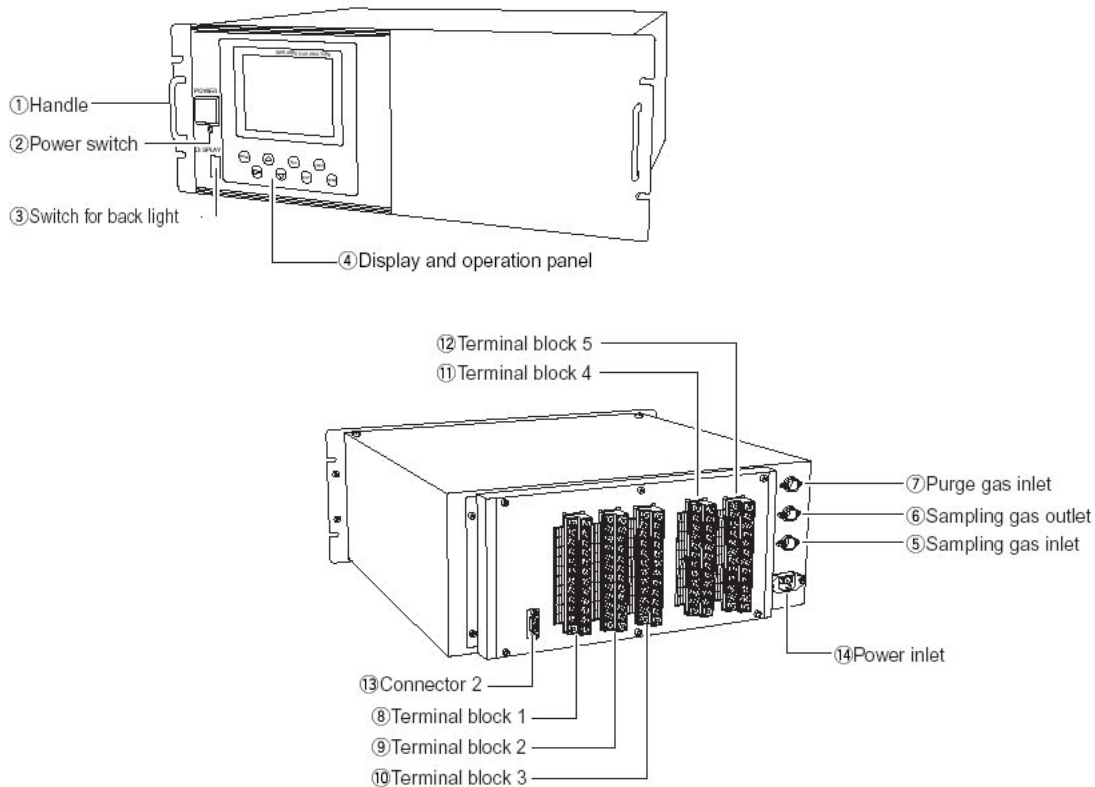

Name	Description
1. Handle	Draws the analyzer unit from the case.
2. Power switch	Turns ON/OFF this analyzer.
3. Switch for back light	Turn ON/OFF the back light of display.
4. Display / Operation panel	Liquid crystal display and keys for various operational settings are arranged.
5. Sampling gas inlet	Port for connecting the sample gas injection pipe.
6. Sampling gas outlet	Port for connecting the pipe for discharging the gas after analysis.
7. Purge gas inlet	Port for connecting the purge gas pipe.
8. Terminal block 1	Analog output terminals
9. Terminal block 2	Analog signal and contact input terminals
10. Terminal block 3	Contact output terminals
11. Terminal block 4	Contact output terminal
12. Terminal block 5	Alarm output terminal
13. Connector 2	Communication interface
14. Power inlet	Used to connect the power cable.

3. INSTALLATION

DANGER

This unit is not explosion-proof type. Do not use it in a place with explosive gases to avoid explosion, fire or other serious accidents.

CAUTION

- For installation, observe the rule on it given in the instruction manual and select a place where the weight of gas analyzer can be endured. Installation at an unsuited place may cause turnover or fall and there is a risk of injury.
- For lifting the gas analyzer, be sure to wear protective gloves. Bare hands may invite an injury.
- Before transport, fix the casing so that it will not open. Otherwise, the casing may be separated and fall to cause an injury.
- The gas analyzer is heavy. It should be transported carefully by two or more persons if manually required. Otherwise, body may be damaged or injured.
- During installation work, care should be taken to keep the unit free from cable chips or other foreign objects. Otherwise, it may cause fire, trouble or malfunction of the unit.

3.1 Installation conditions

To install the analyzer for optimum performance, select a location that meets the following conditions:

(1) Use this instrument indoors.

(2) A vibration-free place

(3) A place which is clean around the analyzer.

(4) Power supply

Rated voltage:	100V to 240VAC
Operating voltage:	85V to 264VAC
Rated frequency:	50/60 Hz
Power consumption:	70 VA max.
Inlet:	Conformity to EN60320 class I type 3-pin inlet

(5) Operation conditions

Ambient temperature:	-5 to 45°C
Ambient humidity:	90% RH or less, no condensation

3.2 Installation of analyzer

There are two methods of installing the analyzer.
For detailed dimensions, see Chapter 9.3.

(Unit:mm)

Types		External dimensions	Mounting dimensions	Mounting method
19 inch rack mounting (Note)	Guide rail			
	Slide rail			

Note: The mounting method should be selected to meet the installation requirements since the top cover must be detached from the gas analyzer for maintenance and check.

Mounting method	Conditions	Remarks
Slide rail	No maintenance space is provided at the top.	These methods must be rigid enough to withstand the mass (about 10 kg) of the gas analyzer.
Guide rail	Maintenance space is provided at the top	

Recommended slide rail: 305A-20, Accuride International Inc.

3.3 Piping

Caution on piping	
CAUTION	<p>In piping, the following precautions should be observed. Wrong piping may cause gas leakage. If the leaking gas contains a toxic component, there is a risk of serious accident being induced. Also, if combustible gas is contained, there is a danger of explosion, fire or the like occurring.</p> <ul style="list-style-type: none"> • Connect pipes correctly referring to the instruction manual. • Exhaust should be led outdoors so that it will not remain in the locker and installation room. • Exhaust from the analyzer should be relieved in the atmospheric air in order that an unnecessary pressure will not be applied to the analyzer. Otherwise, any pipe in the analyzer may be disconnected to cause gas leakage. • For piping, use a pipe and a pressure reducing valve to which oil and grease are not adhering. If such a material is adhering, a fire or the like accident may be caused.

Observe the following when connecting the gas pipes.

- The pipes should be connected to the gas inlet and outlet at the rear panel of the analyzer, respectively.
- Connect the sampling system to the instrument by using corrosion-resistant tube such as Teflon, stainless steel, or polyethylene. In case where there is no danger of corrosion, don't use rubber or soft vinyl tube. Analyzer indication may become inaccurate due to the adsorption of gases.
- Piping connections are Rc1/4 (NPT1/4) female-threaded. Cut the pipe as short as possible for quick response. Pipe of \varnothing 4mm (inside diameter) is recommendable.
- Entry of dust in the instrument may cause operation fault. Use clean pipes and couplings.

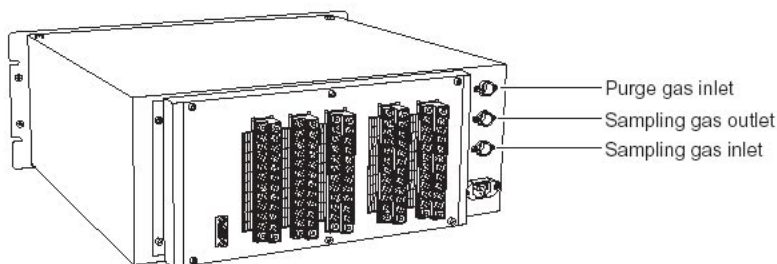

Fig. 3-1 Piping

- Sampling gas inlet:** Connect the pipe so that zero/span calibration standard gas or measured gas pre-treated with dehumidification is supplied properly. The gas flow rate should be kept constant within the range of 1 L/min \pm 0.5 L/min.
- Sampling gas outlet:** Measured gas is exhausted after measurement. Connect the pipe so that the gas may escape through the gas outlet into the atmosphere.
- Purge gas inlet:** It is used for purging the inside of the total gas analyzer. When the analyzer must be purged, refer to Item 3.4, Purging inside Analyzer. Use dry gas N₂ or instrumentation air for purge gas. (flow rate of 1 L/min or more should be used and no dust or mist is contained).

3.4 Sampling

(1) Conditions of sample gas

1. The dust contained in sample gas should be eliminated completely with filters. The filter at the final stage should be capable of eliminating dust of 0.3 microns.
2. The dew point of sample gas must be lower than the ambient temperature for preventing formation of drain in the analyzer. If water vapor is contained in sample gas, its dew point should be reduced down to about 0°C through a dehumidifier.
3. If SO₃ mist is contained in sample gas, the mist should be eliminated with a mist filter, cooler, etc. Eliminate other mist in the same way.
4. If a large amount of highly corrosive gas such as Cl₂, F₂ or HCl is contained in sample gas, the service life of analyzer will be shortened. So, avoid such gases.
5. Sample gas temperature is allowed within a range from 0 to 50°C. Pay attention not to flow hot gas directly into the analyzer.

(2) Sampling gas flow rate

A flow rate of sampling gas must be 1 L/min \pm 0.5 L/min. A flow meter should be provided as shown in Fig. 3-2 to measure flow rate values.

(3) Preparation for standard gas

Prepare the standard gas for zero/span calibration.

	No O2 meter	Built in O2 meter	Externally mounted zirconia O2 meter
Zero gas	N2 gas	N2 gas	Dry air or air (No calibration performed with CO2 meter)
Span gas except for O2	Gas with concentration of 90% or more of full scale	Gas with concentration of 90% or more of full scale	Gas with concentration of 90% or more of full scale
Span gas for O2		Gas with concentration of 90% or more of full scale	1 to 2% of O2 gas

(4) Purging of instrument inside

The inside of instrument need not be purged generally except for the following cases.

1. A combustible gas component is contained in sample gas.
2. Corrosive gas is contained in the atmospheric air at the installation site.
3. The same gas as the sample gas component is contained in the atmospheric air at the installation site.

In such cases as above, the inside of analyzer should be purged with the air for instrumentation or N2. Purging flow rate should be about 1L/min.

If dust or mist is contained in purging gas, it should be eliminated completely in advance.

(5) Pressure at sampling gas outlet

Pressure at the sampling gas outlet should be set to atmospheric pressure.

(6) Example of sampling system configuration

The system configuration may vary depending upon the nature of measured gas, coexistent gases or application. A typical configuration diagram is shown in Fig. 3-2. Since a system configuration depends upon measured gas, consult with Teledyne.

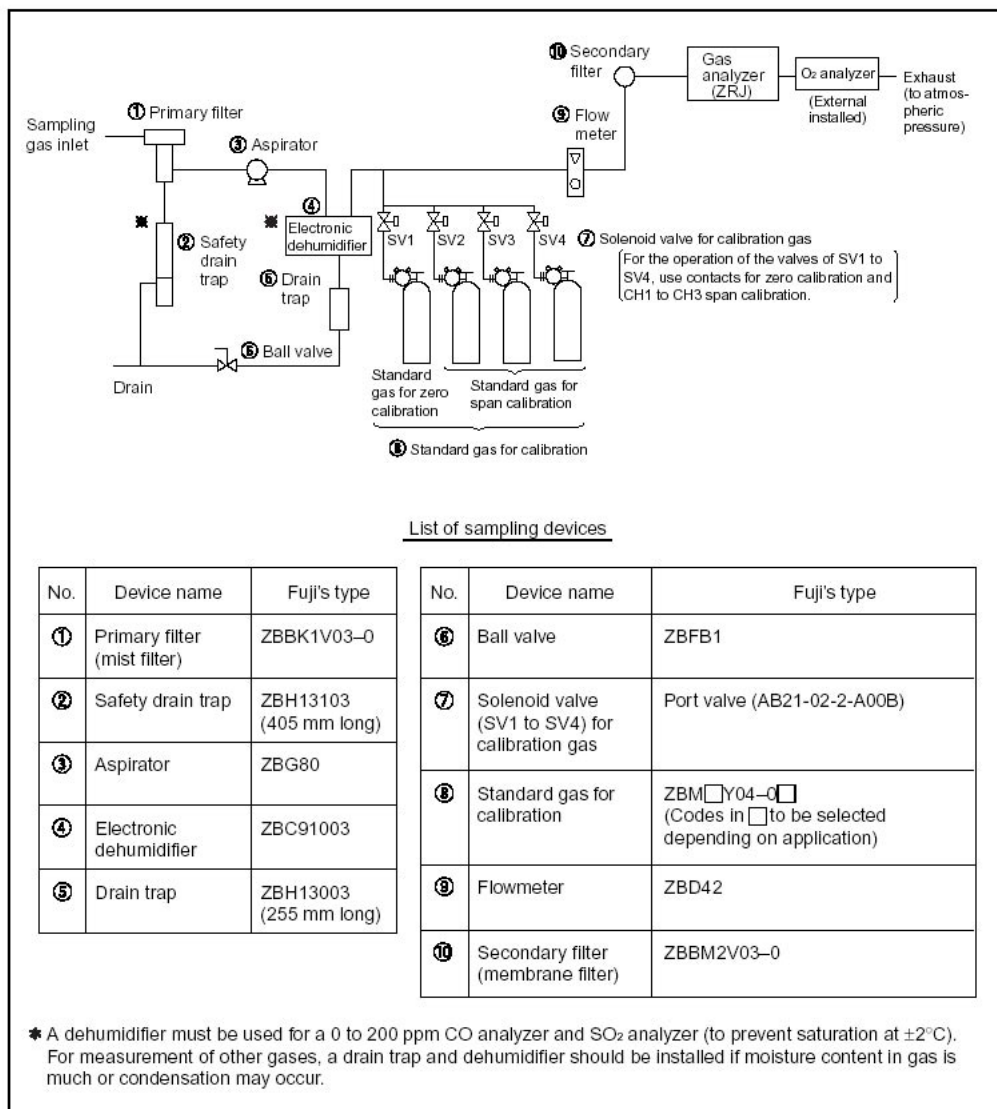

Fig. 3-2 A typical example of sampling system

3.5 Wiring method

Caution on wiring	
CAUTION	<ul style="list-style-type: none"> • Wiring work must be performed with the main power set to OFF to prevent electric shocks. • Enforce construction of class-D grounding wire by all means. <p>If the specified grounding construction is neglected, a shock hazard or fault may be caused.</p> <ul style="list-style-type: none"> • Wires should be the proper one meeting the ratings of this instrument. If using a wire which cannot endure the ratings, a fire may occur. • Be sure to use a power supply of correct rating. Connection of power supply of incorrect rating may cause fire.

Each external terminal is provided on the rear panel of the analyzer. (See Fig. 3-3)
Wire each terminal, referring to Fig. 3-3 and (1) to (7).

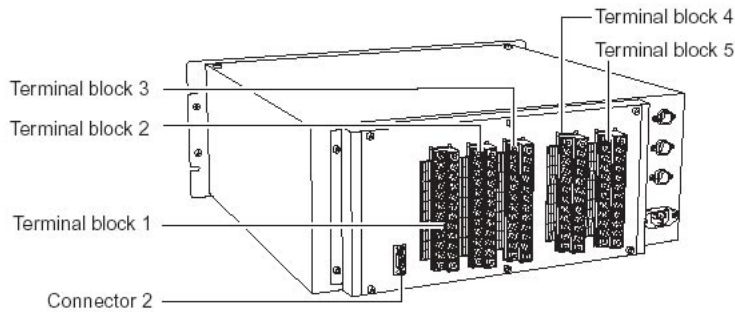

Fig. 3-3 Rear panel

(1) Power inlet

When using supplied power cable, connect the female side to the power inlet at the rear panel of the analyzer, and insert the male side into a receptacle matching the rating.

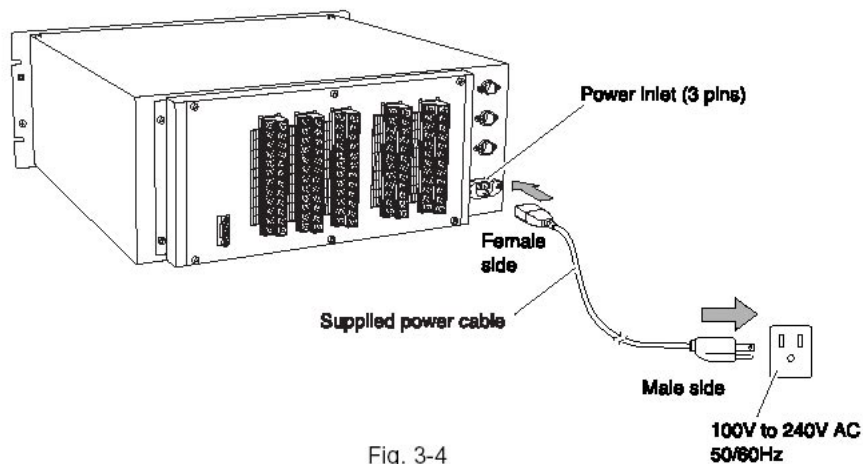
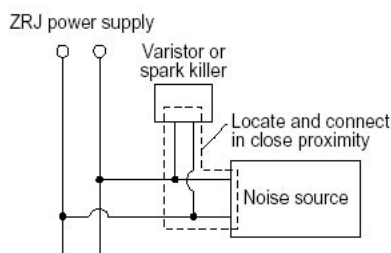

Fig. 3-4

When a noise source is in the vicinity

Do not install the analyzer near power noise generating electric equipment (such as high frequency furnace and electric welder). If the analyzer must be used near such equipment, a separate power line should be used for avoiding noise. In case noise may enter from a relay, solenoid valve, etc. through power supply, connect a varistor (such as ENA211-2 made by Fuji Electric) or spark killer (like S1201 made by OKAYA) to the noise source as shown below. If the varistor or spark killer is located away from the noise source, no effect is obtainable. So, locate near the noise source.



(2) Analog output signal (AO): terminal block 1 (1 to 10, 15 to 20)

Output signal: 4 to 20 mADC or 0 to 1 VDC (selected when ordering)
 Non-insulated output
 Allowable load: 4 to 20 mADC, 550Ω or less
 0 to 1 VDC, 100kΩ or less

- Analog output is provided from each terminal corresponding to the channel displayed in the measurement screen.

Note: All of analog output signals for the instrument are not isolated. It is recommended to isolate signals individually to prevent interference from unnecessary signals or to prevent external interference, especially leading the cable of more than 30 meters or to outdoor.

(3) O₂ sensor input: terminal block 2 (1 – 2)

Input signal:
 External zirconia O₂ analyzer: Zirconia O₂ sensor signal (Teledyne output)
 External O₂ analyzer: 0 to 1 VDC (DC input resistor of 1MΩ or more)

- It is used when the external zirconia O₂ analyzer or external O₂ analyzer is specified as order.
- To connect to the output of the external Zirconia analyzer or external O₂ analyzer prepared separately.
- In case of an external O₂ analyzer, input a signal of 0 to 1 VDC with respect to O₂ full scale of the analyzer.
- In case of built-in O₂ analyzer, do not use the terminals.

Note: O₂ sensor input is not isolated. It is recommended to isolate input signal to prevent interference from unnecessary signals or to prevent external interference. Zirconia O₂ sensor should be installed at a location that is as close to this instrument as possible.

- (4) Contact input (DI): terminal block 2 (13 to 20), terminal block 3 (5 to 10)
- It is for a contact input at no voltage. An input is provided when switching to short circuit (on) or open (off).
 - No voltage is applied to the terminals

- (5) Contact output (DO): terminal block 3 (13 to 20), terminal block 4 and terminal block 5
- Contact rating: 250VAC / 2A, load resistance
 - An output is for a relay contact output. An output is provided when switching to conductive (on) or open (off).

Note: The wires of analog output signals, O₂ sensor input and contact input should be fixed separately from power supply wiring and contact output wiring.

- (6) Communication interface: connector 2
- Please refer to the manual for communication function.

(7) List of terminal blocks 1 to 5

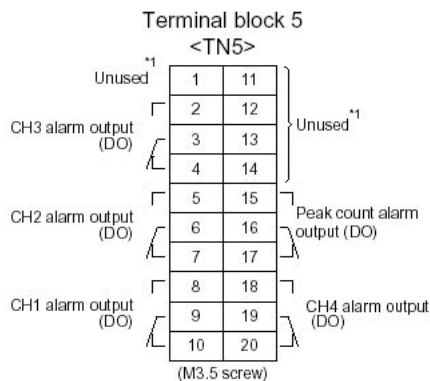
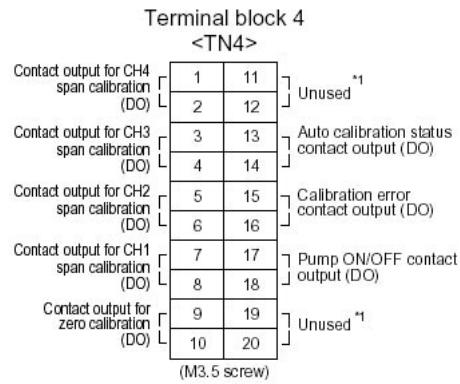
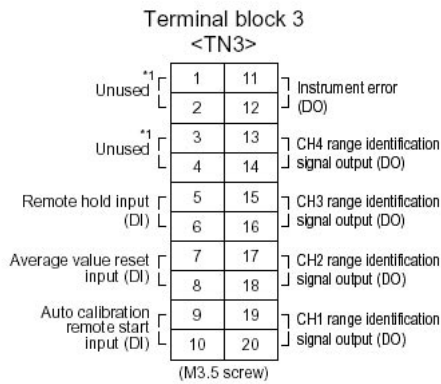
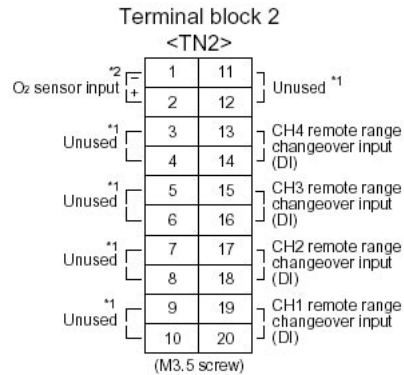
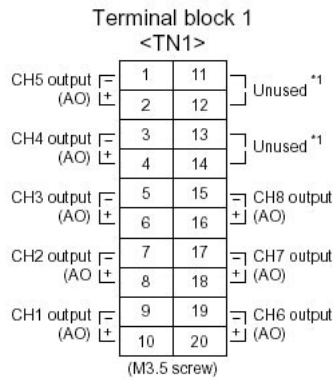

*1) Unused terminals are used for internal connection and should not be used as repeating terminals either.

*2) O₂ sensor input is used when an external O₂ analyzer is selected.

8) Description on terminal block

Terminal block 1 <TN1>

Terminal block for analog output (non-isolated output)
Output : 4 to 20 mA or 0 to 100V DC

- Between 1 – 2: CH5 output
- Between 3 – 4: CH4 output
- Between 5 – 6: CH3 output
- Between 7 – 8: CH2 output
- Between 9 – 10: CH1 output
- Between 11 – 14: For internal connection. Must not be wired. (Must not be used as junction terminal.)
- Between 15 – 16: CH8 output
- Between 17– 18: CH7 output
- Between 19 – 20: CH6 output

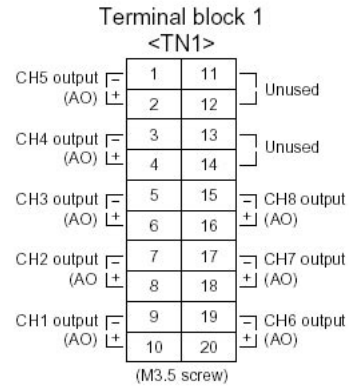

Terminal block 2 <TN2>

- Between 1 – 2: For O2 sensor input. (Input for our Zirconia oxygen sensor or external O2 sensor. Must not be used unless O2 meter is added.)
- Between 3 – 12: For internal connection. Must not be wired. (Must not be used as junction terminal.)
- Between 13 – 14: CH4 remote range changeover input (DI)
- Between 15 – 16: CH3 remote range changeover input (DI)
- Between 17 – 18: CH2 remote range changeover input (DI)
- Between 19 – 20: CH1 remote range changeover input (DI)

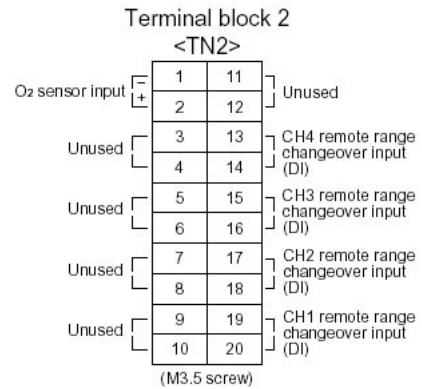

Note: High range is selected when open. Low range is selected when short-circuited. For details of action, refer to “6.7 Parameters Setting, “Remote Range”.

Terminal block 3 <TN3>

Between 1 – 4: For internal connection. Must not be wired. (Must not be used as junction terminal.)

Between 5 – 6: Remote hold input. No hold when open. Output hold when short-circuited.

Between 7 – 8: Average value reset input. Short-circuiting the contact input (for at 1.5 sec or more) resets O2 average and O2 correction average simultaneously. Opening it restarts the average value.

Between 9 – 10: Automatic calibration remote start input. Open input after strapping for at least 1.5 seconds starts the automatic calibration whether automatic calibration setting is ON or OFF.

Between 11 – 12: Conductive when analyzer unit error is produced. Normally open.

Between 13 – 14: CH4 range identification signal

Between 15 – 16: CH3 range identification signal

Between 17– 18: CH2 range identification signal

Between 19– 20: CH1 range identification signal

Note: Range identification signal is conductive at Low range or open at High range. In case of 1-range system, the signal remains open.

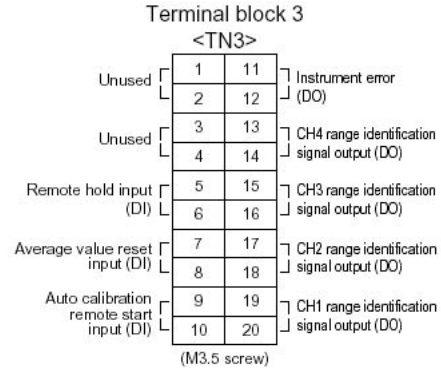

Terminal block 4 <TN4>

Between 1 – 2: CH4 span calibration contact output

Between 3 – 4: CH3 span calibration contact output

Between 5 – 6: CH2 span calibration contact output

Between 7 – 8: CH1 span calibration contact

Between 9 – 10: Zero calibration contact output When the calibration contact output is measured with manual calibration, the calibration contact corresponding to calibration channel is conductive.

For the automatic calibration, they are worked sequentially according to “6.4 Auto calibration setting”. If calibration is not performed, all of them are open.

Between 11 – 12: For internal connection. Must not be wired.
(Must not be used as junction terminal.)

Between 13 – 14: Automatic calibration in progress, contact output.
Conductive during automatic calibration. Open otherwise.

Between 15 – 16: Calibration error contact output. Conductive when error is produced at zero or span calibration. Normally open.

Between 17 – 18: Pump ON/OFF contact output. (Used for turning ON/OFF the pump. Conductive during measurement and open at zero span calibration.)

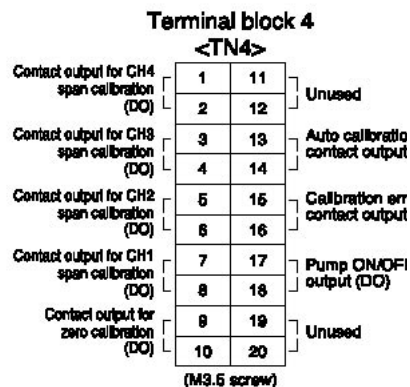

Terminal block 5 <TN5>

1 and 11 – 14: For internal connection. Must not be wired. (Must not be used as junction terminal.)

Between 2 - 3 and 3 - 4: CH3 alarm output. Conductive at 2 – 3 and open at 3 – 4 when set value is exceeded. Open at 2 – 3 and conductive at 3 – 4 otherwise.

Between 5 - 6 and 6 - 7: CH2 alarm output. Conductive at 5 – 6 and open at 6 – 7 when set value is exceeded. Open at 5 – 6 and conductive at 6 – 7 otherwise.

Between 8 - 9 and 9 - 10: CH1 alarm output. Conductive at 8 – 9 and open at 9 – 10 when set value is exceeded. Open at 8 – 9 and conductive at 9 – 10 otherwise.

Between 15 - 16 and 16 - 17: Peak count alarm contact output. Conductive at 15 – 16 and open at 16 – 17 when preset peak count is exceed. Otherwise, open at 15 – 16 and conductive at 16 – 17. For setting and action, refer to instruction manual “6.6 Peak Alarm Setting”.

Between 18 – 19 and 19 – 20: CH4 alarm output. Conductive at 18 – 19 and open at 19 – 20 when set value is exceeded. Open at 18 – 19 and conductive at 19 – 20 otherwise.

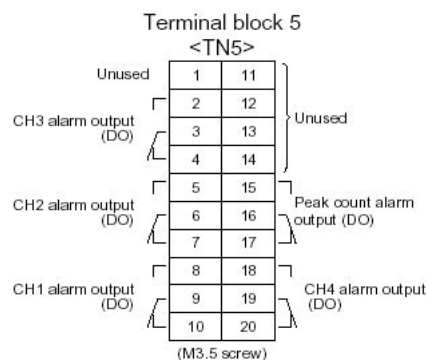

(9) Timing of calibration contact output

1. Manual calibration (See “6.9 Calibration”)

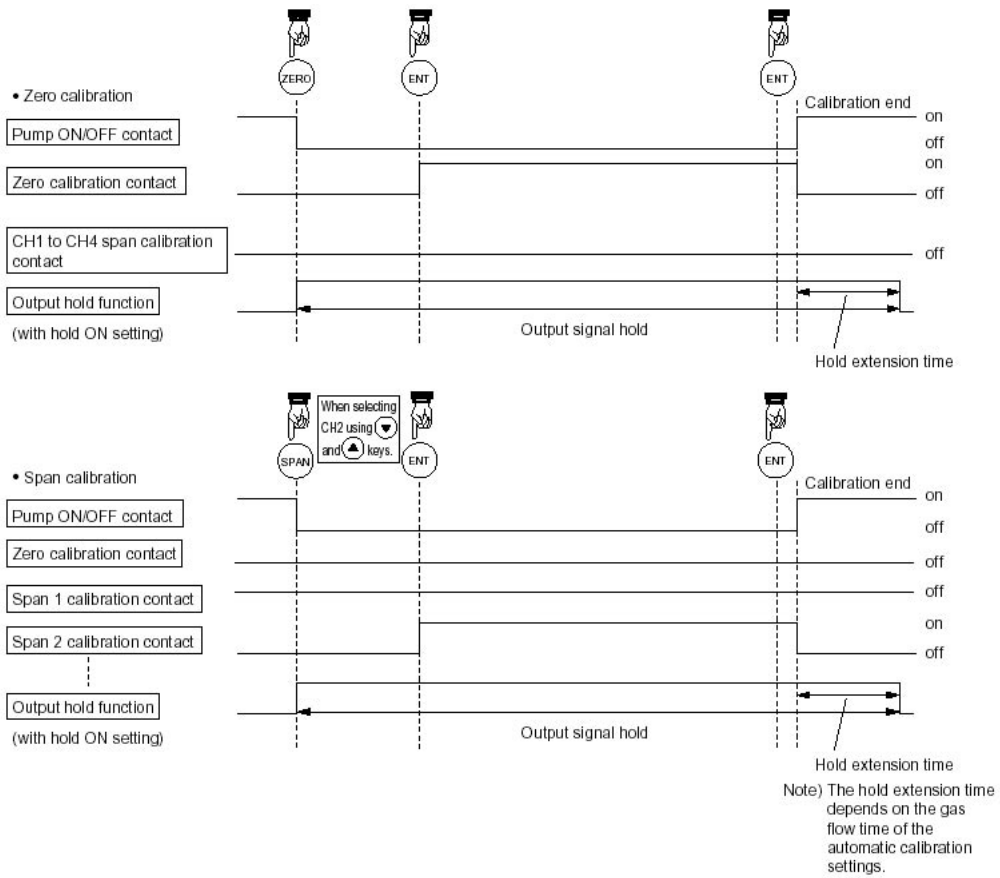

2. In case of automatic calibration (example shown in 6.4.1, Automatic calibration settings)

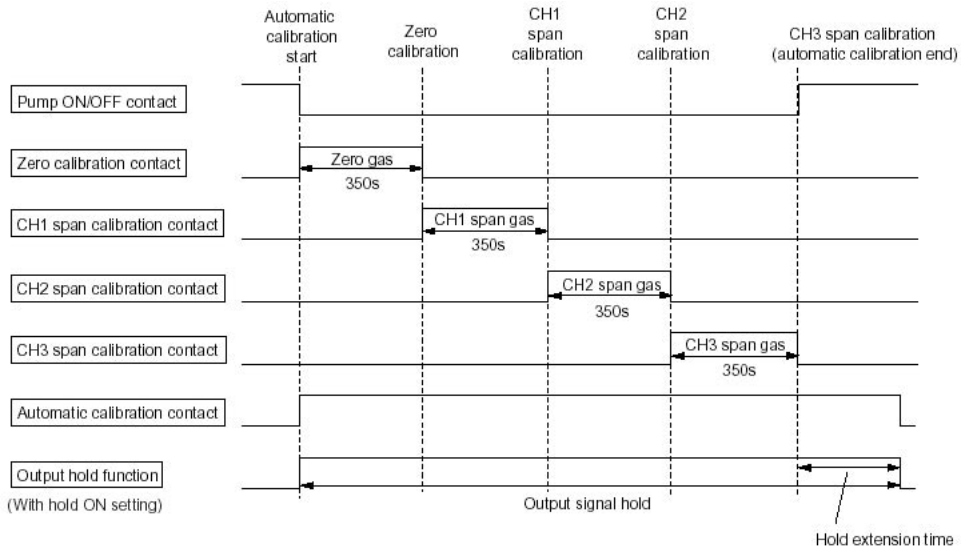

4. OPERATION

4.1 Preparation for operation

- (1) Check of gas sampling tube, exhaust tube and wiring
 - Check that the pipes are correctly connected to the gas sampling port and drain port.
 - Check that the analyzer is correctly wired as specified.

4.2 Warm-up operation and regular operation

- (1) Operation procedure
 1. Turn ON the power switch at the left of the front panel.
 - In one or two seconds, the measurement screen will appear at the front panel.
 2. About 2 hour warm-up operation
 - About 2 hours are needed until the operating performance is stabilized. Warm-up operation should be continued with the power ON.
 3. Setting of various set values
 - Set required set values according to Chapter 6, "Setting and calibration".
 4. Zero and span calibration
 - Perform zero calibration and span calibration after warm-up operation.
 - See Chapter 6.9, "Calibration".
 5. Introduction and measurement of measured gas
 - Start measurement by introducing measured gas into the analyzer.

Note: While in warm-up operation, the concentration reading may be beyond the upper limit of the range (range-over) or below the lower limit. But this is not an error.

5. DISPLAY AND OPERATION PANEL

This section describes the display and operation panel of the gas analyzer. It also explains the name and description of function on the operation panel. See Fig. 5-1.

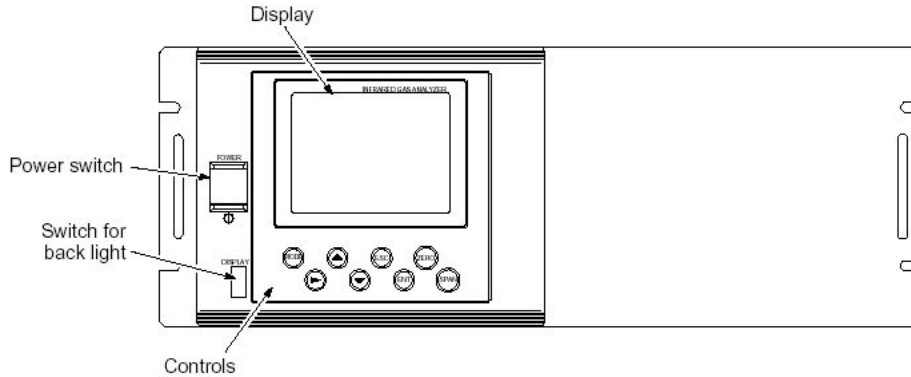

5.1 Name and description of operation panel

- Display: The measurement screen and the setting items are displayed.
- Controls: The configuration is as shown below.

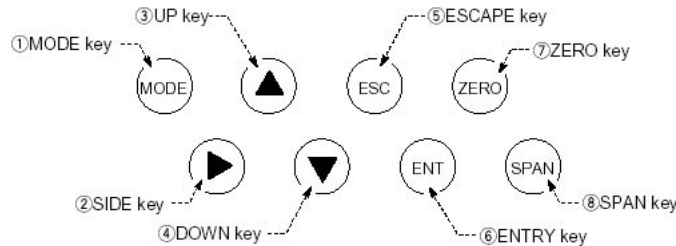

Name	Description	Name	Description
1. MODE key	Used to switch the mode.	5. ESC key	Used to return to a previous screen or cancel the setting midway.
2. SIDE key	Used to change the selected item (by moving the cursor) and numeral digit.	6. ENT key	Used for confirmation of selected items or values, and for execution of calibration.
3. UP key	Used to change the selected item (by moving the cursor) and to increase numeral value.	7. ZERO key	Used for zero calibration.
4. DOWN key	Used to change the selected item (by moving the cursor) and to decrease numeral value.	8. SPAN key	Used for span calibration.

Fig. 5-1 Name and description of operation display and panel

Note: The switch for back light is used for turning ON/OFF the back light of display. The life time of back light is 50,000 hours. Please turn OFF the switch when indicator is not necessary, so the life time will be longer.

5.2 Overview of display and operation panel

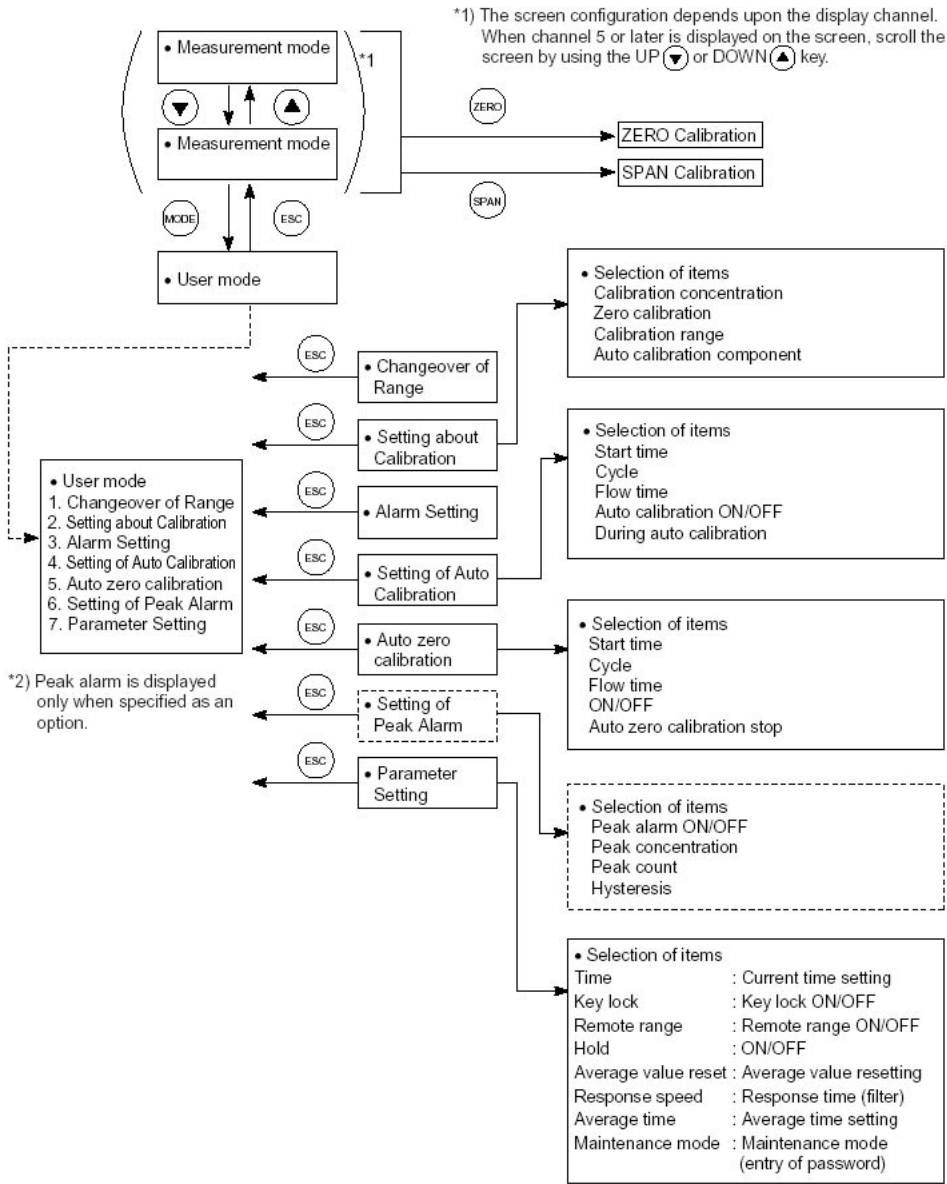

Figure 5.2

5.3 Overview of display screen

(1) Measurement mode screen

On turning on the power switch, the Measurement Mode screen will appear.

The measurement screen depends on the number of components. The following screen configuration shown as an example is for CO₂, CO, O₂ (Output at channel 6).

When channel 5 or later is displayed, scroll up or down key to view another configuration which is beyond the screen.

No.	Name	Function	No.	Name	Description
1	Component display	Displays component of instantaneous value, converted instantaneous value, converted average value, etc.	5	Peak alarm component display	Displays peak alarm component.
2	Concentration display	Displays measured value of concentration.	6	Peak alarm concentration display	Displays peak alarm concentration (Upper limit value).
3	Range display	Displays range values.	7	Peak alarm count	Displays the alarm times exceeding the peak value.
4	Unit display	Displays unit with ppm and vol%.	8	Peak alarm unit display	Displays unit of peak alarm with times/h.

Fig. 5-3 Name and function of measurement mode screen

• Instantaneous value and concentration value:

The concentration display of CH (component) where sampling components such as “CO₂”, “CO” or “O₂” are displayed in the component display, indicates current concentration values of the measured components contained in gas that is now under measurement.

• O₂ correction concentration values:

CH (components) where “cv***” is displayed as “cv CO” in the component display are calculated from the following equation, by setting sampling components, O₂ instantaneous / concentration values and O₂ correction reference value (see item 6.8).

$$\text{Conversion output} = \frac{21 - O_n}{21 - O_s} \times C_s$$

K

On: The value of the O₂ correction reference value (Value set by application)

Os: Oxygen concentration (%)

Cs: Concentration of relevant measured component

K: The value of the fractional part is this equation.

Where, K is When $K \geq 4$, $K=4$. When $K < 0$, $K=4$. When $C_s < 0$, $K=0$.

The correction components are CO and SO₂ only.

• **O2 correction concentration average value:**

CH (component) where “AV / CV” is displayed as “AV / CV CO” in the component display and O2 average value, a value obtained by averaging O2 conversion concentration value or O2 concentration value in a fixed time is output every 30 seconds.

Averaging time can be changed between 1 minute and 59 minutes or 1 hour and 4 hours according to the average time settings (See 6.7 Parameter setting).

(The set time is displayed as “1h”, for instance, in the Range display.)

* The measurement ranges of O2 correction concentration value and O2 correction concentration average value are the same as that of the measuring components. Also, the measurement range of O2 average value is the same as that of O2.

(2) Setting/selection screen

The setting/selection screen is configured as shown below:

- In the status display area, the current status is displayed.
 - In the message display area, messages associated with operation are displayed.
 - In the setting item and selection item display area, items or values to be set are displayed, as required.
- To work on the area, move the cursor to any item by using up, down, and right keys.

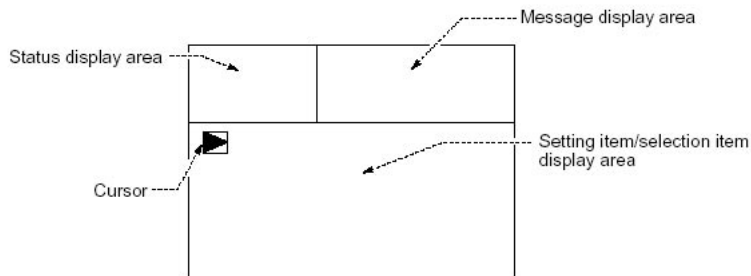

Figure 5-4: Display screen

(3) Contents of measured channel (CH)

The contents in each measured CH corresponding to the type are given below:

Type code			Contents						
5th digit	6th digit	7th digit	CH1	CH2	CH3	CH4	CH5	CH6	CH7
Y	C	Y	O2						
A	Y	Y	SO2						
B	Y	Y	CO						
D	Y	Y	CO2						
E	Y	Y	CH4						
2	Y	Y	CO2	CO					
3	Y	Y	CH4	CO					
4	Y	Y	CO2	CH4					
5	Y	Y	CO2	CO	CH4				
A	A, B, C	Y	SO2	O2					
B	A, B, C	Y, B	CO	O2					
D	A, B, C	Y	CO2	O2					
E	A, B, C	Y	CH4	O2					
2	A, B, C	Y, B	CO2	CO	O2				
3	A, B, C	Y, B	CH4	CO	O2				
4	A, B, C	Y	CO2	CH4	O2				
5	A, B, C	Y	CO2	CO	CH4	O2			
A	A, B, C	A	SO2	O2	Corrected SO2	Corrected SO2 average	O2 average		
B	A, B, C	A, C	CO	O2	Corrected CO	Corrected CO average	O2 average		
2	A, B, C	A, C	CO2	CO	O2	Corrected CO	Corrected CO average	O2 average	
3	A, B, C	A, C	CH4	CO	O2	Corrected CO	Corrected CO average	O2 average	
5	A, B, C	A, C	CO	CO	CH4	O2	Corrected CO	Corrected CO average	O2 average

How to view the Table

When SO2 is displayed in CH1, it means that display and output of CH1 correspond to SO2 component.

5.4 General operation

• Measurement mode

The measurement mode can be displayed for up to 5 channels in a single screen. When viewing a channel beyond the 5 channels, press the (or) key and the screen can be scrolled one by one channel at a time.

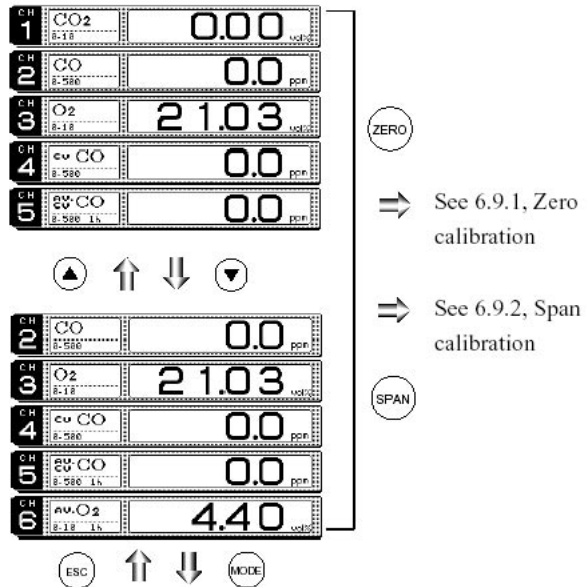

• User mode displays the following settings

- Changeover of range
- Calibration setting
- Alarm setting
- Setting of auto calibration
- Setting of auto zero calibration
- Peak alarm setting
- Parameter setting

User Mode	Select an item with UP/DOWN and ENT Back with ESC
<input checked="" type="checkbox"/> Changeover of Range Setting about Calibration Alarm Setting Setting of Auto Calibration Setting of Auto Zero Calibration Setting of Peak Alarm Parameter Setting	



Measurement Mode

For settings, refer to “6, Setting and Calibration.”

6. SETTING AND CALIBRATION

6.1 Changeover of range

This mode is used to select the ranges of measured components.

1. During measurement, press the MODE key to display the User mode.

2. Point the cursor to “Changeover of Range”. Press the ENT key.

3 The “Channel Selection” screen appears. Press the UP or DOWN key until the cursor moved selects a desired CH (component).

4. After selection, press the ENT key.

Note: The range of O2 correction instantaneous values and O2 correction average values is automatically switched by changing the range of instantaneous value of each CH (component).

5. In the Range Setting screen that appears, move the cursor by pressing the UP or DOWN key to select the range. (The range with a TRIANGLE mark is currently selected.)

6. After selection, press the ENT key.

7. Measurement is conducted within the selected range. The range identification signal (CO) is shorted with the low range (Range 1), and open with the high range (Range 2).

Note: If the Remote Range is set to ON, the changeover of range cannot be performed on the screen.

To close Changeover of range

To close Changeover of range, or cancel the command midway, press the ESC key. A previous screen will return.

↓ (MODE)

User Mode	Select an item with UP/DOWN and ENT Back with ESC
▣ Changeover of Range Setting about Calibration Alarm Setting Setting of Auto Calibration Setting of Auto Zero Calibration Setting of Peak Alarm Parameter Setting	

↓ (ENT)

Range Change	Select CH No. with UP/DOWN and ENT Back with ESC
▣ CH1 CO2	▶ Range1 0-10 vol% Range2 0-20 vol%
CH2 CO	▶ Range1 0-500 ppm Range2 0-2000 ppm
CH3 O2	▶ Range1 0-10 vol% Range2 0-25 vol%

↓ (▼) (▲) (ENT)

Range Change	Select range with UP/DOWN and ENT Back with ESC
CH1 CO2	▶ Range1 0-10 vol% ▶ Range2 0-20 vol%
CH2 CO	▶ Range1 0-500 ppm Range2 0-2000 ppm
CH3 O2	▶ Range1 0-10 vol% Range2 0-25 vol%

↓ (▼) (▲) (ENT)

End of Range Selection

6.2 Calibration setting

This mode is used to set calibration concentration and actions. The calibration setting involves calibration concentration, zero calibration, calibration range and auto-calibration component.

6.2.1 Setting of calibration concentration

It allows you to set concentrations of the standard gas (zero and span) of each channel used for calibration.

1. During measurement, press the MODE key to display the User mode.

2. Point the cursor to “Setting about Calibration” by pressing the UP or DOWN key. Press the ENT key.

3. In the “Setting about Calibration” screen that appears, point the cursor to “Calibration Value” by pressing the UP or DOWN key. Press the ENT key.

4. In the “Calibration Concentration CH Selection” screen that appears, point the cursor to CH you want to set by using the UP or DOWN key. Press the ENT key.



User Mode	Select an item with UP/DOWN and ENT Back with ESC
Changeover of Range <input checked="" type="checkbox"/> Setting about Calibration Alarm Setting Setting of Auto Calibration Setting of Auto Zero Calibration Setting of Peak Alarm Parameter Setting	



Cal. Settings	Select an item with UP/DOWN and ENT Back with ESC
<input checked="" type="checkbox"/> Calibration Value About ZERO Calibration About Calibration Range Auto Calibration Components	

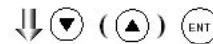

Cal. Settings	Select CH No. for setting calibration value		
Cal. Value			
CH	RANGE	ZERO	SPAN
<input checked="" type="checkbox"/> CH1	0-10vol%	000.00	010.00
CO ₂	0-20vol%	000.00	020.00
CH2	0-500ppm	0000.0	0500.0
CO	0-2000ppm	00000	02000
CH3	0-10vol%	00.00	10.00
O ₂	0-25vol%	00.00	25.00

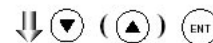

5. In the “Calibration Concentration Selection” screen that appears, select any concentration item you want to set by pressing the UP, DOWN, and RIGHT key.

Note: Analyzers other than the zirconia O2 instrument cannot perform zero setting.

6. In the “Calibration Concentration Value Setting” screen that appears, enter calibration gas concentration values (zero and span). For value entry, press the UP or DOWN key, and a 1-digit value increases or decreases. By pressing the RIGHT key, the digit moves.

After setting, save the entry by pressing the ENT key. The saved value becomes valid from the next calibration process.

Note: Enter the set values corresponding to each range. When the O2 measurement uses atmospheric air for the zero gas, set the concentration value to 21.00. When the cylinder air is used, set to the concentration value as indicated on the cylinder.

To close the setting

To close the calibration concentration value setting process or cancel this mode midway, press the ESC key. A previous screen will return.

Setting range of values

Paramagnetic O2, CO2, CO, SO2 and CH4 measurement:

- Zero gas: Fixed at 0
- Span gas: Minimum digit, 1 to 100% of full scale
(Full scale (FS) is the same as each range value.)

Zirconia O2 measurement :

- Zero gas: 5 to 25 vol%
- Span gas: 0.01 to 5 vol%

The setting cannot be performed beyond the range.

Cal. Settings		Select setting value	
CH	RANGE	ZERO	SPAN
CH1	0-10vol%	000.00	010.00
CO2	0-20vol%	000.00	020.00
CH2	0-500ppm	0000.0	0500.0
CO	0-2000ppm	00000	02000
CH3	0-10vol%	00.00	10.00
O2	0-25vol%	00.00	25.00

Cursor for setting value 

Cal. Settings		Set calibration value	
CH	RANGE	ZERO	SPAN
CH1	0-10vol%	000.00	010.00
CO2	0-20vol%	000.00	020.00
CH2	0-500ppm	0000.0	0500.0
CO	0-2000ppm	00000	02000
CH3	0-10vol%	00.00	10.00
O2	0-25vol%	00.00	25.00



End of Calibration
Concentration Setting

6.2.2 Setting of manual zero calibration

If zero calibration is to be made manually, select whether to calibrate all components at once or each of them separately upon selection.

1. During measurement, press the MODE key to display the User mode.

2. Point the cursor to “Setting about Calibration” by pressing the UP or DOWN key. Press the ENT key.

3. In the “Setting about Calibration” screen that appears, point the cursor to “About ZERO Calibration” by pressing the or key. Press the ENT key.

4. In the “Manual Calibration CH Selection” screen that appears, point the cursor to CH you want to set by using the UP or DOWN key. Press the ENT key.



User Mode	Select an item with UP/DOWN and ENT Back with ESC
Changeover of Range <input checked="" type="checkbox"/> Setting about Calibration Alarm Setting Setting of Auto Calibration Setting of Auto Zero Calibration Setting of Peak Alarm Parameter Setting	

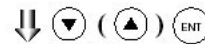

Cal. Settings	Select an item with UP/DOWN and ENT Back with ESC
Calibration Value <input checked="" type="checkbox"/> About ZERO Calibration About Calibration Range Auto Calibration Components	

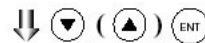

Cal. Settings ZERO Cal.	Select CH No.		
<input checked="" type="checkbox"/> CH1 CO ₂	Range1 0-10 vol % Range2 0-20 vol %	each	
CH2 CO	Range1 0-500 ppm Range2 0-2000ppm	both	
CH3 O ₂	Range1 0-10 vol % Range2 0-25 vol %	each	



5. In the “Manual Calibration Selection” screen that appears, select “At once” or “Each” by pressing the UP or DOWN key. When selecting “Both”, the CH (components) to be set can be zero-calibrated at the same time. When selecting “Each”, either of the CH (components) to be selected is zero-calibrated. After setting, press the ENT key, and the calibration you specified is carried out.

To close “About ZERO Calibration”

To close “About ZERO Calibration” setting or to cancel this mode midway, press the ESC key. A previous screen will return.

EXAMPLE

Whether upon selection or at once can be determined for each CH (component).

Cal. Settings ZERO Cal.		Set each or at once CH at ZERO Calibration	
CH 1 CO ₂	Range1 0-10 vol% Range2 0-20 vol%		at once
CH 2 CO	Range1 0-500 ppm Range2 0-2000ppm		at once
CH 3 O ₂	Range1 0-10 vol% Range2 0-25 vol%		each

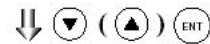

End of Manual Calibration Setting

•Setting upon selection

Select the CH (component) and then perform zero calibration on the manual zero calibration screen.

•Setting at once

At a manual zero calibration, CHs (components) for which “at once” was selected can simultaneously be calibrated.

* When the zirconia O₂ analyzer uses the cylinder air or atmospheric air for the zero gas, select “At once”.

Manual Calibration screen

When “Each” is set for each CH

ZERO Cal.	Select CH No. with UP/DOWN and ENT Back with ESC	
▶CH 1 CO ₂	▶Range1 0-10 vol% Range2 0-20 vol%	20.03
CH 2 CO	▶Range1 0-500 ppm Range2 0-2000ppm	999.9
CH 3 O ₂	▶Range1 0-10 vol% Range2 0-25 vol%	40.95

A single cursor will appear.

When “At once” is set for CH1 and CH2
(CH3 is set “each”)

ZERO Cal.	ENT:Go on calibration of selected CH ESC:Not calibration	
CH 1 CO ₂	▶Range1 0-10 vol% Range2 0-20 vol%	▶ 199.2
CH 2 CO	▶Range1 0-500 ppm Range2 0-2000ppm	▶ 999.9
CH 3 O ₂	▶Range1 0-10 vol% Range2 0-25 vol%	40.95

Cursors will appear on all components where “at once” is set.

6.2.3 Setting of calibration range

This mode is used to set if the range of each CH (component) at the calibration manual calibration or auto calibration) should be calibrated with a single range or 2 ranges.

1. During measurement, press the MODE key to display the User mode.

2. Point the cursor to “Setting about Calibration” by pressing the UP or DOWN key. Press the ENT key.

3. In the “Setting about Calibration” screen that appears, point the cursor to “About Calibration Range” by pressing the UP or DOWN key. Press the ENT key.

4. In the “Calibration Range CH Selection” screen that appears, point the cursor to the CH you want to set by pressing the UP or DOWN key. Press the ENT key.



User Mode	Select an item with UP/DOWN and ENT Back with ESC
Changeover of Range <input checked="" type="checkbox"/> Setting about Calibration Alarm Setting Setting of Auto Calibration Setting of Auto Zero Calibration Setting of Peak Alarm Parameter Setting	

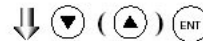

Cal. Settings	Select an item with UP/DOWN and ENT Back with ESC
Calibration Value About ZERO Calibration <input checked="" type="checkbox"/> About Calibration Range Auto Calibration Components	

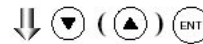

Cal. Settings Cal. Range	Select CH No.		
<input checked="" type="checkbox"/> CH1 CO2	Range1 0-10 vol%	Range2 0-20 vol%	current
CH2 CO	Range1 0-500 ppm	Range2 0-2000ppm	current
CH3 O2	Range1 0-10 vol%	Range2 0-25 vol%	current

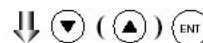

5. In the “Calibration Selection” screen that appears, select “Both” or “Current” by pressing the UP or DOWN key.

- When selecting “both”, Range 1 and Range 2 of the set CH are calibrated together.

- When selecting “Current”, the range alone displayed at the set CH is calibrated.

Cal. Settings Cal. Range		Set calibration range current or both range	
CH1 CO2	Range1 0-10 vol% Range2 0-20 vol%	both	
CH2 CO	Range1 0-500 ppm Range2 0-2000ppm	current	
CH3 O2	Range1 0-10 vol% Range2 0-25 vol%	current	

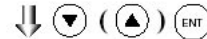

End of Manual Calibration Setting

To close “Setting of Calibration Range”

To close “Setting of Calibration Range” or to cancel this mode midway, press the ESC key. A previous screen will return.

EXAMPLE:

CH1 CO2	Range 1: 0 to 10 vol% Range 2: 0 to 20 vol%	both
CH2 CO	Range 1: 0 to 500 ppm Range 2: 0 to 2000 ppm	current

CH1: Range 1 and Range 2 are calibrated together, with zero or span calibration.
 CH2: Only currently displayed range is calibrated, with zero or span calibration.

Manual Calibration screen

In case of “both” setting

ZERO Cal.	ENT:Go on calibration of selected CH ESC:Not calibration		
CH1 CO2	▶Range1 0-10 vol% Range2 0-20 vol%	◀	19.92
CH2 CO	▶Range1 0-500 ppm Range2 0-2000ppm	◀	999.9
CH3 O2	▶Range1 0-10 vol% Range2 0-25 vol%		40.95

Two cursors will appear in both ranges.

Note: When calibration is performed by the “Both” setting under the normal operating condition, prepare a span gas cylinder on the normal operating range side. It is recommend to perform span gas calibration in the normal operating range. The other range that is calibrated by “Both” may result in some error (max. of ±5% of FS).

6.2.4 Setting of auto-calibration component

It sets the CH (component) to be calibrated in the auto-calibration.

1. During measurement, press the MODE key to display the User mode.

2. Point the cursor to “Setting about Calibration” by pressing the UP or DOWN key. Press the ENT key.

3. In the “Setting about Calibration” screen that appears, point the cursor to “Auto Calibration Components” by pressing the UP or DOWN key. Press the ENT key.

4. In the “Auto Calibration Components” selection screen that appears, point the cursor to the CH you want to set by pressing the UP or DOWN key. Press the ENT key.

⇓ (MODE)

User Mode	Select an item with UP/DOWN and ENT Back with ESC
Changeover of Range <input checked="" type="checkbox"/> Setting about Calibration Alarm Setting Setting of Auto Calibration Setting of Auto Zero Calibration Setting of Peak Alarm Parameter Setting	

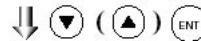

Cal. Settings	Select an item with UP/DOWN and ENT Back with ESC
Calibration Value About ZERO Calibration About Calibration Range <input checked="" type="checkbox"/> Auto Calibration Components	

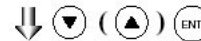

Cal. Settings	Select CH No.		
Auto Cal.			
<input checked="" type="checkbox"/> CH1 CO ₂	Range1 0-10 vol%	Range2 0-20 vol%	enable
CH2 CO	Range1 0-500 ppm	Range2 0-2000ppm	enable
CH3 O ₂	Range1 0-10 vol%	Range2 0-25 vol%	enable



5. In the “Auto Calibration Selection” screen that appears, select “enable” or “disable” by pressing the UP or DOWN key. After setting, press the ENT key.

To close Auto Calibration Component setting

To close “Setting of Auto Calibration Component” or to cancel this mode midway, press the ESC key. A previous screen will return.

Cal. Settings Auto Cal.		Set enable or disable for auto calibration	
CH1 CO2	Range1 0-10 vol% Range2 0-20 vol%	enable	
CH2 CO	Range1 0-500 ppm Range2 0-2000ppm	enable	
CH3 O2	Range1 0-10 vol% Range2 0-25 vol%	disable	



End of Manual Calibration Setting

Example

Auto calibration is made in the following rules according to the setting.

1. Zero calibration at once of CHs (components) which were set to “enable”.
2. The span of CHs (components) which were set to “enable” is calibrated in the ascending order of CH number.

Example 1. In case all of CH1: CO2, CH2: CO, CH3: O2, were set to “enable”.
Zero calibration (at once) of CH1 to CH3 → span calibration of CH1 (CO2) → span calibration of CH2 (CO) → span calibration of CH3 (O2)

Example 2. In case, out of CH1: CO2, CH2: CO and CH3: O2, CH1 (CO2) was set to “enable”, CH2 (CO) was set to “enable” an CH3 (O2) was set to “disable”.
Zero calibration (at once) of CH1 and 2 → span calibration of CH1 (CO2) → span calibration of CH2 (CO)

CAUTION

The components which were set to “enable” is calibrated to zero at once at the time of auto calibration regardless of setting in “6.2.2 Setting of manual zero calibration”.

6.3 Alarm setting

6.3.1 Setting of alarm values

This mode is used to set the upper and lower limit value to provide an alarm output during measurement. Before changing the alarm setting, set the ON/OFF to OFF.

1. During measurement, press the MODE key to display the User mode.

2. Point the cursor to "Alarm Setting" by pressing the UP or DOWN key. Press the ENT key.

3. After the alarm setting CH selection screen has appeared, operate the UP or DOWN key until the cursor is aligned with a desired CH and press the ENT key.

4. After the alarm item selection screen has appeared, operate the or key until the cursor is aligned with a desired item and press the ENT key.

CAUTION

Set the values so that upper limit value > lower limit value and that (upper limit value - lower limit value) > hysteresis error.

The alarm is activated in each range independently from the settings of each range.

↓ (MODE)

User Mode	Select an item with UP/DOWN and ENT Back with ESC
Changeover of Range Setting about Calibration <input checked="" type="checkbox"/> Alarm Setting Setting of Auto Calibration Setting of Auto Zero Calibration Setting of Peak Alarm Parameter Setting	

↓ (▼) (▲) (ENT)

Alarm Setting	Select CH No. or Hysteresis setting
<input checked="" type="checkbox"/> CH1 CO ₂ <input type="checkbox"/> CH2 CO <input type="checkbox"/> CH3 O ₂	
Hysteresis 00 %FS	

↓ (ENT)

Alarm Setting CH1 CO ₂	Select an item with UP/DOWN and ENT Back with ESC
<input checked="" type="checkbox"/> Upper Range 1 10.00 vol% Range 2 10.00 vol% Lower Range 1 00.00 vol% Range 2 00.00 vol% Kind of Alarm Upper ON/OFF 0 F F	

↓ (▼) (▲) (ENT)

After setting, the alarm setting is now completed by pressing the ENT key.

To close the “Alarm Setting”

To close the “ Alarm Setting” or to cancel this mode midway, press the ESC key. A previous screen will return.

Setting range

0 to 100% FS (Settable in each range).

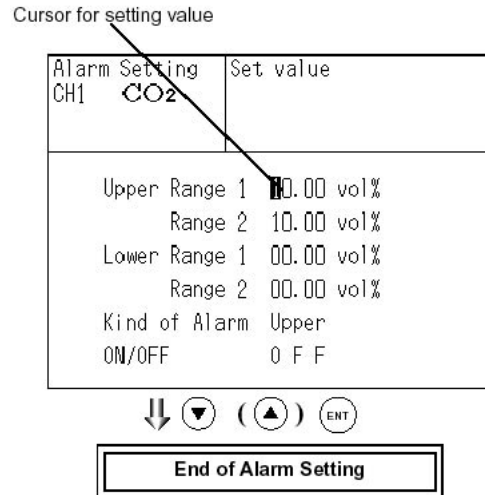

Description of setting items

- Upper limit value: Sets the upper limit value (concentration) of alarm.
- Lower limit value: Sets the lower limit value (concentration) of alarm.
- Contact action: Selects one of upper limit alarm, lower limit alarm, and upper limit or lower limit alarm.
 - Upper limit alarm ... Alarm contact operates when above upper limit value.
 - Lower limit alarm ... Alarm contact operates when below lower limit value.
 - Upper limit alarm or lower limit alarm ...Alarm contact operates when above upper limit value or below lower limit value.

ON/OFF: Enables the alarm function if set at ON, or disables the alarm function if set at OFF.

* The upper limit value cannot be set below the lower limit value, and the lower limit value cannot be set above the upper limit value.

If it is desired to set the upper limit value below the lower limit value already stored in the memory, reduce the lower limit value beforehand, or vice versa.

Typical on-screen display when an alarm occurs

When an upper limit alarm has occurred, the “High alarm” message lights at CH (component) (“Low alarm” at lower limit alarm).

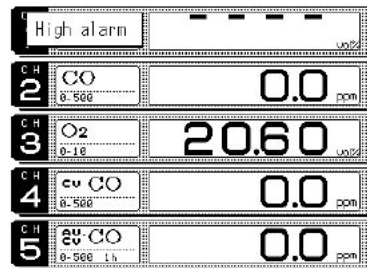

CAUTION

For 10 minutes after turning on power, the alarm judgment is inactive.

6.3.2 Hysteresis setting

To prevent chattering of an alarm output near the alarm setting values, set hysteresis.

1. In the “Alarm Setting CH Selection” screen that appears, point the cursor to “Hysteresis” by pressing the UP or DOWN key. Press the ENT key.

2. In the “Hysteresis Value Setting” screen that appears, enter hysteresis values. For the value entry, 1-digit value is increased or decreased by pressing the UP or DOWN key, and pressing the RIGHT key moves the digit. After setting, press the ENT key to carry out hysteresis.

To close Hysteresis Setting

To close the “Hysteresis Setting” or cancel the mode midway, press the ESC key. A previous screen will return.

Setting range

0 to 20% of full scale

A full scale means each range provides a full scale of width.

Caution

The hysteresis is common to all CHs (components).

Hysteresis

If hysteresis values exceed the upper limit value as shown in graph, an alarm output is provided. Once the alarm output is turned ON, it remains ON until the value falls below the set lower limit of the hysteresis indication.

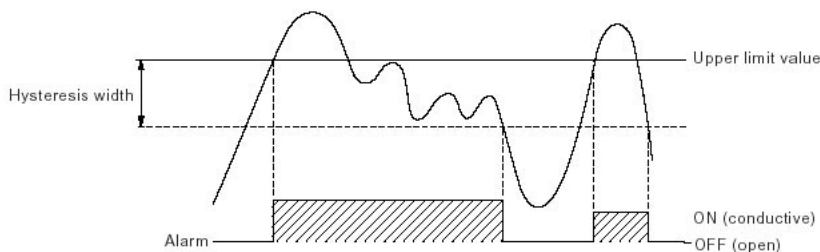

Alarm Setting	Select CH No. or Hysteresis setting
CH 1	CO ₂
CH 2	CO
CH 3	O ₂
<input checked="" type="checkbox"/> Hysteresis 00 %FS	

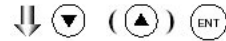

Alarm Setting	Set Hysteresis 0 to 20%FS available
CH 1	CO ₂
CH 2	CO
CH 3	O ₂
Hysteresis 00 %FS	

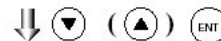

End of Hysteresis Setting

6.4 Setting of auto calibration

6.4.1 Auto calibration

Auto calibration is automatically carried out when zero calibration and span calibration are set.

Before changing the setting of auto calibration, set the ON/OFF to OFF.

1. During measurement, press the MODE key to display the User mode.

2. Point the cursor to “Setting of Auto Calibration” by pressing the or key. Press the ENT key.

3. In the “Setting of Auto Calibration” screen that appears, point the cursor to any item you want by pressing the UP or DOWN key. Press the ENT key.

4. In the “Auto Calibration Parameter Setting” screen that appears, perform the value entry or the setting. For the value entry or setting change, use the UP or DOWN key. For the value entry and setting, use the UP or DOWN key. To change the setting, use the RIGHT key to move the cursor to the right.

After setting, press the ENT key, and auto calibration is carried out by the entered setting value.

Description of setting items

- Start Time: Setting at the first calibration (day of the week, hour, minute)
- Cycle: A period between the start time of one calibration and another (unit : hour/day)
- Flow Time: The time required for the calibration gas to be replaced in the cell
- ON/OFF: Auto zero calibration ON or OFF

To close Setting of Auto calibration

To close the “Setting of Auto calibration” or cancel this mode midway, press the ESC key. A previous screen will return.

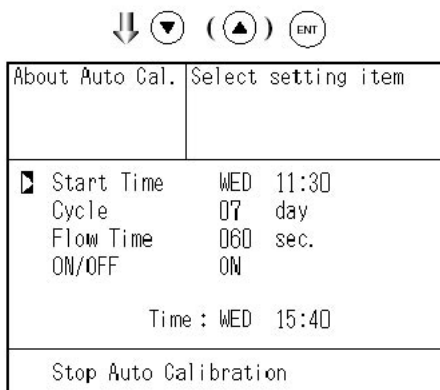
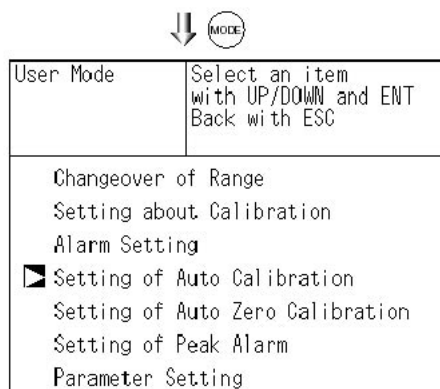

End of Auto Calibration Setting

Auto calibration status contact output is closed during auto calibration, and is open in other cases.

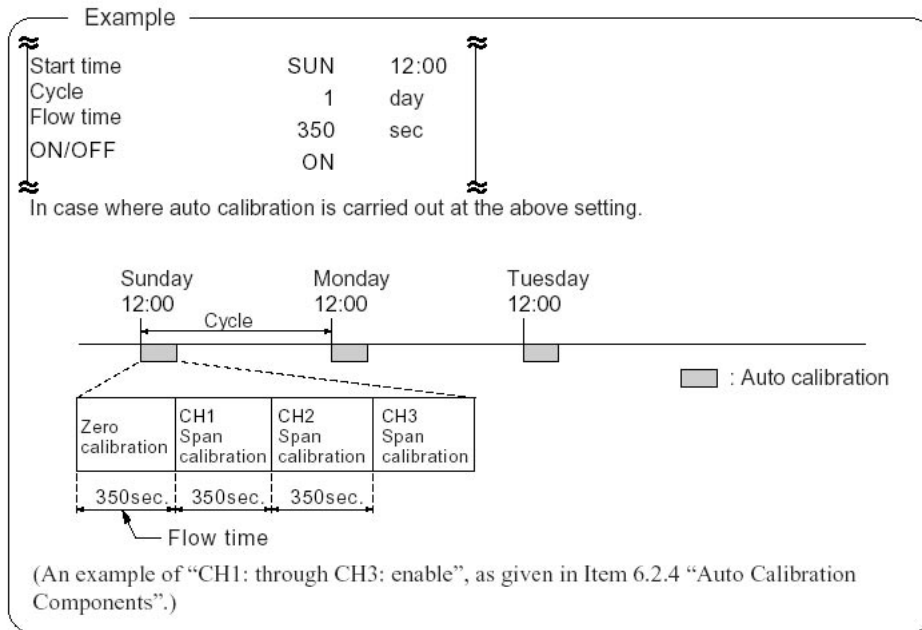

Setting range

Cycle: 1 to 99 hours or 1 to 40 days (initial value 7 days)
 Flow time: 60 to 599 sec (initial value 300sec)

CAUTION

When an auto calibration starts, the measurement screen automatically appears.

Any operation other than forced stop of auto calibration (see Item 6.4.2) is not permitted during auto calibration. “Auto Calibration Cancel” cannot be performed with the key lock to ON. To cancel auto calibration forcedly, set the key lock to OFF and then execute “Auto Calibration Cancel”.

Remote start

Whether the auto calibration is set at ON or OFF, an auto calibration is available by keeping the remote start input short-circuited for at least 1.5 seconds.

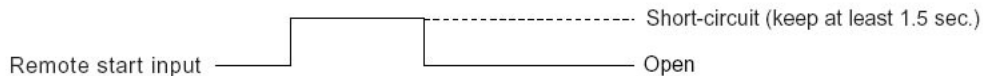

6.4.2 Forced stop of auto calibration

This mode is used to cancel the auto calibration forcedly.

1. In the Menu mode that is displayed, point the cursor to “Setting of Auto Calibration” by pressing the UP or DOWN key. Press the ENT key.

User Mode	Select an item with UP/DOWN and ENT Back with ESC
Changeover of Range Setting about Calibration Alarm Setting <input checked="" type="checkbox"/> Setting of Auto Calibration Setting of Auto Zero Calibration Setting of Peak Alarm Parameter Setting	



2. In the “Setting of Auto Calibration” item selection screen that appears, point the cursor to “Setting of Auto Calibration” by pressing the UP or DOWN key. Press the ENT key.

About Auto Cal.	Select setting item
Start Time WED 16:07 Cycle 07 day Flow Time 060 sec. ON/OFF ON Time : WED 16:19	
<input checked="" type="checkbox"/> Stop Auto Calibration	



3. “Stop Auto Calibration” is inverted. A message appears, prompting you to verify that you want to cancel or continue auto calibration. To cancel the auto calibration, press the ENT key. If you press the ESC key, auto calibration is not stopped.

About Auto Cal.	Stop auto calibration? Stop with ENT Not with ESC
Start Time WED 11:30 Cycle 07 day Flow Time 060 sec. ON/OFF ON Time : WED 15:41	
<input checked="" type="checkbox"/> Stop Auto Calibration	

“Auto Calibration” screen

Example

In case where setting the auto calibration components (see Item 6.2.4) to “CH1: enable” and “CH2: enable”.

• Zero calibration

A message, “Zero calibration” blinks at CH1 and CH2.

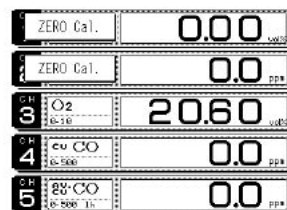

• CH1 span calibration

A message, “Span calibration” blinks at CH1.

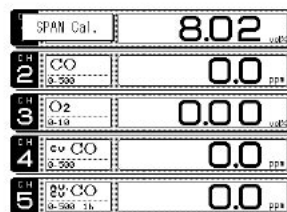

• CH2 span calibration

A message, “Span calibration” blinks at CH2.

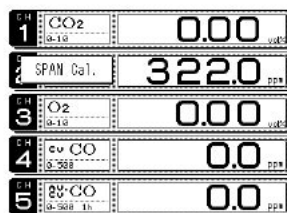

CAUTION

During auto calibration, any key operation is not permitted other than operations such as key lock ON/OFF and “Stop Auto Calibration”. When the key lock is set at ON, even the “Stop Auto Calibration” cannot be used. To stop “Auto Calibration” forcedly, set the key lock to OFF and then execute “Stop Auto Calibration”.

6.5 Setting of auto zero calibration

6.5.1 Auto zero calibration

Auto zero calibration is automatically carried out when zero calibration are set.

Components for which a calibration is to be made are determined by setting of auto calibration component in 6.2.4.

Before changing the setting of auto zero calibration, set the ON/OFF to OFF.

1. During measurement, press the MODE key to display the User mode.

2. Point the cursor to “Setting of Auto Zero Calibration” by pressing the UP or DOWN key. Press the ENT key.

3. In the “Setting of Auto Zero Calibration” screen that appears, point the cursor to any item you want by pressing the UP or DOWN key. Press the ENT key.

4. In the “Auto Zero Calibration Parameter Setting” screen that appears, perform the value entry or the setting. For the value entry or setting change, use the UP or DOWN key. To change the setting, use the RIGHT key to move the cursor to the right.

After setting, press the ENT key, and auto zero calibration is carried out by the entered setting value.

Description of setting items

- Start Time: Setting at the first calibration (day of the week, hour, minute)
- Cycle: A period between the start time of one calibration and another (unit : hour/day)
- Flow Time: The time required for the calibration gas to be replaced in the cell
- ON/OFF: Auto zero calibration ON or OFF

To close “Auto Zero Calibration”

To close the “ Auto Zero Calibration “ or cancel this mode midway, press the ESC key. A previous screen will return.

The sequence of screens is as follows:

- User Mode**: Select an item with UP/DOWN and ENT. Back with ESC.
 - Changeover of Range
 - Setting about Calibration
 - Alarm Setting
 - Setting of Auto Calibration
 - Setting of Auto Zero Calibration
 - Setting of Peak Alarm
 - Parameter Setting
- About Auto Zero Cal.**: Select setting item.
 - Start Time SUN 12:00
 - Cycle 07 day
 - Flow Time 300 sec.
 - ON/OFF OFF
 - Time : WED 15:42
 - Stop Auto Zero Calibration
- About Auto Zero Cal.**: Set Start Time.
 - Start Time SUN 12:00
 - Cycle 07 day
 - Flow Time 300 sec.
 - ON/OFF OFF
 - Time : WED 15:42
 - Stop Auto Zero Calibration
- End of Auto Zero Calibration Setting**

Auto calibration status contact output is closed during auto zero calibration, and is open in other cases.

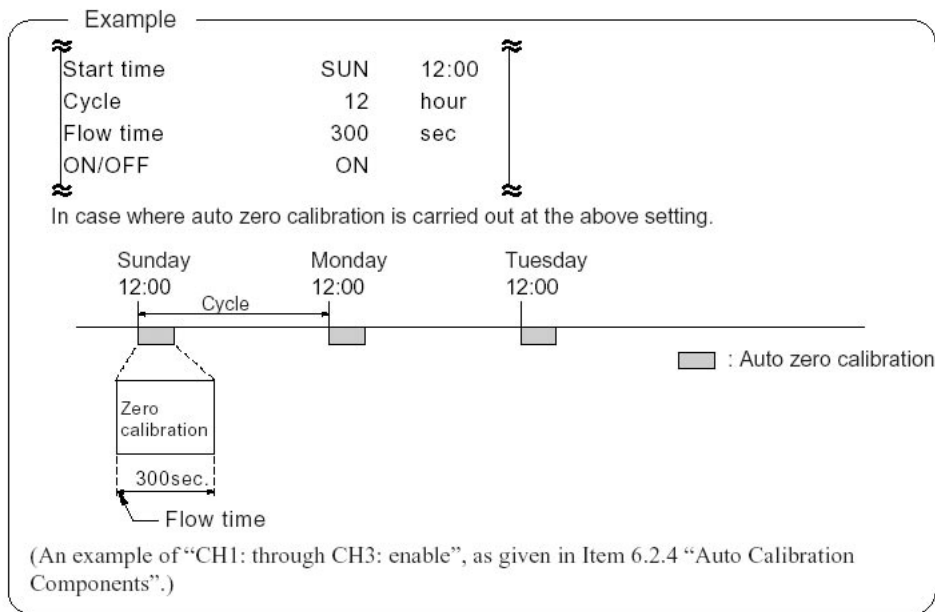

Setting range

Cycle: 1 to 99 hours or 1 to 40 days (initial value 7 days)
 Flow time: 60 to 599 sec (initial value 300 sec)

Caution

- When an auto zero calibration starts, the measurement screen automatically appears.
- Any operation other than forced stop of auto zero calibration (see Item 6.5.2) is not permitted during auto zero calibration. “Auto Zero Calibration Cancel” cannot be performed with the key lock to ON. To cancel auto zero calibration forcedly, set the key lock to OFF and then execute “Auto Zero Calibration Cancel”.
- If the auto calibration period and auto zero calibration period have overlapped, the auto calibration is retained, ignoring the auto zero calibration of that period.

6.5.2 Forced stop of auto zero calibration

This mode is used to cancel the auto zero calibration forcedly.

1. In the Menu mode that is displayed, point the cursor to “Setting of Auto Zero Calibration” by pressing the UP or DOWN key. Press the ENT key.

User Mode	Select an item with UP/DOWN and ENT Back with ESC
Changeover of Range Setting about Calibration Alarm Setting Setting of Auto Calibration <input checked="" type="checkbox"/> Setting of Auto Zero Calibration Setting of Peak Alarm Parameter Setting	

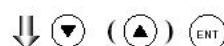

2. In the “Setting of Auto Zero Calibration” item selection screen that appears, point the cursor to “Setting of Auto Zero Calibration” by pressing the UP or DOWN key. Press the key.

About Auto Zero Cal.	Select setting item
Start Time SUN 12:00 Cycle 07 day Flow Time 300 sec. ON/OFF OFF Time : WED 16:19	
<input checked="" type="checkbox"/> Stop Auto Zero Calibration	

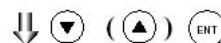

3. “Stop Auto Zero Calibration” is inverted. A message appears, prompting you to verify that you want to cancel or continue auto zero calibration. To cancel the auto zero calibration, press the ENT key. If you press the ESC key, auto zero calibration is not stopped.

About Auto Zero Cal.	Stop auto Zero calibration? Stop with ENT Not with ESC
Start Time SUN 12:00 Cycle 07 day Flow Time 300 sec. ON/OFF OFF Time : WED 16:20	
<input checked="" type="checkbox"/> Stop Auto Zero Calibration	

“Auto Zero Calibration” screen

Example

In case where setting the auto calibration components (see Item 6.2.4) to “CH1: enable” and “CH2: enable”.

- Zero calibration
 - A message, “Zero calibration” blinks at CH1 and CH2.

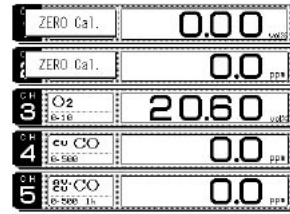

CAUTION

During auto zero calibration, any key operation is not permitted other than operations such as key lock ON/OFF and “Stop Auto Zero Calibration”.

When the key lock is set at ON, even the “Stop Auto Zero Calibration” cannot be used. To stop “Auto Zero Calibration” forcedly, set the key lock to OFF and then execute “Stop Auto Zero Calibration”.

6.6 Peak alarm setting

When the number of peaks of which CO concentration exceeds the upper limit value exceeds the setting time, a peak alarm is outputted.

This section describes how to perform various settings of peak alarm.

Note: The setting is optional and is valid only when peak alarm function is provided.

1. Press the MODE key in the Measurement mode, and the User mode appears.
2. Point the cursor to "Setting of Peak Alarm" by pressing the \downarrow or \uparrow key. Press the ENT key.
3. In the "Peak Alarm Setting" item selection screen that appears, point the cursor to any item you want by pressing the UP or DOWN key. Press the ENT key.
4. Then, enter numeric values and perform the setting.

Entering or setting the numeric values should be carried out by using the UP or DOWN key.

After setting, press the ENT key, and the set values you entered are saved.

Description of setting items

- Peak Alarm: Setting of peak alarm is performed with ON/OFF.
- Alarm value: If peak concentrations exceed the set alarm value, a peak counter counts 1 time.
- Alarm Count: When a peak in excess of the setting time occurs, a peak count alarm output is provided.
- Hysteresis: To prevent possible chattering when the peak value may exceed the set peak concentration by only 1 time, the peak count has an allowance in the hysteresis width.

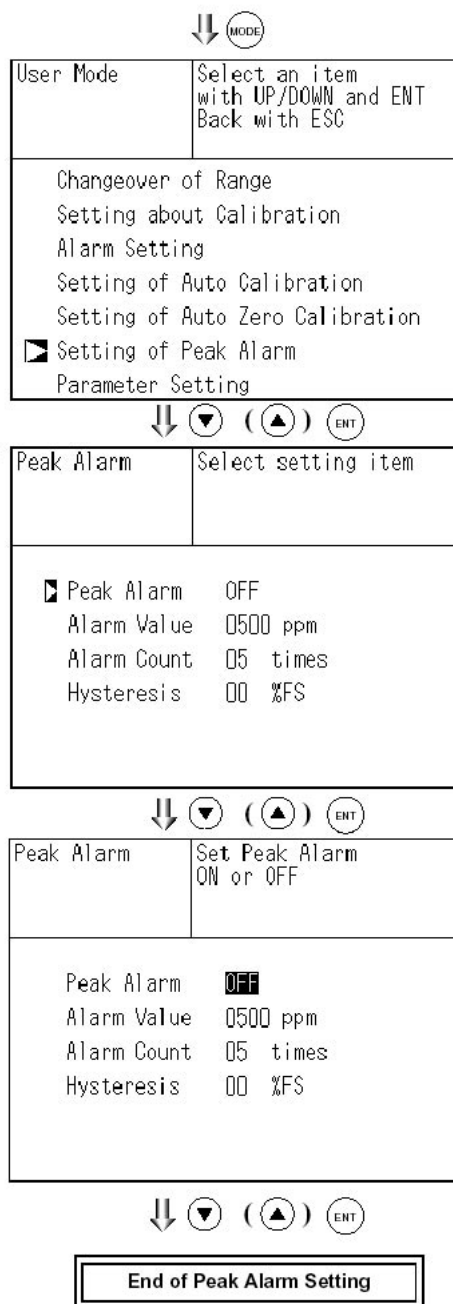

Setting range

- Alarm Value: 0 to 1000 ppm 5 ppm step (initial value: 500 ppm)
- Alarm Count: 1 to 99 times (initial value: 5 times)
- Hysteresis: 0 to 20% of full scale (initial value: 0% of full scale)
* The hysteresis setting is made in terms of full scale.

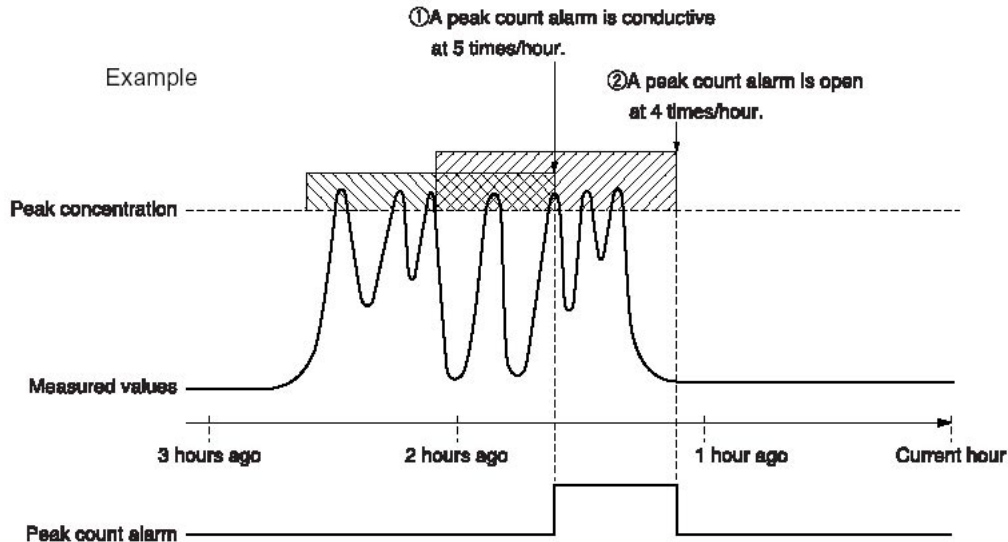

Action of peak alarm

If CO concentration exceeds the alarm value, counting will begin. If the number of peaks is over the set times per hour, a peak count alarm becomes closed (ON). If it is less than the set times per hour, it is open (OFF). Since 5 times of peaks /hour is marked at 1 section from the above graph, the peak count alarm is turned ON. Since peaks of more than 5 times per 1 hour occur at the interval between 1 and 2 , the peak count alarm remains ON. Since peaks are reduced to 4 times per hour, it is turned OFF.

Like the hysteresis of the alarm setting , the hysteresis prevents possible chattering when measured gas is fluctuated near the alarm value.

* For 10 minutes after the power is turned ON, a peak alarm counting is not carried out.

Releasing peak alarm

To release the peak alarm, set the peak alarm to OFF.
Turning on the peak alarm initiates counting from 0.

6.7 Parameter setting

It allows you to carry out the parameter setting such as time, key lock, etc., as required. Items to be set are as follows:

Description of setting items

- Current Time: Sets the current day of the week, hour and time.
- Key Lock: Sets with ON/OFF so that any key operation except the key lock OFF cannot be performed.
- Remote Range: Sets with ON/OFF whether the Range Selection is made valid or invalid by external input.
- Output Hold: Sets whether Calibration Output is held or not.
- Average Value Reset: Resets the average value.
- Response Speed: Sets the response time of electrical system.
- Average Time: Sets the moving average time.
- Maintenance mode: Enters passwords to switch to the Maintenance mode.

* For the maintenance mode, see Item 6.8.

1. To display the User mode, press the MODE key in the measurement mode.

2. Point the cursor to "Parameter Setting" by pressing the or key. Press the ENT key.

3. In the "Parameter Setting" screen that appears, point the cursor to any item you want by pressing the or key. Press the ENT key.

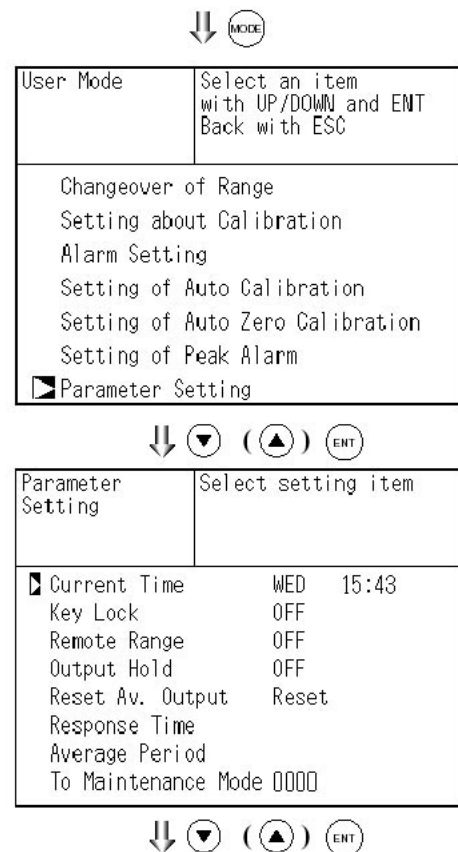

4. In the Parameter Setting screen that appears, enter the numeric values and set the items. Entering the numeric values or setting the items should be carried out by using the or key. To move the cursor to the right, press the key.

After setting, press the ENT key, that the parameter setting is carried out with the value you set.

To close Parameter Setting screen

To close the “Parameter Setting” screen or cancel this mode midway, press the ESC key. A previous screen will return.

Parameter Setting	Select setting item
Current Time	WED 15:43
Key Lock	OFF
Remote Range	OFF
Output Hold	OFF
Reset Av. Output	Reset
Response Time	
Average Period	
To Maintenance Mode	0000



End of Parameter Setting

Setting Range

- Response time: 1 to 60 sec. (Initial value: 3 sec)
- Average time: 1 to 59 min or 1 to 4 hours (Initial value: 1 hour)

When setting the unit of 1 to 59 minutes in terms of minute or 1 to 4 hours with hour

- Maintenance mode: 0000 to 9999 (Initial value: 0000)

Remote Range

A range can be switched via an external input by setting the Remote Range to ON. (The switching action affects all of instantaneous value, O2 correction value, O2 correction average value and O2 average value.) If the Remote Range is set to OFF, the external input becomes invalid.

Opening the input gives the High range, or short-circuiting the input gives the Low range. For the terminal input, refer to 3.4, Wiring.

Switching the range cannot be performed by on-screen operation when the REMOTE RANGE is set to ON.

Note: In case of 1 range system, this function is overridden.

Output Hold

By setting an output hold to ON, an output signal of each channel are held during the calibration (manual calibration and auto calibration) and for the gas flow time (refer to 6.4, Setting of Auto Calibration). Regardless of Hold ON/OFF setting, an output signal can be held via an external input.

(1) Manual calibration

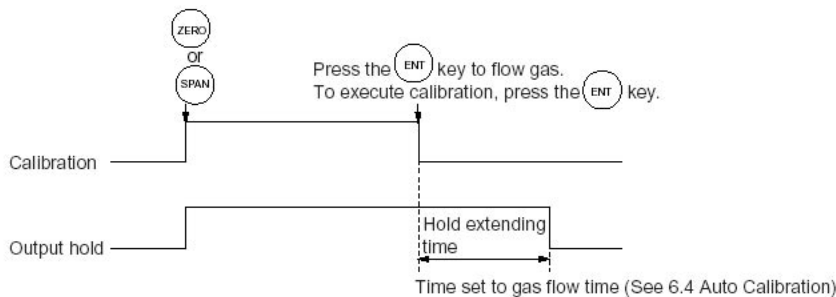

(2) Auto calibration

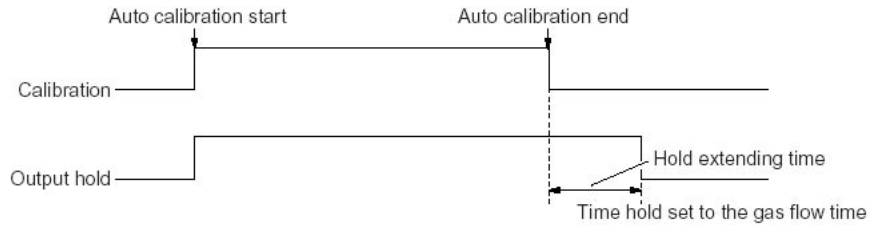

(3) External hold

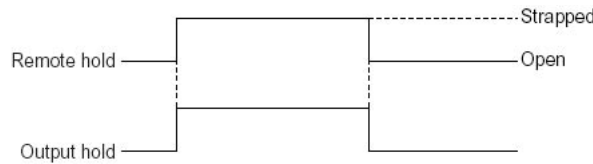

(4) Screen display during holding

The “Holding” message blinks on the measuring screen.

Since the screen displays the process of calibration is displayed during the manual calibration, “Holding” is not displayed even if the screen is held, but the screen is displayed with the hold extending time.

(5) If calibration is cancelled after the calibration gas is supplied regardless of during manual calibration or auto calibration, an output hold of the holding extending time will be performed.

Average value reset

This mode is used to clear O2 correction average value and O2 average value, and restarts averaging. All average values are reset at a time. The indication value and output value is 0 ppm, vol% or so at the time of the reset input.

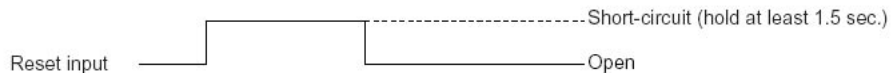

So long as short-circuited, resetting lasts. At the edge of changing from short circuit to opening, the average action restarts.

Response time

The response time of the electrical system can be changed. Setting is available by components.

Note: It does not provide exact seconds for the setting time, but it gives a guide of the setting time. The setting value can be modified as requested by the customer.

Parameter Setting	Response Time	Select CH No.
<input checked="" type="checkbox"/> CH1	CO ₂	03 sec.
CH2	CO	03 sec.
CH3	O ₂	03 sec.

Average period

It allows you to set an average period of the average value of O2 correction.

It enables you to set an average time of 1 to 59 minutes (1-minute step) or 1 to 4 hours (1-hour step).

Changing the setting resets the average value of O2 correction and O2 average value. (Pressing the ENT validates the resetting only for components whose setting was changed.)

Parameter Setting	Average Period	Set period of average output
CH5	AV.CO	01 hour
CH6	AV.O2	50 min

Example of average action

Suppose the average period is 1 hour.

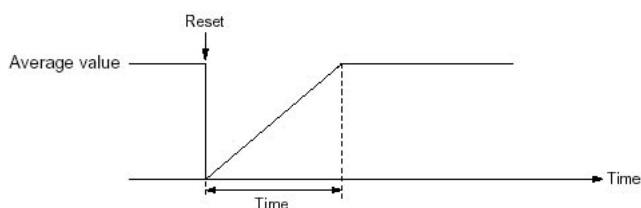

- Sampling occurs every 30 seconds
- Every 30 seconds, the average for last 1 hour (time setting) is output.
- At the instant of resetting, zero is assumed for all past values. It means the average value will not be correct for 1 hour after resetting.

Maintenance mode

To open the maintenance mode, enter a password. After entering the password, press the ENT key.

The password can be used for the Password Setting in the Maintenance mode. A password is set to "0000" before factory-shipment. This value is available for the Maintenance mode.

6.8 Maintenance mode

This mode is used for check of sensor input values, display of error log files or setting of passwords. First, enter a password and then use it from the next operation. This mode is displayed by selecting the Maintenance Mode from “6.7 Parameter Setting”

1. Select the Maintenance mode from the Parameter Setting screen to display the Password Setting screen.

2. Enter the password, and the Maintenance Mode item selection screen will be displayed. Point the cursor to the item you want by pressing the or key and press the ENT key.

3. Next, each Maintenance screen is displayed.

Note: “To Factory Mode” is used for our service engineers only. Refrain from using this mode.

• Sensor Input Value screen

Description of Sensor Input Value screen

- CO2: CO2 sensor input value
- CO: CO sensor input value
- O2: O2 sensor input value
- Temperature : Temperature sensor input value

• Error Log screen

Description of Error Log screen

Error history

For error number, date and time (days, period) of occurrence, channel and other details of error, refer to “8.1 Error message”.

Maintenance Mode	Select operating item
<input checked="" type="checkbox"/> 1. Sensor Input Value 2. Error Log 3. O2 ref. Value 12%O2 4. Password Setting 5. Station No.01 6. To Factory Mode	



Each “Maintenance” screen

Maintenance Sensor Input					
	sensor	input		sensor	input
	CO2	20291			
	CO	20433			
	O2	42471			
	TEMP	17906			

Maintenance Error Log	ENT:Clear Error Log ESC:Back
Error No. 1	WED 14:38
Error No. 10	WED 13:59
Error No. 1	WED 13:59
Error No. 10	WED 13:58
Error No. 1	WED 13:58
Error No. 10	WED 13:52
Error No. 1	WED 13:52
▼ Next page	Page. 1
<input checked="" type="checkbox"/> Clear Error Log	

• O2 correction reference value setting screen

Description of O₂ correction reference value setting screen

O₂ correction value is calculated from the following equation by values set herein:

O₂ correction concentration value

$$= \frac{21 - \text{set value}}{21 - \text{O}_2 \text{ concentration measured value}} \times \text{component concentration measured value}$$

The value of the fractional part in this calculation is limited to 4.
If it is 4 or more, it is fixed at 4.

Maintenance Mode	Set O ₂ ref. Value
<ol style="list-style-type: none"> Sensor Input Value Error Log O₂ ref. Value 12%O₂ Password Setting Station No. 01 To Factory Mode 	

Setting range

- O₂ correction reference value : 00 to 19% in 1% step (Initial value: 12%)

• Password Setting screen

Description of Password Setting screen

It enables you to set a password to be used when switching the parameter setting mode to the maintenance mode.

Note: The password set herein must be managed for safety. Failure to enter the correct password will not open the Maintenance mode.

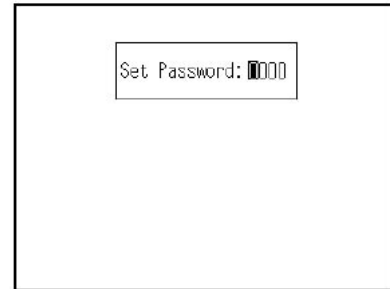

• Station No. setting screen (option)

Setting range

- Station No.: 00 to 31 (Initial No.: 00)

* Please refer to another manual (INZ-TN513327-E) about the communication function.

Maintenance Mode	Set Station No. Allowable 00-31
<ol style="list-style-type: none"> Sensor Input Value Error Log O₂ ref. Value 12%O₂ Password Setting Station No. 01 To Factory Mode 	

6.9 Calibration

6.9.1 Zero calibration

It is used for zero point adjustment. For zero calibration gas, see 3.3 (3), Preparation for standard gas in Sampling. Use a gas according to application.

1. Press the ZERO key on the Measurement screen to display the Manual Zero Calibration screen.

2. Select the CH (component) to be calibrated by pressing the UP or DOWN key. After selection, press the ENT key, and zero gas will be supplied.

CAUTION

For the CH (components) that is set to “at once” in the “Zero Calibration” of the Calibration Setting mode, zero calibration is also carried out at the same time.

3. Wait until the indication is stabilized with the zero gas supplied. After the indication has been stabilized, press the ENT key. Zero calibration in Range selected by the cursor is carried out.

To close Zero Calibration

To close the “Zero Calibration “ or cancel this mode midway, press the ESC key. A previous screen will return.

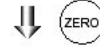

ZERO Cal.	Select CH No. with UP/DOWN and ENT Back with ESC	
CH 1 CO ₂	▶Range1 0-10 vol% Range2 0-20 vol%	10.01
CH 2 CO	▶Range1 0-500 ppm Range2 0-2000ppm	9.9
▶CH 3 O ₂	▶Range1 0-10 vol% Range2 0-25 vol%	10.95



ZERO Cal.	Select CH No. with UP/DOWN and ENT Back with ESC	
▶CH 1 CO ₂	▶Range1 0-10 vol% Range2 0-20 vol%	10.06
▶CH 2 CO	▶Range1 0-500 ppm Range2 0-2000ppm	9.9
CH 3 O ₂	▶Range1 0-10 vol% Range2 0-25 vol%	10.95



ZERO Cal.	ENT:Go on calibration of selected CH ESC:Not calibration	
CH 1 CO ₂	▶Range1 0-10 vol% Range2 0-20 vol%	00.01
CH 2 CO	▶Range1 0-500 ppm Range2 0-2000ppm	000.9
CH 3 O ₂	▶Range1 0-10 vol% Range2 0-25 vol%	20.95



To Measurement screen after
executing Manual Zero Calibration

6.9.2 Span calibration

It is used to perform a span point adjustment. Supply calibration gas with concentration set to the span value to perform the span calibration. For the span calibration gas for the SO₂, CO₂, CO, H₄ measurement, use the standard gas with a concentration of 90% or more of the range value. For the calibration gas for the O₂ measurement, use the standard gas of about 2 vol%.

1. Press the SPAN key on the Measurement screen to display the Manual Span Calibration screen.

2. Press the UP or DOWN key to select CH (component) to be calibrated. After selection, press the ENT key, and the span calibration contact output on corresponding to CH is turned ON. And supply span gas.

CAUTION

When Range Interlock from “Calibration Range” of the Calibration Setting mode is set, span calibration is performed together with 2 Ranges.

3. Wait until the indication is stabilized in the state where the calibration gas is supplied. After the indication has been stabilized, press the ENT key. Span calibration of Range selected by the cursor is performed.

To close Span Calibration

To close the “Span Calibration” or cancel this mode midway, press the ESC key. A previous screen will return.



SPAN Cal.		Select CH No. with UP/DOWN and ENT Back with ESC
CH1 CO ₂	▶Range1 0-10 vol% Range2 0-20 vol%	10.06
CH2 CO	▶Range1 0-500 ppm Range2 0-2000ppm	9.9
CH3 O ₂	▶Range1 0-10 vol% Range2 0-25 vol%	10.95



SPAN Cal.		Select CH No. with UP/DOWN and ENT Back with ESC
CH1 CO ₂	▶Range1 0-10 vol% Range2 0-20 vol%	10.06
CH2 CO	▶Range1 0-500 ppm Range2 0-2000ppm	9.9
CH3 O ₂	▶Range1 0-10 vol% Range2 0-25 vol%	10.95



SPAN Cal.		ENT:Go on calibration of selected CH ESC:Not calibration
CH1 CO ₂	▶Range1 0-10 vol% Range2 0-20 vol%	0.02
CH2 CO	▶Range1 0-500 ppm Range2 0-2000ppm	459.0
CH3 O ₂	▶Range1 0-10 vol% Range2 0-25 vol%	0.00



To Measurement screen after
executing Manual Span Calibration

7. MAINTENANCE

7.1 Daily check

(1) Zero calibration and span calibration

1. It is used for zero point adjustment. For calibration, refer to 6.9.1, Zero calibration.
2. After zero calibration, perform span calibration. For calibration, refer to 6.9.2, Span calibration.
3. Zero calibration and span calibration should be performed once a week, if required.

(2) Flow check

1. Sampling gas flow rate and purge gas flow rate should be as follows;
 Sampling gas flow rate: 1.0 L / min \pm 0.5 L / min (stable)
 Purge gas flow rate: About 1L / min
2. Maintenance and check should be carried out every day, if required.

7.2 Daily check and maintenance procedures

Table 7-1 Maintenance and check list

	Parts to be checked	Phenomena	Cause	Remedy
Every day	Recorder indication	Lower indication	1. Dust is mixed in the sample cell	1. Clean sampling cell and check for sampling device, especially gas filter
			2. Air is sucked in anywhere in the sampling tube	2. Check for leak of the sampling line and repair if required
	Check for purge gas flow if purging the sampling gas flow instrument	Standard flow rate is 1L / min. It is not within the range of the specified flow rate of 0.5 to 1.5 L / min.		Adjust the flow rate with flow rater needle valve
	Replacement of Monitor filter (membrane filter)	Much clogged	Primary filter is damaged	1. Replace primary filter 2. Replace filter (paper)
Every week	Zero point of gas analyzer	Out of zero point		Zero calibration
	Span point of gas analyzer	Out of the standard point		Span calibration
	Replacement of monitor filter (membrane filter)	Irrespective of phenomena		Replace filter (paper)
Every year	Gas analyzer	Irrespective of phenomena		Overhaul

7.3 Cleaning of measuring cell

Entry of dust or water drops in the measuring cell contaminates the interior of the cell, thus resulting in a drift. Clean the inside if dirty. Then, check the sampling device, especially the filter, to prevent the cell from being contaminated by dust or mist.

7.3.1 Disassembly and assembly of measuring cell

There are two kinds of measuring cells, on block cells (cell length: 4 mm, 8 mm, 16 mm, 32 mm) and pipe cells (Cell length: 6.4 mm, 125 mm and 250 mm). 2-component analyzer may incorporate both measuring cells in optical unit. In such a case, detach the pipe cell and then block cell (See Fig. 7-1).

(1) How to remove pipe cell (See Fig. 7-1)

1. Stop measured gas. If it is harmful, purge in the measuring cell thoroughly with zero gas.
2. Turn OFF the power switch.
3. Detach the top cover.
4. Remove the pipe connected to the measuring cell.
5. Slide the infrared ray light source unit (No. 5) toward the front panel by loosening the screw (No. 1) fastened to the base plate to provide clearance between the pipe cell (No. 12) and light source unit.
6. Loosen and remove a screw (No. 7) from the cell retainer (No. 11) fastening the pipe cell.
7. Remove the cell from the measuring unit and unscrew the infrared transmission window (No. 14) at the both ends in the right direction.

Note: The reflection plate in the cell is not closely attached to the cell.

8. For assembly, reverse the disassembly procedure. Provide 0.5 mm clearance between the infrared ray light source unit and cell, and the cell and detector, respectively.

Number	Name
1	Screw (for fixing light source unit)
2	Screw (for fixing detector)
3	Screw (for fixing base plate)
4	Base plate
5	Light source unit
6	Screw (for fixing support)
7	Screw (for fixing cell retainer)
8	Chopper motor connector
(9)	Filter
10	Support
11	Cell retainer
12	Pipe cell
13	O-ring
14	Infrared transmission window
15	Detector
16	Bridge PCB
17	Bridge resistance
(18)	Detector: Installed in 2-component analyzer only

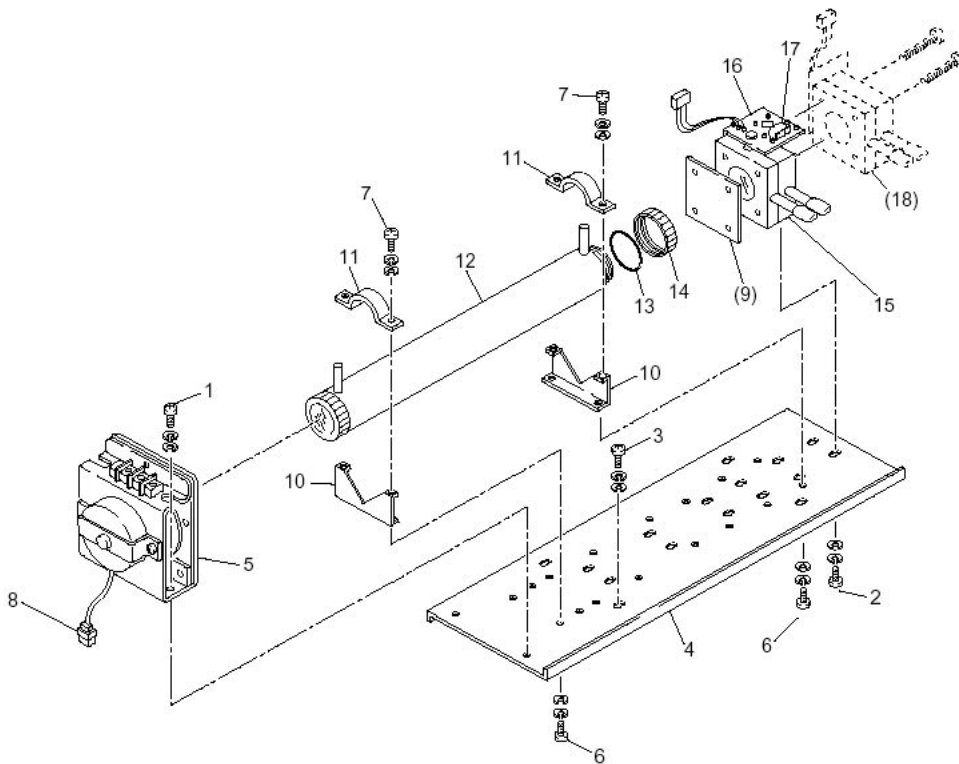

Fig. 7-1 Configuration of measuring unit (pipe cell)

(2) How to remove block cell (See Fig. 7-2)

1. For Step 1 to 4, see Item 7.3.1, (1) How to remove pipe cell.
5. Remove the connector to the detector output cord from the printed board. For the 2-component analyzer, remove the output cord connector of the 2-component analyzer detector (No. 13) from the printed board, and then remove the 2-component detector by unscrewing two mounting screws (No. 14) fastening the 2-component detector.
6. Unscrew the two screws (No. 10) that hold the detector to the infrared ray light source unit to remove the detector from the measuring unit. The cell can be removed together with the detector.
7. To remove the cell, unscrew the two screws (No. 6) holding the cell to the detector. The infrared transmission window is just sandwiched (not fixed) between the detector and block cell. Keep the detector facing up, when removing this window.
8. For assembly, reverse the disassembly procedures.

Note: The O-ring is placed between the window holder and cell. Take care about the O-ring position. With 2-component analyzer, install 2-component detector last. Take care so that no space is left between the 1-component and 2-component detectors. When inserting the detector output cord connector into the printed board, plug the connectors for 1-component detector and 2-component detector into position. The 1-component connector should be plugged into CN11 and 2-component connector into CN1, respectively.

Number	Name
1	Screw (for fixing light source unit)
(2)	Filter
3	Screw (for fixing detector)
4	Base plate
5	Light source unit
6	Screw (for fixing block cell)
7	Block cell
8	Infrared transmission window (window holder)
9	O-Ring
10	Screw (for fixing base plate)
11	Chopper motors connector
12	Detector
(13)	Detector: Install in the 2-component analyzer
(14)	Screws (for mounting the 2-component detector)

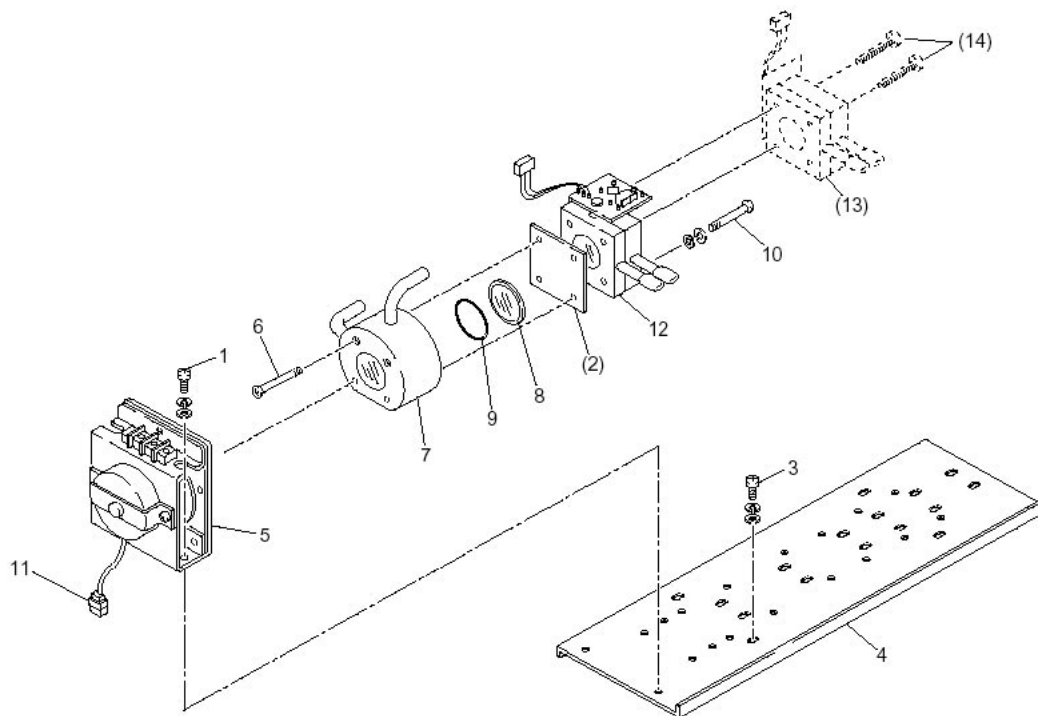

Fig. 7-2 Configuration of measuring unit (block cell)

3) How to remove measuring unit (See Fig. 7-3)

1. For Step 1 to 4, see Item 7.3.1(1), How to remove pipe cell.
2. Remove the detector output cord connector from the printed board.
3. Remove wiring to the 2-pin terminals of the infrared ray light source assembly and chopper motor pin connector (No. 8) from the printed board.
4. Detach the 4 screws (No. 3) fastening the base plate (No. 4) to remove the measuring unit.

Note: Special care should be taken when assembling or disassembling the measuring cell to avoid the application of force to the detector pipe or infrared ray light source unit pipe. If the pipe is deformed or damaged by excessive force, there is a danger of gas leak, thus resulting in misoperation.

Number	Name
1	Screw (for fixing light source)
2	Screw (for fixing detector)
3	Base plate
4	Light source unit
5	Screw (for fixing block cell)
6	Block cell
7	Infrared transmission window
8	O-ring
9	Detector
10	Screw (for fixing base plate)
11	Support
12	Screw (for fixing cell retainer)
13	Cell retainer
14	Pipe cell
15	O-ring
16	Infrared transmission window
17	Screw (fixing detector)
18	Detector

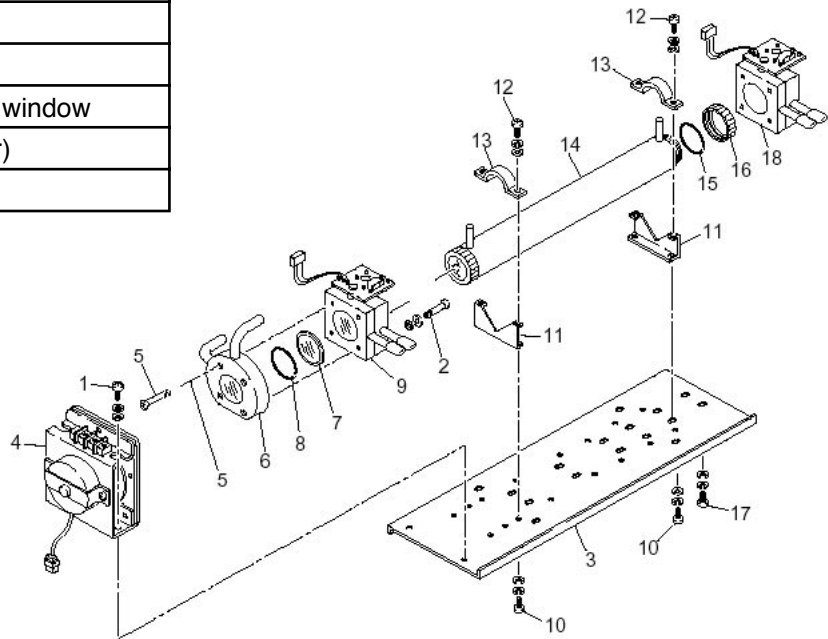

Fig. 7-3 Configuration of measuring unit (2-component analyzer: block cell + pipe cell)

7.3.2 How to clean cell

1. To clean the cell inside or infrared ray transmission window, first clear large dirt of it with a soft brush and then wipe with soft cloth lightly.
Don't use hard cloth.

Note: Handle the fragile window with care. Use care not to rub off the dirt from the window roughly.

2. If the window or the cell interior is very dirty, use a soft cloth moistened with absolute alcohol.
3. If the window is corroded, rub off the scale from the window lightly with a soft cloth to which chrome oxide powder is applied. If it is excessively corroded, it should be replaced with new one.
4. When cell or window cleaning is completed, assemble according to the cell disassembly and assembly procedures. Especially, the pipe should be closely connected without gas leak, and repair if the pipe is bent.

8. TROUBLESHOOTING

8.1 Error message

If errors occur, the following contents are displayed.

Error display	Error contents	Probable causes
Error No. 1	Sector motor rotation detector signal is faulty.	<ul style="list-style-type: none"> • Infrared ray light source is faulty. • Sector motor rotation is faulty or stopped. • Motor rotation detector circuit is faulty. • Amplifier circuit is faulty.
Error No. 3	A/D conversion signal is faulty.	<ul style="list-style-type: none"> • Circuit is faulty.
Error No. 4	Zero calibration is not within the allowable range.	<ul style="list-style-type: none"> • Zero gas is not supplied. • Zero point is deflected much due to a dirty cell. • Detector is faulty.
Error No. 5	A amount of zero calibration (indication value) is over 50% of full scale.	
Error No. 6	Span calibration is not within the allowable range.	<ul style="list-style-type: none"> • Span gas is not supplied. • Calibrated concentration setting does not match cylinder concentration. • Zero calibration is not performed properly. • Span is deflected much due to dirty cell. • Detector sensitivity is deteriorated.
Error No. 7	A amount of span calibration (difference between indication value and calibrated concentration value) is over 50% of full scale.	
Error No. 8	Measured values fluctuate to much during zero and span calibration.	<ul style="list-style-type: none"> • Calibration gas is not supplied. • Time for supplying calibration gas is not short.
Error No. 9	Calibration is abnormal during auto calibration.	<ul style="list-style-type: none"> • Error corresponding to No. 4 to No. 8 occurred during auto calibration.
Error No. 10	Output cable connection is improper.	<ul style="list-style-type: none"> • Wiring is detached between analyzer and interface module. • Wiring is disconnected between analyzer and interface module.

Note: When errors No. 1, No. 3 and No. 10 occur, instrument error output contacts are conductive.
When errors No. 4 to No. 9 occur, calibration error output contacts are conductive.

Screen display and operation at the occurrence of error.
In case of Error No. 1 to No. 4, No. 6, No. 8 to No. 10

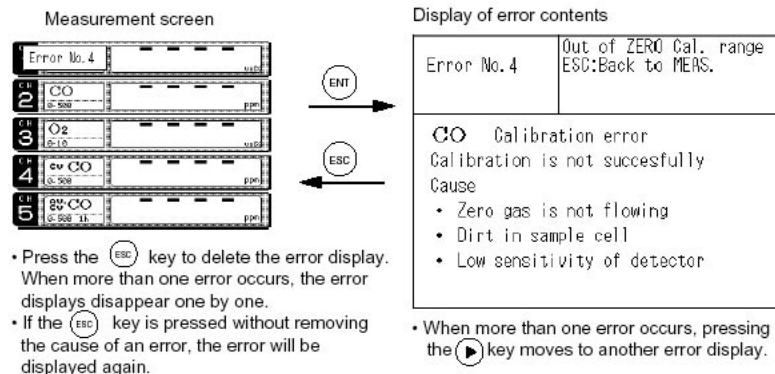

In case of Error No. 5 and No. 7

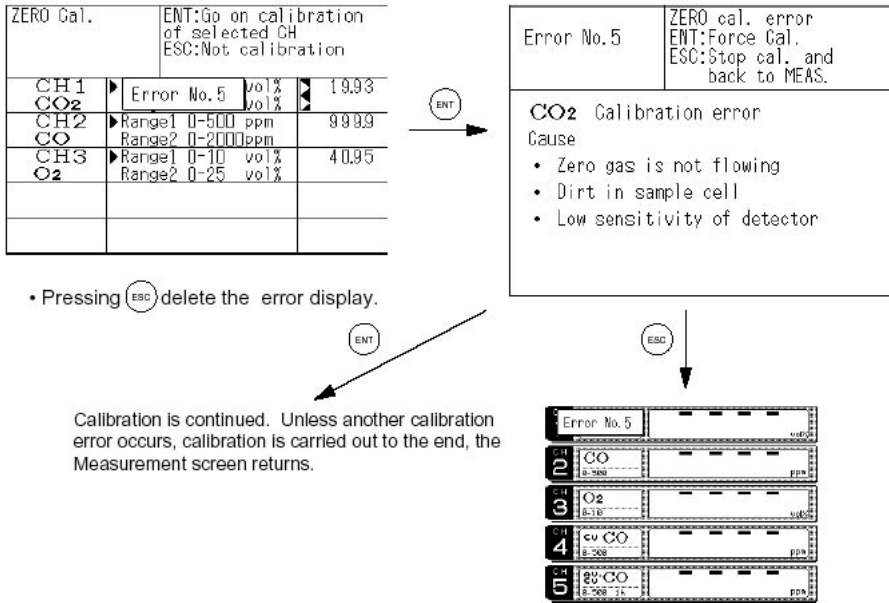

(2) Error log file

If error occurs, the history is saved in an error log file. The error log file exists in the maintenance mode.

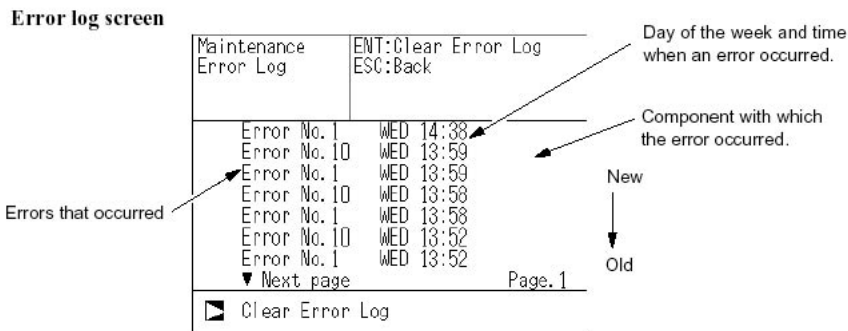

* Up to 14 errors can be saved in the error history; the oldest error will be deleted one by one every time a new occurs.

* If the power display supply is turned OFF, the contents in the error log file will not be lost or damaged.

Deletion of error history

Press the ENT key on the above screen, and the “Error Log Clear” will be inverted. Further pressing the key will clear the error history.

9. SPECIFICATIONS

9.1 Specifications

(1) Standard specifications

Principle of measurement:

CO₂, CO, CH₄, SO₂; Non-dispersion infrared-ray absorption method; Single light source and single beam (single beam system)

O₂: Paramagnetic method (O₂ sensor built in) or zirconia sensor method (O₂ sensor externally installed)

Measurable gas components and measuring range:

	Minimum range	Maximum range
CO ₂	0 to 500 ppm	0 to 100 vol%
CO	0 to 200 ppm	0 to 100 vol%
CH ₄	0 to 1000 ppm	0 to 100 vol%
SO ₂	0 to 1000 ppm	0 to 5000 ppm
O ₂ (built in)	0 to 5 vol%	0 to 100 vol%
O ₂ (external zirconia)	0 to 5 vol%	0 to 25 vol%

- Max. 4 components measurement including O₂.
- 1 or 2 measuring range per component.
- Measuring range ratio $\leq 1:5$ (except built in O₂) $\leq 1:20$ (built in O₂)

Max. 4 components and 2 ranges are selectable including an O₂ measurement. For measurable components and possible combinations of measuring ranges, refer to Tables 1 to 6.

Measured value indication:

Digital indication in 4 digits (LCD with back light)

- Instantaneous value of each component
- Instantaneous value after O₂ correction (only in CO, SO₂ measurement with O₂)
- Average value after O₂ correction (only in CO, SO₂ measurement with O₂)
- O₂ average value

Analog output signals:

4 to 20mA DC or 0 to 1V DC, non-isolated output. Analog output corresponds to measured value indication in 1:1. Permissible load; 550Ω max. for 4 to 20 mA DC/100kΩ min. for 0 to 1V DC

* Refer to Table 6, for the channel No. of displayed values and analog output signals.

Analog input signal:

For signal input from externally installed O₂ sensor. Signal requirement; (1) Signal from Teledyne's Zirconia O₂ sensor (TYPE: ZFK7) (2) 0 to 1V DC from an O₂ sensor Input section is not isolated. This feature is effective when an O₂ sensor is not built in.

Relay contact output:

1a contact (250V AC/2A, resistive load) Instrument error, calibration error, range discrimination, auto calibration status, solenoid valve drive for auto calibration, pump ON/OFF.

1c contact (250V AC/2A, resistive load) Upper/lower alarm contact output. Peak count alarm contact output.

* All relay contacts are isolated mutually and from the internal circuit.

Contact input:

Non-voltage contact (ON/0V, OFF/5V DC, 5mA flowing at ON); Remote range changeover, auto calibration remote start, remote holding, average value resetting; Isolated from the internal circuit with a photocoupler. Contact inputs are not isolated from one another.

*Only M3.5 screw terminals are used for all signal inputs and outputs.

Power supply:

Rated voltage: 100V to 240V AC
 Operating voltage: 85V to 264V AC
 Rated frequency: 50/60 Hz
 Power consumption: 70 VA max.
 Power inlet: Conformity to EN60320 Class I type

Operation conditions:

Ambient temperature: -5°C to 45°C
 Ambient humidity: 90% RH max.

Storage conditions:

Ambient temperature: -20°C to 60°C
 Ambient humidity: 100% RH max.noncondensing

Dimensions (H x W x D):

19-inch rack mounting type: 177 x 483 x 493mm
 Desk-top type: 194 x 483 x 493mm

Mass: Approx. 10 kg

Finish color:

Front panel; Off-white (Munsell 10Y7.5 / 0.5 or equivalent)

Casing: Steel-blue

Enclosure: Steel casing, for indoor use

Material of gas-contacting parts:

Gas inlet/outlet; SUS304
 Sample cell; SUS304/neoprene rubber
 Infrared-ray transmitting window; CaF₂
 Internal tubing; Toaron tube

Gas inlet/outlet:

Rc1/4 or NPT1/4 internal thread

Purge gas flow rate:

1 L / min (when required)

(2) Standard functions

Output signal holding:

Output signals are held during manual and auto calibrations by activation of holding (turning on its setting). The values to be held are the ones just before start calibration mode. Indication values will not be held.

Remote output holding:

Output signal is held at the latest value by short-circuiting the remote output holding input terminals. Holding is maintained while the terminals are short-circuited. Indication values will not be held.

Remote range changeover:

Measuring range can be changed according to an external signal when remote range changeover input is received. Changeover is effective only when remote range setting is turned on. In this case, measuring range cannot be changed manually. When the contact input terminals for each component are short-circuited, the first range is selected, and it is changed over to the second range when the terminals are open.

Range identification signal:

The present measuring range is identified by a contact signal. The contact output terminals for each component are short-circuited when the first range is selected, and when the second range is selected, the terminals are open.

Auto calibration:

Auto calibration is carried out periodically at the preset cycle. When a standard gas cylinder for calibration and a solenoid valve for opening/closing the gas flow line are prepared externally by the customer, calibration will be carried out with the solenoid valve drive contacts for zero calibration and each span calibration turned on/off sequentially at the set auto calibration timing.

Auto calibration cycle setting:

Auto calibration cycle is set. Setting is variable within 1 to 99 hours (in increments of 1 hour) or 1 to 40 days (in increments of 1 day).

Gas flow time setting:

The time for flowing each calibration gas in auto calibration is set. Settable within 60 to 599 seconds (in increments of 1 second)

Auto calibration remote start:

Auto calibration is carried out only once according to an external input signal. Calibration sequence is settable in the same way as the cyclic auto calibration. Calibration starts when a non-voltage rectangular wave is applied to the auto calibration remote start input terminals (opened after short-circuiting for 1.5 seconds or longer). Auto calibration is started when the contacts open.

Auto zero calibration:

Auto zero calibration is carried out periodically at the preset cycle. This cycle is independent on "Auto calibration" cycle.

When zero calibration gas and solenoid valve for opening/closing the calibration gas flow line are prepared externally by the customer, zero calibration will be carried out with the solenoid valve drive contact for zero calibration turned on/off at the set auto zero calibration timing.

Auto zero calibration cycle setting:

Auto zero calibration cycle is set. Setting is variable within 1 to 99 hours (in increments of 1 hour) or setting is variable within 1 to 40 days (in increments of 1 day).

Gas flow time setting:

The timing for flowing zero gas in auto zero calibration is set. Settable 60 to 599 seconds (in increments of 1 second)

Upper/lower limit alarm:

Alarm contact output turns on when the preset upper or lower limit alarm value is reached. Contacts close when the instantaneous value of each component becomes larger than the upper alarm limit value or smaller than the lower alarm limit value.

Instrument error contact output:

Contacts close at occurrence of analyzer error No. 1, 3 or 10.

Calibration error contact output:

Contacts close at occurrence of manual or auto calibration error (any of errors No. 4 to 9).

Auto calibration status contact outputs:

Contacts close during auto calibration.

Pump ON/OFF contact output:

During measurement, this contact close. While calibration gas is flowing, this contact open. This contact is connected in power supply of pump, and stop the sample gas while calibration gas flowing.

(3) Optional functions

O₂ correction:

Conversion of measured CO and SO₂ gas concentrations into values at standard O₂ concentration

21-On

Correction formula: $C = \frac{21-On}{21-Os} \times Cs$

21-Os

C: Sample gas concentration after O₂ correction

CS: measured concentration of sample gas
 Os : Measured O2 concentration
 On: Standard O2 concentration (value changeable by setting)

*The upper limit value of the fractional part in this calculation is 4. The result of calculation is indicated and output in an analog output signal.

Average value after O2 correction and O2 average value calculation:

The result of O2 correction or instantaneous O2 value can be output as an average value in the determined period of time. Used for averaging is the moving average method in which sampling is carried out at intervals of 30 seconds.

(Output is updated every 30 seconds. It is the average value in the determined period of time just before the latest updating.) Averaging time is settable within 1 to 59 minutes (in increments of 1 minute) or 1 to 4 hours (in increments of 1 hour).

Average value resetting:

The above-mentioned output of average value is started from the initial state by applying a non-voltage rectangular wave to the average value resetting input terminals (opened after short-circuiting for 1.5 seconds or longer). Output is reset by short-circuiting and restarted by opening.

CO concentration peak count alarm:

(added only for CO/O2 measurement) Alarm output turns on according to the preset concentration and count. Whenever the instantaneous value of CO exceeds the preset concentration value, count increments. If the count exceeds the preset value in one hour, the alarm contacts close.

Communication function:

RS-232C (9pins D-sub)
 Half-duplex bit serial
 Start-stop synchronization
 ModbusTM protocol
 Contents: Read/Write parameters; Read measurement concentration and instrument status.

Remark : When connecting via RS-485 interface, an RS-232C / RS-485 converter should be used.

(4) Applicable standards

Product safety: EN61010-1 :2001
 EMC: EN61326-1 :1997, A1 :1998, A2 :2001

(5) Performance

Repeatability: $\pm 0.5\%$ of full scale
 Linearity: $\pm 1\%$ of full scale
 Zero drift: $\pm 2\%$ of full scale/week
 Span drift: $\pm 2\%$ of full scale/week
 Response time: (for 90% FS response, including replacement time of sample gas)
 1 or 2 component measurement: Within 15 seconds
 3 or 4 component measurement : Within 30 seconds

Interference from other gases:

Interference component	CO2 analyzer	CO analyzer	CH4 analyzer	SO2 analyzer	O2 analyzer
CO 1000 ppm	$\leq 1\%$ FS		$\leq 1\%$ FS	$\leq 1\%$ FS	
CO2 15%		$\leq 1\%$ FS (for 200 ppm analyzer, $\leq 2.5\%$ FS)	$\leq 1\%$ FS	$\leq 1\%$ FS	$\leq 2\%$ FS
H2O saturation at 20°C	$\leq 1\%$ FS	$\leq 1\%$ FS (for 200 ppm analyzer, $\leq 2.5\%$ FS)	$\leq 1\%$ FS		
H2O saturation at 2°C		$\leq 2.5\%$ FS (for 200 ppm analyzer)		$\leq 5\%$ FS	

(6) Standard Requirements for Sample Gas

Flow rate: 1L / min ± 0.5 L / min
 Temperature: 0 to 50°C
 Pressure: 10 kPa or less (Gas outlet side should be open to the atmospheric air.)
 Dust: 100 $\mu\text{g}/\text{Nm}^3$ in particle size of 0.3 μm or less
 Mist: Unallowable
 Moisture: Below a level where saturation occurs at room temperature (condensation unallowable). Below a level to cause saturation at 2°C for CO measurement with 0 to 200 ppm range and SO2 measurement.

Corrosive component: HCl 1 ppm or less

Standard gas for calibration:

Zero gas; Dry N2

Span gas; Each sample gas having concentration 90 to 100% of its measuring range (recommended). Gas beyond concentration 100% is unusable.

In case a zirconia O2 analyzer is installed externally and calibration is carried out on the same calibration gas line:

Zero gas; Dry air or atmospheric air

Span gas; For other than O2 measurement, each sample gas having concentration 90 to 100% of its measuring range. For O2 measurement, O2 gas of 1 to 2 vol%.

(7) Installation conditions

Use this instrument indoors.

(Select a place where the equipment does not receive direct sunshine, draft/rain or radiation from hot substances. If such a place cannot be found, a roof or cover should be prepared for protection.)

A vibration-free place.

A place which is clean around the analyzer.

9.2 Code symbols

Digit	Description	note	1	2	3	4	5	6	7	8	9	10	11	12	13	14	15	16	17	18	19	20	21	Digit No. of code	
			Z	R	J																				
4	<Custom specifications> Standard					F																			
5	<Measurable component (SO ₂ , CO ₂ , CO, CH ₄) > None SO ₂ CO CO ₂ CH ₄ CO+CO CH+CO CO+CH ₄ CO+CO+CH ₄ Others	note 1					Y A B D E																		
6	<Measurable component (O ₂)> None External zirconia type sensor External O ₂ analyzer Built-in paramagnetic type O ₂ sensor	note 2 note 3					Y A B C																		
7	<Power supply and gas inlet/outlet> 100 to 240V AC, Rc1/4 on back face 100 to 240V AC, Rc1/4 on back face with purging 100 to 240V AC, NPT1/4 on back face 100 to 240V AC, NPT1/4 on back face with purging							0 1 2 3																	
8	<Revision code>								4																
9	<Structure> Table-top type 18-inch rack mounting type 18-inch rack mounting type with slide rail											A B C													
10	<Indication, power cable> In Japanese, Rated voltage: 125V In English, Rated voltage: 125V (UL) In English, Rated voltage: 250V (CEE)	note 10										J E U													
11	<Measuring range> 1st component, 1st range None 0 to 200ppm 0 to 500ppm 0 to 1000ppm 0 to 2000ppm 0 to 2500ppm 0 to 5000ppm 0 to 1% 0 to 2% 0 to 3% 0 to 5% 0 to 10% 0 to 20% 0 to 25% 0 to 40% 0 to 50% 0 to 70% 0 to 100% Others	note 4 note 1 note 5 note 6											Y C E F G U H J K Q L M N V W P X R Z												
12	<Measuring range> 1st component, 2nd range None 0 to 500ppm 0 to 1000ppm 0 to 2000ppm 0 to 2500ppm 0 to 5000ppm 0 to 1% 0 to 2% 0 to 5% 0 to 10% 0 to 20% 0 to 25% 0 to 50% 0 to 100% Others	note 4 note 1											Y E F G U H J K L M N V P R Z												

Digit	Description	note	1	2	3	4	5	6	7	8	9	10	11	12	13	14	15	16	17	18	19	20	21
13	-<Measuring range> 2nd component, 1st range None 0 to 500ppm 0 to 1000ppm 0 to 2000ppm 0 to 2500ppm 0 to 5000ppm 0 to 1% 0 to 2% 0 to 3% 0 to 5% 0 to 10% 0 to 20% 0 to 25% 0 to 40% 0 to 50% 0 to 70% 0 to 100% Others	note 4 note 1	Z	R	J																		
14	-<Measuring range> 2nd component, 2nd range None 0 to 1000ppm 0 to 2000ppm 0 to 2500ppm 0 to 5000ppm 0 to 1% 0 to 2% 0 to 5% 0 to 10% 0 to 20% 0 to 25% 0 to 50% 0 to 100% Others	note 4 note 1																					
15	-<Measuring range> 3rd component, 1st range None 0 to 500ppm 0 to 1000ppm 0 to 2000ppm 0 to 2500ppm 0 to 5000ppm 0 to 1% 0 to 2% 0 to 3% 0 to 5% 0 to 10% 0 to 20% 0 to 25% 0 to 40% 0 to 50% 0 to 70% 0 to 100% Others	note 4 note 1																					
16	-<Measuring range> 3rd component, 2nd range None 0 to 1000ppm 0 to 2000ppm 0 to 2500ppm 0 to 5000ppm 0 to 1% 0 to 2% 0 to 5% 0 to 10% 0 to 20% 0 to 25% 0 to 50% 0 to 100% Others	note 4 note 1																					

Digit No. of code

Digit	Description	note	1	2	3	4	5	6	7	8	9	10	11	12	13	14	15	16	17	18	19	20	21				
17	<O ₂ analyzer, 1st range> None 0 to 5% 0 to 10% 0 to 20% 0 to 25% 0 to 50% 0 to 100% Others	note 4	Z	R	J														Y	L	M	N	V	P	R	Z	
18	<O ₂ analyzer, 2nd range> None 0 to 10% 0 to 20% 0 to 25% 0 to 50% 0 to 100% Others	note 4																	Y	M	N	V	P	R	Z		
19	<Output> 4 to 20mA DC 0 to 1V DC 4 to 20 mA DC + Communication function 0 to 1 V DC + Communication function																		A	B	C	D					
20	<O ₂ correction and O ₂ average value output> None With O ₂ correction output and average output With Peak count alarm output With O ₂ correction and average output, and peak count alarm output	note 7 note 8																	Y	A	B	C					
21	Adjustment Standard For heat treatment Others	note 9																							A	B	Z

<Code specification for ordering>

- (1) Code symbols should be specified.
- (2) Range combination should be the one allowed in separate tables.

(note 1) "Y" should be specified when only O₂ measurement is necessary.

(note 2) External O₂ sensor signal should be 0-1VDC linear of full scale, when " B " is specified at the 6th digit.

(note 3) "C" should be specified when " Y " is specified at the 5th digit.

(note 4) Allowable combinations of ranges are specified in the Table 1 to 6 in page 9-7 and 9-8.

(note 5) Allowed only for CO analyzer.

(note 6) Allowed only for CO and CO₂ analyzers.

(note 7) O₂ correction is carried out for CO and SO₂. At the same time, average value output after O₂ correction and O₂ average value output are added. Peak count alarm is carried out for CO.

(note 8) "Y" should be specified when without O₂ measurement (when 6th digit is Y).

(note 9) A gas composition table should be issued.

(note 10) Rated voltage of supplied power cable and plug configuration differ when "E" and "U" are specified at the 10th digit. Select one from three power voltages. Plug configuration is North America type when specifying "E", and European type when specifying "U".

Measurable component and range - availability check table -

Table 1: Single-component analyzer (CO₂, CO, CH₄ or SO₂)

1st range	2nd range											
	E 0 to 500ppm	F 0 to 1000ppm	G 0 to 2000ppm	U 0 to 2500ppm	H 0 to 5000ppm	J 0 to 1%	K 0 to 2%	L 0 to 5%	M 0 to 10%	N 0 to 20%	P 0 to 50%	R 0 to 100%
C 0 to 200ppm	○	○	—	—	—	—	—	—	—	—	—	—
E 0 to 500ppm	—	⊗	⊗	⊗	—	—	—	—	—	—	—	—
F 0 to 1000ppm	—	—	⊗△□	⊗△□	⊗△□	—	—	—	—	—	—	—
G 0 to 2000ppm	—	—	—	⊗△□	⊗△□	⊗△	—	—	—	—	—	—
U 0 to 2500ppm	—	—	—	—	⊗△□	⊗△	—	—	—	—	—	—
H 0 to 5000ppm	—	—	—	—	—	⊗△	⊗△	—	—	—	—	—
J 0 to 1%	—	—	—	—	—	—	⊗△	⊗△	—	—	—	—
K 0 to 2%	—	—	—	—	—	—	—	⊗△	⊗△	—	—	—
Q 0 to 3%	—	—	—	—	—	—	—	⊗△	⊗△	—	—	—
L 0 to 5%	—	—	—	—	—	—	—	—	⊗△	⊗△	—	—
M 0 to 10%	—	—	—	—	—	—	—	—	—	⊗△	⊗	—
N 0 to 20%	—	—	—	—	—	—	—	—	—	—	⊗△	⊗
W 0 to 40%	—	—	—	—	—	—	—	—	—	—	⊗△	⊗
P 0 to 50%	—	—	—	—	—	—	—	—	—	—	—	⊗△
X 0 to 70%	—	—	—	—	—	—	—	—	—	—	—	⊗△
R 0 to 100%	—	—	—	—	—	—	—	—	—	—	—	⊗△

⊗: CO₂ analyzer measurable range ○: CO analyzer measurable range
 △: CH₄ analyzer measurable range □: SO₂ analyzer measurable range

*Note) Single range is also available.

Table 2: Double-component analyzer (CO₂ and CO)

1st component ↓ (CO ₂), 1st range	2nd component (CO), 1st range →												
	E 0 to 500ppm	F 0 to 1000ppm	G 0 to 2000ppm	U 0 to 2500ppm	H 0 to 5000ppm	J 0 to 1%	K 0 to 2%	L 0 to 5%	M 0 to 10%	N 0 to 20%	V 0 to 25%	P 0 to 50%	R 0 to 100%
H 0 to 5000ppm	—	⊗	⊗	⊗	⊗	⊗	⊗	⊗	⊗	⊗	⊗	⊗	○
J 0 to 1%	⊗	⊗	⊗	⊗	⊗	⊗	⊗	⊗	⊗	⊗	⊗	⊗	○
K 0 to 2%	⊗	⊗	⊗	⊗	⊗	⊗	⊗	⊗	⊗	○	○	○	○
L 0 to 5%	⊗	⊗	⊗	⊗	⊗	⊗	⊗	⊗	⊗	⊗	⊗	⊗	○
M 0 to 10%	⊗	⊗	⊗	⊗	⊗	⊗	⊗	⊗	⊗	⊗	⊗	⊗	○
N 0 to 20%	⊗	⊗	⊗	⊗	⊗	⊗	⊗	⊗	⊗	⊗	⊗	⊗	○
P 0 to 50%	—	⊗	⊗	⊗	⊗	⊗	⊗	⊗	⊗	⊗	⊗	⊗	○
R 0 to 100%	—	○	○	○	○	○	○	○	○	○	○	○	○

○: Available as single range, ⊗: 2 ranges of 2 and 2.5 times each range available.

Table 3: Double-component analyzer (CH₄ and CO)

1st component ↓ (CH ₄), 1st range	2nd component (CO), 1st range →												
	E 0 to 500ppm	F 0 to 1000ppm	G 0 to 2000ppm	U 0 to 2500ppm	H 0 to 5000ppm	J 0 to 1%	K 0 to 2%	L 0 to 5%	M 0 to 10%	N 0 to 20%	V 0 to 25%	P 0 to 50%	R 0 to 100%
H 0 to 5000ppm	—	⊗	⊗	⊗	⊗	⊗	○	⊗	⊗	⊗	⊗	—	—
J 0 to 1%	—	⊗	⊗	⊗	⊗	⊗	○	⊗	⊗	⊗	⊗	○	○
K 0 to 2%	⊗	⊗	⊗	⊗	⊗	⊗	⊗	⊗	⊗	⊗	○	⊗	○
L 0 to 5%	⊗	⊗	⊗	⊗	⊗	⊗	⊗	⊗	⊗	⊗	⊗	⊗	○
M 0 to 10%	⊗	⊗	⊗	⊗	⊗	⊗	⊗	⊗	⊗	⊗	⊗	⊗	○
N 0 to 20%	—	—	⊗	⊗	⊗	⊗	⊗	⊗	⊗	⊗	⊗	⊗	○
P 0 to 50%	—	—	—	—	⊗	⊗	⊗	⊗	⊗	⊗	⊗	⊗	○
R 0 to 100%	—	—	—	—	—	○	○	○	○	○	○	○	○

○: Available as single range, ⊗: 2 ranges of 2 and 2.5 times each range available.

Table 4: Double-component analyzer (CO₂ and CH₄)

		2nd component (CH ₄), 1st range → CH ₄											
		F	G	U	H	J	K	L	M	N	V	P	R
1st component ↓ (CO ₂), 1st range		0 to 1000ppm	0 to 2000ppm	0 to 2500ppm	0 to 5000ppm	0 to 1%	0 to 2%	0 to 5%	0 to 10%	0 to 20%	0 to 25%	0 to 50%	0 to 100%
CO ₂	G 0 to 2000ppm	—	—	—	⊙	⊙	⊙	⊙	⊙	—	—	—	—
	U 0 to 2500ppm	—	—	—	⊙	⊙	⊙	⊙	⊙	—	—	—	—
	H 0 to 5000ppm	—	—	—	⊙	⊙	⊙	⊙	⊙	⊙	—	—	—
	J 0 to 1%	⊙	⊙	⊙	⊙	⊙	⊙	⊙	⊙	⊙	⊙	—	—
	K 0 to 2%	⊙	⊙	⊙	⊙	⊙	⊙	⊙	⊙	⊙	⊙	⊙	—
	L 0 to 5%	⊙	⊙	⊙	⊙	⊙	⊙	⊙	⊙	⊙	⊙	⊙	○
	M 0 to 10%	⊙	⊙	⊙	⊙	⊙	⊙	⊙	⊙	⊙	⊙	⊙	○
	N 0 to 20%	⊙	⊙	⊙	⊙	⊙	⊙	⊙	⊙	⊙	⊙	⊙	○
	P 0 to 50%	—	⊙	⊙	⊙	⊙	⊙	⊙	⊙	⊙	⊙	⊙	○
	R 0 to 100%	—	○	○	○	○	○	○	○	○	○	○	○

○: Available as single range, ⊙: 2 ranges of 2 and 2.5 times each range available

Table 5: Triple component analyzer (CO₂, CO, CH₄)

Covered in combination of Table 2, Table 3 and Table 4.

Table 6: O₂ analyzer

		2nd range				
		L	M	V	P	R
1st range		0 to 5%	0 to 10%	0 to 25%	0 to 50%	0 to 100%
L 0 to 5%		—	○△	○△	○	—
M 0 to 10%		—	—	○△	○	○
V 0 to 25%		—	—	—	○	○
P 0 to 50%		—	—	—	—	○
R 0 to 100%		—	—	—	—	○

○: Built-in O₂ analyzer measurable range,

△: External zirconia type O₂ analyzer measurable range

*O₂ analyzer is selectable indifferently to combination with other components.

External zirconia type O₂ analyzer is assumed to be Fuji's type ZFK.

9.3 Outline diagram

(1) Main unit

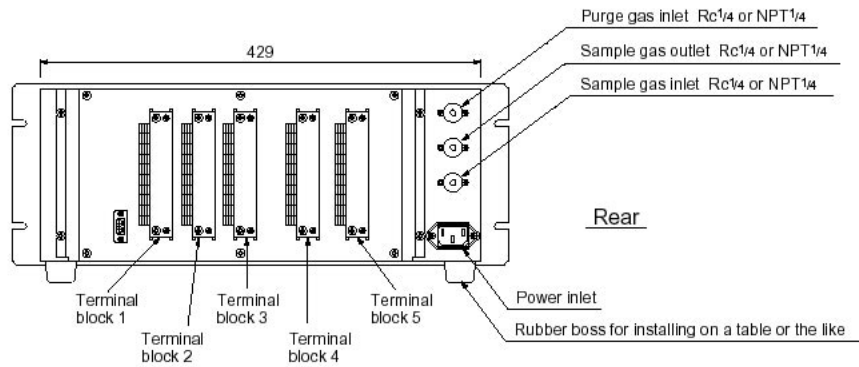
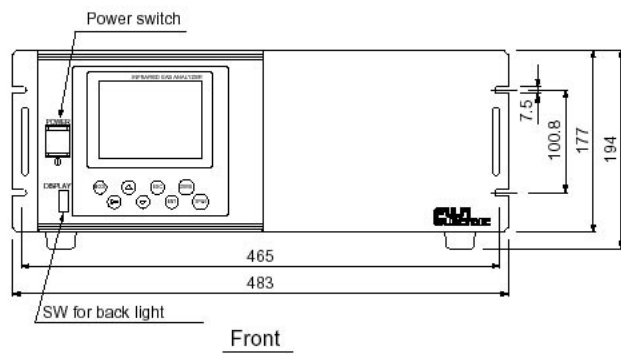
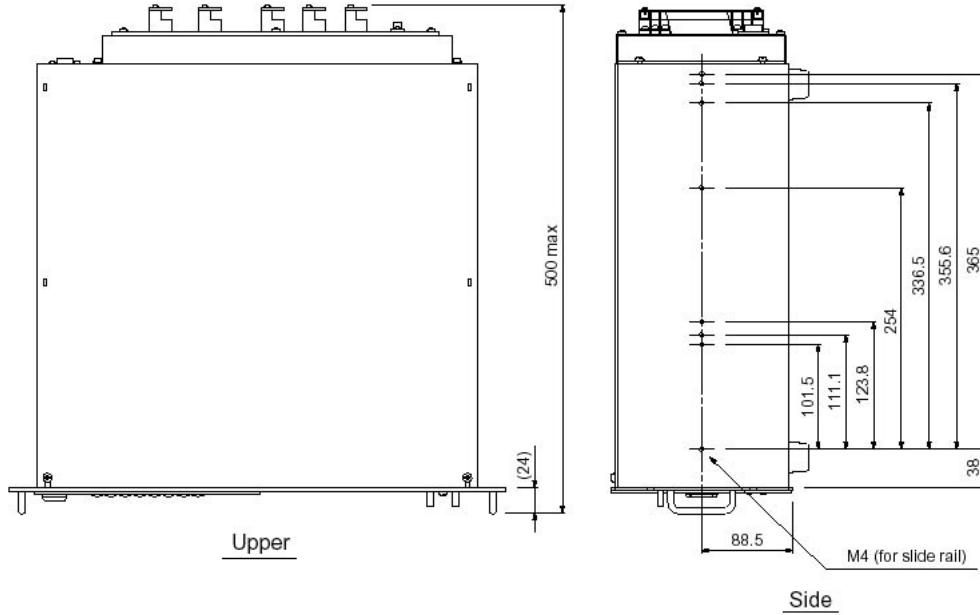

(2) Accessory slide rail (unit: mm)

* The slide rails are attached to this equipment when designated.

Model : 305A-20/Accuride International Inc.

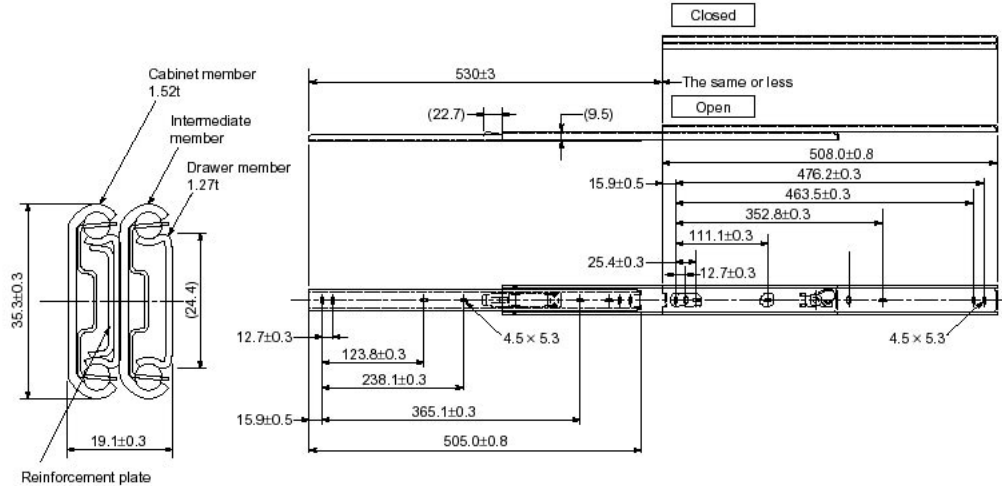

19-inch rack mounting method:

The mass of the instrument should be supported at the bottom of the unit (or the side of the unit when mounted with the slide rails).

Also, for facilitate maintenance, a structure which allows extraction of the main unit by using the slide rail is recommended.

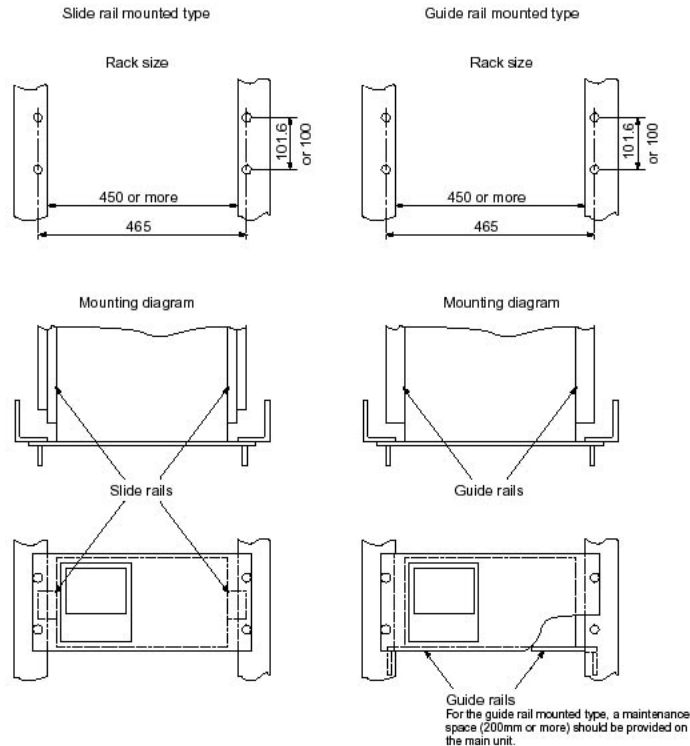

Appendix

Drawing List

D79104 Outline diagram

Free Manuals Download Website

<http://myh66.com>

<http://usermanuals.us>

<http://www.somanuals.com>

<http://www.4manuals.cc>

<http://www.manual-lib.com>

<http://www.404manual.com>

<http://www.luxmanual.com>

<http://aubethermostatmanual.com>

Golf course search by state

<http://golfingnear.com>

Email search by domain

<http://emailbydomain.com>

Auto manuals search

<http://auto.somanuals.com>

TV manuals search

<http://tv.somanuals.com>