

---

OPERATING INSTRUCTIONS  
FOR

*Model OT-2  
Oxygen  
Transmitter System*



**DANGER**



HIGHLY TOXIC AND/OR FLAMMABLE LIQUIDS OR GASES MAY BE PRESENT IN THIS MONITORING SYSTEM. PERSONAL PROTECTIVE EQUIPMENT MAY BE REQUIRED WHEN SERVICING THIS SYSTEM. ONLY AUTHORIZED PERSONNEL SHOULD CONDUCT MAINTENANCE AND/OR SERVICING. BEFORE CONDUCTING ANY MAINTENANCE OR SERVICING CONSULT WITH AUTHORIZED SUPERVISOR/MANAGER.

P/N: M71265  
ECO: #99-0000  
10/21/1999

# Model OT-2 System

---

## Copyright © 1999 Teledyne Analytical Instruments

All Rights Reserved. No part of this manual may be reproduced, transmitted, transcribed, stored in a retrieval system, or translated into any other language or computer language in whole or in part, in any form or by any means, whether it be electronic, mechanical, magnetic, optical, manual, or otherwise, without the prior written consent of Teledyne Analytical Instruments, 16830 Chestnut Street, City of Industry, CA 91749-1580.

### Warranty

This equipment is sold subject to the mutual agreement that it is warranted by us free from defects of material and of construction, and that our liability shall be limited to replacing or repairing at our factory (without charge, except for transportation), or at customer plant at our option, any material or construction in which defects become apparent within one year from the date of shipment, except in cases where quotations or acknowledgements provide for a shorter period. Components manufactured by others bear the warranty of their manufacturer. This warranty does not cover defects caused by wear, accident, misuse, neglect or repairs other than those performed by Teledyne or an authorized service center. We assume no liability for direct or indirect damages of any kind and the purchaser by the acceptance of the equipment will assume all liability for any damage which may result from its use or misuse.

We reserve the right to employ any suitable material in the manufacture of our apparatus, and to make any alterations in the dimensions, shape or weight of any parts, in so far as such alterations do not adversely affect our warranty.

### Important Notice

This instrument provides measurement readings to its user, and serves as a tool by which valuable data can be gathered. The information provided by the instrument may assist the user in eliminating potential hazards caused by his process; however, it is essential that all personnel involved in the use of the instrument or its interface, with the process being measured, be properly trained in the process itself, as well as all instrumentation related to it.

The safety of personnel is ultimately the responsibility of those who control process conditions. While this instrument may be able to provide early warning of imminent danger, it has no control over process conditions, and it can be misused. In particular, any alarm or control systems installed must be tested and understood, both as to how they operate and as to how they can be defeated. Any safeguards required such as locks, labels, or redundancy, must be provided by the user or specifically requested of Teledyne at the time the order is placed.

Therefore, the purchaser must be aware of the hazardous process conditions. The purchaser is responsible for the training of personnel, for providing hazard warning methods and instrumentation per the appropriate standards, and for ensuring that hazard warning devices and instrumentation are maintained and operated properly.

Teledyne Analytical Instruments (TAI), the manufacturer of this instrument, cannot accept responsibility for conditions beyond its knowledge and control. No statement expressed or implied by this document or any information disseminated by the manufacturer or its agents, is to be construed as a warranty of adequate safety control under the user's process conditions.

## Table of Contents

<b>1 Introduction</b>	
1.1 Overview .....	1-1
1.2 Features .....	1-1
1.3 Typical Applications .....	1-2
1.4 Operator Interface .....	1-3
<b>2 Operational Theory</b>	
2.1 Introduction .....	2-1
2.2 Micro-Fuel Cell Sensor .....	2-2
2.2.1 Principles of Operation .....	2-2
2.2.2 Anatomy of a Micro-Fuel Cell .....	2-2
2.2.3 Electrochemical Reactions .....	2-4
2.2.4 The Effect of Pressure .....	2-5
2.2.5 Calibration Characteristics .....	2-6
2.3 Electronics and Signal Processing .....	2-7
2.4 Oxygen Cell Block Heater .....	2-7
2.5 EMI/RFI Protection .....	2-7
2.5 Sample System .....	2-8
<b>3 Operation</b>	
3.1 Installation .....	3-1
3.1.1 Unpacking the System .....	3-1
3.1.2 Mounting the System .....	3-2
3.1.3 System Connections .....	3-3
3.1.3.1 Gas Connections .....	3-3
3.1.3.2 Electrical Connections .....	3-4
3.2 Installing the Micro-Fuel Cell .....	3-6
3.3 Calibration .....	3-6
3.3.1 Calibration Gas Connections .....	3-6
3.3.2 Setting the Span .....	3-8
3.3.3 H <sub>2</sub> S Scrubber .....	3-9
3.3.4 Exhaust/Vent Line .....	3-9
3.4 Testing the System .....	3-9
<b>4 Maintenance</b>	
4.1 Routine Maintenance .....	4-1
4.2 Cell Replacement .....	4-1
4.2.1 Cell Warranty .....	4-2
4.3 Scrubber Replacement .....	4-3
4.4 Filter Servicing .....	4-3

# Model OT-2 System

---

## Appendix

Specifications .....	A-1
Recommended Spare Parts List .....	A-2
Drawing List .....	A-2
Material Safety Data Sheet .....	A-3

The following International Symbols are used throughout the Instruction Manual for your visual and immediate warnings and when you have to attend CAUTION while operating the instrument:



**GROUND**  
Protective Earth



**CAUTION**, The operator needs to refer to the manual for further information. Failure to do so may compromise the safe operation of the equipment.

---

## Introduction

---

### 1.1 Overview

The Teledyne Analytical Instruments Model OT-2 System is designed to accurately monitor the oxygen content in a wide variety of gases at the ppm level. The Trace Oxygen Transmitter is equipped with two oxygen analysis ranges, 0–10 ppm and 0–100 ppm (0-100 ppm and 0-1000 ppm optional). The OT-2 System is acceptable for operation in Class 1, Division 2, Groups B, C, and D hazardous environments, when used in conjunction with a non-insensitive power source, such as the Elsag Baily Total Flow™ System.

The heart of the OT-2 System is Teledyne Analytical Instruments' Micro-Fuel Cell oxygen sensor. This cell is a sealed electrochemical device which translates the amount of oxygen present in a sample into an electrical current. Since it is sealed, there is no electrolyte to change or electrodes to clean and therefore, virtually maintenance free.

The transmitter operates from a 12VDC (nominal) power source and produces a 1-5VDC voltage output that is directly and linearly proportional to the oxygen concentration. The output voltage is used to interface with high input impedance (>10 Kilo ohms) devices such as recorders, alarms, computers or other voltage driven devices.

### 1.2 Features

The following features describe the basic model. The exact configuration depends on the options selected at the time of purchase.

- Two analysis ranges: 0–10 ppm and 0-100 ppm (0-100 ppm and 0-1000 ppm optional) user selectable
- High sensitivity (0.5% FS)
- Digital O<sub>2</sub> concentration display

- Accurate ( $\pm 2\%$  of full scale at constant temperature on 100 ppm, or 1000 ppm scale;  $\pm 1$  ppm on 0–10 ppm scale at constant temperature)
- Insensitive to flow variations
- Fast response and recovery
- Long life, maintenance-free Micro-Fuel Cell oxygen sensor
- Unaffected by reducing agents (HC's, CO, SO<sub>2</sub>, etc.)
- Easy to calibrate, no zero gas required
- 12VDC Battery Powered w/ 1-5 VDC Output
- Rugged NEMA 4, bulkhead mounted enclosure
- Stainless Steel sample system (nylon cell holder)
- H<sub>2</sub>S scrubber
- Pressure regulation with gage
- Sample filter
- Flowmeter
- Heated cell holder assembly

### 1.3 Typical Applications

Although the OT-2 System is designed in conjunction with the Elsag Baily Total Flow™ System for natural gas production, it also is capable of monitoring oxygen at the ppm level in a variety of gases. A few typical applications include:

- Gas gathering and transportation
- Monitoring inert gas blanketing
- Air separation and liquefaction
- Chemical feedstock analysis
- Petrochemical process control
- Heat treating and bright annealing processes
- Quality assurance
- Gas certification
- Welding applications

## 1.4 Operator Interface

The OT-2 System is housed in a rugged metal NEMA-4 case with the display visible from the front and the controls accessible from inside the front door. See Figure 1-1. The front door has a clear Lexan window for viewing the sample system components and transmitter display.

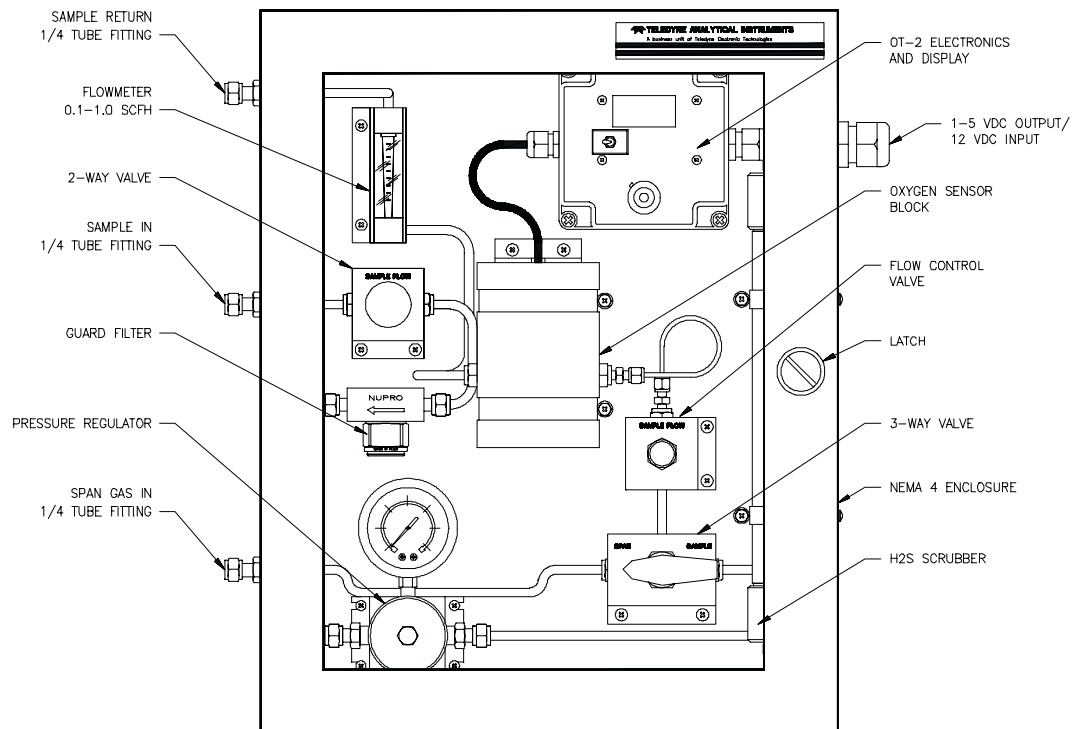

Figure 1-1 Front View

**Access Door:** For access to the Micro-Fuel Cell and transmitter controls, the front door swings open when the slotted latch in the middle right side of the door is turned counter-clockwise. The replaceable Micro Fuel Cell is housed in a nylon cell block positioned for easy access.

**OT-2 Electronics & Display:** The OT-2 meter display is a LCD device that produces 3.5 decimal, 7-segment numbers that are legible in daylight. It produces a continuous readout of oxygen concentration. Accessing the transmitter electronics requires unfastening the screws of the transparent front cover of the OT-2 and lifting the cover off.

**Flowmeter:** Monitors the flow of gas past the sensor. Readout is 0.1-1 standard cubic feet per hour (scfh).

**H<sub>2</sub>S Scrubber:** The H<sub>2</sub>S scrubber prevents H<sub>2</sub>S gas from affecting the oxygen sensor.





## Operational Theory

---

### 2.1 Introduction

The OT-2 System is composed of three subsystems:

1. Micro-Fuel Cell Sensor
2. Electronic Signal Processing, Display and Control
3. Sample System

The Micro-Fuel Cell is an electrochemical galvanic device that translates the amount of oxygen present in the sample into an electrical output.

The electronic signal processing, display and control subsystem provides oxygen concentration information both visually and electronically.

The sample system accepts the sample gas and removes the  $H_2S$  in the sample prior to introduction to the sensor.

## 2.2 Micro-Fuel Cell Sensor

### 2.2.1 Principles of Operation

The oxygen sensor used in the Model OT-2 System is a Micro-fuel Cell designed and manufactured by Analytical Instruments. It is a sealed plastic disposable electrochemical transducer.

The key components of the Micro-Fuel Cell are a diffusion barrier in the form of a thin membrane, a cathode, an anode, and an electrolyte in which they are immersed.

Oxygen from the sample gas diffuses through the thin membrane and is reduced at the cathode. As a result, an electrical current is produced that is proportional to the concentration of oxygen in the sample gas.

The choice of electrolyte, and hence the sensor type, depends on the exact constituents of the sample gas. For sample gases that contain a high concentration of  $\text{CO}_2$ , for example, an acid electrolyte will be the more optimal choice.

### 2.2.2 Anatomy of a Micro-Fuel Cell

The Micro-fuel Cell is approximately  $1\frac{1}{4}$  inches in diameter. The cell body is made of an inert plastic that is compatible with a wide variety of sample streams. Oxygen from the sample gas diffuses through a thin membrane located at one end of the sensor. The other end of the cell is a contact plate consisting of two concentric foil rings. The rings mate with spring-loaded contacts in the sensor block assembly and provide the electrical connection to the rest of the analyzer. Figure 2-1 illustrates the external features.

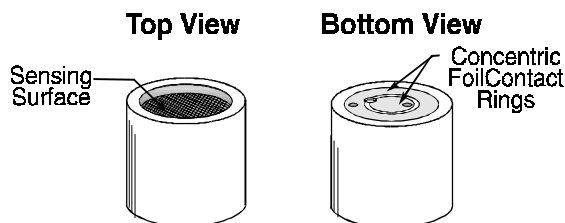

Figure 2-1: Micro-Fuel Cell

Refer to Figure 2-2, *Cross Section of a Micro-Fuel Cell*, which illustrates the following internal description.

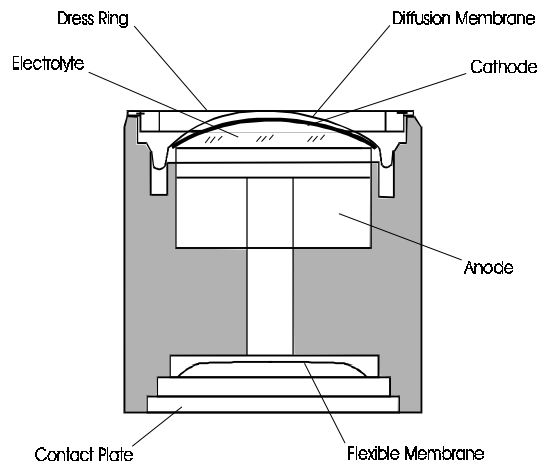

Figure 2-2. *Cross Section of a Micro-Fuel Cell (not to scale)*

At the top end of the cell is a diffusion membrane of Teflon. Beneath the diffusion membrane lies the oxygen sensing element—the cathode.

The anode provides the electrical driving force for the reduction of oxygen at the cathode.

At the rear of the cell, just below the anode structure, is a flexible membrane designed to accommodate the internal volume changes that occur throughout the life of the cell. This flexibility assures that the sensing membrane remains in its proper position, keeping the electrical output constant.

The entire space between the diffusion membrane, above the cathode, and the flexible rear membrane, beneath the anode, is filled with electrolyte. Cathode and anode are submerged in this common pool. They each have a conductor connecting them to one of the external contact rings on the contact plate, which is on the bottom of the cell.

### 2.2.3 Electrochemical Reactions

The sample gas diffuses through the Teflon membrane. For a sensor that employs KOH as electrolyte, oxygen in the sample gas is reduced on the surface of the cathode according to the following HALF REACTION:



(Four electrons combine with one oxygen molecule—in the presence of water from the electrolyte—to produce four hydroxyl ions.)

When the oxygen is reduced at the cathode, lead is simultaneously oxidized at the anode by the following HALF REACTION:



(Two electrons are transferred for each atom of lead that is oxidized. Therefore it takes two of the above anode reactions to balance one cathode reaction and transfer four electrons.)

The electrons released at the surface of the anode flow to the cathode surface when an external electrical path is provided. The current is proportional to the amount of oxygen reaching the cathode. It is measured and used to determine the oxygen concentration in the gas mixture.

The overall reaction for the fuel cell is the SUM of the half reactions above, or:

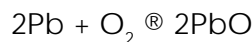

(These reactions will be the dominant sensor current component as long as no gaseous components capable of oxidizing lead—such as iodine, bromine, chlorine and fluorine—are present in the sample.)

In the absence of oxygen, the output of the sensor is approximately zero.

**Warning:**The sensor used in the Model OT-2 System uses electrolytes which contain substances that are harmful if touched, swallowed, or inhaled. Avoid contact with ANY fluid or powder in or around the unit. What may appear to be plain water could contain one of these harmful substances. In case of eye contact, immediately flush eyes with water for at least 15 minutes. Call physician. (See Appendix - Material Safety Data Sheet (MSDS)).



### 2.2.4 The Effect of Pressure

The Micro-Fuel Cell responds to the partial pressure of oxygen present inside the cell holder.

By design, the total gas pressure inside the cell holder is kept approximately the same as the atmospheric pressure. As the atmospheric pressure changes, the partial pressure of oxygen in the cell holder will change accordingly.

The impact due to changes in atmospheric pressure is usually limited to less than 3% of reading.

### 2.2.5 Calibration Characteristics

Given that the total pressure of the sample gas on the surface of the Micro-Fuel Cell input is constant, a convenient characteristic of the cell is that the current produced in an external circuit is directly proportional to the rate at which oxygen molecules reach the cathode, and this rate is directly proportional to the concentration of oxygen in the gaseous mixture. In other words it has a linear characteristic curve, as shown in Figure 2-3. Measuring circuits do not have to compensate for nonlinearities.

In addition, since the sensor output is approximately zero in the absence of oxygen, the characteristic curve has close to an absolute zero (within  $\pm 1$  ppm oxygen or better, depending on the sensor type and model). In practical application, zeroing may still be used to compensate for the combined zero offsets of the cell and the electronics.

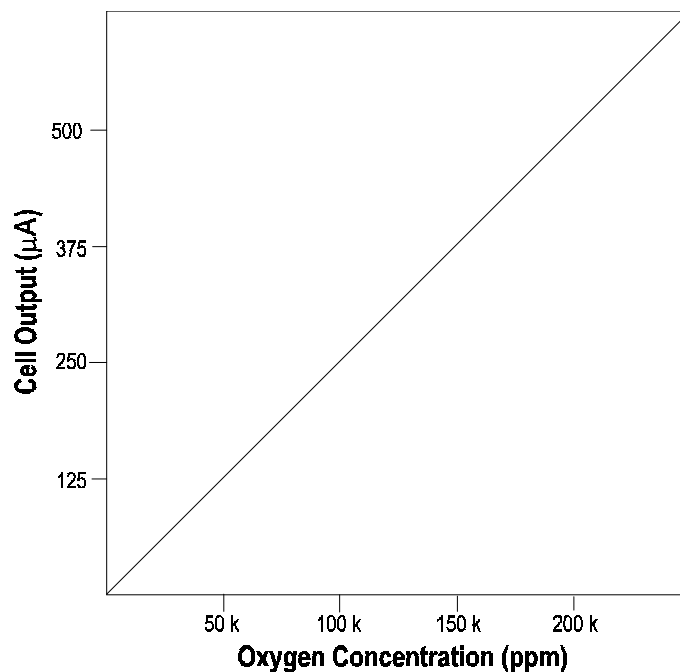

Figure 2-3. Characteristic Input/Output Curve for a Micro-Fuel Cell

### 2.3 Electronics and Signal Processing

The OT-2 circuitry consists of three stages: an input stage, a temperature compensation/gain stage and an output stage.

The input stage consists of a current to voltage converter producing a voltage signal that is proportional to the oxygen concentration as detected by the sensor.

The temperature compensation stage contains circuitry that compensates for the temperature effects on the output current of the O<sub>2</sub> cell. A thermistor mounted in the sensor assembly monitors the sensor temperature.

The output stage provides a 1-5 volt signal into a load >10K ohms corresponding to 0-100% of full scale of the selected range.

The transmitter circuitry operates with a power supply voltage range of 9-16 VDC. It is recommended that the output cable be no longer than 10 feet. A shielded cable should be used whenever possible to minimize electrical noise pickup.

### 2.4 Oxygen Cell Block Heater

The OT-2 system is equipped with an insulated and electrically heated cell block. The heater is switched on when the enclosure temperature dips below 1°C. The 3 watt heater is controlled by the electronic control unit.

**Note:** *The cell block insulation must be in place for the heater system to be effective.*

### 2.5 EMI/RFI Protection

The OT-2 System is well shielded from EMI/RFI. The transmitter electronics are mounted within a grounded metallic enclosure, and the electronics is housed within the main system enclosure. For optimal transmitter performance, the main system enclosure should be well grounded.

## 2.6 Sample System

The system consists of a shut off valve, particulate filter, pressure regulator, scrubber, calibration selector valve, flow control valve, O<sub>2</sub> transmitter and a sample flow meter and incorporates ¼ inch tube fittings for sample inlet and outlet connections at the side of the enclosure.

H<sub>2</sub>S from the sample gas can diffuse into the Micro-Fuel Cell leading to the formation of lead sulphide with the anode material. To eliminate the deleterious effect of H<sub>2</sub>S on the sensor, the scrubber is filled with Purafil®.

### **Sample Flow Description:** (See Figure 2-4)

1. The sample enters the transmitter system via the shut off valve at 6-40 psig and passes through the filter where particulates, to 90 microns, are trapped.
2. A pressure regulator, which has been preset at the factory to approximately 5 psig ensures a constant gas flow to the sensor.
3. After the pressure regulator, the sample gas passes through the scrubber to the calibration selector valve.
4. When the sample has been selected, it flows through the flow control valve to the O<sub>2</sub> sensor.
5. Finally, the sample flows through the flow meter and exits the system through the vent line to a safe area at atmospheric pressure.

**Note:** *The flow control valve should be adjusted until the flow meter indicates a flow rate of 0.4 scfh.*

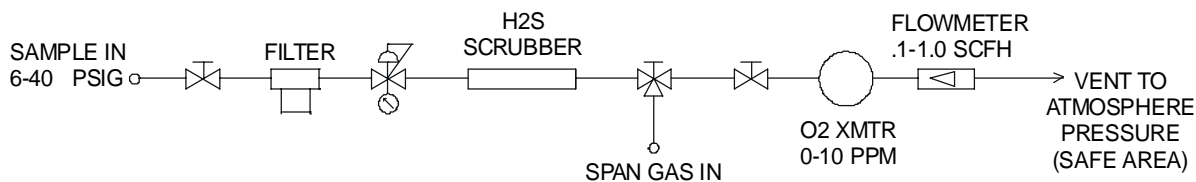

Figure 2-4 Flow Diagram



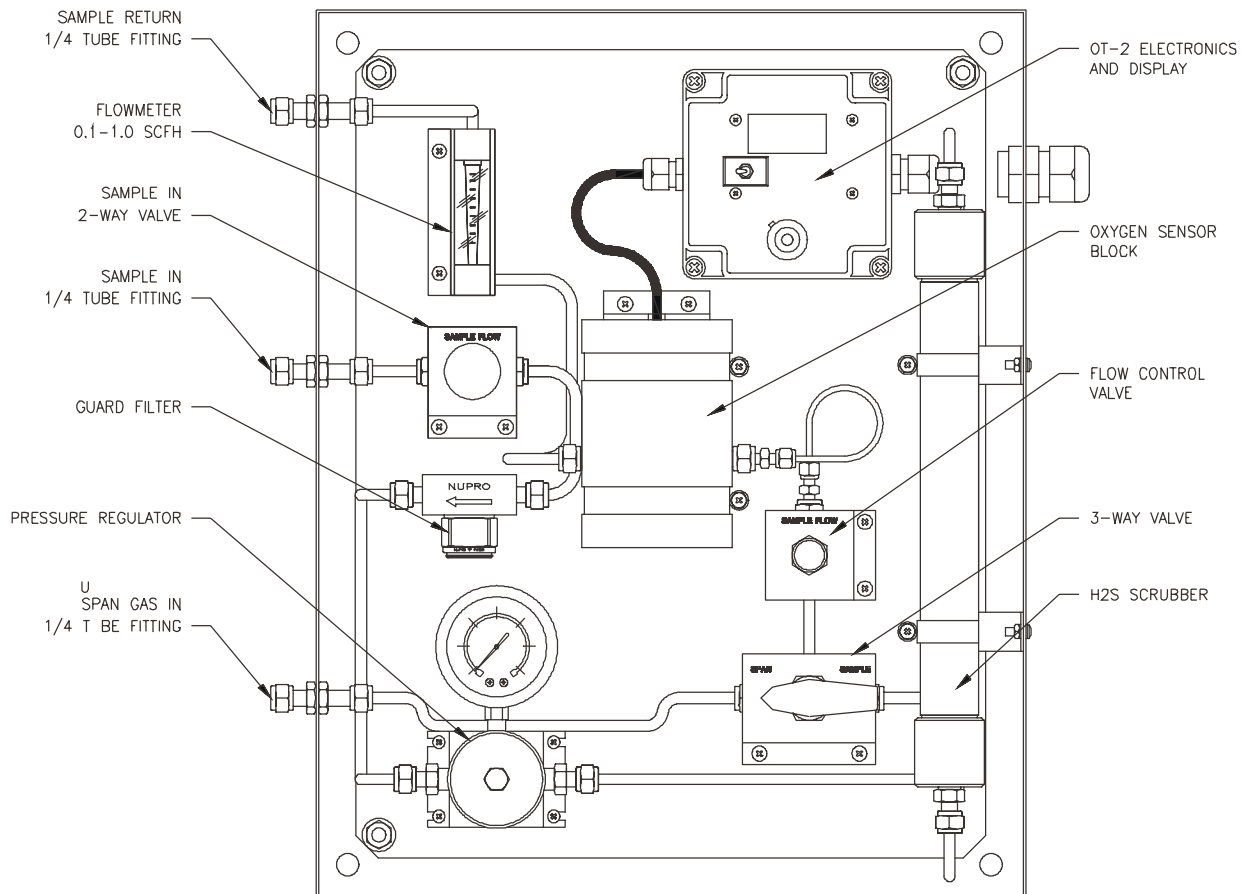

Figure 2-5 Piping Layout

Figure 2-5 is the Piping Layout of the sampling system. In the standard instrument, calibration gases (zero and span) are connected directly to the Span Gas In port by teeing to the port with appropriate valves. The sample gas is connected to the Sample Gas In port in the same manner as the Span Gas.



## Operation

---

Operation of the Model OT-2 System involves installing the unit, making appropriate sample gas connections, and calibration.

### 3.1 Installation

**WARNING:** *Safe operation of the system requires the user to properly ground the system, install the wiring and power the transmitter.*



**It is the user's responsibility to determine and install, should a safety barrier be required.**

Installation of the Model OT-2 System includes:

1. Unpacking
2. Mounting
3. Gas connections
4. Electrical connections
5. Installing the Micro-Fuel Cell
6. Testing the system.

#### 3.1.1 Unpacking the Analyzer

Carefully unpack the analyzer and inspect it for damage. Immediately report any damage to the shipping agent.

3.1.2 Mounting the Analyzer

The OT-2 System is designed for bulkhead mounting. Figure 3-1 is an illustration of the OT-2 System and mounting hole dimensions. There are four mounting holes—one in each of the inside corners of the rigid enclosure.

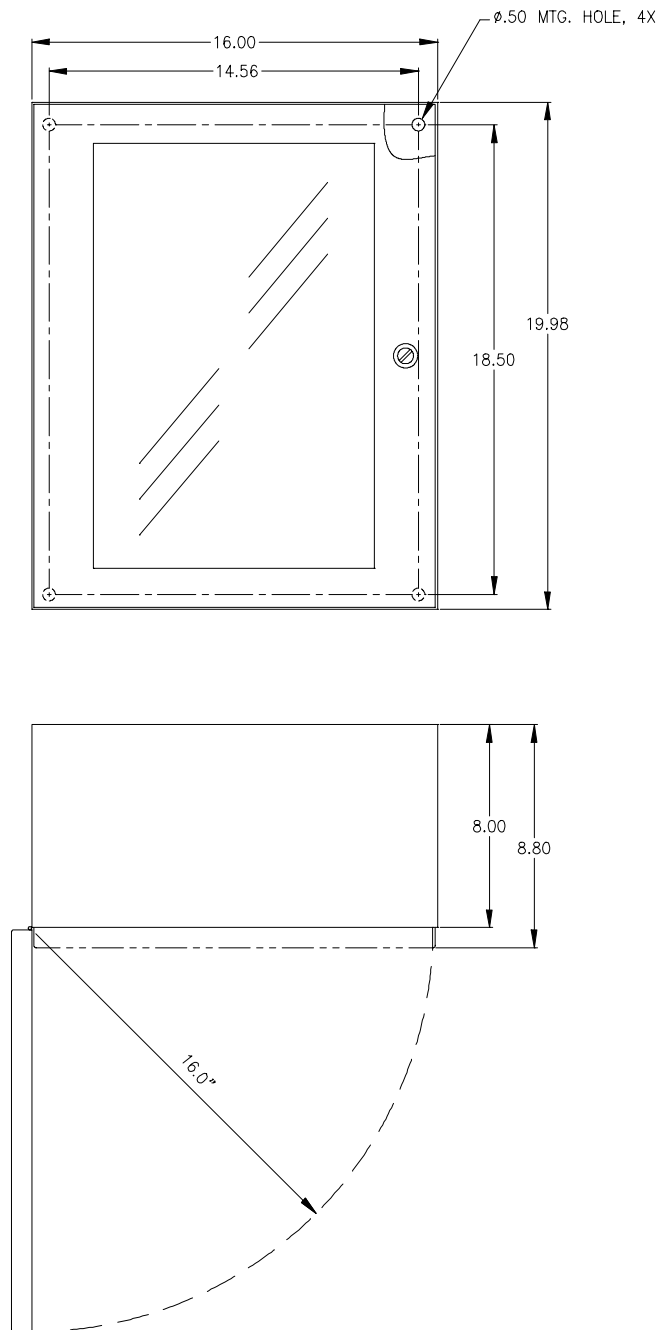

Figure 3-1 Mounting Details

All operator controls are located inside the system enclosure, which is hinged on the left edge and provides easy access to the transmitter, sensor and cell block inside the instrument. The main enclosure door will swing open when the slotted latch at the right center of the door is turned counter-clockwise. Allow clearance for the door to open in a 90-degree arc at a radius of 16 inches. See Figure 3-1.

### 3.1.3 System Connections

Figure 3-2 shows the Model OT-2 System. There are ports for gas inlet and outlet, power and analog concentration output.

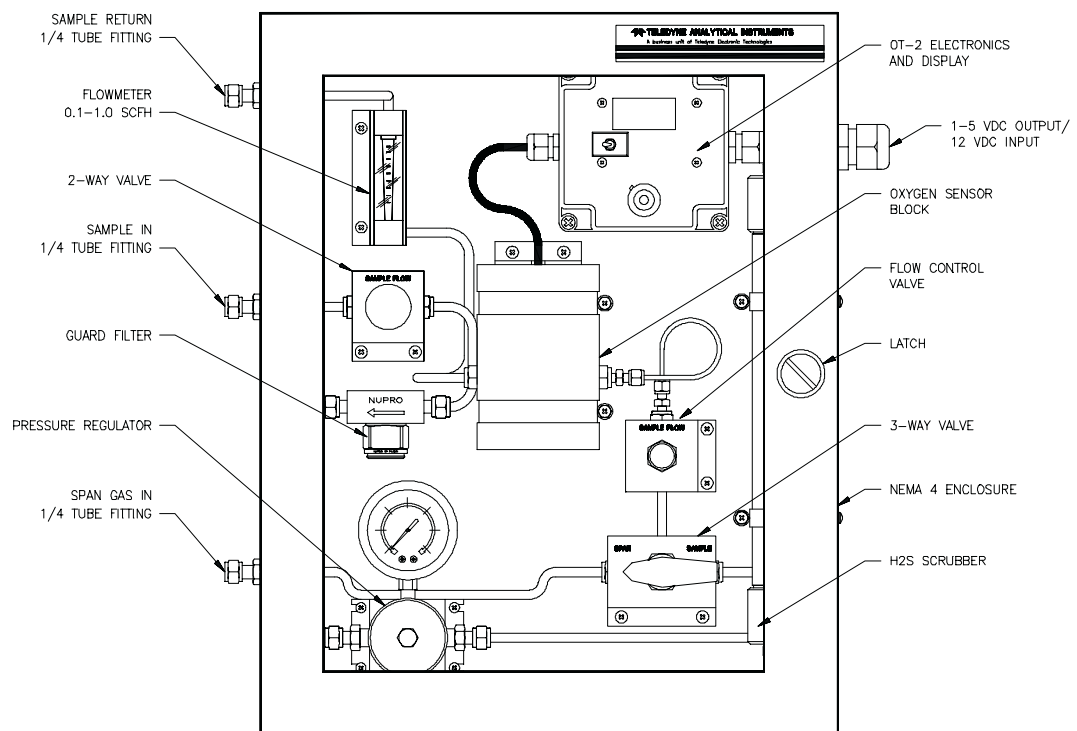

Figure 3-2 Front View of OT-2 System

#### 3.1.3.1 Gas Connections

The unit is manufactured with 1/4 inch tube fittings for system installations.

To connect gas lines to the Model OT-2 System:

1. Insert the tube into the tube fitting, and finger-tighten the nut until the tubing cannot be rotated freely, by hand, in the fitting. (This may require an additional 1/8 turn beyond finger-tight.)
2. Hold the fitting body steady with a wrench, and with another wrench rotate the nut another 1-1/4 turns.

***All gas connections, Sample In, Sample Return and Span Gas In are made at the connectors located on the left side of the system enclosure as shown in Figure 3-2.***

**SAMPLE IN:** The gas connection for the sample is made at the SAMPLE IN connector.

The internal gas pressure regulator is factory preset to approximately 3 psig which will keep the system flowmeter reading in an acceptable range (0.1-1 scfh). The sample in pressure can be 6-40 psig.

**SAMPLE RETURN:** Exhaust connections must be consistent with the hazard level of the constituent gases. Check Local, State, and Federal laws, and ensure that the exhaust stream vents to an appropriately controlled area if required.

**SPAN GAS IN:** This is the port for inputting span gas and zero gas. The span gas source should be regulated at 3 psig.

### 3.1.3.2 Electrical Connections

All electrical connections for the OT-2 System are made on a terminal blocks in the transmitter box located on the inside of the system enclosure, see Figure 3-3.

1. To access the terminal block remove the four screws securing the transmitter box cover and remove it.
2. Connect the 4 wires and shield to the terminal block as shown in Figure 3-4.
3. Replace the cover and screws.

For safe connections, ensure that no uninsulated wire extends outside of the connectors they are attached to. Stripped wire ends must insert completely into terminal blocks. No uninsulated wiring should be able to come in contact with fingers, tools or clothing during normal operation.

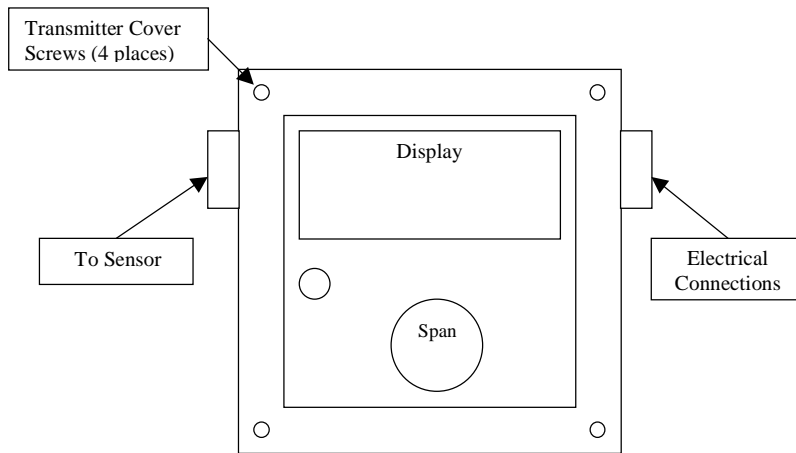

Figure 3-3 Front View of Transmitter

**System Power Requirements:**

The Model OT-2 System requires a 12 VDC (nominal), reverse polarity protected power source.



Observe good wiring practices. For hazardous area applications, the Model OT-2 System must be powered by a source that is consistent with intrinsically safe operation.

**Analog Outputs:**

1-5 VDC: Voltage increases linearly with increasing oxygen, from 1 VDC at 0 ppm to 5 VDC at full scale ppm.

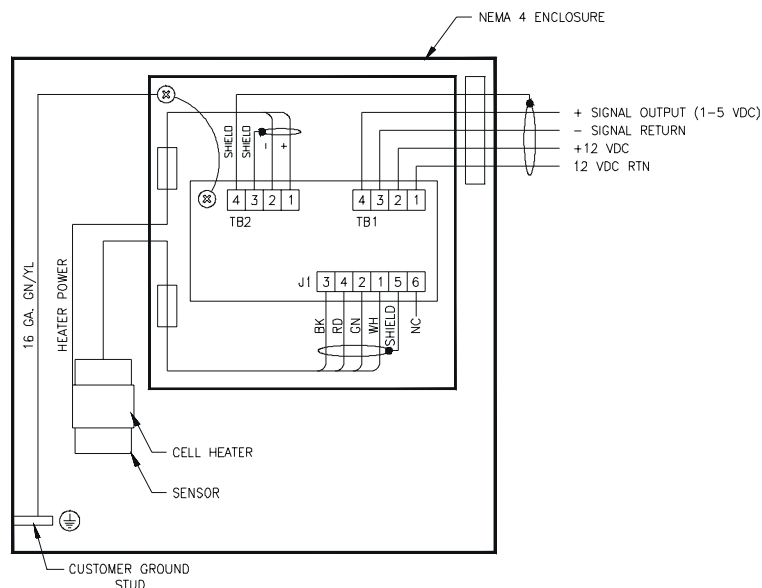

Figure 3-4: Transmitter Electrical Connections

## 3.2 Installing the Micro-Fuel Cell

The Micro-Fuel Cell is not installed in the cell block when the instrument is shipped. Install it before the analyzer is placed in service.

When the micro-Fuel Cell needs to be installed or replaced, follow the procedures in chapter 5, *Maintenance*, for removing and installing cells.

**Recommendation:** During installation, minimize the time the sensor is exposed to atmospheric oxygen, i.e. the time between removal of the sensor from the sealed bag to installation into the cell holder.

## 3.3 Calibration

The calibration process consists of:

- Connecting span gas to Span In Port
- Setting the span

Setting the span of the transmitter requires adjustment of the potentiometer located on the transmitter box.

The sensor will respond to changes in oxygen concentration immediately after installation. For maximum performance (accuracy and sensitivity) TET/AI recommends that the sensor be purged with a zero (0% oxygen) gas for about 24 hours after the sensor is installed and then calibrate with span gas with a value of approx. 80-100% of the analytical range of interest. The following sections describe the calibration procedure.

### 3.3.1 Calibration Gas Connections

Prior to installation of the O<sub>2</sub> cell, a zero gas (purge gas) containing less than 1 ppm O<sub>2</sub>, should be connected to the system and be ready to purge the O<sub>2</sub> cell. To facilitate spanning the zero and span gas source can be connected to a common manifold via a three way valve. This manifold then connects directly to the "Span Gas In" port on the system (Fig. 3-5). ***It is important that the operator bleeds any trapped air in the tubing prior to installation of the sensor to minimize the amount of atmospheric oxygen introduced into the system.***

**NOTE:** In order to minimize the time required to purge the cell after exposure to air, limit the time the cell is exposed to air to 1 minute or less, if possible.



The span gas cylinder must be equipped with a pressure regulator with a metallic diaphragm. The regulator should be set to approximately 3-5 psig. Rotate the selector valve (a) to the span position and observe the flow meter (b) which should indicate a flow of about 0.4 scfh. For calibration purposes the flow can be increased to as much as 1 scfh in order to reduce the time required to stabilize.

Allow the span gas to pass through the O<sub>2</sub> sensor until the reading has stabilized (approx. 10 min.). The O<sub>2</sub> transmitter can then be adjusted (see instructions elsewhere in this section) to match the analyzed content of the span gas. When the calibration is complete, return the selector valve (a) to the sample position and readjust the flow valve (c), (if necessary) so that flow meter (b) reads 0.4 scfh.

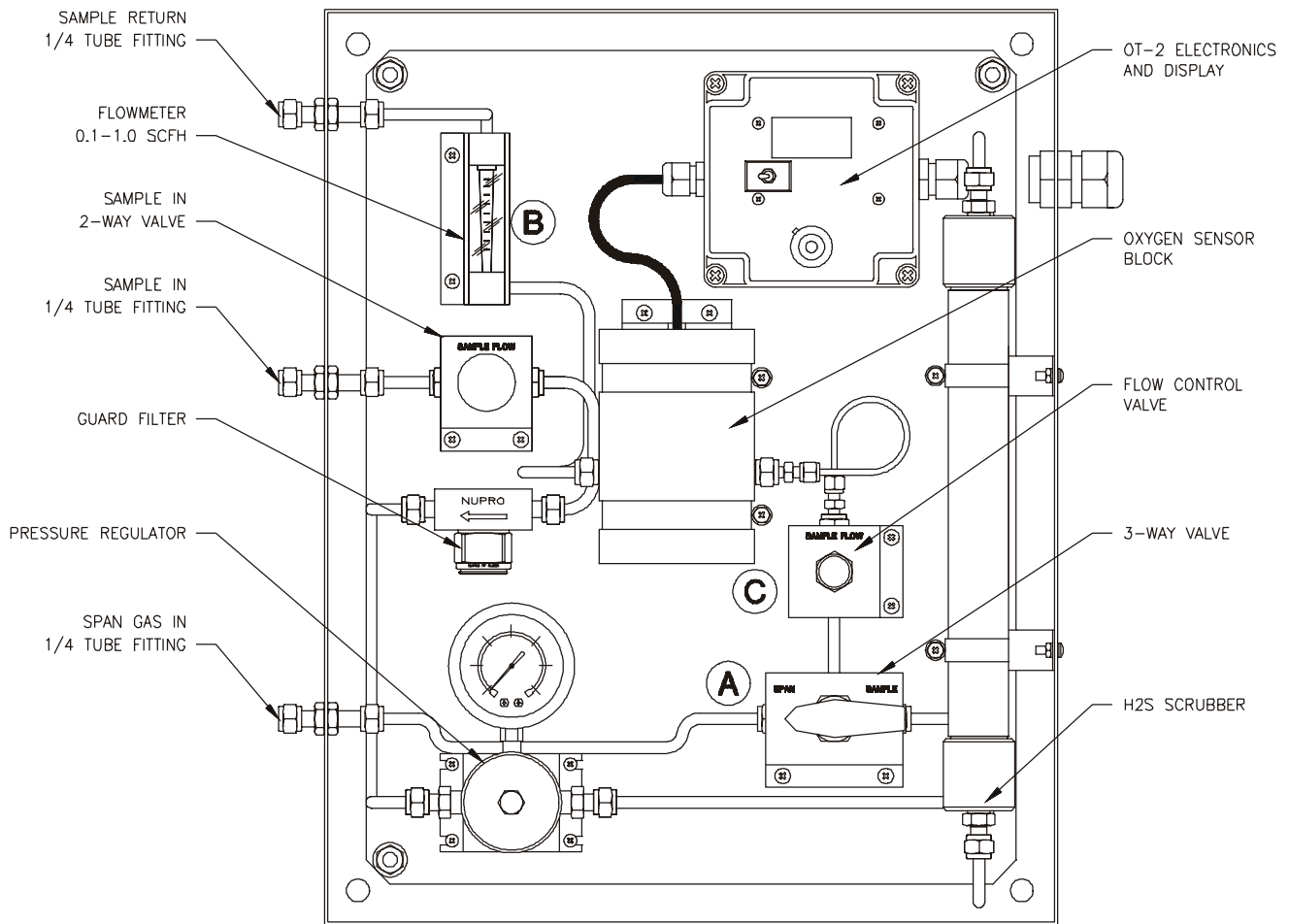
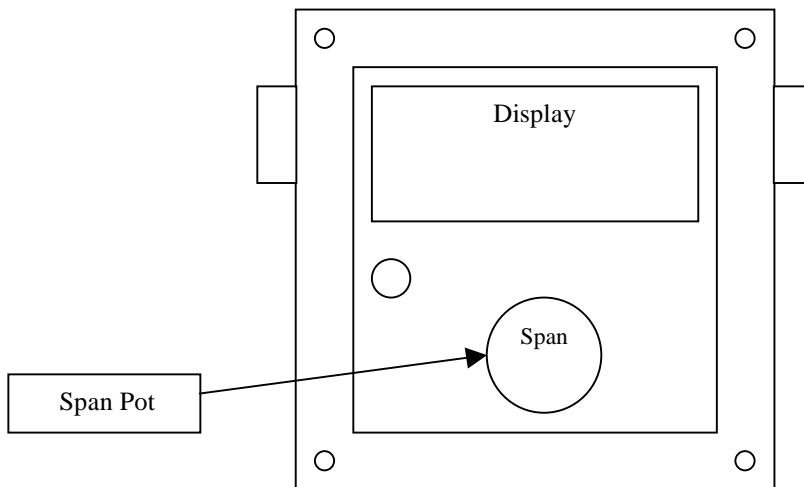

Figure 3-5 Sample System Component Locations

**NOTE:** This procedure is more critical on the 0-10 ppm range and less critical on the 0-100 or 0-1000 ppm range.

### 3.3.2 Setting the Span Pot

1. Switch the system from zero gas to span gas and allow time for stabilization.



*Figure 3-6: Span Pot Location*

**NOTE:** The span gas should have an O<sub>2</sub> concentration of 80% - 100% of full scale. For example, if the range is set at 0-100 ppm, the span gas should be a certified grade gas of about 90 ppm O<sub>2</sub> in N<sub>2</sub> or Argon.

2. If 90 ppm gas is used, adjust the span pot (Figure 3-6) to read 90.0 ppm on the LCD display. The output to the Elsag Baily Total Flow™ computer will have a signal of 4.6VDC (into a >10K ohm load).

The formula for this is:

$$\frac{\text{Span Gas \% F.S.} \times 4}{100} + 1 = \text{Output in VDC}$$

### 3.3.3 H<sub>2</sub>S Scrubber

The life expectancy of the stainless steel H<sub>2</sub>S scrubber, included in this system, is determined by the amount of H<sub>2</sub>S passing through it.

With the maximum concentration of 200 PPM H<sub>2</sub>S and a flow rate of 0.2 scfh the expected scrubber life will be over 6 months with Purifil® and over 11 months with Purifil® II.

This scrubber life expectancy increases with lower H<sub>2</sub>S concentration or gas sample flow rates. It is recommended that the flow rate be set no higher than 0.4 scfh initially. The flow rate should be increased only if a faster system response time is desired.

It is suggested that a spare scrubber be kept on hand and replaced every 6 months. When the scrubber needs to be replaced, follow the procedure in section 4, *Maintenance*, "Scrubber Replacement".



**WARNING: IF SCRUBBER IS NOT PROPERLY MAINTAINED THE O<sub>2</sub> SENSOR LIFE WILL BE SHORTENED.**

### 3.3.4 Exhaust/Vent Line (Sample Return)

It is recommended that a long vent line (approx. 4 ft.) be installed to the "Sample Return" connector at the side of the system enclosure. The extended vent line will minimize back diffusion from the atmosphere back to the sensor. The minimum recommended tubing diameter is 1/4" to minimize back pressure.

## 3.4 Testing the System

Before connecting the instrument into the power source:

- Check the integrity and accuracy of the gas connections. Make sure there are no leaks.
- Check the integrity and accuracy of the electrical connections. Make sure there are no exposed conductors.
- Check that inlet sample pressure is within the acceptable range (see section 3.3.1).
- Power up the system, and test it.



---

## Maintenance

---

### 4.1 Routine Maintenance

Aside from normal cleaning and checking for leaks at the gas connections, routine maintenance includes servicing the filter, the scrubber, installing replacement Micro-Fuel cells and recalibration. For recalibration, see section 3.3 *Calibration*.

### 4.2 Cell Replacement

The Micro-Fuel Cell is a sealed electrochemical transducer with no electrolyte to change or electrodes to clean. When the cell reaches the end of its useful life, it is replaced. The spent fuel cell should be discarded according to local regulations.

The characteristics of the Micro-Fuel Cell are similar to those of a mercury battery in that both provide an almost constant output (when the sensor is exposed to a constant level of oxygen) throughout their useful life, and then fall off sharply towards zero at the end. Cell failure, in the Model OT-2 System, will probably be indicated by the inability to properly span calibrate the transmitter, or excessively long response time to changes in oxygen concentration.

To ensure availability, TAI recommends that a spare cell be purchased shortly after the instrument is placed in service, and each time the cell is replaced.

The spare cell should be carefully stored in a cool, and near constant temperature, area if possible.

**NOTE:** Do not disturb the integrity of the cell package until the cell is to actually be used. If the cell package is punctured and has been exposed to atmospheric air over an extended period, the sensor may not function properly.



Power must be removed from the OT-2 prior to removing or installing the sensor.

To replace the cell: Figure 4-1

1. Open the enclosure door.
2. Undo the velcro straps.
3. Remove the insulation.
4. The cell block is located in the center of the unit. Unscrew the cap on the bottom of the cell block. The B-2C sensor should drop down once the cap is removed.

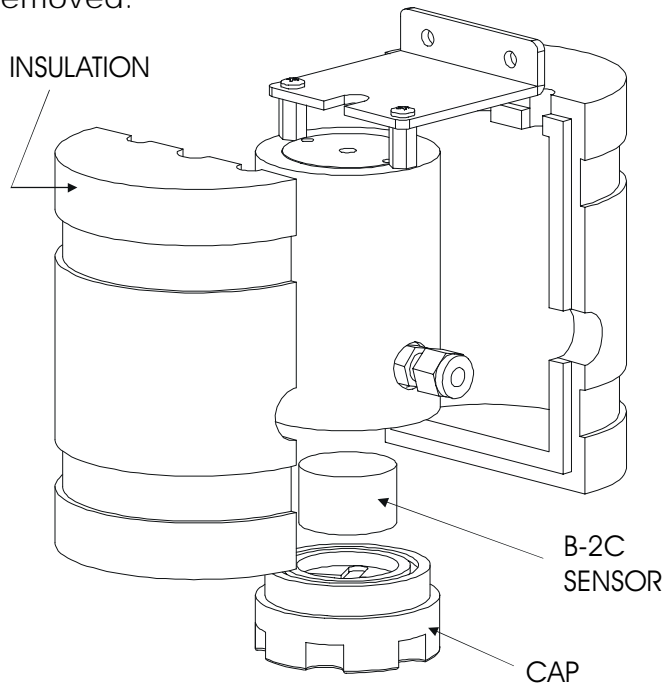

Figure 4-1 Cell Block

**NOTE:** Before the cell is removed from its package, a zero gas with low ppm oxygen flowing at a relative high rate through the cell block can lessen the time it will take the newly installed cell to drop to a zero reading.

3. Remove the new cell from its package, and carefully remove the shorting clip.

**WARNING:** *The sensor used in the Model OT-2 System uses electrolytes which may contain substances that are harmful if touched, swallowed, or inhaled. Avoid contact with ANY fluid or powder in or around the unit. What may appear to be plain water could contain one of these toxic substances. In case of eye contact, immediately flush eyes with water for at least 15 minutes. Call physician. {See Appendix - Material Safety Data Sheet (MSDS)}.*



4. Place the new cell on the cap with the sensing surface face down and the gold contact rings up.
5. Position the cell and cap so that the cell is inside the cell block. Press up on the cap and rotate. Tighten the cap screws.

#### 4.2.1 Cell Warranty

The cell warranty is sensor specific. Please contact Teledyne Electronic Technologies/ Analytical Instruments on explicit warranty on sensors.

**NOTE: Evidence of damage due to tampering or mishandling will render the cell warranty null and void.**

#### 4.3 Scrubber Replacement

To ensure proper operation of the OT-2 System, it is recommended to replace the scrubber every 6 months or more frequently if the sensor is reaching end of life prematurely.

It is important that the replacement of the scrubber be completed within one hour of it's removal to prevent back diffusion of oxygen from the atmosphere to the sensor.

During scrubber replacement, it is recommended that the 3-way valve is switched to "Span Gas". This will minimize the system recovery time.

**NOTE: If the sensor is exposed to air through back diffusion, from the atmosphere it may cause the sensor to re-stabilize slowly.**

#### 4.4 Filter Servicing

To ensure the proper performance and sample flow, it is recommended that the sample filter be inspected when the cell is replaced. The filter requires both a 1" and a 11/16" open end wrench to remove the filter bowl. Turn off the sample flow valve prior to servicing filter. The filter should be cleaned or replaced as required.





---

## Appendix

---

**Specifications:**

**System Enclosure:** NEMA 4 Rated, bulkhead mounted

**Power Requirements:** 9-16 VDC and 16-275mA.

**Ranges:** 0–10ppm and 0–100ppm Oxygen  
or 0-100 ppm and 0-1000 ppm O<sub>2</sub>.

**Accuracy:** ± 2% of full scale at constant temperature and pressure (temperature and pressure of calibration), except ± 1ppm on 0–10ppm range.  
± 5% of full scale over operating temperature range (once thermal equilibrium has been reached), except ± 1ppm on 0–10ppm range.

**Response Time (90%):** Sensor Response Time = 61 seconds @ 77°F (25°C).  
Overall system response time is flow rate dependent.

**Operating Temperature:** 5-113°F (-15–45°C)

**Stability:** ± 1% in 24 hours (at constant temperature)

**Reproducibility:** ± 1% of full scale at constant temperature

**Sensor Type:** Micro-Fuel Cell class B2C

*Optional (application dependent):* Micro-Fuel Cell class A2C if CO<sub>2</sub> concentration consistently exceeds 1000 ppm.

**Signal Output:** 1-5 VDC

**Recommended Spare Parts List**

<b>Qty.</b>	<b>Part Number</b>	<b>Description</b>
1	C71345A & C71345B	Cell Block Insulation Set
1	C70976B	PC Board — 1-5V Transmitter (0-100/0-1000 ppm)
1	C70976A	PC Board — 1-5V Transmitter (0-10/0-100 ppm)
1	B71343	Scrubber Assembly (complete)
1	P396	Scrubber Material
1	C6689-B2C	Micro-Fuel Cell B2C Class
1	C6689-A2C	Micro-Fuel Cell A2C Class
1	F688	Filter
1	H517	Heater
1	C71272	Cell Holder Assembly

A minimum charge is applicable to spare parts orders.

**NOTE:** Orders for replacement parts should include the part number (if available ) and the model and serial number of the instrument for which the parts are intended.

Orders should be sent to:

**Teledyne Analytical Instruments**

16830 Chestnut Street  
 City of Industry, CA 91749-1580  
 Phone (626) 934-1500, Fax (626) 961-2538  
 TWX (910) 584-1887 TDYANLY COID

Web: [www.teledyne-ai.com](http://www.teledyne-ai.com)

or your local representative

**Drawing List**

- C71020 Outline Diagram
- B71018 Interconnection Diagram
- D70975 Schematic — 1-5V Transmitter
- B71019 Piping Diagram

---

**Material Safety Data Sheet**
**Section I – Product Identification**

**Product Name:** Micro-Fuel Cells  
 Mini-Micro-Fuel Cells, all classes  
 Super Cells, all classes except T-5F  
 Electrochemical Oxygen Sensors, all classes.

**Manufacturer:** Teledyne Analytical Instruments  
**Address:** 16830 Chestnut Street, City of Industry, CA  
 91749  
**Phone:** (626) 934-1500  
 Date Prepared or Last Revised: 08/08/91  
 Emergency Phone Number: (626) 934-1500

**Section II – Physical and Chemical Data**

Chemical and Common Names:	Potassium Hydroxide (KOH), 15% (w/v) Lead (Pb), pure	
CAS Number:	KOH 1310-58-3 Pb 7439-92-1	
Melting Point/Range:	<b>KOH (15%)</b> -10 to 0 °C	<b>Pb (pure)</b> 328 °C
Boiling Point/Range:	100 to 115 °C	1744 °C
Specific Gravity:	1.09 @ 20 °C	11.34
pH:	>14	N/A
Solubility in Water:	Completely soluble	Insoluble
Percent Volatiles by Volume:	None	N/A
Appearance and Odor:	Colorless, odorless solution	Grey metal, odorless

---

**Section III – Physical Hazards**

**Potential for fire and explosion:** The electrolyte in the Micro-Fuel Cells is not flammable. There are no fire or explosion hazards associated with Micro-Fuel Cells.

**Potential for reactivity:** The sensors are stable under normal conditions of use. Avoid contact between the sensor electrolyte and strong acids.

**Section IV – Health Hazard Data**

**Primary route of entry:** Ingestion, eye/skin contact  
**Exposure limits:** OSHA PEL: .05 mg./cu.m. (Pb)  
ACGIH TLV: 2 mg./cu.m. (KOH)

**Effects of overexposure**

**Ingestion:** The electrolyte could be harmful or fatal if swallowed.

Oral LD50 (RAT) = 3650 mg./kg

**Eye:** The electrolyte is corrosive; eye contact could result in permanent loss of vision.

**Dermal:** The electrolyte is corrosive; skin contact could result in a chemical burn.

**Inhalation:** Liquid inhalation is unlikely.

**Signs/symptoms of exposure:** Contact with skin or eyes will cause a burning sensation and/or feel soapy or slippery to touch.

**Medical conditions**

**aggravated by exposure:** None

**Carcinogenicity:** NTP Annual Report on Carcinogens: Not listed  
LARC Monographs: Not listed  
OSHA: Not listed

**Other health hazards:** Lead is listed as a chemical known to the State of California to cause birth defects or other reproductive harm.

---

**Section V – Emergency and First Aid Procedures**

- Eye Contact:** Flush eyes with water for at least 15 minutes and get immediate medical attention.
- Skin Contact:** Wash affected area with plenty of water and remove contaminated clothing. If burning persists, seek medical attention.
- Ingestion:** Give plenty of cold water. Do not induce vomiting. Seek medical attention. Do not administer liquids to an unconscious person.
- Inhalation:** Liquid inhalation is unlikely.

**Section VI – Handling Information**

**NOTE:** The oxygen sensors are sealed, and under normal circumstances, the contents of the sensors do not present a health hazard. The following information is given as a guide in the event that a cell leaks.

**Protective clothing:** Rubber gloves, chemical splash goggles.

**Cleanup procedures:** Wipe down the area several times with a wet paper towel. Use a fresh towel each time.

**Protective measures**

**during cell replacement:** Before opening the bag containing the sensor cell, check the sensor cell for leakage. If the sensor cell leaks, do not open the bag. If there is liquid around the cell while in the instrument, put on gloves and eye protection before removing the cell.

**Disposal:** Should be in accordance with all applicable state, local and federal regulations.

**NOTE:** The above information is derived from the MSDS provided by the manufacturer. The information is believed to be correct but does not purport to be all inclusive and shall be used only as a guide. Teledyne Analytical Instruments shall not be held liable for any damage resulting from handling or from contact with the above product.



## Free Manuals Download Website

<http://myh66.com>

<http://usermanuals.us>

<http://www.somanuals.com>

<http://www.4manuals.cc>

<http://www.manual-lib.com>

<http://www.404manual.com>

<http://www.luxmanual.com>

<http://aubethermostatmanual.com>

Golf course search by state

<http://golfingnear.com>

Email search by domain

<http://emailbydomain.com>

Auto manuals search

<http://auto.somanuals.com>

TV manuals search

<http://tv.somanuals.com>