

326X SERIES MODEM Modem Cards, Backplanes, and Modular Nest 9 and 21 Enclosures

In This Notice	Topic	See Page
	Introduction	2
	About the 326X Series Modem Documentation Set.....	2
	For More Details on the 326X Modem's.....	2
	Safety Information.....	3
	Warning Description	3
	Connecting Port Warning	3
	Installation Warning	4
	Pre-Installation Information and Activities	5
	326X Series Modem Cards and Backplanes	5
	326X Series Modem Cards.....	5
	326X Series Modem Card Backplanes	5
	Stand-alone Modems and Enclosure Cards: Differences.....	6
	A/B Switching and the A/B LED	6
	ALM LED.....	6
	Telephone Company Compliance—U.S.A. Models	7
	Backplane Jumpers for the Busy Out Feature.....	7
	Hong Kong and the United Kingdom	7
	Countries That Support Busy Out.....	8
	How and When is Make Busy Activated?.....	8
	Setting the Modem Card DIP Switch.....	12
	Cabling the 3262 and the 3267 (Dual Dial) Modem Cards	14
	Cabling the 3263 and the 3268 (Leased Line, Dial Restoral) Modem Cards	15
	Attaching Ferrite Beads (U.S.A., Canada, and Japan Only).....	16
	Removing Audio Cable Connectors From a Modem Backplane.....	16
	326X Series Modem—Cabling to a Network Manager.....	18
	Setting Control Across Groups	22
	Example	22
	Cautions and Limitations for Network Management Cabling.....	23
	Daisy-Chaining NC Ports: Card Modems to Stand-alone Modems	24
	Preparing the 9110 DMS for 326X Series Card Modems	26
	326X Modem Card Power Supply Requirements in 21-Card Enclosure..	26
	Removing and Installing a Backplane in Modular Nest 9 or 21 Enclosure ..	27
	Removing a 326X Backplane.....	28
	Installing or Replacing a 326X Backplane.....	30

Overview

This document covers:

- Information you need and activities you must complete *before* installing and operating 326X Series Modem card(s) in the Modular Nest 9 and 21 Enclosure
- Procedures for *removing and replacing a* backplane installed in a Modular Nest 9 or 21 enclosure
- A procedure for *testing* a backplane for proper installation and connection

Use this information with the *Modular Nest 9 and 21 Operations and Installation Guide* (Part No. TEL-09564), shipped with the Modular Nest 9 and 21 enclosure, which explains how to install, operate and maintain the enclosure. It also provides instructions for installing and removing product cards from the enclosure.

Introduction

This notice provides information about new features and enhancements available with 326X Series Modem cards and backplanes.

About the 326X Series Modem Documentation Set

The following documentation is shipped with your 326X Series Modem (stand-alone and card units):

- *326X Series Modem User's Guide* (Part No. TEL-T0009)
- *326X Series Modem Reference Card* (Part No. TEL-T0009-01)

For More Details on the 326X Modem's...

- Configuration options (and equivalent AT commands)
- V.25 bis Automatic-Calling Unit
- NetView's LPDA-2 dialing commands
- Diagnostic tests

...refer to the *326X Series Modem Reference Guide*, which you can order through your Telenetics sales representative or local distributor.

Safety Information

This section explains how **Warning** Notices are used in Telenetics' documentation, and it provides such notices for users of the 326X Series Modem.

Warning Description

The following notice emphasizes certain information. In documentation, it is displayed in the format shown:



Warning

Warning is the most serious notice, indicating that you can be physically hurt.

Un avertissement constitue le message le plus sérieux, indiquant que vous pouvez subir des blessures corporelles.

Eine Warnung ist der ernsthafteste Hinweis auf Körperverletzungsgefahr.

Connecting Port Warning



Warning

Ports that are capable of connecting to other apparatus are defined as SELV. To ensure conformity with EN60950, ensure that these ports are only connected to ports of the same type on other apparatus.

Les ports qui sont susceptibles d'être connectés à des équipements sont désignés comme TBTS. Pour garantir la conformité à la norme EN 60950, n'interconnecte ces ports qu'avec des ports du même type sur des autres matériels.

Anschlüsse, die mit anderen Geräten verbunden werden können, sind als SELV beschrieben. Um Konformität mit EN 60950 zu versichern, versichern Sie, daß diese Anschlüsse nur mit denen der selben Type auf anderen Geräten verbunden werden.

Installation Warning



Warning

All Telenetics devices should be used in environments designed for computers and electronic equipment. In areas susceptible to lightning, take precautions to prevent damage to electronic equipment. Contact your telephone company, or an electronic accessories vendor, for information on lightning protection equipment. Customers experiencing problems caused by surges from lightning have eliminated such problems by installing appropriate surge suppressors on power and data lines connected to Telenetics devices.

Tous les dispositifs Telenetics doivent être utilisés dans des environnements conçus pour des ordinateurs et du matériel électronique. Dans les zones susceptibles d'être frappées par la foudre, prenez des précautions pour éviter que le matériel électronique soit endommagé. Contactez votre compagnie téléphonique, ou un vendeur d'accessoires électroniques, pour obtenir des renseignements concernant les systèmes de protection contre la foudre. Certains usagers confrontés à des problèmes causés par des sautes de tension dues à la foudre ont éliminé ces problèmes en installant des régulateurs de tension appropriés sur les câbles électriques et les câbles de données reliés aux dispositifs Telenetics.

Telenetics-Geräte sind grundsätzlich in für Rechner und elektronische Anlagen vorgesehenen Umgebungen zu verwenden. In unwettergefährdeten Bereichen ist jegliche Elektronik gegen Blitzeinwirkung zu schützen. Näheres über entsprechende Schutzeinrichtungen erfahren Sie von Ihrer Telefongesellschaft oder einem Elektrohändler. Probleme mit Spannungsstößen durch Blitzeinwirkung lassen sich durch Einbau von Überspannungsableitern in die zu Telenetics-Geräten führenden Netz- und Datenleitungen beheben.

Pre-Installation Information and Activities

This section provides information about 326X Series Modem card models 3262, 3263, 3267 and 3268. It describes activities you must complete *before* installing and operating 326X Series Modem card(s) in a Modular Nest enclosure.

326X Series Modem Cards and Backplanes

This section describes 326X Series Modem cards and backplanes, and items shipped with them.

326X Series Modem Cards

326X Series Modem cards can be:

- **Dial modem** —two modems on a card, 2-wire leased line or dial (Model 3262 or 3267)
- **Leased line modem with dial restoral**—2-/4- wire leased line or 2-wire dial (3263 or 3268)

With each modem card, you receive:

- Audio cables for connecting to the dial and leased line

Optionally, you receive:

- Two audio cables with ferrite beads (U.S.A., Japan, and Canada only)
- Modular connector blocks (Japan only)

Refer to the *326X Series Modem User's Guide*, Appendix C, Country-Specific Information, for a description of the cables that meet your country's requirements.

326X Series Modem Card Backplanes

326X Series Modem card backplanes can be:

- 1-card/2-slot
- 9-card/10-slot
- 21-card/21-slot (for 21-slot enclosure only)

With each 326X Series Modem card backplane, you receive:

- One *326X Series Modem User's Guide* (Part No. TEL-T0009)
 - One *326X Series Modem Reference Card* (Part No. TEL-T0009-01)
 - Four cable clamps
-

Stand-alone Modems and Enclosure Cards: Differences

The 326X Series Modem card front panel differs from that of the stand-alone 326X Series Modem. As shown in Figure 1, the 3262, 3263, 3267, and 3268 Modem cards have **eight** front-panel LEDs. Stand-alone 326X Series Modems do *not* have two of these:

- A/B LED
- ALM LED

These two LEDs are described here.

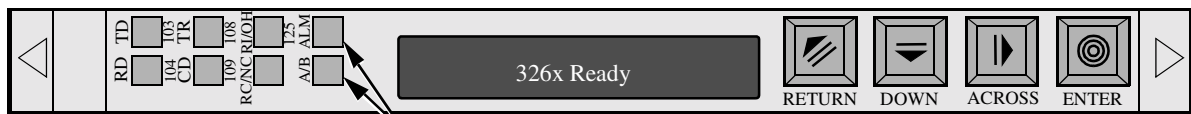



The A/B and ALM LED's are not featured in stand-alone modems.

Figure 1. 326X Series Modem Card Front Panel

A/B Switching and the A/B LED

With the 3262 and the 3267 Modem card (dial-only), two modems (A and B) share a single card and front panel. One modem controls the front panel display and LEDs at a time. The A/B LED indicates which front panel display and LEDs you are currently viewing. When the **A/B LED is:**



- *Lit (green)*, **modem A** front panel information is being displayed
- *Not lit*, **modem B** front panel information is being displayed

To toggle between the displays, hold down , and press .

Since the 3263 and the 3268 Modem cards (leased line with dial restoral) contain only one modem, the A/B LED is always lit (green).

ALM LED

The ALM LED lights (yellow) when a test is in progress or a modem failure occurs. With the Dual Dial Modem card, if one modem fails or is being tested, the ALM LED lights and remains lit regardless of which modem front panel is displayed.

To find out which modem failed, toggle between the front panels of modems A and B by holding down , and pressing . The failed modem displays:

ERRORxxx

■Note

If modem A has control and the network manager puts modem B into test mode, modem B's ALM LED lights.

Telephone Company Compliance—U.S.A. Models

The Telenetics 326X Series Modem complies with Part 68 of the FCC rules. The modem card includes a label with the FCC registration number for this equipment. If requested by the telephone company, you must provide this information. Generally, the ringer equivalence number (REN) is also requested for telephone equipment. The REN is listed on the FCC registration label.

The REN is used to determine the number of devices that can be connected to the telephone line. Excessive RENs on the telephone line may result in the devices not ringing in response to an incoming call. The sum of the RENs should not exceed five. To be certain of the number of devices that can be connected to the line, contact the telephone company to determine the maximum REN for the calling area.

NOTE: The telephone company may make changes in its facilities, equipment, operations, or procedures that could affect equipment operation. If this happens, the telephone company will notify you in advance so that you can make the necessary modifications to maintain uninterrupted service.

This equipment uses the following USOC jacks: RJ11C, RJ16C, RJ45S, RJ4MB, and for the leased line, JM8.

Refer to the *326X Series Modem User's Guide*, Appendix C, Country-Specific Information, for regulatory agency information for your country.

Backplane Jumpers for the Busy Out Feature

This section applies to countries that use the "Universal International" (UI) Modular Nest enclosure backplane.

This section also is of interest to users in Hong Kong and the United Kingdom.

Hong Kong and the United Kingdom

IMPORTANT: *In Hong Kong and the United Kingdom, do not install a 3268 or 3268FAST Modem (leased line with dial restoral) in a Busy Out backplane. The modem will not function.*

In Hong Kong and the United Kingdom, Busy Out backplanes are hard-wired for Busy Out operation. These backplanes do not use pin jumpers.

Countries That Support Busy Out

Some backplanes have a Busy Out feature and are intended for use with dial modems (models 3262 and 3267). In some countries, leased modems (models 3263 and 3268) use Busy Out for dial restoral. The following table shows which countries use the Busy Out feature.

Countries that Support the Busy Out Option

<i>Country</i>	<i>3262 and 3267</i>	<i>3263 and 3268</i>
Australia	Yes	Yes
Belgium	Yes	Yes
Canada	Yes	No
Denmark	Yes	Yes
Hong Kong	Yes	No*
Ireland	Yes	Yes
Sweden	Yes	Yes
Switzerland	Yes	Yes
United Kingdom	Yes	Yes*
United States	Yes	Yes
All Others	No	Yes

How and When is Make Busy Activated?

Make Busy versions of Modular Nest 9 and Modular Nest 21 **backplanes** (which install in a Modular Nest enclosure with card modems) come equipped with the **Busy Out** feature. This feature causes a Busy Out modem to “appear busy” to the central office when:

- Power is disconnected from the Modular Nest enclosure
- The modem card is not present in its slot
- **Busy Out=ON** (the option is set through the front panel menu, the AT ACU, or a network manager)

Busy Out is intended for use with Model 3262 and 3267 **dial** modems. In some countries, it is also used in **dial-restoral mode** on Model 3263 and 3268 **leased line** modems.

Pre-Installation Information and Activities

Make Busy backplanes are factory configured for Busy Out operation in their destination country, as indicated in Table 1 or Table 2.

Table 1. Backplane Pin Settings for Busy Out, Modular Nest 9

Pin Pair	Function	U. S. A. and Canada:	Other UI Countries:
Left ¹	TIP and RING	No jumper connector	Connected with jumper
Right ¹	Make Busy and Make Busy 1	Connected with jumper	No jumper connector; not applicable

¹Inner backplane surface, as viewed from the rear of the Modular Nest.

Table 2. Backplane Pin Settings for Busy Out, Modular Nest 21

Pin Pair	Function	U. S. A. and Canada:	Other UI Countries:
Left ¹	Make Busy and Make Busy 1	Connected with jumper	No jumper connector; not applicable
Right ¹	TIP and RING	No jumper connector	Connected with jumper

¹Inner backplane surface, as viewed from the rear of the Modular Nest.



Warning

Only **qualified service personnel** should remove pin jumpers. A qualified service person is one who is familiar with product operation, trained in the technology of electrically powered information processing and business equipment and adequately aware of the hazards associated with this equipment. Removal by unqualified personnel could result in **personal injury** or **equipment damage**, which could jeopardize your warranty and maintenance agreement. Users who are not qualified to perform this action themselves should contact Telenetics or an authorized distributor regarding available upgrade services.

Seul un **personnel qualifié** est autorisé à enlever les cavaliers. Nous appelons qualifiée toute personne familière avec le fonctionnement du produit, ayant suivi une formation dans la technique du traitement de l'information et des équipements de bureau par système électrique et connaissant les dangers liés à ces équipements. Le recours à un personnel non qualifié pour cette opération risque d'entraîner des **dommages corporels et matériels** ainsi que l'invalidité éventuelle du contrat de garantie et de maintenance. Nous conseillons aux utilisateurs non qualifiés pour effectuer cette procédure de contacter Telenetics ou un distributeur agréé pour obtenir une liste des services de mise à jour disponibles.

Pre-Installation Information and Activities

Kontaktstiftüberbrückungen sollten nur von **qualifiziertem Kundendienstpersonal** entfernt werden. Ein qualifizierter Kundendiensttechniker ist vertraut mit dem Betrieb des Produkts, ausgebildet für die Technologie der mit Strom versorgten Datenverarbeitung und Unternehmensgeräten sowie informiert über die Gefahren, die von diesen Geräten ausgehen können. Werden diese Komponenten von unqualifiziertem Personal entfernt, kann dies **Verletzungen von Personen** oder **Geräteschäden** zur Folge haben und Ihre Garantie- und Wartungsvereinbarung gefährden. Anwender, die keine Berechtigung zum Durchführen dieses Vorgangs besitzen, sollten Upgradedienste von Telenetics oder einem autorisierten Händler anfordern.

Pre-Installation Information and Activities

Refer to Figure 2, which shows pin locations on Modular Nest 21 backplanes. Modular Nest 9s have a similar layout.

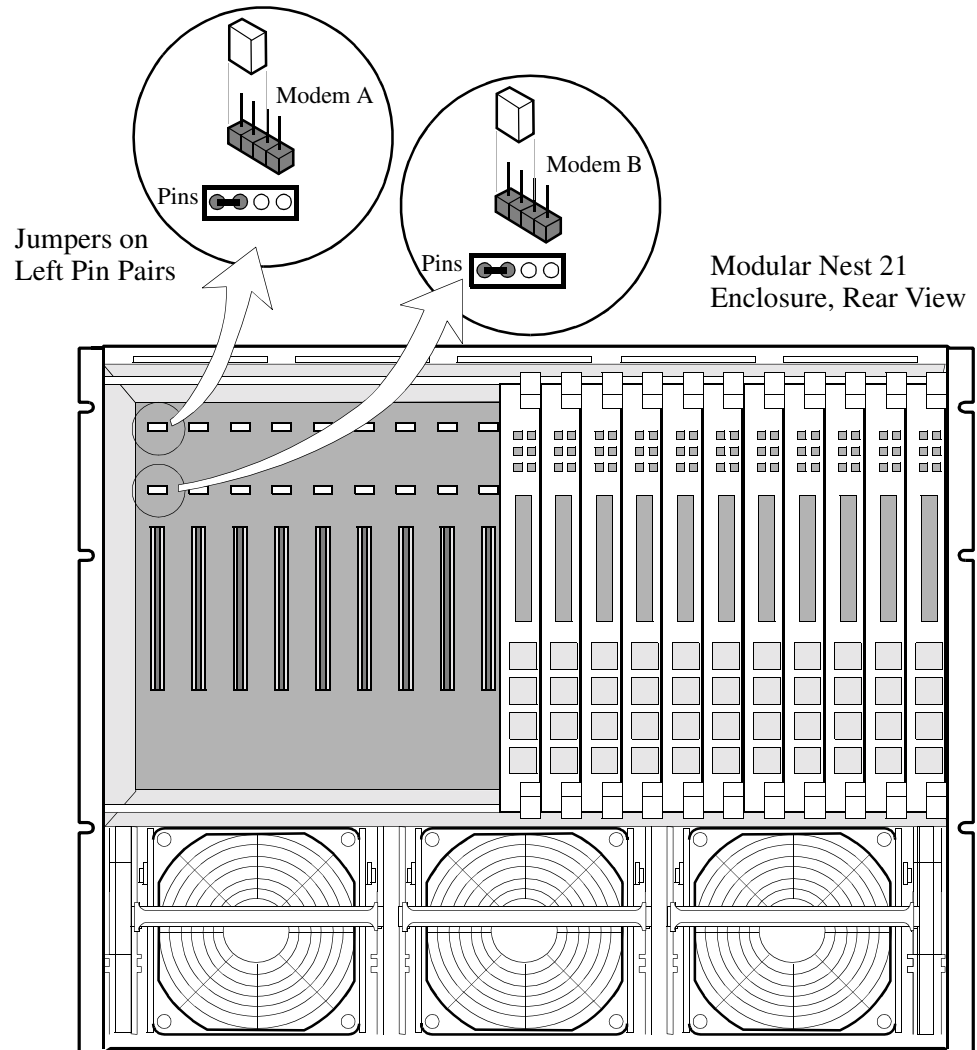

Figure 2. Modular Nest Backplane Pin Locations (Modular Nest 21 Shown)



Caution

If you use a 3263 or 3268 (leased line with dial restoration) modem card with a Busy Out backplane, *remove* jumpers from all four pins, or the modem in that slot will not operate properly. These cards do not support Busy Out.

Setting the Modem Card DIP Switch

An 8-position DIP (Dual Inline Package) switch on the modem card functions the same as the rear panel DIP switch on stand-alone modems.

The switches are numbered from left to right on the card (Figure 3). You must set the DIP switch *before installing the card*. Table 3 lists the switches and explains their use. Open (Off) is the factory default for the switches.

The references “Modem A” and “Modem B” in refer to the dual modem capability of models 3262 and 3267. See “A/B Switching and the A/B LED.”

NOTE: Switches 7 and 8 apply only to Models 3262 and 3267 (dial-only). Though Switches 7 and 8 appear on Models 3263 and 3268 (leased line with dial restoral), they are not connected and have no function.

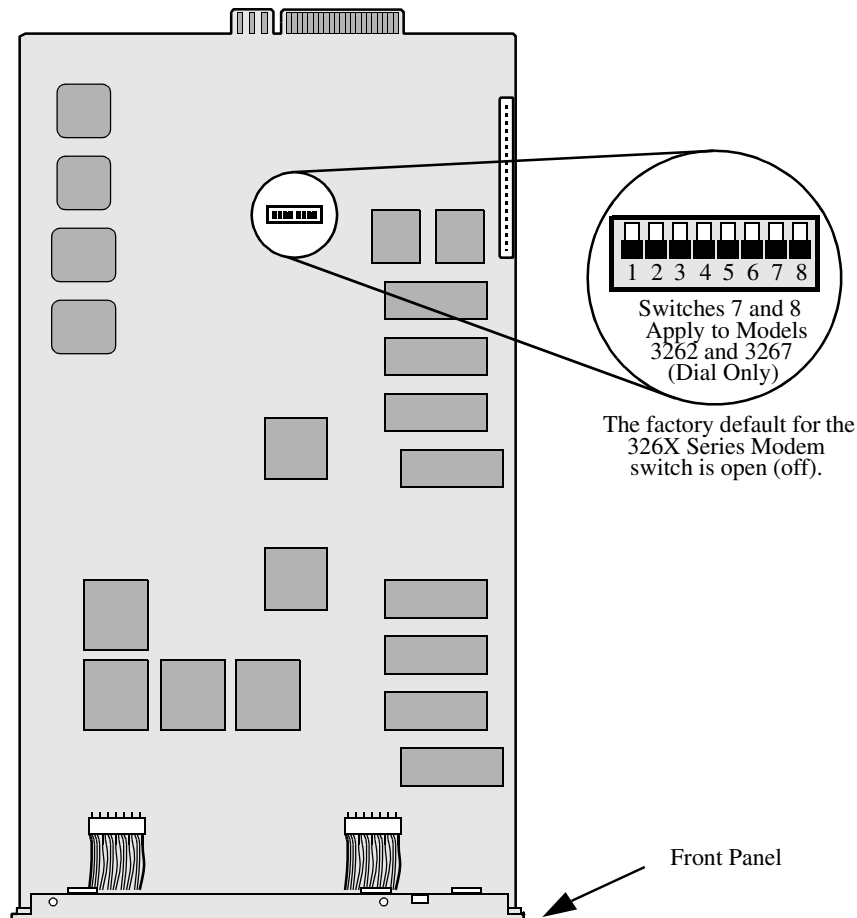

Figure 3. Locating Eight-Position DIP Switch

Table 3. Modem Rear Panel DIP Switch Functions

Switch Number	Setting	Function
1 (Modem A <i>only</i>) 7 (Modem B <i>only</i>)	Off	EIA/TIA 232-D pin 23 is set for data rate input. Setting Switch 1 or 7 to this position has no effect on modem operation.
	On	EIA/TIA 232-D pin 23 is set as a data indicator.
2 (Modem A <i>only</i>) 8 (Modem B <i>only</i>)	Off	Busy Out Select. A signal on EIA/TIA 232-D Pin 25 makes the modem appear busy to incoming calls.
	On	Test Indicator Signal (V.24 Circuit 142) Select. The modem sends a signal to the terminal on EIA/TIA 232-D Pin 25 (V.24 Circuit 142) when a test is in progress.
3 (Modems A and B)	Off	Front panel enable. The front panel functions normally.
	On	Front panel disable. You can check only status displays. NOTE: If your modem is under remote configuration control by another 326XSeries Modem, the controlling modem retains front-panel control of your modem.
4 (Modems A and B)	Off	Normal password protection applies.
	On	This reinitializes the modem to its factory settings. Use this when you forget your password, to unlock the modem from password protection.
5 (Modems A and B)	Off	AT and V.25 bis command sets can be used from an attached terminal.
	On	AT and V.25 bis command sets cannot be used from an attached terminal. NOTE: If your modem is under remote configuration control by another 326X Series Modem, the controlling modem retains AT ACU control.
6 (Modems A and B)	Off	Factory use only.

Cabling the 3262 and the 3267 (Dual Dial) Modem Cards

Refer to Figure 4 for cabling of 3262 and 3267 (dual dial) Modem cards. Interface and cabling pin-outs vary by country.

Refer to the *326X Series Modem User's Guide*, Appendix C, Country-Specific Information, for interface and cable pin-outs. For DTE and Network Control Port interface pin-outs, refer to Appendix B, Interface Pin-outs, of that guide.

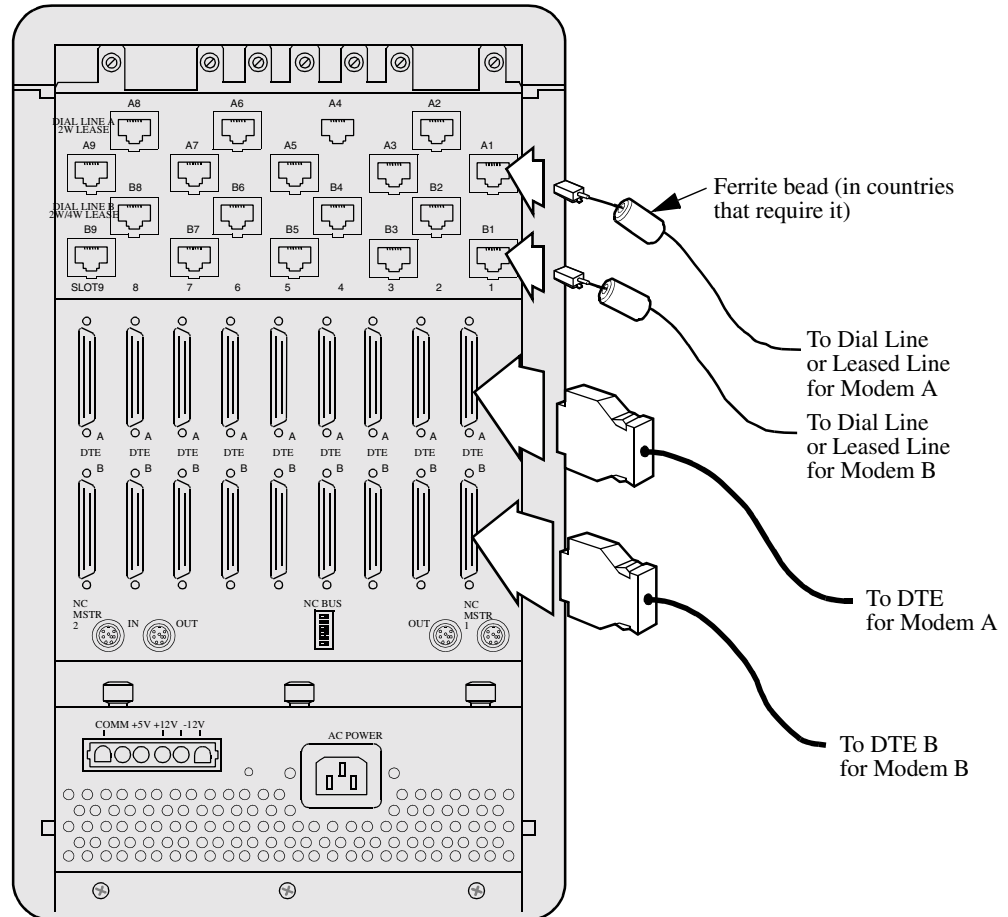

Figure 4. Cabling the 3262 and the 3267 (Dual Dial) Modem Cards

Pre-Installation Information and Activities

Cabling the 3263 and the 3268 (Leased Line, Dial Restoral) Modem Cards

Refer to Figure 5 for cabling of 3263 and 3268 (leased line with dial restoral) Modem cards. Interface and cabling pin-outs vary by country.

Refer to the *326X Series Modem User's Guide*, Appendix C, Country-Specific Information, for interface and cable pin-outs. For DTE and Network Control Port interface pin-outs, refer to Appendix B, Interface Pin-outs, of that guide.

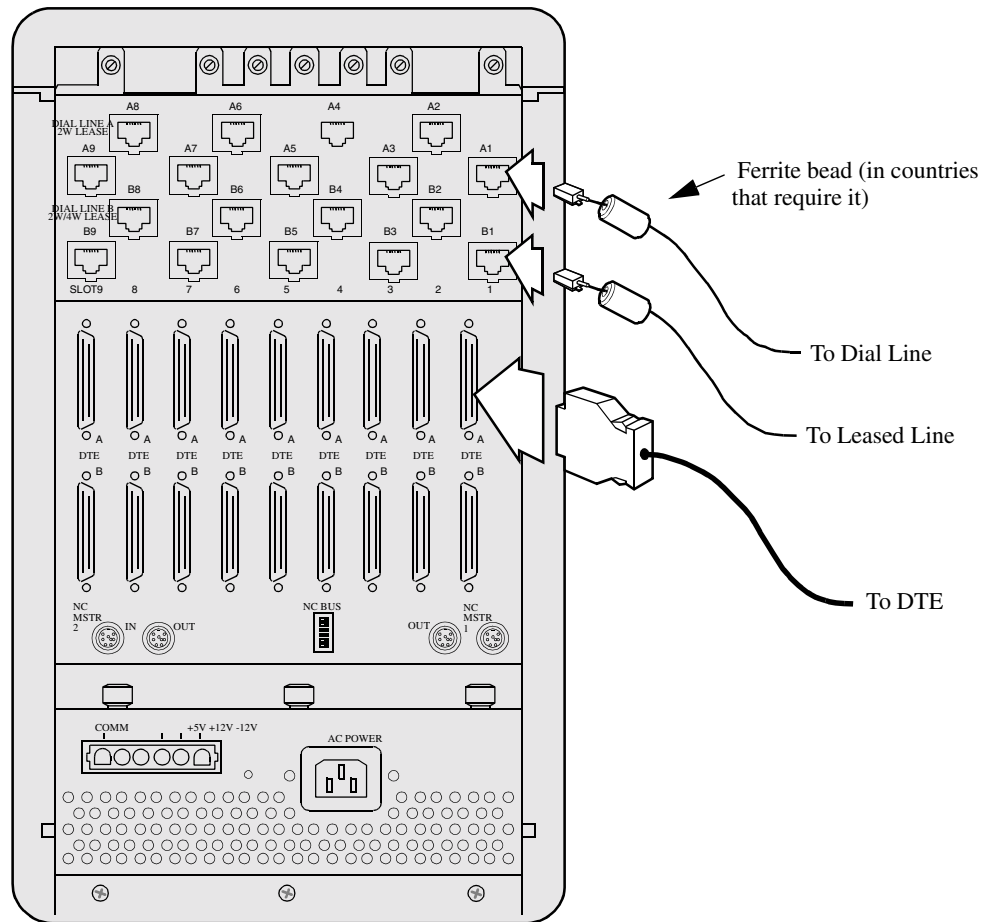

Figure 5. Cabling the 3263 and the 3268 (Leased Line with Dial Restoral) Modem Cards

Attaching Ferrite Beads (U.S.A., Canada, and Japan Only)

A cable with an attached ferrite is included in the accessory kit for U.S.A., Canada, and Japan 326X Series Modem cards. In order to meet FCC Class A and CISPR requirements, the ferrite side of the dial and leased line cables must be attached as close to the backplane as possible (Figure 6).

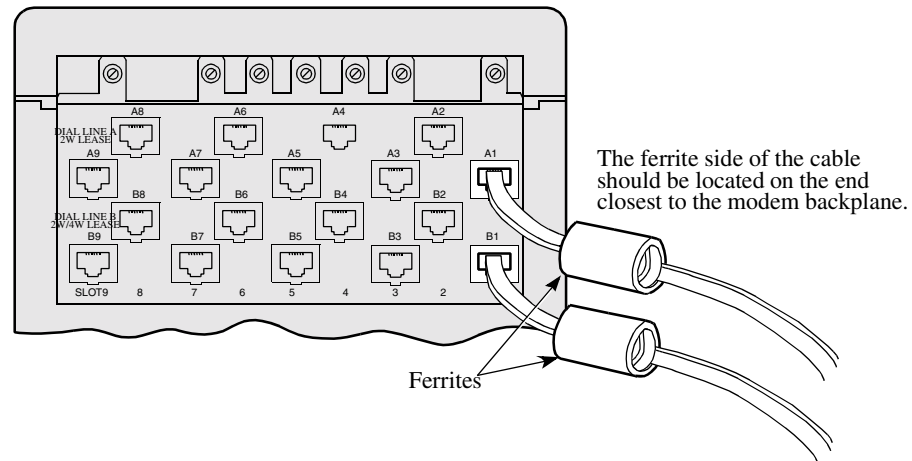

Figure 6. Attaching Ferrite Bead to Cable

Removing Audio Cable Connectors From a Modem Backplane

For compliance with safety standards, audio connectors (for dial and leased line connections) on the 326X Series Modem backplane are recessed approximately 4 cm behind the sheet metal on the backplane (Figure 7).

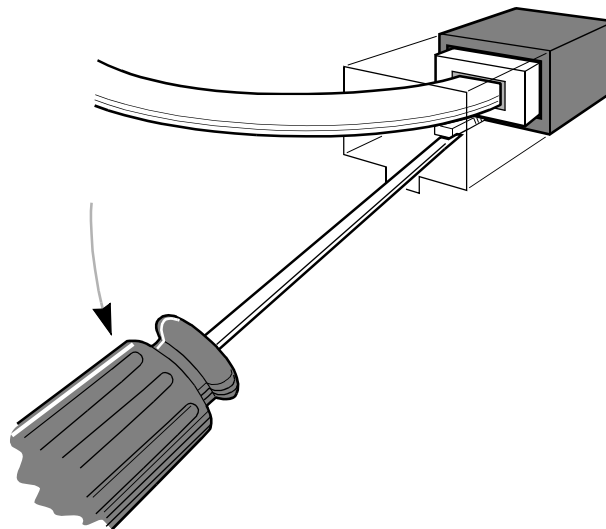

Figure 7. Releasing Backplane Audio Connectors

Pre-Installation Information and Activities

To release the connector:

- 1) Insert a small screwdriver beneath the clip on the bottom of the connector (Figure 7).
 - 2) Press down on the screwdriver to release the clip and gently pull to remove the connector from its receptacle on the backplane.
-

326X Series Modem—Cabling to a Network Manager

This section describes how to set the 326X Series Modem backplane NMS Bus DIP switches for network management. It also describes the proper sequence for connecting to a Network Management System (NMS).

When cabling 326X Series Modem enclosure cards to a network manager:

- The network control (NC) master is a modem that receives network management polls and responds over the digital NC interface. NC polls are generated by the manager and passed to the local or remote site. NC responses are generated:
 - By the modems at the local site and passed to the manager site
 - By the modems at the remote site and passed to the manager site
- The NC slave is a modem that receives NC polls and responds over the audio interface (dial or leased line).
- When you divide an enclosure into groups, each group represents a single NC channel. The enclosure can operate with some slots empty, but at least one card must be in the “master slot” of each group to allow NC signaling for other slots in that group. The master slot corresponds to the NC IN/NC OUT connectors.

The network manager regards all 326X Series Modems included in a group and their associated slaves as operating on a single NC channel. For proper network management operation on a single NC channel, each modem and its associated slaves must have a unique NC address. The total number of 326Xs on one NC channel must not exceed the maximum number of devices per channel supported by the network manager. See your NMS documentation for details.

Pre-Installation Information and Activities

Figure 8 shows a single NC command flow path. In the figure, the local masters receive network control from a single network manager source.

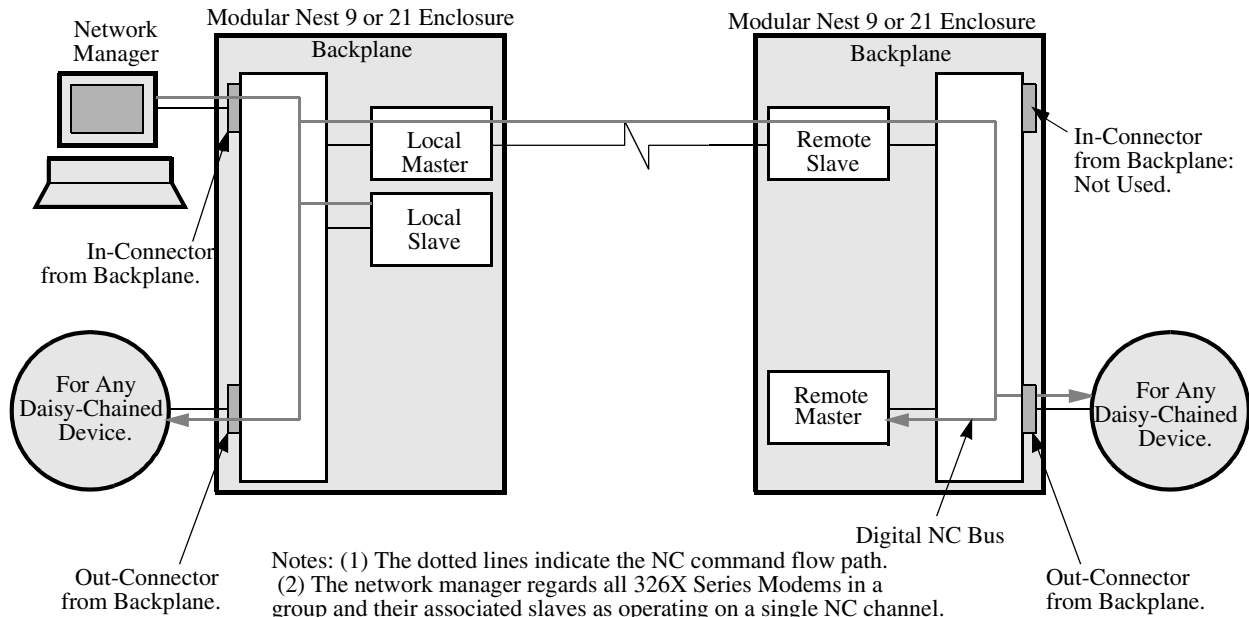

Figure 8. Leased or Dial Line Network Managed Command Flow Path

Each 326X Series Modem backplane provides network control (NC) ports for connection to a Network Manager:

- The 21-card backplane has four NC ports (NC 1 - NC 4)
- The 9-card backplane has two NC ports (NC 1 and NC 2)
- The 1-card backplanes each have one NC port

With the 1-card backplane, the NC port is only for the modem occupying that slot, but with the 9-, and 21-card backplanes, one NC port is assigned to serve a group of 4, 5, or 6 modem cards as outlined in Table 4.

**Table 4.
 Number of Groups vs. Number of Modem Cards per Slot**

Backplane Size	Number of Groups	Number of Modem Cards in a Group
1 Card	1	1
9 Card	2	5 and 4
21 Card	4	5, 5, 5, and 6

Pre-Installation Information and Activities

A group's network management signaling is passed along a multi-drop bus in the backplane to each NC port. One slot of each group is the Bus Master slot (NC 1 for group 1, NC 2 for group 2, etc.). The group number is identified by the Bus Master slot number (e.g., Group 1 uses Bus 1 Master slot). For a group's NC port to work, its Bus Master slot must be occupied. Figures 9 and 10 show this for each backplane.

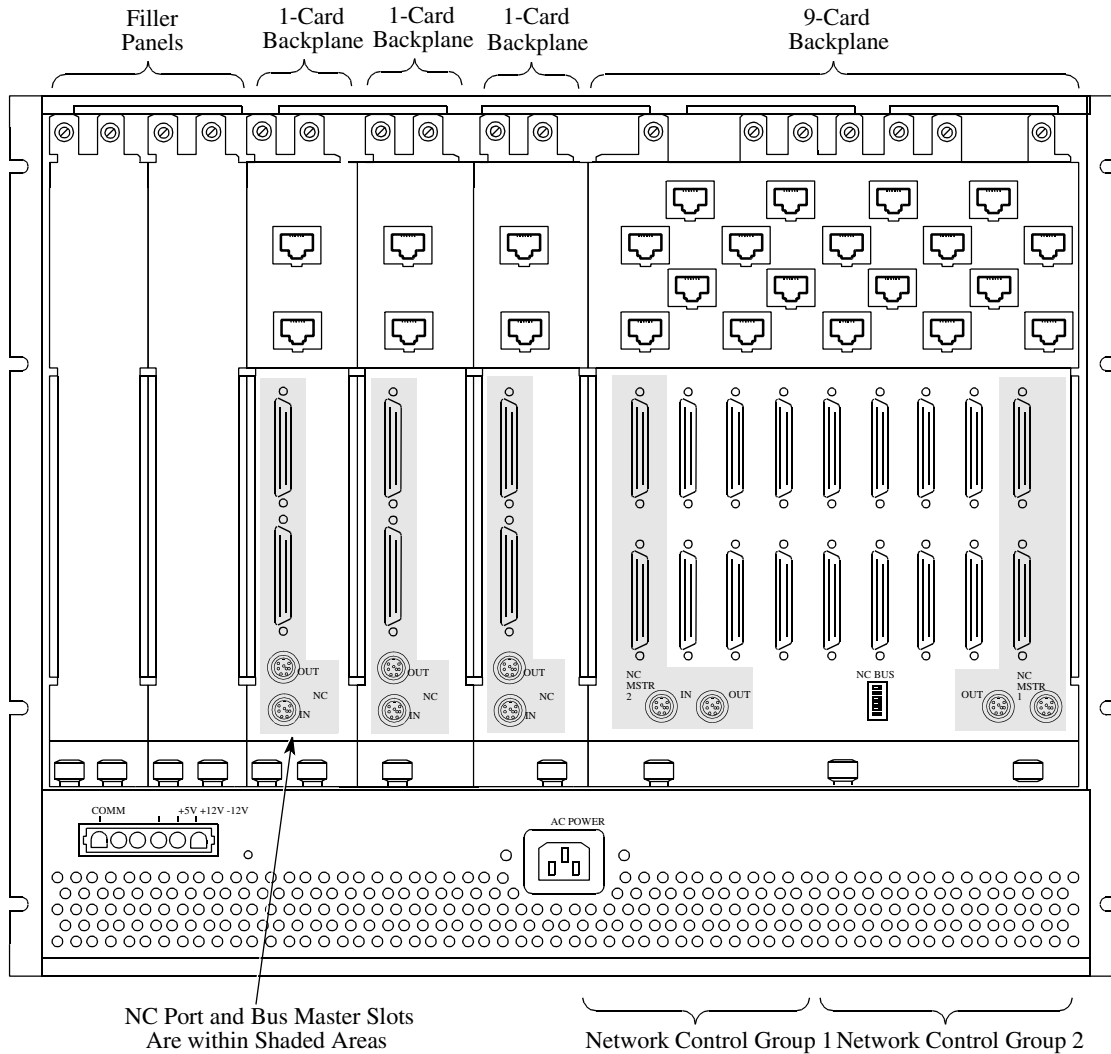

Figure 9. NC Port and Bus Master Locations, and Groups (1- and 9-Card Backplanes)

Pre-Installation Information and Activities

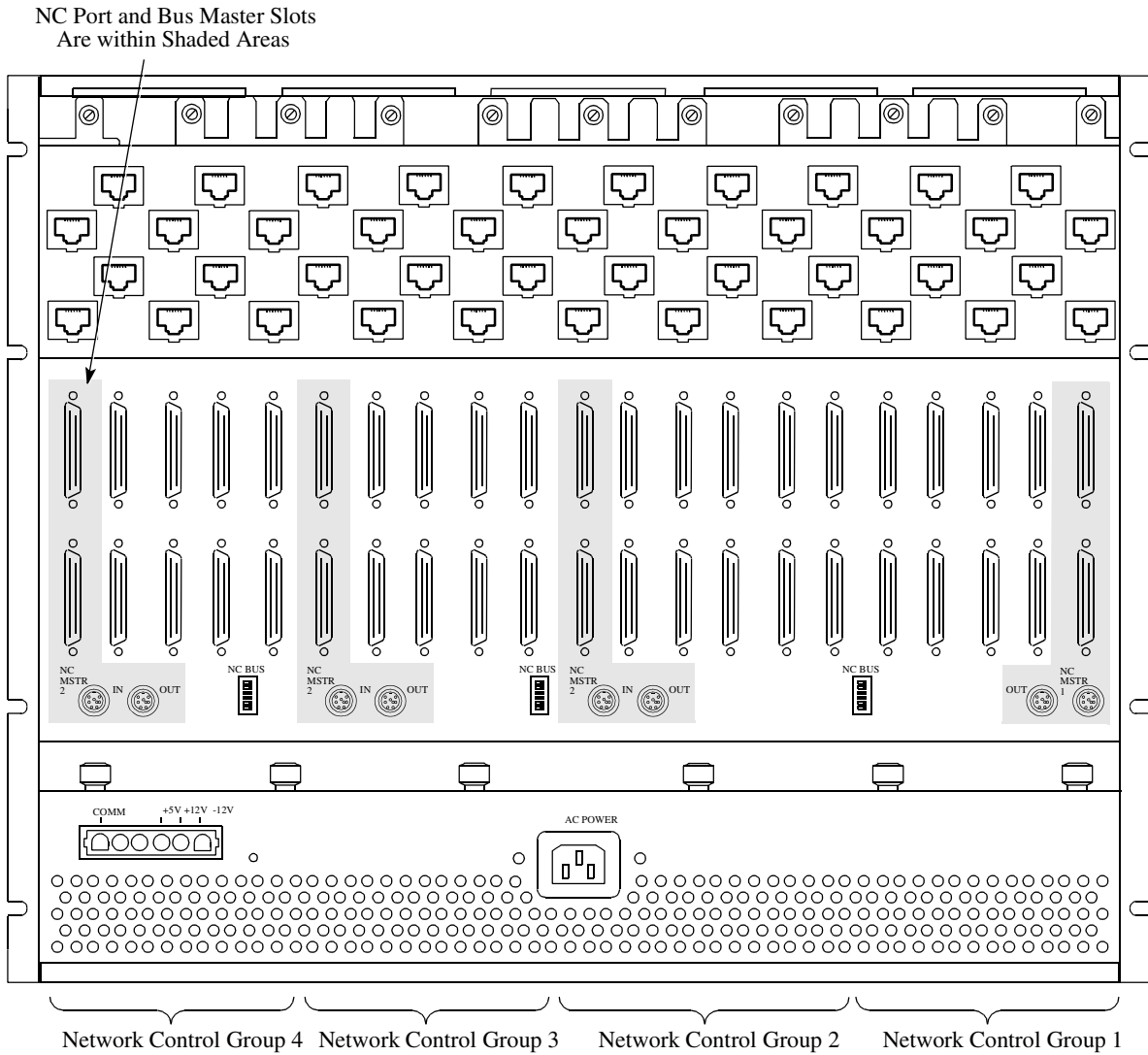

Figure 10. NC Port Locations, Bus Master Locations, and Groups (21-Card Backplane)

Setting Control Across Groups

You can use cables to daisy-chain NC ports on 326X Series Modem cards, as you can with stand-alone modems. With 9- and 21-card backplanes, you can also set NMS Bus DIP switches on the backplane so that all NC signaling is bussed to one NC Port.

To bus two or more groups' NC signaling to one NC Port using Bus DIP switches:

- Groups must be contiguous (Group 3 to Group 2 to Group 1)
- The NC port you plan to use must be the lowest-numbered NC port, and it must have its Bus Master slot occupied
- The NMS Bus DIP switch between groups whose signals are to be bussed to a common NC port must have all six positions set to the *low* number (if all six positions are set to the high number, daisy-chaining is disabled)



Caution

Do not mix switch settings to high and low numbers. This causes interference with Network Control signaling.

Example

For example, to bus signals from group 2 to group 1's NC port:

- 1) Ensure that Bus 1 Master slot is occupied. Other slots in groups 1 and 2 need not be (because the backplane uses a "multi-drop bus," successful bussing of NC signaling along the backplane takes place even when slots are unoccupied).
- 2) On the backplane, locate the NMS Bus DIP switch between Bus 1 Master slot and Bus 2 Master slot (Figure 11). Set all six NMS Bus DIP switches to 1.
- 3) Connect the network management cable (supplied with your network manager) from the Bus 1 Master slot NC IN port to the network manager.

Figure 11 illustrates this example.

Pre-Installation Information and Activities

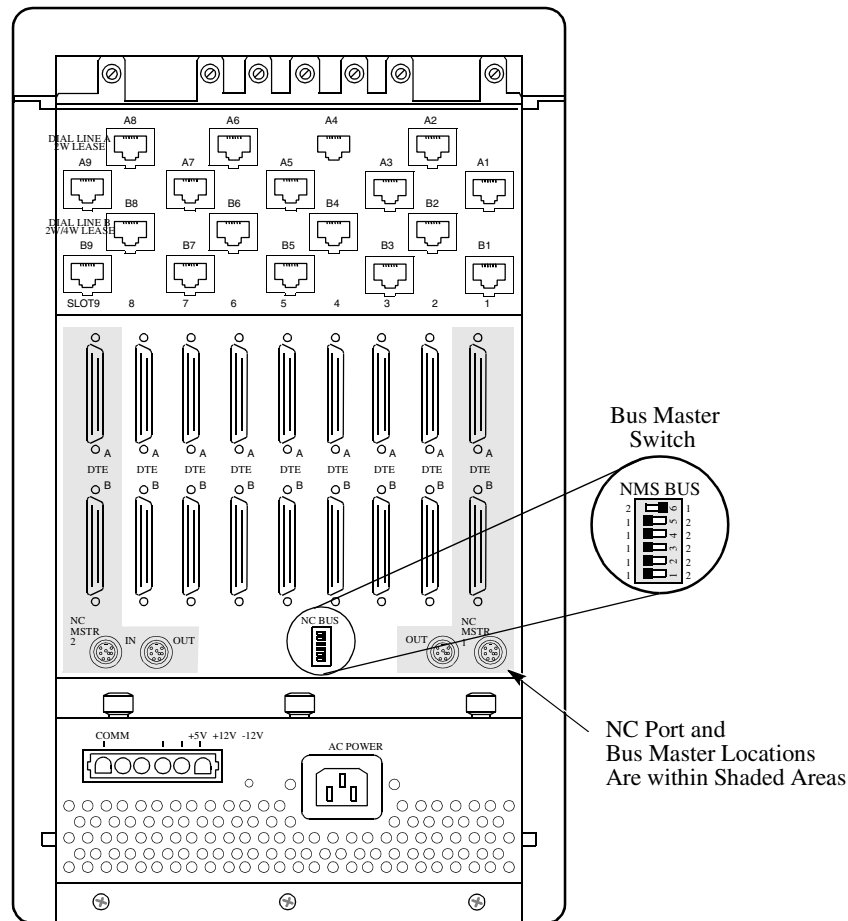

Figure 11. Combining NC Ports With Backplane NMS Bus DIP Switches

Cautions and Limitations for Network Management Cabling

The enclosure daisy-chain (leased line) interface and the multi-drop (dial line) bus features do not support certain NC cabling applications. You can connect multiple NC Master modems to operate in a daisy-chain or operate in a multi-drop bus configuration. However, there can be only one NC slave configured in an enclosure multi-drop bus group or daisy-chain.

Check your NMS documentation for the maximum number of modems per channel. Do not bus more modem NC signals to a single NC port than the network manager can handle on a single channel.

Some applications require multiple NC slaves in an enclosure using the multi-drop NC bus. In this case, use the larger backplanes to accommodate multiple groups. For example, one NC slave is allowed for each group. For the number of groups that each backplane can accommodate and the number of modem cards in those slots, refer to Table 4.

Pre-Installation Information and Activities

If the application requires more NC slaves than the larger backplanes have groups, connect multiple backplanes in the enclosure using the 1-card backplane.

When combining backplanes in an enclosure, one modem card slot is lost for each type of backplane that is used. For example, two 9-modem card backplanes in an enclosure occupy 19 slots. Therefore, two 9-modem card backplanes and one 1-modem card backplane results in the use of only 19 326Xs in a 21-modem card enclosure. The maximum number of backplanes that can be combined in a 21-modem card enclosure is 11 1-modem card backplanes.

Daisy-Chaining NC Ports: Card Modems to Stand-alone Modems

When daisy-chaining NC ports between a modem card and a stand-alone modem, be aware of the following condition.

If a 326X Series Modem card is located *between* a Network Manager and a stand-alone modem, the modem must have software revision level 3.0 or higher (Figure 12).

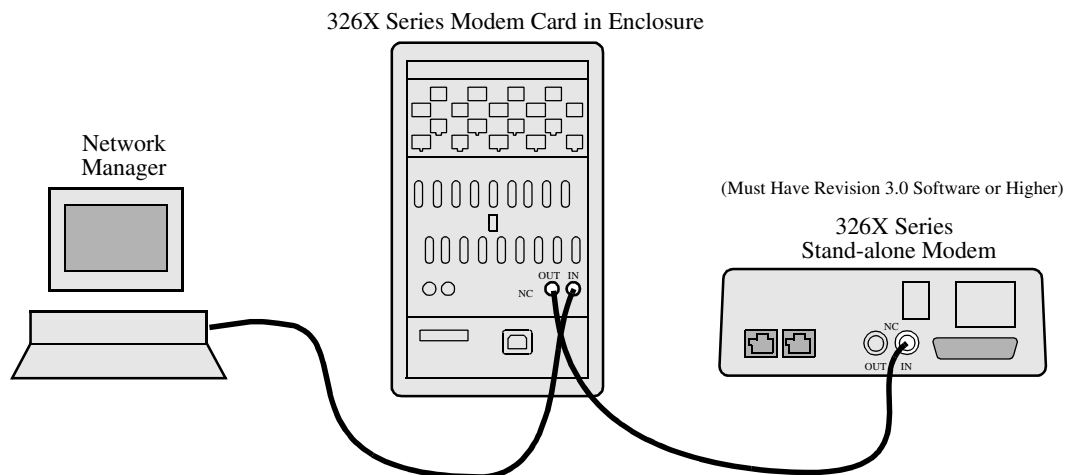

Figure 12. Daisy-Chaining NC Ports: Enclosure Between Network Manager and Stand-Alone

Pre-Installation Information and Activities

There are two ways to determine your modem's software revision number.

From the modem front panel:

- 1) Press the appropriate front panel control key (from your location in the configuration menu structure) until the following (for example) appears:

Data 9600 T/D?

- 2) Press **▶** until the Operating Status appears (for example):

DTE 19.2 RELIABL

- 3) Press **▼** until the following appears:

Display Modem ID

- 4) Press **⊙**. The following appears:

SWPart=xxxxxxx

The rightmost two digits indicate the software revision level. Ensure that they are "30" (meaning software revision level 3.0) or higher.

Using an AT Command:

Enter **AT&IO** from the control terminal. The 8-digit software part number appears. The software revision number is indicated by the rightmost two digits.

If a stand-alone modem is located *between* a Network Manager and a card modem, software revision levels are not an issue. Figure 13 illustrates this condition.

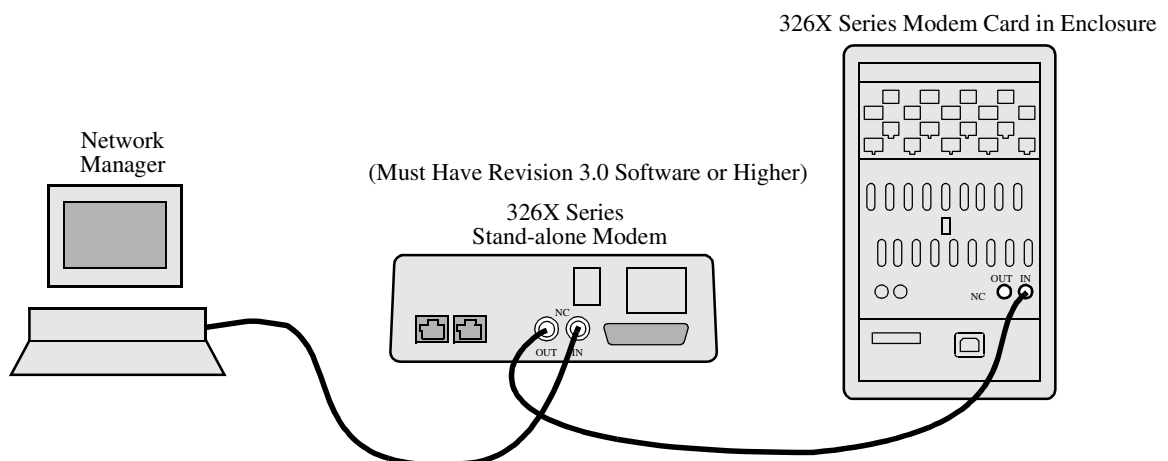

Figure 13. Daisy-Chaining NC Ports: Stand-Alone Between Network Manager and Enclosure

Preparing the 9110 DMS for 326X Series Card Modems

When managing 326X Series Modems in an enclosure using the 9110 Dial Management System (DMS), set the **Use** option (in the 9110 Comm Port Definition screen) to **Complete**. This configures the 9110 to poll all modems (see “Polling” in Chapter 1 of the *9110 DMS User's Guide*) even if one modem is not responding.

Change the **Use** option to **Complete** as follows:

- 1) Shut down the 9110.
- 2) Start up the Setup Program, log on, and select the **Setup File Editor** Option.
- 3) Open *SETUP.WIN* from the File menu.
- 4) Select **Edit** from the Comm menu. The Comm Port List Window is displayed.
- 5) Select a Comm port that is cabled to a 326X Series modem enclosure.
- 6) Select the **Use** option and select **Complete** in the popup window. Ensure the setting next to **Use** changes to **Complete**.
- 7) Press **F1** to save the change in memory.
- 8) Repeat Steps 4 through 7 for each Comm port cabled to a 326X Series modem enclosure.
- 9) Select **Save** from the File menu and save *SETUP.WIN*.
- 10) Exit the Setup Program and restart the 9110.

326X Modem Card Power Supply Requirements in 21-Card Enclosure

If you are using more than nine 326X cards in a Modular Nest 21 enclosure, you must have two power supplies. A third power supply can be added for redundancy.

Removing and Installing a Backplane in Modular Nest 9 or 21 Enclosure

This section explains how to remove and install a 326X backplane attached to a Modular Nest 9 and 21 enclosure. Use this information with the *Modular Nest 9 and 21 Installation and Operation Guide* (Part No. TEL-09564).



Warning

Only qualified service personnel should perform the procedure described in this section. Use of this procedure by unqualified personnel could result in personal injury or equipment damage, and could jeopardize your warranty and maintenance agreement.

Seules des personnes qualifiées peuvent mettre en pratique les procédures décrites dans cette section. Dans le cas contraire, des risques de blessures ou d'endommagement du matériel sont possibles, ce qui pourrait annuler votre garantie et votre contrat de maintenance.

Die in diesem Abschnitt aufgeführten Vorgänge sollten ausschließlich von geschultem und qualifiziertem Servicepersonal durchgeführt werden. Wenn diese Vorgänge von unqualifiziertem Personal durchgeführt werden, kann dies zu Personenschäden oder einer Beschädigung des Gerätes führen und darüber hinaus Ihren Anspruch auf Garantieleistung und Kundendienst gefährden.

Removing a 326X Backplane



Caution

Power down the unit before you begin.

To remove a backplane from a Modular Nest 9 or 21 enclosure (Figure 14):

- 1) Ensure that the enclosure is powered down.
- 2) Remove all cards from the front of the enclosure.
- 3) Using a flat-blade screwdriver, unfasten the backplane connectors.
- 4) Pushing up from beneath the connectors near the top of the backplane, lift the backplane *vertically*, very slightly, to disconnect it from the power distribution connector (A).
- 5) Tilt the top of the backplane away from the enclosure (B), and remove the backplane (C).
- 6) Power up the enclosure.

Removing and Installing a Backplane in Modular Nest 9 or 21 Enclosure

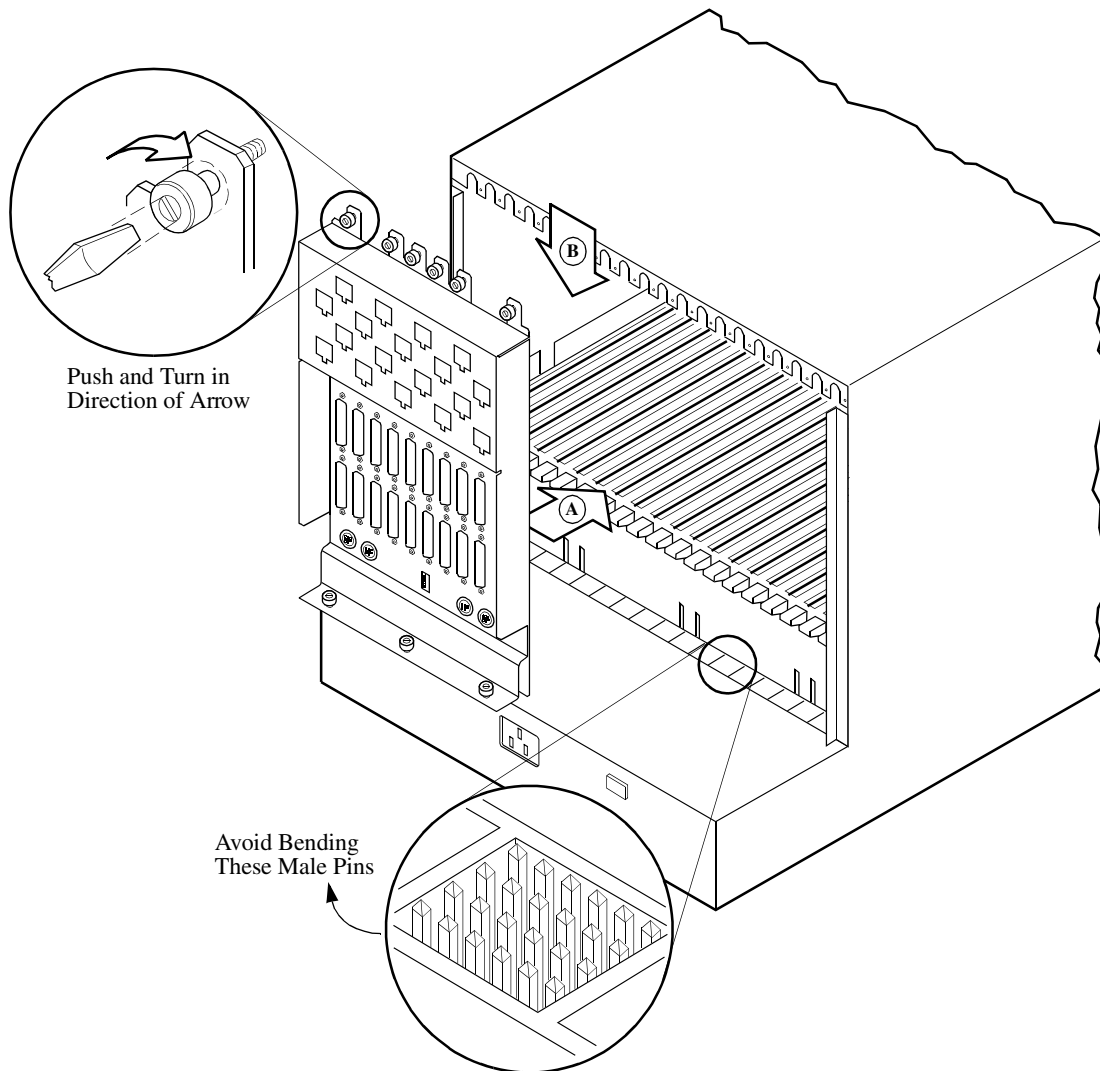

Figure 14. Removing a 326X Backplane

Installing or Replacing a 326X Backplane



Caution

Power down the unit before you begin.

To install or replace a backplane in a Modular Nest 9 or 21 enclosure (Figure 14):

- 1) Ensure the enclosure is powered down.
- 2) Using the alignment guides on the backplane and enclosure to line up the backplane between the screw holes on the top and bottom of the enclosure, first insert the bottom of the backplane (A), and then rotate the top of the backplane into position (B). **Do not to bend any pins on the connector.**
- 3) Push down slightly on the base of the backplane (C), ensuring that the backplane connectors are aligned.
- 4) Using a flat-blade screwdriver, secure the backplane to the enclosure with the fasteners supplied. Fasten the base first, then the top.
- 5) Remove all cards and power supplies from the front of the enclosure.
- 6) Set an Ohm-meter a minimum 20 Ω range. Measure the resistance between the following pairs of J2 test-connector pins:

<i>Pin</i>	<i>Description</i>	<i>Pin</i>	<i>Description</i>
1	Digital ground	4	+5V
1	Digital ground	5	+12V
1	Digital ground	6	-12V
4	+5V to	5	+ +12V
4	+5V	6	-12V
5	+12V	6	-12V

- If all readings register as open circuits, the backplane connectors are not short-circuited. Go on to the next step.
- If any reading registers resistance, the backplane connectors are short-circuited. Remove the backplane (using the procedure above), and carefully straighten any bent or broken pins. Reinsert the backplane (using this procedure).

If you cannot resolve a problem, call the Telenetics Customer Support Center.

- 7) Re-install the cards and power supplies that were removed when you removed the backplane.
- 8) Power up the enclosure.

Removing and Installing a Backplane in Modular Nest 9 or 21 Enclosure

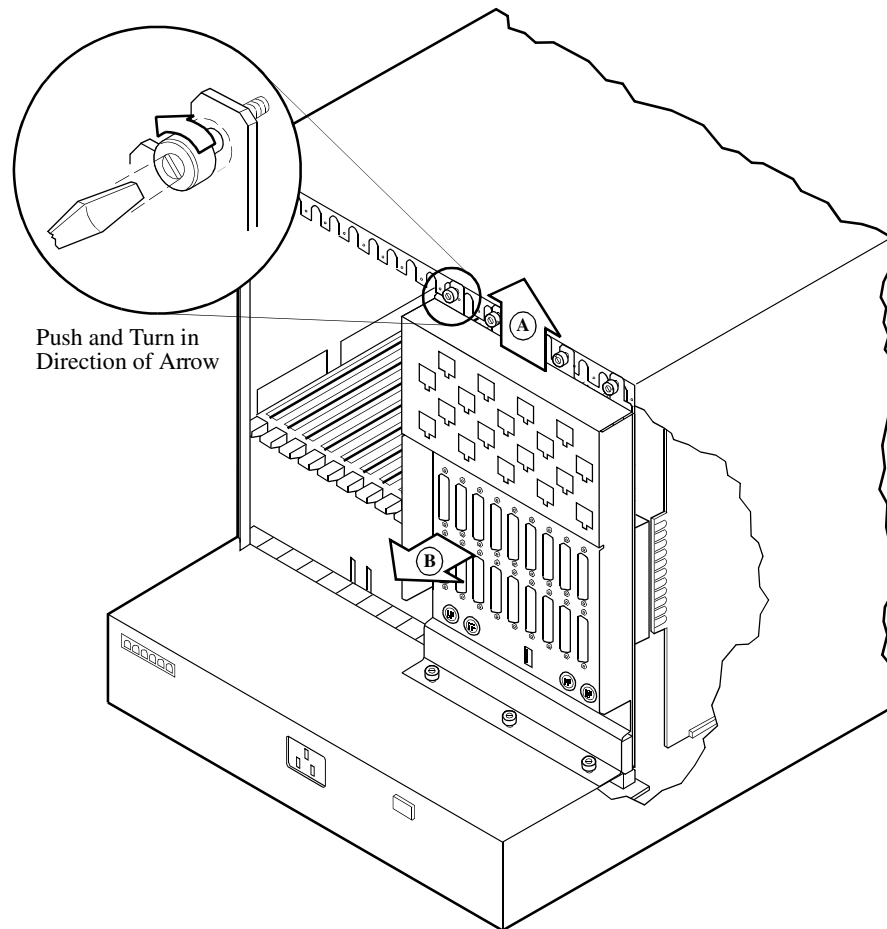

Figure 15. Installing or Replacing a 326X Backplane

Index

Numerics

- 3262 [5, 8, 12, 14, 15](#)
- 3263 [5, 8, 11, 15](#)
- 3267 [5, 8, 12, 14, 15](#)
- 3268 [5, 8, 11, 15](#)
- 9110 DMS and the 326X Series Modem [26](#)

A

- A/B LED [6](#)
- A/B switching [6](#)
- ALM LED [6](#)
- audio cables [5](#)
- audio connector [16](#)
- Australia [8](#)
- Avertissement [3, 4](#)

B

- backplane jumper [7](#)
- backplane, modem card [5](#)
- backplane, Modular Nest [11](#)
- Belgium [8](#)
- Bus Master slots [19](#)
- Busy Out [7, 8, 11](#)
- busy out backplanes
 - and supported countries [7](#)

C

- cable clam [p5](#)
- cables [5](#)
- cabling [14, 15](#)
 - card models to a network manager [19](#)
 - models 3262/3267 [14](#)
- Canada [5, 8, 16](#)
- card modem [6](#)
- Caution [11](#)
- central office [8](#)
- CISPR [16](#)
- connecting port Warning [3](#)

D

- daisy-chaining NC (network control) signals [24](#)
- Denmark [8](#)
- dial restoral [5](#)
- DIP switch
 - modem card [12](#)
- Dual Inline Package (DIP) switch [12](#)

Removing and Installing a Backplane in Modular Nest 9 or 21 Enclosure

- E**
 - EN60950 3
- F**
 - FCC 16
 - FCC Part 68 7
 - ferrite 5, 14, 15, 16
 - ferrite cable
 - attaching to card models 16
 - front panel 6
- H**
 - Hong Kong 7, 8
- I**
 - installation warning 4
 - interface 14, 15
 - Ireland 8
- J**
 - jack 7
 - Japan 5, 16
 - jumper 7, 11
- L**
 - leased line 5
 - LED 6
 - LEDs
 - A/B 6
 - ALM 6
 - ALM LED 6
 - lightning 4
- M**
 - Make Busy 8
 - modular connector block 5
 - Modulus 9 and 21 enclosure 2, 8
- N**
 - NC (network control)
 - card groupings for NC signal bussing 19
 - ports 19
 - signal bussing 19
 - signal daisy-chaining 24
 - network manager
 - cabling card models to 19
 - configuring 9110 DMS for 326X Series Mode m26
- P**
 - power 8

Removing and Installing a Backplane in Modular Nest 9 or 21 Enclosure

R
ringer equivalence number (REN) 7

S
safety information 3
safety standard 16
SELV 3
slot 5
stand-alone modem 6
surge 4
Sweden 8
Switzerland 8

T
TBTS 3
test mode 6

U
U.S.A. 5, 8, 16
United Kingdom 7, 8
Universal International 7
USOC 7

W
Warning 3
Warnung 3, 4

Free Manuals Download Website

<http://myh66.com>

<http://usermanuals.us>

<http://www.somanuals.com>

<http://www.4manuals.cc>

<http://www.manual-lib.com>

<http://www.404manual.com>

<http://www.luxmanual.com>

<http://aubethermostatmanual.com>

Golf course search by state

<http://golfingnear.com>

Email search by domain

<http://emailbydomain.com>

Auto manuals search

<http://auto.somanuals.com>

TV manuals search

<http://tv.somanuals.com>