

Telex®

Operating Instructions



RadioCom™

FM-1

QSB-1

SMP

**Professional
Wireless
Intercom System Management**

TELEX®

Table of Content

Section 1 Introduction	1-1
Overall Description	1-1
Section 2 System Manager Program (SMP) Software	2-1
System Manager Program (SMP)	2-1
Installing the program for the first time (Step 1)	2-1
Installing Driver for QSB-1 Card Reader (Step 2)	2-1
Launching the System Manager Program (Step 3)	2-2
Using the System Manager Program	2-3
Configuration Button	2-4
Button Options	2-5
Downloading/Uploading	2-6
Downloading an Event	2-6
Uploading a SnapShot	2-6
Section 3 QSB-1	3-1
QSB-1	3-1
QSB-1 Specifications	3-1
Section 4 FM-1 Frequency Manager	4-1
Front Panel Control and Connections	4-1
Rear Panel Controls and Connections	4-1
FM-1 Specifications	4-2
Operation	4-2
Basic Description	4-2
Connecting the FM-1 to the Base Station	4-2
Powering the Unit	4-2
Start-up Screen	4-2
Downloading a Card	4-3
Selecting an Event and Downloading to System	4-3
Snap Shot	4-3
Section 5 FM-1 Menu Structure	5-1
FM-1 Menu Flow Chart	5-1
Section 6 Software License	6-1
End-User License Agreement for Telex® Software	6-1
Section 7 DataFlash® Card Handling and Storage Precautions	7-1
Section 8 Frequency Bands	8-1
Frequency Bands	8-1
Band Pairing for Systems	8-1
Table 1 Available Band Pairings	8-1
Table 2 Band Names and TV Channels	8-1
Section 9 Replacement Parts and Accessories	9-1

Overall Description

The SMP Software along with the QSB-1 and FM-1 allow a user to easily manage large systems of BTR-1 base stations along with their beltpacks.

The SMP (System Manager Program) software enables a user to set-up multiple events on the computer. An event is a particular situation where a pack of ten base stations need their parameter set a certain way. These parameters include transmit and receive frequencies, intercom levels, auxiliary levels, to name a few. The event could be a football game or act one of a Broadway show, the possible applications are endless. A good example is a college football team which uses a ten pack BTR-1 system for its' coaches on the field to talk to each other and the personal in the press box. If that team plays twelve games a year and six of them are away then the SMP could be used to set up 7 events. Event one would be the frequencies and parameters for a ten pack of base stations used at home. The other six events would be the ten pack's frequencies and parameters for the away locations.

The QSB-1 (Qard Serial Bus) pod interfaces with the SMP via a USB connection to the computer. This enables the user to download events into a small, convenient, DataFlash® card. FM-1 "Snap Shots" can also be uploaded to the SMP from the DataFlash card via the QSB-1.

The FM-1 (Frequency Manager) interfaces with up to ten BTR-1 base stations. The FM-1 talks to the bases via a CAN bus system. The CAN bus starts at the FM-1 and daisy chains through all the base stations and then back to the FM-1 to terminate. The DataFlash card is inserted in the card reader slot for the FM-1 to read events from the card. With the DataFlash card in the FM-1 the user can select an event on the card and download the selected event. Now the user can download the event into the base stations. The FM-1 can also take "snap shots" of the ten pack of bases and download those parameters on the DataFlash card for eventually uploading into the SMP.

System Manager Program (SMP)

Installing the Program (Step 1)

1. Insert the Manual/SMP Program compact disc into your CD-ROM drive. The program will automatically start.
2. Select the "System Manager Program" button. You will automatically go to the system manager page.
3. Click on the "Install Software" button. The Setup Wizard screen will appear. Follow the Setup Wizard instructions on your screen.

A



B

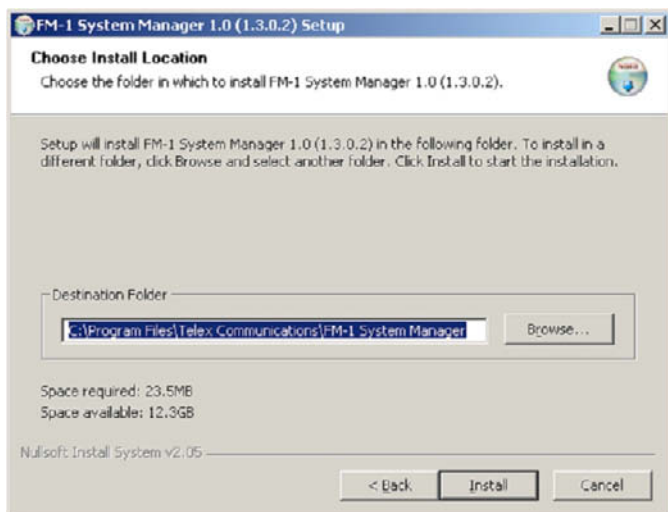

C

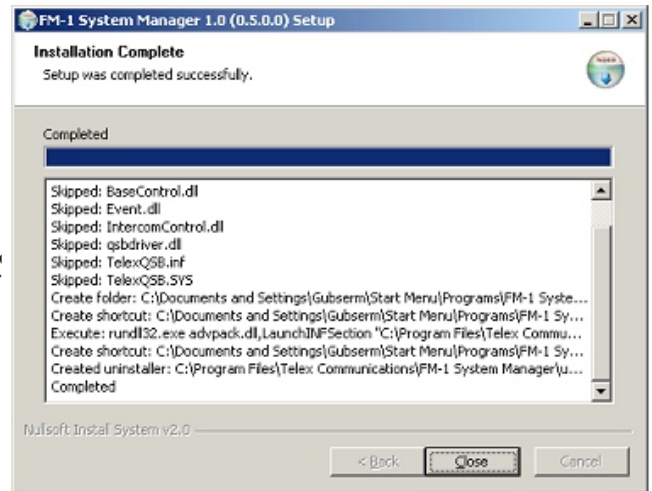

Installing Driver for QSB-1 Card Reader (Step 2)

1. Connect the supplied USB cable to an available USB port on your computer.
2. Connect the QSB-1 to the USB cable.
3. The QSB-1 device driver should be loaded automatically to your computer. If they were not loaded, follow the instructions on your screen.
4. The device driver can be found at: C:\Program Files\Telex Communications\FM-1 System Manager on your computer.

A



B



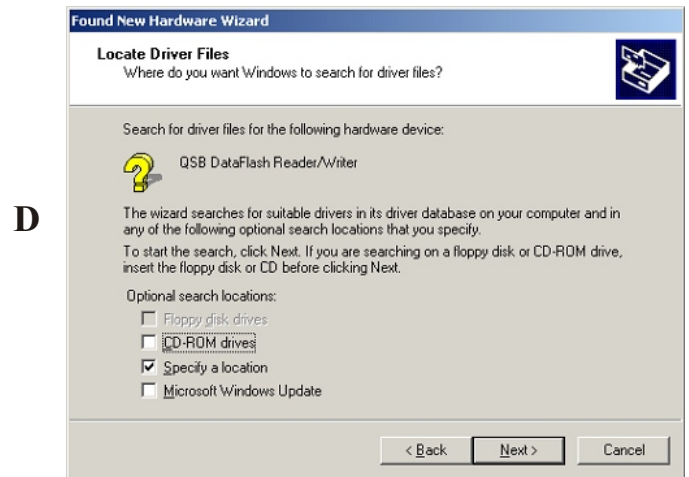
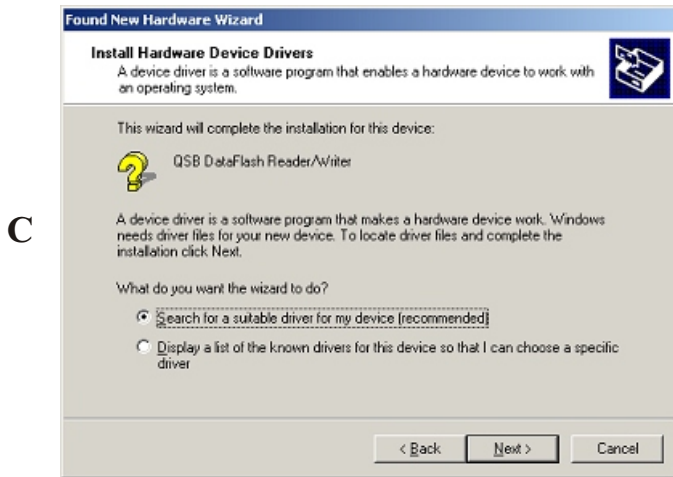

Launching the System Manager Program (Step 3)

1. Click on the computer desktop icon, shown to the right, to launch the program.
2. The following Screen will then appear:



FM-1 System Manager.exe

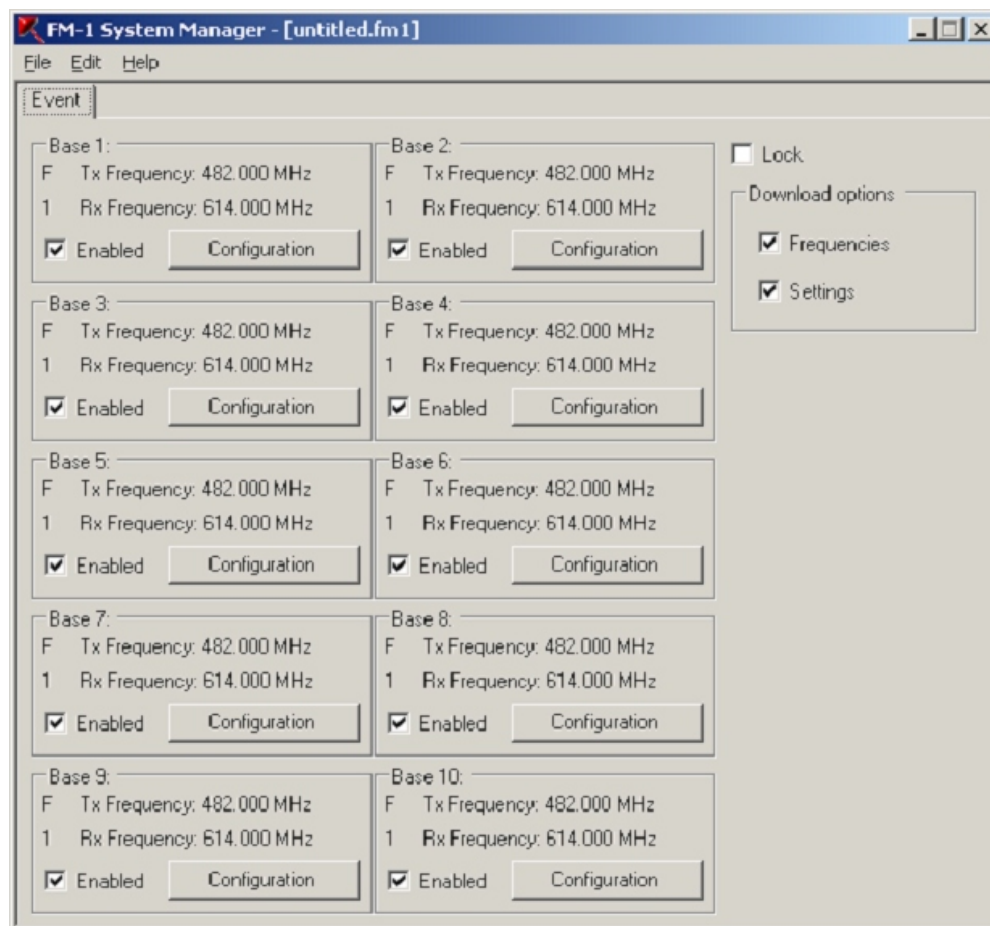

Figure 2-1
The main screen of the system manager program.

Using the System Manager Program

The main screen displays the 10 base stations.

1. **Event Name.**
2. **Base Name** – A 10 character name for the base is displayed here. The name is entered in the configuration screens.
3. **The Band Designation** – Base 1, shown here, is a F1 base station. This indicates its transmit band is in the F band and it's receive band is in the 1 band. See section 8 for band definitions.
4. **Enable** – If checked the user can enter configuration and change settings, etc. If not checked the user cannot re-configure the base station. The FM-1 will only download to base stations that are enabled.
5. **Configuration Button** – Selecting this button allows the configuration of that BTR-1 base main settings and the TR-1's buttons A, B and C
6. **Lock** – Will lock all ten base stations so the configuration can be viewed but not accidentally changed. A base must have the enable check marked in order to view the configuration.
7. **Download Frequencies** – If selected, and settings is not, then only frequencies will be downloaded to the DataFlash card for that event.
8. **Download Settings** - If selected, and frequency is not, then only settings will be downloaded to the DataFlash® card for that event.

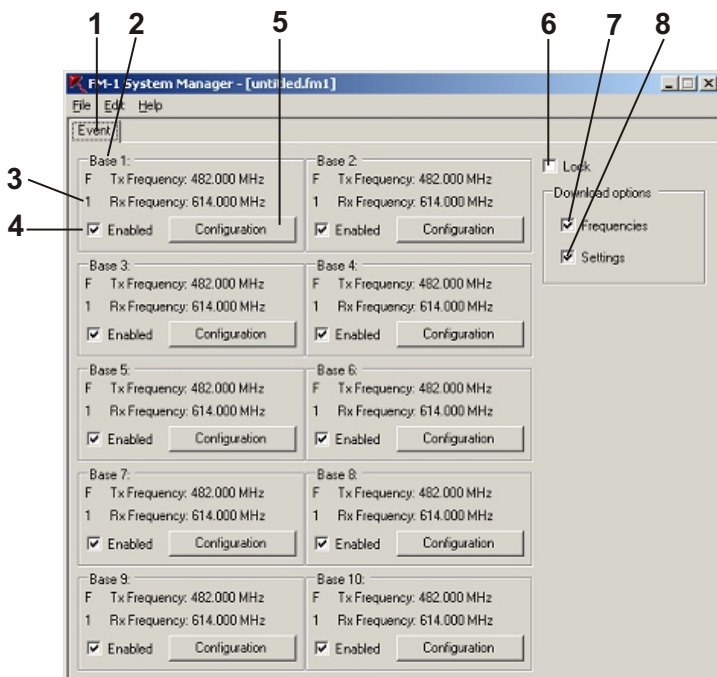

Figure 2-2

The Main Screen Of The System Manager Program.

The main menu bar definitions are defined below:

FILE:

- New: Creates a new event.
- Open: Opens a file with a .fm1 extension
- Save: Saves file with current name and a <.fm1> file extension.
- Save as: Saves file with a new name you create and a <.fm1> file extension.
- Print: Prints a report of the main settings of the ten base stations.
- Print Preview: On-screen preview of print output. Can also print from this screen.
- Download: Downloads current Event, or Events, to the QSB-1 and DataFlash® memory card.
- Upload: Uploads "SnapShot" files taken at the FM-1 Frequency Manager of the base stations.
- Exit: Exit the Program.

EDIT:

- New Event: Creates New Event within the current file.
- Delete Event: Deletes Event selected.
- Rename Event: Renames Event selected.
- Copy Event: Copies currently selected event into memory.
- Paste Event: Pastes current event in memory to SMP. Adds the event to the end of the event folder tabs.
- Paste Frequencies: Allow the user to paste frequencies only into an event from a tab delimited text file. For example, Microsoft® Excel can be used as a source to transfer frequencies to the SMP. The 1st column of 10 rows in Excel can be base TX frequencies and the 2nd column of 10 rows can be the RX frequencies. This 2 x 10 array of numbers is then selected and copied to the clip board. Now "Paste Frequencies" may be used to paste the 2 x 10 array of frequencies to the SMP. The frequencies of the base stations read from the file must be within the bands set for the bases in the SMP.

HELP:

About: Provides current software version information.



Configuration Button

This button creates the configuration of the selected BTR-1 and TR-1. It allows access to the following items.

- Base Main
- Button A
- Button B
- Button C
- Four wire settings

When the configuration button is pressed the following screen will appear:

1. **Name** – If desired the user can enter up to a 10 character name for the base station. This will be displayed at the top of the status screen of the base.

2. **Transmit Band** – Select the transmit band of the base station from the drop down menu. This will set the frequencies that will appear in the transmit frequency drop down menu.
3. **Transmit Frequencies** – Enter directly or select the transmit frequency from the drop down menu. The range of frequencies to select from was set by the transmit band list.
4. **Intercom** – This item allows the select of the intercom type that the base station will be set to. The options are: Telex 2 Wire, RTS 2 Wire XLR, RTS 2 Wire DB15, ClearCom 2 Wire and Four Wire.
5. **Receive Band** – Enter directly or select the receive band of the base station from the drop down menu. This will set the frequencies that will appear in the receive frequency drop down menu.
6. **Receive Frequencies** – Select the receive frequency from the drop down menu. The range of frequencies to select from was set by the receive band list.
7. **Auxiliary Input Select** – The auxiliary input of a base station may be routed one of two ways:

Local = Any audio placed into the auxiliary input port is routed only to the base's local headset and beltpack (Recommended)

Global = Any audio placed into the auxiliary input port is routed not only to the base's local headset and beltpack, but also to any wired system connected to the base station.

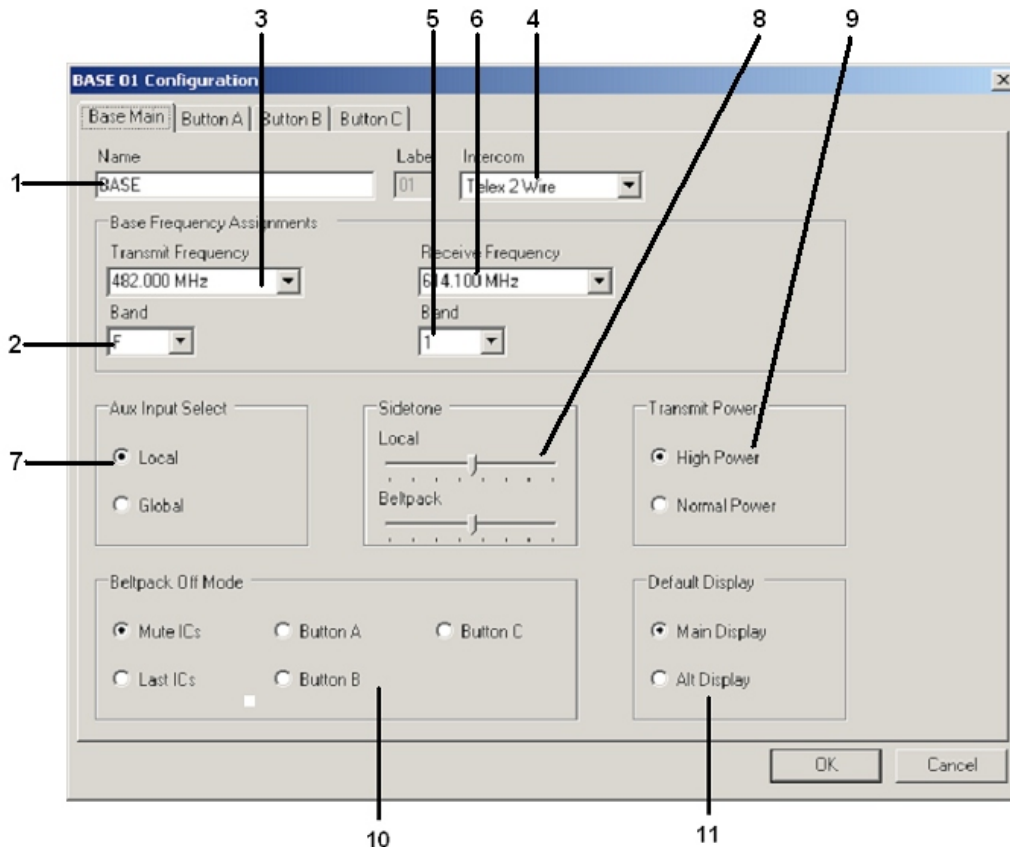

Figure 2-3
The Base Main Screen

8. **Sidetone** - The sidetone is the amount of a user's own voice that is feed back to their headphones. Both the beltpack and base stations sidetone my be adjusted.
9. **Transmit Power** - The base transmit power can be set to the following positions:
 - Normal** = The transmit power is 10 dB below maximum power. This is 5 mW typically.
 - High** = The transmit power is at full power. This is 50 mW typically. (Recommended)
10. **Beltpack Off Mode** - Sets the base station's wired connectivity when the beltpack is off, out of communications range or in push-to-transmit mode with the talk button off.
 - Mute ICs** - The base drops connectivity to any wired intercom connected to it after 1 second of not receiving communications from a beltpack.
 - Last IC** - The base maintains connectivity to the wired intercom(s) the beltpack was last at if not receiving communications from a beltpack.
 - BTN A**-The base connects to the "A" button defined wired intercom(s) when not receiving communications from a beltpack.
 - BTN B** - The base connects to the "B" button defined wired intercom(s) when not receiving communications from a beltpack.
 - BTN C** - The base connects to the "C" button defined wired intercom(s) and activates the "C" button options (QB and/or Relay if active) when not receiving communications from a beltpack.

11. **Default Display** - The user may select the normal or alternate status screen for the default display on the base station.

Button Options

The other three tabs in the configuration screen are the settings for the three TR-1 buttons: A, B and C. Displayed in figure 2-4 is the tab for button C. The other buttons tabs are almost identical. The C button was chosen to display below because it has a few more additional options. If the intercom type chosen is "four wire" the button tabs are replaced by a single "four wire" tab. The operation of it's features are similar to that below:

1. **Talk** = The intercom port is active. Audio is passed to and from the beltpack and base's local headset.
2. **Listen Only** = The audio on the intercom port can be heard at the beltpack headset, but no audio is passed to the intercom port from the beltpack.
3. **Mute** = The intercom port is off. No audio is placed on or taken from that port. If selected, intercom level controls will not be settable.

4. **IC in (Listen)** – Sets the level of the intercom audio coming into the base station. Will be the only adjustment active if Listen Only is selected.
5. **IC out (Talk)** – Sets the level of the intercom audio going out of the base station.
6. **Relay Closure** - If selected, when button C on the beltpack is pressed, a relay closure is activated on the rear of the base station.
7. **QB** = If selected, when button C on the beltpack is pressed, a 1000 Ohm path to ground is activated at pin 15 of the male and female D-sub connectors in the rear of the base station. This can be used to active a PTT on some external radio systems. Audio from the beltpack and local base station's headset is also available at pin 15 when the button is pressed.
8. **Auxiliary Audio Enable** – If selected auxiliary audio is switched to on in the base station.
9. **Auxiliary In / Out Levels** – If enable is selected, then the auxiliary in and out levels are set here.

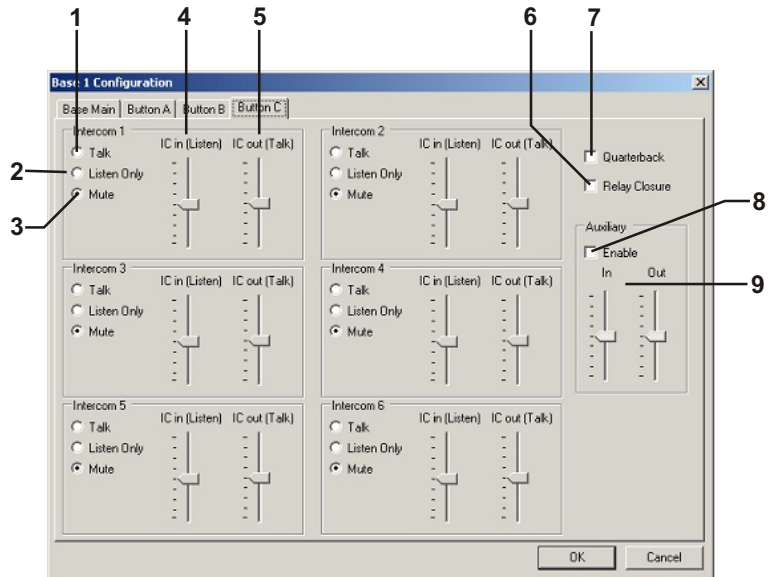

Figure 2-4
The Button "C" Screen

Downloading / Uploading

After an event is set-up it may be downloaded to a DataFlash card for the eventual downloading into a FM-1 and thus to a system of up to 10 base stations.

A snap shot of a system of up to 10 base stations may also be uploaded to the SMP in order to examine the settings of the system for trouble-shooting, use the system as a 'base line' for setting up other events, or just for records.

Downloading an Event

1. Open FM-1 System Manger Program
2. Create an Event
3. Save Event
4. Download Event to QSB-1 and DataFlash memory card.
5. Place memory card in an FM-1 and download card to FM-1.

Uploading a SnapShot

1. Download a Snap shot(s) to the DataFlash memory card from the FM-1
2. Remove the DataFlash card from the FM-1 and place in the QSB-1.
3. Open FM-1 System Manger Program
4. Upload the snapshot to the SMP from the memory card that is in the QSB-1.

NOTE: Snap Shots are named sequentially by the FM-1. The 1st snap shot will be, "snap shot 0" the second, "snap shot 1", etc. Up to 10 snap shots may be taken.

QSB-1

The QSB-1 (Qard Serial Bus) pod interfaces with the SMP (System Manager Program) via a USB connection to the computer. The QSB-1 allows the user to download events into a small, convenient, DataFlash memory card. Event(s) and Snapshot(s) of the system can also be uploaded to the SMP from the card via the QSB-1.

The card for use with the QSB-1 is a 2 MB DataFlash memory card. These may be purchased in various electronic stores or from Telex, see the “Accessories and Replacement Parts” section of the manual.

NOTE: The 2 MB card is the only size currently compatible with the FM-1, QSB-1 and SMP. Larger or smaller DataFlash cards will **NOT** work.

Connections

NOTE: Item 2 is Located on back of Unit

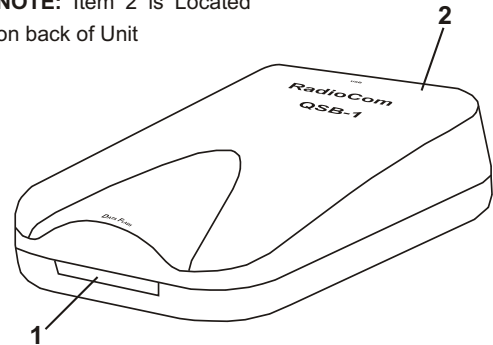

**Figure 3-1
The QSB-1 Card Reader**

1. **Card Slot** - Only use 2 MB DataFlash memory cards.
 2. **USB Connection** – Connect USB cable from computer.
- The QSB-1 is powered from the computer via it’s USB cable.

QSB-1 Specifications

Temperature Range	32°F to 104°F (0°C to 40°C)
Dimensions.....	2.47”W x 0.97”H x 3.37”D (6.3 cm x 2.5 cm x 8.6 cm)
Weight.....	2 oz (57 g)
USB Type	Version 1.1 or 2.0
Memory Card Type.....	DataFlash , 2 MB Only

DataFlash is a registered trademark of Atmel Corporation

Front Panel Controls and Connections

1. **Power Switch.**
2. **<MENU> and <SET> buttons** – Used to select menus and set options on the LCD.
3. **Backlit Graphics LCD (Liquid Crystal Display).**
4. **<UP> and <DOWN> buttons** – Used to select options on the LCD.
5. **Contrast Adjust** – Adjusts the LCD's contrast.
6. **Snap Shot Button** – Press and hold for 2 seconds and the user will be asked to check if a DataFlash® card is in the "card reader" slot. Press again and a "snap shot" of the BTR-1(s) will be taken. This will record frequencies and other important parameters of the BTR-1 system.
7. **Card Reader Slot** – Slot where the 2 MB DataFlash card is inserted.

Rear Panel Controls and Connections

1. **CAN Bus Out** – This RJ-45 jack is where the CAN bus communication goes out to the first BTR-1 base station.
2. **CAN Bus Termination** - This RJ-45 jack is where the CAN bus communication terminates from the last BTR-1 base station.
3. **Power** – IEC receptacle. Accepts 100 – 240 VAC, 50 – 60 Hz.

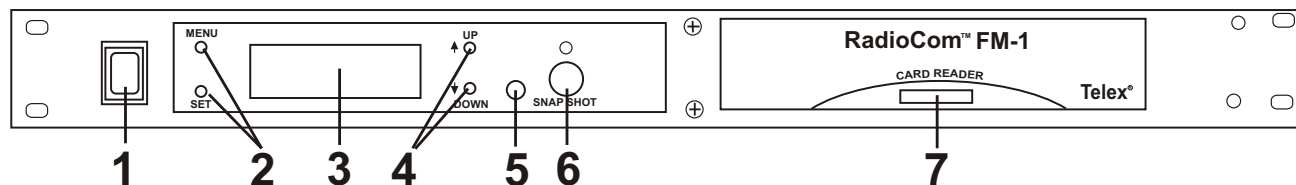

Figure 4-1
Front View of FM-1

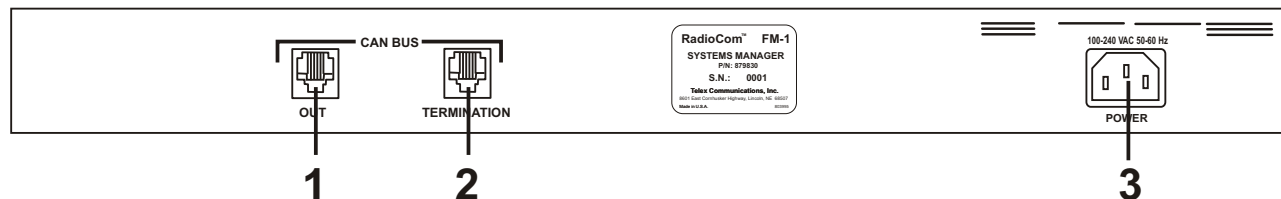
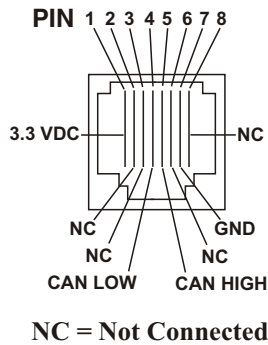

Figure 4-2
Rear View of FM-1

FM-1 Specifications

Temperature Range.....	-4°F to 130°F (-20°C to 55°C)
Dimensions.....	19.0"W x 1.72"H x 8.02"D (48.3 cm x 4.4 cm x 20.4 cm)
Weight.....	3 lbs 9 oz (1.62 kg)
Memory Card Type.....	DataFlash , 2 MB Only
Event Storage	Up to 99 Events
Power Requirements	100 – 240 VAC, 50 – 60 Hz, IEC receptacle
Communication Bus	CAN Bus



(Looking at rear panel of FM-1)

Figure4-3
CAN Bus OUT RJ-45 Pinout

Operation

Basic Description

The FM-1 (Frequency Manager) interfaces with up to ten BTR-1 base stations. The FM-1 talks to the bases via a CAN bus system. The CAN bus starts at the FM-1 and daisy chains through all the base stations and then back to the FM-1 to terminate. The flash card is inserted in the card reader slot for the FM-1 to read events from the card. With the flash card in the FM-1 the user can select an event on the card and download the selected event. Now the user can download the event into the base stations. The FM-1 can also take “snap shots” of the ten pack of bases and download those parameters on the flash card for eventually uploading into the SMP.

Connecting the FM-1 to the Base Stations

The FM-1 communicates to the base stations via the CAN bus. This CAN bus starts at the FM-1 “OUT” port. It is connected from there to the first base station. It does not matter which CAN bus base station jack is the input or output. From the first base it daisy chains through all the base stations (up to ten). The CAN bus connects from the last base station to the FM-1 port marked “Termination”.

DataFlash is a registered trademark of Atmel Corporation

Powering the Unit

The input to the FM-1 is a standard IEC connector. It accepts 100 – 240 VAC, 50 – 60 Hz.

If the unit has been connected to AC power for some time, and the front panel switch is turned on, the unit will power-up almost instantaneously. However, if the unit has its power switch in the on position and is then powered by VAC voltage via the rear panel the unit will take 3 to 4 seconds to power-up. This is normal, the internal power supply of the FM-1 takes 3 to 4 second to power up if powered-up cold.

Start-up Screen

When the FM-1 is powered-up the start-up screen will be displayed for 5 seconds.



The lower left-hand corner contains the software version in the FM-1. After the start-up screen the event screen will be displayed. The event screen is the main default screen. It will display the current event in FM-1 memory. Up to 99 events may be stored in the FM-1 and on a card, see the "FM-1 Menu Flow Chart section for the menu structure.



Downloading a Card

The following steps download a card to the FM-1.

1. From the event screen press <MENU> once to arrive at the download card / select event menu screen.
2. Select download card with the <UP>/<DOWN> arrow buttons and press <SET> to go to the download screen.
3. Make sure the DataFlash card is in the FM-1 and press <SET>. The unit will indicate it is downloading from the card.
4. The FM-1 will say it has completed the download. After a few seconds it will now go to the event screen. The <MENU> button could also be pressed to proceed to the event screen.

The contents on the DataFlash card write over all previous FM-1 memory.

Selecting an Event and Downloading to System

The following steps select an event that has been downloaded from a DataFlash card to the FM-1. Then that event is downloaded to the BTR-1s on the CAN bus.

1. From the event screen press <MENU> once to arrive at the download card / select event menu screen.
2. Select "select event" with the <UP>/<DOWN> arrow keys and press <SET> to go to the select event screen.
3. The last event in FM-1 memory will be displayed. Press <SET> and the current events in memory will be displayed. The event will begin flashing.
4. Use the <UP>/<DOWN> arrows to select the event desired. Press <SET> at the displayed event to enter the system download screen.



5. Press <SET> again at the above screen to send the event to the system of BTR-1 base stations.
6. After programmed, press <MENU> to arrive back at the event screen.

As the BTR-1s are programmed and confirmed the numbers displayed will blink and turn to normal characters to show programming did occur.

After programming the display will indicate the following:

Normal Numbers = The BTR-1 were programmed to the parameters downloaded.

Inverted Numbers = Programming of the base cannot be confirmed.

Snap Shot

The FM-1 can take snap shots of the base station connected to its' CAN bus. This is a record of the base station's frequencies and settings at the time the snap shot is taken.

1. From the event screen press <Snap Shot> for about 2 seconds. The following screen will occur. Make sure there is a DataFlash® in the FM-1.

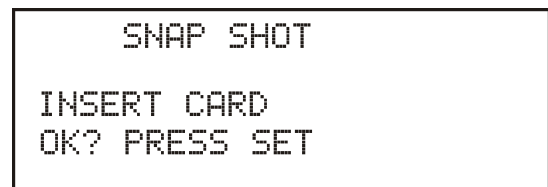

2. Press <SET> to take the snap shot.

A snap shot is saved to the DataFlash card. If the snap shot is successful, the confirmation screen displays, then defaults to the event screen.

Up to 10 snap shots may be placed on a DataFlash card.

DataFlash is a registered trademark of Atmel Corporation

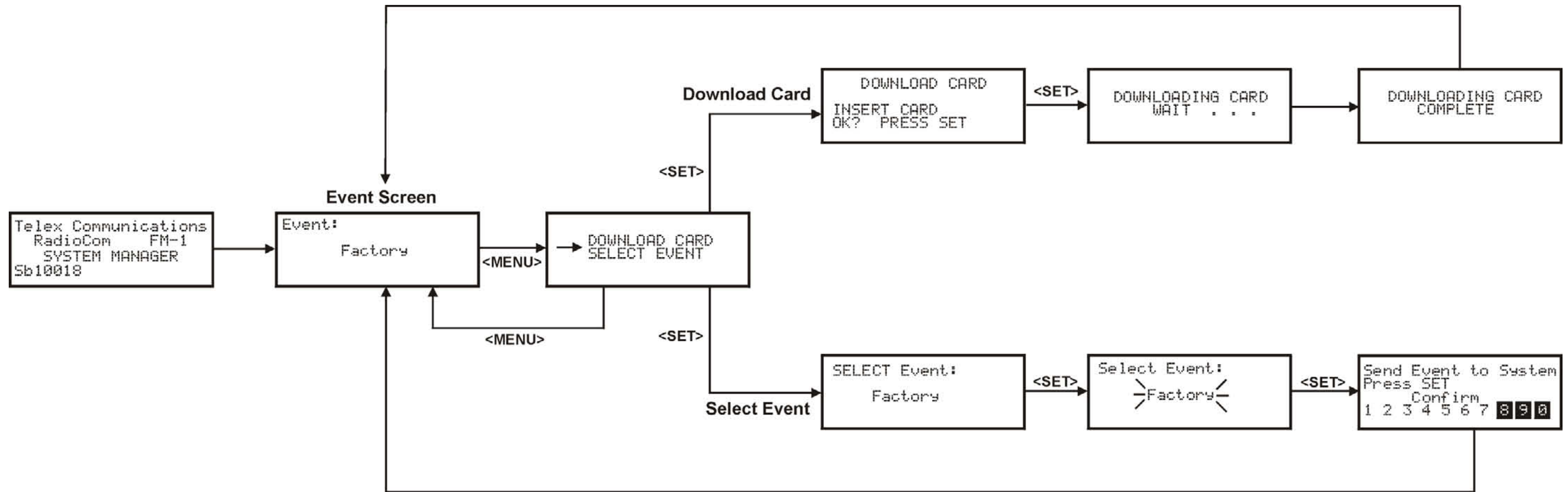

Figure 5-1
FM-1 Menu Flow Chart

End-User License Agreement for Telex® Software

IMPORTANT - Please read this document carefully before using this product.

THIS DOCUMENT STATES THE TERMS AND CONDITIONS UPON WHICH TELEX COMMUNICATIONS, INC. (the "COMPANY") OFFERS TO LICENSE THE INSTALLED SOFTWARE OR PROGRAM (the "SOFTWARE") FOR USE WITH THE PRODUCT IN WHICH IT WAS INSTALLED. YOU ARE AGREEING TO BECOME BOUND BY THE TERMS OF THIS AGREEMENT. IF YOU DO NOT AGREE TO THE TERMS OF THIS AGREEMENT, DO NOT USE THIS PRODUCT. PROMPTLY RETURN THE PRODUCT TO THE PLACE WHERE YOU OBTAINED IT FOR A FULL REFUND.

The installed software as supplied by the Company is licensed, not sold, to you for use only under the terms of this license, and the Company reserves all rights not expressly granted to you. You own the product or other media on or in which the Software is originally or subsequently recorded or fixed, but the Company retains ownership of all copies of the Software itself.

1. License: This license allows you to use the Software for internal purposes only on a single product in which it was installed.
2. Restrictions: (a) You may not market, distribute or transfer copies of the Software to others or electronically transfer or duplicate the software. YOU MAY NOT REVERSE ENGINEER, DECOMPILE, DISASSEMBLE, MODIFY, ADAPT, TRANSLATE, RENT, LEASE OR LOAN THE SOFTWARE OR CREATE DERIVATIVE WORKS BASED ON THE SOFTWARE OR ANY ACCOMPANYING WRITTEN MATERIALS. (b) The Software and the accompanying written materials are copyrighted. Unauthorized copying of the Software, including portions thereof or the written materials, is expressly forbidden. (c) You understand that the Company may update or revise the Software and in so doing incurs no obligation to furnish such updates to you.
3. Limited Warranty: The company does not warrant that the operation of the Software will meet your requirements or operate free from error. The company DISCLAIMS ALL OTHER WARRANTIES AND CONDITIONS EITHER EXPRESS OR IMPLIED, INCLUDING THE WARRANTIES OF MERCHANTABILITY, FITNESS FOR A PARTICULAR PURPOSE AND NON-INFRINGEMENT OR THIRD PARTY RIGHTS.
4. Limited Liability: The liability of the company for any claims arising out of this License based upon the Software, regardless of the form of action, shall not exceed the greater of the license fee for the Software or \$50.

DataFlash Card Handling and Storage Precautions

- Do not disassemble or remodel
- Keep out of reach of children. Danger of swallowing. If swallowed, seek medical advice immediately
- Do not impact, bend, drop or get wet
- Do not touch the metal terminals with or hands or metal objects
- Do not detach the label on the card
- Do not store in location directly exposed to sunlight, a heat vent, or a heating appliance
- Do not use or store in humid or dusty locations
- Do not use or store in locations exposed to corrosive gases
- Formatting will erase all existing data on the card

Telex Communications, Inc. is not responsible for lost or destroyed data in the card.

Frequency Bands

The BTR-1 system operates in TV channels 16 to 36 and 38 to 59. This is the frequency range of 482 to 608 MHz and 614 MHz to 746 MHz. The band, the TV channels and frequencies are shown in Table 2. Most bands are 18 MHz wide, however band 7 is 24 MHz wide.

Bands F to E are always base transmit bands (beltpack receive bands). Bands 1-7 are always base receive bands (beltpack transmit bands). Thus an A2 base station would be comprised of an A band transmitter paired with a 2 band receiver.

Band Pairing for Systems

All band pairs cannot be made into a system (a single system is comprised of a base and beltpack). Table 1 show the available band pairings.

Base TX Bands	Base RX Bands
F	1, 2, 3, 4, 5, 6, 7
H	1, 2, 3, 4, 5, 6, 7
A	2, 3, 4, 5, 6, 7
B	3, 4, 5, 6, 7
C	4, 5, 6, 7
D	5, 6, 7
E	6, 7

Table 1
Available Band Pairings

In Table 1 it can be seen that a C base station transmit band can be paired with 4, 5, 6 or 7 receive bands. However, a C3 unit cannot be made. This is because a certain amount of frequency separation between transmit and receive bands is required for good transmit and receive operation. If they are too close the RF performance of the system is reduced.

Band	TV	Freq. Start	Freq. End
F	16	482	488
	17	488	494
	18	494	500
H	19	500	506
	20	506	512
	21	512	518
A	22	518	524
	23	523	530
	24	530	536
B	25	536	542
	26	542	548
	27	548	554
C	28	554	560
	29	560	566
	30	566	572
D	31	572	578
	32	578	584
	33	584	590
E	34	590	596
	35	596	602
	36	602	608
Not Used	37	608	614
1	38	614	620
	39	620	626
	40	626	632
2	41	632	638
	42	638	644
	43	644	650
3	44	650	656
	45	656	662
	46	662	668
4	47	668	674
	48	674	680
	49	680	686
5	50	686	692
	51	692	698
	52	698	704
6	53	704	710
	54	710	716
	55	716	722
7	56	722	728
	57	728	734
	58	734	740
	59	740	746

Table 2
Band Names and TV Channels

Section 9

Replacement Parts and Accessories

QSB-1 Card Reader

P/N 879845

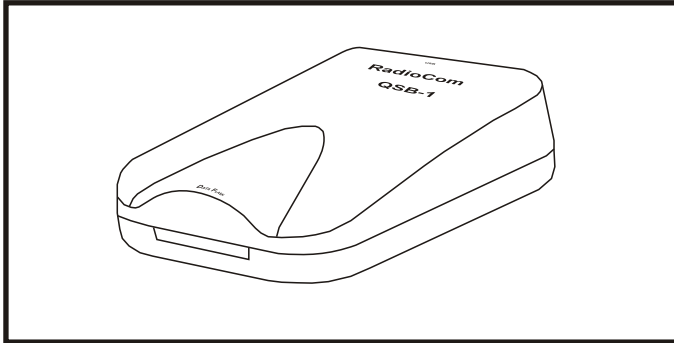

USB Cable

P/N 600091

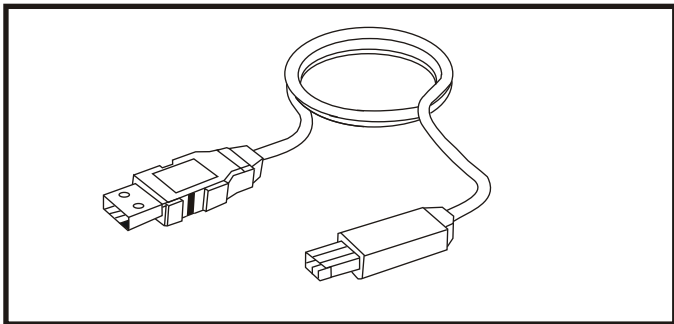

2 MB DataFlash® Memory Card

P/N 760600

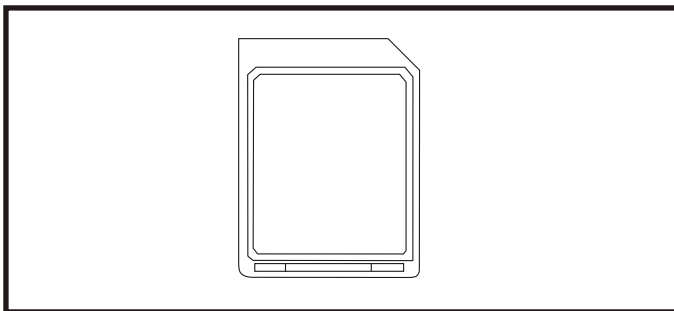

QSB-1 Kit

Includes: QSB-1 Card Reader

USB Cable

DataFlash® Card

Cat No. 301641000

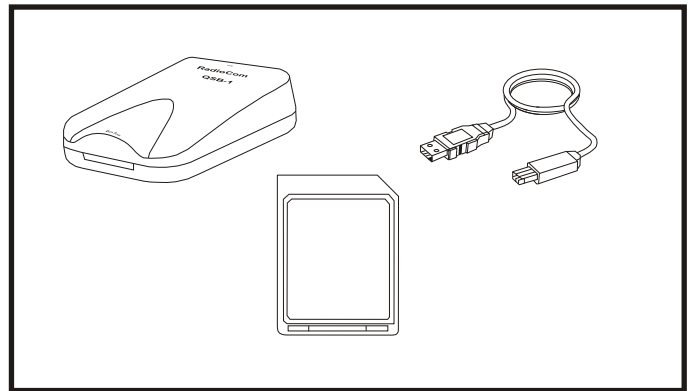

Power Cord for FM-1

North America

550024013

CAN BUS Cable

17" RJ-45 Male Connectors

P/N 879483

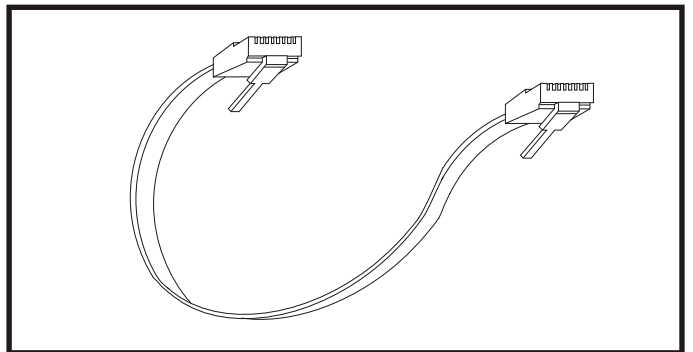

DataFlash® is a registered trademark of Atmel® Corporation

TELEX[®]

TELEX COMMUNICATIONS, INC. • 12000 Portland Ave. South, Burnsville, MN 55337.

PN 803996 REV B

MARCH 2005

Made in U.S.A.

Free Manuals Download Website

<http://myh66.com>

<http://usermanuals.us>

<http://www.somanuals.com>

<http://www.4manuals.cc>

<http://www.manual-lib.com>

<http://www.404manual.com>

<http://www.luxmanual.com>

<http://aubethermostatmanual.com>

Golf course search by state

<http://golfingnear.com>

Email search by domain

<http://emailbydomain.com>

Auto manuals search

<http://auto.somanuals.com>

TV manuals search

<http://tv.somanuals.com>