

# Telex

---

## Operating Instructions

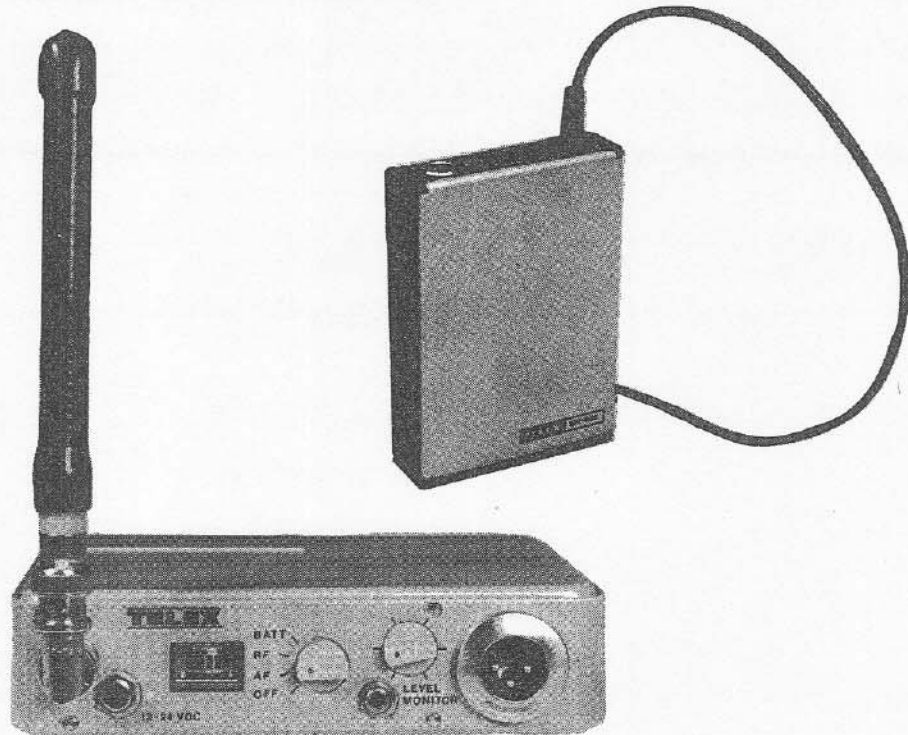

**Professional Wireless  
Microphone System  
ENG-4  
WT-400**

---

**TELEX.**

---

# INTRODUCTION

## WHAT IS A WIRELESS MICROPHONE SYSTEM?

**Microphone:** This is an electro-acoustic transducer which responds to sound waves and deliver essentially equivalent electrical waves. These electrical waves are sent to the belt transmitter or handheld unit.

**Transmitter:** The transmitter generates and amplifies an RF (Radio Frequency) carrier signal, modulates this carrier with the microphone signal, and radiates the modulated RF carrier.

**Receiver:** The FM VHF receiver is tuned to the frequency of the transmitter. The receiver picks up the radiated RF signal from the transmitter through the antenna and converts the RF signal into audio voltages for use with PA, Line, Network, etc. The receiver frequency must be matched to the transmitter frequency.

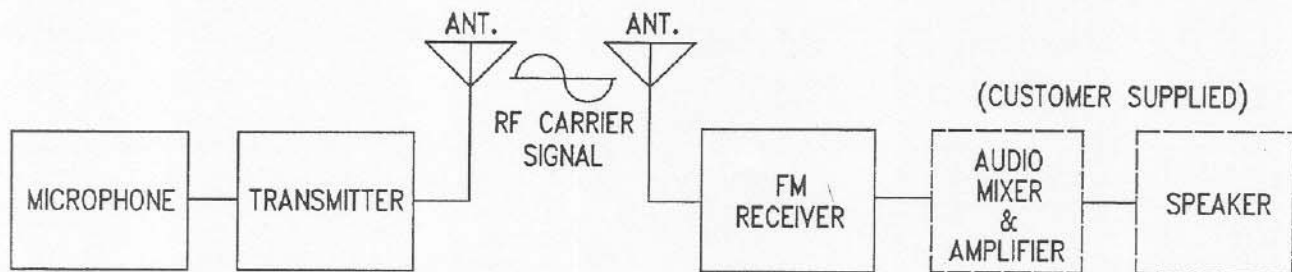

Figure 1  
Block Diagram of Typical Wireless Microphone System

## WHAT FREQUENCY BAND DOES THE TELEX SYSTEM OPERATE IN?

The Telex ENG-4 System features dual channel, crystal controlled transmitters and four channel receivers operating in the VHF Band between 150-216 MHz. There are 10 standard frequencies available.

Your system operates on a fixed frequency which can be computer selected to provide "interference free" operation. Up to seven systems can be operated in a single location simultaneously, without intermodulation.

## OFTEN ASKED QUESTIONS

**Q**uestion: Can more than one microphone be used simultaneously?

**A**nswer: Yes, but never on the same frequency. You will need to have different frequencies for every receiver/transmitter combination. All units are factory set for specific frequencies.

---

**Q**uestion: Is the system more sensitive in any one particular direction?

**A**nswer: No, the transmitter's antenna radiates equally in all directions, but the signal is attenuated by your body, walls or other surrounding objects. The receiving antenna is essentially sensitive in all directions as well, except when using a directional antenna.

---

**Q**uestion: Can the receiver receive other transmissions when the transmitter is turned off?

**A**nswer: Yes it can. The Telex ENG-4 system operates in VHF band between 150-216 MHz. However, it is not susceptible to radio wave skip, CB'ers or standard FM radio transmissions.

The frequency on which your system operates can be computer selected for least interference, but there is no such thing as a 100% clear channel all the time, anywhere in the U.S.A., forever!

If the system is going to be used in a permanent fixed location, the system should operate interference free until such a time or date when someone else begins using the same frequency.

If the system is going to be moving among various locations, you will inevitably run into occasional frequency conflicts.

In either case, when you're not using the wireless microphone, turn the gain down on your audio mixer, just as you would a wired microphone. If a mixer control is not available, turn the receiver off when the transmitter is not in use. This will prevent the reception of undesired signals.

If a mixer control is not available and the system must be left on, the transmitter should be left on to prevent the receiver from picking up outside interference.

---

# ENG-4 TECHNICAL INFORMATION

**General Description:** A fully transportable VHF FM receiver ideally suited for electronic news gathering, film or sound recording, or other such activities.

**Features:** Small size, light weight and is self contained.

## Controls and Connections (Front Panel):

Rotary Function Switch/Meter ..... 4-position rotary switch with meter.  
Position - OFF ..... Non-functional, no current drain.  
Position - AF ..... Built in meter monitors audio output.  
Position - RF ..... Built in meter monitors RF received.  
Position - BATT ..... Built in meter monitors battery voltage.  
Level Monitor ..... Adjusts volume to headphone output jack.  
Antenna Jack ..... BNC jack (supplied with flexible antenna for frequencies installed).  
+9-28 VDC Jack ..... For external power input.  
Accepts 9 to 28 VDC, center pin is positive.  
XLR Connector ..... For MIC or LINE level output (selectable via MIC/LINE Switch).  
Line Output ..... For 600 ohm balanced line output.  
Mic Level Output 200 ohm balanced mic level output (adjustable via Mic Level Control).

## Controls (Rear Panel):

Mic Level ..... Controls mic level output to front panel XLR Connector.  
Screwdriver adjustable, rotary type  
LINE/MIC Switch ..... Slide switch that selects LINE or MIC level output for  
front panel XLR connector. Screwdriver adjustable.  
Comandor IN/OUT ..... Slide switch that controls comandor operation.  
Must be set to match transmitter operation. Screwdriver adjustable.  
Channel A/B/C/D ..... RF Channel (operating frequency) selection. Must be set  
to match transmitter channel or frequency. Screwdriver adjustable, rotary type.  
Battery Release ..... Squeeze to release slide locks. Internal battery  
holder pops up through top of case.

## ENG-4 Specifications:

Type ..... Single conversion superheterodyne.  
Frequency Range ..... 150-216 MHz  
Any 1 of 4 frequencies selectable by external switch. 0.005% crystal stability.  
Modulation ..... Frequency modulation, 12 kHz. Nominal 50  $\mu$ S de-emphasis.  
IF Frequency ..... 10.7 MHz.  
IF Selectivity ..... 9-pole filter, 150 kHz wide, -6 dB/370 kHz wide, -60 dB.  
Sensitivity ..... 1.0  $\mu$ V or less/0.5  $\mu$ V typical for 12 db SINAD.  
Image Rejection ..... 90 dB.  
Spurious Rejection ..... 70 dB.  
Signal to Noise Ratio ..... (ultimate),  
Comandored ..... 104 dB.  
Uncomandored ..... 68 dB.  
Squelch Threshold ..... Internal, set at 1.0  $\mu$ V.  
Squelch Quieting ..... 100 dB.  
Quieting ..... (ultimate) Ref: 12 kHz deviation, 104 dB.  
Dynamic Range ..... Ref: 12 kHz deviation, 104 dB.  
Audio Distortion ..... 1% or Less. 0.5% typical at full output (1 kHz).

Audio Frequency Response .....	$\pm 1$ dB, 100-15000Hz.
Headphone Output Jack Power .....	1 kHz.
350 mW (8 ohm load)	
200 mW (16 ohm load)	
100 mW (32 ohm load)	
Line Level Output .....	+ 14 dBm Maximum (12 kHz deviation).
Mic Level Output .....	Adjustable,
-7 dB Maximum (200 ohms), (12 kHz deviation)	
-21 dB Minimum (200 ohm), (12 kHz deviation)	
Battery .....	Four AA alkaline or nickel-cadmium required for internal use.
Current drain .....	95 mA nominal.

## WT-400 TECHNICAL INFORMATION

**General Description:** A belt worn battery powered VHF FM Transmitter ideally suited for any activity requiring a cordless portable microphone.

**Features:** Small size, lightweight and is self-contained.

### Controls and Connections (Front Panel):

Power OFF/ON Switch .....	Low profile slide switch, allows access to power OFF/ON.
Microphone Gain Control .....	Screwdriver adjust for microphone gain control.
Frequency Switch .....	Slide switch, choose either channel A or B Frequency.
Microphone Connector .....	4-pin LEMO connector.
Antenna .....	Permanent, strain relief, flexible wire type.

### Controls and Connections (Internal):

Comandor IN/OUT Switch .....	Slide switch.
Antenna .....	Flexible wire type, permanently attached to the front panel (top)
Battery Compartment .....	For 9 volt alkaline, Mallory MN1606 or equivalent. Average life is 6-8 hours minimum.
Battery Test .....	A red LED is mounted on the front panel. A fresh battery will cause the LED to flash one time when the transmitter is turned on. A week battery will illuminate the LED constantly. A dead or unusable battery will show no indication.

### WT-400 Specifications:

Type .....	Direct FM, x 9 multiplication.
Frequency Range .....	150-216 MHz (one of two frequencies selectable from front panel switch, A or B) /0.005% crystal stability.
RF Power Output .....	50 mW maximum, 45 mW typical.
Modulation .....	Frequency Modulated, 12 kHz deviation Nominal 50 $\mu$ S pre-emphasis.
Microphone Input .....	100-10k ohm dynamic, or electret (+ 5 volts bias available).
Microphone Gain .....	Screw driver adjustable. 0.007 V RMS input required for 100% modulation. 1.0 V RMS maximum acceptable input.
Modulation Limiter .....	Internal Compressor (Comandor System).
Battery .....	9.0 Volts nominal.
Current drain .....	40 mA typical

# ENG-4 CONTROLS AND CONNECTIONS

27049-A-003

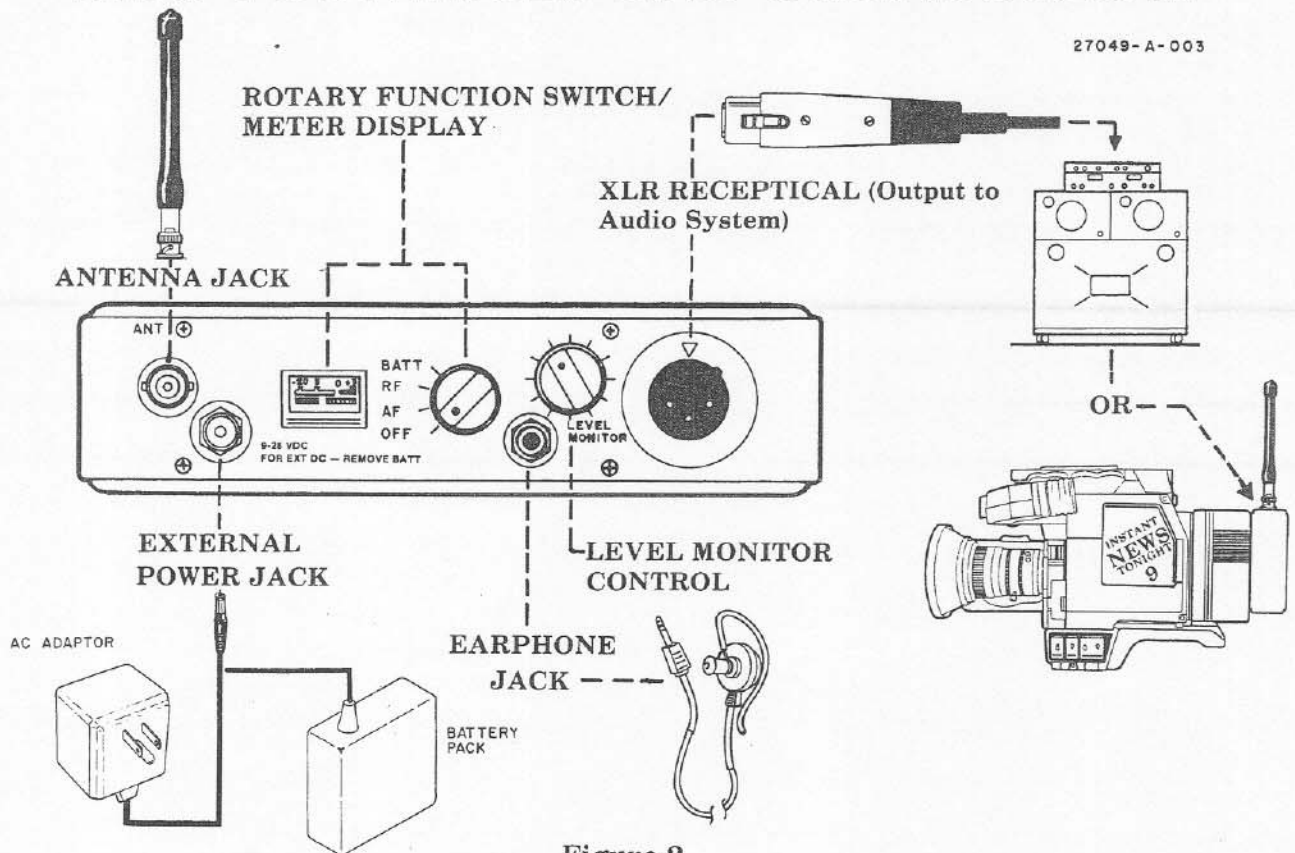

Figure 2  
Front Panel — ENG-4

**Antenna Jack:** BNC type receptical, Refer to Antenna Connection, Page 9 and Figure 9.

**External Power Jack:** For external power source, 9 VDC to 28 VDC/100 mA. Refer to Figure 7.

**Rotary Function Switch/Meter Display:**  
ROTARY FUNCTION SWITCH - 4-position switch:

OFF Position - Non Functional - no current drain.

AF Position - Indicates relative modulation of the system (Audio Output).

RF Position - Indicates when the ENG-4 is receiving a transmitter signal (Carrier Indicator). Indication is relative only. Red bar normally indicates weaker RF Signal, Green bar normally indicates stronger RF Signal.

BATT Position - The meter indicates the relative battery condition. Red bar indicates weak or marginal batteries, Green bar indicates good batteries.

METER DISPLAY - A tri-color meter, relative indication of Audio Output (AF), received signal (RF), or battery condition. Selectable via the Rotary Function Switch.

**Earphone Jack:** Connect to supplied earphone for monitoring incoming audio from transmitter's microphone.

**Level Monitor Control:** Adjusts volume to earphone output jack. DOES NOT AFFECT MIC OR LINE LEVEL.

**XLR Receptical:** Output to audio sound system (Amplifier/Mixer, Video-Cam, etc.). Output is adjustable for MIC Output by means of the MIC Level Control. MIC/LINE Switch must be in the "MIC" position to be adjustable. Refer to Receiver Output Connection, pages 9 and 10.

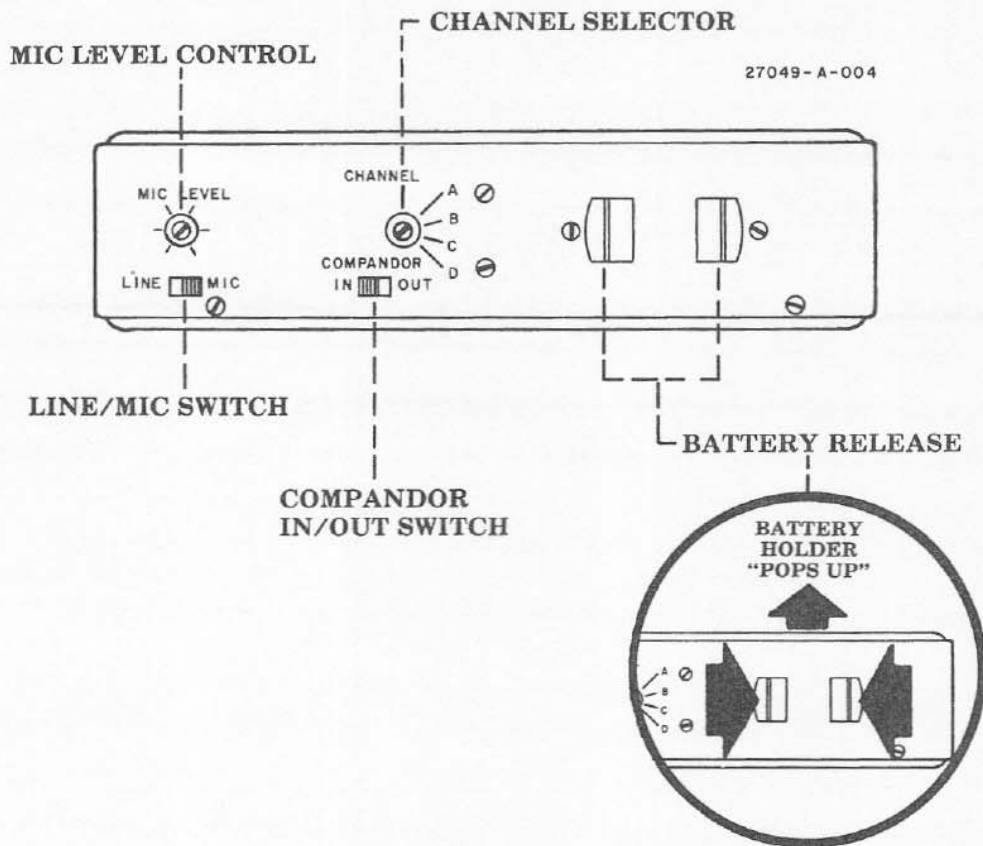

**Figure 3**  
**Rear Panel — ENG-4**

**MIC Level Control:** Rotary, screwdriver adjustable control which controls MIC Level Output to the front panel XLR receptical when selected by LINE/MIC Switch. (200 ohm balanced MIC Level Output).

**LINE/MIC Switch:** A slide switch that selects LINE or MIC level output for front panel XLR receptical. Use supplied plastic screwdriver to operate slide switch to desired position.

**Compandor IN/OUT Switch:** A recessed slide switch that controls compandor operation. Must be set to match transmitter operation. Use supplied plastic screwdriver to slide switch to desired position.

**Channel Selector:** Choice of 4 separate RF channels (operating frequency). Must be set to match transmitter channel or frequency. Screwdriver adjustable.

**Battery Release:** Squeeze to release slide locks. Internal battery holder pops up through top of case.

# WT-400 CONTROLS AND CONNECTIONS

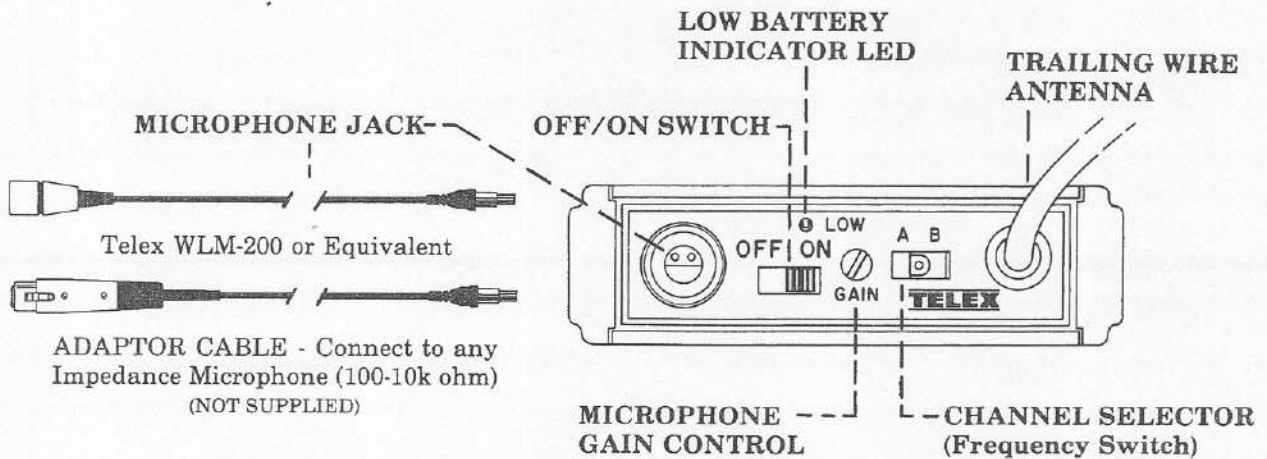

Figure 4  
Top Panel — WT-400

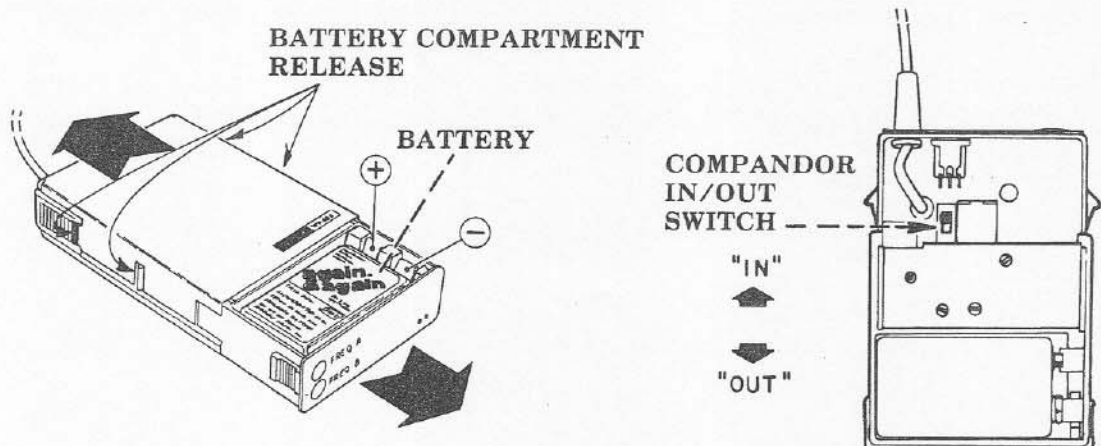

Figure 5  
Internal View — WT-400

**Microphone Jack:** The WT-400 was designed to easily interface with dynamic or electret microphones in the 100-10k ohm impedance range. A (10k ohm) resistor is permanently wired to the audio circuit to provide a source for electret microphones. No XLR adaptor cable is provided with this system. It was designed to utilize the Telex WLM-200 microphone.

**OFF/ON Switch:** A low profile slide switch is provided to allow access to power OFF/ON.

**Low Battery Indicator LED:** Part of the battery check circuit. When the power switch is placed in the "ON" position the LED will flash one time if the battery is good. A poor battery will cause the LED to be illuminated continuously and a bad or unusable battery will not cause any illumination at all.

**Trailing Wire Antenna:** A fully flexible ¼-wave antenna with a permanent strain relief.

**Microphone Gain Control:** Screwdriver adjustable. Adjusts the Audio Gain of the microphone either up or down.

**Channel Selector (Frequency Switch):** A slide switch which allows the user to select either Channel A or B frequency. Screwdriver adjustable.

**Battery Compartment Release:** Depressing the two side spring latches and pulling the bottom of the case downward exposes the battery compartment.

**Compandor IN/OUT Switch:** Internal switch allows the user to control the WT-400 compandor operation. Must be set to match receiver operation.



**FOR LINE LEVEL CONNECTION (Less Common):** This connection is identical to MIC LEVEL connection with the following exceptions:

Place the output level switch in the LINE position. A 2-conductor phone plug will be needed on the Mixer/Amplifier end of the audio cable to connect to the 1/4 inch line input jack. See Figure 11.

After you have selected either MIC or LINE operation, turn the Monitor Level Control down (counterclockwise) and attach a monitor earphone, if desired. Adjust listening level to suit.

**NOTE:** MIC output is 200 ohms, adjustable level via the MIC LEVEL Control. LINE output is 600 ohms, fixed level.

Set the Channel Selector Switch to match the transmitter.

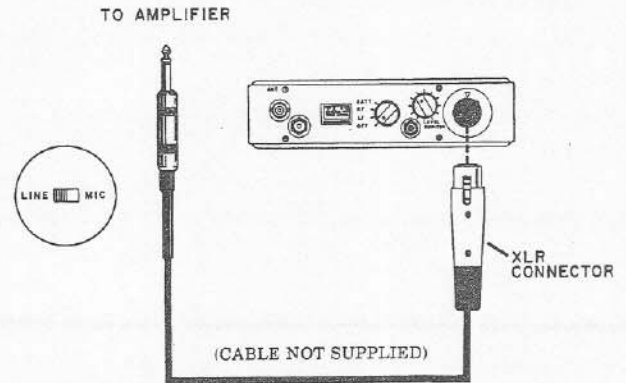
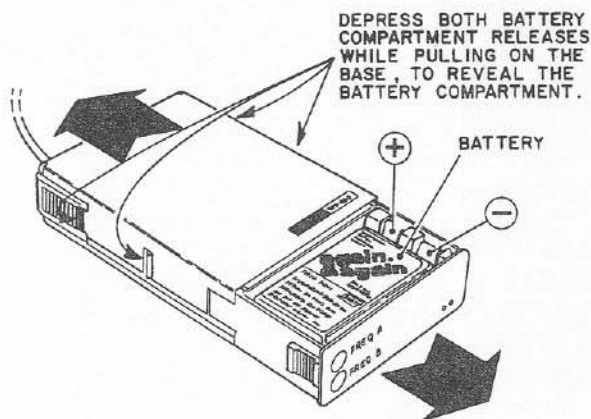

**Figure 11**  
"LINE LEVEL" Connection

## TRANSMITTER SET-UP AND CONNECTIONS

**Battery Installation:** Insure that the power switch is in the "OFF" position. Depress the two spring latches (See Figure 12) on each side of the case. Pull the front panel assembly forward until the transmitter is removed from the case. Insert the battery as shown in Figure 12, making sure the proper polarity is observed.

27049-A-005



**Figure 12**  
Battery Installation - WT-400

**Comparator IN/OUT:** Determine whether it is desired to operate with the comparator IN or OUT. Basically, this is a personal choice. Some operators prefer to operate with the comparator OUT, even at the expense of signal-to-noise ratio and other advantages of comparator operation. In any case place the internal comparator switch (See Figure 5) to the "IN" or "OUT" position, as desired.

**NOTE:** Double check to be sure that the receiver comparator switch is in the same position as the transmitter, either IN or OUT.

**Microphone Connection:** Reinsert the transmitter into the case until the latches are secure. Plug the microphone into the transmitter. Refer to Figure 13. (If the microphone brand that you are using is other than Telex, request "Technical Bulletin No. PA-84-1" for interface information.

Using the screwdriver provided, set the Frequency Switch to A or B, to match the receiver.

LEMO CONNECTIONS

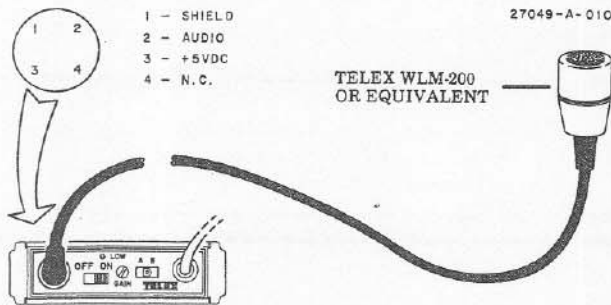

Figure 13  
Microphone Connection

**Battery Check:** Set the power switch to the "ON" position. Note that the battery LED (labeled LOW) should flash one time on a good battery. A poor battery will cause the LED to be illuminated continuously and a bad or unusable battery will not cause any illumination at all. Set the power Switch to the "OFF" position. Refer to Figure 4.

Assuming that you have set-up the receiver previously, proceed to the "Setting System Gain Levels" section.

## SETTING SYSTEM GAIN LEVELS

**Introduction:** If you have followed the instructions up to this point you should now be ready to set optimum signal gain settings on each unit.

### Transmitter Gain Setting:

**STEP 1**

Turn the ENG-4 receiver Function Switch to the "RF" position.

Set the WT-400 power switch to the "ON" position. The ENG-4 meter should indicate in the "GREEN" area. Turn the ENG-4 Function Switch to the "AF" position. See Figure 14.

27049-A-009

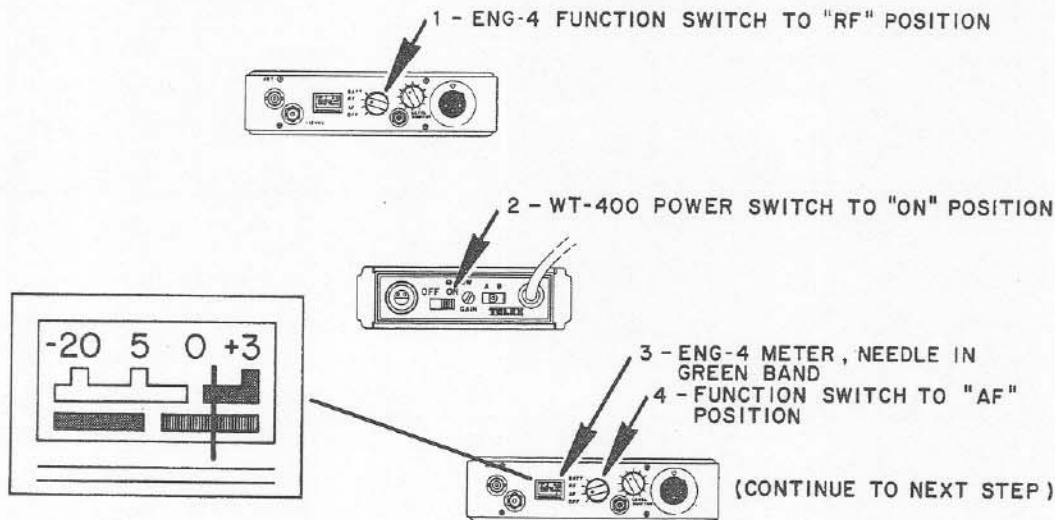

Figure 14  
Checking Incoming RF Signal

## STEP 2

The microphone "GAIN" Control on your WT-400 has been factory set for normal or average audio levels.

**High Level Setting:** If your application is in a high SPL (Sound Pressure Level) area such as singing or instrumentation, the factory gain setting is probably too high and will result in overload or distortion. This will be indicated on the ENG-4 receiver meter between 0 to +3 (red).

**Low Level Setting:** If your application is in a low SPL area, the factory gain setting is probably too low. This will be indicated by low meter indication on the ENG-4 meter, -20 or below (white).

To correct either a too high or too low setting, adjust the Microphone Gain Control (screwdriver slot) on the front panel of the WT-400, so that average audio causes the meter to indicate between -20 to -5. An occasional overshoot into the RED area is allowable. Refer to Figure 15.

**Receiver Gain Setting:** After the transmitter gain has been properly set, you are now ready to set receiver gain.

**NOTE:** Insure that the Compandor IN/OUT switch on the receiver agrees with the transmitter Compandor IN/OUT Switch.

Set the LINE/MIC Switch as required. In the LINE position, there is no adjustment. The Line output level is fixed. In the MIC position, the output level is adjustable via the MIC Level Control (screwdriver slot). Refer to Figure 3.

Adjust the level to accommodate the mixer or other audio system.

**NOTE:** This control does not affect the ENG-4 meter indication.

If monitoring is required, plug the earphone (supplied) into the Monitor Jack on the front of the ENG-4 receiver and adjust the Monitor Level Control for comfortable listening. Adjusting the Monitor Level DOES NOT affect the MIC LEVEL. They are independent functions. Refer to Figure 2.

27049-A-008

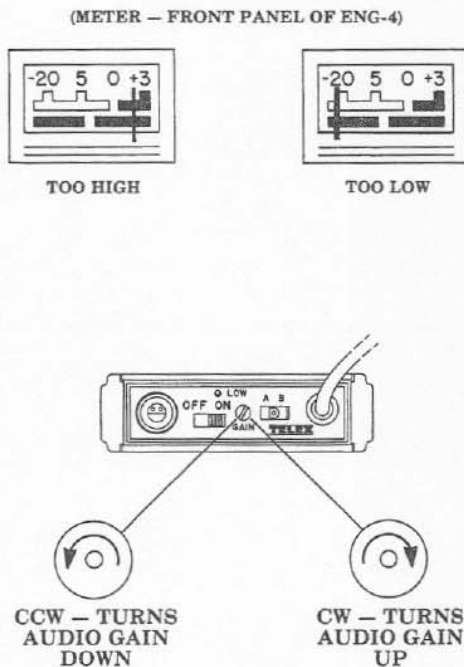

**Figure 15**  
**High Level and Low Level**  
**Gain Adjustment**

# SYSTEM WALK-THRU

**General:** Now that you have successfully "set up" your Telex Wireless System and turned on your sound equipment (amplifier/mixer, video cam etc.), you are ready to test the overall performance by "Walking" the Telex transmitter through the areas in which you will be using it.

The "system walk-thru" can detect the following RF problems:

Weak signal strength caused by:

1. Poor antenna location
2. RF "Trouble Spots"
3. Operating distance beyond System capability
4. Malfunctioning system

**Carrier Indication:** Under normal conditions with the Rotary Function Switch in the "RF" position the carrier indication on the meter should always be center scale or higher (green area) with the transmitter "ON". See Figure 14.

"Weak Signal" conditions will result in low meter indication with the potential of actually "hearing" this in the sound system.

**Audio Feedback:** The system walk-thru can also uncover locations in the performing area which are prone to audio feedback (usually sounds like a "squeal" or a "howl"). Feedback can be a problem for any microphone — whether wired or wireless. To eliminate feedback observe placement of the microphone and any nearby loudspeakers.

In 99% of all instances you will set up your Telex Wireless System, walk it through and achieve error-free performance. If in the rare instances your Telex System does not "pass" during your walk-thru evaluation, refer to the last two sections of this manual which deal with Antenna Information and System Troubleshooting.

## TROUBLESHOOTING

Reread the sections of this manual to make sure you have completed system set-up properly.

PROBLEM	SOLUTION
<b>DISTORTION</b> — System's audio quality seems distorted at medium to high input levels.	Reduce audio gain on the transmitter by adjusting gain control as suggested on Pages 11 and 12.
<b>HISS</b> — System seems to produce a "hiss" which is undesirable.	Check the gain settings on both the transmitter and receiver as indicated on Pages 11 and 12, they may be too low. Check Compandor IN/OUT Switch.
<b>LOW OUTPUT</b> — System produces a lower output level than wired microphone in sound system.	Check the gain settings on both the transmitter and receiver as indicated on Pages 11 and 12, they may be too low.

## TROUBLESHOOTING CONT.

PROBLEM	SOLUTION
<p>FEEDBACK — Moving around performing area produces “squeal” or “howl” in various locations.</p>	<p>Reduce gain settings on wireless system and sound system. Readjust nearby loudspeakers.</p>
<p>DROPOUTS — When moving around performing area there seem to be locations where the signal “swooshes” or completely disappears.</p>	<p>Make sure the antenna is connected and follow the location suggestions on Pages 16 and 17. Change the location of the receiver/antenna or avoid the bad area with the transmitter.</p>
<p>INTERFERENCE — System picks up signals other than wireless transmitter.</p>	<p>Make sure Telex transmitter is turned on — this will usually eliminate the interfering signal.</p> <p>If problems persist with Telex transmitter on, you will probably need to have your system’s frequency changed to another channel.</p>
<p>REDUCED DISTANCE — System doesn’t operate as far as it once did. System doesn’t operate as well as you think it should.</p>	<p>Transmitter battery is possibly in need of replacement. Receiver antenna possibly located incorrectly. See Pages 16 and 17 for proper placement.</p>
<p>BATTERIES DON’T LAST (TRANSMITTER)</p>	<p>If using “throw away” batteries, make sure they are alkaline (Mallory MN1604 or equivalent). If using nickel-cadmium, make sure it is an 8.4 volt, 7.2 volt batteries won’t work. Refer to Page 15.</p>
<p>BATTERIES DON’T LAST (RECEIVER)</p>	<p>If using “throw away” batteries, make sure they are AA alkaline (Mallory MN1500) or equivalent.</p>

If you are unable to solve the problem contact the dealer from whom you purchased the system for assistance.

# BATTERY INFORMATION

**General:** Improper battery selection, use, installation and care are the cause of numerous wireless system failures.

**Alkaline Batteries:** Alkaline batteries such as Mallory's DURACELL® or Eveready's ENERGIZER® provide the most reliable operation in wireless transmitters. The use of low cost carbon-zinc batteries is **NOT** recommended.

**Nickel-Cadmium Batteries:** These batteries can save you money in the long run, as they can be recharged, but they can also cause disappointing wireless performance. If you want to use rechargeable nickel-cadmium batteries you must select a heavy duty nickel-cadmium. Conventional 9 volt size such as GE® or Radio Shack® are only capable of providing 7.2 volts, which is not sufficient to power the Telex WT-400 transmitter.

**Nickel-Cadmium Memory Effect:** For maximum performance and longer life from nickel-cadmium batteries you should completely discharge them whenever possible. This can be done by simply leaving the Telex transmitter turned on overnight. If nickel-cadmiums are not discharged on a regular basis they will remember how long you use them for each performance and will not have the ability to retain their original performance.

Battery Type	Volts	Expected Life
Conventional "RAY-O-VAC" Carbon Zinc	9	Not Recommended
Alkaline "MALLORY" MN1604 or Equivalent	9	6 to 8 Hours
GE or Radio Shack Nickel-Cadmium Rechargeable	7.2	Does Not Work
Varta or Gould "Again and Again" Nickel-Cadmium Rechargeable	8.4	1½ to 2 Hours per charge

**Table 1**  
**Battery Information for WT-400**

Battery Type	Size	Expected Life With ENG-4
Alkaline "EVEREADY" #E91 or Equivalent.	AA	6-8 Hours Typical
EVEREADY Nickel-Cadmium #CH15 or Equivalent	AA	4-5 Hours Typical

**Table 2**  
**Battery Information for ENG-4**

ENERGIZER® is a registered trademark of Union Carbide Corporation.

DURACELL® is a registered trademark of Duracell Inc.

GE® is a registered trademark of General Electric Company

Radio Shack® is a registered trademark of the Tandy Corp.

# ANTENNA INFORMATION

**Antenna Alignment:** To align the antenna properly refer to Figure 16.

27049-B-016

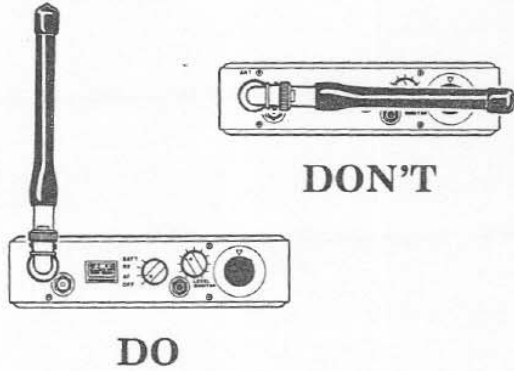

**DO**

**DON'T**

**Figure 16**  
Antenna Alignment  
Do and Don't

**Antenna Polarization:** The Telex Wireless System is "Vertically Polarized". This means both the transmitting and receiving antennas should operate in the vertical position.

27049-A-017

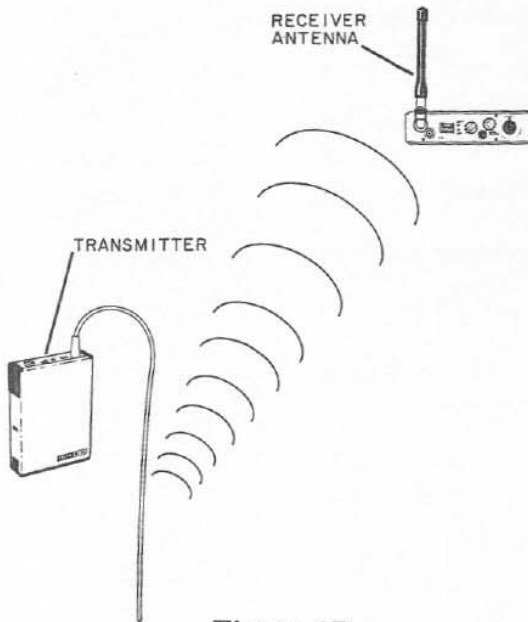

**Figure 17**  
Vertically Polarized Antenna

**Antenna Placement:** Keep the distance between the transmitter and the receiver's antenna as short as possible. The greater the distance, the weaker the signal.

27049-B-024

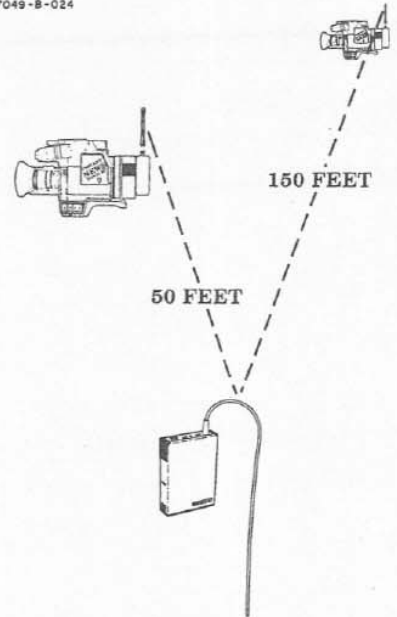

**Figure 18**  
Distance Between Transmitter  
and Receiver

Make sure the "signal path" between the transmitter and receiver's antenna is unobstructed. You should always be able to visibly locate the antenna at all times.

27049-A-019



**Figure 19**  
Keeping Site Clear to Antenna

Attempting to operate the wireless system through or around walls, ceilings, metal objects, etc., will reduce system range and performance.

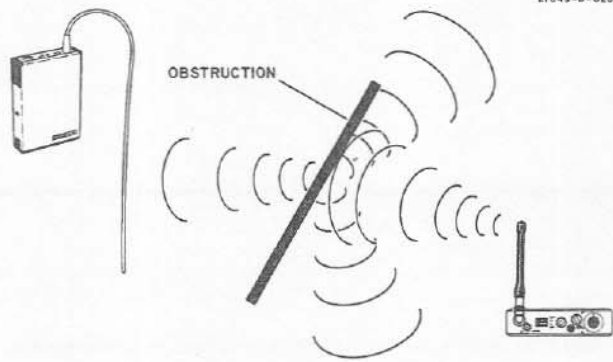

SIGNAL REFLECTION OFF A METAL OBSTRUCTION CAUSES REDUCED SIGNAL AND "MULTIPATH"

Figure 20  
Operating Through Obstructions

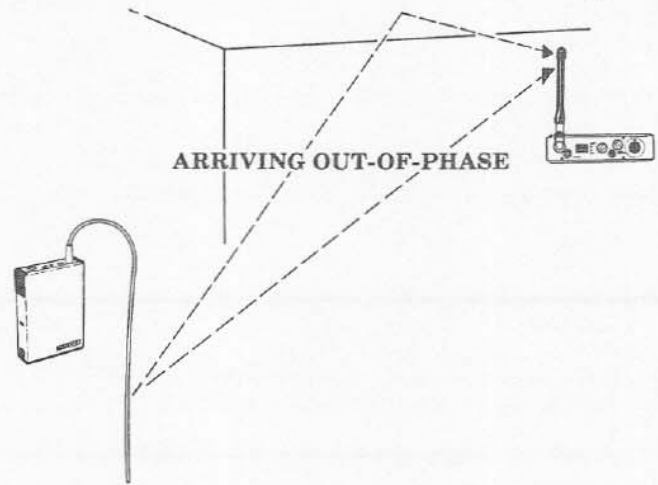

WALLS, CEILING, METALLIC OBJECTS, ETC. CAN CAUSE "MULTIPATH" BOUNCE RESULTING IN "DEAD SPOTS".

Figure 21  
Multipath Reception

**Dropouts/Picket Fencing:** A "signal dropout" can occur at any operating distance and is caused by the direct signal from the transmitter and reflected signals from the transmitter (called multipath) arriving at the receiving antenna out-of-phase.



## FCC REGULATION

The Telex Model WT-400 Transmitter is Type Accepted under United States Federal Communications Commission Parts 90 and 74. The receiver ENG-4 is Type Accepted under Part 15 of the Federal Communications Commission. Licensing of Telex equipment is the user's responsibility and licensability depends upon the user's classification, user's application, and frequency selected. Telex strongly urges the user to contact the appropriate telecommunications authority for any desired clarification.

**CAUTION:** Changes or modifications made by the user could void the user's authority to operate the equipment.

## WARRANTY SERVICE INFORMATION

If your receiver or transmitter should need servicing under the warranty, please contact:

Warranty Service Department  
TELEX COMMUNICATIONS, INC.  
8601 East Cornhusker Highway,  
P.O. Box 5579,  
Lincoln, Nebraska 68505-5579 U.S.A.  
Phone: (402) 467-5321 or 465-7021

All claims of defect or shortage should be sent to the above address. When returning items for service, you must provide date and proof of purchase, such as a copy of the sales receipt, to establish warranty. A letter should be included outlining all symptoms and claimed defects. Information on how the equipment was installed and used is very helpful. Please include your phone number and return address in case our service technicians need to contact you.

Units that have been modified cannot be accepted for repair.

Include all information requested by the Service Center. Then pack the unit as follows:

Check the unit to see that all parts and screws are in place. Then wrap it in heavy paper or put it in a plastic bag. If the original carton is not available, place the unit in a strong carton that is at least six inches bigger in all three dimensions than the unit. Fill the carton equally around the unit with resilient packing material (shredded paper, excelsior, etc.). Seal it with gummed paper tape, tie it with a strong cord, and ship it by prepaid express, United Parcel Service or insured parcel post to the Hy-Gain Service Center.

It is very important that the shipment be well-packed and fully insured. Damage claims must be settled between you and the carrier and this can delay repair and return of the unit to you.

Telex reserves the right to make changes in design and improvement on its product without assuming any obligation to install the same on any of its products previously manufactured. Further Telex reserves the right to ship new and/or improved products which are similar to the form, fit and function of products originally ordered.

## ACCESSORIES

**Lapel Microphone** - Electret type comes with tie clip and lapel clip holder.

WLM-100/Order No. 63852-000

WLM-200/Order No. 63852-001

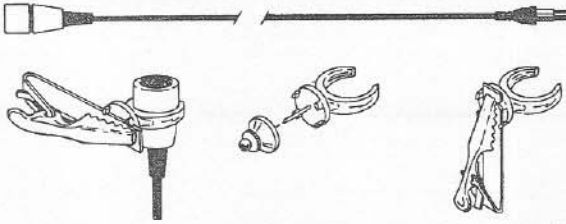

**Nickel-Cadmium Battery** - For WT-400 Transmitter 8.4 Volts

Order No. 63912-000



**PH-22 Headworn Microphone** - Close talking, noise cancelling electret.

Order No. 64327-002

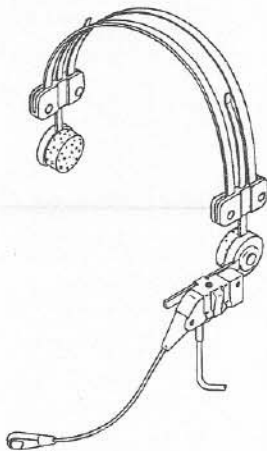

**Carrying Case** - For the WT-400 Transmitter

Order No. 59756-000

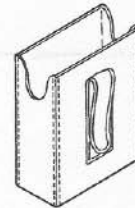

**Adaptor Cable** - SLR to LEMO adaptor cable for WT-400

Order No. 63841-000



**Carrying Case** - For the ENG-4 Receiver

Order No. 70372-000

**BC-2 Battery Charger** - For charging nickel-cadmium battery used in WT-400.

Order No. 64267-000

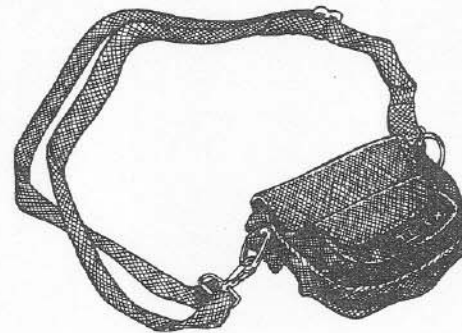
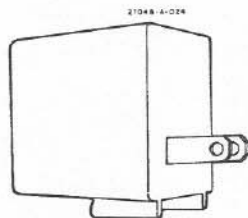

## REPLACEMENT PARTS

**Battery Sled Assembly** - For ENG-4 Receiver. Replacement or for extra battery holder.

Order No. 64480-000

**Earphone Assembly** - For ENG-4 for monitoring incoming audio from transmitter's microphone. Four separate parts.

- A Cord, CMT-98  
Order No. 60013-015
- B Eartip, ET-1  
Order No. 35608-000
- C Earloop, AEF-2  
Order No. 09252-000
- D Earphone, RTW-04  
Order No. 60012-005

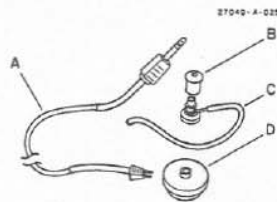

**Antenna Replacements** - For ENG-4 and WT-400. When ordering antenna order by the frequency of the receiver.

### ENG-4 Replacements

- 150-158 MHz/Order No. 57032-005
- 158-165 MHz/Order No. 57032-006
- 165-175 MHz/Order No. 57032-000
- 175-185 MHz/Order No. 57032-001
- 185-195 MHz/Order No. 57032-002
- 195-205 MHz/Order No. 57032-003
- 205-216 MHz/Order No. 57032-004

### WT-400 Replacement

- 150-216 MHz/Order No. 70277-000

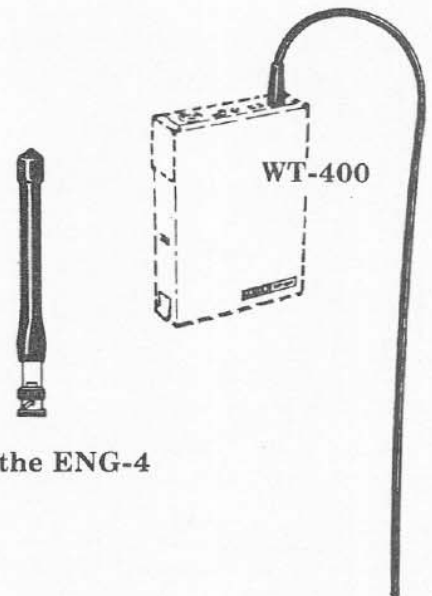

For the ENG-4

## Free Manuals Download Website

<http://myh66.com>

<http://usermanuals.us>

<http://www.somanuals.com>

<http://www.4manuals.cc>

<http://www.manual-lib.com>

<http://www.404manual.com>

<http://www.luxmanual.com>

<http://aubethermostatmanual.com>

Golf course search by state

<http://golfingnear.com>

Email search by domain

<http://emailbydomain.com>

Auto manuals search

<http://auto.somanuals.com>

TV manuals search

<http://tv.somanuals.com>