



Electro-Voice®

a MARK IV company

Model EVM-15L[®] PRO-LINE 15-Inch Professional Sound Reinforcement Loudspeaker

SPECIFICATIONS

Usable Frequency Response in TL606 Vented 3.2-Cubic-Foot Enclosure (see Frequency Response section):

60-6,000 Hz

Sound Pressure Level, Indicated Watts into Nominal Impedance (using spectrum specified in EIA Standard SE-103 Section SE3),

30 feet at .001 watt input:

53.5 dB

10 feet at 1 watt input:

93 dB

4 feet at 400 watts input:

127 dB

Long-Term Average Power Handling Capacity (see Power Handling section):

400 watts (per EIA Standard RS-426A)

Impedance, (see Figure 8),

Nominal:

8 ohms

Minimum:

6.5 ohms

Voice Coil Diameter:

6.35 cm (2.50 in.)

Magnet Weight:

2.2 kg (4.9 lbs)

Dimensions,

Overall Diameter:

38.4 cm (15.13 in.)

Overall Depth:

17.8 cm (7.00 in.)

Mounting Bolt Circle:

37.0 cm (14.56 in.)

Mounting Hole Diameter,

Eight Evenly Spaced Holes:

0.71 cm (0.281 in.) — letter L drill

Baffle Opening Diameter, Front or Rear

Mounting:

35.25 cm (13.88 in.)

Optional Mounting Accessory:

SMH-1 (see Installation section)

Net Weight:

9.5 kg (21 lbs)

DESCRIPTION

The EVM-15L, Pro-Line is a 15-inch speaker designed for professional high-level, high-quality sound reinforcement systems. Used full range, the EVM-15L, Pro-Line's frequency response is specially tailored for strong mid-range and smooth bass performance. The EVM-15L, Pro-Line incorporates voice coil and suspension refinements, including beryllium copper flatwire leads, that have improved performance. Power capacity is 400 watts per the revised EIA Standard RS-426A. The Power Handling Test section describes these ratings in detail.

The construction of the EVM-15L, Pro-Line features a low mass edgewound voice coil on a rugged laminated polyimide coil form, driven by our largest 16-lb magnetic structure. Also featured are a heavy-duty curvilinear cone and a fatigue-resistant cone suspension. Both the coil and magnetic structure are vented. All of this is packaged in a rugged eight-spoke diecast aluminum frame with a heat-radiating back cover.

The EVM-15L, Pro-Line may be front or rear mounted without an adapter. The optional SMH-1 speaker mounting kit facilitates front mounting (see Installation section).

FREQUENCY RESPONSE

Frequency response was measured with the EVM-15L, Pro-Line in a TL606 enclosure placed in a half-space anechoic (echoless) environment at 10 feet on axis with 4 volts of swept 1/3-octave random noise. The frequency response curve is shown in Figure 2.

DIRECTIONAL PERFORMANCE

The directional characteristics of the EVM-15L, Pro-Line in the TL606, 3.2-cubic-foot vented enclosure, were measured by running a set of polar responses, in EV's large anechoic chamber, at selected octave band center frequencies. The test signal was octave bandwidth-limited pseudo-random pink noise centered at the frequencies indicated in Figure 3. The curves show horizontal (side-to-side) dispersion when the enclosure's long axis is vertical. The vertical (up-and-down) polar responses deviate only slightly from the horizontal responses.

Additional typical data is provided in Figures 4 and 5 which indicate 6-dB-down beam-width versus frequency and directivity factor, respectively, for an EVM-15L, Pro-Line in the TL606 enclosure.

POWER HANDLING TEST

To our knowledge, Electro-Voice was the first U.S. manufacturer to develop and publish a power test closely related to real-life conditions. First, we use a random noise input signal because it contains many frequencies simultaneously, just like real voice or instrument program. Second, our signal contains more energy at extremely high and low frequencies than typical actual program, adding an extra measure of reliability. Third, the test signal includes not only the overall "long-term average" or "continuous" level — which our ears interpret as loudness — but also short-duration peaks which are many times higher than the average, just like actual program. The long-term average level

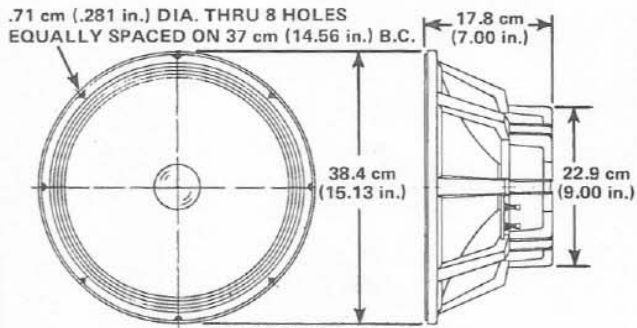

FIGURE 1 - Dimensions

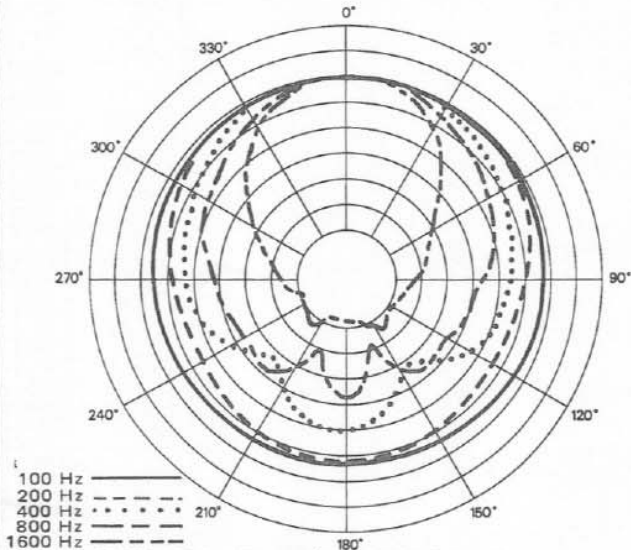

FIGURE 3 - TL606/EVM .15L Polar Response
4 V RMS of Octave Band Limited Pink Noise in
Anechoic Environment, 10 ft on axis in Horizontal
Plane (5 dB per Division, Scales not normalized)

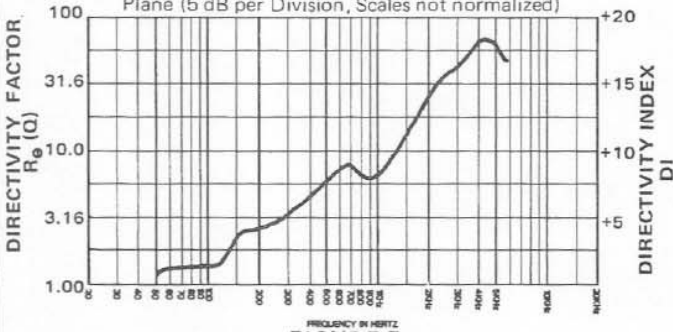

FIGURE 5

TL606/EVM .15L Directivity Factor and Directivity Index vs. Frequency

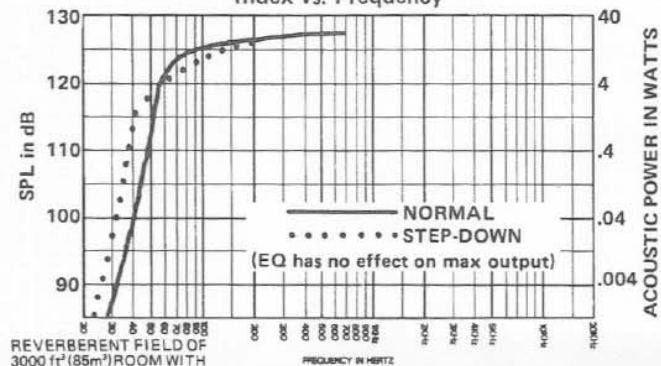

FIGURE 7

TL606/EVM .15L Theoretical Low Frequency Maximum Acoustic Output vs. Frequency

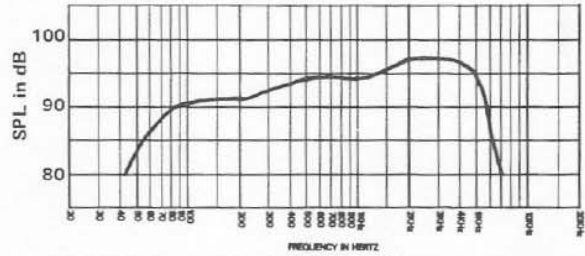

FIGURE 2 - TL606/EVM .15L Frequency Response
(Swept 1/3-Octave Band Pink Noise, 4 V at 10 ft.
on Axis, Half-Space Environment)

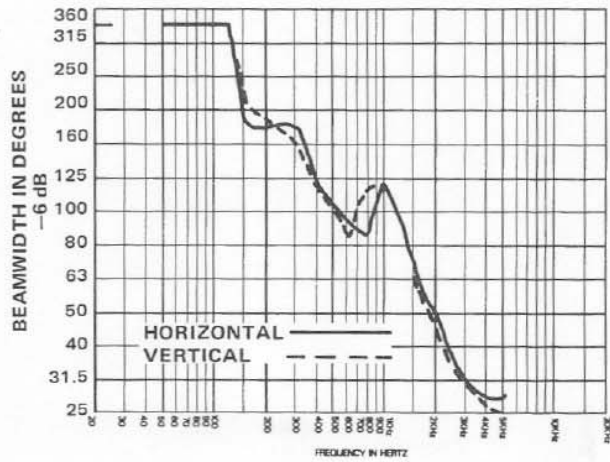

FIGURE 4

TL606/EVM .15L Beamwidth vs. Frequency

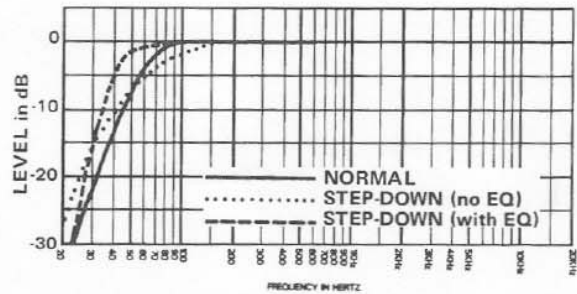

FIGURE 6

TL606/EVM .15L Low Frequency Response

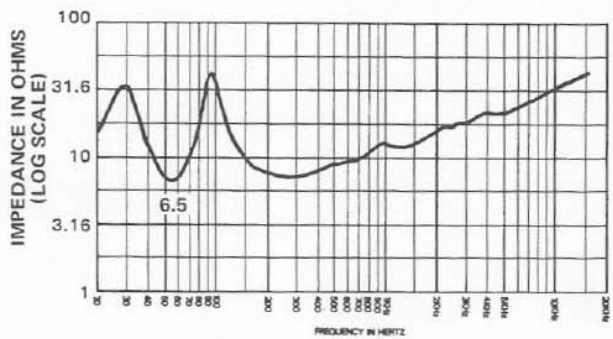

FIGURE 8

TL606/EVM .15L Input Impedance vs. Frequency

stresses the speaker thermally (heat). The instantaneous peaks test mechanical reliability (cone and diaphragm excursion). Note that the sine wave test signals sometimes used have a much less demanding peak value relative to their average level. In actual use, long-term levels exist from several seconds on up, but we apply the long-term average for several hours, adding another extra measure of reliability.

Specifically, the EVM-15L, Pro-Line is designed to withstand the power test described in the revised EIA Standard RS-426A. The EIA test spectrum is applied for eight hours. To obtain the spectrum, the output of a white noise generator (white noise is a particular type of random noise with equal energy per bandwidth in Hz) is fed to a shaping filter with 6-dB-per-octave slopes below 40 Hz and above 318 Hz. When measured with the usual constant-percentage bandwidth analyzer (one-third-octave), this shaping filter produces a spectrum whose 3-dB-down points are at 100 Hz and 1200 Hz with a 3-dB-per-octave slope above 1200 Hz. This shaped signal is sent to the power amplifier with the continuous power set at 400 watts into the 6 ohms EIA equivalent impedance, (49 volts true RMS). Amplifier clipping sets instantaneous peaks at 6 dB above the continuous power, or 1600 watts peak (98.0 volts peak). This procedure provides a rigorous test of both thermal and mechanical failure modes.

RECOMMENDED ENCLOSURES

Replacement Use in Existing Enclosures

The EVM-15L, Pro-Line will often be used to replace inferior speakers in existing enclosures. Mechanical and electrical characteristics are such that the superior efficiency, sound quality, and reliability of the EVM-15L, Pro-Line will be realized in virtually any sealed, vented (bass reflex) or horn-loaded enclosures.

Vented Enclosures

The most extended, lowest distortion, and best controlled bass performance is usually realized in properly designed vented enclosures. In such designs, the vent, or port, actually reproduces the lowest octave or so of bass response. The vent is driven to full acoustic output by a relatively small motion of the speaker cone itself, acting through the air contained within the enclosure. The excursion of the EVM-15L, Pro-Line at these frequencies is much reduced compared to sealed or open-backed enclosures, directly reducing harmonic distortion and the possibility of speaker "bottoming."

The 3.2-cubic-foot TL606 enclosure has a low-frequency 3-dB-down point (f_3) of 63 Hz, ideal for bass and mid-range applications, and many vocal reinforcement situations. Relative to a sealed system of similar output ability, the box tuning of 55 Hz reduces cone excursion, over a usefully wide frequency range of 55 Hz to over 150 Hz.

For bass use the TL606 vent should be partially covered to lower box tuning to 40 Hz ("step-down" mode). This discourages speaker bottoming at the low bass notes and provides a low-frequency response that rolls off slowly below 150 Hz ($f_3 = 78$ Hz), performance typical of the most popular bass systems. With appropriate electronic boost, an f_3 of 42 Hz may also be obtained, a beneficial extension for many vocal reinforcement applications.

Figure 6 shows small-signal total acoustic power output versus frequency for the TL606/EVM-15L, Pro-Line. In addition, Figure 7 shows the maximum acoustic power output versus frequency. The maximum output is limited by either (1) the thermal power handling capacity of the speaker, or (2) the speaker's maximum linear cone excursion capabilities, whichever occurs first. Note that some 2 to 3 dB of maximum output in the 60 to 90 Hz range is sacrificed when the step-down mode is used.

Details on TL606 design, construction, and equalization may be obtained from Electro-Voice by requesting "TL606 Builders Plans," Form 1545-523. Multiple TL606's may also be constructed. For example, a dual TL606 would have twice the internal volume of a single TL606, with the vent area doubled and vent length unchanged. The vent area may be either all-in-one or split into two or more separate vents, as long as the total vent area remains the same.

SPECIAL NOTE ON LOW-FREQUENCY PERFORMANCE

The TL606 vented enclosure and associated performance specifications shown earlier were determined in accordance with the definitive analysis of A.N. Thiele, R.H. Small, and others (for example, see A.N. Thiele, "Loudspeakers in Vented Boxes," *J. Audio Eng. Soc.*, Part I, Vol. 19, May 1971, pp. 382-391; Part II, Vol. 19, June 1971, pp. 471-483). Other vented box sizes and tunings are quite feasible and may give performance more suitable for a particular application.

By applying the work of Thiele and Small, Electro-Voice engineers developed a computer program which easily, quickly, and

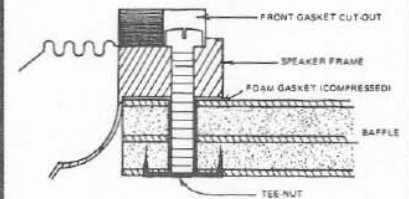

FIGURE 9
Front Mounting Detail
(Not to scale)

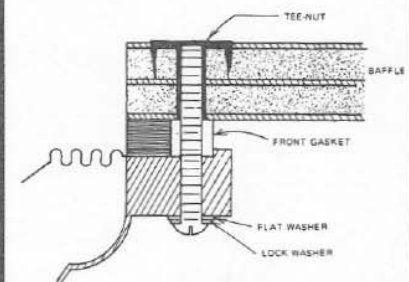

FIGURE 10
Rear Mounting Detail
(Not to scale)

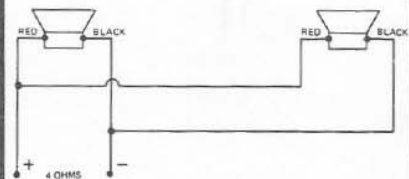

FIGURE 11
Connection of 2 EVM-15L
Speakers in Parallel

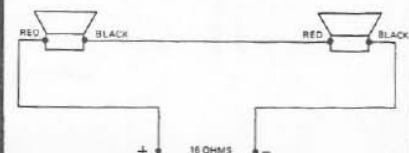

FIGURE 12
Connection of 2 EVM-15L
Speakers in Series

accurately predicts the performance of any speaker-box combination in the frequency range where the diaphragm is acting as a simple piston. The Thiele-Small Driver Parameters shown below include the speaker characteristics required by the computer program to develop the small and large signal performance of a given speaker and enclosure combination. Technically advanced users will find these parameters useful in the design of vented enclosures for the EVM-15L, Pro-Line.

Thiele-Small Driver Parameters,

f_s
Free-Air Resonance Frequency
43 Hz

Q_{es} Electro-Magnetic Q at f_s
0.250

Q_{ms} Mechanical Q at f_s
4.96

Q_{ts} Total Q at f_s $\frac{(Q_{es} Q_{ms})}{(Q_{es} + Q_{ms})}$
0.238

V_{as}
Volume of Air Having Same Acoustic Compliance as Driver Suspension
0.245 M³ (8.65 ft³)

η_0
Half-Space Reference Efficiency
6.2%

V_d
Peak Displacement Volume of Diaphragm
(= $S_d \times X_{max}$)
282.2 cm³ (17.2 in.³)

S_d
Effective Diaphragm Area
855.3 cm² (132.6 in.²)

X_{max}
Peak Linear Displacement of Diaphragm
3.3 mm (0.13 in.)

P_e (MAX)
Thermally Limited Maximum Input Power
400 watts EIA

R_e
DC Resistance of Voice Coil
5.2 ohms \pm 10%

INSTALLATION

The EVM-15L, Pro-Line may be front- or rear-mounted, although front mounting is preferred because of convenience. For simple front mounting, the convenient SMH-1 mounting accessory is recommended. Complete mounting instructions are included with

the SMH-1. Instructions for standard front mounting are given below. It is important that recommended baffle openings and mounting hole locations be followed.

Front mounting requires a 13.88-inch diameter cutout and a 14.56-inch bolt circle. Mark baffle opening and screw locations on the blank panel first. Drill the screw holes before cutting the large baffle opening. If 1/4-20 screws are used, four screws are sufficient for secure mounting of the speaker. T-nuts are recommended for simple, secure mounting. If T-nuts are used, the holes should be 0.281-inch diameter (letter L drill). Apply glue to the flanges of 1/4-20 long shank T-nuts before driving into the rear of the holes.

Sealing of the front-mounted speaker is accomplished with the adhesive-backed foam gasket segments. Strip off protective paper and apply gasket to the rear mounting surface of the speaker rim, making certain that holes in the gasket line up with the mounting holes in the speaker frame.

Length of the 1/4-20 screws should be 1/2-inch plus the panel thickness when using T-nuts. The screws must have fillister heads to seat down in the recess of the speaker frame. Screws should be tightened evenly and securely. Maximum torque possible with a proper size screwdriver should be sufficient.

IMPORTANT! When front mounting, the screw head must fit down into the front gasket cutout. See Figure 9.

Rear mounting requires the same diameter cutout and screw circle as front mounting. Other comments regarding the use of T-nuts apply to rear mounting as well.

Screw length should be 3/4-inch plus panel thickness if using T-nuts — longer for standard hex nuts. If hex nuts are used, a second nut should be tightened against the first nut to prevent loosening during operation. A lock washer and flat washer are recommended between the screw head and frame. See Figure 10.

Screws should be tightened evenly, but not excessively. Maximum torque possible with a proper size screwdriver should be sufficient. Do not use adhesive-back gasket segments for rear mounting.

If a cabinet is to be constructed from scratch, 3/4-inch solid and jointed or marine

plywood is recommended. After construction, be certain interior is completely free of metal filings, wood chips, etc.

CONNECTIONS

Use No. 18 or larger stranded wire to connect the two terminals on the loudspeaker to the amplifier output. If a choice of amplifier output impedance is available (4, 8, 16 ohms), a single EVM-15L, Pro-Line speaker should be connected to the 16-ohm tap. Two EVM-15L, Pro-Line speakers may be connected in parallel as shown in Figure 11. Be sure to connect the red terminals together as shown in Figure 4. If series wiring is desired, wiring and polarity should follow Figure 12.

Patent #4,547,632

WARRANTY (Limited)

Electro-Voice Speakers and Speaker Systems (excluding active electronics) are guaranteed for five years from date of original purchase against malfunction due to defects in workmanship and materials. If such malfunction occurs, unit will be repaired or replaced (at our option) without charge for materials or labor if delivered prepaid to the proper Electro-Voice service facility. Unit will be returned prepaid. Warranty does not extend to finish, appearance items, burned coils, or malfunction due to abuse or operation under other than specified conditions, including cone and/or coil damage resulting from improperly designed enclosures, nor does it extend to incidental or consequential damages. Some states do not allow the exclusion or limitation of incidental or consequential damages, so the above exclusion may not apply to you. Repair by other than Electro-Voice or its authorized service agencies will void this guarantee. A list of authorized warranty service agencies is available from Electro-Voice, Inc., 600 Cecil Street, Buchanan, MI 49107 (AC/616-695-6831); or Electro-Voice West, 8234 Doe Avenue, Visalia, CA 93291 (AC/209-651-7777). This warranty gives you specific legal rights, and you may also have other rights which vary from state to state.

Service and repair address for this product: Electro-Voice, Inc., 600 Cecil Street, Buchanan, Michigan 49107.

Specifications subject to change without notice.



Free Manuals Download Website

<http://myh66.com>

<http://usermanuals.us>

<http://www.somanuals.com>

<http://www.4manuals.cc>

<http://www.manual-lib.com>

<http://www.404manual.com>

<http://www.luxmanual.com>

<http://aubethermostatmanual.com>

Golf course search by state

<http://golfingnear.com>

Email search by domain

<http://emailbydomain.com>

Auto manuals search

<http://auto.somanuals.com>

TV manuals search

<http://tv.somanuals.com>