Zephyr Xstream

Advanced Digital Network Audio Transceiver

The Best Way to Hear from There™



USER'S MANUAL

Manual Version 3.0 for software version 3.0 and later
(For 10 Base-T and 100 Base-T hardware versions)

Customer Service

We support you...

By phone/Fax in the USA.

Customer service is available from 9:30 AM to 6:00 PM USA Eastern Time, Monday through Friday at +1 216.241.7225. We're often here at times outside of these hours as well – please feel free to try at any time!

Fax: +1 216.241.4103.

By phone/Fax in Europe.

Service is available from Telos Europe in Germany at +49 81 61 42 467.

Fax: +49 81 61 42 402.

By E-Mail.

The address is: support@telos-systems.com.

Via World Wide Web.

The Telos Web site has a variety of information that may be useful for product selection and support. The URL is: <http://www.telos-systems.com>.

Feedback

We welcome feedback on any aspect of the Telos Zephyr Xstream or this manual. In the past, many good ideas from users have made their way into software revisions or new products. Please contact us with your comments.

Telos Systems
2101 Superior Avenue
Cleveland, OH 44114
USA
Telephone: +1 (216) 241-7225
Fax: +1 (216) 241-4103

Telos Systems Europe
General-von-Nagel-Strasse 21
85354 Freising
Germany
Telephone: +49 81 61 42 467
Fax: +49 81 61 42 402
E-mail address:
europa-info@telos-systems.com

Updates

The operation of the Telos Zephyr Xstream is determined largely by software. Periodic updates may become available. Contact us to determine if a newer release is more suitable to your needs.

Trademarks

Telos Systems, the Telos logo, Zephyr, ZephyrExpress, Zephyr Xstream, Liverwire and the phrase "The Best Way to Hear From There" are trademarks of TLS Corporation. All other trademarks are the property of their respective holders.

Copyright

Copyright © 1994, 2002, 2007, 2009 by TLS Corporation. Published by Telos Systems, who reserves the right to make improvements or changes in the products described in this manual, which may affect the product specifications, or to revise the manual without notice. All rights reserved.

Notice

All versions, claims of compatibility, trademarks, etc. of hardware and software products not made by Telos mentioned in this manual or accompanying material are informational only. Telos Systems makes no endorsement of any particular product for any purpose, nor claims any responsibility for operation or accuracy.

Warranty

This product is covered by a one year limited warranty, the full text of which is included in the Section 14 of this manual.

Service

You must contact Telos before returning any equipment for factory service. Telos Systems will issue a Return Authorization number, **which must be written on the exterior of your shipping container**. Please do not include cables or accessories unless specifically requested by the Technical Support Engineer at Telos. Be sure to adequately insure your shipment for its replacement value. Packages without proper authorization may be refused. US customers please contact Telos technical support at +1 (216) 241-7225. All other customers should contact your local representative to arrange for service.

We strongly recommend being at the unit when you call, so our Support Engineers can verify information about your unit and the conditions under which the problem occurs. If the unit must return to Telos, we will need your serial number, located on the rear panel.

Test Lines

To aid you in testing and demonstrating your Zephyr Telos Systems has the following test numbers available:

- USA: +216 781.9310, +216 781.9311 (Layer III Dual transmit @ 32 KHz sample rate)
- USA: +216 621.1826 (aacPlus mono, must call as an Xport call)
- Germany: (49) 81 61 42 061 Dial this number twice (Layer III Dual transmit @ 32 KHz sample rate)
- Germany: (49) 81 61 42 062 (Layer II Mono @ 32 KHz)

Notices and Cautions

	<p>CAUTION:</p> <p><i>THE INSTALLATION AND SERVICING INSTRUCTIONS IN THIS MANUAL ARE FOR USE BY QUALIFIED PERSONNEL ONLY. TO AVOID ELECTRIC SHOCK, DO NOT PERFORM ANY SERVICING OTHER THAN THAT CONTAINED IN THE OPERATING INSTRUCTIONS UNLESS YOU ARE QUALIFIED TO DO SO. REFER ALL SERVICING TO QUALIFIED PERSONNEL.</i></p>
---	---

	<p>WARNING:</p> <p><i>TO REDUCE THE RISK OF ELECTRICAL SHOCK, DO NOT EXPOSE THIS PRODUCT TO RAIN OR MOISTURE. DO NOT SHOWER WITH THE UNIT.</i></p>
---	---



This symbol, wherever it appears, alerts you to the presence of uninsulated, dangerous voltage inside the enclosure – voltage which may be sufficient to constitute a risk of shock.



This symbol, wherever it appears, alerts you to important operating and maintenance instructions. Read the manual.



TO PREVENT RISKS OF
 ELECTRIC SHOCK,
 DISCONNECT POWER
 CORD BEFORE SERVICING



USA CLASS A COMPUTING DEVICE INFORMATION TO USER. WARNING: This equipment generates, uses, and can radiate radio-frequency energy. If it is not installed and used as directed by this manual, it may cause interference to radio communication. This equipment complies with the limits for a Class A computing device, as specified by FCC Rules, Part 15, Subpart J, which are designed to provide reasonable protection against such interference when this type of equipment is operated in a commercial environment. Operation of this equipment in a residential area is likely to cause interference. If it does, the user will be required to eliminate the interference at the user's expense.

NOTE: Objectionable interference to TV or radio reception can occur if other devices are connected to this device without the use of shielded interconnect cables. FCC rules require the use of only shielded cables.



CANADA WARNING:

“This digital apparatus does not exceed the Class A limits for radio noise emissions set out in the Radio Interference Regulations of the Canadian Department of Communications.”

“Le present appareil numerique n’émet pas de bruits radioelectriques dépassant les limites applicables aux appareils numeriques (de les Class A) prescrites dans le Reglement sur le brouillage radioelectrique edicte par le ministere des Communications du Canada.”

Table of Contents

1	QUICK START – Step by Step Guide to Getting Running.....	1
1.1	<i>Connections Preview.....</i>	2
1.2	<i>Success, Step-by-Step:</i>	4
1.3	<i>Powering Up</i>	6
1.4	<i>Basic Configuration.....</i>	7
1.5	<i>Placing Your First Call (to Yourself).....</i>	10
1.6	<i>Your Next Call, to Telos.....</i>	11
1.7	<i>Where to find answers to frequently asked questions:</i>	13
2	INTRODUCTION - Getting to Know the Zephyr Xstream	15
2.1	<i>What is the Zephyr Xstream?.....</i>	15
2.2	<i>Why the Zephyr Xstream?</i>	16
2.3	<i>Xstream vs. Xstream MX vs. Xstream MXP.....</i>	16
3	GUIDED TOUR of the HARDWARE.....	19
3.1	<i>Zephyr Xstream Front Panel (Non-mixer version).....</i>	19
3.2	<i>Zephyr Xstream Rear Panel (non-mixer version)</i>	24
3.3	<i>Zephyr Xstream MX/MXP Front Panel (Mixer versions)</i>	38
3.4	<i>Zephyr Xstream MX/MXP Rear Panel (Mixer versions).....</i>	44
4	BASIC OPERATION & INSTALLATION	59
4.1	<i>Essentials</i>	59
4.2	<i>Introduction to Zephyr Xstream’s Menu System.....</i>	61
4.3	<i>Codec Settings: Transmit, Receive, Bit Rate, & Sample Rate</i>	77
5	GUIDED TOUR of the MENUS	81
5.1	<i>The Menu Tree.....</i>	81
5.2	<i>The Default Screen.....</i>	86
5.3	<i>The Audio Menu.....</i>	86
5.4	<i>The Codec Menu</i>	93
5.5	<i>The Tel Menu</i>	99
5.6	<i>The System Menu</i>	105
5.7	<i>Auto, Dial & Drop.....</i>	108





6	AUDIO CODING REFERENCE.....	109
6.1	<i>Introduction to Audio Coding Technology</i>	109
6.2	<i>Choosing the Best Coding Mode for Your Application</i>	126
7	ISDN BASICS.....	133
7.1	<i>Background.....</i>	133
7.2	<i>The ISDN Basic Rate Interface (BRI).....</i>	134
7.3	<i>How to Order ISDN</i>	138
7.4	<i>Switched 56.....</i>	142
8	LIVEWIRE™ – IP Audio	143
8.1	<i>Configuration of the Zephyr Xstream for Livewire.....</i>	143
8.2	<i>Livewire Audio Settings.....</i>	149
9	The V.35/X.21 Interface Option.....	153
9.1	<i>Installing the V.35/X.21 Interface option.....</i>	153
9.2	<i>Uses for the X.21/V.35 Interface Option</i>	154
9.3	<i>Hook-Ups to Non-ISDN Synchronous Networks.....</i>	157
10	APPLICATIONS GUIDE – Hints & Ideas	165
10.1	<i>Xstream Versatility – types of dial-up connection and modes.....</i>	165
10.2	<i>Choosing the Best Transmit Mode for your application</i>	170
10.3	<i>Applications Guide.....</i>	172
10.4	<i>Multi Codec connections.....</i>	176
10.5	<i>Choosing a Receive mode</i>	177
10.6	<i>Dealing With Delay.....</i>	184
11	THE WORKS! - Detailed Menu Reference	187
11.1	<i>The MENUS.....</i>	187
11.2	<i>The AUDIO Menu – Xstream (non-mixer version).....</i>	192
11.3	<i>The AUDIO Menu – Xstream MX/MXP (mixer models).....</i>	197
11.4	<i>The CODEC Menu.....</i>	202
11.5	<i>The TEL Menu</i>	215
11.6	<i>The SYSTEM Menu</i>	228
11.7	<i>Special Menus: Auto, Dial, & Drop.....</i>	239





12	System Functions and Remote Control	245
12.1	<i>Ancillary Data</i>	245
12.2	<i>Remote Control.....</i>	247
13	DEEP TECH INFORMATION & TROUBLESHOOTING	261
13.1	<i>Accessing the Hardware</i>	262
13.2	<i>Updating Firmware.....</i>	265
13.3	<i>Updating Xstreams with the 100 Base-T hardware</i>	265
13.4	<i>Updating the original (10 Base-T) Xstream</i>	267
13.5	<i>Troubleshooting.....</i>	273
13.6	<i>General Troubleshooting Techniques</i>	273
14	SPECIFICATIONS & WARRANTY	293
14.1	<i>Specifications.....</i>	293
14.2	<i>Zephyr Xstream Limited Warranty.....</i>	296
APPENDICES		297
<i>Appendix 1: Codec Interoperability Information.....</i>		297
<i>Appendix 2: Finding Public Codec User Lists</i>		299
<i>Appendix 3: ISDN Cause Phrases/Values</i>		301
<i>Appendix 4: Known Working SPID Formats by Telco</i>		309
<i>Appendix 5: Suggested Reading and References.....</i>		313
<i>Appendix 6: Streaming and Special Operational Modes</i>		315
<i>Appendix 7: Ordering ISDN for countries using ETS 300 (Euro ISDN).....</i>		327
<i>Appendix 8: Ordering ISDN for the USA & Canada</i>		331
<i>Appendix 9: Modular Cable Guide</i>		339
<i>Appendix 10: Glossary</i>		345
INDEX.....		365

Conventions used in this manual

The following symbols are used throughout this manual to highlight various type of information contained within.

	<p>DANGER!</p> <p><i>This information is important to safe operation of the equipment and warns of possible hazards. For your safety you should read these.</i></p>
	<p>IMPORTANT TIP!</p> <p><i>This information is essential to getting the Zephyr Xstream to work, or prevent damage to it. To avoid headaches read these.</i></p>
	<p>HOT TIP!</p> <p><i>This information will probably come in handy at some point. You will probably wish to read these.</i></p>
	<p>ISDN TIP!</p> <p><i>Important information about ISDN, particularly the Zephyr Xstream's built-in ISDN interface. This is recommended reading for all ISDN users.</i></p>
	<p>COMPATIBILITY TIP!</p> <p><i>Information useful when configuring your Zephyr Xstream to communicate with other codecs.</i></p>

	<p>DEEP TECH NOTE!</p> <p><i>Amaze your technical friends with your voluminous knowledge of the Zephyr Xstream, ISDN, and coding technology! Not necessary for the ability to install and use the Zephyr Xstream, but this information might come in handy if you ever need to troubleshoot the system.</i></p>
	<p>CURIOSITY NOTE!</p> <p><i>Amaze your friends with your grasp of ISDN and Coding trivia. Not necessary for the ability to install and operate the Zephyr Xstream.</i></p>
Z	<p>ZEPHYR CLASSIC VS XSTREAM COMPARISON!</p> <p><i>These notes point out important differences between the original Zephyr and the Zephyr Xstream Series. A wise man once said, "don't make assumptions". The Zephyr Xstream is designed to be easily learned by Zephyr users. We will try to anticipate areas where the differences might be confusing, and draw your attention to them.</i></p>

1 QUICK START – Step by Step Guide to Getting Running

Who can use this section?

You have just opened the carton containing a cool new Telos codec. We know how you feel. You don't want to sit around and read a manual. You want to plug-in your new Zephyr Xstream and hear what it can do. You want to connect to a distant location and be amazed at how audio over ISDN connections or Ethernet is even better than ever. We know because we feel the same way when we get a new, expensive, piece of gear.

As much as we understand your excitement, we ask you to please peruse the following to get the most out of your Zephyr Xstream.

This manual is designed to fully instruct you on the capabilities of your Zephyr Xstream and to provide you with interesting and useful information on audio coding and digital telephony. (Unlike most other manuals, large sections don't even require that you be sitting in front of the product.) We hope you will take the time to read the manual. We trust you will enjoy it and that it will provide you with new and useful information that you can use to impress others.

If you need to put the unit in service today, or have experience with other, similar equipment, this section will allow you to get started quickly with your Zephyr Xstream.

“Quick Start” Is for You If You...

- Know how to dial a telephone call.
- Are not intimidated by looking at the front panel of the Zephyr Xstream.
- Are willing to erase all of the settings in your Zephyr Xstream that may have been programmed (by others) before you got it.
- Have an ISDN line. (Before starting this process, US users should contact their telephone company to verify that the line was installed exactly as specified in the ISDN order instructions found in the appendix of this manual.) Sorry, but there are too many variables when connecting via Switched 56 or a dedicated digital service for us to include such a set-up in this “Quick Start.” If you are using a non-ISDN setup see the instructions for the X.21/V.35 option in Section 9 (The V.35/X.21 Interface).
- Understand and have before you all of the items listed in the section that follows called “What you need before you start.”
- Understand that this “Quick Start” will only get you started and will not answer all of your questions, or demonstrate all of the features of the Zephyr Xstream.
- Promise to read the full manual later.

Now, let's get started.

What you need before you start...

There are two categories of items you need: First, the equipment to connect your Zephyr Xstream to the audio equipment and the ISDN circuit; second, some information that should have been provided to you by the person who provided your ISDN.

1.1 Connections Preview

ISDN Connections

All of the connection cables have telephone-type modular connectors and come packaged with your Zephyr Xstream.

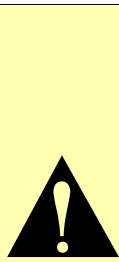

IMPORTANT TIP!

An RJ-11 style 6-position plug can be inserted into the center of an RJ-45 style 8-position jack, if the Telco installed an RJ-45 style jack for your U Interface ISDN line (in the USA or Canada).

1. In the USA & Canada you will be using the Zephyr Xstream's built-in NT1. *Cable required: A standard telephone-type modular cable that fits into the smaller, RJ-11 style jack on the Zephyr Xstream. The other end of this cable plugs into the jack provided by the Telco.*
2. OR-Your telephone company (Telecom) has provided an NT1. This is nearly always the case outside of the USA & Canada. *Cable required: A large, modular cable with eight wires that fits into the upper (larger, 8 pin RJ-45 style) jack on the Zephyr Xstream and a jack on the NT1 that is labeled "Terminal" or "S/T". The other end of this cable plugs into the NT1, or into the jack wired by the Telco. Your NT1 should have been wired to the ISDN line by your Telco.*

Audio connections

You want to hear something, don't you? Connections are needed for sending audio to the remote location and receiving audio from it. You will need to provide the appropriate cables. For connection to the Zephyr Xstream, the two send cables must have either male XLR connectors or ¼ inch plugs (Zephyr Xstream accepts XLR, and both Tip/Ring (TR) unbalanced and Tip/Ring/Sleeve (TRS) balanced ¼ inch connectors). The two receive cables must have female XLR connectors. The termination on the other side of these cables depends on your equipment. You may choose to use headphones to listen to the receive audio; in this case you will not need receive cables.

Information on your ISDN line

Zephyr Xstream needs to know some things about your ISDN line to work properly. Your ISDN circuit consists of two digital "B channels". Just like a regular telephone line, these channels have telephone numbers so that you can send and receive calls. The Zephyr Xstream, as with most ISDN equipment, refers to these channels as "lines". Unlike regular telephone lines, both "lines" might have the same telephone number assigned to them.

There are several different types of ISDN service. You must know what type you have. In addition, ISDN circuits in the US and Canada will usually have Service Profile Identification (SPID) numbers. SPIDs, when used, *must* be programmed into the Zephyr Xstream. In rare circumstances, US users may also need Directory Numbers (DNs) if the telephone numbers are not incorporated into the SPIDs.

ISDN TIP!

*European & Japanese users should disregard all references to SPIDs. Euro ISDN & Japanese ISDN do not have SPIDs! If your equipment configuration requires MSNs, they may be entered in the MSN/DN menu options in the **TEL** menu. MSNs are optional, would only be used if another ISDN device is sharing the ISDN circuit with the Zephyr Xstream.*

Here is a summary of what you need to know and a place to write it down. You may want to make a copy of this page and keep it next to your Zephyr Xstream.

✓ **ISDN type, check one:**

- "National ISDN-1" (The most frequent choice in the US). Will always have SPIDs.
- "Nortel DMS Custom" ISDN. (Will always have SPIDs).
- "AT&T Custom Point-to-Point" (PTP). (Will not have SPIDs. Single phone number)
- "European ISDN" (Euro-ISDN or ETS300). (Will not have SPIDs).
- "INS 64 (Nippon). This option is for use in Japan. (Will not have SPIDs).

✓ **Your ISDN telephone numbers:**

Line 1 _____

Line 2 _____

(Worksheet continued on next page)

✓ **SPID numbers, if applicable (USA & Canada):**

Line 1 _____

Line 2 _____

✓ **Directory Numbers (DN, or 7 digit telephone number), if applicable (USA & Canada):**

Line 1 _____

Line 2 _____

If your ISDN line is connected to an internal phone system that requires you dial a prefix for an outside line, write it here: _____

ISDN TIP!

If you have European, Japanese, or AT&T Point-to-Point ISDN, it is acceptable if you only have one number that applies to both lines. If you have another ISDN type and only one number, contact Telos Customer Support.



1.2 Success, Step-by-Step:

Connecting the Audio Inputs/Outputs

Got your audio cables ready? Here is where to connect them:

Send audio is connected to the back panel. This is the outbound audio to be heard at the far end (it usually consists of a mix minus). Use the two combo XLR/ ¼" connectors labeled "INPUTS: SEND TO NETWORK." If your Zephyr Xstream includes a mixer (models MX and MXP) use inputs 1 or 2 if you are using a microphone or inputs 3 & 4 if you are using a line level device such as a CD player. *If you are not certain about how to make this connection, refer to Section 3.2 and Section 3.4 (Guided tour of the rear panel).*

Received audio can be monitored at the headphone jack on the front panel. Alternately, it can be connected to some other audio equipment using the back panel jacks. Use the two XLR

connectors labeled "OUTPUTS: RECEIVE FROM NETWORK." *If you are not certain about how to make this connection, refer to Section 3.*

Livewire™

If you are already familiar with Axia's audio nodes, you might think of this new version of the Zephyr Xstream as an "original" Xstream codec with a 2x2 node on the front of it. The LAN port will be used for all Livewire audio connections in and out of the codec. As with all Livewire™ devices, the Livewire streams being delivered to the network require unique ID numbers.

The two most important concepts to understand are:

1. The Livewire™ destinations deliver audio to the inputs to the Xstream codec.
2. The outputs of the Xstream codec (Hybrid Channels) will become the codec's Livewire™ sources to your Axia Livewire network.

The virtual 2x2 node, in combination with the codec, has some unique mono/stereo features:

- If the stream being received by the codec is stereo - both codec outputs (Livewire sources) will be stereo with both delivering identical stereo streams.
- If the stream being received by the codec is dual mono (such as G.722), the decoded audio is split between the two Livewire™ sources. The first source has the A mono feed replicated on both left and right channels. The second source has the B mono feed on both channels. Thus - when you are using dual mono, you will use both codec outputs as independent Livewire sources.
- Remember, Livewire™ streams are always stereo. In the case of a mono source as described above, the mono data is simply replicated on both left and right channels.
- Dual/Mono TRANSMIT works only in Layer 3 Dual/Mono mode. In Layer 3 Dual/Mono transmit; the left channel of the first destination is used to create the "Channel A" mono feed to be sent over ISDN. The second destination is used for the "Channel B" mono transmit feed. The right channel of each of those streams is ignored.

A Word about Livewire Codec Backfeeds

Backfeeds to a codec in the Livewire™ world are always stereo. By default, the right channel of the backfeed is a L/R mono sum of the configured program source (usually PGM1). The left channel is the same *PLUS* talkback. The left channel program can be dimmed or muted when talkback is present.

Connecting to the ISDN Circuit

Making the physical connection to the ISDN line varies with your NT1. You will use one of the following methods as appropriate for your locale:

1. Zephyr Xstream's built-in NT1 (i.e. USA & Canada)
Using a standard RJ-11 style telephone-type modular cable, interconnect the smaller modular jack on the Zephyr Xstream and the jack installed by the telephone company. Be careful to insert the cable in the center of each jack, as it is the middle two wires that have the ISDN circuit.
2. External NT1 provided by the Telephone company (Europe & most locations worldwide)
Using a large 8-pin (RJ 45 style), telephone-type modular cable with eight wires, interconnect the larger jack on the Zephyr Xstream and a jack on the NT1 that is labeled "Terminal" or "S/T." *This cable must have eight wires and is provided with the Zephyr Xstream.*

You should not need to provide power to the NT1. The NT1 is normally powered from the ISDN line.

1.3 Powering Up

Time to turn on the Zephyr Xstream!

- Connect the provided IEC power cable to the Zephyr Xstream. As you face the back, the connection is on the lower right.
- Connect the other end of the IEC cable to your AC (mains) power outlet. The Zephyr Xstream's power input is universal, accepting anything from 100 to 240 Volt AC 50/60Hz.
- Flip the power switch, located just above the power cable connector, to the "on" position. (push in the side labeled "1").
- Your Zephyr Xstream will start up. After a few moments, the front panel LCD display screen will display the status of your Zephyr Xstream. Above the Send meters, the SYNC indicator should be illuminated. If you have a proper audio connection, and are feeding an audio signal to the Zephyr Xstream, you will see activity on the two SEND meters on the left- side of the front panel.

1.4 Basic Configuration

Your Zephyr should display a screen that looks like this:



Press the <CODEC> button once. You should see a screen that looks like this:



If it does not look like the above (i.e. some of the settings are different), your unit has been previously configured. If it was, and you want to proceed with the Quick Start, you must erase all of the previous settings. *Before you go to the next step, check with the last person who used this Zephyr Xstream to be certain that s/he no longer needs these settings.*

To reset the Zephyr Xstream to the factory defaults:

- Press the <System> button (located beneath the LCD display) 5 times. You will see a screen that looks like the following:

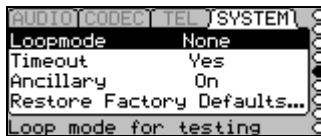

- Using the <▼> button move the dark bar so that “Restore Factory Defaults” is highlighted (white text on a black background). Press the <SEL> Button. You should see the following screen:

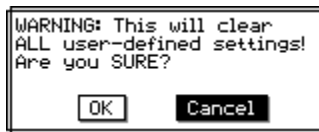

- Now press <▼> then press <SEL> to erase all settings to the factory defaults.

We are now ready to configure your Zephyr Xstream. Follow these instructions exactly for the most reliable path to success!

We will be using the <TEL> button. This will take you through the menus where the information about your ISDN circuit is stored.

1. You have two options depending on what type of ISDN you are using:

- If you have Euro-ISDN (or another service that does not have SPIDs), press the < TEL > button (located beneath the LCD display) three (3) times and *skip to step 5*.
- If you have SPIDs, press the < TEL > button two (2) times and continue.

You should see a screen that looks like this:

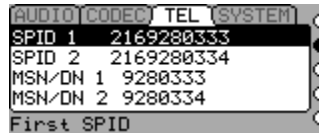

2. Make sure the dark cursor bar is highlighting the line labeled "SPID 1". Press the <SEL> button once and then enter the SPID of your first B channel, using the dial pad on the front right panel. (Note that there are no hyphens, punctuation, or blank spaces in SPIDs; they are one continuous number.) The < ^ > button can be used to back up (move the cursor to the left) to delete characters for editing (or to erase an existing entry). Then press the <SEL> button to store it.
3. Press the < v > button to highlight the line labeled "SPID 2 ". Press the <SEL> button once and then enter the SPID of your second B channel using the dial pad on the front right panel, as above. Then press the <SEL> button to store it.
4. You now have two options:
 - If your ISDN does not require Directory Numbers (DN) press <TEL> one (1) time and skip to step 5.
 - If your ISDN requires Directory Numbers (DNs), **and most users in the USA & Canada will**, press the < v > button to move the dark cursor to the line labeled "DN/MSN 1".

Press the <SEL> button once and then enter the DN (the 7 digit telephone number) of your first B channel using the dial pad on the front right panel. (Note that there are no hyphens, punctuation, or blank spaces in DNs or MSNs; they are one continuous number.) The < ^ > button can be used to back up (move the cursor to the left) and delete characters or erase an existing entry. Press the <SEL> button to store it.

Press the < v > button to move the dark cursor to the line labeled "DN/MSN2". Press the <SEL> button once and then enter the DN or MSN of your second B channel using the dial pad on the front right panel. Press the <SEL> button to store it.

Press the <TEL> button once. You will see a screen like this:



USER'S MANUAL



5. Make sure the dark cursor bar is highlighting the line labeled "Telco". Press the <SEL> button once. Press the <^> or <v> button repeatedly until the type of ISDN you have appears on the screen. Then press the <SEL> button to accept it. **Even if the correct ISDN type is shown, press the <SEL> button to choose this item and then again to deselect it.**

You should now see the following screen:



Press the <v> button and then <SEL> to confirm you wish to reboot. The Zephyr Xstream will reboot. After a few moments, you should see the following screen:



In addition, you should observe the following:

- The SYNC lamp will be glowing green near the top of your Zephyr Xstream's front panel (above the *Send* meter).
- If you are using the Zephyr Xstream's internal NT1 (i.e. are a user in the USA or Canada), the little green LED (at the bottom left, of the back of the unit) should be illuminated solidly, not blinking or flickering.

Note: if you are using an external (Telco provided) NT1 this LED will be flickering, this is normal.

- Press the <TEL> button once. The two status words at the left of the LCD screen should both indicate "Ready" (you may need to wait as long as 30 seconds for the ISDN to initialize, so be patient).

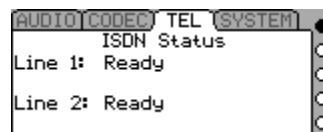

6. If these conditions are met, you are ready to place your first call. If not, something is not right with your ISDN line, the way you have configured

your Zephyr Xstream, or both. Since these are Quick Results, the tips below are brief and note only the most frequent problems encountered.

- If you have SPIDs, or DNs, check to see whether you have entered them correctly. If you have not, you can erase all of the settings in the Zephyr Xstream by following the directions above, near the beginning of "Basic Configuration".
- Check all of your ISDN line connections to be certain they are firm and correct. Refer to the instructions above.

Note: In the USA and Canada you should normally be using the smaller (RJ-11 style) ISDN jack on the rear of the unit whereas users outside those countries will normally use the larger (RJ-45 style) jack.

- Your ISDN line may not be activated or may be configured incorrectly. Contact your ISDN line provider. US users should confirm that the line was installed exactly as specified in the ISDN ordering instructions found in the appendix of the manual.
- If you are using Zephyr Xstream's internal NT1, the green status LED (near the jack, on the rear panel) should be on solid. If it is not, you have a very basic line problem – see Section 13 (Deep Tech & Troubleshooting) for more advice and guidance.

At this point, if the conditions in item 5 are still not met, contact Telos Customer Support for assistance. When you call, have the information on your ISDN circuit on hand.

1.5 Placing Your First Call (to Yourself)

Your first call is to be placed to yourself. You will be using your first ISDN "line" to connect to your second ISDN "line" (both "lines" are part of the same ISDN circuit). If this works, you know you are connected to your local telephone company office and your Zephyr is programmed correctly. (This procedure will not work if you only have ordered only one ISDN B channel from the Telco.)

Follow these step-by-step instructions:

1. Press the <DIAL> button once. You will see a screen that looks like this:

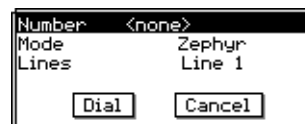

Since you are dialing from the first "line" (to your second "line"), use the keypad to enter the phone number of your second line (you do not need to press <SEL> before entering the number). If you need a code to access an outside line, be sure to enter it.

Note: Since this is a local call, you probably do not need a "1" or area code.

2. Press the <DIAL> button again. You should see a series of messages that say "Seize Pending; Out Ring; Connected." If successful, the receive *LOCK* LEDs will light (it might take a few moments), and, if you are sending audio into your Zephyr, you will see activity on both the *Send* and *Receive* meters. If connected to your studio audio gear, you should be able to hear the audio feed from the "Output: Receive from Network" audio outputs, or your headphones.
3. Whether or not you have successfully connected, slowly press the <DROP> button repeatedly until *both* of the LINE status indicators have returned to "Ready". This may take up to four presses.
4. If you have successfully connected, go on to the next section. If you have not, try again. Try dialing the other line number provided to you. You may wish to try with an area code or 1. If you fail after a few more attempts, contact Telos Customer Support or your local Telos Representative.

1.6 Your Next Call, to Telos

Located less than a mile from the Rock 'n' Roll Hall of Fame, there is always something interesting playing on the Telos ISDN test line. Let's call Cleveland. If you prefer, you can call our test line in Europe. That number is listed under "Test Lines" on page iii at the front of this manual. Be certain to call a Layer-3 line.

Follow these step-by-step instructions:

1. Press the <DIAL> button once. Use the keypad to enter the first Telos test line number. Be certain to precede it with any number you may need to dial to access an outside line and/or to place a long distance or international call. The first number is +1 216.781.9310. Press the <DIAL> button again.
2. You should see a series of messages that say "Seize Pending; Outgoing Seize; Out Ring; Connected."

If successful, the green *Lock* LED over the left *Send* meter will be illuminated. You may not hear audio or see any meter action until you have connected the second line. If you do not connect, go to step 5, below.

3. Press the <DIAL> button once. Use the keypad to enter the second Telos test line number. Again, be certain to precede it with any number you may need to dial to access an outside line and/or to place a long distance or international call. The second number is +1 216.781.9311. Press the <DIAL> button again.

You should see a series of messages that say "Seize Pending; Outgoing Seize; Out Ring; Connected."

If successful, the second green *Lock* LED over the right *Send* meter left of the LCD display will be illuminated. Unless the CD player at Telos has stopped, you should see activity on the receive meters and hear music.

4. Whether or not you have successfully connected, slowly press the <DROP> button repeatedly until *both* of the LINE status words have returned to "Ready". This should take four presses. You want to be sure to disconnect, as this may be an expensive call. Alternately, you can select 'Both' lines from the drop menu:
5. If you have successfully connected, go on to the next section. If you have not, try again. If you do not succeed, here are a few things to try:
 - US users should try calling using another long-distance carrier. To do so, insert the carrier's seven-digit access code. The number to dial starts with any prefix needed for you to get an outside line, followed by the long distance access code, followed by the Telos test line number. See Section 13 for additional tips. Let us say you don't need a prefix (and most people don't) and you want to use MCI. Dial:

Line 1: 1010222 1 216.781.9310

Line 2: 1010222 1 216.781.9311

If this works, you should contact your phone company to determine how to resolve the problem with your primary long distance carrier.

- Wait an hour and try again. The Telos test line may be busy.
- Call Telos Customer Support for assistance. The terminal adapter in Zephyr Xstream has a built-in ISDN analyzer that will provide plain language error messages in many circumstances. Have these messages ready when you call, as they will help speed the process of solving your problem.

What's Next?

Now you are ready to call the world. Remember your promise to read the entire manual! If you want to skip around the manual a bit, the chart that follows can tell you where to find answers to the most frequently asked questions.

Further assistance in using your Zephyr Xstream can be found in the HELP text which is displayed whenever you select a menu item using the <SEL> key. You may wish to go through the menus and select various items to learn more about what they do.

1.7 Where to find answers to frequently asked questions:

Question	Manual Section
How do I order my ISDN line?	Appendices 7 (Ordering ISDN for ETS 300) & 8 (Ordering ISDN for USA & Canada)
What are the meanings of all the meters and indicators on the front panel?	Section 3 (Guided tour to the hardware)
Should I use AAC, Layer III, Layer II, or G.722?	Section 6 (Audio Coding Reference) & Section 10 (Applications Guide)
How do I call a Zephyr Xport on a POTS line?	Section 4.2 & Section 10.1
How should the Zephyr Xstream be configured when the far end is not a Zephyr Xstream?	Section 10 (Applications Guide)
How can I connect the Zephyr to a computer?	Section 12 (System functions & Remote Control)
How do configure the Xstream for Livewire?	Section 8 covers Livewire setup and shows relevant web pages
Can I call a regular Telephone?	Section 4.2
How do I contact Telos?	Customer Support: Page ii
Connector Pin-outs?	Section 3 (Guided Tour of the Hardware)
Specifications? Warranty?	Section 14 (Specifications & Warranty)

Z E P H Y R

XSTREAM

USER'S MANUAL

2 INTRODUCTION - Getting to Know the Zephyr Xstream

2.1 What is the Zephyr Xstream?

In 1993, we had a dream. We envisioned a way for CD-quality audio to be sent over common digital phone lines — the perfect marriage of advanced audio coding and digital telephone technologies. Our pursuit of that dream resulted in the Telos Zephyr™, which transformed broadcasting by making ISDN an easy-to-use, effective tool for sending and receiving high-quality audio.

Since its introduction, broadcasters and audio professionals worldwide have made Zephyr the most successful digital broadcast product ever. Its name has become synonymous with easy, instantaneous point-to-point audio transfer: “Just Zephyr it to me!”

Zephyr Xstream™ continues this tradition of excellence. It includes all the tools and features Zephyr users have come to rely on — ISO/MPEG Layer III, Layer II and G.722 coding, straightforward front-panel controls, full-duplex, 20kHz stereo audio, analog and digital I/O (model Xstream) — as well as new capabilities.

In 2002 we added to the versatility of the Zephyr by adding the Zephyr Xport to the product line. A portable, easy-to-use, mono codec the Xport can connect to POTS lines and call your ISDN Xstream at the station. An ISDN option permits connectivity with AAC and G.722 over ISDN.

A software upgrade in 2006 adds enhancements to IP such as bi-directional dialing and AAC with error concealment. Units manufactured since 3rd quarter 2006 also have hardware support for Livewire™ direct input/output to and from Axia audio networks.

In short, the Zephyr Xstream is an advanced, economical, flexible, and easy to use audio codec. While we have added a number of advanced features, we've also maintained ease of use. Some highlights of the Zephyr Xstream family are:

- MPEG 2 AAC (Advanced Audio Coding). This new standard for audio coding combines the techniques developed by researchers all over the world into a single algorithm.
- Unique *Dual* Receive mode in MPEG Layer-3, allows independent audio streams arriving from two distant codecs.
- Unique POTS to ISDN technology communicates with a companion Xport in the field using aacPlus™ for the absolute best quality at the very low bitrates required.
- *Auto Receive* mode searches and determines the correct decoder settings for the incoming audio stream.
- Advanced technology – lower heat generation and improved reliability – Unit has no cooling fan for silent operation in your studio.
- V.35 option allows connection to serial synchronous data equipment for use with services such as dedicated lines, Switched 56, or Satellite services.

2.2 Why the Zephyr Xstream?

Zephyr Xstream is the logical “next step” to our highly successful Zephyr and ZephyrExpress products. We’ve taken the latest technology, years of experience, and suggestions from users like yourself, to create these new products.

You and your staff will benefit from the fact that the three models of the Xstream are identical in their operation. Only the audio menu differs between the mixer and non-mixer versions.

ISDN stands for Integrated Services Digital Network. Xstream is the only codec that takes full advantage of its integration, offering connectivity to telephones, the Xport POTS codec, as well as ISDN codecs. You save on board/router inputs. Operators need learn only one box. And, there is no need for another line at the studio, one ISDN line meets all your needs.

ISDN to POTS technology is undeniably superior for modem performance vs POTS to POTS, and is exactly how Internet Service Provider's provide "56 K" modem connections. To describe this succinctly, this arrangement is better because there is 50% less "POTS," and 50% more digital, transmission (in the majority of cases) vs the POTS to POTS connection used by other manufacturer's equipment. For more on the various types of connections possible with your Xstream, see Section 10 (Applications Guide) where we illustrate them.

No other broadcast codec offers the flexibility and power available in the Zephyr Xstream family.

2.3 Xstream vs. Xstream MX vs. Xstream MXP

Zephyr Xstream

This is the basic model and will usually find its home in the studio. Highlights of the Zephyr Xstream are:

- Supports the MPEG AAC, Layer-2, Layer-3 and G.722 coding standards.
- MPEG AAC-LD offers Layer-3 fidelity with 75% less delay.
- AES/EBU inputs and outputs (standard)
- Analog line level inputs and outputs (Switchable between “Consumer” and “Professional” Levels)
- Short learning curve. Zephyr users will be up and running in minutes.
- High reliability design. No fan or battery to fail. Rugged chassis design.

Zephyr Xstream MX and MXP

These are typically found in remote facilities. These two units are identical with the exception that the MX is rack mountable whereas the MXP has a portable chassis. Highlights of the Zephyr Xstream MX & MXP are:

- Supports the MPEG2 AAC, Layer-2, Layer-3 and G.722 coding standards.
- Exclusive MPEG4 AAC-LD offer Layer-3 fidelity with 75% less delay.
- Short learning curve. Zephyr users will be up and running in minutes.



- 4 input stereo mixer. Each input gain selectable from mic. to line levels and is pan-able left/right. Mixer directly feeds the audio coder section.
- Exclusive, DSP-based, audio processing by Omnia for AGC/Limiting
- Selectable phantom power feeds inputs 1 & 2
- Two local mixes allow any combination of send and receive audio for local headphone monitoring or a Public Address feed.
- Local Mix one appears on the front panel on a stereo ¼" connector.
- Local Mix two appears on three front panel ¼" stereo connectors, each with a separate volume control. This mix is also available on a pair of balanced XLR outputs.
- Rugged chassis design incorporates rubberized shock protection.

Z E P H Y R

XSTREAM

USER'S MANUAL

3 GUIDED TOUR of the HARDWARE

The Zephyr Xstream, Xstream MX, and Xstream MXP are all quite similar in their design and operation. The menus are identical between all three versions with the exception of the *AUDIO* menu.

The front and rear panels of the Xstream MX and Xstream MXP are identical. The only difference between these two models is the fact that the Xstream MX is rack-mountable, whereas the Xstream MXP has a rugged portable case.

The Xstream has different front and rear panels from the other models. Therefore, we will cover the hardware of the Xstream in Sections 3.1 (front) and 3.2 (rear) and the Xstream MX/MXP in Sections 3.3 (front) and 3.4 (rear).

3.1 Zephyr Xstream Front Panel (Non-mixer version)

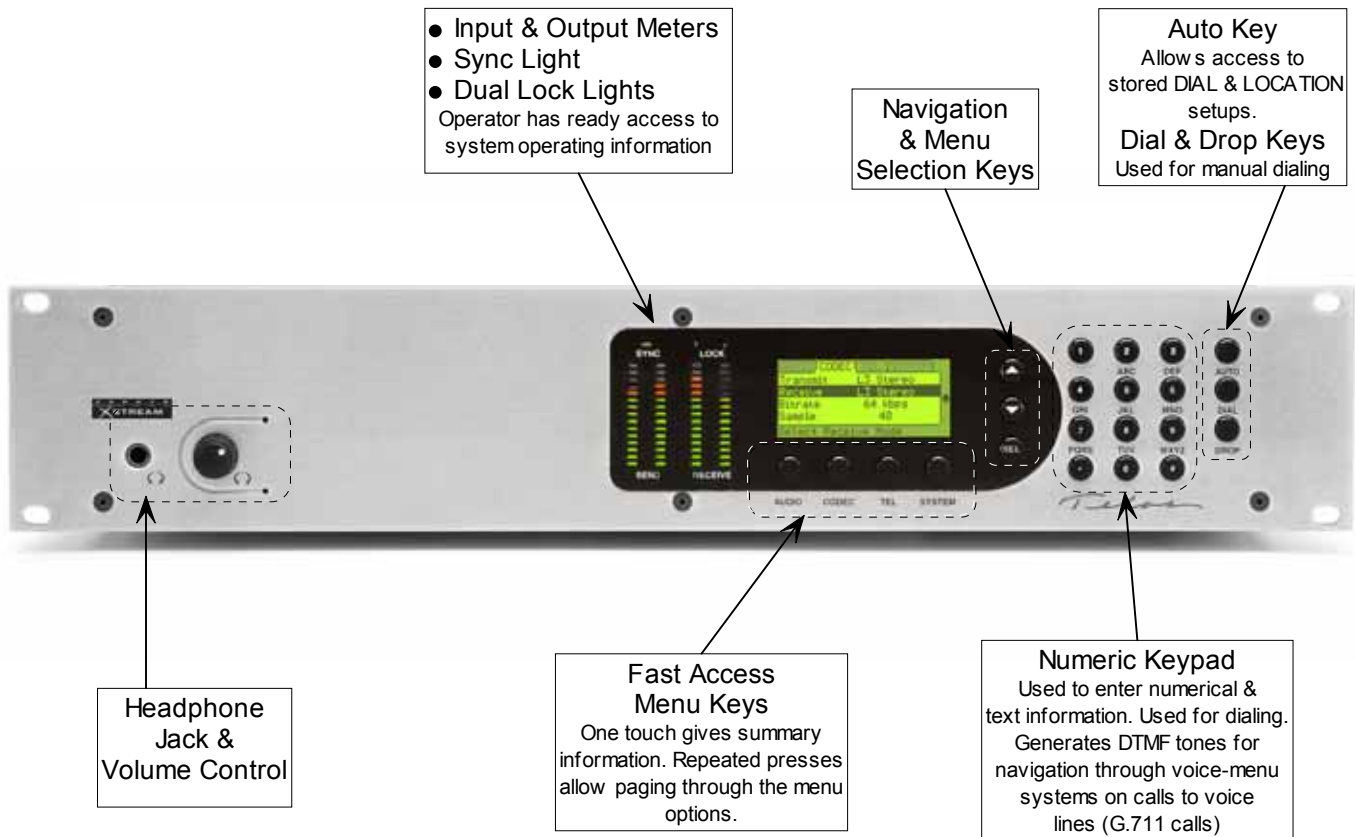

Headphone Jack & Volume Control

The front panel has a headphone jack near the left side. The adjacent knob controls the level. This jack duplicates the receive signal on the main outputs on the rear panel.



Meters and indicators

The following LEDs allow you to monitor the system status and audio levels:

Sync LED

The green *Sync* LED indicates, "all is well" with the system. It indicates that certain clock signals are present and that the internal PLL is within its normal range. This LED should normally be illuminated at all times if the internal ISDN interface is functioning and selected as your *Interface* in the *TEL* Menu.

When the V.35/X.21 interface is present (and selected) the *Sync* LED will be illuminated only if a valid external clock signal at the correct frequency for the *Bit Rate* setting (in the *CODEC* menu) is present on one of the two V.35/X.21 ports.

When the Ethernet interface is selected, the *Sync* LED will blink while the Xstream's clock works to sync with the Xstream on the other side of the connection. Due to network conditions, it is common for this light to be solidly *on*, then start blinking again as the clock readjusts.

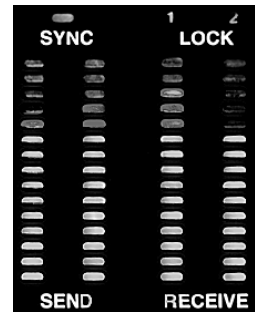

Lock 1 & 2 LEDs

The green *Lock 1* and *Lock 2* LEDs represent the codec decoder status.

These will illuminate when a valid bitstream is received as follows: If a dual channel receive mode is used (i.e. L3 Dual/Mono, or G.722) the *Lock 1* LED represents that the decoder is locked (or "framed") to the incoming coded audio on "Line 1" while the *Lock 2* LED represents a decoder lock on an incoming audio stream on "Line 2".

In the case of a stereo, or mono-128, receive mode, both lock LEDs will illuminate only once a compatible pair of bit-streams are present on both "Lines".

Send Bargraph

The Send Bargraph LEDs represent the level of audio into the coder section. This level is effected by several factors: the output level of the device connected to the Zephyr Xstream; the settings of the input level jumpers (see Section 5); the setting of the *Level In* option in the *AUDIO* menu; and the setting of the *Gain trim* (may be called *In Gain* on early software versions) setting in the *AUDIO* menu.

As with most digital equipment, these meters are calibrated in dBfs (decibel below full scale). In other words, the top LED represents the clip point and the numbers are calibrated in dB below full scale. Therefore it is essential that your levels be set to where the top LED is never lit.

There is a transition of LED color at -10 dBfs. Since the meters are peak indicating, it will generally be safe to run things into the red, depending on the desired headroom, and the dynamics of the material. When setting levels with a sine wave (tone) a level near the red green boundary allows for the stated headroom specifications.

Receive Bargraph

The Receive LEDs represent the level of the audio being decoded from the far end. The level is monitored in the digital domain at the output of the decoder and therefore is not affected by the *Audio Out* setting in the *AUDIO* menu. The calibration and characteristics of the Receive meter match those of the Transmit bargraph.

Fast Access Menu Keys – AUDIO, CODEC, TEL, SYSTEM

These keys are used to instantly jump to a desired menu. The first key-press displays a summary status screen for that menu. Subsequent presses page through the screens of options. The idea is to make it easy to jump directly to a desired menu simply by pressing the desired Menu key a specific number of times.

Pressing and holding down any of these keys will take you back to the default status screen.

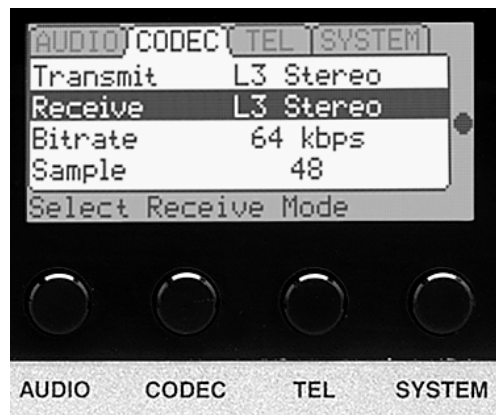

See Section 5 (Guided Tour of the Menus) for an introduction to these menus and Section 11 (Detailed Menu Reference) for details on menu options.

HOT TIP!

*Note that the **CODEC**, **TEL**, & **SYSTEM** menus (and Navigation and Menu Selection Keys) are identical among all models of the Zephyr Xstream. Only the **AUDIO** menu varies between the Xstream (non-mixer) and Xstream MX/MXP (mixer) versions.*



Navigation and Menu Selection Keys

These keys are used to move through the menu options on a given page of menu items. Once the desired menu item has been highlighted (displayed with white text on a black background), pressing the <SEL> selects this option. You can then use the <▲> or <▼> keys to view the options for this item (or to change the position of a sliding control). The previous setting will have [] around it. Pressing the <SEL> key once again saves your selection.

Pressing any Menu key will abort the entry process and allows you to “escape”.



Numeric Keypad

The operation of this is straightforward. A given button corresponds to the number printed on it. It can also be used for text entry of the letters associated with it. Additional characters are available on the <*> key (i.e. * () [] <> <space>) and the <#> key (i.e. # . , ; : ! ? <space>) and underscore is available on the <1> key.

To enter text characters, press the key with the appropriate letter printed near it. Keep tapping it to cycle through the possible choices. For example, tapping the 2-key in a text field will first enter A. Repeated taps will change that to a B, then C, then the lower-case letters, then the numeral 2. Enter a space by pressing 1 three times. Punctuation characters appear on the * and # keys. The period "." is on the # key.



For example:

Press the number 2 once.....	See the character A
... press it again.....	See the character B
... press it again.....	See the character C
... press it again.....	See the character a
... press it again.....	See the character b
... press it again.....	See the character c
... press it again.....	See the numeral 2
... press it yet again.....	the cycle starts again from A

To move to the next character in a field, tap any other key or press the <▼> button. To back up, press the <▲> key.

AUTO, DIAL, & DROP Keys

These keys will be explained in detail in Section 4.2.

The <AUTO> key allows access to Zephyr Xstream's 100 stored *Dial Setups* (#00 to #99). These can be accessed by pressing <AUTO>, entering two digits, and then pressing <AUTO> again.

It can also be used to access the 30 *Location Setups* (#100 to #129) can be accessed to configure the ISDN and, optionally, AUDIO settings for frequently visited locations. Press and hold the <▼> key to move rapidly through the available *Setups*. Location setups can also be accessed by pressing <AUTO>, entering three digits, and then pressing <AUTO> again.

The <DIAL> key is used to manually dial a number. Press, <DIAL>, enter the phone number and press <DIAL>. To redial the last number dialed simply press <DIAL> twice.





IMPORTANT TIP!

*The **Number** field (in the Dial menu) is different from other entry fields in the Zephyr Xstream. It is **NOT** necessary to press <SEL> before entering the number to be dialed.*

While we like consistency, this field is used so often, it made sense to make it easier by doing this. It also makes operation more similar to the Zephyr classic.

The <DROP> key is also straightforward in its most basic form. Pressing <DROP> twice will drop any call on "Line 1". If "Line 1" is idle it will drop any call on "Line 2". Therefore, pressing <DROP> four times will clear both lines.

3.2 Zephyr Xstream Rear Panel (non-mixer version)

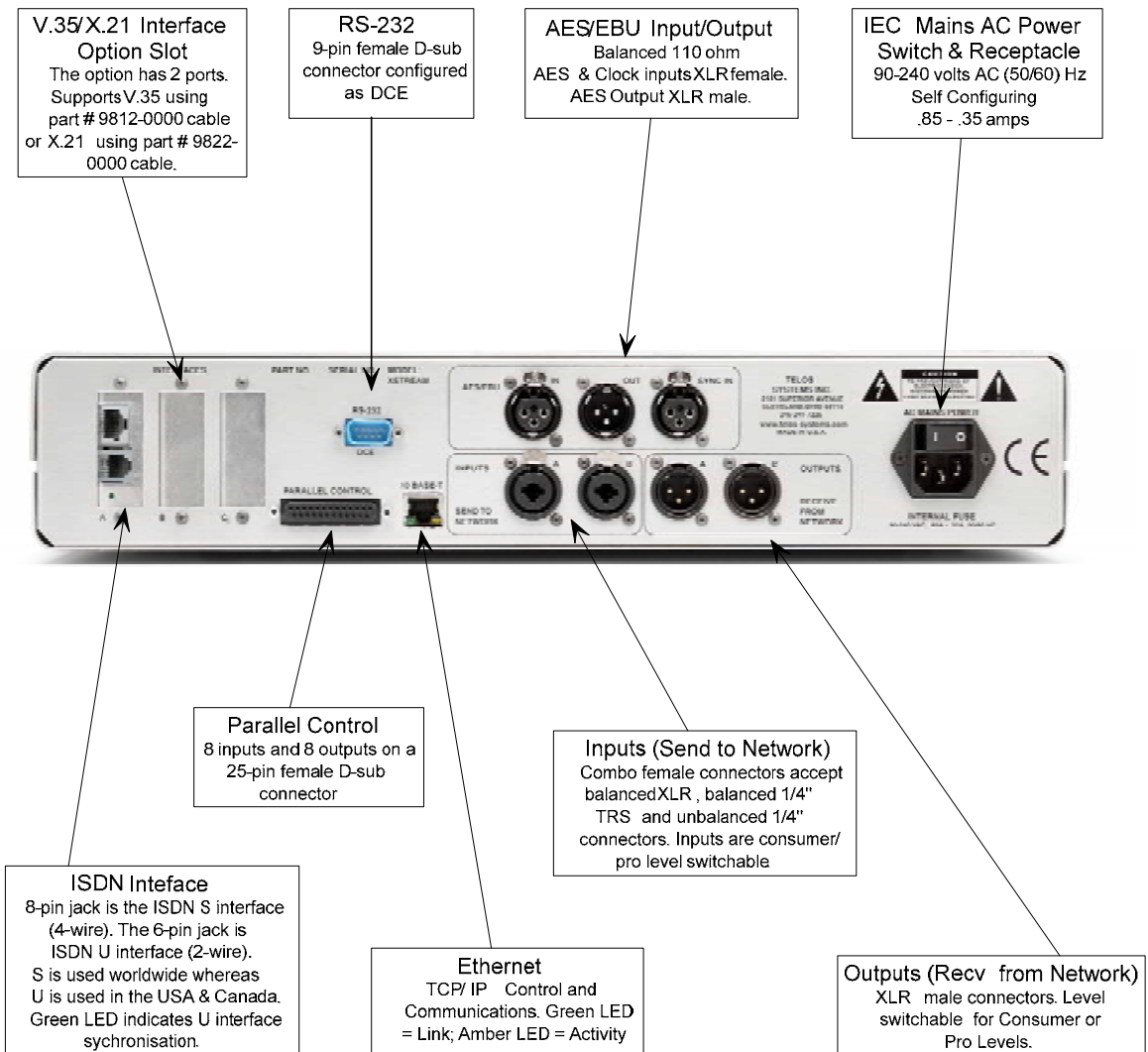

ISDN Interface



IMPORTANT!

As with any piece of modern electronic gear, it is advisable that precautions be taken to prevent damage caused by power surges. Standard telephone line surge protectors can be used to offer some degree of protection at the U interface jack. Special protectors are available for the S interface.

It is the user's responsibility to ensure that adequate protection is provided.

Section 5 has additional information.

U Interface (2 wire) - for use in the USA and Canada

The ISDN U interface is for connection with "raw" 2B1Q BRI ISDN circuits as provided primarily in the USA & Canada. When this jack is used, you will be using Zephyr Xstream's built-in NT1 (Network Terminator). This is a 6-position/4-pin miniature modular jack with the following pin out.

<i>PIN</i>	<i>FUNCTION</i>
1	No Connection
2	No Connection
3	Line (R)
4	Line (T)
5	No Connection
6	No Connection (Top)

ISDN U interface connector. Note, the polarity of the line connections should not matter.

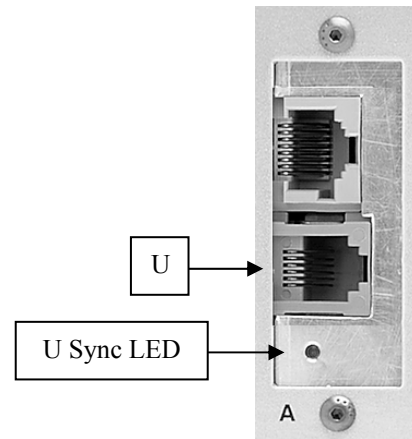

U Interface Sync LED

A green LED, located below the U interface jack, shows the status of the built-in NT1. Normal status is indicated by the LED being lit. Rapid flashing (about five times per second) indicates a loss of the ISDN at the lowest (physical) level. If the NT1 can contact the central office (or an active U repeater), the LED will blink slowly (about once per second) as the S connection between the NT1 and the rest of the ISDN interface occurs. The LED will come on solidly when all handshaking is completed and the basic line connection (OSI Layer 1) is good. If this LED does not light continuously once you have connected your ISDN circuit, you may wish to skip ahead to Section 13.4 (Deep Tech Information - Troubleshooting) for information on troubleshooting problems.

HOT TIP!



Normally, the Telephone Company should supply an RJ-11 style jack for the U interface. This is the same 4 or 6-pin plug used for analog lines. However, sometimes you may find an 8-pin RJ-45 style jack—and sometimes you may even be charged extra for it! If you have this situation, an RJ-11 plug can be inserted into the center of an RJ-45 jack to make things work. If you discover that the Telco charged you extra, be sure to request a refund!

S Interface (4 wire) for use worldwide

The S interface is an 8-position/8-pin miniature modular jack (RJ-45 style) and is supplied for use outside of North America (where the NT1 will be provided by the Telco). It can also be used for special applications where the Zephyr Xstream's built-in NT1 is shared between it, and another, ISDN device, such as an ISDN telephone.

<i>PIN</i>	<i>FUNCTION</i>
1	No Connection
2	No Connection
3	S Transmit to network +
4	S Receive from network +
5	S Receive from network -
6	S Transmit to network -
7	*PS 2 Power (-48 VDC)
8	*PS 2 Power (Ground)

* Available only on early production units

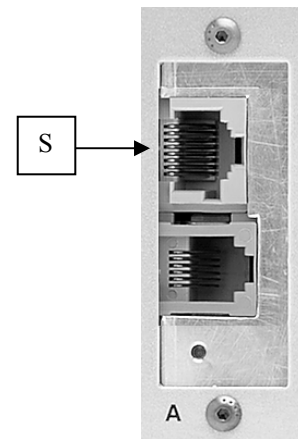

The S interface is a standard modular RJ-45 style jack with the pin-out shown above.

Early rev units have PS2 power source (48 volts DC) provided on Pins 7 & 8 to power external equipment on the S interface. Those units were shipped with PS2 power disabled. To enable -48 see Section 13 (Deep Tech Info) for details *and for important safety warnings.*



IMPORTANT!

Do Not enable PS2 power if you plan to connect the S interface of your Xstream to a Zephyr Classic or ZephyrExpress.

Doing so could cause damage to one of the units!



ISDN TIP!

If you are connecting to ISDN using the S (4-wire) Interface you can ignore the status of the NT1 U Sync LED. It will be flickering rapidly if the U (2-wire) interface is not used.

V.35/X.21 Interface Option

Offers interface to digital synchronous serial bit-streams, primarily for non-ISDN applications. Both V.35 and X.21 equipment can be accommodated with the use of the appropriate cable.

More information can be found in manual Section 9 (The V.35/X.21 Interface).

Communications and Control Ports

RS-232 (DCE)

Using a female 9-pin D-sub connector, this is an RS-232 serial port using the standard modem-style format. The default line protocol is: 8 bits, 1 Stop Bit, No Parity, and no flow control. Bit rate can be adjusted from 2400 to 57,600 bps using the rs232 menu selection in the first *SYSTEM* Menu. The default for this setting is 19,200 bps.

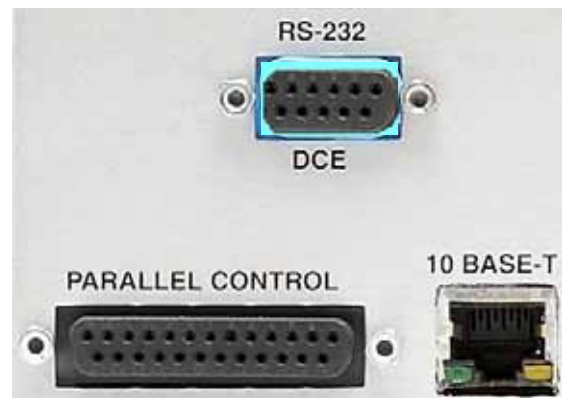

Z

ZEPHYR CLASSIC VS XSTREAM COMPARISON!

NOTE: The RS-232 connectors on the newer Telos gear, such as the Zephyr Xstream, are wired to look like a modem (i.e. DCE), rather than a computer. Therefore, a standard "straight through" cable can be used to connect the Xstream to your computer.

You told us that you were much more likely to connect your equipment to a computer than to a modem, so we responded with this change. We regret any confusion this might cause.

If you need to connect your Xstream to a modem, use a "null modem" adapter such as Radio Shack #26-1496 (25 pin to 25 pin) or #26-264 (9 pin to 9 pin).

<i>PIN</i>	<i>FUNCTION</i>
1*	DCD (Xstream to Computer)
2	RD (Xstream to Computer)
3	TD (Computer to Xstream)
5	Ground
6*	DSR (Xstream to Computer)
8*	CTS (Xstream to Computer)
* These handshake signals are present (i.e. permanently asserted) on motherboard versions "G" and later	

Using a 9 pin female D-Sub connector, this is an RS-232 serial port using the standard 9-pin format, configured as if it were a modem. Zephyr Xstream ignores any incoming handshake signals.

A computer plugged into this port can control the system, and can access a number of special diagnostic modes, as described in Section 12 (System Functions & Remote Control). It is also possible to connect to the Zephyr Xstream's command line using TCP/IP (see below).

When used for local control this function is always available. For more on the local command set see Section 12.

This port can also be placed in a "transparent mode" to allow communication with another Zephyr (Layer-3 only) or Zephyr Xstream (Layer-3 & AAC only). Note single-direction communication is possible if the correct coding mode is only used in one direction.

The following tables show the recommended cable configuration for connecting the Telos Zephyr Xstream to 9-pin and 25-pin DTE (computer) serial ports.

CABLE PIN OUT 9-PIN

Computer (DTE)	Description	Direction	Telos Xstream
1	*Data Carrier Detect (DCD)	◀	1#
2	Receive Data (RD)	◀	2
3	Transmit Data (TD)	▶	3
4	Data Terminal Ready (DTR)	▶	Not used
5	Signal Ground (SG)		5
6	*Data Set Ready (DSR)	◀	6#
7	Request to Send (RTS)	▶	Not used
8	*Clear to Send (CTS)	◀	8#
9	Ring Indicator (RI)	◀	Not present

*Optional connection, may not be required
This signal present on motherboards Rev "G" and later.

CABLE PIN OUT 25-PIN

Computer (DTE)	Description	Direction	Telos Xstream
2	Transmit Data (TD)	▶	3
3	Receive Data (RD)	◀	2
4	Request to Send (RTS)	▶	Not used
5	*Clear to Send (CTS)	◀	8#
6	*Data Set Ready (DSR)	◀	6#
7	Signal Ground (SG)		5
8	*Data Carrier Detect (DCD)	◀	1#
20	Data Terminal Ready (DTR)	▶	Not used
22	Ring Indicator (RI)	◀	Not present

*Optional connection, may not be required
This signal present on motherboards Rev "G" (-07) and later.

If you need to connect your Xstream to a modem, use a "null modem" adapter such as Radio Shack #26-1496 (25 pin to 25 pin) or #26-264 (9 pin to 9 pin).

CURIOSITY NOTE!



The DB- designation for D-Sub connectors is from Cinch Corp's part numbering system. The proper Cinch designation for a 9-pin D-Sub connector is a DE-9p (plug) or DE-9s (socket) not DB-9!

Other Cinch designations for D-Sub connectors are; DA-15, DB-25, DC-37 and DD-50.

Our thanks going out to Mike Schweizer, for contributing this information.

Ethernet

This is an industry standard 100Base-T Ethernet connector on the usual 8-position/8-pin miniature modular (RJ-45 style) jack. Older models have only 10Base-T capability. On units made since 3rd quarter 2006 this supports the Livewire audio over Ethernet standard. Using Telnet and TCP/IP you can connect to the Zephyr Xstream's command line interface to control it or access diagnostic modes. Or you can use this port to control your Xstream using HTML via a standard web browser. The web browser interface is also used to update the Zephyr Xstream's operating software. See Sections 12 (System Functions & Remote Control) & Section 13 (Deep Tech Info) for details.

The 100Base-T connector has two integral LED indicators, which can be helpful, if problems are suspected.

The green "Link" LED (left) indicates the presence of a live physical connection to a working Ethernet hub (or other device). If the green indicator does not light, you should check your network wiring and Ethernet switch. The absence of the link light might also indicate a hardware failure of the Zephyr Xstream.

The amber "Activity" LED (right) indicates network activity on this segment of the network. Depending on network activity, this indicator may only illuminate occasionally; flickering of this light is normal.

	<p>IMPORTANT!</p> <p><i>Xstreams manufactured prior to 3rd quarter 2006 have a 10 Base-T connector instead of a 100Base-T connector. You can identify if your unit supports 100 Base-T and Livewire input/output by checking the rear panel, or by looking in the first System menu. If the rear panel says "100 Base-T" or the software version shown in the system menu end with "r" or "b" your unit has the 100 Base-T Ethernet and supports Livewire input/output.</i></p>
---	---

You can use a browser to communicate with the Zephyr Xstream. Just enter an IP address into the Xstream and enter that IP address in your web browser. User name, if requested, is "user" and there is no default password. The Zephyr Xstream uses a fixed IP address.

	<p>HOT TIP!</p> <p><i>Direct communication is possible without an IP router if both the computer and Xstream have IP addresses in the same subnet (i.e. the first 3 numbers in the IP address match).</i></p> <p><i>You can even connect a computer directly to the Xstream if you use the correct Ethernet "crossover cable". See Appendix 9.</i></p> <p><i>The IP addresses in the range of 192.168.0.0 to 192.168.255.255 are examples of addresses for private network use. They are not assigned to any router on the Internet. Of course, you should make sure they are not being used by another computer on your LAN. Note that these IP addresses cannot be used to update your unit directly from Telos (since they work for local access only).</i></p>
---	---

Parallel Control Port

The parallel control port has 8 inputs and 8 outputs that can be used in a variety of ways. For instance, in AAC, AAC-LD, Layer 3 and certain Layer 2 modes, these contact closures can communicate between two Zephyr Xstreams. By grounding an input on the local Xstream, you would therefore cause current to flow into the corresponding output, at the far end unit. These can also be used for local control and to monitor local status see Section 11 has additional information on the use of this port.

Z

ZEPHYR CLASSIC VS. XSTREAM COMPARISON!

The original Zephyr has only four inputs and outputs numbered 0-3 while the Xstream has 8 inputs 0-7. The four inputs and outputs of the Zephyr will communicate with the first four inputs and outputs of the Xstream (i.e. 0-3)

<i>PIN</i>	<i>FUNCTION</i>
1	+5 Volts DC 400 mA max
2*	Output 0
3*	Output 1
4*	Output 2
5*	Output 3
6	Output 4
7	Output 5
8	Output 6
9	Output 7
10	No Connection
11	No Connection
12	No Connection
13	No Connection
14*	Input 0
15*	Input 1
16*	Input 2
17*	Input 3
18	Input 4
19	Input 5
20	Input 6
21	Input 7
22	Not Connected
23	Not Connected
24	Not Connected
25	Ground
*	These pins are compatible with the corresponding input/outputs of the Zephyr.

NOTE: Pin 1 is connected directly to the +5 volt power supply. Failure to limit current draw on this pin could cause hardware damage or system instability.

Parallel Outputs 0-7

Outputs are open collector to ground and can sink up to 125 mA of current each (actually, any output can sink up to 400 mA, however the maximum combined current should be kept below 1000 mA).

	<p>IMPORTANT!</p> <p><i>Outputs on the Zephyr Xstream motherboards prior to Rev G (1401-0000--007) cannot be used with external pull-ups higher than 5 volts.</i></p> <p><i>If this ability is required contact Telos Systems Customer Support.</i></p>
---	--

These include a 10k-ohm 5 volt pull-up resistor to allow direct interface with 5 volt logic inputs on other equipment. If your other equipment uses a voltage greater than 5 volts, you will need an external pull up resistor, unless it is built-in to that equipment's inputs. An appropriate value is in the range if 2.2K Ω to 10K Ω . Operation with logic inputs requiring a voltage less than 5 volts is not possible.

If used with a relay or LED, then tie your external power source ground to pin 25 (or use the 5 VDC power supplied on pin 1) and run this power source through your device, with a resistor in series to limit maximum current to less than 125 mA.

The outputs can also be used for monitoring the status of the unit. This functionality can be set by several menu selections in *SYSTEM* menu. Refer to Section 11.5 (Detailed Menu Reference) for the menu selections relating to these outputs.

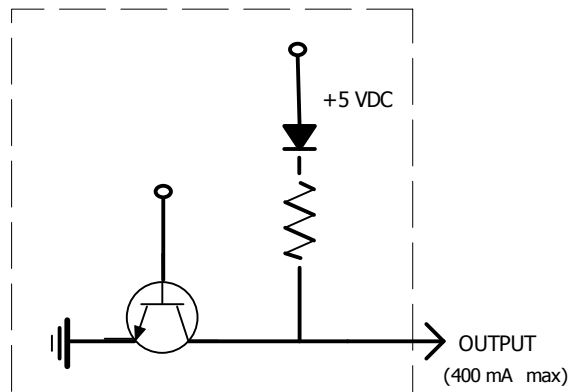

Equivalent schematic for the Parallel Outputs.

An external pull up resistor can be used if voltages greater than 5 volts are used. Alternatively, a voltage source (such as the 5 volts on pin 1) can be driven through an external device (such as a relay or LED) into the input.

Parallel Inputs 0-7

All inputs are specially treated to accept either a voltage (up to 24 VDC), or a closure to ground, which may be provided by switches, relays, or logic outputs. The inputs are active low. In other words, shorting the input to ground causes it to become true (i.e. "asserted").

A built in 1kΩ pull up resistor is provided so TTL outputs can be directly interfaced. See below for a simplified schematic of the input circuitry.

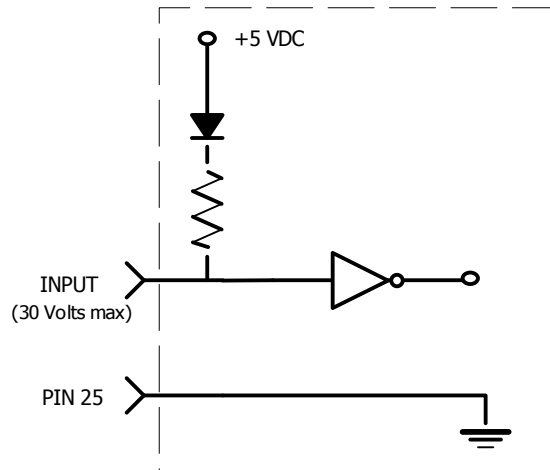

Parallel logic input circuit



DEEP TECH NOTE!

The Zephyr Xstream's "universal" logic input circuit (motherboard rev G and later) can be used with switch or relay closures, voltage levels up to 24 Vdc, or logic outputs – either "totem-pole" or open-collector.

The inputs can be transmitted to the far end Zephyr Xstream when using the Layer-3, AAC, or AAC-LD coding modes. The inputs can also be used for local control functionality such as triggering Dial Setups (Panic Dial). Refer to Section 11.5 (Detailed Menu Reference) for the menu selections relating to these functions.

Analog Inputs & Outputs

Inputs (Send to Network)

These are Combo Connectors with XLR female and ¼" Tip-Ring-Sleeve (TRS) balanced female inputs. The pin out is as follows:

<i>XLR PIN</i>	<i>FUNCTION</i>	<i>TRS PIN</i>
1	Ground	S
2	Audio +	T
3	Audio -	R

The analog audio inputs have the following characteristics:

- Active balanced
- Line level: A menu selection *Level In*, in the *AUDIO* menu, allows selection for Consumer or Pro levels. The nominal input level is jumper setttable on the audio board (See Section 13.1) to allow the following nominal levels:

<i>JUMPER SETTING (J10)</i>	<i>Menu Setting: Professional</i>	<i>Menu Setting: Consumer</i>
*Pins 1/2 and 5/6	+4 dBu nom. (+22 clip)	-11 dBu nom. (+7 clip)
Pins 2/3 and 4/5	0 dBu nom. (+18 clip)	-15 dBu nom. (+3 clip)
* Factory default setting		

- Headroom: 18dB above nominal
- Bridging ≥ 10 K ohm impedance

An analog soft clipper is included to allow maximum dynamic range, while still protecting the user from over loading the A/D converter if input signal exceed these values.

The inputs are designed to be sourced from balanced, line level, signals. Older equipment, with a transformer output stage, may need a terminating resistor (usually 600 ohms) across pins 2 and 3, consult the manual for your equipment for how to use it with high impedance inputs.

Unbalanced sources may be used by connecting pins 3 to the source ground while the signal high is connected to pin 2. We recommend leaving pin 1 (ground) unconnected, as this arrangement will prevent the possibility of ground loops.

	<p>HOT TIP!</p> <p><i>Xstreams with Stereo Audio boards prior to Rev G (1401-0009-007) can handle unbalanced signals at -11dBu or -15dBu only (see jumper settings, above).</i></p> <p><i>The Level In selection in the AUDIO menu should be set to PRO in this case. The Gain Trim selection in the AUDIO menu should be increased until proper levels are observed on the Send meters.</i></p> <p><i>Later version mother boards allow both -11/15dBu (Consumer setting) or 0/+4dBu (Pro setting) unbalanced signals.</i></p>
---	---



HOT TIP!

The signal fed to these inputs should normally be a mix-minus or those monitoring from the far end will hear a delayed version of their own audio coming back to them (i.e. an echo).

See Section 10.3 for details on dealing with delay and mix-minus.

A digital gain adjustment can be used to alter the signal levels into the coder section. Levels can be increased by up to 12dB or decreased by up to 12dB to allow for equipment variation or differing headroom requirements at the far end. This is the *Gain Trim* selection of the *AUDIO* menu. Note that by adjusting the signal at this point, you will decrease system dynamic range by a corresponding amount.



CURIOSITY NOTE!

The Telos Zephyr Xstream uses the more common pin-outs for three pin XLR inputs & outputs. You can easily remember the correct signals when wiring connectors using the phrase "George Washington Bridge." Pin 1 = G = Ground, Pin 2 = W = "+" = White (typical color in mic cable, if there is no white there will be a red conductor), and Pin 3 = B = "-" = Black.

Outputs (Receive from Network)

These are XLR male sockets with the following pin outs.

<i>PIN</i>	<i>FUNCTION</i>
1	Ground
2	Audio +
3	Audio -

The analog audio outputs have the following characteristics:

- Active differential
- Line Level output. A menu selection *Level Out* in the *AUDIO* menu allows adjustment for *Consumer* (-11 dBu) or *Professional* (+4 dBu) levels.
- Clip point: 18 dB above nominal level
- Impedance: < 35 Ohm x 2

If a single-ended (unbalanced) output is required, connect between ground and either of the output pins. **Do not ground the unused pin.** Use the same pin on both outputs to maintain phase.

AES/EBU Inputs & Outputs



These are inputs and outputs for AES/EBU format digital audio signals. More information about the various menus related to their operation is in Section 5 (Guided Tour of the Menus) and Section 11 (Detailed Menu Reference).

AES In (Send to Network)

The input is internally sample-rate converted, so may accept sources at any of the usual rates (32, 44.1, or 48kHz).

A digital gain adjustment can be used to alter the signal levels into the codec section. Levels can be increased or decreased by up to 12dB to allow for equipment variation. This is the *Gain Trim* selection of the *AUDIO* menu.

AES Out (Receive from Network)

The output may be synchronized and sample-rate converted to either the input AES signal's frequency, or the frequency of an independent sync signal presented at the *Sync In* connector. This selection is made in the *AUDIO* menu. See Section 11 (Detailed Menu Reference) for details on this menu option.



DEEP TECH NOTE!

The Sample Rate conversion and AES Sync capabilities allow you to prevent problems with “clock slip” due to different clock rates within a digital facility. Typically a “house clock” reference would be fed to the SYNC IN jack of the Zephyr Xstream, as well as to other equipment, to prevent drop outs due to buffer “overflow” or “underflow” conditions.

It is important to understand that while the Zephyr Xstream provides frequency synchronization, it does not provide byte alignment. Your digital mixing equipment should provide this capability, if required.

AES Sync-In

This jack allows the user to provide an AES/EBU house frequency reference that the Zephyr Xstream can use to match its AES/EBU signal to. The synchronization is accepted from a standard AES/EBU format signal. Only the sync information is stripped; any audio which may be present is ignored.

AC (Mains) power

The AC receptacle connects mains power to the unit with a standard IEC (International Electrotechnical Committee) power cord and provides an on/off switch. The power supply has a “universal” AC input, accepting a range from 100 to 240 VAC, 50-60 Hz. A fuse is located inside on the power supply circuit board.



	<p>IMPORTANT!</p> <p><i>As with any piece of modern electronic gear, it is advisable that precautions be taken to prevent damage caused by power surges. Standard line surge protectors can be used to offer some degree of protection. It is the user's responsibility to ensure protection adequate for their conditions is provided.</i></p> <p><i>Section 4 (Installation & Basic Operation) has additional information.</i></p>
--	---

	<p>WARNING!</p> <p><i>This equipment is designed to be operated from a power source, which includes a third “grounding” connection in addition to the power leads.</i></p> <p><i>Do not defeat this safety feature. In addition to creating a potentially hazardous situation, defeating this safety ground will prevent the internal line noise filter from functioning.</i></p>
--	--

	<p>IMPORTANT SAFETY INFORMATION!</p> <p><i>If fuse replacement is required, please note: For continued protection against fire, replace fuse only with same type and value. See the DETAILED TECHNICAL INFORMATION section for information and cautions.</i></p>	
--	--	--

3.3 Zephyr Xstream MX/MXP Front Panel (Mixer versions)

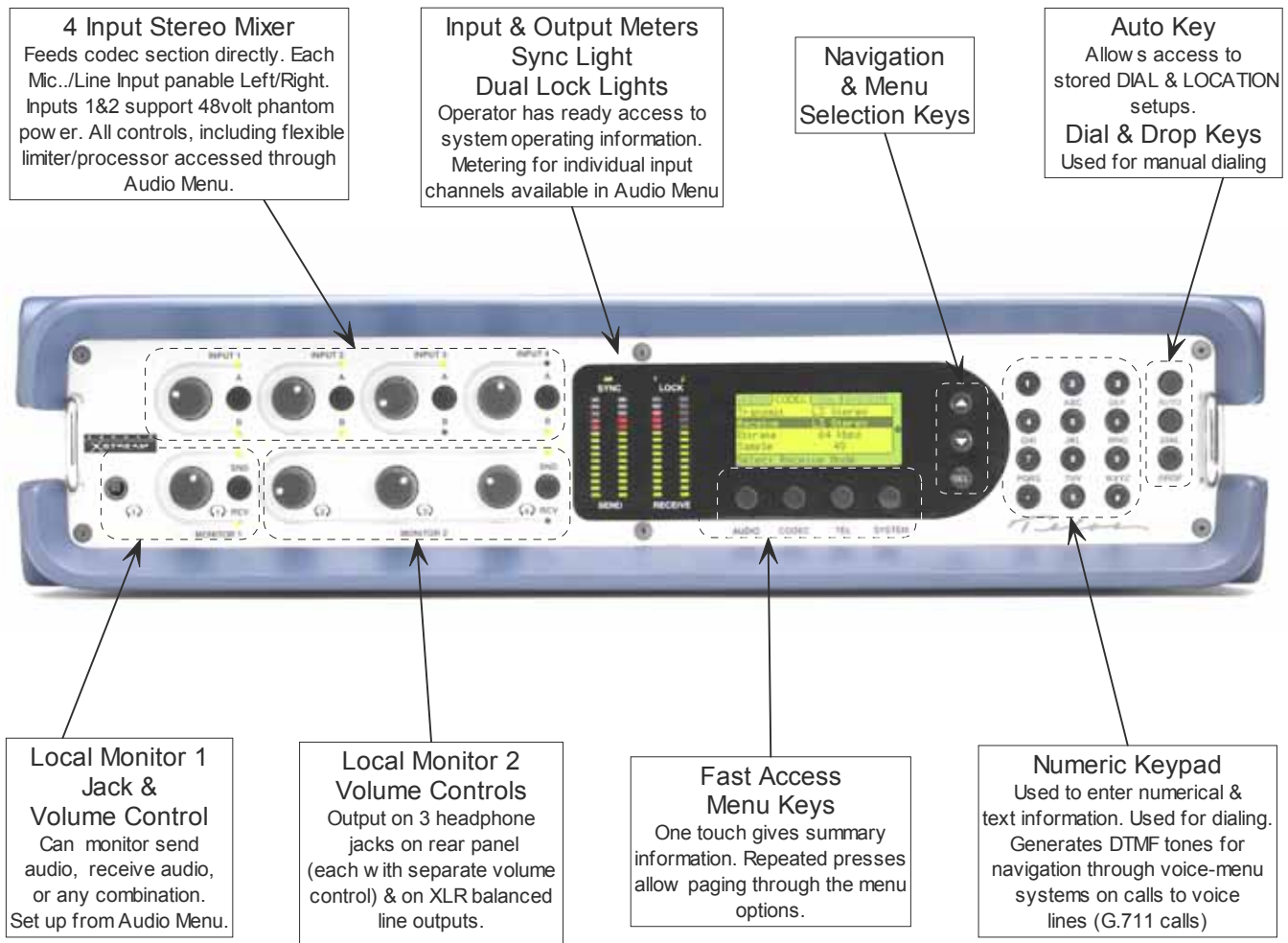

Local Monitor Mix 1 Jack & Volume Control

The front panel has a headphone jack near the left side. The adjacent knob controls the level. The adjacent button allows you to select if you wish to monitor *Snd* (send) audio, *Rcv* (receive) audio or a mix of both. Repeatedly pressing this button will cycle between the options. The sixth *AUDIO* menu allows you to set up the send/receive and A/B balance for local monitor mix 1.



Local Monitor Mix 2 Volume Controls



Local Mix 2 is available on three rear-panel headphone jacks (1/4" stereo jacks) as well as, by default, a pair of balanced XLR jacks - we'll cover these jacks shortly, in Section 3.4. Each of these headphone jacks has an associated front-panel volume control. Just as with Local Monitor Mix 1, an adjacent button allows you to select if you wish to monitor *Snd* (send) audio, *Rcv* (receive) audio or a mix of both. Repeatedly pressing this button cycles between the options. The seventh *AUDIO* menu allows you to set up the Send/Receive and Left/Right balance for local monitor mix 2.

Main Mixer Controls

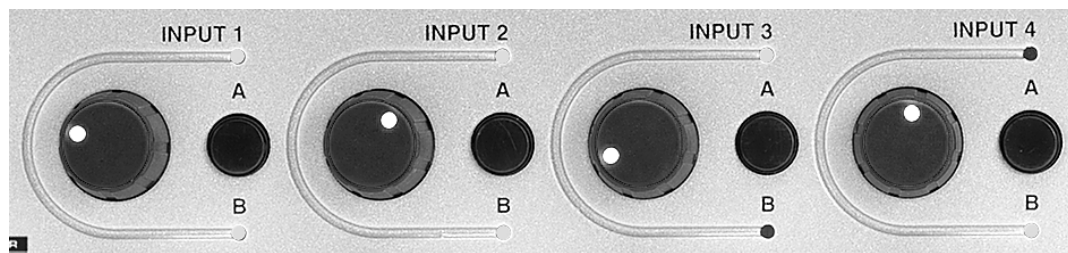

These four knobs control the Zephyr Xstream MX/MXP's input levels for the main mixer section. A button adjacent to each input allows assignment to the A (Left), B (Right), or both, mixer busses.

- The nominal input gain and AGC/Limiter options for each mixer input can be set on the second through the fifth *AUDIO* menus (for inputs 1-4, respectively).
- The Main Mixer's output directly feeds the codec section.
- The factory defaults for inputs 1 and 2 is for microphone inputs levels and assigned to both A and B audio channels.
- The factory defaults for input 3 is "professional" input levels assigned to the A audio channel.
- The factory defaults for input 4 is "professional" input levels assigned to B audio channel.

HOT TIP!

*The nominal inputs levels for each input can be adjusted using the **Ch "x" Gain** option in the 2nd through 3rd **AUDIO** menus.*

*You can also enable phantom power for inputs 1 & 2 on **AUDIO** menu 8. Note that this controls phantom power for both input 1 & 2 simultaneously.*



HOT TIP!

*The individual level of the audio for each of the 4 mixer inputs (post fader) can be monitored on the first **AUDIO** menu (status screen). This permits seeing the ratio of the 4 inputs in the mix shown on the main **SEND** bargraphs.*

*A visible clip indication is also provided. If clipping occurs, the word "Clip" will be displayed for that channel. If clipping occurs you will need to change the **Ch "x" Gain** setting for the input that is clipping.*



Each channel also has individual settings to control the built in AGC/Limiter by Omnia™. The controls are available on the second through fifth **AUDIO** menus for inputs 1 through 4, respectively.

Phantom power for Inputs 1 & 2 can be enabled from the eighth **AUDIO** menu.

Main Mixer Input Assign/Clip LEDs

For each input on the Main Mixer, there are two LEDs. These indicate whether that input is assigned to the A (left) or B (right) mixer buss (or both). When both LEDs are lit the **PAN** setting in the Audio menu for that input determines panning.

These LEDs also have an important secondary function. They act as a "Clip" indicator for the input stage for the associated input. If excessive input levels cause the input stage to clip, these LEDs will flicker for about a second. While occasional clipping may be acceptable (and sometimes inevitable), if these LEDs are flickering with any regularity you should change the **Ch "x" Gain** setting in the **AUDIO** menu for this input (second through fifth **AUDIO** menus).



Meters and indicators

The following LEDs allow you to monitor the system status and audio levels:

Sync LED

The green **Sync** LED indicates, "all is well" with the system. It indicates that certain clock signals are present and that the internal PLL is within its normal range. This LED should normally be illuminated at all times, if the internal ISDN interface is functioning and selected as your **Interface** in the **TEL** Menu.

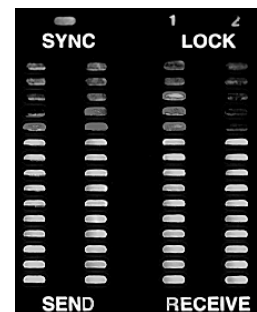

When the V.35/X.21 interface is present (and selected) the *Sync* LED will be illuminated only if a valid external clock signal at the correct frequency for the *Bit Rate* setting (in the *CODEC* menu) is present on one of the two V.35/X.21 ports.

When the Ethernet interface is selected, the *Sync* LED will blink while the Xstream's clock works to sync with the Xstream on the other side of the connection. Due to network conditions, it is common for this light to be solidly on, and then start blinking again as the clock readjusts.

Lock 1 & 2 LEDs

The green *Lock 1* and *Lock 2* LEDs represent the codec decoder status. When a dual channel receive mode is used (i.e. L3 Dual-mono or G.722) the *Lock 1* LED represents that the decoder is locked (or "framed") to the incoming coded audio on "Line 1" while the *Lock 2* LED represents a decoder lock on an incoming audio stream on "Line 2".

In the case of a receive mode requiring both B channels (most stereo mode as well as mono 128) both lock LEDs will illuminate only once a compatible pair of bit-streams are present on both "Lines".

Send Bargraph

The *Send* bargraph LEDs represent the level of audio into the coder section. This level is affected by several factors: The output level of the device connected to the Zephyr Xstream; the setting of the *Ch "x" Gain* option in the *AUDIO* menus; the mixer knob setting.

As with most digital equipment, these meters are calibrated in dBfs (decibels below full scale). In other words, the top LED represents the clip point and the numbers are calibrated in dB below full scale. Therefore, it is important that your levels be set to where the top LED is never lit.

There is a transition of LED color at -10 dBfs. Since the meters are peak indicating, it will generally be safe to run things into the red, depending on the desired headroom and the dynamics of the material. When setting levels with a sine wave (tone), a level near the red green boundary should be used.



HOT TIP!

*The individual level for the audio of each of the 4 mixer inputs (post fader) can be monitored on the first **AUDIO** menu. This permits viewing the ratio of the 4 inputs in the mix shown on the main **SEND** bargraphs.*

Receive Bargraph

The *Receive* Bargraph LEDs represent the level of the audio being decoded from the far end. The level is monitored in the digital domain at the output of the decoder. The calibration and characteristics of the Receive meter match those of the Transmit meter.

Fast Access Menu Keys – AUDIO, CODEC, TEL, SYSTEM

These keys are used to instantly jump to a desired menu. The first key-press displays a summary status screen for that menu. Subsequent presses page through the pages of options for that menu.

The idea is to make it easy to jump directly to a desired menu, simply by pressing the desired menu key a specific number of times.

See Section 5 (Guided Tour of the Menus) and Section 11 (Detailed Menu Reference) for more information.

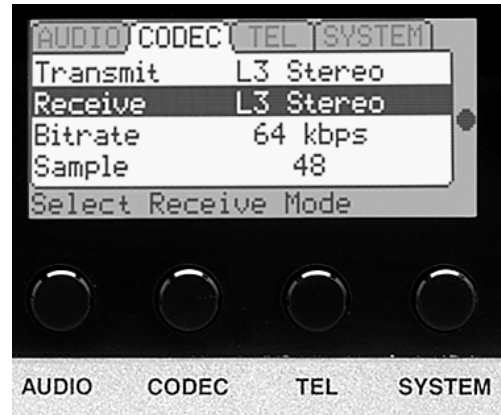

HOT TIP!

*Note that the **CODEC**, **TEL**, & **SYSTEM** menus (and Navigation and Menu Selection Keys) are identical among all models of the Zephyr Xstream. Only the **AUDIO** menu varies between the Xstream (non-mixer) and Xstream MX/MXP (mixer) versions.*

Navigation and Menu Selection Keys

These keys are used to move through the menu options on a given page of menu items. Once the desired menu item has been highlighted, (displayed with white text on a black background) pressing the <SEL> selects this option. You can then use the <▲> or <▼> keys to view the options for this item (or to change the position of a sliding control). The previous setting will have [] around it. Pressing the <SEL> key once again saves your selection.

Pressing any Menu key will abort the entry process and allows you to “escape”.



Numeric Keypad

The operation of this is straightforward. A given button corresponds to the number printed on it. It can also be used for text entry of the letters associated with it. Additional characters are available on the <*> key (i.e. * ([] <> <Space>) and the <#> key (i.e. # . , ; : ! ? <space>) and underscore is available on the <1> key.

To enter text characters, press the key with the appropriate letter printed near it. Keep tapping it to cycle through the possible choices. For example, tapping the 2-key in a text field will first enter A. Repeated taps will change that to a B, then C,



then the lower-case letters, then the number 2. Enter a space by pressing 1 three times. Punctuation characters appear on the * and # keys. The period "." is one the # key.

For example:

Press the number 2 once..... See the character A
 ... press it again..... See the character B
 ... press it again..... See the character C
 ... press it again..... See the character a
 ... press it again..... See the character b
 ... press it again..... See the character c
 ... press it again..... See the numeral 2
 ... press it yet again..... the cycle starts again from A

To move to the next character in a field, tap any other key or press the <▼> button. To back up (delete), press the <▲> key.

AUTO, DIAL, & DROP Keys

These keys will be covered in greater detail in Section 4.2 (Basic Installation & Operation).

AUTO

The <AUTO> key allows access to Zephyr Xstream's 100 stored *Dial Setups* (#00 to #99). These can be accessed by pressing <AUTO>, entering two digits, and then pressing <AUTO> again.

It can also be used to access the 30 *Location Setups* (#100 to 129) can be accessed to configure the ISDN settings for frequently visited locations. Press and hold the <▼> key to jump to the *Location Setups*. Or, press <AUTO> enter 3 digits and press <AUTO> again.



DIAL

The <DIAL> key is used to manually dial a number. Press, <DIAL>, enter the phone number and press <DIAL>. To redial the last number dialed simply press <DIAL> twice.

DROP

The <DROP> key is also straightforward in its most basic form. Pressing <DROP> twice will drop any call on "Line 1". If "Line 1" is idle, it will drop any call on "Line 2". Therefore, pressing <DROP> four times will clear both lines. Of course you also have the option of choosing a specific line to drop.

3.4 Zephyr Xstream MX/MXP Rear Panel (Mixer versions)

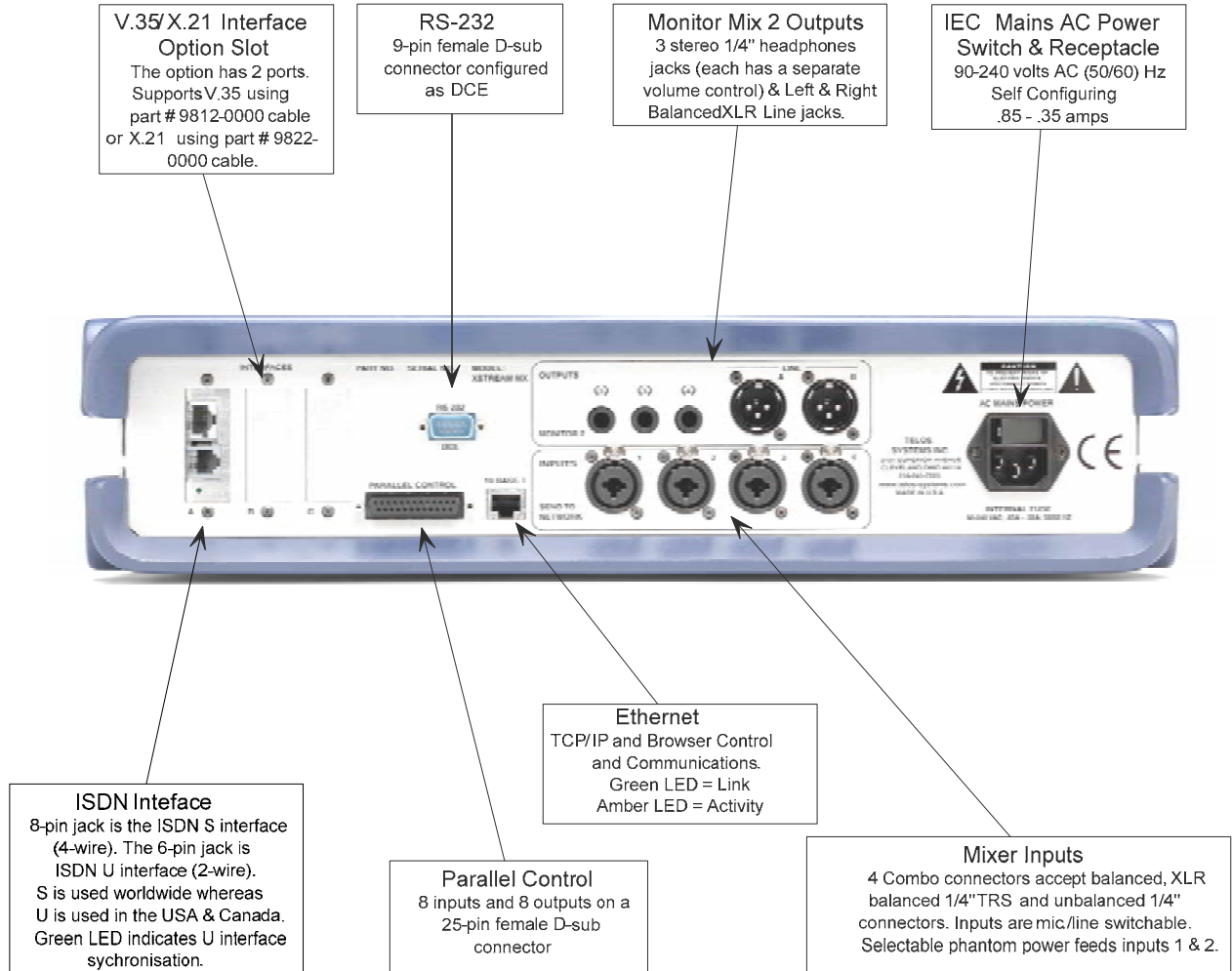

ISDN Interface

	<p>IMPORTANT!</p> <p><i>As with any piece of modern electronic gear, it is advisable that precautions be taken to prevent damage caused by power surges. Standard telephone line surge protectors can be used to offer some degree of protection at the U interface. Special protectors are available for the S interface.</i></p> <p><i>It is the user's responsibility to ensure that adequate protection is provided.</i></p> <p><i>Section 4 has additional information.</i></p>
---	---

U Interface (2 wire) - for use in the USA and Canada

The ISDN U interface is for connection with "raw" 2B1Q BRI ISDN circuits as provided primarily in the USA & Canada. When this jack is connected you will be using Zephyr Xstream's built-in NT1 (Network Terminator). This is a 6-position/4-pin miniature modular jack with the following pin out.

<i>PIN</i>	<i>FUNCTION</i>
1	No Connection
2	No Connection
3	Line (R)
4	Line (T)
5	No Connection
6	No Connection (Top)

ISDN U interface connector. Note, the polarity of the line connections should not matter.

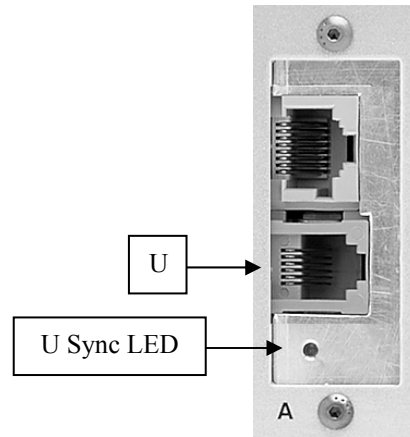

U Interface Sync LED

A green LED, located below the U interface jack, shows the status of the built-in NT1. Normal status is indicated by the LED being lit. Rapid flashing (about five times per second) indicates a loss of the ISDN at the lowest (physical) level. If the NT1 can contact the central office (or an active U repeater), the LED will blink slowly (about once per second) as the S connection between the NT1 and the rest of the ISDN interface occurs. The LED will come on solidly when all handshaking is completed and the basic line connection is good. If this LED does not light continuously, once you have connected your ISDN circuit, you may wish to skip ahead to Section 13 (Deep Tech Information - Troubleshooting) for information on troubleshooting the problem.



HOT TIP!

Normally, the Telephone Company should supply an RJ-11 style jack for the U interface. This is the same 4 or 6-pin plug used for analog lines. However, sometimes you may find an 8-pin RJ-45 style jack—and sometimes you may even be charged extra for it! If you have this situation, an RJ-11 plug can be inserted into the center of an RJ-45 jack to make things work. If you discover that the Telco charged you extra, be sure to request a refund!

S Interface (4 wire) for use worldwide

The S interface is a 8-position/8-pin miniature modular jack (RJ-45 style) and is supplied for use outside of North America (where the NT1 will be provided by the Telco). It can also be used for special applications where the Zephyr Xstream's built-in NT1 is shared between it and another ISDN device, such as an ISDN telephone.

<i>PIN</i>	<i>FUNCTION</i>
1	No Connection
2	No Connection
3	S Transmit to network +
4	S Receive from network +
5	S Receive from network -
6	S Transmit to network -
7	*PS2 Power (-48 VDC)
8	*PS2 Power ground (+) (Top)

*Available only on early production units

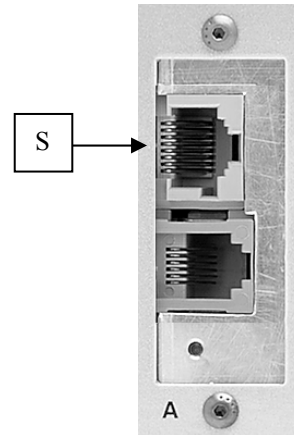

The S interface is a standard modular RJ-45 style jack with the pin-out shown above.

Early rev units have PS2 power source (48 volts DC) provided on Pins 7 & 8 to power external equipment on the S interface. Those units were shipped with PS2 power disabled. To enable -48 see Section 13 (Deep Tech Info) for details *and for important safety warnings.*

	<p>IMPORTANT!</p> <p><i>Do Not enable PS2 power if you plan to connect the S interface of your Xstream to a Zephyr Classic or ZephyrExpress.</i></p> <p><i>Doing so could cause damage to one of the units!</i></p>
---	--

	<p>ISDN TIP!</p> <p><i>If you are connecting to ISDN using the S (4-wire) Interface you can ignore the status of the NT1 Sync LED. It will be flickering rapidly if the U (2-wire) interface is not used.</i></p>
---	--

V.35/X.21 Interface Option

Offers interface to digital synchronous serial bit-streams, primarily for non-ISDN applications. Either V.35 and X.21 equipment can be accommodated by the use of the appropriate cable.

More information can be found in manual Section 9 (The V.35/X.21 Interface).

Communications and Control Ports

RS-232 (DCE)

Using a female 9-pin D-sub connector, this is an RS-232 serial port using the standard modem-style format. The default line protocol is: 8 bits, 1 Stop Bit, No Parity, with no flow control. Rate is selectable from 2400 to 57,600 bps using the RS232 menu selection in the first SYSTEM menu. Default is 19,200 bps.



Z	<p>ZEPHYR VS XSTREAM COMPARISON!</p> <p><i>NOTE: The RS-232 connectors on the newer Telos gear, such as the Zephyr Xstream, are wired to look like a modem (i.e. DCE), rather than a computer. Therefore, a standard "straight through" cable can be used to connect the Xstream to your computer.</i></p> <p><i>You told us that you were much more likely to connect your equipment to a computer than to a modem, so we responded with this change. We regret any confusion this might cause.</i></p> <p><i>If you need to connect your Xstream to a modem, use a "null modem" adapter such as Radio Shack #26-1496 (25 pin to 25 pin) or #26-264 (9 pin to 9 pin).</i></p>
---	---

<i>PIN</i>	<i>FUNCTION</i>
1*	DCD (Xstream to Computer)
2	RD (Xstream to Computer)
3	TD (Computer to Xstream)
5	Ground
6*	DSR (Xstream to Computer)
8*	CTS (Xstream to Computer)
* These handshake signals are present (i.e. permanently asserted) on motherboard versions "E" and later	

Using a 9 pin female D-Sub connector, this is an RS-232 serial port using the standard PC-style format, configured as if it were a modem. Zephyr Xstream ignores any incoming handshake signals.

A computer plugged into this port can control the system, and can access a number of special diagnostic modes, as described in Section 12 (System Functions & Remote Control). It is also possible to connect to the Zephyr Xstream's command line using TCP/IP (see below).

When used for local control this function is always available. For more on the local command set see Section 12.

This port can also be placed in a "transparent mode" to allow communication with another Zephyr (Layer-3 only) or Zephyr Xstream (Layer-3 & AAC only). Note single-direction communication is possible if the correct coding mode is only used in one direction.

The following tables show the recommended cable configuration for connecting the Telos Zephyr Xstream to 9-pin and 25-pin DTE (computer) serial ports.

CABLE PIN OUT 9-PIN			
Computer (DTE)	Description	Direction	Telos Xstream
1	*Data Carrier Detect (DCD)	◀	1#
2	Receive Data (RD)	◀	2
3	Transmit Data (TD)	▶	3
4	Data Terminal Ready (DTR)	▶	Not used
5	Signal Ground (SG)		5
6	*Data Set Ready (DSR)	◀	6#
7	Request to Send (RTS)	▶	Not used
8	*Clear to Send (CTS)	◀	8#
9	Ring Indicator (RI)	◀	Not present

*Optional connection, may not be required
This signal present on motherboards Rev "E" (-07) and later.

CABLE PIN OUT 25-PIN			
Computer (DTE)	Description	Direction	Telos Xstream
2	Transmit Data (TD)	▶	3
3	Receive Data (RD)	◀	2
4	Request to Send (RTS)	▶	Not used
5	*Clear to Send (CTS)	◀	8#
6	*Data Set Ready (DSR)	◀	6#
7	Signal Ground (SG)		
8	*Data Carrier Detect (DCD)	◀	1#
20	Data Terminal Ready (DTR)	▶	Not used
22	Ring Indicator (RI)	◀	Not present

*Optional connection, may not be required
This signal present on motherboards Rev "E" (-07) and later.

If you need to connect your Xstream to a modem, use a "null modem" adapter such as Radio Shack #26-1496 (25 pin to 25 pin) or #26-264 (9 pin to 9 pin).

	<p>CURIOSITY NOTE!</p> <p><i>The DB- designation for D-Sub connectors is from Cinch Corp's part numbering system. The proper Cinch designation for a 9 pin D-Sub connector is a DE-9p (plug) or DE-9s (socket) not DB-9!</i></p> <p><i>Other Cinch designations for D-Sub connectors are; DA-15, DB-25, DC-37 and DD-50.</i></p> <p><i>Our thanks going out to Mike Schweizer, for contributing this information.</i></p>
---	--

Ethernet

This is an industry standard 100Base-T Ethernet connector on the usual 8-position/8-pin miniature modular (RJ-45 style) jack. On units made since 3rd quarter 2006 this supports the Livewire audio over Ethernet standard. Using Telnet and TCP/IP you can connect to the Zephyr Xstream's command line interface to control it or access diagnostic modes. Or you can use this port to control your Xstream using HTML via a standard web browser. The Zephyr Xstream can also use FTP over TCP/IP to update its operating software over this port. See Section 12 (System Functions & Remote Control) & Section 13 (Deep Tech Info) for details.

The 100Base-T connector has two integral LED indicators which can be helpful if problems are suspected.

The green "Link" LED (left) indicates the presence of a live physical connection to a working Ethernet hub (or other device). If the green indicator does not light, you should check your network wiring and Ethernet Hub. The absence of the link light might also indicate a hardware failure of the Zephyr Xstream.

The amber "Activity" LED (right) indicates network activity on this segment of the network. Depending on network activity, this indicator may only illuminate occasionally; flickering of this light is normal.



IMPORTANT!

Early rev Xstreams have a 10 Base-T connector instead of a 100Base-T connector. You can identify if your unit supports 100 Base-T and Livewire streaming by checking the rear panel, or by looking in the first System menu. If the rear panel says "100 Base-T," or the software version displayed in the System menu ends with a "b" or "r" your unit has the 100 Base-T Ethernet and supports Livewire input/output.

You can use a browser to communicate with the Zephyr Xstream. Just enter an IP address into the Xstream and enter that IP address in your browser. User name, if requested, is "user" and there is no default password. The Zephyr Xstream uses a fixed IP address.



HOT TIP!

Direct communication is possible without an IP router if both the computer and Xstream have IP addresses in the same subnet (i.e. the first 3 numbers in the IP address match).

You can even connect a computer directly to the Xstream if you use the correct Ethernet "crossover cable". See Appendix 5.

The IP addresses in the range of 192.168.0.0 to 192.168.255.255 are considered safe for private network use. They are not assigned to any router on the Internet. Of course you should make sure they are not being used by another computer on your LAN. Note that these IP addresses cannot be used to update your unit directly from Telos (since they work for local access only).

Parallel Control Port

The parallel control port has 8 inputs and 8 outputs that can be used in a variety of ways. For instance, in AAC, AAC-LD, Layer 3 and certain Layer 2 modes, these contact closures can communicate between two Zephyr Xstreams. By grounding an input on the local Xstream, you would therefore cause current to flow into the corresponding output at the far end unit. These can also be used for local control and to monitor local status.

Z

ZEPHYR CLASSIC VS. XSTREAM COMPARISON!

The original Zephyr has only four inputs and outputs numbered 0-3 while the Xstream has 8 inputs 0-7. The four inputs and outputs of the Zephyr will communicate with the first four inputs and outputs of the Xstream (i.e. 0-3).

<i>PIN</i>	<i>FUNCTION</i>
1	+5 Volts DC 400 mA max
2*	Output 0
3*	Output 1
4*	Output 2
5*	Output 3
6	Output 4
7+	Output 5
8+	Output 6
9+	Output 7
10	No Connection
11	No Connection
12	No Connection
13	No Connection
14*	Input 0
15*	Input 1
16*	Input 2
17*	Input 3
18	Input 4
19+	Input 5
20+	Input 6
21+	Input 7
22	Not Connected
23	Not Connected
24	Not Connected
25	Ground
*	These pins are compatible with the corresponding input/outputs of the Zephyr Classic.
+	These pins are compatible with the corresponding inputs/ outputs of the Zephyr Xport

NOTE: Pin 1 is connected directly to the +5 volt power supply. Failure to limit current draw on this pin could cause hardware damage or system instability.

Parallel Outputs 0-7

Outputs are open collector to ground and can sink up to 125 mA of current each (actually, any output can sink up to 400 mA, however the maximum combined current should be kept below 1000 mA).



IMPORTANT!

Outputs on Zephyr Xstream motherboards prior to Rev G (1401-0000--007) cannot be used with external pull ups higher than 5 volts.

If this ability is required, please contact Telos customer support.

These will include a 10k-ohm 5 volt pull-up resistor to allow direct interface with 5 volt logic inputs on other equipment. If your other equipment uses a voltage greater than 5 volts, you will need an external pull up resistor, unless it is built-in to that equipment's inputs. An appropriate value is in the range of 2.2K Ω to 10K Ω . Operation with logic inputs requiring a voltage less than 5 volts is not possible.

If used with a relay or LED, then tie your external power source ground to pin 25 (or use the 5 VDC power supplied on pin 1) and run this power source through your device, with a resistor in series to limit maximum current to less than 125 mA.

The outputs can also be used for monitoring the status of the unit. This functionality can be set by several menu selections in *SYSTEM* menu. Refer to Section 11.5 (Detailed Menu Reference) for the menu selections relating to these outputs.

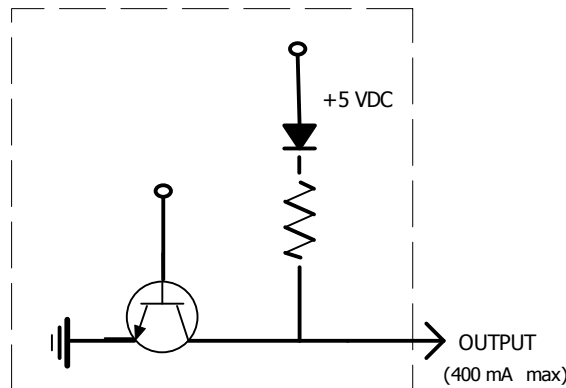

Equivalent schematic for the Parallel Outputs.

An external pull up resistor can be used if voltages greater than 5 volts are used. Alternatively, a voltage source (such as the 5 volts on pin 1) can be driven through an external device (such as a relay or LED) into the input.

Parallel Inputs 0-7

All inputs are specially treated to accept either a voltage (up to 24 VDC), or a closure to ground, which may be provided by switches, relays, or logic outputs. The inputs are active low. In other words, shorting the input to ground causes it to become true (i.e. "asserted").

A built in 1kΩ pull up resistor is provided so TTL outputs can be directly interfaced. See below for a simplified schematic of the input circuitry.

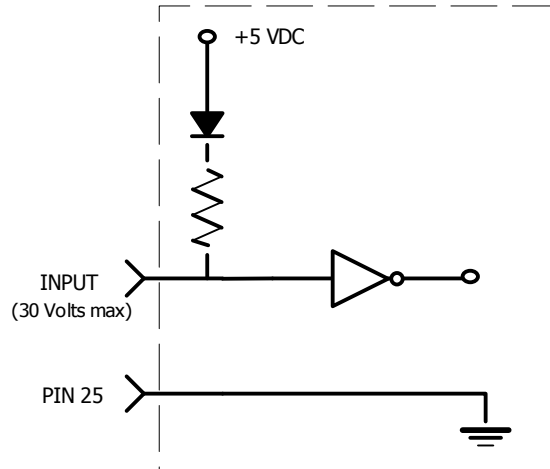

Parallel logic input circuit



DEEP TECH NOTE!

The Zephyr Xstream's "universal" logic input circuit can be used with switch or relay closures, voltage levels up to 24 Vdc, or logic outputs – either "totem-pole" or open-collector.

The inputs can be transmitted to the far end Zephyr Xstream when using the Layer-3 or AAC coding mode. The inputs can also be used for local control functionality such as triggering Dial Setups (Panic Dial). Refer to Section 11.5 (Detailed Menu Reference) for the menu selections relating to these functions.

Main Mixer Inputs (Send to Network)

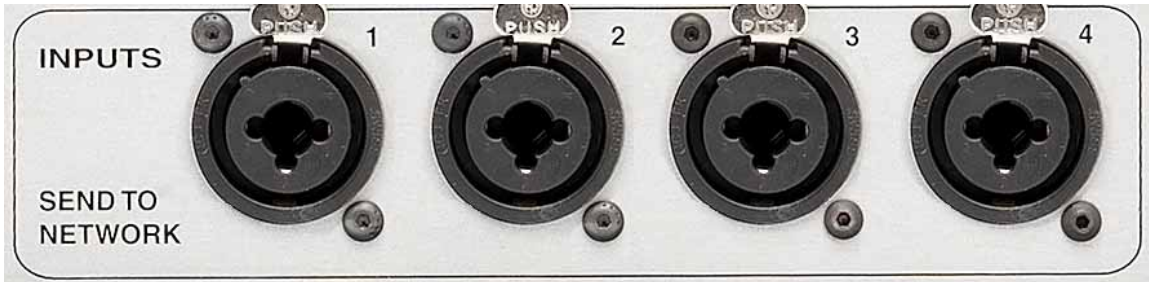

These are Combo Connectors with XLR female and ¼" Tip-Ring-Sleeve (TRS) female inputs. The pin out is as follows:

<i>XLR PIN</i>	<i>FUNCTION</i>	<i>TRS PIN</i>
1	Ground	S
2	Audio +	T
3	Audio -	R

The analog audio inputs have the following characteristics:

- Active balanced
- Mic. or Line level: The system allows selection from 2 microphone settings and two line level settings, as set using the *Ch X Gain* selection in the 2nd through 5th *AUDIO* menus. The mix level for each range is adjustable, of course, and is also affected by the built-in AGC/Limiter (selected in the *Ch "x" Proc* menu selection on the second through the fifth *AUDIO* menus). The values given above are the nominal levels for a sine wave when the input adjustment is at the 3-o'clock position and the AGC/Limiter is off. The following are the nominal inputs levels for each setting (AGC/Limiter off, fader set to mid position). 15 dB of headroom is provided.
- With certain high output microphones, a 10 dB pad may be necessary to prevent overload. These are commonly available: For instance the Whirlwind Pad IMP-10.

<i>MENU SETTING</i>	<i>LEVEL</i>
<i>(AUDIO menus 2-5)</i>	
<i>MIC +44</i>	-60 dBu nom. (-41 clip)
<i>MIC +30</i>	-40 dBu nom. (-26 clip)
<i>Line Con</i>	-10 dBu (+4 clip)
<i>Line Pro</i>	+4 dBu (+18 clip)

- Bridging ≥ 10 K ohm impedance

The inputs are designed to be sourced from balanced, signals. Older equipment (or some microphones) with a transformer output stage may need a terminating resistor (usually 600 ohms) across pins 2 and 3, consult the manual for your equipment for how to use it with high impedance inputs.

Unbalanced sources may be used by connecting pins 3 to the source ground, while the signal high is connected to pin 2. We recommend leaving pin 1 (ground) unconnected, as this arrangement will prevent the possibility of ground loops.



HOT TIP!

The signal fed to these inputs should normally be a mix-minus or those monitoring from the far end will hear a delayed version of their own audio coming back to them (i.e. an echo).

See section 10.3 for details on dealing with delay and mix-minus.



CURIOSITY NOTE!

The Telos Zephyr Xstream the more common pin-outs for three pin XLR inputs & outputs. You can easily remember the correct signals when wiring connectors using the phrase "George Washington Bridge." Pin 1 = G = Ground, Pin 2 = W = "+" = White (typical color in mic cable, if there is no white there will be a red conductor), and Pin 3 = B = "-" = Black.

Local Monitor Mix 1 Outputs

See the Section 3.3 for information on this headphone level output, located on the front panel. On units with rev F audio boards this mix can be output on the XLRs instead of Local Monitor Mix 2.

Local Monitor Mix 2 Outputs



Local Monitor Mix 2 can be set up to monitor *Snd* (send) Audio, *Rcv* (receive) Audio or a combination of both. The audio to be monitored is controlled by the button adjacent to the headphone 4 knob on the front panel. The ratio of send to receive audio and other parameters are set up in the seventh *AUDIO* menu. Headphones 2 – 4 have individual front panel volume controls. The A and B line outputs are at +4 dBu nominal level.

These are standard ¼" stereo jacks. They are designed to handle headphones with impedances down to 10 ohms. The output level is approx 3 watts into 20 ohms and will vary depending on the headphone impedance.

XLR Monitor Mix Outputs

By default these XLR outputs are fed from Local Monitor Mix 2. On units with rev F or later MIC Audio Boards (part # 1401-00008-006 or later) the unit can be configured to be fed from Local Monitor Mix 1. These are XLR male sockets with the following pin outs.

<i>PIN</i>	<i>FUNCTION</i>
1	Ground
2	Audio +
3	Audio -

The analog audio outputs have the following characteristics:

- Active differential
- Output level; Line Level output at +4 dBu nominal. The *Level Out* option in the eighth *AUDIO* menu allows selection for *Consumer* (-10 dBu) or *Professional* (+ 4 dBu) output levels for these outputs. 18 dB headroom is provided (+22 dBu maximum output level).
- Impedance: < 33 ohm x 2

If a single-ended (unbalanced) output is required, connect between ground and either of the output pins. **Do not ground the unused pin.** Use the same pin on both outputs to maintain phase.

AC (Mains) power

The AC receptacle connects mains power to the unit with a standard IEC (International Electrotechnical Commission) power cord and provides an on/off switch. The power supply has a "universal" AC input, accepting a range from 100 to 240 VAC, 50-60 Hz. A fuse is located inside on the power supply circuit board.





IMPORTANT!

As with any piece of modern electronic gear, it is advisable that precautions be taken to prevent damage caused by power surges. Standard line surge protectors can be used to offer some degree of protection. It is the user's responsibility to ensure protection adequate for their conditions is provided.

Section 4 (Basic Operation & Installation) has additional information.



WARNING!

This equipment is designed to be operated from a power source that includes a third "grounding" connection in addition to the power leads.

Do not defeat this safety feature. In addition to creating a potentially hazardous situation, defeating this safety ground will prevent the internal line noise filter from functioning.



IMPORTANT SAFETY INFORMATION!

*If fuse replacement is required, please note: **For continued protection against fire, replace fuse only with same type and value.** See Section 13 (Deep Tech Information) for information and cautions.*





USER'S MANUAL

4 BASIC OPERATION & INSTALLATION

This section is intended only as an introduction. For many ISDN users, it will provide all the information needed to get started with the unit. However, you may also need to review Section 5 (Guided Tour of the Menus) & Section 11 (Detailed Menu Reference), particularly if you are using remote control or one of the other advanced features. If you are using V.35 or Ethernet streaming mode see Section 10 and Appendix 6, respectively.

Section 7 also has a number of tips about SPIDs and ISDN protocol types. Section 1 has step-by-step instructions for quick start up and initial testing.

4.1 Essentials

Your Zephyr Xstream should ideally be placed in a location convenient to the operator. As the unit has no fan or other noise-producing elements, you may wish to locate it in the studio to which it is connected.

Large facilities may wish to locate a bank of Zephyr Xstreams in the main equipment room. In this case a web browser can be used to control the Zephyr Xstream remotely using HTML. Or, you may wish to consider using The Software Authority's Zephyr Remote software package (see <http://www.softwareauthority.com/zephyrremote.htm> for additional information).

Environmental Considerations

Heating, Ventilating, & Cooling Requirements

For optimal reliability, it is necessary to avoid exceeding the maximum allowable ambient air temperatures surrounding the Zephyr Xstream. Ambient air temperature should be between 0 to 40 degrees Celsius (32 to 104 degrees Fahrenheit). Relative humidity may be between 0 to 98% (non-condensing).

AC (mains) Requirements

The system is designed to work from 100 to 240 volts AC, 50-60 Hz. As with any microprocessor-based equipment, it is desirable that the Zephyr Xstream be fed from a reliable source of clean power. A UPS (uninterruptible power supply) with noise suppression would be helpful, particularly if local power is unreliable.

AC surge protection is also desirable. Our first choice would be a top-of-the-line unit containing a ferro-resonant transformer as well as a UPS. You will want to avoid "bargain basement" brands, which can cause more problems than they solve.



One possible source is Best Power Technology with its ferro-resonant transformer/UPS combination for extremely clean UPS power. Another source is American Power Conversion. Their Back-Ups Pro series is well suited for microprocessor-based equipment such as the Zephyr Xstream.

Be sure that UPS battery replacement goes on your preventative maintenance schedule.

It is essential that the third “grounding” pin not be defeated on the power cord and that the power cord be connected to a properly grounded receptacle. If a grounded receptacle is not available, a qualified electrical contractor, familiar with the regulations in your area, should be contracted to provide one.

	<p>IMPORTANT!</p> <p><i>As with any piece of modern electronic gear, it is advisable that precautions be taken to prevent damage caused by power surges. Standard line surge protectors can be used to offer some degree of protection. It is the user’s responsibility to ensure protection adequate for their conditions is provided (see above).</i></p>
---	--

	<p>WARNING!</p> <p><i>This equipment is designed to be operated from a power source that includes a third “grounding” connection in addition to the power leads.</i></p> <p><i>Do not defeat this safety feature. In addition to creating a potentially hazardous situation, defeating this safety ground will prevent the internal line noise filter from functioning.</i></p>
--	--

	<p>IMPORTANT SAFETY INFORMATION!</p> <p><i>If fuse replacement is required, please note: For continued protection against fire, replace fuse only with same type and value. See the DETAILED TECHNICAL INFORMATION section for information and cautions.</i></p>	
---	---	---

ISDN Lightning Protection

The single biggest source of failures of Telecom equipment is due to damage related to lightning. Some failures are catastrophic failures, while some are due to the cumulative damage that can occur over the course of several years. For this reason, we also recommend that in addition to AC (mains) power protection (see above), that a quality telephone line s-stage surge protector be employed at the back panel of the Zephyr Xstream. The ground terminal of this device should be connected directly to the Zephyr Xstream chassis, and the protector connected to the Xstream’s ISDN Interface jack with as short a cable as possible (under 8 inches). This approach is particularly well suited to situations where you expect nearby strikes, such as when you are located near a tower.

One Source for an appropriate unit is American Power Conversion. Their model "PdigiTel" is suitable for use on either the S or U interface (also suitable for T1). See <http://www.apcc.com/products> for additional information.

Another source would be Panamax. Their model "Max ISDN" Allpath is suitable for the ISDN S or U interfaces (also suitable for T1).

Another source is Allcom model "552-U", suitable for the ISDN S and U interfaces. See: <http://www.allcomtlc.com>

Another possible source for an appropriate unit is Polyphaser. See <http://www.polyphaser.com/> Users have reported good results with their multi-conductor twisted pair models. (a unit with 65 kHz bandwidth should be correct) They also have a number of good papers on lightning protection on their site.

A source for protection on Switched-56 or DDS circuits (model 22-64) protectors is Telebyte corp. See <http://www.telebyteusa.com> .

Many other sources are available. Search "surge+ISDN" for numerous sources.

4.2 Introduction to Zephyr Xstream's Menu System

The Zephyr Xstream has seven menus. The four primary menus are *AUDIO*, *CODEC*, *TEL* and *SYSTEM*. Repeated presses of the associated menu button, located immediately below the LCD screen, access these menus. The following information is meant as a quick introduction only. Section 11 (Detailed Menu Reference) covers the menu selections for the primary menus in detail.

The Default Display

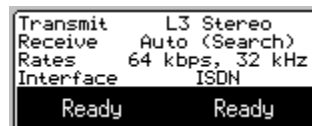

The default display will appear after the system has been left idle for 60 seconds. It gives summary information on system status. At the bottom, in inverse text is the status of each ISDN "line" or V.35 port.

The Primary Menus; AUDIO, CODEC, TEL & SYSTEM

Pressing of any of these primary menu buttons once gives a summary status screen for the functions related to that menu.

Repeated presses of the menu button pages through the menu's screen one at a time. The intention is that frequent users will learn the locations of commonly accessed items, and will be able to jump directly to the associated menu page in question.

Once a desired page of menu selections is shown on the display, you must



highlight and select the item to be changed (or field to be edited). The current selection will be highlighted; i.e. it will be displayed with white text on a black background. Other menu items (which are not highlighted) will be shown with black text on a white background. You can change which item is highlighted using the <▲> & <▼> buttons.

NOTE that the options in several of the menus will vary depending on if you are configured to use ISDN, V.35, or Ethernet.

	<p>HOT TIP!</p> <p><i>The bottom line of the LCD display will give you a description of the highlighted menu item. This context sensitive help will give you an indication of what an item does. For more information about that item, push the <SEL> button.</i></p>
---	--

Once the desired menu selection is highlighted, you must select it by pressing the <SEL> button. The selected item will move to the top of the screen and detailed information about that menu selection will be shown below it.

In the case of most menu items, you can now view the options for this item using the <▲> or <▼> buttons. Note that the option currently in effect has square brackets “[]” around it.

	<p>IMPORTANT TIP!</p> <p><i>If you change your mind, get lost, or otherwise panic, don't worry. Pressing any menu key (i.e. <AUDIO>, <CODEC>, <TEL>, or <SYSTEM>) will de-select the item currently selected, without saving the changes in progress.</i></p>
---	--

In the case of numeric or alphanumeric text fields, you can begin entering text as soon item has been selected with the <SEL> button. To erase previously entered text, use the <▲> button.

	<p>IMPORTANT TIP!</p> <p><i>Like many devices using telephone keypads, the Zephyr Xstream uses multiple presses of the various buttons of the keypad to enter all of the letters of the alphabet, as well as the digits 0 through 9. We will cover this in detail below.</i></p>
---	---

Let's go through a couple of quick examples to see the Zephyr Xstream menus in action.

Example 1: Selecting a setting from a list (i.e. the bit rate):

1. Press the <CODEC> button twice. You should see a screen that looks like the following:



2. Now press the <▼> button twice so the menu item "bitrate" is highlighted (i.e. is shown with white text on a black background) as shown below:



3. Press the <SEL> button once. Note that the menu item moves to the top of the screen and information about "Bitrate" is displayed.

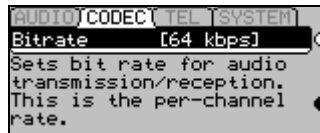

4. Press the <▼> button repeatedly to view the possible settings for this menu item (i.e. 56 or 64).

	<p>IMPORTANT TIP!</p> <p><i>You can press the <CODEC> button at any time to "escape" without saving the changes you have made.</i></p>
---	---

5. Press the <SEL> button to confirm your selection. Or, press <CODEC> to ignore the change.

Example 2: Entering a numeric entry (i.e. entering a SPID):

1. Press the <TEL> button twice. You should see a screen that looks like the following:

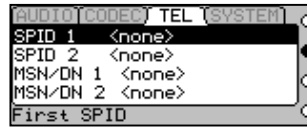

2. Verify that the menu item “SPID 1” is highlighted (i.e. is shown with white text on a black background). If not, use the <^> button to highlight this menu selection.
3. Press the <SEL> button once. Note that the menu item moves to the top of the screen and information about “SPID 1” is displayed.



4. Press the <^> button repeatedly to erase any existing information.
5. Type in the new SPID number using the Zephyr Xstream’s keypad.



IMPORTANT TIP!

You can press the <TEL> button at any time to “escape” without saving the changes you have made.

IF THIS UNIT HAS ALREADY BEEN PROGRAMMED YOU SHOULD PRESS <TEL> NOW!

6. Press <SEL> to confirm your entry. Or, press <TEL> to ignore the information and abort the entry process.

More on the Numeric Keypad – Entering Alphabetic Characters

A given keypad button corresponds to the number printed on it. It can also be used for text entry of the letters below it. Additional characters are available on the <*> key (i.e. * ([] <> <Space>) and the <#> key (i.e. # . , ; : ! ? <space>) and underscore is available on the <1> key.



To enter text characters, press the key with the appropriate letter printed near it. Keep tapping it to cycle through the possible choices. For example, tapping

the 2-key in a text field will first enter A. Repeated taps will change that to a B, then C, then the lower-case letters, then the number 2. Enter a space by pressing 1 three times. Punctuation characters appear on the * and # keys.

For example:

Press the number 2 once.....	See the character A
... press it again.....	See the character B
... press it again.....	See the character C
... press it again.....	See the character a
... press it again.....	See the character b
... press it again.....	See the character c
... press it again.....	See the numeral 2
... press it yet again.....	the cycle starts again from A

To move to the next character in a field, tap any other key or press the <▼> button. To back up, press the <▲> key.

Special Menus; DIAL, AUTO & DROP

The *DIAL* menu

The *DIAL* menu appears after the *Dial* button has been pressed and looks like the following:

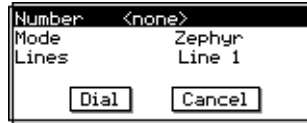

If you wish to dial a data call to another ISDN codec (*Mode* = Zephyr) you can simply enter the desired number and press <*DIAL*> again. A second call can be placed on "Line 2" by pressing <*DIAL*> a third time.

To drop all calls in progress, simply press <*DROP*> four times:

This sequence is illustrated here.

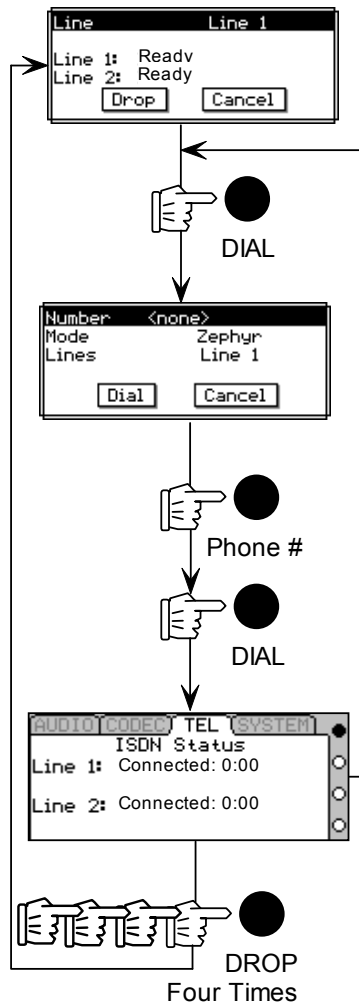



IMPORTANT TIP!

The *Number* field in the *DIAL* menu is different from other entry fields in the Zephyr Xstream. It is *NOT* necessary to press <SEL> before entering the number to be dialed.

While we like consistency, this field is used so often, it made sense to make it easier by doing this. It also makes operation more similar to the Zephyr classic.

If you wish to specify the *Line* to be used, or use a *mode* other than the default (i.e. other than Zephyr,) you can do so. After entering the number, press <SEL>, then use the <▲> or <▼> keys to move to the desired menu selection, and press <SEL> again to change the item. Repeat this process till all items are set as desired..

Once you have set the *Line* and *Mode* press <DIAL> to make the connection.

The available modes are:

- *Zephyr* - Places a "data" mode call at the rate indicated in the *CODEC* menu.
- *Phone* - Places a "voice" mode call according to the G.711 standard. This allows placing a call to any standard telephone line.
- *Xport* - Places a "voice" mode call according to the G.711 standard and loads Xstream's modem code into DSP to allow communication with a Zephyr Xport connected to a POTS (analog) line.

The *DROP* menu

The *Drop* menu is activated by pressing the <DROP> button once. It looks like this:

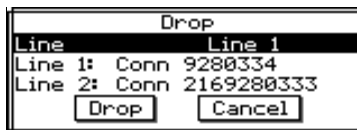

The system will default to *Line 1* if that line is in use. It will default to *Line 2* only if *Line 1* is not in use. Press <DROP> a second time to drop the line shown.

To drop a *Line* other than the line shown, press the <SEL> button, then press <▲> or <▼> to select the desired *Line(s)*. To drop the *Line(s)* press <DROP> again.

To easily clear both ISDN lines simply press <DROP> four times.

For connecting when in Ethernet/IP mode, see Appendix 6,

The *AUTO* menu

The *AUTO* menu is used to enter or activate *Dial Setups* and *Location Setups*.

Dial Setups

Dial Setups are very similar to the "Auto Dial Setups" used in the classic Zephyr. Each of the 100 dial setups consists of several pieces of information.

- A *Setup* number – this 2 digit number (00 to 99) can be used to instantly access a given setup.
- An alphanumeric *Name*
- *Number 1* (optional) – A telephone number to be dialed on “Line 1”
- A “mode” for number 1 – Either *Zephyr* for a codec call, *Xport* for a call to a Zephyr Xport using a POTS line, or *Phone* for calls to a standard telephone.
- *Number 2* (optional) – A telephone number to be dialed on “Line 2”
- A “mode” for number 2
- *Include* selection. This allows you to include *CODEC* menu settings (optional) – This is a snapshot of all settings of the *CODEC* menu. This allows the unit to automatically change to the settings used with a given site based on the *Dial Setup* used.

	<p>HOT TIP!</p> <p><i>If you are using one of the Xstream's V.35 interface modes (see Section 9) you can use Dial Setups without phone numbers to conveniently change modes.</i></p> <p><i>If a setup containing a phone number is activated while the Interface (in the third TEL menu) is set to V.35 Split, or V.35 single, the system will change the interface to ISDN so that the number(s) may be dialed.</i></p>
---	---

	<p>ZEPHYR CLASSIC VS XSTREAM COMPARISON</p> <p><i>The Zephyr Xstream's Dial Setups offer some important differences from the Zephyr's Auto Dial Setups:</i></p> <ol style="list-style-type: none"> 1. <i>Inclusion of codec information is optional with the Xstream, whereas it is mandatory with the Zephyr. Inclusion of codec information is the default.</i> 2. <i>Xstream allows independent setups for Line 1 and Line 2 to be used. Zephyr does not allow access to Auto Dials if any line is in use.</i> 3. <i>Zephyr only allows Auto Dial Setups to place data (i.e. Zephyr) calls while Zephyr Xstream's Mode settings allow Dial Setups to place calls to an Xport using "Xport" Mode or a regular telephone using the "Phone" Mode.</i>
---	---

HOT TIP!

You can use dial setups as a way to conveniently change your codec settings. Possibly to accommodate incoming calls from differing locations.

Simple leave the **Number 1** & **Number 2** field blank, and set **Include** to **Codec**. As always, be sure to set the **CODEC** menu items to the proper settings before creating your setup.



Activating a Dial Setup – Step by Step

Before beginning, verify the Zephyr Xstream is connected and ready for use. In most cases the line status should indicate *Ready & Ready* (with ETS 300 ISDN it is acceptable if *Deactivated & Deactivated* is displayed)

If necessary, activate the appropriate *Location Setup* for the location (if you have just arrived there) now (see below). Or you may need to manually configure *SPIDs, DNs/MSNs* and *Telco* information in the *Tel* menu (if no *Location Setup* exists for this location).

1. Press the <AUTO> key. The most recently used *Dial Setup* will be highlighted (white text on a black background). To activate this *Setup* Press <AUTO> again.
2. To choose a different *Dial Setup* you have two options:
 - Use the <^> and <v> to scroll through the list of 100 *Dial Setups*.
 - Or: Use the Keypad to enter the two-digit number (00 to 99) for the desired setup. That setup will be displayed and will be highlighted.
3. Once the desired setup is highlighted, press the <AUTO> button to activate the dial sequence.

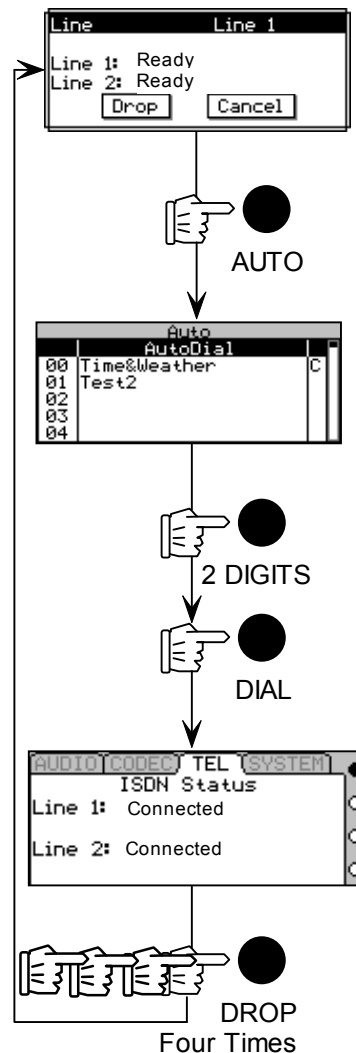

The illustration below shows several sample *Dial Setups*. Note that the notation "C" in the right column indicates that a particular setup includes *CODEC* menu settings.

Auto		
Dial Setups		
00	Time & Weather	
01	Remotel	C
02		
03		
04		

Creating Dial Setups – Step by step

1. Configure the Zephyr Xstream's *CODEC* menu as it will be used when connected to this location. This step is optional, you can skip this step if you are creating a *Dial Setup* that does not include codec settings



HOT TIP!

*You will probably wish to include the **CODEC** settings in your **Dial Setup**. This allows you to dial a variety of locations, each with differing codec requirements, without the need for manual configuration.*

2. (Optional) If you wish to include *CODEC* settings in your *Dial Setup*, you may wish to dial the location in question now, to verify that your codec settings are correct. If you choose to "include" the codec settings in step 8, the current codec setting will be stored with the new setup.
3. Press the <AUTO> key. Choose the *Dial Setup* to be entered. Note: You can edit an existing setup by selecting it.

To choose a *Dial Setup* you have two options:

- Use the <^> and <v> to scroll through the list of 100 *Dial Setups*.
- Or: Use the Keypad to enter the 2-digit number (00 to 99) for the desired setup. That setup will be displayed and will be highlighted.

Auto		
Dial Setups		
00	Time & Weather	
01	Remotel	C
02		
03		
04		

4. Once the desired setup is highlighted, press the <SEL> button to allow entry of (or editing of) the information for this setup. If an empty setup was selected, "Empty Entry" will be displayed.



5. Press <SEL> to continue or press <^> and then <SEL> to escape without changing.

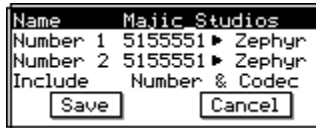

6. Enter a name (see the beginning of this chapter section for an example on how to select and enter information).
7. Enter one or two phone numbers, as required for transmit and receive modes to be used when communicating with this site.
8. For each phone number entered, select a call type. This would be *Zephyr* if calling an ISDN codec, *Phone* if placing a call to a telephone, or *Xport* if dialing a Zephyr Xport.
9. You can choose whether to *Include* Codec settings or not by selecting this menu selection. The choices are *Number* (no codec information included with this dial setup) or *Number & Codec*.

If *Number & Codec* is selected the system will include the current settings in the *CODEC* Menu with this setup. Each time this setup is activated, the system will reset the *CODEC* Menu items to these setting before dialing the number(s) for this setup.

10. Move the cursor to the word *Save* and then press <SEL> to complete the entry process.

HOT TIP!

You can use a Dial Setup to easily configure your Zephyr Xstream for inbound calls. To do so, just leave the **Number 1 & Number 2** fields empty and set **Include** to "Number & Codec".

When this dial setup is activated, the Xstream will change **CODEC** Menu settings to the settings present when this dial setup was created.



Editing Dial Setups

1. If this setup *includes* codec information, configure the Zephyr Xstream's *CODEC* menu as it will be used when connected to this location. If the existing codec information included with this setup is correct, simply activate the setup to recall those settings now (then drop the call (s) by pressing drop 4 times). If you are editing a *Dial Setup* that does not include codec settings you can skip this step.

2. Press the <AUTO> key. Choose the *Dial Setup* to be edited.

To choose a *Dial Setup* you have two options:

- Use the <^> and <v> to scroll through the list of 100 *Dial Setups*.
- Or: Use the Keypad to enter the 2-digit number (00 to 99) for the desired setup. That setup will be displayed and will be highlighted.

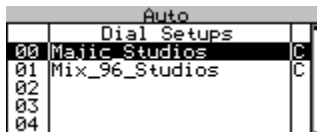

3. Once the desired setup is highlighted, press the <SEL> button. The name of the setup will be displayed.



4. Press <^> and then <SEL> to edit the setup.

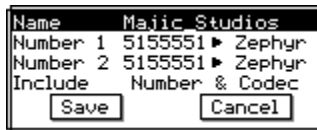

5. Edit the name, number 1 or 2, or call type 1 or 2 (see the beginning of this section for an example on how to select and enter information).
6. You can choose whether to *Include* Codec settings or not by choosing this menu selection. The choices are *Number* (no codec information included with this dial setup) or *Number & Codec*.

If *Number & Codec* is selected, the system will include the current settings in the *CODEC* Menu with this setup. Each time this setup is activated, the system will reset the *CODEC* Menu items to these setting before dialing the number(s) for this setup.

7. Move the black cursor to the word *Save* and then press <SEL> to complete the editing process.

Location Setups

Location setups are a useful feature that allows you to pre-configure information about the ISDN line (*TEL* menu information) and the mixer setup/assignment information (*AUDIO* menu and *MX/MXP* front panel information) for frequently visited locations. Each dial setup consists of several pieces of information:

- A Setup number – this three-digit number can be used to instantly access a given *location setup*.
- An alphanumeric *Name*
- *TEL* menu settings – This is a snapshot of all settings of the *TEL* menu.
- *AUDIO* settings (optional) – This is a snapshot of all settings of the *AUDIO* menu. Note, the front panel Left/Right and Snd/Rcv mixer assignments on the Zephyr Xstream MX/MXP model's front panel are included along with the settings in the *AUDIO* menu.

Activating a Location Setup – Step by Step

Note that this process is the same as accessing a Dial Setup, only a three-digit number is used.

1. Press the <AUTO> key.
2. To choose a *Location Setup* you have two options:
 - Use the <▲> and <▼> to scroll through the list of 30 *Location Setups*. These are setups # 100 to 129 - may need to press and hold <▼> to scroll past the *Dial Setups*.
 - Use the Keypad to enter the three-digit number for the desired setup. That setup will be displayed and will be highlighted.

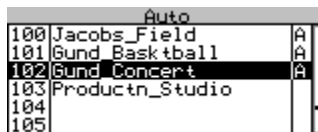

3. Once the desired setup is highlighted, press the <AUTO> button to activate the configuration sequence. Once configuration is complete, the Xstream will show the following screen:

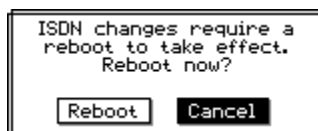

4. Press <^> then <SEL> to reboot.

The illustration below shows several sample *Location Setups*. Note that the notation "A" in the right column indicates that a particular setup includes *AUDIO* menu settings as well as *TEL* menu settings.

Auto		
100	Jacobs_Field	A
101	Gund_Basketball	A
102	Gund_Concert	A
103	Productn_Studio	
104		
105		

Creating Location Setups – Set by Step

1. Configure the Zephyr Xstream with the ISDN line to be used at this location (see below). You must make certain that the menu selections in the *TEL* and *AUDIO* (optional) menus are set correctly:
 - All menu settings in the *TEL* menu. Ideally, you should be connected to the line for the target location, so you can verify the ISDN settings are correct. In that case, the line status should indicate *Ready & Ready* (with ETS 300 ISDN it is acceptable if *Deactivated & Deactivated* is displayed). If you are not connected to the line that's ok too, but you should be certain that the menu selections in the *TEL* menu are set correctly. NOTE: *TEL* menu settings are always included in a *Location Setup*.



HOT TIP!

*You can activate an existing setup to recall these parameters, assuming you have an existing setup for the line in question. Do this first, and then make the necessary changes to the **AUDIO** menu settings. Then create your new **LOCATION** setup as described below.*

- If you wish to include *AUDIO* settings in this Location Setup (optional):
 - All menu settings in the *AUDIO* menu.
 - And: Front panel Main mixer A/B buss assignments (MX/MXP only)
 - And: Front panel *Snd/Rcv* settings for Local Mix 1 & 2 (MX/MXP only)

2. Press the <AUTO> key. Choose the *Location Setup* to be entered. Note: You can edit an existing setup by selecting it.

To choose a *Location Setup* you have two options:

- Press and hold the <▼> to scroll to the list of 30 *Location Setups* (these are setups # 100 to 130).
- Use the Keypad to enter the three-digit number for the desired setup. That setup will be displayed and will be highlighted.

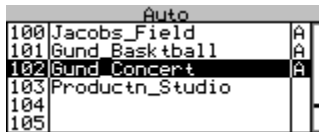

3. Once the desired setup is highlighted, press the <SEL> button to allow entry of (or editing of) the information for this setup. If an empty setup was selected, "Unused Entry" will be displayed (see below):



4. Press <SEL> to continue to the screen shown below:
or press <^> and then <SEL> to escape without changing.

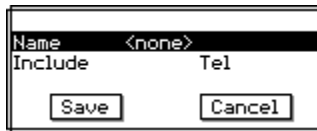

5. Enter a name (see the beginning of this chapter section for an example on how to select and enter information).

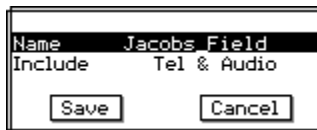

6. You can choose whether to *Include* Audio settings or not, by selecting this menu selection. The choices are *Tel* (no *Audio* menu information included with this *Location* setup) or *Tel. & Audio*.

If *Tel* is selected the system will include the current settings in the *TEL* Menu with this setup. Each time this setup is activated, the system will reset the *TEL* Menu items to these setting before dialing the number(s) for this setup. If *Tel. & Codec* was selected the *AUDIO* settings will also be changed when this setup is activated.

6. Move the cursor to the word *Save* and then press <SEL> to complete the entry process.

Editing Location Setups

1. If this setup *includes* audio information, configure the Zephyr Xstream's *AUDIO* menu and front panel mixer assignments as it will be used when connected to this location. If the existing Audio information included in this setup is correct, simply activate the setup to recall those settings now (then drop the call (s) by pressing drop 4 times). If you are creating a *Dial Setup* that does not include audio settings, you can skip this step.
2. Configure the Zephyr Xstream with the information ISDN line to be used at this location (see below). You must make certain that the menu selections in the *TEL* and *AUDIO* (optional) menus are set correctly
3. Press the <AUTO> key. Choose the *Location Setup* to be edited.

To choose a *Location Setup* you have two options:

- Press and hold the <▼> to scroll to the list of 30 *Location Setups* (these are setups # 100 to 130).
- Use the Keypad to enter the three-digit number for the desired setup. That setup will be displayed and will be highlighted.

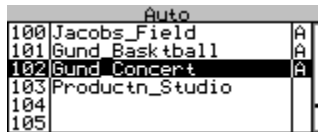

4. Once the desired setup is highlighted, press the <SEL> button. The name of the setup will be displayed. Press <▲> and then <SEL> to edit the setup.

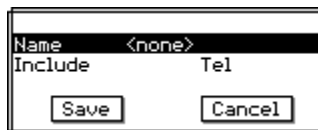

5. Edit the name (see the beginning of this chapter section for an example on how to select and enter information).

You can choose whether to *Include* Audio settings or not, by selecting this menu selection. The choices are *Tel* (no *Audio* menu information included with this Location setup) or *Tel. & Audio*.

6. Move the cursor to the word *Save* and then press <SEL> to complete the editing process.

4.3 Codec Settings: Transmit, Receive, Bit Rate, & Sample Rate

When calling another ISDN codec (e.g. mode = Zephyr), these settings must be set correctly to achieve an end-to-end bi-directional audio connection. Since this is just an introduction, we will just briefly tell you what each is. For more information, see Section 11 (detailed Menu Reference). Section 6 (Audio Coding Reference) covers the different transmission modes in detail, including the advantages and disadvantages of each.

NOTE: When placing a call to a telephone (mode = Phone), or to a Zephyr Xport that is on a POTS line (mode = Xport) this settings can be ignored.

Transmit

This determines the format of the audio locally coded for transmission. In order for the far end to receive this audio, the far end codec must:

- 1) Support this transmission mode; and
- 2) Must have its "Receive" (or "decoder") mode set appropriately to receive the mode being sent.
- 3) The bit rate and sample rate settings must be matched between the two ends.

	<p>COMPATIBILITY TIP!</p> <p><i>The AAC and AAC-LD standards are new, and are not supported by older codecs. When communicating with older equipment, you must make some other choice.</i></p> <p><i>The G.722 transmit mode is the most widely supported standard. The majority of codecs support this mode. Since it has the lowest delay, it is frequently used for return feeds and IFB.</i></p>
---	---

Receive

This instructs your Zephyr Xstream to decode a particular mode being transmitted from the far-end codec.

The easiest option here is to set *Receive* to the "Auto" setting. This mode will attempt to determine the mode being sent from the far end, and internally set the Receive mode to match. All you'll need to do is be sure your *Sample Rate* (see below) is matched to the far end. The mode selected will then be displayed on the default menu and the codec status screen so you can note it for future reference.

As the auto mode takes several seconds to determine the correct mode, there are times you may wish to use a specific setting for *Receive*. In this case, your *Receive* mode must be set to decode the stream being sent from the far end.

If you choose not to use the "Auto" setting, you will need to know the Transmit ("Xmt" or "Encoder") mode of the far end to determine the correct setting.

	<p>HOT TIP!</p> <p><i>You can determine the correct setting for the Receive mode by first using the Auto mode. Once the Xstream gets a receive lock simply press the <CODEC> button and check what Receive mode was found. Then press <CODEC> again and change the Receive selection to this option.</i></p>
---	---

For a detailed explanation of the options for this menu item, see Section 5 (Guided Tour of the Menus). Section 6 (Audio Coding Reference) provides additional information about the features and advantages of each the different transmission schemes.

	<p>IMPORTANT TIP!</p> <p><i>It is important to understand that the Transmit and Receive settings on two connected units may very well NOT match. This is because there are frequently times when it is appropriate to use a different coding mode coming versus going.</i></p> <p><i>The important thing to remember is that the <u>local</u> Transmit mode must be compatible with the Receive settings and capabilities of the <u>far end</u> unit.</i></p> <p><i>Whereas the <u>local</u> Receive mode must be compatible with the Transmit settings of the <u>far end</u> unit.</i></p>
--	--

	<p>COMPATIBILITY TIP!</p> <p><i>Some brands of codecs have proprietary protocols implemented. These codecs require that they be placed in "Independent mode" or bi-directional communication with ISO/MPEG compliant codecs is not possible.</i></p>
---	---

Bit Rate

This setting determines the per-channel bit rate used for digital audio transmission. This setting sets up the codec section and tells the ISDN interface what rate call to place the call over the network.

This parameter must be matched between the Zephyr and the far end codec(s).

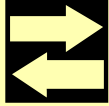

COMPATIBILITY TIP!

The Zephyr Xstream specifies the bit rate per channel. Since certain modes (i.e. stereo or mono-128) require two channels to operate, the total (aggregate) bit rate would be double the number displayed in these cases.

This is important as some other brands of codecs specify the total bit rate.

Since the network must accommodate the rate selected, it is important to hang up (i.e. drop the call) and redial if this parameter is changed during a call.



ISDN TIP!

Since this parameter specifies the bit rate placed over the dial up data network, it is important to understand the following: In some areas of the USA & Canada, only 56kbps or 64kbps service may be available. In addition, since different network paths (trunk groups) are sometimes used for the two rates, there are times where one rate may provide more reliable connections than the other.

In our experience, the only sure way to know if a connections at a given between to particular points will work, is to try it. First at 64kbps, and then at 56kbps, if the higher rate fails.



HOT TIP!

Since the network has to know the bit rate for a given call, this information is available to the Xstream on incoming calls. Therefore, the Xstream will switch to the rate of the incoming call.

*There is one exception however. If the Xstream already has a call in progress at a given rate, and a second call comes in (i.e. from a third codec) the unit will accept the call, but will not change rate (since that would cause a loss of audio from the original site). There will be no lock or audio from the site associated with the second call. In this case, the second remote site should drop the call, change rates to match, and redial - All three units must be at the same **Bit Rate** for this to work.*

Sample Rate

This is the digital sample rate used for transmission/reception by the codec section. Note that this rate may or may not be the same as the AES/EBU sample rate used on the input or output. See Section 11 (Detailed Menu Reference) for information on using the AES/EBU ports. The sample rate must be matched between your Zephyr Xstream and the codec at the far end for successful audio transmission.

If the sample rate is not matched, you will have no lock, intermittent lock loss, or audio that sounds pitch shifted.

	<p>IMPORTANT TIPS!</p> <ol style="list-style-type: none"> 1) <i>Zephyr Xstream only supports the 24kHz sample rate in MPEG Layer-2. Therefore, the Sample Rate menu does not have this option. The “L2 Half 64” Transmit and Receive modes are used to achieve 24kHz operation in MPEG Layer-2.</i> 2) <i>The G.722 standard calls for a Sample Rate of 16kHz. This rate is used for G.722 regardless of the Sample Rate setting.</i>
---	---

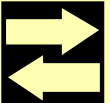
	<p>COMPATIBILITY TIP!</p> <p><i>Not all codecs support all sample rates. 32kHz is most commonly supported in MPEG Layer-3 whereas 48kHz is more commonly used in Layer-2.</i></p> <p><i>24kHz is sometimes seen in Layer-2. In this case set your Transmit or Receive to “L2 Half/24” and this Sample Rate will be used (regardless of the Sample Rate setting).</i></p> <p><i>16kHz is used with G.722 and is automatically employed whenever G.722 is used.</i></p>
---	--

	<p>ZEPHYR CLASSIC VS XSTREAM COMPARISON!</p> <p><i>Note: Not all Zephyrs support MPEG Layer-2. Very early units support MPEG Layer-3 and G.722 only.</i></p> <p><i>The Zephyr and Zephyr Express do not support MPEG Layer-2 at the 32kHz Sample Rate. When communicating with a Zephyr or Zephyr Express in Layer-2, the 48 kHz sample rate should be used.</i></p>
---	--

5 GUIDED TOUR of the MENUS

5.1 The Menu Tree

This section gives an overview of the Xstream's front panel menu suitable for the average operator. Section 11 is a detailed reference of the menus. We assume you have already read Section 4 (Basic Operation), which introduces the system and its basic operation.

Note that most of the functions described in this section are also available in the HTTP configuration pages that you may access using your favorite web browser. Of course, you will have to give your Xstream a suitable IP address before you can access it in that manner. Where applicable, the web pages have been included in this section for your reference. Many settings are duplicated on the front panel and the web pages for maximum flexibility.

First, let's lay out for you the Xstream's home page and the front panel menu we'll be discussing. The next few pages show each of the menus in detail. Note that we show the *AUDIO* menus twice, once for the Xstream, and again for the Xstream MX/MXP models. Web pages will also be shown to illustrate where you can find these settings in the web interface.

Telos Zephyr Xstream	
<u>Status</u>	current operation of the codec and network interface including dial and drop functions
<u>System</u>	loopback testing, ancillary data, contact closures
<u>Tel</u>	SPIDs, DNs, switch type, auto-answer, dialing prefix, network interface, streaming ports
<u>Codec</u>	codec modes, bitrate, sample rate, compatibility, streaming buffer, WAN IP, hostname
<u>Audio</u>	input/output levels, gain trim, send mix, input source (MX); per-channel gain, gain, processing, low cut, per-monitor bal, mix, pan
<u>Auto</u>	dial and location setups create, modify, or recall setups
<u>Configure Livewire</u>	Configure Livewire sources and destinations: names, channel numbers, format
<u>Livewire Meters</u>	Monitor Livewire audio levels. Input gain control.
<u>Administration</u>	IP network address, NTP server Software update and maintenance
<u>Quality of Service Settings</u>	Livewire Clock Mastership settings 802.1p priority and VLAN tagging, DSCP Class of Service

Zephyr Xstream Home Page

MENUS - The CODEC, TEL & SYSTEM Menus (all versions)

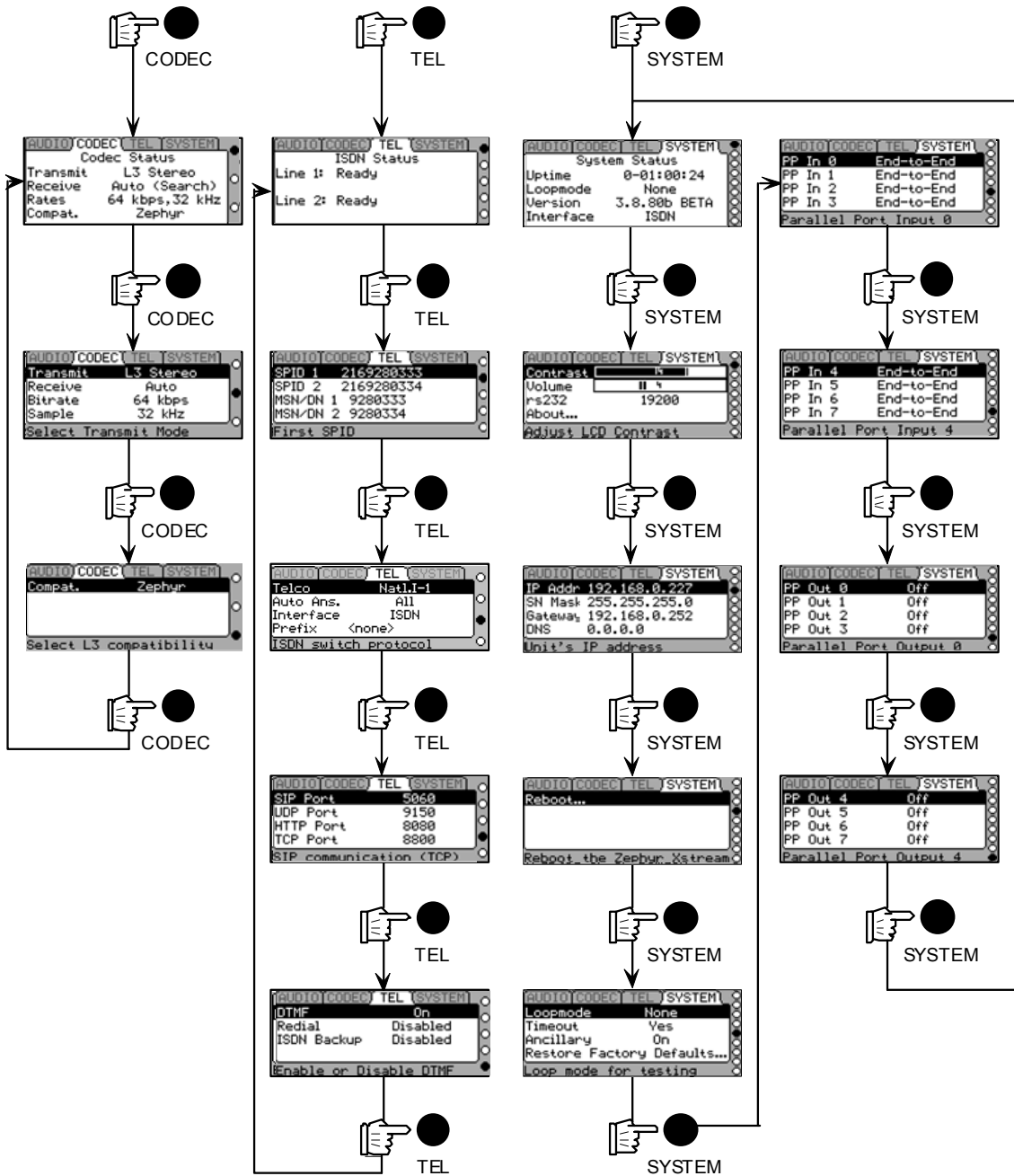

MENUS - The DIAL & AUTO Menu (all versions)

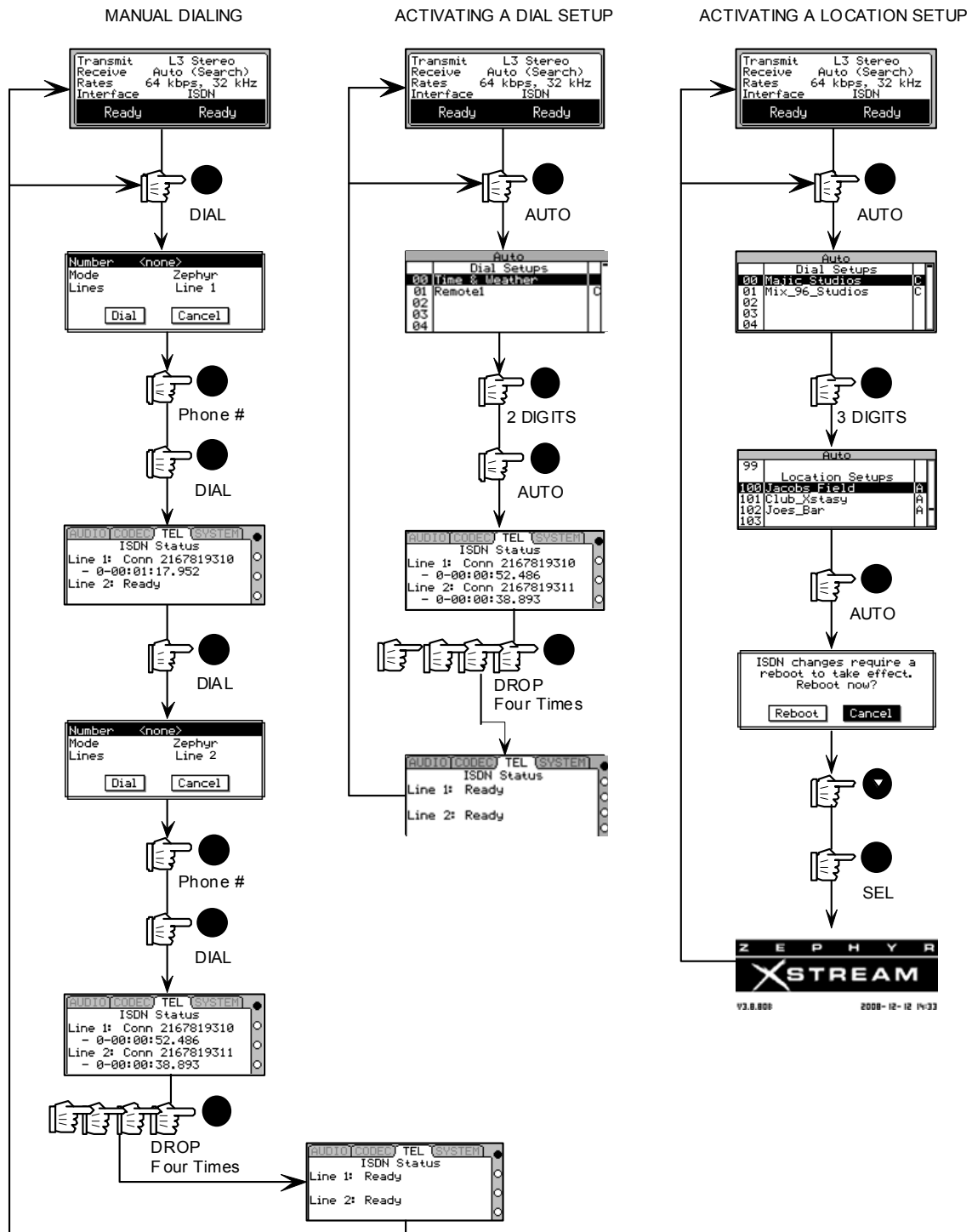

MENUS - The Audio Menu (non-mixer version)

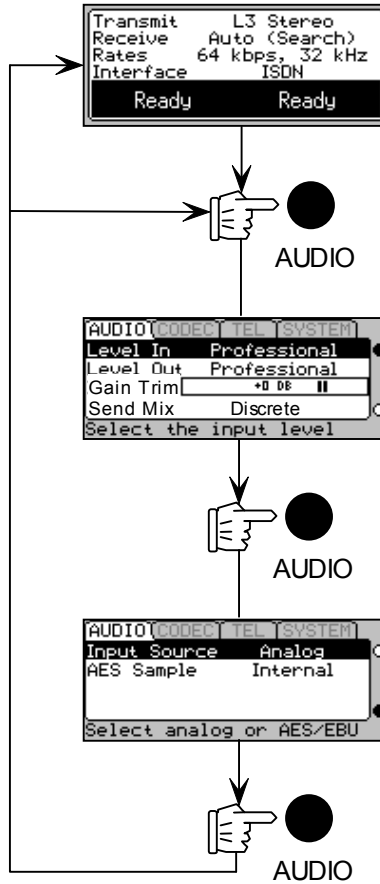

MENUS - The Audio Menu MX/MXP (mixer versions)

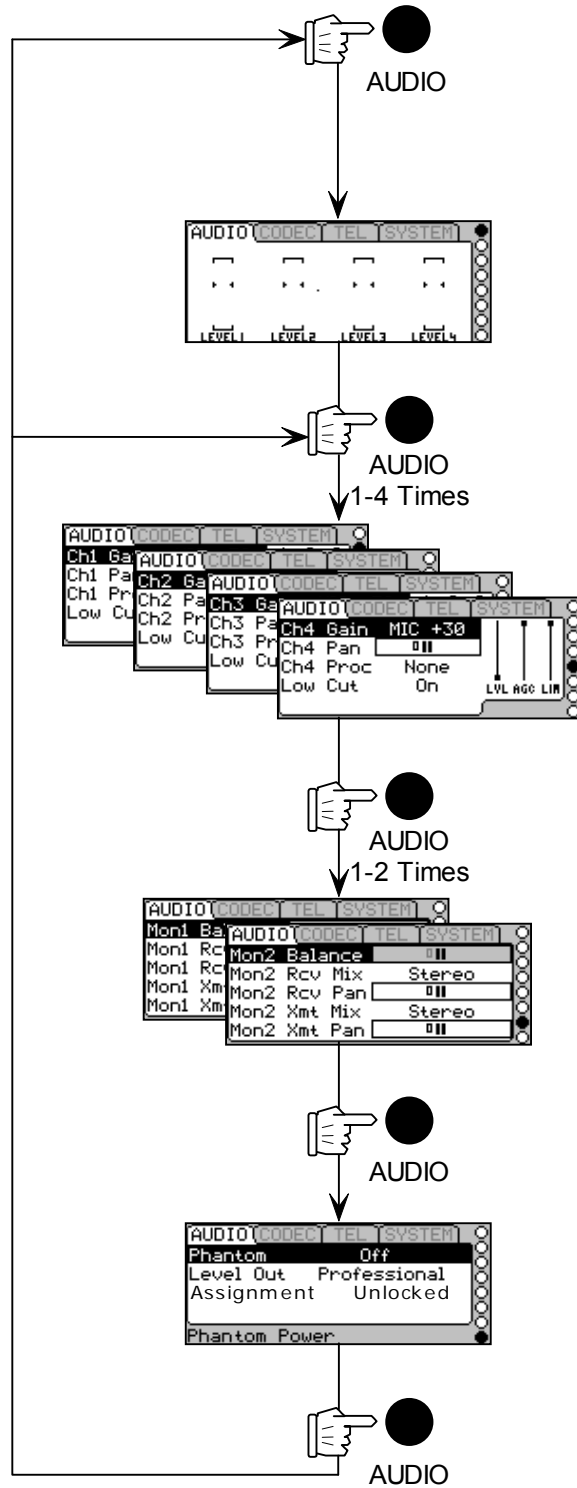

5.2 The Default Screen

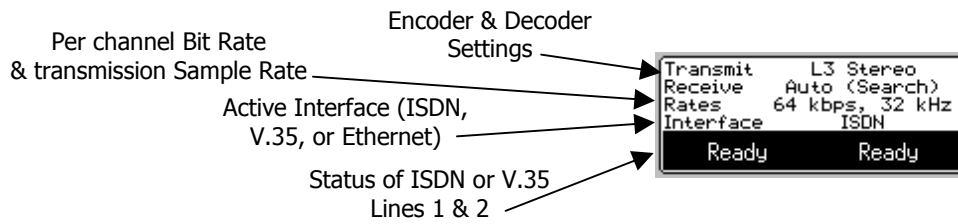

The default display (shown above) will appear after the system has been left idle for 120 seconds (unless defeated). It gives summary information on system status. At the bottom, in inverse test is the status of each ISDN "line" or V.35 port.

IMPORTANT TIP!

*You can defeat the timeout function that causes the default screen to appear if you wish. You may want to do this so you can monitor some other status screen (such as the **AUDIO** Status screen on the MX/MXP models).*

*To disable this screen, go to the 5th **SYSTEM** menu and set the **Timeout** option to "No".*

5.3 The Audio Menu

5.3.1 The Zephyr Xstream's Audio Menu (non-mixer version)



AUDIO - Screen 1

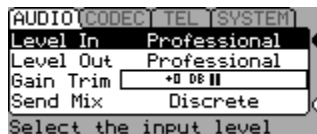

Pressing the **AUDIO** button once will show the first **AUDIO** menu, with the following selections.

Level In

This determines the nominal input level for the Xstream's analog inputs. As shipped from the factory, *Professional* sets the system to a +4 dBu nominal input level. However, this can be changed to 0dBu by changing internal jumpers. See Section 3 and Section 13 for information on changing these jumpers.

Level Out

This determines the operating level at the Output (Receive from Network) jacks. *Professional* sets the system to a +4 dBu nominal input level. *Consumer* sets the operating level to -11dBu (nominal). Lower operating levels can be accommodated using an external pad.

Gain Trim

This allows a fine adjustment of send level. This adjustment allows compatibility with a variety of equipment. This adjustment is in the digital domain and adjusts both the analog and AES/EBU send level.

AUDIO - Screen 2

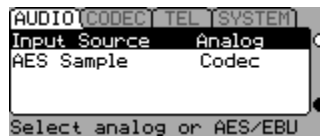

Pressing the *AUDO* Button a third time will show this screen with the following options.

Input Source

This allows selection of either the *Analog*, *AES/EBU* or *Livewire* input for your Send to Network Audio.

AES Sample

This option determines what source is used to clock the AES/EBU output. The *Input* selection clocks the AES/EBU output to the AES/EBU signal fed to the rear-panel AES/EBU input and is the most commonly used option. The *Sync* selection clocks the AES/EBU output to the AES/EBU signal fed to the rear-panel Sync-in jack. See Section 11. (Detailed Menu Reference)

5.3.2 Zephyr Xstream's MX & MXP's *Audio* Menu

Don't forget that you can create *Location Setups* to easily recall the menu selections of the *AUDIO* menus. Even if the ISDN line is the same, these *Location Setups* can be used to program these parameters (i.e. for different shows or uses in a dedicated situation. In the cases where the ISND settings have not changed, just choose *CANCEL* when requested to reboot.

AUDIO - Screen 1 (Status)

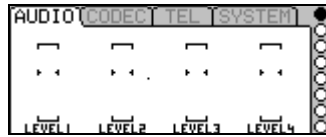

The first *AUDIO* menu has the individual levels for each of the Main Mixer inputs. These levels are post fader and therefore can be used to view relative levels of each source in the final mix.

AUDIO - Screens 2 - 5

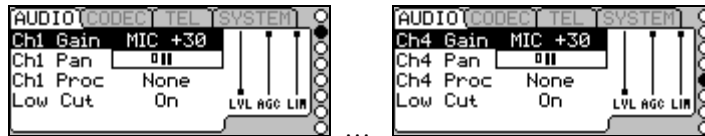

The second, third, fourth and fifth *AUDIO* menus allow adjustments of parameters for Main Mixer inputs 1-4, respectively. These screens are identical and have the following information:

Ch "x" Gain

This menu selection allows you to select from four different gain settings (2 mic. and 2 line) for Main Mixer input x. The options for this setting are:

MIC +44 : -55 dBu nom.

MIC +30: -40 dBu nom.

Line Con: -10 dBu nom.

Line Pro: +4 dBu nom.

The nominal values given above assume the fader is mid-position and the AGC/Limiter (processor) is off

Ch "x" Pan

This menu selection is a "panorama" adjustment that allows you to vary the amount of audio sent to the Left and Right codec inputs. Note that this adjustment has no effect unless the input x has been assigned to both A and B using the front panel control.

Ch "x" Proc

This menu selection allows you to enable the built in AGC/Limiter Main Mixer input x. You will be able to see the level for input "x" as well as the AGC and Limiter working by looking at the small bar-graphs and gate indicator to the right side of this screen. The built in Omnia processor is sophisticated and offers the following options:

None:

This disables the input processor for channel "x".

Voice L:

(Voice Low) This is the least aggressive setting, intended to protect against minor level problems when running a live show. It provides AGC with no limiting. Ideally where you want the most natural sound in live situations where mixing could be difficult.

Voice M:

(Voice Medium) This is a moderate setting. It combines AGC with a small amount of limiting. This provides good dynamics control, and also serves to "beef up" the voice. This setting is the most frequently used general purpose option. Do not use this setting for music.

Voice H:

(Voice High) This is an aggressive setting employing both AGC and limiting. This setting is perfect for easily excited talent such as sportscasters. Do not use this setting for music.

Music:

This setting offers a slow AGC only.

Low Cut

This is a low cut filter designed to reduce wind noise, pops and breath noise. This can be enabled independently for each input.

AUDIO - Screens 6 & 7

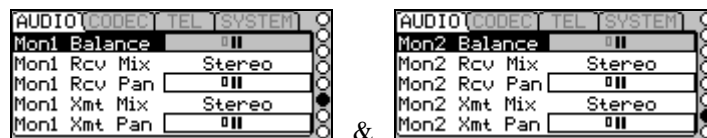

These screens are used to set up Local Mix 1 (screen 6) and Local Mix 2 (screen 7). The following options allow the operator to customize the Local Mixes as required for different applications as needed to accommodate talents' needs. The following selections are displayed are offered.

Mon "x" Balance

This adjustment allows you to vary the ratio of Send to Receive audio in Local Mix x. This control has no effect if both *SND* and *RCV* have not been selected on the front panel.

Mon "x" Rcv Mix

This parameter, in combination with *Mon x Rcv Pan* selection (see below) is useful for when only a single return channel is being sent from the far end. The default is stereo. The options are:

Stereo:

This choice routes the incoming (far end) audio to the headphones as received. The A channel audio appears on the Left side of the Local Mix and the B channel audio appears in the Right side of the Local Mix.

Left:

This option routes the incoming channel A (Left) audio to both sides of the Local Mix.

Right:

This option routes the incoming channel B (Right) audio to both sides of the Local Mix.

Left +Right:

This option sums (i.e. mixes) the incoming A & B audio channels and routes this to both sides of the Local Mix.

Particularly useful when the both a mix minus and a producer IFB (interruptible foldback) are being recieved as it allows both feeds to be heard in both ears.

Mon "x" Rcv Pan

Whenever *Rcv* is selected using the front panel button, this control determines the ratio of the amount of the audio fed to the A (Left) and B (Right) channels of the Local Mix.

Mon "x" Xmt Mix

This option operates in the same way as *Mon "x" Rcv*, only the send audio is used. This is particularly useful when creating two separate mono mixes to be sent to two far end locations as it can allow the talent to hear the correct return mix in both ears. The options are:

Stereo:

This choice routes the outgoing (near end) audio to the headphones just as transmitted by the codec section. The A channel audio appears on the Left side of the Local Mix and the B channel audio appears in the Right side of the Local Mix.

Left:

This option routes the outgoing channel A (Left) audio to both sides of the Local Mix.

Right:

This option routes the outgoing channel B (Right) audio to both sides of the Local Mix.

Left +Right:

This option sums (i.e. mixes) the incoming A & B audio channels and routes this to both sides of the Local Mix.

Mon "x" Xmt Pan

Whenever *Xmt* is selected using the front panel button, this control determines the ratio of the amount of the audio fed to the A (Left) and B (Right) channels of the Local Mix.

AUDIO - Menu 8



This menu has three options:

Phantom

This option allows you to disable (*Off*) or enable (*On*) phantom power for inputs 1 & 2. Phantom power is the full 48 volts and is fed to both inputs 1 & 2.

Level Out

This option sets the nominal output level for the line outputs for Monitor Mix 2. The options are "*Professional*" (+4 dBu nominal) or "*Consumer*" (-10 dBu nominal).

Assignment

This setting this to *Locked* locks the input assignments (A/B select) and monitor assignments (Send/Receive select) to their current settings.

Livewire

Since Livewire is one way of getting audio to and from your Xstream, we will show those menus here as well. Please refer to Section 8 for details on configuration of Livewire.

These menus enable you to specify the Livewire streams being created by the codec (“sources” delivered to the Livewire network) and the audio streams being delivered by the codec (“destinations” from the Livewire network). Expert mode enables you to specify custom backfeeds if required.

Please see Section 8 for details on Livewire configuration.

Hybrid Channels

#	Name:	Channel:	Source Mode:
1	<input type="text" value="ZXS2 SRC 1"/>	<input type="text" value="100"/>	<input type="button" value="Livestream"/>
2	<input type="text" value="ZXS2 SRC 2"/>	<input type="text" value="101"/>	<input type="button" value="Livestream"/>

Entering a channel number configures both:
 Livewire Source and Destination for the hybrid.
 Destinations will be configured 'To source'.

To configure Livewire Sources and Destinations separately, use [Expert Mode](#)

Livewire – Basic Setup

-- Expert Livewire configuration mode --

Livewire Sources			Livewire Destinations		
#	Name:	Channel:	Mode:	Channel:	Mode:
1	<input type="text" value="ZXS2 SRC 1"/>	<input type="text" value="100"/>	<input type="button" value="Livestream"/>	<input type="text" value="100"/>	<input type="button" value="To source"/>
2	<input type="text" value="ZXS2 SRC 2"/>	<input type="text" value="101"/>	<input type="button" value="Livestream"/>	<input type="text" value="101"/>	<input type="button" value="To source"/>

Livewire – Expert Setup

5.4 The *Codec* Menu

The settings of the codec menu will determine what codecs with which you can communicate, as well as the quality and delay of the coded audio stream. For more on these selections see Section 6 (Audio Coding Reference) and Section 10 (Applications Guide).

Note that the menus shown here are applicable when the *Interface* setting in the *TEL* Menu is set to *ISDN* or *V.35 split*. If *V.35 single* or *Ethernet* is selected for *Interface*, the *CODEC* menus will be slightly different. See Appendix 6 (Special Operational Modes) for more details.

CODEC - Screen 1 (Status)



The first press of the <CODEC> button shows a screen with a summary of the codec settings (see below)

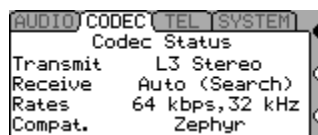

CODEC - Screen 2



A second press of the <CODEC> button shows the screen above:

On this screen are the settings that affect compatibility with far-end codecs. These parameters also affect the quality (and delay) of the audio transmitted.

Transmit

This determines the format of the audio locally coded for transmission. In order for the far end to receive this audio, the far end codec must:

- 1) Support this mode; and
- 2) Must have its Receive (or decoder) mode set appropriately to receive the mode being sent.
- 3) The bit rate and sample rate settings must be matched between the two ends.

	<p>IMPORTANT TIP!</p> <p>When referring to Transmit modes we use the Term "Mono 64" to refer to a mono signal using a single B channel. Therefore, the audio stream may be at 56 or 64kbps since the call could be placed at either rate.</p> <p>Similarly, we use the term "Mono 128" to refer to a mono signal using the bandwidth from both B channels. Therefore, the audio stream would be at either 112 or 128kbps.</p>
---	---

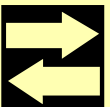
	<p>COMPATIBILITY TIP!</p> <p>The AAC and AAC-LD standards are new, and are not supported by older codecs. When communicating with older equipment, you must make some other choice.</p> <p>The G.722 transmit mode is the most widely supported standard. The majority of codecs support this mode. Since it has the lowest delay, it is frequently used for return feeds and IFB.</p>
---	---

Receive

This instructs your Zephyr Xstream to decode a particular mode being transmitted from the far-end codec.

The easiest option here is to set *Receive* to the "Auto" setting. This mode will attempt to determine the mode being sent from the far end and internally set the Receive mode to match.

As the auto mode takes several seconds to determine the correct mode, generally, we recommend that you use a specific setting for *Receive*. In this case, your receive mode must be set to decode the stream being sent from the far end. You will need to know the Transmit ("Xmt" or "Encoder") mode of the far end to set this correctly.

For a detailed explanation of the options for this menu item, see Section 6 (Audio Coding Reference) and Section 11 (Detailed Menu Reference).

	<p>IMPORTANT TIP!</p> <p>When referring to Receive modes we use the Term "64" to refer to any incoming bit stream using only a single B channel. The actual audio stream may be at 56 or 64kbps since the call could be placed at either rate. Note that in nearly all cases a 56 or 64kbps signal will be mono.</p> <p>Similarly, we use the Term "128" to refer to any signal using the bandwidth from both B channels. Therefore, the audio stream would be at either 112 or 128kbps.</p> <p>The only exception is the G.722 and L3 Dual/Mono modes. These modes can receive one or two L3 "Mono 64" data streams. When one of these modes is used, you may have 2 sites connected simultaneously and independently to your Xstream.</p>
---	---



IMPORTANT TIP!

*It is important to understand that the **Transmit** and **Receive** settings on two connected units may very well **NOT** match. This is because there are frequently times when it is appropriate to use a different coding mode coming versus going.*

*The important thing to remember is that the local **Transmit** mode must be compatible with the **Receive** settings and capabilities of the far end unit.*

*Whereas the local **Receive** mode must be compatible with the **Transmit** settings of the far end unit.*

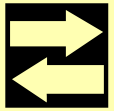

COMPATIBILITY TIP!

Some brands of codecs have proprietary protocols implemented. These codecs require that they be placed in "Independent mode" or bi-directional communication with standard ISO/MPEG codecs is not possible.

Bit Rate

This setting determines the per-channel bit rate used for digital audio transmission. This setting sets up the codec section as well as telling the ISDN interface what rate call to place the call over the network.

When the *Network* setting in the *TEL* menu is set to "Single V.35" or one of the Ethernet modes this parameter indicates the total bit rate.

This parameter must be matched between the Zephyr Xstream and the far end codec.

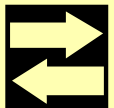



COMPATIBILITY TIP!

The Zephyr Xstream specifies the bit rate per ISDN or V.35/X.21 channel. Since certain modes (i.e. stereo or mono-128) require two channels to operate, the total (aggregate) bit rate would be double the number displayed in these cases.

This is important as some other brands of codecs specify the total bit rate.

Since the network must accommodate the rate selected, it is important to hang up (i.e. drop the call) and redial if this parameter is changed during a call.

	<p>ISDN TIP!</p> <p><i>Since this parameter specifies the bit rate placed over the dial up data network, it is important to understand the following: In some areas of the USA & Canada, only 56kbps or 64kbps service may be available. In addition, since different network paths (trunk groups) are sometimes used for the two rates, there are times where one rate may provide more reliable connections than the other.</i></p> <p><i>In our experience, the only sure way to know if a connections at a given between to particular points will work, is to try it. First at 64kbps, and then at 56kbps, if the higher rate fails (or is unreliable).</i></p>
---	---

	<p>HOT TIP!</p> <p><i>Since the network has to know the bit rate for a given call, this information is available to the Xstream on incoming calls. Therefore, the Xstream will switch to the bit rate of the incoming call.</i></p> <p><i>There is one exception, however. If the Xstream already has a call in progress at a given rate, and a second call comes in (i.e. from a third codec) the unit will accept the call, but will not change rate (since that would cause a loss of audio to/from the original site). There will be no lock or audio from the site associated with the second call. In this case, the second site should drop the call, change rates to match, and redial.</i></p>
---	--

Sample Rate

This is the digital sample rate used for transmission/reception by the codec section. Note that this rate may not match the AES/EBU sample rate used on the input or output. The sample rate must be matched between your Zephyr Xstream and the codec at the far end for successful audio transmission. If the sample rate is not matched, you will have no lock, intermittent lock loss, or audio that sounds pitch shifted.

	<p>IMPORTANT TIP!</p> <p>1) <i>Zephyr Xstream only supports the 24kHz sample rate in MPEG Layer-2 (or when used in “IP streaming mode” -See Appendix 6 - Special Operational Modes for more on that mode of operation).</i></p> <p><i>Therefore, the Sample Rate menu does not have this option. The “L2 Half 64” Transmit and Receive modes are used to achieve 24kHz operation in MPEG Layer-2.</i></p> <p>2) <i>The G.722 standard calls for a Sample Rate of 16kHz. This rate is used with G.722 regardless of the actual sample rate setting.</i></p>
---	---

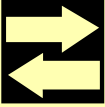
	<p>COMPATIBILITY TIP!</p> <p><i>Not all codecs support all sample rates. 32kHz is most commonly supported in MPEG Layer-3, whereas 48kHz is more commonly used in Layer-2.</i></p> <p><i>24kHz is sometimes seen in Layer-2. In this case, set your Transmit or Receive to “L2 Half/24” and this Sample Rate will be used (regardless of the Sample Rate setting) 16kHz is used with G.722 and is automatically employed whenever G.722 is used.</i></p>
---	---

	<p>ZEPHYR CLASSIC VS XSTREAM COMPARISON!</p> <p><i>Note: Not all Zephyrs support MPEG Layer-2. Very early units support MPEG Layer-3 and G.722 only.</i></p> <p><i>The Zephyr and Zephyr Express do not support MPEG Layer-2 at the 32kHz Sample Rate. When communicating with a Zephyr or Zephyr Express in Layer-2, the 48 kHz sample rate should be used.</i></p>
---	--

CODEC - Screen 3



A third press of the <CODEC> button shows the screen above.

The Compatibility option on this screen changes the format of the data used to transmit Layer 3 over ISDN for compatibility with some third-party codecs. You should leave this setting at Zephyr unless you are experiencing this particular incompatibility.

5.5 The Tel Menu

TEL - Screen 1 (Status)



The first press of the *TEL* button will show the *Tel Status* screen. This gives the current status of each of your ISDN B channels ("lines" 1 & 2). The most commonly seen status words are the following (See Section 10 for additional information):

Ready – This indicates that this B channel has correctly initialized with the Telco and is able to make and receive calls. The line is "idle".

ISDN TIP!

*A false ready may be displayed if your **Telco** setting is incorrect (see below), or if SPIDs are not entered when required.*

If your ISDN circuit uses the National ISDN or DMS-Custom ISDN protocol, you must enter Directory Numbers. An absent, or incorrect, Directory Number can prevent your Xstream from receiving calls, despite being in the Ready state.



Connected – The line is currently dialed up to another unit. The number it is connected to (if available), and the duration of the connection will be displayed.

SPID Pending – This may be displayed if an external NT1 has not completed initializing to the line. Or, it may indicate that the internal NT1 has recognized the line and is initializing to the rest of the Xstream (i.e. slowly blinking NT1 LED). Finally, we have seen this when the ISDN circuit is grossly misconfigured.

SPID Error – This indicates that the SPID for this number (located in the 2nd TEL menu) is incorrect. SPIDs are only needed with certain ISDN protocols used in the USA & Canada. SPIDs are not needed for ETS-300 (Euro ISDN), INS 64 (Japanese ISDN) or AT&T Custom Point to Point.

Inactive – This indicates that internal NT1 is not active nor is there an active S interface. This may mean that the ISDN line is not connected or is faulty. NOTE that Euro ISDN (ETS 300) lines are permitted to go into this state, and will act normally when the time comes to dial.

TEL - Screen 2

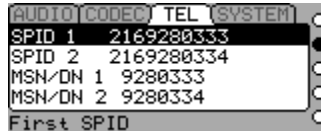

Pressing the *TEL* button a second time, shows this screen. These important parameters must be entered about your ISDN circuit in order for it to properly function.

If your ISDN BRI circuit protocol is ETS 300 (Euro ISDN), INS 64 (Japanese ISDN), or AT&T Cust PTP you can leave all of these blank.

SPID 1 & SPID 2

Users in the USA & Canada should enter their SPIDs here. SPID mistakes (or confusion) are among the most common problems users in these countries have. Here are some tips to assist you.

	<p>ISDN TIP!</p> <ol style="list-style-type: none"> 1. <i>Incorrectly entered SPIDs are the most common problem users in the USA & Canada have placing ISDN calls. Compare the SPIDs you have entered with the SPIDs provided to you on by the phone company to be certain that you have entered them correctly. Do not add anything to your SPIDs.</i> 2. <i>Note that there are no hyphens, dashes (-), or spaces in SPIDs, so the system will not allow you to enter these characters. If your installer has included them in the SPID, ignore them.</i> 3. <i>For a list of working SPID formats by Telephone Company, see Appendix 4.</i> 4. <i>See Section 10 for numerous tips about SPIDs and ISDN protocol settings.</i> 5. <i>If you have any questions about your SPIDs, call your phone company.</i> 6. <i>If you have PTP (AT&T Custom Point-to-Point), INS 64 (Japanese ISDN), or ETS300 (Euro-ISDN) ISDN, you should not enter anything in the SPID fields.</i>
---	---

We've included numerous tips on SPIDs and the *TELCO* setting in Section 11.5 (Detailed Menu Reference).

MSN/DN 1 & MSN/DN 2

DNs (Directory Numbers) are needed in the USA & Canada, when the ISDN protocol is National ISDN or DMS-Custom. These are simply your 7-digit telephone numbers, as would be found in the telephone directory.

MSNs (Multiple Subscriber Numbers) are used with ETS 300 (Euro ISDN) and are optional. They can be used if you are sharing your BRI circuit with other equipment. For more information, see Section 11 (Detailed Menu Reference).



HOT TIP!

The Directory Numbers or DNs (sometimes called Listed Directory Numbers or LDNs) are your 7-digit phone number as would be found in the Telephone Directory. They normally do not include the area code.



IMPORTANT TIP!

Each directory number (DN) will correspond to one SPID. You must enter them to reflect this relationship. The DN corresponding to SPID1 must be entered as MSN/DN 1 while the DN corresponding to SPID2 must be entered as MSN/DN 2.

If you experience problems only with incoming calls check your DNs.



ZEPHYR CLASSIC VS XSTREAM COMPARISON!

Most versions of the Zephyr Classic allow the Directory Numbers to be omitted. The Xstream and Xport require that these be entered.

TEL - Screen 3



Pressing the *TEL* a third time will show this menu. The options for this menu are as follows:

Telco

This is the protocol for your ISDN circuit. Outside of the USA & Canada, it is usually ETS 300 (Euro ISDN). In the USA & Canada, the most common protocol is National ISDN 1 (use the *Natl.I-1* setting). In Japan it will be INS 65 (Japanese ISDN).

	<p>IMPORTANT!</p> <p><i>Each ISDN circuit has a certain ISDN protocol (or “switch type”) that the phone company should have given you. By far the most common protocols in the USA & Canada are National ISDN-1 & National ISDN-2 in which case you should set the Telco setting to Natl.I-1.</i></p> <p><i>If you do not know what protocol your line is configured for, try Natl.I-1 first. If that does not work, see Section 11 (Detailed Menu Reference) for hints on how to guess your protocol.</i></p>
---	---

In Section 11 (Detailed Menu Reference), we've included numerous tips in how to guess your *Telco* setting for users in the USA & Canada.

<h1 style="font-size: 2em; margin: 0;">Z</h1>	<p>ZEPHYR CLASSIC VS XSTREAM COMPARISON!</p> <p><i>The Zephyr classic does not distinguish between "National ISDN-1" protocol and "DMS-100 Custom Functional" protocol - Both use the Natl I-1 setting. This is not true for the Xstream. If unsure which is correct for your ISDN circuit, try both settings.</i></p>
---	---

Auto Ans.

This determines whether your Xstream will automatically connect to incoming calls. When set to *All* it will answer incoming calls. You will hear a "bleep" sound when this happens.

When set to *None* the unit will make a "ringing" sound when there is an incoming call. A message is displayed on the LCD screen showing the calling party number (if available) and options allowing you to accept or reject the call.

You can also select *Zephyr* or *Phone*, which will cause the unit to only accept data or voice telephone calls, respectively. Other types of calls would require manual treatment, as detailed above.

NOTE: Call from a Zephyr Xport that is calling from a POTS (analog) line is considered a *Phone* mode call.

Interface

This allows you to choose between the ISDN, Ethernet and, if you have the optional V.35/X.21 interface, V.35. To use the V.35/X.21 interface choose *V.35 Split* or *V.35 Single*. To use the built-in ISDN interface set this to *ISDN*. To stream IP over the Ethernet choose *Ethernet*.

	<p>HOT TIP! <i>Choosing Ethernet or V.35 Single will change the available options for the CODEC and DIAL menus. See Appendix 7 (Special Operational Modes) for additional information.</i></p>
---	--

Prefix

This will generally be left blank. Any number(s) entered in this field will be appended to the beginning of any number entered when dialing (either manually or by using *Dial Setups*). The most common use of this is when your ISDN circuit requires that a "9", "8", or other digit be used before dialing a number.

Since your Xstream may be moved from line to line, and not all lines may need this prefix, we allow you to enter this prefix here, so you can omit it from *Dial Setups*. In this way the same *Dial Setups* can be used on different lines.

TEL - Screen 4



Pressing the *TEL* a fourth time will show this menu. These are the settings for the ports used for incoming and outgoing connections in the SIP and RTP Ethernet interface modes. The default ports are shown above. Please refer to Appendix 6 for more details on port assignments.

The options for this menu are as follows:

SIP Port

This is a TCP port used by the Xstream to set up a bi-directional Ethernet streaming connection.

UDP Port

After the a SIP session is initiated, or when using RTP streaming mode, the actual audio data is carried by UDP packets sent to and received on this port.

HTTP Port

The Xstream is able to use HTTP protocol to send an audio stream to a PC-based player for local debugging. At this time, these software players only support Layer 3 streaming. For stability, this should only be used for debugging, not on-air delivery or monitoring.

TCP Port

This setting is currently unused.

TEL - Screen 5



The fifth TEL screen has various settings for fine-tuning ISDN and v.35 performance.

DTMF

Enables or disables sending DTMF tones over voice calls using the front panel keypad. We offer the option of turning this off in the case that you may be entering information with the keyboard while dialed up on a voice call.

Redial

Sets the delay between automatic ISDN redials, or disables the feature. If an outgoing call is active when the Xstream loses ISDN connectivity or power, it will attempt to re-establish the call as soon as the error state is cleared (that is, when the ISDN comes back to life, or power is restored to the Xstream). You can adjust the time between these attempts, or disable them entirely. The redialing feature is also used when attempting to dial via contact closures and v.35 roll-over (see next item).

ISDN Backup

On an Xstream with both a v.35/x.21 card and an ISDN card, you can enable a rollover in case of v.35/x.21 failure. If you choose to enable this feature, this menu item will allow you to select an dial setup (any of your first ten) to be used. Note that by enabling this feature, you also allow ISDN calls to switch the Xstream from v.35/x.21 mode to ISDN mode (This is necessary because while one side of the high speed serial connection may see a failure, the other side could be operating as usual. In this case, when the side seeing the failure condition switches to ISDN mode and redials, the other side must respond to the ISDN request).

5.6 The *System* Menu

The system menu has many selections, a number of which the average user need not consider. We'll cover those of interest to the average user in this section. See Section 11 (Detailed Menu Reference) for more information on the rest.

The screenshot shows the 'Administration' section of the web interface. It contains three main configuration panels:

- IP settings:**
 - Host name: (letters and digits only, no spaces)
 - Network address:
 - Netmask:
 - Gateway:
 - NTP server: (takes effect after reset)
- User password:**
 - New password: (5 to 8 characters, letters and numbers)
 - Retype new password: (verify)
- Firmware version:**
 - Hardware revision: rev. 2
 - Primary Bank ver. 3.8.42b (build Fri Oct 24 13:16:15 EDT 2008)
 - Secondary Bank ver. 3.8.43b (build Fri Oct 24 13:37:21 EDT 2008)
 - commit this version to Bank 0
 - Warning: System will reboot after changing current bank.

An 'Apply' button is located at the bottom of the form.

SYSTEM - Screen 1 (Status)

```

AUDIO CODEC TEL SYSTEM
System Status
Uptime      0-01:00:24
Loopmode    None
Version     3.8.80b BETA
Interface   ISDN
    
```

This menu gives summary information about the system. It gives a quick summary of the information customer support will need to help you. Should you need to call us, have this information ready.

Uptime – This is the length of time since the last reboot (power cycle or warm boot). This can be helpful when troubleshooting intermittent problems. The format is D-HH:MM:SS. D = Days; H = hours; M = Minutes; S = Seconds.

Loopmode – This is the state of the Loopmode setting in the 5th *SYSTEM* menu. This should normally be set to *none*.

Version – This is the software version for your Zephyr Xstream. When you call Telos Technical Support they may request this information. If version number ends in 'b' or 'r' and the unit has a 100Base-T Ethernet jack on the back, it is capable of Livewire streaming.

Interface – This is the current setting of the *Interface* option located on the third *TEL* menu.

SYSTEM - Screen 2



This menu has the most frequently used *System* menu items. These are:

Contrast

This allows you to change the contrast of Xstream's LCD display to accommodate differing room lighting or viewing angle.

Volume

No, this doesn't belong in the *AUDIO* menu... this volume selection is to adjust the volume of the different sounds the Xstream makes when keys are pressed, calls connect, or other things happen.

rs232

This allows you to easily set the bit rate of the Zephyr Xstream's RS-232 port on the rear panel.

About

This gives you information about your Xstream.

SYSTEM - Screen 3



Pressing the *SYSTEM* button a third time shows this screen with the selections needed to configure your IP (Internet Protocol) settings. You won't need to enter this to operate the unit from the front panel. You will need to enter this information if you will be connecting to the Xstream's Ethernet port (i.e. if you are using Livewire, will be using the *Ethernet* streaming mode, or will be controlling the unit remotely using a web browser).

You will also need to enter these items when the time comes to update the Xstream's operating software. For more information, see Section 11 (Detailed Menu Reference) and Section 13 (Deep Tech & Troubleshooting Info.)

SYSTEM - Screen 4

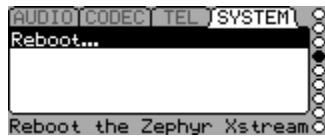

Current Version



Legacy Versions

The fourth press of the *SYSTEM* button brings you to the reboot or FTP screen used to update the Zephyr Xstream's software. Older versions of the software use an FTP site for updates. Current versions are updated via their web page interface. For more information, see Sections 11 (Detailed Menu Reference) and 13 (Deep Tech & Troubleshooting Info.)

Reboot

This option is used to restart the Xstream without cycling power. It can be handy. The Xstream is designed for long term operation without user intervention. If you frequently experience problems that seem to be solved by rebooting, be sure to contact Telos with all relevant details, so we can assist you in determining the cause.

SYSTEM - Screen 5

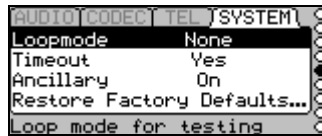

The fifth *SYSTEM* menu screen has several options, as follows:

Loopmode

This allows you to activate various loop modes used to troubleshoot the unit and its environment. This should normally be set to *None*, and will revert to that value on startup. See Section 13 (Deep Tech & Troubleshooting) for troubleshooting information.

Timeout

This determines whether the system will return to the default screen after a period of inactivity. The default setting is "Yes" meaning that the system will return to the default menu after 120 seconds of inactivity.

Ancillary

See Section 11 (Detailed Menu Reference) for details on this option. The usual setting is "On" which is the default.

Restore Factory Defaults...

This selection allows you to clear all settings of your Xstream. All menu options will be returned to the factory default settings. Don't use this option unless you are sure you wish to erase these entries. However, *Dial Setups* and *Location Setups* will not be erased.

You will be prompted with a WARNING screen inquiring if you really wish to erase all your settings. Press the <SEL> button (or any of the MENU buttons) if you wish to abort.

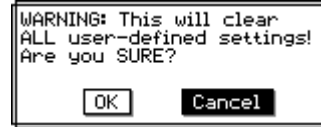

If you choose to proceed with erasing your settings, select *OK* by pressing <▼> or <▲> to select *OK*. Then press <SEL> to proceed.

In rare cases where the Zephyr Xstream's internal memory has become corrupted, the *Restore factory defaults* selection may help clear up the misbehavior of the unit.

5.7 Auto, Dial & Drop

These functions are covered in detail in *Section 4.2 – Intro to the Xstream's Menu System* and in *Section 11.7 – The Works, Detailed Menu Reference*. Please refer to those sections for more information.

6 AUDIO CODING REFERENCE

6.1 Introduction to Audio Coding Technology

Introduction

Audio takes up a lot of data. Just a regular phone call uses 64,000 bits per second.

Without data reduction, CD-quality quality audio — 16 bits at 44.1kHz sample rate — requires a transmission capacity of about 706 thousand bits per second (kbps) for each audio channel. But, the wires we use for remote broadcasting are on a telephone system designed for voice-grade communications: 8 bits at 8kHz sample rate, or 64 thousand bits per second (kbps) per channel. That's 11% of what we need.



CURIOSITY NOTE!

*You can arrive at these same numbers with nothing more complicated than grade-school math. Just multiply the sample rate by the sample depth: 44,100 samples per second * 16 bits per sample = 705,600 bits per second for CD-quality mono audio. Multiply by 2 for stereo.*

You can reduce the data requirements by lowering the quality somewhat. 13 bits would yield a respectable 78 dB dynamic range, certainly adequate for casual home listening. And a 32kHz sample rate — with careful equipment design — will give you flat response to 15kHz, the practical limit for analog FM broadcasting in North America. Unfortunately, that still leaves us with telephone data channels about 93% too small to do the job. Besides, 13 bits is an awkward bit depth (resolution) for computers to deal with, and the audio it produces isn't clean enough to survive today's transmitter processors.



CURIOSITY NOTE!

Bit depth and sample rate translate easily into audio specifications. Digital audio must have a sample rate of at least twice the desired bandwidth, so 15kHz audio requires (after a safety margin) 32kHz sampling.

Each bit of sample depth represents slightly more than 6dB of dynamic range.

The first practical coding methods used a principle called ADPCM, Adaptive Delta Pulse Code Modulation. This takes advantage of the fact that it takes fewer bits to code the difference, or

delta, between successive audio samples compared to using the individual values. Further efficiency is had by adaptively varying the difference comparator according to the nature of the program material. G.722 and APT-X are examples of ADPCM schemes. They achieve around a factor of 4:1 reduction in bitrate.

G.722 achieves additional efficiency by allocating its bits to match the patterns in the human voice, and it's considered adequate for news and talk programming over ISDN. But, for high-fidelity transmission, algorithms with more power are required. These are based on psychoacoustics, where the coding process is adapted to the way we hear sounds. There are several algorithms available, with varying complexity and performance levels.

Some years ago, the international standards group ISO/IEC established the ISO/MPEG (*Moving Pictures Expert Group*), to develop a universal standard for encoding moving pictures and sound for digital storage and transmission media. The standard was finalized in November 1992 with three related algorithms, called Layers, defined to take advantage of psychoacoustic effects when coding audio. Layer 1 and 2 are intended for compression factors of about 4:1 and 6 or 8:1 respectively, and these algorithms have become popular in satellite and hard-disk systems. Layer-3 achieves compression up to 12.5:1 — 8% of the original size — making it ideal for ISDN.

Basic Principles of Perceptual Coding

With perceptual coding, only information that can be perceived by the human auditory system is retained.

Lossless – which, for audio, translates to noiseless – coding with perfect reconstruction would be an optimum system, since no information would be lost or altered. It might seem that lossless, redundancy-reducing methods (such as PKZIP, Stuffit, Stacker, and others used for computer hard-disk compression) would be applicable to audio. Unfortunately, no constant compression rate is possible due to signal-dependent variations in redundancy. There are highly redundant signals like constant sine tones (where the only information necessary is the frequency, phase, amplitude, and duration of the tone), while other signals, such as those which approach broadband noise, may be completely unpredictable and contain no redundancy at all. Furthermore, looking for redundancy can take time. While a popular song *might* have three choruses with identical audio data that would need to be coded only once, you'd have to store and analyze the entire song in order to find them. Any system intended for a real-time use over telephone channels must have a consistent output rate and be able to accommodate the worst case, so effective audio compression is impossible with redundancy reduction alone.

Fortunately, psychoacoustics permits a clever solution! Effects called “masking” have been discovered in the human auditory system. These masking effects (which merely prove that our brain is also doing something similar to bit rate reduction) have been found to occur in both the frequency and time domains and can be exploited for audio data reduction.

Most important for audio coding are the effects in the frequency domain. Research into perception has revealed that a tone or narrow-band noise at a certain frequency inhibits the audibility of other signals that fall below a threshold curve centered on a masking signal.

The figure below shows two “threshold of audibility” curves. The lower one is the typical frequency sensitivity of the human ear when presented with a single swept tone. When a single constant tone is added, the threshold of audibility changes as shown in the upper curve. The

ear's sensitivity to signals near the constant tone is greatly reduced. Tones that were previously audible become "masked" in the presence of "masking tones," in this case, the one at 300 Hz.

All signals below the upper "threshold of audibility" curve, or Masking Threshold are not audible, so we can drop them out or quantize them crudely with the least number of bits. Any noise which results from crude quantization will not be audible if it occurs below the threshold of masking. The masking depends upon the frequency, the level, and the spectral distribution of both the masker and the masked sounds.

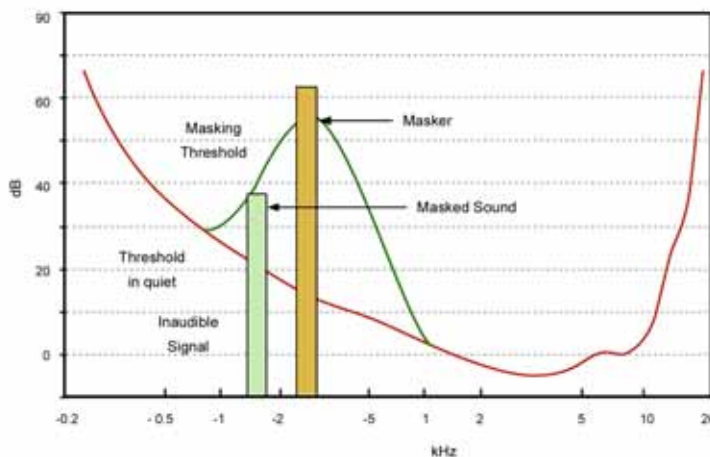

Masking effects in the frequency domain. A masking signal inhibits audibility of signals adjacent in frequency and below the threshold.

To benefit from the masking effects, perceptual coders use a filter bank to divide the input audio into multiple bands for analysis and processing. The maximum masked noise level is calculated depending upon the spectral content, and the available bits are allocated so as to keep the quantization noise below the masking threshold at every point in the spectrum.

While coding efficiency increases with more bands and better frequency resolution, the time domain resolution decreases simultaneously owing to an inevitable side-effect of the band filtering process. Higher frequency resolution requires a longer time window – which limits the time resolution. Happily, masking works also in the time domain. A short time before and a longer time after a tone is switched on and off, other signals below a threshold amplitude level are not noticeable. Filter banks with higher frequency resolution naturally exploit the ear's time-masking properties.

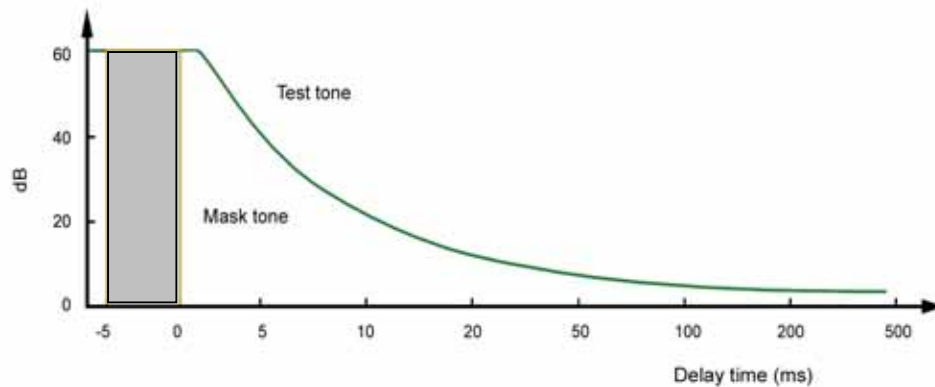

Masking effects in the time domain. Masking occurs both before and after the masking signal.

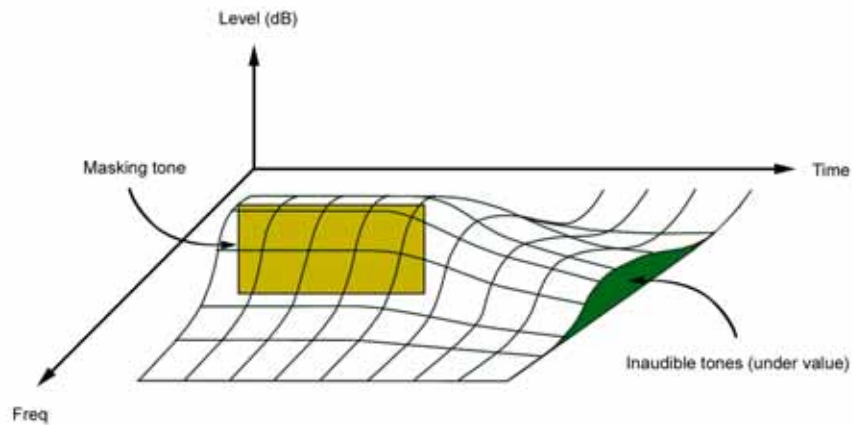

The combined results of time and frequency vs. masking. Signals under the curve are inaudible.



IMPORTANT!

Due to a perceptual coder's reliance on precisely modeling principles of human perception, audio to be coded should not be processed with any non-linear dynamics-processing such as clipping, multi-band compression, or hard limiting. Wideband compression, or AGC, is acceptable, and may be desirable if a consistent level cannot otherwise be achieved.

The same is true of audio that has been decoded, after passing through a perceptual coding cycle, but to a much lesser degree.

For more information on this follow the link to our Omnia Audio website that has a paper delivered at the AES by Frank Foti on this topic.

<http://www.omniaaudio.com/techinfo/default.htm>

The steps involved in the perceptual coding process are shown below:

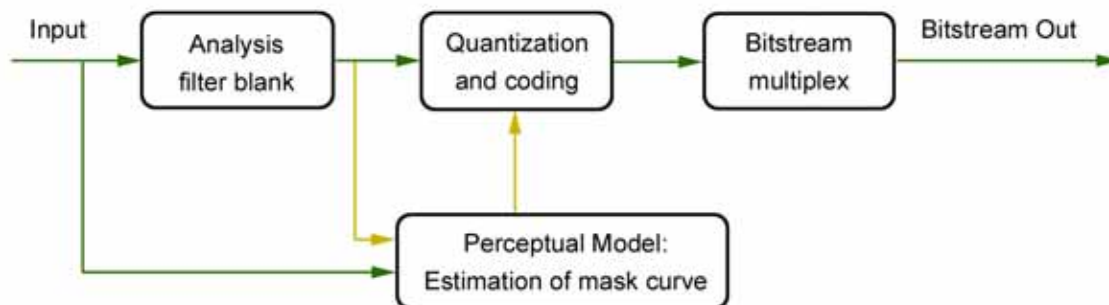

The components work as follows:

- The analysis filter bank divides the audio into spectral components. Sufficient frequency resolution must be used in order to exceed the width of the ear's critical bands, which is 100 Hz below 500 Hz and 20% of the center frequency at higher frequencies.
- The estimation of masked threshold section is where the human ear/brain system is modeled. This determines the masking curve, under which noise must fall.
- The audio is reduced to a lower bit rate in the quantization and coding section. On the one hand, the quantization must be sufficiently coarse in order not to exceed the target bit rate. On the other hand, the error must be shaped to be under the limits set by the masking curve.
- The quantized values are joined in the bit stream multiplex, along with any side information.

Doing audio coding effectively means managing several tradeoffs. Most important is the number of samples coded together in one frame. Long frames have high delay, but are more efficient because the header and side information is transmitted less frequently. Longer frames offer the possibility to use filter banks with better frequency resolution. A fundamental principle in signal processing is that spectral splitting filters may have either good time resolution, or good frequency resolution, but not both. This makes sense when you consider that a longer time window means that the analyzer has more complete information, more full audio cycles, to work with¹.

In the case of rapidly changing input signals (transients) long frames are poorer than short ones because the time spread will lead to so called *pre-echoes*. For such signals, the size of the frame should correspond to the temporal resolution of the human ear. This can be achieved by using short frames or by changing the frame length according to the immediate characteristics of the signal.

¹ Perhaps this is the DSP designer's equivalent to the economist's TANSTAAFL: There ain't no such thing as a free lunch.

MPEG

By far, the most popular high fidelity audio coders rely upon techniques developed under the MPEG umbrella. MPEG stands for Motion Pictures Expert Group, a Joint Committee of the International Standards Organisation (ISO) and the International Electrotechnical Commission. Over a decade ago, when the CD had just been introduced, the first proposals for audio coding were greeted with suspicion and disbelief. There was widespread agreement that it would simply not be possible to satisfy golden ears while deleting 80% or more of the digital audio data. But the audio coding pioneers were persistent and the MPEG audio group was formed. Since 1988, they have been working on the standardization of high quality audio coding. Today, almost all agree not only that audio bit rate reduction is effective and useful, but that the MPEG process has been successful at picking the best technology and encouraging compatibility across a wide variety of equipment.

The MPEG process is open and competitive. A committee of industry representatives and researchers meet to determine goals for target bit rate, quality levels, application areas, testing procedures, etc. Interested organizations that have something to contribute are invited to submit their best work. A careful double blind listening test series is then conducted to determine which of the entrant's technologies delivers the highest performance. The subjective listening evaluations are done at various volunteer organizations around the world that have access to both experienced and inexperienced test subjects. Broadcasters are the most common participants with many of the important test series conducted at the BBC in England, the CBC in Canada, and NHK in Japan. Finally, results are tabulated, a report is drafted and ultimately a standard is issued.

In 1992, under MPEG1 (the first of the MPEG standards), this process resulted in the selection of three related audio coding methods, each targeted to different bit rates and applications. These are the famous layers: 1, 2 and 3. As the layer number goes up, so does performance and implementation complexity. Layer 1 is not much used. Layer-2 is widely used for DAB in Europe, audio for video, and broadcast playout systems. Layer-3 – which Telos was the first to use in the Zephyr – is widely used in broadcast codecs and has gone on to significant Internet and consumer electronics fame under the moniker derived from the file extension: *MP3*. MPEG2 opened the door for new work, and some minor improvements were added to both Layers 2 and 3. In 1997, the first in the AAC family was added to the MPEG2 standard. MPEG4 is ongoing now, but it has already been decided that AAC will be the “general audio” coder under this umbrella. (MPEG3 was skipped for reasons unknown.)

MPEG2 AAC (Advanced Audio Coding)

The MPEG2 AAC system is the newest audio coding method selected by MPEG and became an International standard in April 1997. It is a fully state-of-the-art audio compression tool that provides performance superior to any known approach at bit rates greater than 64 kbps and excellent performance relative to the alternatives at bit rates reaching as low as 16 kbps.

The idea that led to AAC was not only to start fresh, but also to combine the best work from the world's leading audio coding laboratories. Fraunhofer, Dolby, Sony, and AT&T were the primary collaborators that offered components for AAC. The hoped for result was ITU (International Tele-communications Union) “indistinguishable quality” at 64 kbps per mono channel. That is,

quality indistinguishable from the original, with no audio test item falling below the “perceptible, but not annoying” threshold in controlled listening tests.

The MPEG test items include the most difficult audio known to codec researchers, so this was daunting challenge. The thinking was that if a codec could pass this test, it would surely be transparent for normal program material like voice and pop music, which are much easier to encode. AAC designers chose to use a new modular approach for the project, with components being plugged-in to a general framework in order to match specific application requirements and the always-present performance/complexity/delay tradeoffs.

Compared to the previous layers, AAC takes advantage of such new tools as temporal noise shaping, backward adaptive linear prediction and enhanced joint stereo coding techniques. AAC supports a wide range of sampling rates (8–96 kHz), bit rates (16–576 kbps) and from one to 48 audio channels.

AAC is a lot more sophisticated than the previous MPEG layers 2 & 3, providing significantly more coding power. Because it uses a modular approach, new ideas can be developed and plugged in to the basic structure. This had the additional advantage that it was possible to combine the various components from different developers, taking the best pieces from each. AAC was built on a similar structure to Layer-3, and thus retains most of its features. Nevertheless, compared to the previous MPEG layers, AAC benefits from some important new additions to the coding toolkit:

- An improved filter bank with a frequency resolution of 2048 spectral components, nearly four times the number used by Layer-3.
- Temporal Noise Shaping, a new and powerful element that minimizes the effect of temporal spread. This benefits voice signals, in particular.
- A Prediction Module guides the quantizer to very effective coding when there is a noticeable signal pattern, like high tonality.
- Perceptual Noise Shaping allows a finer control of quantization resolution, so bits can be used more efficiently.

Because it uses this modular approach, an implementer may pick and choose among the component tools to make a product with appropriate performance/complexity ratios. Or, new modules can be developed later and “plugged in” to its basic structure. Three default profiles have been defined, using different combinations of the available tools:

- **Main Profile.** Uses all tools except the gain control module. Provides the highest quality for applications where the amount of random accessory memory (RAM) needed is not constrained.
- **Low-complexity Profile.** Deletes the prediction tool and reduces the temporal noise-shaping tool in complexity.
- **Sample-rate Scaleable (SRS) Profile.** Adds the gain control tool to the low complexity profile. Allows the least complex decoder.

The block diagram of the AAC encoder is shown below. It is considerably more sophisticated than the previous MPEG Layer-2 and Layer-3 systems, and therefore offers more coding power.

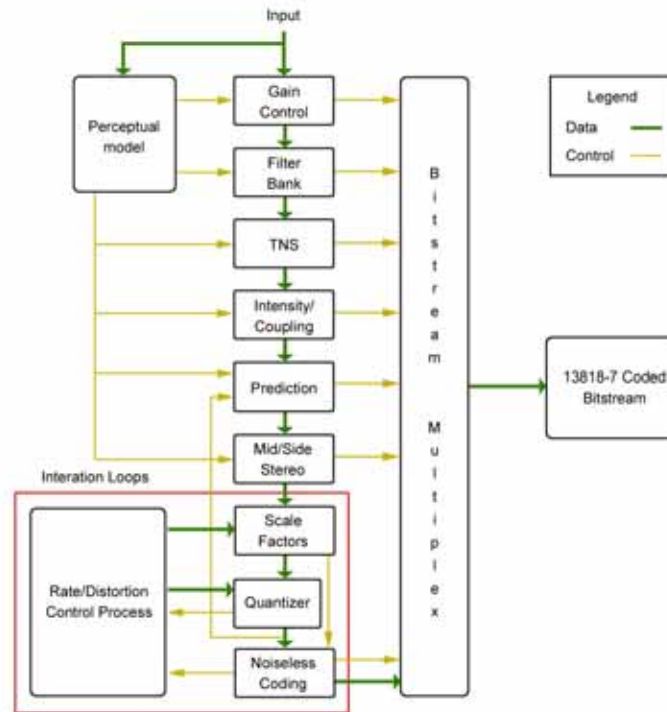

Because AAC was built on a similar structure to Layer-3, it therefore retains some of its powerful features:

- **Redundancy Reduction.** A Huffman encoding process causes values that appear more frequently to be coded with shorter words, while values that appear only rarely are coded with longer words. This results in an overall increase in coding efficiency – with no degradation, since it is a completely lossless process.
- **Bit Reservoir buffering.** Often, there are some critical parts in a piece of music that cannot be encoded at a given data rate without audible noise. These sequences require a higher data rate to avoid artifacts. On the other hand, some signals are easy to code. If a frame is easy, then the unused bits are put into a reservoir buffer. When a frame comes along that needs more than the average amount of bits, the reservoir is tapped for extra capacity.
- **Ancillary Data.** The bit reservoir buffer offers an effective solution for the inclusion of such ancillary data as text or control signaling. The data is held in a separate buffer and gated onto the output bit stream using some of the bits allocated for the reservoir buffer when they are not required for audio.
- **The Joint Stereo mode** takes advantage of the redundancy in stereo program material. The encoder switches from discrete L/ R to a matrixed L+R/ L-R mode dynamically, depending upon the program material.

The result of all this is that the researchers succeeded. AAC provides performance superior to any known codec at bitrates greater than 64kbps, and excellent performance relative to the alternatives at bitrates reaching as low as 16 kbps.

And the researchers succeeded in achieving the ITU goal. AAC is the first codec system to fulfill the ITU requirements for indistinguishable quality at 128 kbps/stereo². It has approximately 100% more coding power than Layer-2 and 30% more power than the former MPEG performance leader, Layer-3. For more information on AAC, and the tests of it, see our web site for a paper on the subject: www.telos-systems.com.

Zephyr Xstream is the first broadcast codec to incorporate the power of AAC coding, resulting in superior high-fidelity audio at lower bitrates and with less delay than Layer-3 or Layer-2.

It is the most powerful coding method available in Zephyr Xstream, and we particularly like it because it is perfectly matched to the bitrates available on ISDN BRI lines.

It offers:

- 20 kHz mono or stereo audio bandwidth.
- Significantly less delay than Layers 2 or 3.
- Full-fidelity mono on a single 56/64kbps channel.
- CD quality stereo³ on a single ISDN Telco circuit.
- Affordable, transparent, audio transmission for AM/FM radio or television audio.

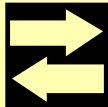
	<p>COMPTIBILITY TIP!</p> <p><i>The Zephyr Xstream cannot receive two J-stereo 64 feeds from the far end (after all, where would the audio be output?).</i></p> <p><i>When connected to two different sites simultaneously you can receive an audio feed back from each using G.722 or L3 Dual/Mono.</i></p>
---	--

² Subjective Evaluation of State-of-the-Art Two-Channel Audio Codecs, G. A. Soulodre, T. Grusec, et al. Journal of the Audio Engineering Society; Vol. 46, #3; March 1998, Pg 164 - 177.

³ 20kHz bandwidth, >96dB dynamic range... just like a CD. The encoding process can cause some loss that a trained listener, using carefully-selected program material and good monitors, could detect. However, most people won't hear the loss, and there's no accepted way to measure it.

AAC-LD (AAC Low Delay)

When announcers use codecs for broadcast remote applications, they often need to have natural two-way interaction with other program participants located back at the studio, or callers. Because it is a hot topic for engineers working in the field of Internet telephony, a number of studies have been conducted to determine user's reactions to delays in telephone conversations. The data apply directly to the application of professional codecs to remotes, so it is interesting to take a peak over the shoulder of the telecom guys to see what they have learned.

For broadcast remotes, we try to arrange our system so that there is no path for the field announcer's voice to return to his/her headphones. Nevertheless, sometimes echo is unavoidable. For example, this can happen when a telephone hybrid has leakage or when a studio announcer has open-air headphones turned-up loud and the audio makes its way into the studio microphone.

When there is no echo, it has been discovered that anything less than 100 ms one-way delay permits normal interaction between participants. Between 100 and 250 ms is considered "acceptable." ITU-T standard G.114 recommends 150 ms as the maximum for "good" interactivity. Echo introduces a different case. As you might expect, echo is more or less annoying depending upon both the length of time it is delayed and its level. Telephone researchers have measured and quantified reactions, and ITU-T G.131 reports the findings and makes recommendations.

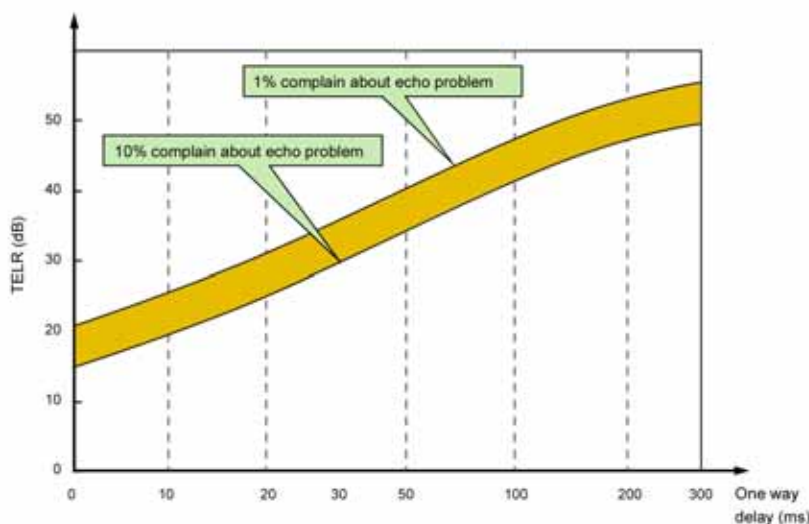

Summary of ITU-T G.13, with recommendations for designers of telephone systems that must cope with echo. This shows Talker Echo Loudness Rating vs delay.

There are codecs using other than perceptual technologies that have lower delay, but they are not as powerful. That is, for a given bitrate, they do not achieve fidelity as good as the MPEG systems we have been examining. The common G.722 is an example. It uses ADPCM (Adaptive Delta Pulse Code Modulation), which can have delay as low as 10 ms, but with much poorer quality. So the question arises: Is it possible to have high quality and low delay in the same

codec? Until recently, the answer was no, but new developments in codecs have changed the picture. One of the main objectives in audio coding is to provide the best tradeoff between quality and bit rate. In general, this goal can only be achieved at the cost of a certain coding delay. Codecs for voice telephone applications have use ADPCM and CELP because they have much lower delay than perceptual codecs. These are optimized for voice and can have reasonably good performance.

Zephyr users have known for years that Layer-3 offers all the fidelity needed for most broadcast situations. However, they also know that the delay of Layer-3 can be frustrating, particularly if high fidelity is needed in both directions and parties at the two ends must carry on a conversation.

The folks at Fraunhofer were aware of these factors, and have developed an extension to AAC called "AAC Low Delay," or "AAC-LD" for short. AAC-LD offers quality equivalent to Layer-3 with less than 25% of the delay!

AAC-LD combines the advantages of perceptual coders (such as Layer-3) with certain principles of speech coders. Compared to speech coders, AAC-LD handles both speech and music with good quality. Unlike speech coders, however, audio quality scales up with bit rate, and transparent quality can be achieved. AAC-LD's coding power is roughly the same as Layer 3, meaning that mono high fidelity 15 kHz audio may be sent via one ISDN channel. With ISDN's two channels, you achieve near CD quality stereo.

Delay in perceptual codecs is dependent on several parameters:

- Frame length. Time is required to collect all the samples for a frame. The longer the frame, the more the delay.
- Filter bank delay. This causes an additional delay equivalent in time to the frame delay.
- Look-ahead delay for block switching. Layer-3 and AAC use filter banks with high frequency resolution. For signals with high tonality, efficiency is high. But when there are transients, a dynamic switching process changes to a filter bank with lower frequency resolution and better time resolution. In order to correctly decide when to make this change, a look ahead process is required, adding delay.
- Bit reservoir. The length of this buffer determines how much delay this process contributes.

The overall delay is a combination of all of these components, divided by the sampling rate. The delay scales linearly and inversely with the sampling frequency.

How AAC-LD Gets its Low Delay

AAC-LD is based on the core AAC work, so much is similar, but each of the contributors to the delay had to be addressed and modified:

- The frame length is reduced to 512 or 480 samples, with the same number of spectral components at the filter bank output.

- No dynamic block switching is used because the required look-ahead delay is too big. The temporal problem that causes pre-echoes is handled by the Temporal Noise Shaping module.
- The “window shape” of the spectral filter is enhanced to be adaptive. Normally, the shape is a simple sine curve, but AAC-LD can use a shape that has a lower overlap between the bands. This significantly improves performance with transients, without adding any delay.

Amazing Performance

Low delay would not be useful if the quality was not acceptable, of course. So how does AAC-LD stack-up? The results are shown below: AAC-LD is clearly better than Layer-3 for half of the test items, and as good for the remaining half. Not bad considering that AAC-LD has a fraction of the delay.

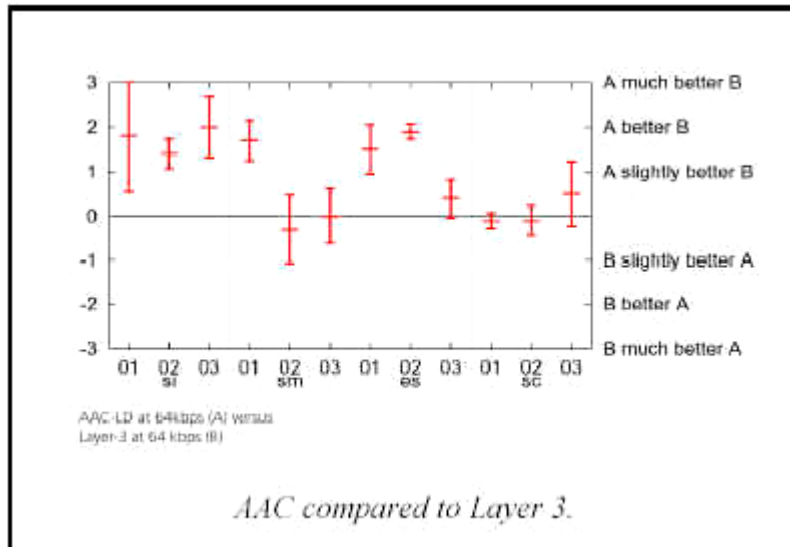

Performance comparison of Layer 3 and AAC-LD. A = AAC-LD, B = Layer 3.

Results here are very good for AAC-LD. Test items es01-03 are speech. Since most mono remote broadcasts are speech, you can expect audio quality even better than with the familiar – and already perfectly useful – Layer-3. Pop music is the test item sc03 and performance is good here as well. The one slight trouble spot is the glockenspiel at sm02...

We expect you will find this mode very useful.

ISO/MPEG LAYER-3

After extensive testing by broadcasting organizations around the world under the direction of the CCIR, it had been designated as the most powerful of the three audio coding systems

standardized in ISO/MPEG IS-11172. Prior to the availability of AAC, Layer-3 was specifically recommended for 56 and 64 kbps channel.

Layer-3 Features

Psychoacoustic Masking

The audio in Layer-3 is divided into 576 frequency bands. First, a polyphase filter bank performs a division into the 32 “main” bands which correspond in frequency to those used by the less complex Layer-2. Filters are then used to further subdivide each of the main bands into 18 more. At a 32 kHz sampling rate, the resulting bandwidth is 27.78 Hz – allowing very accurate calculation of the masking threshold values. Sufficient frequency resolution is available to exceed the width of the ear’s critical bands (100 Hz below 500 Hz; 20% of the center frequency at higher frequencies) across the audible spectrum, resulting in better hiding of noise than would otherwise be possible.

Redundancy Reduction

Redundancy reduction is accomplished by a Huffman coding process to take advantage of the statistical properties of the simplified signal output from the psychoacoustic stage. Values that appear more frequently are coded with shorter words, whereas values that appear only rarely are coded with longer words. This results in an overall decrease in the data rate, with no degradation, since it is a lossless reduction scheme.

Notice that this redundancy reduction process is the ideal supplement to psychoacoustic masking. In general, maskers with high tonality have more redundancy but allow less masking, while noise-like signals have low redundancy and high masking effect.

Bit Reservoir Buffering

Often, there are some critical parts in a piece of music that cannot be encoded at a given data rate without audible noise. These sequences require a higher data rate to avoid artifacts. Layer-3 uses a short time “bit reservoir” buffer to address that need. Similar to a savings account, this buffer is filled in “easy times” with data bits that are not required for the actual frame. If a critical part occurs, the encoder can use the saved bits to code this part with a higher data rate.

Ancillary Data

The bit reservoir buffer offers an interesting capability: an effective solution for the inclusion of such ancillary data as text or control signaling. The data is held in a separate buffer and gated onto the output bitstream using the bits allocated for the reservoir buffer when they are not required for audio.

Layer-3 J-Stereo

A joint stereo mode permits advantage to be taken from the redundancy in stereo program material. The encoder switches from discrete L/R to a matrixed L+R/L-R mode dynamically, depending upon the program content. The matrixed mode of operation takes advantage of the usual redundancy of the “center” channel information and therefore significantly improves overall fidelity.



HOT TIP!

Joint stereo takes advantage of the way sounds distribute themselves over a normal stereo field. If you're transmitting two signals that don't comprise a normal stereo field — as would be the case if you're transmitting two totally independent audio channels — it won't save you anything.



CURIOSITY NOTE!

Layer-3 is the direct successor to the "ASPEC" algorithm, which was based on coding methods by Fraunhofer/University of Erlangen, AT&T, Thomson Consumer Electronics, and CNET (Centre National d'Edudes des Télécommunications).

In the first tests for ISO in 1990, ASPEC showed the best sound quality, with an advantage at lower bit rates. The precursor to the Layer-2 algorithm — originally called MUSICAM⁴ — had the advantage of lower complexity and simpler processing. L3 came from a merging of both systems: For easier transcoding, L3 adopted the L2 filter-bank for the first stage, and the bitstream rate was adjusted

ISO/MPEG LAYER-2

MPEG Layer-2 was an extremely popular early perceptual coding method, primarily because it's easier and less expensive to implement — particularly at the encoder — and practical devices using it were available earlier than Layer-3. It's a preferred choice for applications where very large data capacity is available, such as satellite links, high-capacity Primary ISDN or T1 circuits, and hard disk storage systems using Ethernet for signal distribution.

We include it in Zephyr Xstream to offer compatibility with the widest variety of codecs, and for use at high bit rates.

Layer-2 J-Stereo

The Layer-2 joint stereo mode uses an "intensity coding" method. This method has high coding power and is quite effective, but hurts stereo separation on some program material. Audio above 3 kHz or so is combined to mono and panned to one of seven positions across the stereo stage.

G.722

This technology pre-dates perceptual coding. It is much simpler than the transform methods, but suffers from poorer audio performance. It has the benefit of low cost and the unique advantage of low delay. It has been around as an international standard the longest, and is

⁴ While "Musicam" was the original European developer's name for a particular coding process, it was subsequently registered as a product trademark by a US company... forcing world-wide users to drop the name and use "Layer-2" instead. That company's products and the internationally-accepted algorithm have nothing to do with each other, except that ISO/MPEG Layer-2 is one of the modes supported by the products.

probably the most widely used system. In our view, this technology is acceptable for mono voice where high fidelity is not necessary. It is good also for cueing and intercom channels.

We have included G.722 in ZephyrXstream because:

- It had been the most popular coding method early on, so there are many of these codecs in use. Because it is a standard, codecs from various manufacturers have a good probability of being able to interwork with one-another. (We've tested with many units and have found no problems so far.)
- G.722 has the lowest delay of all popular coding methods.

This method was invented in the late 70s and adopted as a standard in 1984 by the CCITT, the *Consultative Committee for International Telephony and Telegraphy*, a division of the United Nations. The technique used is Sub-Band ADPCM (Adaptive Delta Pulse Code Modulation), which achieves data reduction by transmitting only the difference between successive samples. G.722 does this in two audio frequency sub-bands: 50-4kHz and 4kHz-7kHz.



DEEP TECH NOTE!

Only two bits are allocated per sample for audio frequencies above 4 kHz – sufficient for conveying the sibilance in voice signals, but not very good for intricate musical sounds. Also, the “predictor model” used to determine the step size in the adaptive function is designed only for speech. This is why music transmitted via G.722 has a distinct ‘fuzzy’ quality.

G.722 has a frequency response extending to 7.5 kHz with fairly poor fidelity. Unless there is no alternative, it should not be used for music.

G.722 uses a procedure called “statistical recovery timing” or “statistical framing” to lock the decoder to the data stream. (We use the procedures specified in ANSI standard T1.306-1989.) This process usually happens instantaneously, but can take up to 30 seconds.

Other strange effects may be observed. Tones and noises may be present before locking occurs, and some continuous audio tones may cause momentary unlocking. Please note this is inherent in G.722’s statistical framing and is not an implementation problem with Zephyr Xstream.



IMPORTANT!

The locking can be sensitive to audio present on the G.722 path, as it relies on properties of the audio itself. Some audio material and tones can prevent lock from ever happening. Low level noise is the most reliable signal for locking, and undistorted voice is usually OK. The most common problems are with sine tones and distorted voice or music signals, in which case turning off the audio signal — or lowering it 12dB or so — for a few seconds will generally let the system relock. In very rare cases, it may be necessary to disconnect and redial.

*In cases such as this, the **AUTO** Receive mode will not be capable of determining the correct settings and you may need to set the **Receive** setting to **G.722**.*

**HOT TIP!**

Another characteristic of G.722's statistical framing is that the decoder may remain locked despite serious corruption of the data, although audio fidelity will degrade. In cases where you are unable to get a good connection you may find this characteristic desirable, however you will find that the fidelity will be substantially less under these circumstances.

CASCADING

This section is preliminary, as coder cascading is an active field of investigation among algorithm designers, standards organizations, and users. Telos urges you to be wary and to let your own ears be the final judge until better information becomes available.

Some of what we do know:

- Some CCIR tests have demonstrated that one pass of Layer-3 at 56/64kbps can be cascaded with 2 - 5 passes of Layer-2 operating at high (112kbps+/channel mono; 192kbps+ Joint Stereo) bitrates with good results.
- Informal tests at the Telos lab with two passes of Zephyr Layer-3 have proven successful, with listeners noticing no audible degradation, even on "difficult" CDs.
- Tests with APT-X followed by one or two passes of Layer-3 followed by APT-X proved to be quite acceptable.
- One user has reported that two passes of Zephyr Layer-3, followed by one pass of SEDAT, is OK. (Stereo program mode.)
- The goal is to get as much "coding headroom" as possible at each stage. This is achieved when you:
 - a) Use the most possible bits at each stage, with the least possible compression (for example, by lowering the sample rate, and using 64kbps rather than 56kbps connection). This why we offer the mono 128 modes. and/or
 - b) Use the more powerful coding method of those available at each stage Xstream offers you the AAC for this reason.
 - c) Reduce the number of coded stages in the chain.

At the moment, we offer the following advice:

- Use coders only where necessary. Consider the alternatives at each stage. With the cost of hard disk capacity falling, is it really necessary to crunch at that point?

- Use the maximum bitrate you can afford at each stage.
Hard disk recorders and other studio systems often have an option to adjust this. For very critical work, remember that Zephyr Xstream has several modes where a mono program is split over two digital network channels, thereby cutting the compression ratio by 50%.
- Get the MPEG2 AAC and MPEG4 AAC-LD advantage on low bitrate channels.
- When using dedicated lines, consider using *V.35 Single* mode (see Appendix 6 - Special Operational Modes) at 256 or 384 kbps to allow "headroom" for other coding in the chain.

Mixed MPEG Signal Chains

What about the case where you will be using Layers 2, 3 *and* AAC in a signal chain? It turns out that the two methods are nicely complimentary.

At low bit-rates, AAC or Layer-3 gets more signal-to-mask margin than Layer-2. This is why they perform better in the low bit-rate tests. It accomplishes this by using a filter bank with more bands, 2048 vs 576 vs 32. One effect of this is "time spread." (More frequency resolution requires a longer time window. It's a law of physics thing...) For a small number of passes (one or two), this is good, as the ear has masking in the time domain as well as the frequency domain, and Layer-3 naturally exploits this additional dimension. The down-side is that when many stages of Layer-3 are used at low bit-rates, the time spread can become audible (softening of transients and pre-echoes, mostly), and this is a bad thing. While Layer-2 does not have this problem, it has another. Since it is closer to the edge for signal-to-noise, multiple generations result in unmasking (noise and grit, mostly).

But the ISO/MPEG people do not propose that a bunch of passes of Layer-3 be used. The idea is that AAC or Layer-3 be used at ISDN/SW56 bit-rates for field pick-up and that Layer-2 be used at higher bit-rates in other parts of the signal path.

This is why the ISO group decided to recommend the Layers as they did: AAC for 64kbps/channel and Layer-2 for equal to or greater than 128kbps/mono channel.

Our own experiments with codec cascading confirm that this is the right approach: the two coding methods seem to complement each other. Two passes of Layer-3 (stereo @ 128 kbps) sound noticeably better than two of Layer-2; a pass of Layer-3 followed by a pass of Layer-2 also sounds better than two of Layer-2. Moreover, we've had customers who have used a pass, or two, of Layer-3 followed by SEDAT without evident problems.

6.2 Choosing the Best Coding Mode for Your Application

The following chart summarizes and compares a number of important parameters for the coding modes offered in the Zephyr Xstream.

	AAC	AAC-LD	Layer-3	Layer-2	G.722
Algorithm Type:	Perceptual + Huffman + Temporal noise shaping + Backwards adaptive Linear prediction.	Perceptual + Huffman + Temporal noise shaping + Backwards adaptive Linear prediction.	Perceptual + Huffman	Perceptual	ADPCM
Audio Freq Response (+0/-1 dB):					
<i>Mono (56 or 64kbps) & Discrete Stereo (112 or 128kbps):</i>					
Sample Rate:					
16 kHz	--	--	--	--	7.5 kHz
24kHz	--	--	--	8.6 kHz	--
32 kHz	15 kHz	14 kHz	15 kHz	*7.8/9.8 kHz	--
48 kHz	20 kHz	14 kHz	16 kHz	*7.8/9.8 kHz	--
<i>Joint Stereo (112 or 128kbps):</i>					
Sample Rate:					--
32 kHz	15 kHz	14 kHz	15 kHz	15 kHz	--
48 kHz	20 kHz	14 kHz	16 kHz	20 kHz	--
<i>Stereo (56 or 64kbps)</i>					
Sample Rate					
32 kHz SR	7 kHz	--	--	--	--
48 kHz	10 kHz				
<i>Mono (112 or 128 kbps)</i>					
Sample Rate:					
32 kHz	15.8 kHz	15.8 kHz	14.8 kHz	14.8 kHz	--
48 kHz	19.8 kHz	15.8 kHz	21.8 kHz	18.8 kHz	--

	AAC	AAC-LD	Layer-3	Layer-2	G.722
Delay :					
<i>Stereo (128kbps):</i>					
Sample Rate:					--
32 kHz	242 msec	96 msec	452 msec	332 msec	--
48 kHz	190 msec	68 msec	326 msec	220 msec	--
<i>Mono (64kbps):</i>					
Sample Rate:					
16 kHz	--	--	--	590	14 msec
24kHz	--	--	--	402 msec	--
32 kHz	284 msec	88 msec	390 msec	308 msec	--
48 kHz	240 msec	56 msec	316 msec	208 msec	--
<i>Stereo (64kbps):</i>					
AAC @ 32kHz SR	404 msec	--	--	--	--
Coding "Power"	16:1 - 18:1	12:1	12:1	6-8:1, 12:1 in Joint stereo	4:1
Number of Bands	2048	2048	576	32	2
Notes: * Layer-2 mono or discrete stereo @ 48 kHz sample rate yields 7.8 kHz audio response at 56 kbps and 9.8 kHz at 64 kbps Delay will vary depending on ISDN network delay and other factors. Typical figures for encode-to-decode delay are given (network delay is not included). Frequency response is for swept sine test; response with program material will vary <i>owing to the dynamic nature of the coding process.</i>					

As you can see from above, the Zephyr Xstream offers such a wide range of options for several reasons:

- To optimize the tradeoff between delay and quality (see below);
- To offer compatibility with the large variety of equipment deployed in existing installations.
- To offer a range of delay vs. quality to accommodate different programming scenarios.

Delay vs. Quality

Looking at the chart, one thing that should be apparent is that there generally is a trade-off between delay and audio performance. Layer 3's excellent audio performance requires a significant delay. This is because some of its power comes from the ability to analyze the audio over a relatively long period. Layer II requires the next longest delay, followed by AAC, AAC-LD and G.722. AAC-LD and G.722 have minimal delay.

It should now be clear why we included AAC and AAC-LD in the Xstream. These modes break the rules: AAC offers the best fidelity with delay less than Layer-2, while AAC-LD offers the shortest delay of any perceptual coder, while still offering near-CD quality.

	<p>HOT TIP!</p> <p><i>The "round trip" delay in a typical broadcast remote may be minimized by using the AAC-LD algorithm from the remote site to the studios with the return path using G.722.</i></p> <p><i>Even with a stereo feed to the station, the round-trip delay will be under 100 msec using this combination! This makes two-way conversations between the two sites much easier.</i></p>
---	--

The Zephyr Xstream permits the coding mode for the send and receive paths to be independently chosen, so the choice may be optimized for the specific requirements of each direction.

It is generally agreed that delays of over 10 ms make live monitoring difficult. When modes other than G.722 are used, and live transmission of remote programs is required, operational methods like those routinely used with satellite links are a necessity. Section 10.3 (Applications Guide - Choosing a Receive mode) has more information on this topic.

	<p>DEEP TECH NOTE!</p> <p><i>The longer delay in the STEREO modes results from the splitting process required to take the MPEG bitstream and feed it across two transmission channels. In order to accommodate the possible differential delay between the two transmission channels, the system must buffer the two digital signals. The frames are read out from the buffer according to their numbering, which is generated during the encoding process. This makes for a very reliable method to ensure that the channels are in sync.</i></p> <p><i>The MONO 64 modes do not require this buffering and therefore have a lower delay. While it is possible to use the L3 Dual/Mono mode for stereo transmission, the system is unable to correct for delay differences between the two channels and significant phase problems are likely to occur.</i></p>
---	---

Dual/Mono vs. Stereo vs. Joint Stereo in AAC, AAC-LD & Layer-3

With one transmission path,

- Layer-3 Dual/Mono provides mono capability.

With two transmission paths,

- Layer-3 Dual/Mono mode is simply two simultaneous mono channels (to one or two sites).
- The AAC, LD-AAC, and Layer-3 STEREO modes compensate for any delay between the two transmission paths, but keep the two audio channels completely independent.



DEEP TECH NOTE!

While the "Stereo" modes keep the audio separate, the psychoacoustic model assumes the listener will be hearing both audio channels (i.e. it assumes that audio from one channel may mask audio on the other channel). For this reason the Mono/Dual mode is preferred when discrete unrelated material is to be sent down the two channels.



HOT TIP!

The when transmitting in the stereo modes, the far end will not receive anything until both transmission (i.e. ISDN) channels are connected and operating. The decoder will not will not output anything until this happens. Any data drop outs could cause interruptions of both audio channels.

If your application requires the ability for the two channels to come and go independently, such as when they are from independent sites, you must use L3 Mono/Dual for transmit and the far end must use L3 Mono/Dual receive. Or, you can use G.722. These are the only modes that support fully independent operation.

Z

ZEPHYR CLASSIC VS. XSTREAM COMPARISON

While the Zephyr Classic supports Dual transmission in Layer-3 as well as G.722, it can only independently receive in G.722.

- J-STEREO (Joint Stereo) mode in AAC, AAC-LD, and Layer-3 takes advantage of the redundancy that is usually present in stereo program material. The encoder switches from discrete L/R to matrixed L+R/L-R dynamically. When in L+R/L-R mode, bits are allocated dynamically to these two bit-streams allowing maximum advantage be taken advantage of redundancy between the two channels.

Since the "center-channel" redundancy, present in most stereo sources, is exploited to our advantage, the compression ratio is lower and therefore the quality is higher, for most material. For this reason we recommend using J-stereo under most circumstances.

The biggest exceptions would be:

- a) Cases where material that has been encoded in a surround sound format.
- b) Cases where final mix approvals of stereo source material are being made over the coded link. In this case, decisions about "stereo imaging" should be made in discrete stereo whereas overall mix review can be made in J-stereo.

Mono vs. MONO128 vs. Stereo vs. J-Stereo in Layer-2

With one transmission path,

- L2 Mono 64 provides mono capability.
- The L2 HALF 64 Xmt mode allows operation at 24kHz when this sample rate is desired, primarily when communicating with “single line” capable Layer-2 codecs.

With two transmission paths,

- L2 MONO128 provides the best Layer II quality by combining both transmission paths to achieve a higher bitrate. This mode requires 2 data paths.
- L2 STEREO mode is simply two simultaneous mono channels.
- L2 J-STEREO mode uses the “intensity coding” method in order to provide maximum quality for stereo program material and compensates for any delay between the two transmission paths.

Sampling Rate

This option sets the sample rate for the transmitted and received coded audio. Input/output is (usually) independent of the transmission bit rate and is set in the AES/EBU options in the *AUDIO* menus.

The Zephyr Xstream may be operated at either 48 kHz or 32 kHz sample rate. 48 kHz offers lower delay and in certain modes 20 kHz audio bandwidth. However, the 32 kHz rate is generally preferred for broadcast applications because no bits are wasted on frequencies above 15 kHz – which are not transmitted in analog broadcast services, anyway.

Decoder Limitations

- If your application requires the ability for the two channels to come and go independently, such as when they are from independent sites, you must use L3 Dual/Mono or G.722. These are the only modes that support fully independent operation.

Z	<p>ZEPHYR CLASSIC VS XSTREAM COMPARISON!</p> <p><i>Zephyr's L3 Stereo receive mode, used to receive two, independent, mono signals, requires that both channels be connected and operating in order for the decoder to function. Until both channels are present, the decoder will not output anything, even if the Xmt mode at the other end is not stereo. Any data dropouts could cause interruption of both audio channels.</i></p> <p><i>Zephyr Xstream's L3 Dual/mono decoder allows for completely independent reception. Therefore, it can accommodate incoming L3 mono from two sites simultaneously without compromise.</i></p> <p><i>Of course both Zephyr Classic and Zephyr Xstream can transmit L3 mono audio to two sites.</i></p>
---	--

- A typical application which works perfectly with these modes is the one used for dual-language sports broadcasts, with separate studio sites. This is

also useful for network operations centers, or other busy facilities, where the equipment must be stretched as far as possible.

Connectivity

The Xstream's MPEG bit streams follow standard ISO format, and may be used to communicate with any codec that supports this standard. In modes that require two ISDN channels, the channel-splitting (IMUX) method becomes an issue.

Layer 2 is widely supported by many manufacturers. The Zephyr Xstream supports the CDQ splitting scheme, so it may be used to communicate with the codecs from a variety of vendors that support this mode.

In Layer-3 Zephyr set the standard. Other codecs that support Layer-3 use the FhG/Telos protocol developed for Zephyr classic (Buchta splitting).

Telos has long been a proponent of international standards for codec interoperability. The specifications of our IMUX system, developed for AAC and AAC-LD, is available without royalty, and is published on our web site for reference by other manufacturers.

The Xstream's G.722 mode offers connectivity with almost all codecs that use this coding method, and which do not use the rare H.221 framing scheme. We support the more common "SRT" (Statistical Recovery Timing) method.

Ancillary data transmission is not standardized and is therefore not available between codecs made by different manufacturers.



USER'S MANUAL

7 ISDN BASICS

7.1 Background

It was the introduction of digital transmission services from telephone providers, which has made the Zephyr family possible. The telephone infrastructure has moved from analog to digital. Telephony made the first significant use of digital audio techniques. In the mid 60's a digital transmission method called "T-carrier" began to be widely deployed to expand the voice-channel carrying capacity of existing copper wires. While they were intended originally for simple single-channel analog, engineers discovered that the common copper wire pairs were capable of much higher bandwidth than the 3.4 kHz required for speech. Indeed, it was determined that two of these pairs could be made to relay 24 voice conversations – if they were digitized and appropriately multiplexed. Thus was born the basic technology used for digital telephony today.

The standards developed then continue to define the digital telephone network: an 8 kHz sampling rate (resulting from the desired 4 kHz Nyquist frequency to accommodate a 3.4 kHz audio bandwidth, with guard band) with 8 bits of amplitude resolution (instantaneously companded to provide performance roughly the same as a 13 bit linear system producing 78 dB dynamic range for speech signals). Thus the basic voice channel bit rate was established to be 64kbps. (8kbyte/sec x 8bits = 64kbps.)

DEEP TECH NOTE!



Actually, the original Telco technique used only 7 bits for the audio, and the 8th bit was used for signaling. Since the digital technology was deployed as isolated links (later over microwave or coax cable) within an otherwise analog network, channel banks at the boundaries of each digital interface performed analog-to-digital-to-analog conversion.

It was soon discovered that quantization noise was a problem, given that many calls underwent 3 or more conversions enroute. Since the signaling did not require 8kHz resolution, it was decided to use all 8 bits for audio, but to "rob" this low order bit on every 6th sample for signaling. This improved the noise problem, without the need to revamp the rest of the system.

This "Robbed bit" signaling is still occasionally encountered with T1 applications. It is ironic to discover that these bits (2 in each direction) are merely used to emulate the switch hook leads on much older analog trunk interfaces.

ISDN BRI and PRI finally bring truly modern signaling to the local loop. In fact PRI is very closely related to the SS7 technology used for interoffice trunks.

These early applications of digital technology were invented by the telephone industry for its own benefit. The fact that they were digital was neither obvious nor important to customers. However, telephone engineers soon learned to appreciate digital audio for the same reason we in the pro audio community have: immunity to noise and other quality impairments, ease and flexibility of routing and multiplexing, and lower cost due to compatibility with the electronics and media invented for the rapidly advancing computer industry.

Nearly all long-distance calls are now connected from city-to-city using digital paths on fiber cables and nearly all switching and routing is performed by digital machines.

With the digital nature of the modern telephone network is hidden from subscribers, voice and signaling has been delivered just as they have been since the era of wooden phone sets and mechanical bells. In the age of digital communication, this "last mile" bottleneck has become increasingly frustrating for those who have need to send digital information through Ms. Bell's wires.

With most of the network now digital, it is clearly odd that we have been using modems to convert digital information to analog beeps just to accommodate the mile or two of ancient analog linkage at each end of a thousand-mile long digital connection.

ISDN is the technology which has evolved to eliminate this analog bottleneck yet still utilize existing copper infrastructure. It is currently the only technology that allows fully digital access to the Public Switched Telephone Network.

7.2 The ISDN Basic Rate Interface (BRI)

On one ISDN BRI circuit, there are three simultaneous channels: Two 64kbps "bearer" channels for the transmission of user information and one 16kbps signaling channel for call set-up and status communication. This is Basic Rate Interface (BRI), 2B+D service. In Europe and other countries it is also referred to as ISDN-2 or S0. It can be implemented over most of the millions of standard copper two-wire phone circuits already in service.



CURIOSITY NOTE!

While the D channel is always present for signaling, it can, in theory, be used for connections to the public packet network. ISDN lines where the D channel is used only for signaling are sometimes referred to as 2B+0D rather than 2B+D service. D channel packet service is not widely available and is not used by Zephyr Xstream.

ISDN BRIs are perfectly matched to Zephyr Xstream's transmission capabilities. One channel provides high quality mono, while the two channels can carry near-CD quality stereo.

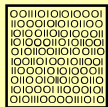

ISDN TIP!

In some cases, your ISDN line, while having 2 B channels, will only have only one phone number. This is the case of the AT&T Custom PTP protocol, and may be the case with ETS 300 (Euro-ISDN) and INS 64 (Japanese ISDN). This does not generally present a problem. This works as if the lines are assigned to a short "hunt group" i.e.; the first incoming call will be assigned to Line 1, and the second incoming call will be assigned to Line 2. Of course you have the option of which line to use on outgoing calls.



DEEP TECH NOTE!

The actual 2 B channels (i.e. timeslots) of the BRI are assigned on a per call basis. Therefore, from a theoretically correct viewpoint, Lines 1 and 2 do not fully correspond to B1 and B2.

From the perspective of telephone network routing, each B channel appears to be a separate line with its own number and independent dial-out capabilities. Since each has to be dialed or answered separately, they appear to be “lines” to users also. To reduce confusion (hopefully) for non-technical users, we refer to a B channel as a “line” on the Zephyr Xstream’s menus.

SPIDs

Service Profile IDentification numbers (SPIDs) are only required with the Zephyr when you are using the National I-1 or DMS Custom functional ISDN protocols in the USA. This number is given to the user by the phone company and *must be entered correctly* into the Zephyr Xstream in order for the connection to function. SPIDs usually consist of the phone number plus a few prefix or suffix digits. There is frequent confusion between telephone numbers and SPIDs, even among Telco personnel. While the SPID generally includes the corresponding phone number, this is not necessarily the case.

For numerous additional tips on SPIDs, see Section 11 (Detailed menu Reference).

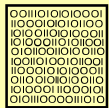

ISDN TIP!

ETS 300 (Euro ISDN) and INS 64 (Japanese ISDN) users should disregard all references to SPIDs. These ISDN protocols do not have SPIDs! If your ISDN configuration uses MSNs, they may be entered in the DN/MSN menu selection of the TEL menu.

If you are using the “National ISDN-1” (Natl I-1) or the “DMS Custom” functional (DMS Cust) protocol, your Telco service representative must give you one or two SPID numbers. You should get one SPID for each B channel you ordered.

Upon power-up, connection of the ISDN line, or reboot, the Zephyr Xstream and the Telco equipment go through an initialization/identification routine. The Zephyr Xstream sends the SPID(s) and, if it is correct, this fact is signaled by the network and “Ready” will be displayed for the status of that B channel. Thereafter the SPID is not sent again to the switch.

Realtors remind buyers that the three most important factors of real-estate success are Location, Location, and Location! We want to remind you that the three most important factors to ISDN success are: Get the SPIDS, **GET THE SPIDS**, please

get the SPIDs!

You must have this number, and it must be 100% correct, or the system won't work. Don't let the installer depart without leaving them. You've been warned!

	<p>HOT TIP!</p> <p><i>Most phone companies in the USA have settled on a standardized SPID format, based on the telephone number. This format is area code+7 digit phone number + 0101. For example, if your phone number was (321) 555-1234 then your SPID would be 32155512340101.</i></p> <p><i>For a list of known working SPID formats, listed by telephone company, see Appendix 4 (Known Working SPIDs by Telephone Company).</i></p>
---	--

	<p>ISDN TIP!</p> <p><i>In an emergency, to save a remote, you might be able to get a line to work without the proper SPIDs by dialing into it. If it works, this fix is only temporary, and the line will fail to initialize next time the Zephyr Xstream is booted.</i></p>
---	---

	<p>ISDN TIP!</p> <p><i>If you see SPID ERROR as your line status, your SPID for that channel is incorrect. In this case check the SPID. For a list of known working SPID formats listed by telephone company see Appendix 4 (Known Working SPIDs by Telephone Company).</i></p>
---	---

Directory Numbers (DNs) and Multiple Subscriber Numbers (MSNs)

Directory Numbers

Directory Numbers, or DN for short, are the 7 digit telephone numbers assigned to the ISDN lines (as would typically found in the telephone *directory*) in the USA & Canada. You may be assigned one or two, depending upon the line configuration. In the case where you have two active ISDN B channels, you will usually have two DN (but not always). However, the "physical" channels (i.e. "time slots") are independent from the "logical" numbers. A call coming in on the second number will be assigned the first physical B channel, if it is not already occupied. Therefore, there must be some way for the Zephyr Xstream to sort out which call goes to which channel/line. The DN is used for this function when the USA ISDN protocols are used.

When a call rings in, it contains set-up information, which includes the DN that was dialed by the originating caller. The last 4 digits are matched with the DN's programmed into the Zephyr Xstream, and the proper assignment is made. Therefore, problems with Directory Numbers will virtually always be difficulties related to receiving calls.

Z

ZEPHYR CLASSIC VS XSTREAM COMPARISON!

Most versions of the Zephyr Classic can operate without Directory Numbers. Zephyr Xstream requires the DNs be present to receive incoming calls.

Multiple Subscriber Numbers (MSNs)

MSNs perform the same function when the ISDN protocol used is ETS 300 (Euro ISDN) or INS 64 (Japanese ISDN). In this case, use of the MSN is entirely optional. If no MSNs are entered, the first call to any of the numbers associated to the ISDN circuit will ring in as "line 1" if that "line" is idle. If "line 1" is in use the call will ring in on "line 2". This is precisely the same behavior as when a line with the "AT&T Custom PTP" protocol is used.

Long-Distance Digital Connectivity

Long-distance connectivity is routinely available in most parts of the USA from carriers such as AT&T, Sprint, and Verizon. Connectivity between any two given points is somewhat variable. The "dial 1+" default carrier may be chosen at the time you order the line, just as with traditional voice lines. Also, just as with voice lines, you may choose a carrier on a per-call basis by prefixing the number with the 1010XXX carrier selection code.

You must dial the full number, including the 1 or 011 + country code following the prefix.

Some long-distance connections are limited to 56kbps/channel. This limitation is becoming more rare. There is no certain way to know in advance. Occasionally, some connections may work at 64Kbps and not 56Kbps. Therefore, you may need to try both.

The Zephyr Xstream provides standard rate adaptation (officially known as 'CCITT V.110') from 56 to 64 kbps and vice versa when required. Bit rate adaptation happens automatically within the Zephyr Xstream depending upon the rate selected by the calling party. Since the Zephyr Xstream cannot communicate at both rates simultaneously, it will ignore rate adaptation information on the second incoming call remaining at the rate set for the prior call.

In our experience, the only sure way to know if a connection given between to particular points will work is to try it, first at 64kbps and then at 56kbps if the higher rate fails.

ISDN TIP!

Not all carriers can handle "Circuit Switched Data" (CSD) connections at all. This type of connection is what makes real-time low-delay audio transmission possible, and is required. For the latest information, check Appendix 10 (Ordering ISDN in the USA & Canada).



**DEEP TECH NOTE!**

The 56kbps limitation arises from a quirk of the older telephone infrastructure. The channel banks that have been widely employed in the long-distance network have a native 64kbps capability, but “rob” the low order PCM bit on every sixth frame in order to convey supervision information (on-hook/off-hook and dial pulses). On voice calls the results is merely a slightly increased noise floor. Therefore, data applications must not use the low order bit, leaving a 56 kbps channel rate.

As new telephone plant is built for clear 64kbps transmission and a technology called “Signaling System 7” is deployed to allow the various elements of the phone network to communicate without using the robbed bits, this limitation has all but disappeared.

The European network has universal full 64kbps capability.

7.3 How to Order ISDN

See Appendix 8 (ordering ISDN:ETS-300) and Appendix 10 (ordering ISDN for the USA & Canada) for additional information and ISDN order forms to send to your Telco.

Dealing with the Phone Company

As is often the case when we broadcasters interface with the phone people, the lines of communication on ISDN can get a little tangled. Face it: we are not the usual customers. The good news is that ordering ISDN is pretty routine these days, and problems are really quite rare. The following information is intended to help if you run into difficulties.

The first order of business is to find someone who knows what ISDN is. While your usual account agent will be the normal entry point, you might need to talk to some other phone company people before you find one who understands your needs. Some of the regional Bell companies offer a single point of contact number for switched digital services. Some Telcos use “Resellers” or “Agents”. If so, you should be sure to ask what experience the particular agent has with ordering lines for high fidelity audio codecs. If in doubt, go direct to the Telco. *And, always order your line in writing using the ISDN order forms in the Appendix of this manual.*

This section is intended to be used as an overview. It is not necessary to understand everything in this section to get an ISDN line for a Zephyr Xstream.

The easiest (and most accurate) way to order the line is to use the appropriate Faxable ISDN Order Form from Appendix 7 or 8 (Ordering ISDN). Appendix 8 also includes a list of contact telephone numbers for many of the regional telephone companies in the USA & Canada.

Details, Details

In order to communicate accurately what it is you need, you might want to learn about the nature of the ISDN service and the vocabulary used to describe it. As with anything, for best results, it helps to know what you are talking about. We already have a good start, but there is more to learn.

CSD and CSV

Recall that each ISDN BRI has two possible B channels. It is possible to order a line with one or both of the B channels enabled – and each may be enabled for voice and/or data use. Phone terminology for the class of service is “CSV” for Circuit Switched Voice and “CSD” for Circuit Switched Data.

CSV is for calls using standard voice phone service and allows ISDN to interwork (i.e. to call) with analog phone lines and phones. *CSD is required for Zephyr connections.* Even though you may be sending voice, the codec bitstream output looks like computer data to the phone network. “Alternate CSD/CSV” or “Alternate voice/data” means both capabilities are supported.



HOT TIP!

While the D channel is always present for signaling purposes, it can, in theory, be used for packet data connections. ISDN lines where the D channel is used for signaling only are sometimes referred to as “2B+0D” rather than “2B+D” service. D channel packet service is not widely available.

Zephyr Xstream allows the option of a voice call on either of the channels as well as the coded hi-fi audio. This capability exists on both channels. Thus, you can make calls to any normal telephone number on one channel while a program is being transmitted on the other. The Xstream even allows you to place two of these voice calls, but then, of course, you would not be able to transmit hi-fidelity codec data, since both channels would be in use.

Calls from a Zephyr Xport that is connected to an analog "POTS" line also use CSV.

Therefore, you will want to order CSV as well as CSD on one or both B channels. Typically, you would order an ISDN BRI 2B+D line with alternate CSV/CSD on both channels. If you don't need voice possibility on the channels, you want 2B+D with only CSD enabled.

NT1s

The ISDN standard specifies two reference points, the ‘U’ and the ‘S’ interfaces.

The U is the single-pair bare copper from the Telco CO. This is sometimes referred to as the “2-wire” interface. A device called a ‘Network Termination, Type 1’ (NT1 or NT-1) converts this to the two-pair S interface. The S interface sometimes is called the “4-wire interface. The NT1 can also be generically be referred to as NCTE (Network Channel Termination Equipment).

Outside the USA & Canada, the NT1 (and NCTE for other types of lines) is nearly always provided by the telephone company, and therefore the S interface must be on user equipment. In some countries, it is referred to as a NTBA (Network Termination Basic Access). In the USA and Canada, the NT1 is usually provided by the user. Therefore, the Zephyr Xstream includes both interfaces. The U interface on the Zephyr Xstream is on a 2-pin 6-position miniature modular plug (RJ-11 style). The S interface is on an 8-pin 8-position miniature modular plug (RJ-45 style).

Refer to manual Section 3 (Guided Tour of the Hardware) for additional information on Zephyr Xstream's built-in NT1.

Zephyr Xstream ISDN Compatibility

Protocols

The Telco network and the Zephyr Xstream communicate via a 'protocol' – the language the user equipment and the telephone network use to converse (on the D channel) for setting up calls and the like. This is where there are differences depending upon the central office equipment used on the line and the standards which are supported by that particular equipment. While each type will work with the Zephyr Xstream, the differences need to be taken into account when lines are ordered and the Zephyr Xstream set up.

In the USA, telephone companies use either AT&T/Lucent 5ESS, Northern Telecom/Nortel DMS-100, or Siemens EWSD switches. Each of these can support the National ISDN 1 (NI-1) protocol standard, which has been specified by Bellcore, the technical lab that was jointly owned by the phone companies. However, both AT&T and Northern Telecom had "custom" versions of ISDN which pre-date the NI-1 standard and a few switches have not been upgraded to the newer NI-1 standard.



CURIOSITY NOTE!

There is also a newer National ISDN-2 (NI-2) standard, but it designed to be compatible with NI-1 for all of the basic functions.

In Europe (as well as much of the rest of the world), the common standard is Euro-ISDN, following the ETS 300 standards. It is an (apparently successful!) attempt for all of the European telephone networks to use a single, compatible protocol.

In Japan, the protocol used is called INS64.

The Zephyr Xstream supports all of these with the appropriate selection of the "Telco" menu-selection in the *TEL* menu, as follows:

TELCO SWITCH	BRI CIRCUIT PROTOCOL	CORRECT TELCO SETTING	NOTES:
AT&T/Lucent 5ESS	Custom PTP (Point-to-Point)	AT&T Cust. (PTP)	No SPIDs (leave blank). One phone number for both channels
AT&T/Lucent 5ESS	National ISDN-1 National ISDN-2	Natl. I-1	SPIDs required Directory Numbers required
NORTEL DMS-100	Custom Functional	DMS Cust.	SPIDs required Directory Numbers required
NORTEL DMS-100	National ISDN-1 National ISDN-2	Natl. I-1	SPIDs required Directory Numbers required
Siemens EWSD (USA)	National ISDN-1	Natl. I-1	SPIDs required Directory Numbers required
JAPAN NTT	INS 64	Ins 64	No SPIDs MSNs may be used (optional)
EUROPE & Others (Various switches)	ETS 300	ETS300	NO SPIDs Used in most countries including Europe, Australia, South Africa, Mexico and most of South America. Multiple terminals frequently share the S interface. MSNs may be used (optional).

Remember, complete information, as well as forms for ordering ISDN, are in Appendices 7 & 8 (Ordering ISDN).

7.4 Switched 56

Switched 56 is a transition technology, which is often available in areas of the USA & Canada where ISDN is not available. As the name suggests, this is a service that permits a single bi-directional digital data stream to be sent at a 56kbps rate. It can use either one or two copper pairs ("2 wire" and "4 wire", respectively), depending upon the particular Central Office configuration. Be sure to determine in advance which service will be provided.

Of course two Switched 56 circuits can be ordered, if transmission of stereo is desired.

In most areas, switched 56 and ISDN are "inter-worked" within the Central Office switches, so that subscribers of both services can connect to each other (at a 56kbps rate, of course).

The Xstream can be used with Switched 56 and other synchronous data services through the optional V.35/X.21 interface and external CSU/DSU(s). We cover more about using the V.35/X.21 interface to interface to Switched 56 CSU/DSUs in Section 9 (The V.35/X.21 Interface).

8 LIVEWIRE™ – IP Audio

8.1 Configuration of the Zephyr Xstream for Livewire

Overview

Livewire can now be used to connect your Xstream to your studio's Axia audio network. Livewire greatly simplifies wiring plus gives you all of the advantages of networked audio to and from your codec.

The Xstream has been improved and updated many times since its original release. A Livewire-capable Xstream will have a version number that ends in 'b' or 'r' and it will have a 100Base-T Ethernet jack on the back. Livewire has been included since the first release on that hardware. You will also notice that these Xstream codecs have grey "Axia-style" web pages.

Older Xstream codes may not be capable of Livewire due to hardware limitations. A non-Livewire-capable Xstream will have a version number that ends in 'i' or 'p' and it will have a 10Base-T jack on the back.

The Zephyr Xstream has three types of local audio connections; analog, AES and Livewire audio (Note: Xstreams with a mixer do not have AES as an option). The audio configuration is established by the front-panel menu of the Xstream. In the "Audio" menu, Input Source selection, you will find these three options. You would normally use Livewire at your studio and analog at the remote site.

In addition to audio connections, you can use Livewire to manage GPIO at your studio location. GPO (output) control is available simultaneously at both rear panel parallel port and Livewire. GPI input mode must be specified as either Livewire or rear panel.

If you are already familiar with Axia's audio nodes, you may think of this new version of the Zephyr Xstream as an "original" Xstream codec with a 2x2 node on the front of it. The LAN port will be used for all Livewire audio connections in and out of the codec. As with all Livewire™ devices, the Livewire streams being delivered to the network require unique ID numbers.

The two most important concepts to understand are:

1. The Livewire™ destinations deliver audio to the inputs to the Xstream codec.
2. The outputs of the Xstream codec (Hybrid Channels) will become the Livewire codec sources to your Axia Livewire network.

The virtual 2x2 node, in combination with the codec, has some unique mono/stereo features:

- If the stream being received by the codec is stereo - both codec outputs (Livewire sources) will be stereo with both delivering identical stereo streams.

- If the stream being received by the codec is dual mono (such as G.722), the decoded audio is split between the two Livewire sources. The first source has the A mono feed replicated on both left and right channels. The second source has the B mono feed on both channels. Thus - when you are using dual mono, you will use both codec outputs as independent Livewire sources.
- Remember, Livewire™ streams are always stereo. In the case of a mono source as described above, the mono data is simply replicated on both left and right channels.
- Dual/Mono TRANSMIT works only in Layer 3 Dual/Mono mode. In Layer 3 Dual/Mono transmit; the left channel of the first destination is used to create the "Channel A" mono feed to be sent over ISDN. The second destination is used for the "Channel B" mono transmit feed. The right channel of each of those streams is ignored.

A Word about Livewire Codec Backfeeds

Backfeeds to a codec in the Livewire™ world are always stereo streams. By default, the right channel of the backfeed is a L/R mono sum of the configured program source (usually PGM1). The left channel is the same L/R sum *PLUS* talkback. The left channel program can be dimmed or muted when talkback is present.

Livewire Configuration Settings

It is important to get the basics configured properly before you attempt to configure Livewire audio. Before we can get to the web pages for configuration of the Xstream, you will need to give the Xstream an IP address from the front panel controls. This process is well covered in Section 11.6 of the User's Manual.

Once you have assigned a unique IP address to the Xstream, it can be connected to your network. To access the web pages, simply launch your favorite web browser and "aim" it at the Xstream by entering the Xstream's IP address in the browser's URL box.

Let's now look at the Xstream's Livewire configuration web pages in detail. Let's start with the important items on the Administration and drill down to the other items in the sequence that you might use to setup your Xstream.

Administration

IP Settings

This is where you will give the Xstream a name and configure the IP settings. The web page looks like this:

The screenshot shows a web browser window titled "ZXS-II (System)". The navigation menu includes: Home | Status | System | Telco | Codec | Audio | Autodial | LiveWire | LiveWire Meters | LiveWire QoS | Administration. The main content area is divided into three sections:

- IP settings:**
 - Host name: (letters and digits only, no spaces)
 - Network address:
 - Netmask:
 - Gateway:
 - NTP server: (takes effect after reset)
- User password:**
 - New password: (5 to 8 characters, letters and numbers)
 - Retype new password: (verify)
- Firmware version:**
 - Hardware revision: rev. 2
 - Primary Bank ver. 3.8.42b (build Fri Oct 24 13:16:15 EDT 2008)
 - Secondary Bank ver. 3.8.42b (build Fri Oct 24 13:37:21 EDT 2008)
 - commit this version to Bank 0
 - Warning: System will reboot after changing current bank.

Host name

A 12 digit, alphanumeric name for this Node that may include hyphens but NOT spaces; those will be converted to hyphens. This name is used to identify the node on the network. You may wish to include the location of the node (studio or rack) in the name for ease of reference. In the example above, we have chosen a simple name of ZXS-II.

Network address (IP Address)

This is the IP address of the Xstream codec. As you might expect, each Livewire device must have a unique IP address. In the example above, we have chosen an address in the 192.168.0.x range. If you are looking at this page, you have obviously already assigned an IP address to the unit and it is connected to the same LAN as your PC. Note that this IP address must be in the same range as your other Livewire devices and the Xstream must be physically connected to the Axia LAN. Otherwise, the Xstream will not be able to send or receive Livewire streams to/from your Axia network.

	<p>IMPORTANT!</p> <p>If you change this unit's IP address, you will lose your browser connection when you click Apply. It will be necessary to reconnect using the new IP address.</p>
---	---

Gateway (Router)

A gateway will be required if you are using the IP streaming method of communicating to another Xstream codec.

NTP Server

An NTP server is optional and not currently required for the Xstream.

User password

By default, the user name is "user" and the password is blank. We suggest you leave it this way until you get everything operating properly.

Firmware version

As with all other Axia devices, the Xstream has two internal memory banks. Each bank contains room for a complete version of operating software. This approach allows a software update download to be completed and checked without danger of making the unit inoperable if the download were to be incomplete or corrupted. It also provides an easy way to try a new software version and return to the old version if desired.

The software version in each bank is displayed here. To change banks simply click in the "radio button" for the desired bank and then click on <Apply>.

	<p>IMPORTANT!</p> <p>The node will reboot after you click Apply if you change the software version. This will result in loss of audio locally, and at any unit using the Xstream's Livewire sources</p>
---	--

Saving Bank 1 Software

New software is always downloaded to Bank 1 (the secondary bank). Downloading software (see below) will overwrite the software currently in this bank, if any. If you wish to save the software currently residing in Bank 1, you can save it by moving it to memory bank 0 by checking and applying the box designated with "**commit this version to Bank 0**". Once you perform this

action, any software version that was previously located in Bank 0 will be replaced by the new, committed version. This action will not cause a reboot.

Livewire QoS

This configuration page provides the settings for Livewire QoS (Quality of Service). In almost all cases, the factory default settings are recommended so you will probably not need to make any changes to this page, particularly to the Audio Stream settings. It is worth noting here that the Livewire clock master priority will be set to either "0 (always slave)" or "3 (default)" and the Livewire clock mode will be "IP low rate (default)".

Detailed information on these settings is provided below. Here is the web page:



Livewire Clock Master

Since a device such as a codec is often powered-down or relocated, the recommended clock priority setting for an Xstream is "0 (always slave)". Here is a bit of background on this topic.

Livewire's clocking system is automatic and largely transparent to end users. By default the Axia hardware node with the lowest Ethernet MAC address will be the clock "master". The system will automatically and transparently switch to a new unit as clock master if need be. We do, however, permit a forced clock master to be assigned to a particular device (usually a node), or to set certain nodes as "preferred" for clock mastership while maintaining automatic operation. For example you may wish to assign nodes that are on UPS power as preferred clock masters. Note that in the automatic modes, a new clock master is designated only when the current master becomes unavailable (adding a new node will not change clock mastership regardless of the new node's setting). The only exception to this rule is the 7 (Always Master) setting.

The following table provides the settings possible for choices Live Clock Priority and provides some information on each of these settings:

0 (always slave) "STL"	Unit will never be master and is only used with Ethernet radios.
0 (always slave)	This unit will never be used as clock master.
3 (default)	The usual and default setting for an 8x8 node.
4 (Secondary Master)	Nodes with this setting will be used as clock masters before those set to 3.
5 (Primary Master)	Nodes set to this setting will be used as clock masters before those set to 4.
7 (Always Master)	This forces a particular node to be clock master, even if another node is currently clock master. If this mode becomes available then the usual prioritization is used.
7 (Always Master) "STL Snake"	This setting forces a particular node to be clock master. Use only when two nodes are connected back to back without an Ethernet Switch.



IMPORTANT!

Only a single node on a Livewire network should ever be set to 7 (Always Master). For this reason we do not recommend using that selection.

Livewire Clock Mode

Provided for compatibility with older revisions:

- IP low rate (default) – recommended setting
- Ethernet – compatible with 1.x firmware
- IP High rate – compatible with 2.1.x master

Receive Buffer Size

This setting determines the amount of buffering in the receiver. Buffering is needed to compensate for jitter in network packet delivery. Usually the biggest source of jitter is a PC using the IP driver. Real-time performance varies a lot from one system to another; some computers can provide very low timing irregularities and allow the receive buffer to be reduced to achieve lower audio delay. The default setting is 100 ms.

801.1p tagging, 802.1p VLAN ID, 802.1q Priority, & DSCP Class of Service

802.1p tagging is necessary within the Livewire network to mark high-priority audio packets. This information is used by the Ethernet switches in the packet scheduling and queuing mechanism. It provides low-jitter packet forwarding of Livewire clock and low-latency audio streams.

On the other hand, Standard streams don't need tagging, because they are not low-latency. By default, standard streams are marked with Type of Service (DSCP code points) information in the IP header which can be used by L3 switches to provide better service to our audio streams than to best effort IP traffic.

There is an option to enable L2 802.1p tagging on standard streams, and this may be used with switches which do not use the DSCP information included in the TOS field of the IP header. We do not enable this tagging by default, because it wouldn't work in cross-over Ethernet connection to PCs; most network cards do not accept 802.1p frames by default.

You should not need to change these default settings unless you are building a system which is not based on our recommendations.

In Axia nodes and the Xstream, the VLAN ID setting is a read-only value. It is always 0 and cannot be changed. As a result Livewire audio always uses the native VLAN assigned to the port of the switch.

"DSCP Class of Service" is a standard describing the tagging of IP frames with service information. Network equipment can be set up to provide different forwarding delay and drop precedence depending on the service information. Our defaults are compatible with most Ethernet equipment defaults for class of service Livewire requires; you should not need to change them unless instructed by Axia Support.

8.2 Livewire Audio Settings

There are two ways to setup Livewire audio, Basic Mode (shown by default) and Expert Mode. The difference between these two modes is that Expert Mode allows you to customize the codec backfeeds. We will take a look at both scenarios.

Livewire Configuration – Basic Mode

This mode will be fully adequate for most users. It assumes the default backfeed for the codec. This is the automatic mix-minus created by the mix engine and will consist of the PGM or AUX bus as configured on your Element or other control surface.

In this example, the sources being delivered to the Livewire network have been identified as ZXS SRC 1 and ZXS SRC 2. These are simply name tags and they can be virtually anything you want. We suggest you make them descriptive and unique so you will be able to easily determine the source if you have multiple Xstream codecs in your facility.

The channel numbers that you specify must be carefully chosen. They must be unique since duplicate channel numbers in a Livewire network will result in multicast collisions and "less than

excellent” audio. You have a channel number range available from 1 to 32,767 so there are lots of numbers to choose from.

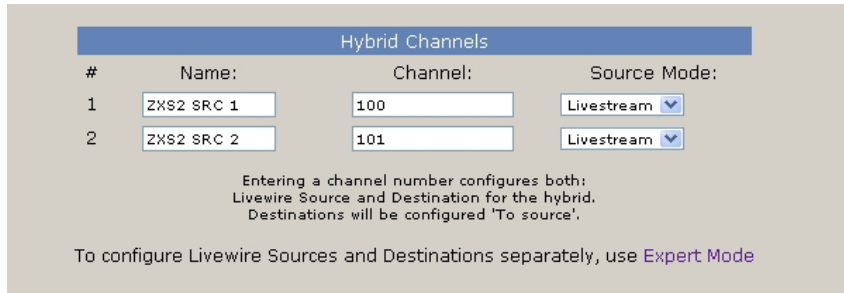

In Basic Mode, the backfeeds will have the same channel number as the source channels and will automatically be configured as “to source”. This ensures that your backfeed consists of a suitable mix-minus that is automatically created by your Studio Mix Engine.

Livewire Configuration – Expert Mode

There may be a case when you want to use something other than the automatic mix-minus as a backfeed. For example, maybe you want to use an AUX bus to create your own custom mix. In this case, you would use Expert Mode to create the setup. Use the destination drop-down boxes to select the Livewire streams that you wish to use as backfeeds to your codec channels. Remember that these destinations are used to designate the audio being delivered to the codec inputs. Select “from source” if the Livewire channel you are selecting is not one of the automatic backfeed channels. Click “apply” and the selected streams will be delivered to the codec channel inputs.



In this example, the channels used as backfeeds illustrate the “normal” settings you would get when Basic Mode is used. Changes can be made to these basic settings as required and applied.

System Settings (GPIO)

This page of the Xstream configuration has the *GPIO input mode* setting.

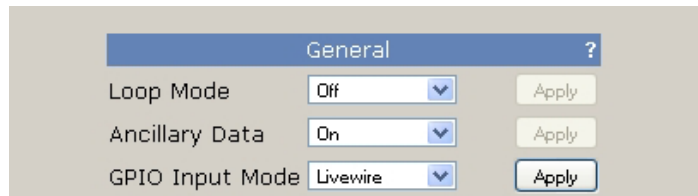

The screenshot shows a configuration window titled "General" with a question mark icon. It contains three settings, each with a dropdown menu and an "Apply" button:

Setting	Value	Action
Loop Mode	Off	Apply
Ancillary Data	On	Apply
GPIO Input Mode	Livewire	Apply

Since Livewire has the capability of “embedded” GPIO, there is often no need for connections to switches as a means of controlling various external functions. You can use Livewire or the traditional parallel port to manage GPIO at your studio location.

GPO (output) control is available simultaneously at both rear panel parallel port and Livewire. GPO is sent to both the back panel and Livewire, and is triggered by the events specified on the System menu.

GPI (input) mode must be specified as either Livewire or rear panel since we can take inputs from the rear panel *OR* Livewire, not both at the same time. GPI comes from either Livewire or the back panel, and triggers the event specified on the front panel Sys menu (or System web-page). This can be either a dial setup or sent through ancillary data to the remote end.

GPIO implementation can be tricky. Please check our web site for new application notes on this topic and other topics that may involve complex configurations.





USER'S MANUAL

9 The V.35/X.21 Interface Option

9.1 Installing the V.35/X.21 Interface option

Some Zephyr Xstream models include the V.35/X.21 interface option. This can be identified by a miniature hi-density 40-pin D connector in interface slot B. The V.35/X.21 option can be easily added in the field as discussed below.

	<p style="text-align: center;">IMPORTANT! WARNING! DANGER!</p> <p><i>Always disconnect AC (mains) power and Telephone Circuit Before removing the Zephyr Xstream's cover.</i></p> <p><i>Potentially lethal voltages are inside! Failure to observe the above warning may result in injury or even death!</i></p> <p><i>Refer all servicing to qualified personnel.</i></p>	
---	--	---

The optional V.35/X.21 Interface (**Telos part # 1701-00006** [old # 9167-0000]) can be installed as follows:

1. Remove power from unit
2. Remove top lid screws (18 or 14 screws) using a Phillips screwdriver. 6 screws top (these will be 1/16th inch Allen-head screws on model MXP), 6 (or 4) screws on each side. Lift cover straight off the unit.

NOTE: Screws on the top surface of model MXP will require a 1/16th Inch Allen wrench to remove.
3. Looking at the rear of the unit, note the Interface slots. Locate Interface slot B. Using a 1/16th Inch Allen wrench, remove slot B cover plate screws.
4. Turn the Zephyr Xstream so the front panel is facing you. Orient the V.35/X.21 option card so that the grey multi-pin connector is facing down and the mounting plate and V.35/X.21 Interface connector is away from you.
5. Hold the option card between the two connectors on the motherboard for slots B and C. Move the card toward the rear panel until the V.35/X.21 Interface connector is protruding through the rear panel opening of the Zephyr Xstream. Lift the card slightly, keeping it parallel with the bottom of the unit, and move it to the right, aligning it with the Slot B connector.

6. Once the connectors are aligned, push the V.35/X.21 option card straight down into the connector on the motherboard. Only moderate pressure should be required to seat the card.
7. Fasten the option card to the rear panel of the chassis using the two 4-40 button head screws previously removed in step 3, above.
8. Replace the lid. If you have a Zephyr Xstream MXP, align the blue bumpers with their corresponding holes.
9. Fasten the lid using the 18 (or 14) screws removed in step 1.
10. To use your V.35/X.21 interface you will need to connect an appropriate cable:
 - For V.35 use **Telos part # 2091-00023** (old #9812-0000)
 - For X.21 use **Telos part # 2091-00024** (old #9822-0000)
11. To enable the X.21 Interface, change the *Interface* menu selection In the *TEL* menu to *V.35 Split* or *V.35 Single* as appropriate for your application.

9.2 Uses for the X.21/V.35 Interface Option

SWITCHED 56

Switched 56 is a transition technology which is being offered primarily in the few areas of the USA & Canada where ISDN is not available. As the name suggests, this is a service that permits a single bi-directional digital data stream to be sent at a 56kbps rate. A switched 56 line requires a *Channel Service Unit/Data Service Unit (CSU/DSU)* to interface the digital line with the Zephyr.

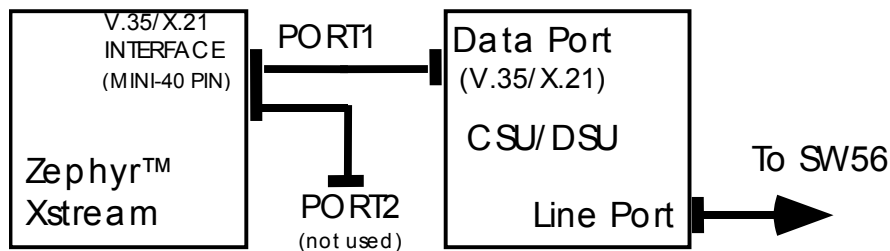

Typical setup for mono configuration. Only one port is used.

Switched 56 comes in two varieties: two-wire and four-wire. The one you need depends upon the service style offered by your telephone company. In many cases, you can purchase this equipment from your Telos Systems dealer. The most popular manufacturer for these Switched 56 CSU/DSUs seems to be:



Adtran
901 Explorer Ave
Huntsville, AL 35806
800-827-0807
www.adtran.com

Adtran makes all sort of equipment for the telecom industry. The Telcos buy equipment from Adtran. Reputable company. Most USA Telos Dealers carry Adtran equipment.

An appropriate CSU/DSU (*Channel Service Unit/Data Service Unit*) is required to interconnect the line with the Zephyr Xstream. Dialing is performed using the CSU/DSU directly. Popular models are the Adtran DSU III S4W (for 4 wire circuits, **Adtran part # 1202013L1**) and DSU III S2W (for 2 wire circuits, **Adtran part # 1200015L2**) see www.adtran.com or your Adtran dealer.

Adtran also makes CSU/DSU's for use with dedicated 56 or 64kbps circuits. See below.

If the location with Switched 56 is only to be used temporarily, you might wish to rent the CSU/DSU rather than purchase one. One rental source is:

Silver Lake Audio
90 South Long Beach Rd
Rockville Centre, NY 11570
516-763-1776
www.silverlakeaudio.com

In most areas, switched 56 and ISDN are "inter-worked" within the Central Office switches, so that subscribers of both services can connect to each other (at a 56kbps rate, of course). Therefore, the far end unit may be on ISDN or Switched 56.

If two Switched 56 circuits are available (as well as two CSU/DSU's) Stereo or Mono 128 operation is possible.

T1 Circuits

This permits subscriber access to up to 24 channels of 64kbps each. T1 circuits into the dial up network are frequently used with private telephone systems (i.e. PBXs). However, dedicated T1 service between two locations is available. This option has become increasingly popular for STLs.

T1 requires a special *Multiplexer* or *DSU* (available from Adtran and others) to break out the individual channels. These are usually modular, permitting each channel (time slot) to be used individually as desired.

Each Zephyr Xstream would require 1 or 2 channels for bi-directional mono and stereo, respectively, if the *V.35 split* mode were used. In that case, each channel would be broken out by the multiplexer into a separate V.35/X.21 port.

Or a single 112, 128, 256, Or 384 kbps connection can be used, if the Xstream *V.35 single* is selected for the *Interface* in the *TEL* menu. See Appendix 6 (Special Operational Modes) for more on *V.35 Single* operation.

These configurations would be similar to using DDS lines (see below), however it gives the remainder of the T1 capacity for some other purpose between the two sites in question.

	<p>DEEP TECH NOTE!</p> <p><i>If you can afford a full T1 for your application, then you should be considering options that do not require use of audio compression.</i></p> <p><i>We recommend that option for STLs and other critical audio paths. Equipment is available from a variety of vendors to allow uncompressed audio transmission over T1 circuits.</i></p> <p><i>Zephyr Xstream's V.35 Single offers audio connectivity at an intermediate cost while offering the high fidelity and robustness possible with MPEG at low compression ratios.</i></p>
---	---

	<p>HOT TIP!</p> <p><i>When ordering dedicated lines, such as DDS or T1, which will not be used for interstate access, be sure to file an "Interstate Access Charge Exemption Form". This should result in significant savings in monthly fees.</i></p>
---	---

Digital Data System (DDS)

A DDS circuit is a dedicated, "nailed-up" connection between two specific locations. Also referred to as dedicated digital service. Technically, DDS service includes rates up to 56kbps. Two such lines can be used to provide stereo audio. However, "dedicated digital lines" are also available at higher rates such as 64kbps. In Europe we've even seen 128kbps dedicated lines.

Use of this service requires an appropriate CSU/DSU (*Channel Service Unit/Data Service Unit*) at each end to interconnect the line with the Zephyr Xstream. One popular model is the Adtran DSU 56/64 (**Adtran part # 1200062L1**) see www.adtran.com or your Adtran dealer.

Other Possibilities

Any transmission channel that can convey synchronous digital signals in real time, may be used with the Zephyr Xstream. Possibilities include T1, satellite links (Including the portable Inmarsat terminals), spread-spectrum RF transmission systems, and ATM. The error rate should be 1 e-7 or less. The communications equipment must support V.35 or X.21. An adaptor cable may be required if this equipment does not support the usual connector. The Xstream expects this communications equipment to provide a clock on the X.21 or V.35 connector.

When considering a technology (such as ATM) it is essential that your service has a "Committed Information Rate" equal to the required bit rate (i.e. 56, 64, 112, 128, 256, or 384 kbps) and that it is a "Constant Bit Rate" service.

9.3 Hook-Ups to Non-ISDN Synchronous Networks

The V.35/X.21 Connection

If present, the V.35/X.21 interface is supplied in slot B slot, looking from the rear. It permits connection to transmission paths other than ISDN. It may also be used with external ISDN Terminal Adapters in the (rare) case where the available ISDN service is not compatible with the Zephyr's internal TA, or for emergencies.



CURIOSITY NOTE!

You might wonder why the much more common RS-232 is not used. Answer: V.35 is synchronous, meaning that the bit clock is transmitted between the two ends.

RS-232 is typically used for self-clocking (asynchronous) applications, and requires overhead start and stop bits, slowing and chopping the bit flow. And, just as with audio, balanced transmission is more reliable in a noisy environment, or in one which has ground potentials at differing levels.

V.35 is a standard for connecting to synchronous digital data paths. Like RS-232, it defines signals and (not officially) connectors and pin-outs so that equipment from various manufacturers may talk with each other. The usual connector is a big boxy AMP type, which was chosen by AT&T decades ago. Most terminal equipment sold for the US market supports the V.35 standard (although an adapter cable may be required to connect to the usual connector). The following Signals are provided at the V.35 end of the Telos cable:

V.35 CONNECTOR PIN-OUT		
Pin	Description	Direction (Xstream ◀▶ DCE)
B	Ground	
C #	RTS (Request to Send)	▶
F	CD (Carrier Detect)	◀
H #	DTR (Data Terminal Ready)	▶
P *	TX Data	▶
R	RX Data	◀
S *	/TX Data	▶
T	/RX Data	◀
V	RX Clock	◀
X	/RX Clock	◀
Y	TX Clock	▶
AA	/TX Clock	▶

* Xstream does not support separate TX and RX clocks. RX Clock signal is sent out as TX Clock.

RTS and DTR are permanently asserted "true".



DEEP TECH NOTE!

The standard uses electrically balanced transmission for both clock and data (but not for the special auxiliary signals, which are identical to RS-232). The transmit voltage level is ± 5.5V, but receivers must handle wider swings.

X.21, a more modern standard, is also used for connections to synchronous digital data paths. This standard specifies the much more reasonable DB-15 connector. Fortunately, it is possible to design an interface that accepts both V.35 and X.21 signals. This we have done with the Zephyr Xstream, allowing connection to both types just by changing the interconnect cables. The X.21 standard is frequently seen in Europe and other areas outside the USA & Canada. The following Signals are provided at the X.21 end of the Telos cable:

<i>X.21 CONNECTOR PIN-OUT</i>		
Pin	Description	Direction (Xstream ◀▶ DCE)
2	TX Data	▶
3 #	RTS	▶
4	RX Data	◀
5	CD (Carrier Detect)	◀
6	Clock	◀
8	Ground	
9	/TX Data	▶
10 #	/RTS	▶
11	/RX Data	◀
13	/Clock	◀
# RTS and DTR are permanently asserted "true".		

CSU's and DSU's

CSU. Channel Service Unit. DSU. Data Service Unit. This is what the interface between the Zephyr and digital channel is usually called. It converts the signals from the telephone line to the

required V.35 or X.21 standard and in the case of Switched-56 provides dialing capability. (Some have keypads and LCD displays for this function; others rely upon external computer control.)

The designation DSU is most often used when terminating Switched-56 lines. Modular DSU's are also used within a **Multiplexer** to break out the various paths. Originally, the CSU and DSU were separate pieces of equipment. Today however, the equipment sold for use on DDS lines is nearly always an integrated piece of gear variously referred to as a CSU, DSU, CSU/DSU, or a DSU/CSU.



DEEP TECH NOTE!

In the old days a CSU (Channel Service Unit) was used to terminate the digital circuit (to use the generic term, it was the NCTE or Network Channel Terminating Equipment).

One or more DSUs (often in the form of plug in cards) were used to provide the interface to the terminal equipment. These days the 2 devices are nearly always combined and are variously referred to as CSUs, DSUs, CSU/DSUs, and DSU/CSUs! We prefer CSU/DSU and will use that term.

Note that the Telos web site (www.telos-systems.com) includes a glossary if you need help with any of the other terms.

Cables

The Zephyr Xstream connects to digital transmission channels via the ports from the V.35/X.21 interface module.

The cables available from Telos, connect to standard terminal adapters or CSUs, which, in turn, connect to the digital network channels. The design of the port electronics permits interface with either V.35 or X.21 equipment – the connector style and pin-out is the only difference.

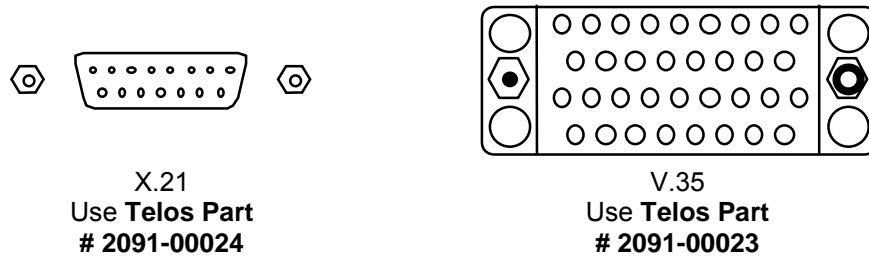

You can tell whether you have V.35 or X.21 by looking at the connectors. These are the "footprints" of the two types to help you select the proper Telos cable to interface to your datacom gear.

Each V.35/X.21 connection conveys both send and receive digital signals.

The V.35 or X.21 cable from Telos includes two V.35 or X.21 plugs. This two-port cable may be used for single-port applications by simply letting the unused plug (usually port 1) go unconnected.

The compact plug at one end of the cable snaps onto the mating connector on the Zephyr Xstream with a locking action. To release the plug, the two pushbuttons at either end of the plug housing are pressed simultaneously and the plug is withdrawn.

	<p>IMPORTANT!</p> <p><i>We had to use a small socket in order to make more room on the rear panel (sorry), so you cannot plug directly into it with off-the-shelf cables. You must have the appropriate cable from Telos to connect!</i></p> <p><i>The Xstream uses the same cables as the Zephyr.</i></p>
---	---

The V.35/X.21 interface, while a single physical plug, has two electrical ports, of which one or both may be used.

The plugs at the other end are labeled "PORT 1" and "PORT 2" and are connected to the TA/CSU as follows:

One Port Operation

- For one-port mono operation, only the PORT 1 plug is used. It connects to the TA/CSU V.35/X.21 socket.
- In the mono 64 modes, only one V.35/X.21 connection is required. Audio channel A corresponds to PORT 1 and audio channel B corresponds to PORT 2 (usually not used in this case).

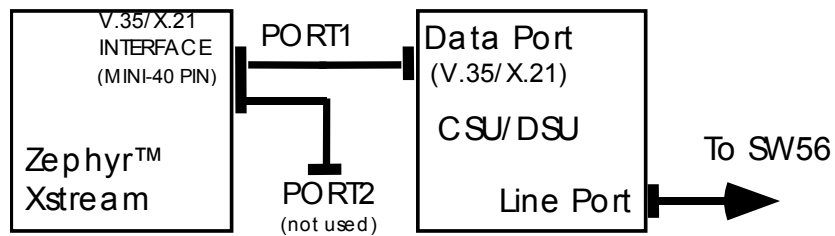

Single port operation supporting 56 or 64 kbps for mono operation on a single V.35/X.21 port.

Interface in the TEL menu should be set to "V.35 Split"

- For high bit-rate applications using one port

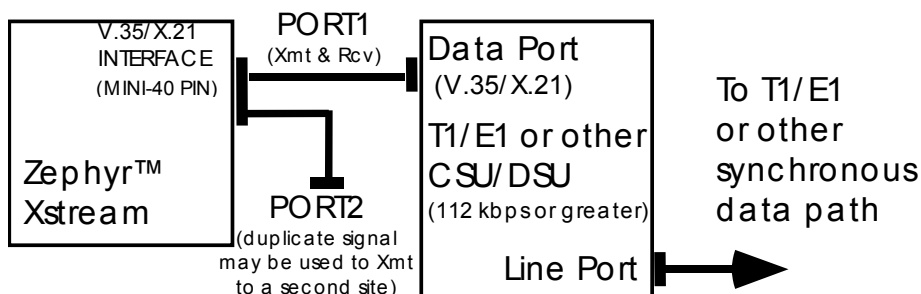

Single port operation supporting 112, 128, 256, or 384 kbps for operation on a single V.35/X.21 port. The **Interface Selection** in the **TEL** menu should be set to "V.35 Single." The **second port can be used to send an identical audio stream to a second site if desired.**

	<p>HOT TIP!</p> <p>Layer 2 and AAC support operation at bit rates up to 384 kbps (4:1 compression ratio for stereo). Layer 3 supports bit rates up to 256 kbps.</p>
---	--

Split Operation using both ports

- For two-port operation using inverse multiplexing, two digital transmission paths are required, so both the PORT 1 and PORT 2 plugs mate to the TA/CSU digital connections. The TA/CSUs may be separate for each path, or may be a single unit with two data ports. In Stereo and J-stereo the system automatically sorts out which channel is which and therefore it is irrelevant which plug goes to which port. See below for when Mono/Dual modes are used.

	<p>HOT TIP!</p> <p>When troubleshooting configurations using V.35/X.21 split operation using both ports, keep the following in mind:</p> <ul style="list-style-type: none"> In L3 Dual/Mono Xmt mode channel A audio will be coded and sent out PORT 1 and channel B audio will be coded and sent out PORT 2. If the receiving unit is put into L3 Dual/Mono Rcv mode it will be receiving from both ports independently. <p>Therefore, by observing which audio channel experiences audio drop-outs, you can determine where to look for problems.</p> <p>By systematically switching cables, TA/CSUs, and lines, you will be able to isolate the problem to a single line or piece of equipment, by seeing if the dropouts change channels as equipment is swapped.</p> <p>NOTE: Be sure to switch the units back to J-Stereo or Stereo operation once troubleshooting is complete. The Dual mode does not match phase between the two channels, and is not intended for stereo material.</p>
---	--

Z

ZEPHYR CLASSIC VS XSTREAM COMPARISON

Since the Zephyr does not have the L3 Dual/Mono Receive mode, data corruptions on either data channel will cause dropouts on both audio channels. Therefore, Zephyr users performing troubleshooting tests would need to switch to mono operation, over a single data channel, to verify each channel separately.

- For two-port operation in the Dual/Mono mode, audio channel A corresponds to PORT 1 and audio channel B corresponds to PORT 2, when both are used.

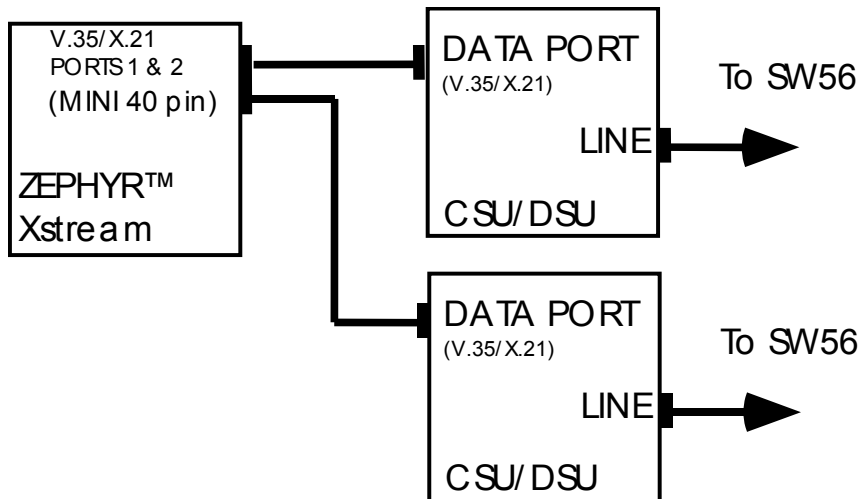

Two port operation supporting 56x2 or 64x2 kbps for mono 128 or Stereo operation using both V.35/X.21 ports. The **Interface** selection in the **TEL** menu should be set to "V.35 Split"

Control Leads

There are a number of "control leads" defined in the V.35 and X.21 standards. CSU/DSUs will frequently have indicator lights showing the status of these signals, which may be useful when troubleshooting problems.

In the direction Zephyr Xstream -> TA/CSU, the Xstream provides DTR (*Data Terminal Ready*) and RTS (*Request to Send*). Both of these signals are made active when the V.35 interface is selected and the Zephyr Xstream is ready for operation.

HOT TIP!

Since the data is generally clocked from the master clock at the Telco anyway, handshaking is unnecessary. Timing variations between the various handshake signals varies and may cause equipment incompatibilities. If this occurs, it is entirely ok to disable handshake signals on the CSU/DSU using the appropriate DIPswitch or command.



In the direction CSU/DSU -> Zephyr Xstream, only CD (*Carrier Detect*) is implemented. This signal is used to tell the Zephyr Xstream which port/channel has been connected and activated. It is used for internal selection of the network clock source. When the *TEL* menu selection *Interface* is set to "V.35" the *TEL* status screen will indicate "Inactive" or "Active" depending on whether the CD signal is present for that channel. NOTE that at any given time only one of the V.35 signals is providing clock which is used for both ports. Therefore both V.35 sources must be at the same clock frequency (which is generally the case since Telco's use highly accurate clock sources for all of their gear).

Configuring CSU/DSUs

There will generally be at least two main configuration menus. One for interface to the DTE (Data Terminal Equipment) and one for the interface to the "loop" or "line". Your CSU/DSU manual (or manufacturer) should have information on the correct settings for the various options.

DTE Options:

Set to "Synchronous" and set the bit rate to match the Zephyr Xstream's and line's bit rate (usually 56kbps). If necessary, you may disable any handshaking signals by setting them to "forced" or "ignored" since handshaking is not required with synchronous data. "Anti streaming" or "scrambling" options should be disabled.

Loop or Line Options:

Set to the speed of your line (usually either 56 or 64kbps). The Xstream's *CODEC* menu option *Bit Rate* must be set to the same rate as the line. Your Telco or CSU/DSU manual should be able to give you the correct setting for any other options.

Clock Options:

It is essential that the clock option be set to "network" or "from loop". The Xstream will clock its synchronous data to the clock from the CSU/DSU. In order to prevent buffer overflow or underflow, the far end unit must share the same clock. The only way to ensure this, is for each CSU/DSU to derive its clock from the network (i.e. from the line itself). The CSU/DSU must not derive clock from the V.35 port.



DEEP TECH NOTE!

In cases where "dry line" modems are used one end can use a local clock (master) and the other end (slave) can derive timing from the far end by using loop timing.

If a dual port scenario is to be used with these modems, the second modem at the master end would need to be slaved using the clock connections on the V.35 ports of these two units. It can be done, but you will need to fabricate a special cable to do so.



Channel Assignment:

DSU's for use with T1 or E1 will have a menu that determines which channel(s) should be brought out (or aggregated and brought out) to each V.35 port. This will need to be set on each end.

If you are using a fractional T1 or E1 you will need to know which channels are active. The Telco can give you that information.

10 APPLICATIONS GUIDE – Hints & Ideas

Of course we hope that you will (eventually) read through the other sections of this manual – we give you a lot of information about audio coding technology and lots of information on how and when to use the different coding modes. However, here we have included the following informational guide to get you started.

10.1 Xstream Versatility – types of dial-up connection and modes

The Xstream is the most versatile codec platform on the market at this time, communicating with a variety of devices in several ways. In this section, we'll give a review of the different modes available when on ISDN, illustrating the various capabilities of the unit.

First, let us look at a matrix of the Xstream's abilities:

DIAL MODE	TALKS TO	NETWORK CALL TYPE	CODEC	# OF CONNECTIONS POSSIBLE	NOTES
<i>ZEPHYR</i>	Most ISDN Codecs	Circuit Switched Data (CSD)	Various, as selected	2, using <i>L3 Dual</i> or <i>G.722</i>	Maybe be mixed with a <i>Phone</i> mode call
<i>XPORT</i>	Zephyr Xport on POTS line	Circuit Switched Voice (CSV)	G.711 or aacPlus (ZXP to ZXS) + AAC-LD (ZXS to ZXP)	1	DSP modem uses G.711 (A-Law/ μ -Law)
<i>PHONE</i>	POTS Telephone or Coupler	Circuit Switched Voice (CSV)	G.711 (A-Law/ μ -Law)	2	Maybe be mixed with a <i>Zephyr</i> mode call
<i>ETHERNET HTTP</i>	Desktop player codecs	IP	AAC or L3	Depends on bitrate	Legacy pull-only
<i>ETHERNET RTP</i>	Xstream	IP	AAC or L3	Depends on bitrate	Push-only
<i>ETHERNET SIP</i>	Xstream	IP	AAC or L3	1	Bi-directional

The matrix shows the appropriate *Mode* to use when placing outbound calls, however the unit can receive all these same call types, of course. Since the *Zephyr* mode supports a number of different codecs (for differing user requirements, as well as compatibility with other codecs) the *Xmt*, *RCV*, and *Sample* settings must be configured, as well as using the correct call type when using this mode.

Xstream ISDN to ISDN Connection Examples:

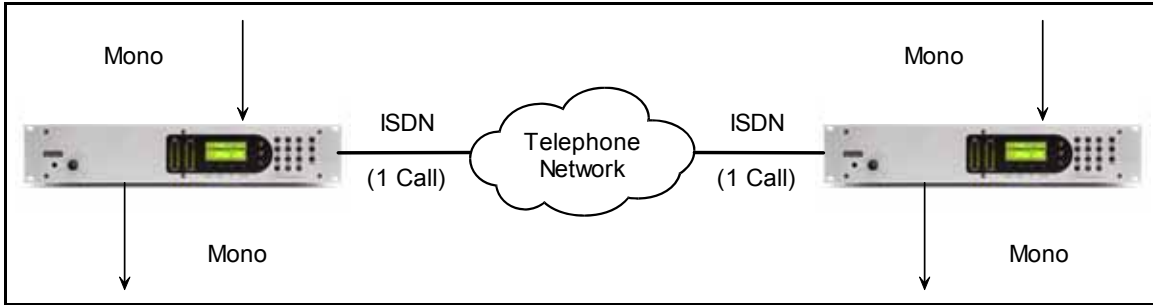

The basic Mono 56 or 64 kbps ISDN codec connection is shown above. The audio quality is dependent on the settings in the CODEC menu. ISDN is used end-to-end for the best quality and lowest delay.

When using MONO modes the channel A inputs and Line 1 are used.

The dialing MODE for this call is Zephyr.

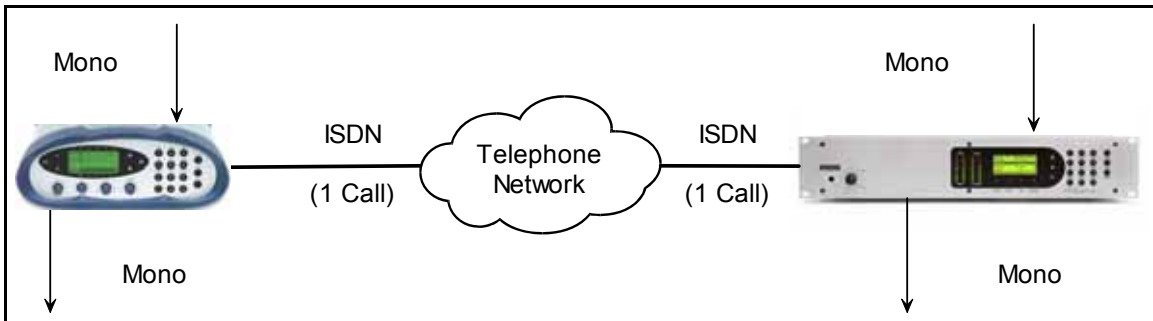

The call between an Xport on ISDN and the Xstream is similar to the above case. In this case the Xstream would be set to AAC-LD Mono-64 @ 48kHz. No configuration of the Xport is necessary.

The dialing MODE for this call is Zephyr.

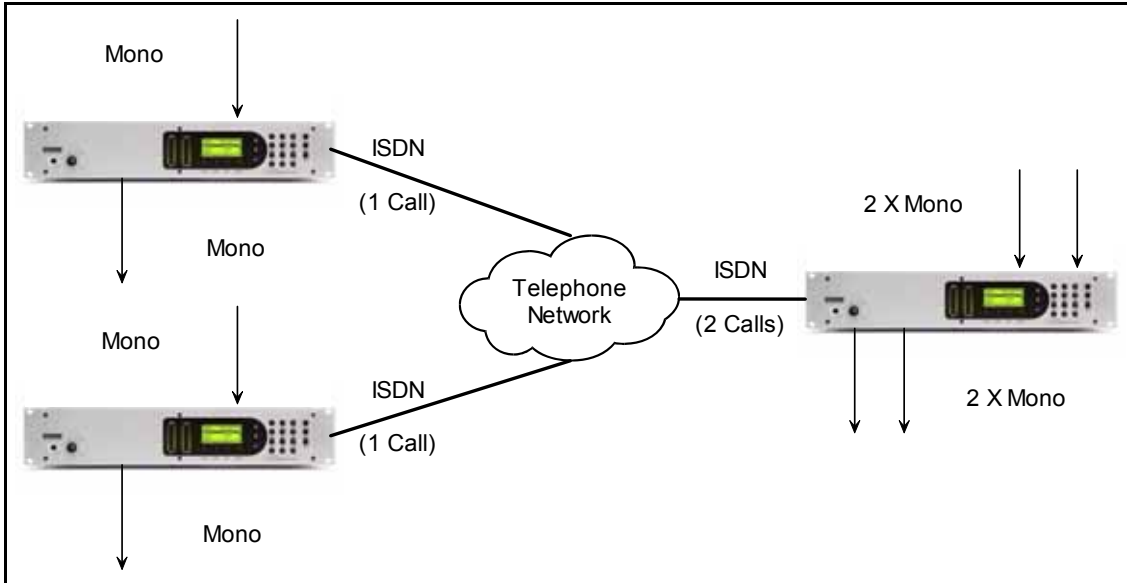

Dual mode operation allows a "central" codec to connect to two "remote" codecs simultaneously. Dual operation is available in both Layer 3 and G.722.

The remote codecs generally would both use the A inputs and outputs and Line 1.

The central codec will use the A inputs and outputs to communicate with the remote site connected to Line 1, and the B inputs and outputs to communicate with the remote unit connected to Line 2.

The dialing MODE for these calls is Zephyr.

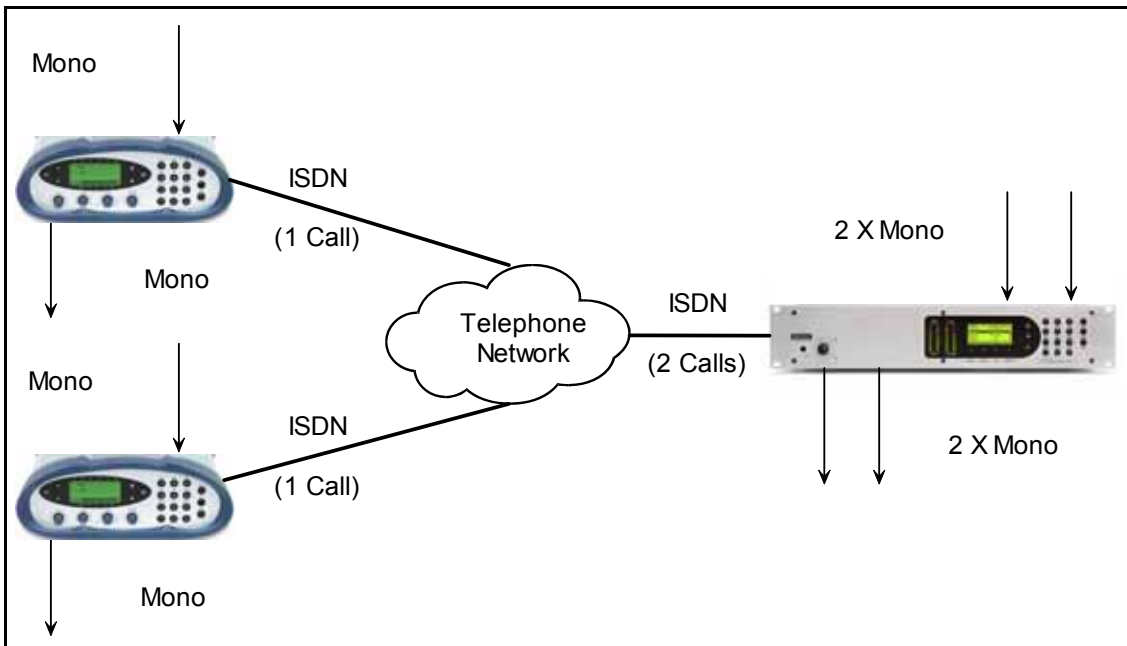

This example is the same as the above, only the connection shown is with Xports as the field. In this case, G.722 would be used.

The dialing MODE for these calls is Zephyr.

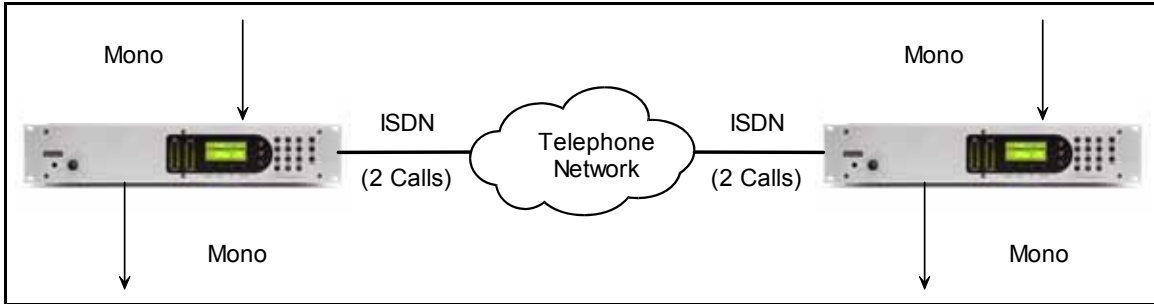

The basic Mono 112 or 128 kbps ISDN codec connection is shown above. The audio quality is dependent on the settings in the CODEC menu. ISDN is used end-to-end for the best quality and lowest delay.

In Mono 128 modes, the channel A input is used.

The dialing MODE for these calls is Zephyr.

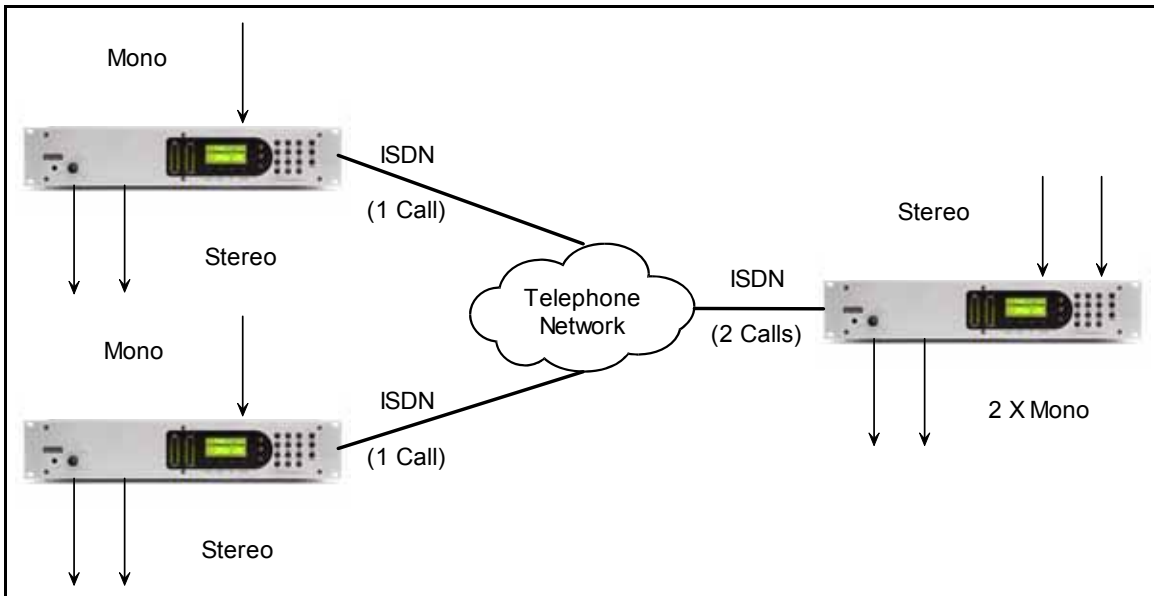

The Stereo 64 mode is a special case. In this scenario a central codecs sends the same stereo audio to two sites. The remote-to-central return path is mono and can be L3 or G.722.

The dialing MODE for these calls is Zephyr.

Xstream POTS to ISDN Connection Examples

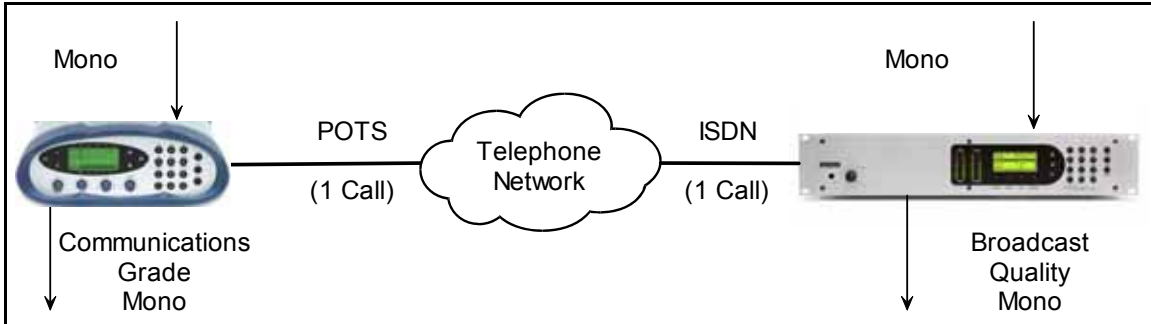

The "integrated services" of ISDN means ISDN line can communicate with POTS lines. This arrangement means that the connection is mostly digital, with only the POTS line analog, thereby giving better performance.

The dialing MODE for this call is Xport. No other configuration is required in this case.

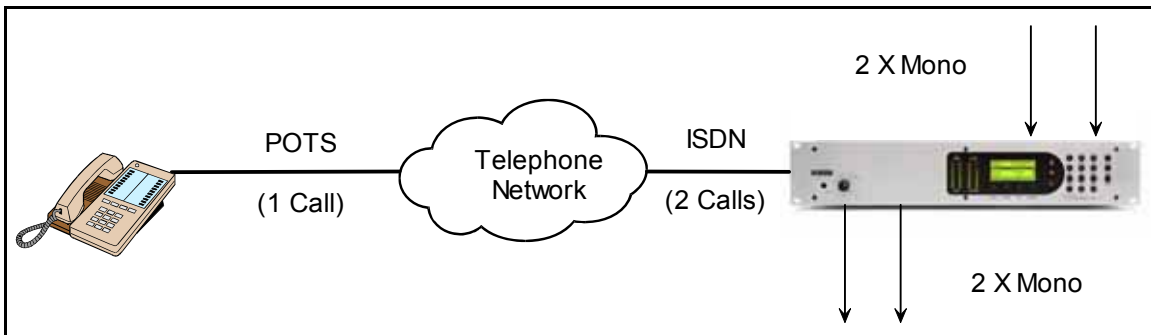

The Xstream can also act as a digital telephone coupler.

The dialing MODE for this call is Phone. No other configuration is required in this case.

10.2 Choosing the Best Transmit Mode for your application

FIDELITY versus CODING METHOD versus DELAY – A quick comparison

We have listed the different modes here in approximate order of delay. See Section 6 (Audio Coding Reference) for more information on the Quality and Delay of the various coding methods.

G.722

Offers 7kHz audio frequency response at moderate fidelity. It operates at 56-64kbps per channel. Sample rate is 16kHz. The frequency response is 7.5 kHz. G.722 was originally designed for “enhanced” telephone applications. It is widely supported by other codecs. It’s very low delay (less than 20 msec) makes this coding method very popular for cueing or foldback (IFB) channels.

AAC-LD

AAC-LD offers fidelity equivalent to Layer-3 with very low delay (about 70 msec). It is an excellent choice for situations where live interaction is required.

AAC-LD offers 14 kHz audio frequency response.

AAC

AAC offers Layer-2 quality at 50% of the bit rate. The fidelity of stereo at 128kbps meets the ITU (International Telecommunications Union) criteria for "Indistinguishable Quality" for stereo transmission. The delay is quite low, at less than 1/5th second.

AAC should be used whenever it is supported at both ends.

Offers 15 or 20 kHz audio frequency response, at 32 or 48 kHz sample rate, respectively

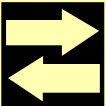
	<p>COMPATIBILITY TIP!</p> <p><i>Zephyr Xstream supports both 32kHz and 48kHz sample rate for Layer-2 in the following modes. The majority of Layer-2 codecs deployed in the field (including the Zephyr Classic) support the 48 kHz sample rate only.</i></p> <p><i>The Layer 2 Mono/Half mode allows operation at 24 kHz sample rate, however the delay is significantly increased.</i></p>
---	---

Layer-2

L2 Mono 64 & L2 Stereo– Offers 7.8kHz (at 56kbps) or 9.8 kHz (at 64kbps) at moderate fidelity. Sample rate is 32 or 48kHz. It is generally preferred over G.722 for music, but not always for voice. Sibilance causes obvious artifacts. When the 48 kHz sample rate is used, the delay is moderately low (1/4 second for stereo, 1/10 second for mono) however the increased

compression ratio required to accomplish this task pushes the Layer-2 coding to the limit, with obvious artifacts present.

L2 Mono-128 – Offers 20kHz or 15 kHz frequency response at very high fidelity. It operates at 112-128kbps. Sample rate is 48kHz or 32 kHz. By using both ISDN B channels for mono, you get an improved fidelity mono, however this causes the delay to increase to slightly over 1/4 second. The low compression ratio also makes this mode ideal for scenarios where the audio is likely to go through additional coded audio links later in the transmission chain. This mode is the defacto standard for voice-work transmissions.

This mode should be used for critical mono material when the far end site does not support MPEG AAC.

Layer-3 Modes

Layer-3 Dual/Mono (this is 2 channels of mono. You can send them to separate sites, if you wish) This mode offers 15kHz (using 32kHz sample rate) or 16kHz (using 48kHz sample rate) at high fidelity. Fidelity is better using the 32kHz sample rate as this reduces the compression ratio. It operates at 56 – 64 kbps per audio channel. Layer-3 coding allows high fidelity transmission while using only one of the ISDN B channels. Delay is longer than the other single B channel methods at over 1/4 second. If you can only afford to use one B channel (or have a single Switched-56 line) then this mode offers you better fidelity than any other, unless the far end supports MPEG AAC (see above).

L3 Mono 128- Offers 22kHz mono when using the 48 kHz sample rate and 15 kHz at the 32 kHz sample rate. This mode offers a reduced compression ratio, and consequently better resilience to artifact caused by future coding cycles. It operates at 128 or 112 kbps depending on the *Bit Rate* selected in the *CODEC* menu.

Z	<p>Zephyr VS Zephyr Xstream !</p> <p><i>Zephyr does not offer Layer 3 Mono 128 operation (although the Joint-stereo mode can be used as a substitute for it).</i></p> <p><i>However, the Zephyr can decode the Xstream's Layer 3 Mono-128 streams. Set the Zephyr to L3 Stereo Rcv.</i></p>
---	---

Layer-3 J-stereo - Offers 15kHz (using 32kHz sample rate) or 16kHz (using 48kHz sample rate) at high fidelity. Fidelity is better when using the 32kHz sample rate as this reduces the compression ratio. It requires at 112 – 128 kbps. Because this mode exploits the typical center redundancy present in most stereo material, fidelity is improved as compared to Layer-3 Stereo (at 112 – 128 kbps) or L3 Mono (at 56 – 64 kbps). Delay is longer than the single B channel methods, at nearly 1/2 second. This mode offers the best fidelity Stereo available using a single ISDN BRI circuit, unless the far end supports MPEG AAC (see below).

That is the end of our quick overview. Note that a higher sample rate does not necessarily offer better fidelity (due to the increased compression ratio) but it *does* decrease delay.

Also note that Layer-3 has more delay than Layer-2 which has more delay than AAC. AAC-LD follows with G.722 having the shortest delay.

Note that *for a given bit rate and sample rate*, that AAC offers the best fidelity, followed by Layer-3 and AAC-LD, followed Layer-2, and finally by G.722.

As a Zephyr Xstream user, you have the best of all worlds. Layer-2, Layer-3, and G.722 offer backwards compatibility with older codecs, while AAC and AAC-LD allow better quality or reduced delay.

10.3 Applications Guide

Voice-over applications on a single B channel (1 call)

Good:

Use *L3 Dual/Mono* Transmit - Far end would use *L3 Mono* (Zephyr) or *L3 Dual/Mono* (Zephyr Xstream) Receive.

Use 32kHz sample rate for best fidelity.

Best Quality:

Use *AAC Mono 64* transmit - Far end should use *AAC 64* for Receive

Voice-over applications using two B channels (2 calls)

Good:

Use *L2 Mono 128* Transmit – Far end should use *L2* Receive (Zephyr or Zephyr Xstream) at 48kHz sample rate.

Better:

Use *L3 Mono 128* Transmit – Far end should use *L3* (Zephyr Xstream) or *L3 Stereo* (Zephyr) Receive.

Use the 32 or 48 kHz sample (both ends must match).

Best:

Use *AAC Mono 128* Transmit – Far end should use *AAC* Receive.

Either 32 or 48 kHz can be used for the sample rate (must match on the both ends).

Voice-over applications communicating with non-Telos codecs

Most Common:

G.722 is the most commonly available coding mode in the world. Use *G.722* for your *Transmit & Receive* modes. Note: Since the quality of G.722 is only moderate, you should only use this mode with clients who do not have a better option available. One B channel (1 call) required for mono.

Most Popular:

MPEG Layer-2 Mono 128 seems to be the defacto standard used in the voice Industry. Set your *Transmit* to *L2 Mono 128* and your *Receive* to *L2*. Two B channels (2 calls) required.

Use 48 kHz sample rate

Radio remotes (Mono) using a single B channel (1 call)

Good:

Field unit: *L3 Dual/Mono* Transmit and *G.722* Receive

Studio unit: *G.722* Transmit and *L3 Dual/Mono* Receive (Zephyr Xstream) or *L3 Mono* (Zephyr)

Use 32 kHz sample rate for best fidelity, or 48kHz sample rate for reduced delay⁵.

Better:

Field unit: *AAC-LD Mono 64* Transmit and *G.722* Receive

Studio unit: *G.722* Transmit and *AAC-LD* Receive

This option has low round-trip delay with fidelity comparable to Layer-3⁵.

Use 32 kHz sample rate for best fidelity or 48 kHz for reduced delay.

Best:

Field Unit: *AAC Mono 64* Transmit and *G.722* Receive.

Studio Unit: *G.722* Transmit and *AAC 64* Receive

This option has better fidelity than the *AAC-LD*, but longer delay.

Use 32 kHz sample rate for best fidelity or 48 kHz for reduced delay⁵.

⁵ We know that this statement seems contradictory. The sample rate determines the "frame rate" through the Xstream's DSP. Therefore, higher sample rates result in reduced delay.

However, the higher sample rate also increases the amount of raw data. This requires a higher compression ratio to get the data to the target transmission rate. Therefore using the increased sample rate may cause more audible artifacts, as compared to a lower rate.

When full fidelity is needed in both directions:

Field Unit: *AAC-LD Mono 64* Transmit and *AAC 64* Receive.

Studio Unit: *AAC-LD Mono 64* Transmit and *AAC 64* Receive

Use 32 kHz sample rate for best fidelity or 48 kHz for reduced delay⁵.

Radio remotes where only POTS is available at the remote location

Best:

Field Unit: Zephyr Xport

Studio Unit: Zephyr Xstream

Dial using "Xport" mode

Radio remotes (Stereo) using a single B channel (1 call)

Good:

Field Unit: *AAC J Stereo 64* Transmit and *G.722* Receive.

Studio Unit: *G.722* Transmit and *AAC 64* Receive.

Use 32 kHz sample rate.

When best stereo is needed in both directions:

Field Unit: *AAC J Stereo 64* Transmit and *AAC 64* Receive.

Studio Unit: *AAC J Stereo 64* Transmit and *AAC 64* Receive

Use 32 kHz sample rate

NOTE: If a single return feed is required, any other single-B channel mode (typically AAC-LD, or G.722, see above) can be used in the return direction for improved fidelity or reduced delay.

Radio remotes (Stereo) to two sites using a two B channels (2 calls) with one return from each.

Good:

Field Unit: *AAC J Stereo 64* Transmit and *G.722* Receive.

Studio Units: *G.722* Transmit and *AAC 64* Receive.

Use 32 kHz sample rate.

NOTES:

- The same stereo audio will be received at both studios. Return audio from the studio connected to "Line 1" will be output "Channel A/Left" and Return audio from the studio connected to "Line 2" will be output "Channel B/Right".
- *L3 Dual/Mono* can be used in place of *G.722* if better fidelity from the studio to remote direction is required.

Radio remotes (Stereo) using two B channels (2 calls)

Good:

Field Unit: Use *L3 J Stereo* Transmit and *G.722* Receive (Zephyr or Zephyr Xstream).

Studio Unit: Use *G.722* Transmit and *L3 Stereo* (Zephyr) or *L3* (Zephyr Xstream) Receive.

Use 32 kHz sample rate for best fidelity or 48 KHz sample rate for reduced delay⁵.

Better:

Field Unit: Use *AAC-LD J Stereo* Transmit and *G.722* Receive.

Studio Unit: Use *G.722* Transmit and *AAC* Receive.

Use 32 kHz sample rate for best fidelity.

Best:

Field Unit: Use *AAC J Stereo* Transmit and *G.722* Receive.

Studio Unit: Use *G.722* Transmit and *AAC* Receive.

Program Link Applications (Stereo)

For bit rates of 112-128 kbps:

For AM and FM backup Studio-Transmitter links:

Use V.35 Split or V.35 Single depending on whether two 56 (64) kbps channels or a single 112 (128) kbps channel is to be used.

Studio Unit: Use *AAC J Stereo* Transmit.

Transmitter site Unit: Use *AAC* Receive

Use 32 kHz sample rate

For bit rates of 256 to 384 kbps over dedicated synchronous circuits:

Use "Single V.35" for your Interface in the TEL menu.

Studio Unit: Use *AAC*, or *L2* Transmit.

Transmitter site Unit: AAC or L2 Receive

Use 48 kHz sample rate

10.4 Multi Codec connections

Sometimes one Xstream will need to connect to two other units simultaneously. The Xstream's L3 Dual/Mono Receive mode allows for considerable flexibility in this regard. In all of the following cases the *Bit Rate* and *Sample Rate* must be matched on all three units.

A single Xstream can receive Layer 3 mono from two sites as shown below:

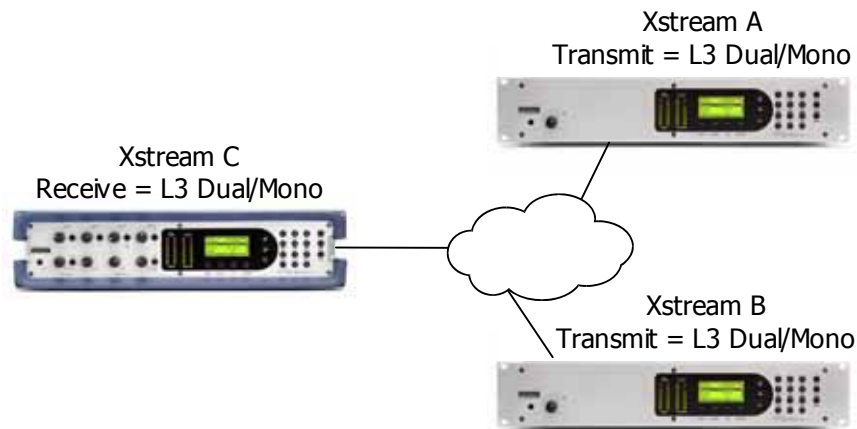

A Zephyr Xstream set to L3 Dual/Mono can receive one channel from each of two remote Zephyrs. Each remote unit would be set to L3 Dual/Mono Transmit.

If Xstream A is dialed from "Line 1" to Xstream C's "Line 1," then Xstream A's channel A audio would be present at Xstream C's channel A output.

If Xstream B dialed from "Line 1" to Xstream C's "Line 2" then Xstream B's channel A audio would be present at Xstream C's channel B output.

Return feeds to A and B can be made using G.722 or L3 Dual/Mono.

Transmitting mono to two sites is also easily accomplished. In the above scenario Xstream C would use L3 Dual/Mono for Transmit. Xstreams A and B would be set to L3 Dual/Mono receive.

If Xstream A were connected to "Line 1" of Xstream C, it would receive the channel A audio from C.

If Xstream B were connected to "Line 2" of Xstream C, it would receive the channel B audio from C.

Xstream also has the useful ability to send Stereo to two sites. This is outlined below:

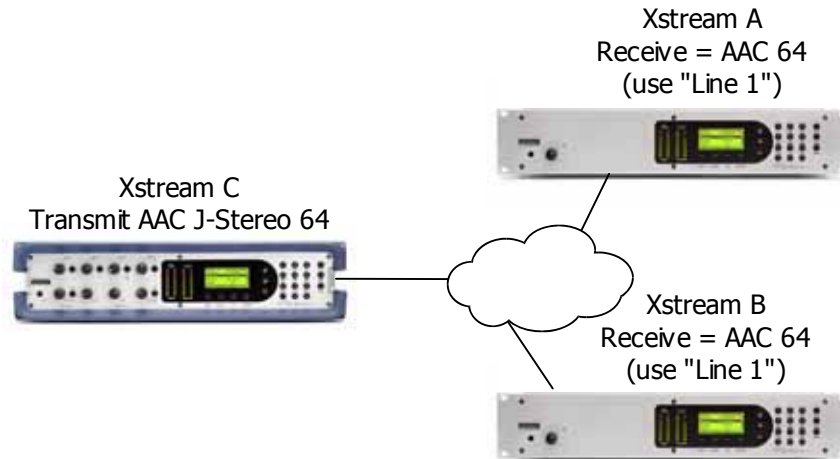

10.5 Choosing a Receive mode

You could always use the *AUTO* option. You will need to set the correct *sample rate*, however. Using the appropriate receive mode will result in the fastest lock when connections are established however. The appropriate *Receive* mode (set in the *CODEC* menu) will be determined with the encoding or *Transmit* mode used at the far end. The terminology used at the far end will vary. Therefore, we will break this section into sub-sections depending on the far-end codec.

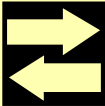
	<p>COMPATIBILITY TIP!</p> <p>When two channels are required for transmission (i.e. for Stereo, J-Stereo, and Mono 128) an "inverse multiplex" (IMUX) scheme must be used to break the standard MPEG data stream into two streams for transmission.</p> <p>In Layer-2, the Zephyr Xstream uses the CCS CDQ (TM) IMUX protocol. Most Layer-2 codecs support this method, allowing for compatibility among different codec manufacturers.</p> <p>The Telos splitter used for AAC and AAC-LD, is published on our website to encourage interoperability with other manufacturers.</p>
---	--

	<p>IMPORTANT!</p> <p>The <i>Auto</i> mode is not applicable when using "V.35 Single" for your Interface in the TEL menu. You must select the appropriate receive mode in this case.</p> <p>See Section 9 (V.35/X.21 Option) for details.</p>
---	---

**HOT TIP!**

The Sample Rate and Bit Rate must be matched for the auto mode to detect the incoming bit stream.

Certain conventions are used which it will help to understand:

64 - This is a Zephyr Xstream *Transmit* mode that requires only a single B channel to operate. The actual bit rate of that channel could be either 56 or 64 kbps.

128 - This is a Zephyr Xstream *Transmit* mode that requires two B channels to operate. The actual bit rate of those channels could be either 56 kbps (for a total of 112 kbps) or 64 kbps (for a total of 128 kbps)

Dual/Mono - This is simply a special case of Mono 64. In the Dual/Mono case the A audio source is sent over "Line 1" while the B audio source is sent over "Line 2".

J-Stereo - This is "Joint Stereo" and is the preferred stereo mode in most cases. The biggest exception is when stereo material will later be transmitted over a surround sound transmission system (i.e. for Video or Film production) in which case the Stereo mode should be used. All stereo modes require 2 B channels (2 calls) unless otherwise stated.

J-Stereo 64 - This mode, unique to AAC, is the only stereo transmission mode that does not require 2 B channels.

L2 Half 64 - This is a special Layer-2 mode that operates at 24 kHz sample rate. The audio will be transmitted at 24 kHz sample rate regardless of the actual sample rate selected in the *CODEC* menu.

The following pages show the correct Xstream "receive" settings for various codecs:

Zephyr Xstream at far end:

Transmit Mode at Far End	Set Local Receive Mode to:
AAC-LD Stereo	AAC-LD
AAC-LD J-Stereo	AAC-LD
AAC-LD Mono 128	AAC-LD
AAC-LD Mono 64	AAC-LD 64
AAC J-Stereo 64	AAC 64
AAC J-Stereo	AAC
AAC Stereo	AAC
AAC Mono 128	AAC
AAC Mono 64	AAC 64
G.722	G.722 *
L2 Stereo	L2
L2 J-Stereo	L2
L2 Mono 64	L2 64
L2 Mono 128	L2
L2 Half 64	L2 64 +
L3 Stereo	L3
L3 J-Stereo	L3
L3 Dual/Mono	L3 Dual/Mono ~
L3 Mono 128	L3
Sample rates on the two ends must match * Actual Sample Rate will be 16 kHz regardless of setting + Actual Sample Rate will be 24 kHz regardless of setting ~ L3 Dual Mono Receive mode can receive 1 or 2 channels of L3 mono from one or two far end sites.	

Zephyr (classic) at far end:

Transmit Mode at Far End:	Set Local Receive Mode to:	Set Local Sample Rate to:
° L3 DUAL or L3 MONO	L3 Dual/Mono	32 or 48 kHz
L3 STEREO	L3	32 or 48 kHz
L3 JSTEREO	L3	32 or 48 kHz
G.722	G.722	* Any
L2 MONO	L2 64	48 kHz
L2 MONO128	L2	48 kHz
° L2 STEREO or L2 DUAL	L2	48 kHz
L2 JSTEREO	L2	48 kHz
L2 HALF/24	L2 64	+ Any
Sample rates on the two ends must match * Actual Sample Rate will be 16 kHz regardless of setting + Actual Sample Rate will be 24 kHz regardless of setting ° Name will depend on software version		

ZephyrExpress at far end:

Transmit Mode at Far End:	Set Local Receive Mode to:	Set Local Sample Rate to:
L3-DUAL	L3 Dual/Mono	32 or 48 kHz
L3-STEREO	L3	32 or 48 kHz
L3-JOINT	L3	32 or 48 kHz
G.722	G.722	* Any
L2-MONO64	L2 64	48 kHz
L2-MONO128	L2	48 kHz
L2-DUAL	L2	48 kHz
L2-JSTEREO	L2	48 kHz
L2-HALF/24	L2 64	+ Any
Sample rates on the two ends must match * Actual Sample Rate will be 16 kHz regardless of setting + Actual Sample Rate will be 24 kHz regardless of setting		

Zephyr Xport at the far end

When Xport is on ISDN use the "Zephyr" *Dial Mode* selection on the dialing Xstream or Xport:

- *Transmit* - AAC-LD Mono 64
- *Receive* - AAC-LD Mono 64
- *Sample Rate* : 48 kHz
- Connect on one B channel only

When Xport is on POTS use the "Xport" *Dial Mode* selection on the dialing Xstream or Xport:

- No configuration necessary

Comrex Nexus at far end

Use the following settings on the Xstream:

- *Transmit* - G.722
- *Receive* - G.722
- *Sample Rate* - Any
- Connect on one B channel only.

CCS CDQ Prima at far end

Far End Setting (ID #):	Set Local Receive Mode to:	Set Local Transmit Mode to:	Set Local Sample Rate to:	Set Local Bit Rate to:
6: G.722_56K:QS	G.722	G.722	* Any	56 kbps
7: G.722_64K:QS	G.722	G.722	* Any	64 kbps
24:ZEPHYR/56K:QS	L2 64	L2 Mono 64	48 kHz	56 kbps
25:ZEPHYR/64K:QS	L2 64	L2 Mono 64	48 kHz	64 kbps
26:ZEPHY/112K:QS	L2	L2 Mono 128	48 kHz	56 kbps (2)
27:ZEPHY/128K:QS	L2	L2 Mono 128	48 kHz	64 kbps (2)
30:LYR3IND56:QS	L3 Dual/Mono	L3 Dual/Mono	48 kHz	56 kbps
31:LYR3IND64:QS	L3 Dual/Mono	L3 Dual/Mono	48 kHz	64 kbps
32:LYR3IND56/32:QS	L3 Dual/Mono	L3 Dual/Mono	32 kHz	56 kbps
33:LYR3IND64/32:QS	L3 Dual/Mono	L3 Dual/Mono	32 kHz	64 kbps
36:ZEPHY112MONO:QS	L2	L2 Mono 128 or L2 J-Stereo or L2 Stereo	48 kHz	56 kbps (2)
37:ZEPHY128MONO:QS	L2	L2 Mono 128 or L2 J-Stereo or L2 Stereo	48 kHz	64 kbps (2)
(2) = Both B channels must be dialed for this mode				
* Actual Sample Rate will be 16 kHz regardless of setting				
Note: Rev 6.32 Primas support all of the above pre-sets (unless they have been overwritten by the user). Earlier models may not include all of the above.				

CCS Roadrunner at far end

Far End Setting (ID #):	Set Local Receive Mode to:	Set Local Transmit Mode to:	Set Local Sample Rate to:	Set Local Bit Rate to:
1: L2/56/24YES:QS	L2 64	L2 Half 64	+ Any	56 kbps
3: L2/56/32YES:QS	L2 64	L2 Mono 64	32 kHz	56 kbps
5: L2/56/48YES:QS	L2 64	L2 Mono 64	48 kHz	56 kbps
7: L2/64/24YES:QS	L2 64	L2 Half 64	+ Any	64 kbps
9: L2/64/32YES:QS	L2 64	L2 Mono 64	32 kHz	64 kbps
11: L2/64/48YES:QS	L2 64	L2 Mono 64	48 kHz	64 kbps
13: L2112/32YES:QS	L2	L2 Mono 128	32 kHz	56 kbps (2)
15: L2112/48YES:QS	L2	L2 Mono 128	48 kHz	56 kbps (2)
17: L2128/32YES:QS	L2	L2 Mono 128	32 kHz	64 kbps (2)
19: L2128/48YES:QS	L2	L2 Mono 128	48 kHz	64 kbps (2)
23: L3/56/32YES:QS	L3 Dual/Mono	L3 Dual/Mono	32 kHz	56 kbps
25: L3/56/48YES:QS	L3 Dual/Mono	L3 Dual/Mono	48 kHz	56 kbps
29: L3/64/32YES:QS	L3 Dual/Mono	L3 Dual/Mono	32 kHz	64 kbps
31: L3/64/48YES:QS	L3 Dual/Mono	L3 Dual/Mono	48 kHz	64 kbps
33: L3112/32YES:QS	L3	L3 Mono 128	32 kHz	56 kbps (2)
35: L3112/48YES:QS	L3	L3 Mono 128	48 kHz	56 kbps (2)
37: L3128/32YES:QS	L3	L3 Mono 128	32 kHz	64 kbps (2)
39: L3128/48YES:QS	L3	L3 Mono 128	48 kHz	64 kbps (2)
40: G722/56NO:QS	G.722	G.722	* Any	56 kbps
41: G.722/56YES:QS	G.722	G.722	* Any	56 kbps
42: G.722/64NO:QS	G.722	G.722	* Any	64 kbps (1)
43: G.722/64YES:QS	G.722	G.722	* Any	64 kbps (1)
(1) = Dial up one B channel only, or this mode may not work				
(2) = Both B channels must be dialed for this mode				
* Actual Sample Rate will be 16 kHz regardless of setting				
+ Actual Sample Rate will be 24 kHz regardless of setting				

10.6 Dealing With Delay

Mix-Minus

All perceptual coders have too much delay for talent on remote to hear themselves via a round-trip loop without an "echo" that can be annoying and disorienting. Therefore, a special *mix-minus* (sometimes called a "clear feed" or "mix-minus one") arrangement is required – exactly the same as has been used with satellite linked remotes for years. The European term "mix minus one" is clearer in the most typical situation.

The principle is this: The remote talent does not hear himself via the studio cue return. Rather, his microphone is mixed locally with a studio feed that has everything *but* the remote audio – thus the "mix-minus" designation. The announcer gets in his headphones a non-delayed version of himself and a slightly delayed version of all of the studio pieces.

Most modern digital console can be configured to generate mix-minuses without user intervention. If you are using an older console that does not have this ability, or a non-broadcast console, here are some methods you can use.

Examples of mix-minus set-ups:

Example 1: Using a broadcast console (mixing desk)

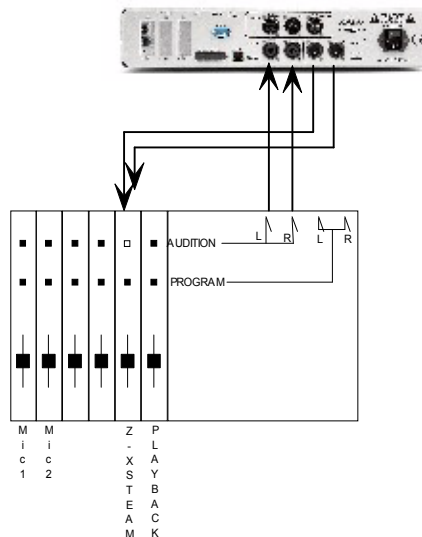

The simplest form of mix-minus involves using a dedicated bus to feed the Xstream. In this case, we show Audition feeding the Zephyr Xstream. Note that Fader 5 (a stereo input) is NOT assigned to Audition.

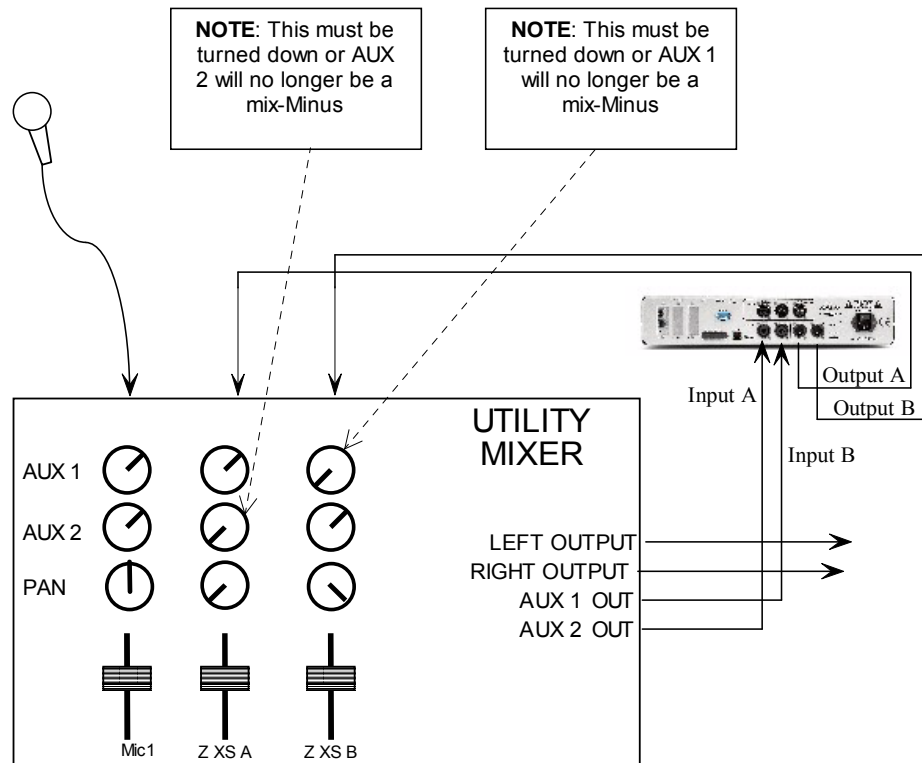

Example 2: Using a Utility Mixer

The simplest form of mix-minus using a Utility Mixer with mono inputs. Two mono faders and two busses, AUX 1 and AUX 2 are used.

It is also possible to use the mixer's main outputs to form a mix-minus, by Panning one Input channel "hard left" and the other input "hard right".

Phones and Remotes

To save money and hassle, callers are usually received at the studio, rather than at the remote site. In this situation, phones need to be fed to the remote talent, so that they can hear and respond to callers. Moreover, the phone callers need to hear the talent. In many cases, the remotes are sufficiently distant that the station cannot be monitored for the caller feed. Even if it could, the profanity delay would be a problem, since the talent needs to hear the phone pre-delay.

The talent hears callers via the return path. As before, this return is fed with mix-minus: a mix of everything on the program bus minus the remote audio.

As for the second half of the equation, the callers hear the talent because the remote feed is added to the telephone mix-minus buss. No problem if you have a set-up that permits selective assignment to the phone mix-minus.

The most common problem with this arrangement is a result of a phone hybrid with too much leakage combined with the system delay. If the hybrid isn't doing a good job of preventing the send audio from leaking to its output, the special remote send mix-minus is corrupted.

Remember, if any of the announcer audio from the remote site is returned via the monitor feed, it will be delayed by the codec link, causing an echo effect. Problem. The answer is to make sure you have the best possible hybrid with the maximum trans-hybrid loss, such as a system that uses ISDN lines. If it has variable override (caller ducking), you could increase the amount when these remotes are in progress (or, on some hybrids, you would decrease the setting of the "duplex" control).

Some users place a downward expander, carefully adjusted to gate the leakage, in the caller audio path.

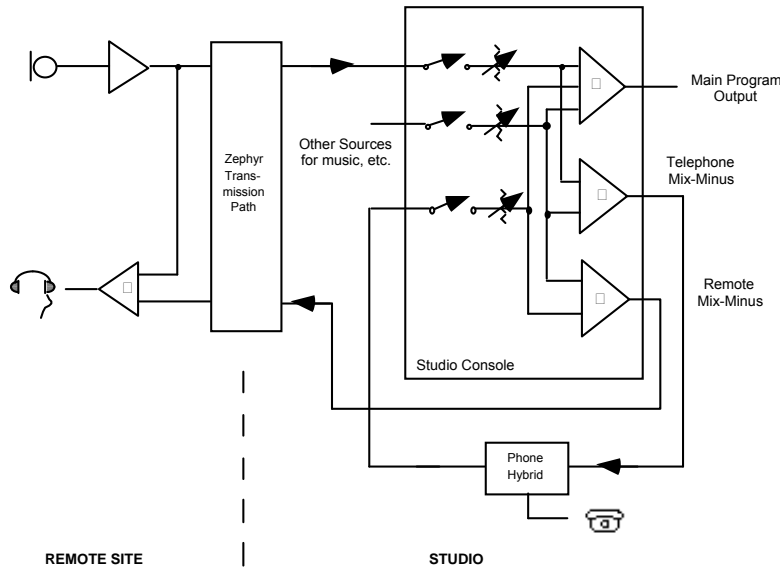

Diagram showing system set-up for remotes with delay in the transmission path and phones taken at the studio. Note that this is the same as required for satellite links.

Another issue worth considering is the round trip delay. The apparent on-air response time of the talent to callers' comments will be the sum of studio-to-remote delay + remote-to-studio delay + talent's thinking time. For this reason the studio-to-remote path will generally use the G.722 mode, which sacrifices fidelity for delay (after all, the callers need not be in high fidelity). This round trip delay issue will also affect your choice of remote-to-studio coding. If the show will be 90% talk with just a small amount of music then delay can be minimized by using a mono mode for this path rather than using one of the slower stereo modes.

Here is where Zephyr Xstream's AAC-LD encoding really shines. It gives you high quality announcer audio with the lowest delay possible. In addition, the reduced delay time will serve make any leakage less distracting (for more on this see Section 6 - Audio Coding Reference).

Another trick is to use a POTS call (call *mode = Phone*) for the studio-to-remote link, which will make the delay in that direction very small. Other intermediate tradeoffs are possible, and will be dependent on your format. Talent thinking time can be significantly reduced by drinking a strong cup of coffee!

For information on the tradeoff between audio quality and delay, refer to manual Section 6 (Audio Coding Reference)

11 THE WORKS! - Detailed Menu Reference

In this section, we cover each selection of every menu in detail. It is intended as a reference, and for those using some of the more specialized features of the Zephyr Xstream. Beginning users are likely to find the topics of interest covered in Section 4 (Basic Operation & Installation) and Section 4 (Guided Tour of the Menus)

	<p>IMPORTANT!</p> <p><i>This section covers the front panel menus of the Xstream. Many of these functions are also available from the HTTP interface that can be accessed by using your favorite web browser. Note that you will need to have Java installed to view certain items such as the Livewire audio meters.</i></p>
---	--

The Xstream's web pages are also included in this section for reference. For your convenience many of the Xstream's settings are found in both locations - front panel menus and web pages. The grouping of functions on these pages is similar so, in most cases, a direct comparison is possible. Both interfaces are presented here – front panel and web pages.

11.1 The MENUS

First, let's lay out the home page and each of the menus we'll be discussing. The next few pages show the details each of the sub-menus. Note that we show the *AUDIO* menus twice, once for the Xstream, and again for the Xstream MX/MXP models. Here is the "home page" of the web browser interface.

Telos Zephyr Xstream	
<u>Status</u>	current operation of the codec and network interface including dial and drop functions
<u>System</u>	loopback testing, ancillary data, contact closures
<u>Tel</u>	SPIDs, DNS, switch type, auto-answer, dialing prefix, network interface, streaming ports
<u>Codec</u>	codec modes, bitrate, sample rate, compatibility, streaming buffer, WAN IP, hostname
<u>Audio</u>	input/output levels, gain trim, send mix, input source (MX):per-channel gain, pain, processing, low cut, per-monitor bal, mix, pan
<u>Auto</u>	dial and location setups create, modify, or recall setups
<u>Configure Livewire</u>	Configure Livewire sources and destinations: names, channel numbers, format
<u>Livewire Meters</u>	Monitor Livewire audio levels. Input gain control.
<u>Administration</u>	IP network address, NTP server Software update and maintenance
<u>Quality of Service Settings</u>	Livewire Clock Mastership settings 802.1p priority and VLAN tagging, DSCP Class of Service

MENUS - The CODEC, TEL & SYSTEM Menus (all models)

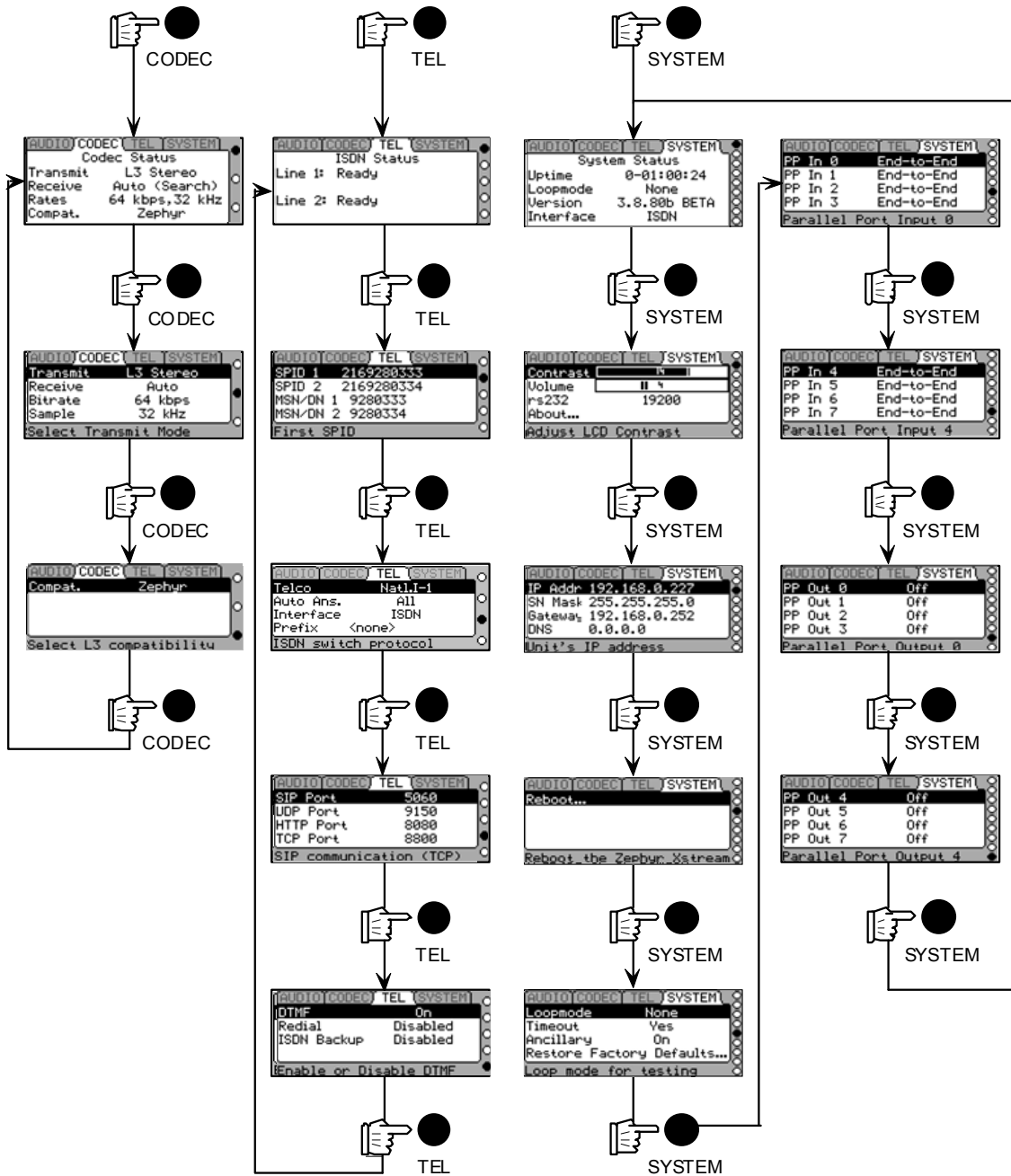

MENUS - The DIAL & AUTO Menus (all models)

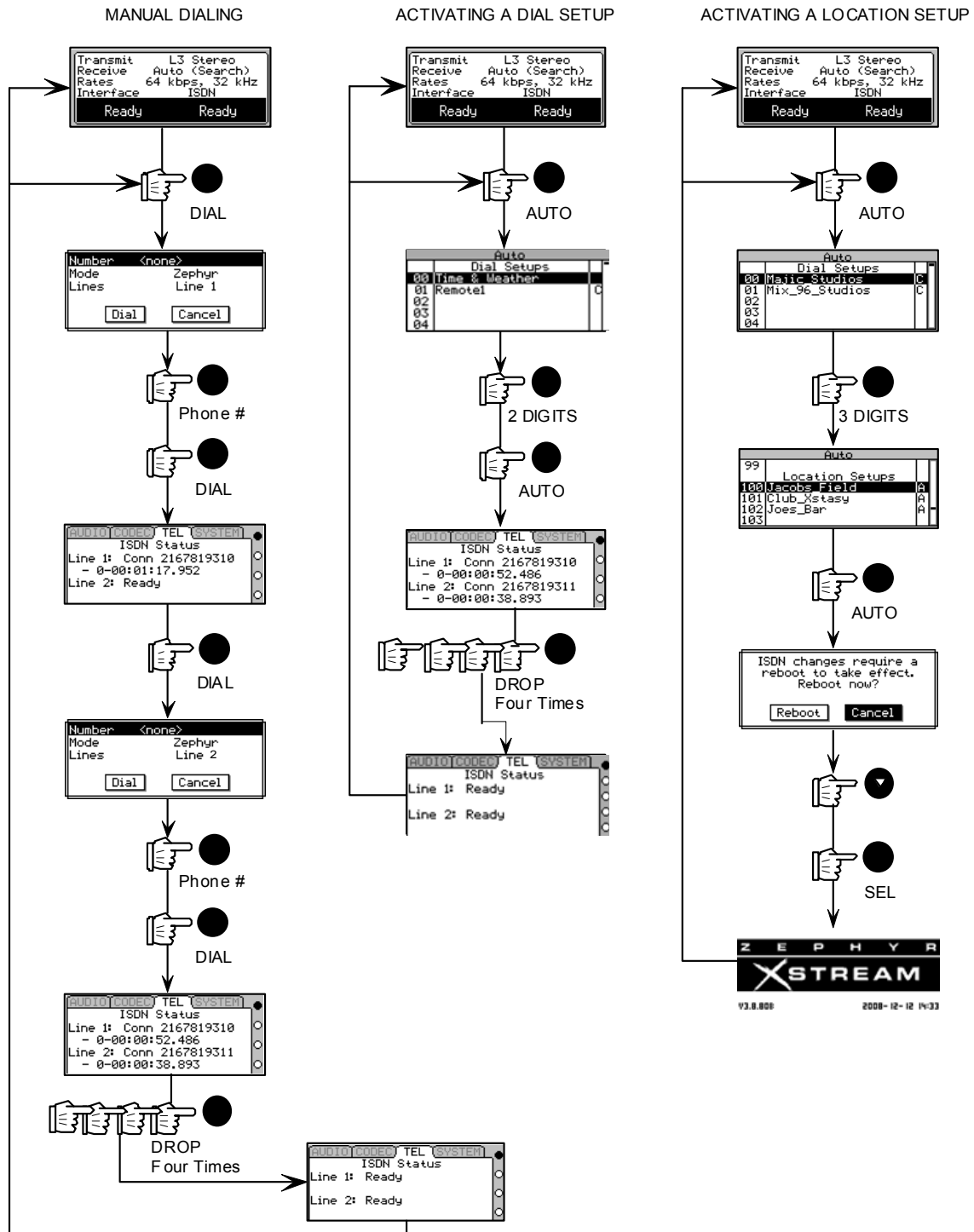

MENUS - The Audio Menu (non-mixer model)

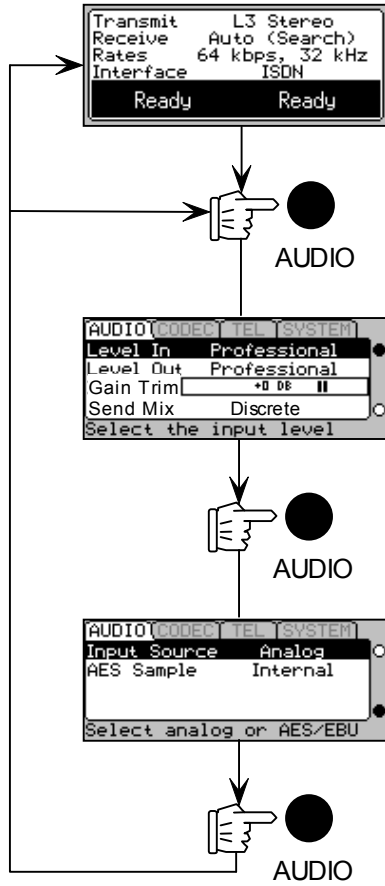

MENUS - The Audio Menu MX/MXP (mixer versions)

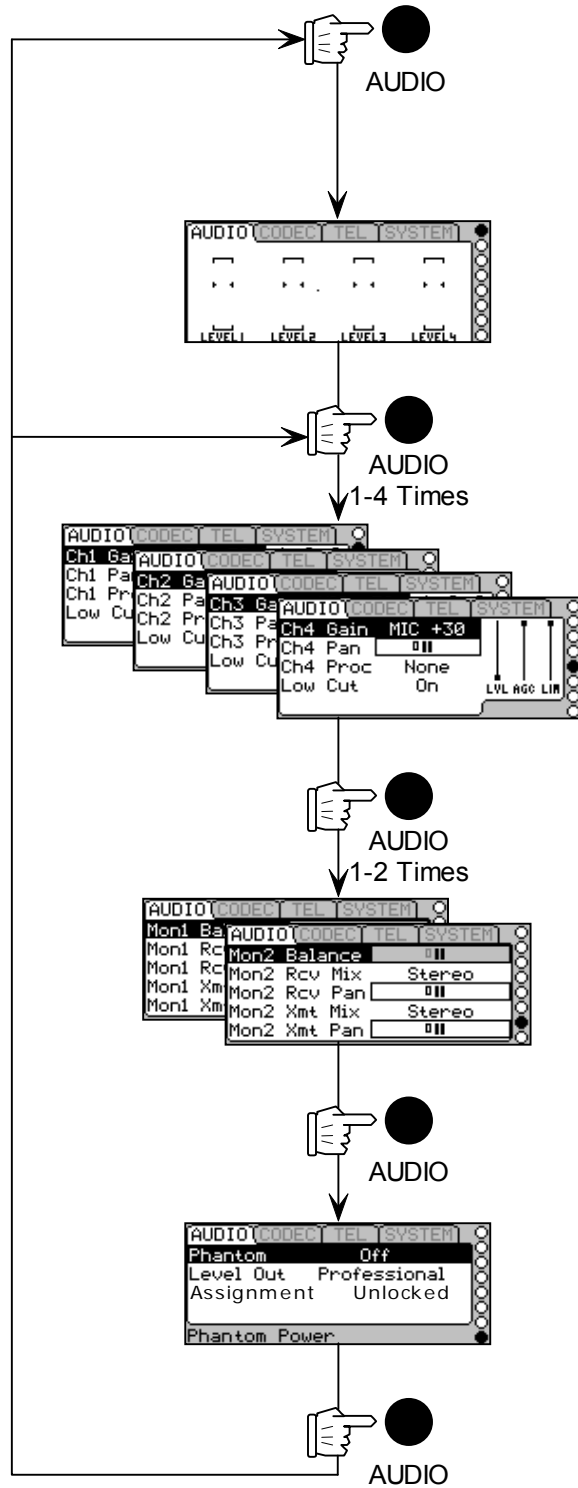

11.2 The AUDIO Menu – Xstream (non-mixer version)

See the next section, if your Zephyr Xstream has a mixer (models Xstream MX or Xstream MXP).

Don't forget that you can create *Location Setups* to easily recall the menu selections of the *AUDIO* menus. Even if the ISDN line is the same, these *Location Setups* can be used to program these parameters (i.e. for different shows or uses in a dedicated situation. See Section 5.2 (Guided Tour of the Menus) for more on *Setups*.

The Audio menu has items related to audio input and output –analog, AES/EBU and Livewire.



HOT TIP!

*We've broken each of the menus into "pages" so you can navigate easily. For example, to jump to the second **AUDIO** menu you need only press the <AUDIO> button twice and you are there!*

AUDIO – Screen 1



Level In:

This option determines the input operating level for the Xstream's inputs (non-mixer version) as follows.

Professional:

This will be +4 dBu (nominal) with the factory default settings for JP10 & 11 (JP 5 & 6 on early rev audio boards). If these jumpers are reconfigured (see section

13.1) the level would be 0 dBu (nominal). The system allows for 18 of headroom above nominal level, clipping at +22 dBu.

Consumer:

This will be -11 dBu (nominal) for the factory default settings of JP10 & 11 (JP 5 & 6 on early rev audio boards). If these jumpers are reconfigured (see section 13.1) the level would be -15 dBu (nominal). The system allows for 18 headroom above nominal level, clipping at + 7dBu.

Level Out: (Professional; Consumer)

This determines the nominal output level as follows:

Professional:

+4 dBu (nominal). Clip point is +22 dBu.

Consumer:

-10 dBu (nominal). Clip point is +8 dBu.

Gain Trim: (-12dB to +12 dB)

This setting happens after the Analog-to-Digital converter. It will affect the levels of both the Analog and AES/EBU inputs. It can be used to adjust for differing headroom requirements when connected to other gear. Since this setting is in the digital domain changing to values greater than the default (0 dB) will decrease operating headroom, by a corresponding amount.

	<p>IMPORTANT TIP!</p> <p><i>Setting the gain trim adjustment (below) to values greater than 0 dB will serve to reduce input headroom by a corresponding amount.</i></p> <p><i>The analog inputs clip point remains at +22 dBu(or +8, see above) so this level must not be exceeded. The rare source device with a clip point in excess of +22 dBu may require an external pad.</i></p>
---	--

The *Gain Trim* setting may be use to adjust for differing peak output levels between different "+4 nominal" source equipment, or it can be used to accommodate analog sources that are below the nominal levels. We recommend that the source equipment's clip point be determined and this be set using that information.

- The default setting of *0dB* accommodates input levels at nominal levels of +4 dBu with a clip point of 22 dBu (e.g. 18 dB headroom). When feeding the inputs from a "+4 nominal" device that clips at some lower level (for example +18 dBu, e.g. 14 dB headroom), you can increase the gain (by 4 dB in our example) to match this device's clip point to the Xstream's 0 dBfs point.

- This adjustment can also be used in cases where a low-level signal source must be used. Again you should use the rated clip point of the source device to determine the closest setting. Simply add gain to bring this rated clip point up to +22 dBu.

AES sources. In the case of AES sources, this adjustment can be used to adjust system headroom. This should be done with care and deliberation.

While we don't recommend setting levels "by eye," if you choose to do so, you can use the Send meters as your guide.

AUDIO – Screen 2

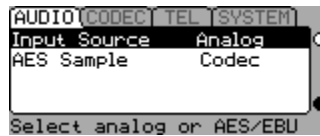

INPUT SOURCE: (Analog; AES/EBU; Livewire)

This selection determines which inputs are active. Your options are Analog, AES and Livewire. Note that *analog*, *AES/EBU*, and *Livewire* outputs are always (simultaneously) active.

AES SAMPLE:

This determines the sample rate of the *AES/EBU Output* signal as follows:

Codec

This option uses the sample rate selected in the Codec menu. This is the "transmission" sample rate and is derived from the ISDN (or V.35) clock. Use this option only the AES/EBU equipment being fed is tied to this network clock (for example, another codec).

Sync:

This option sample rate converts the codec receive audio to the rate of the AES/EBU signal present at the *SYNC-IN* jack for output at the *AES/EBU Out* jack on the rear of the Zephyr Xstream. This can be any AES/EBU signal; any audio present will be ignored.

AES Input:

This is the usual setting if a house sync is not used; this option sample-rate-converts the codec receive audio (set in the *AUDIO* menu) to the rate of the AES/EBU signal present at the *AES/EBU IN* jack for output at the *AES/EBU Out* jack on the rear of the Zephyr Xstream. This option allows easy synchronisation to your clock reference, when the Xstream's *AES/EBU In* is fed from a device already tied to your house clock reference.



IMPORTANT TIP!

*When the AES SAMPLE setting is set to Sync or Input there will be no AES output signal unless there is a valid signal at the **Sync-IN** or **AES In** jack, respectively.*

48kHz, 44.1, & 32 kHz

These options sample rate convert the codec receive audio (set in the *Audio* menu) to the selected rate. An internal locally generated clock reference in the Xstream is used. This option should only be used if the device connected to the Zephyr Xstream's **AES/EBU OUT** jack performs sample rate conversion, or dropouts due to buffer overflow or underflow will occur.



DEEP TECH NOTE!

*The Sample Rate conversion and AES Sync capabilities allow you to prevent problems with "clock slip" due to different clock rates within a digital facility. Typically a "house clock" reference would be fed to the **SYNC-IN** jack of the Zephyr Xstream, as well as to other equipment, to prevent drop outs due to buffer "overflow" or "underflow" conditions.*

It is important to understand that while the Zephyr Xstream provides frequency synchronization, it does not provide byte alignment. Your digital mixing equipment should provide this capability, if required.

SEND MIX

This determines how the two inputs are treated when a mono send mode is used.

Discrete:

When *Discrete* is selected the A audio input will be used and the B audio input will be ignored. This is the default setting.

Mono A+B

This option sums the two audio inputs with the resulting mono signal being sent both inputs of the encoder system.

Livewire

Since Livewire is one way of getting audio to and from your Xstream, we will discuss those menus here as well. Please refer to Section 8 for details on configuration of Livewire.

These menus enable you to specify the Livewire streams being created by the codec ("sources" delivered to the Livewire network) and the audio streams being delivered by the codec ("destinations" from the Livewire network). Expert mode enables you to specify custom backfeeds if required.

Please see Section 8 for background on Livewire and more details on the Xstream configuration.

Hybrid Channels			
#	Name:	Channel:	Source Mode:
1	ZXS2 SRC 1	100	Livestream
2	ZXS2 SRC 2	101	Livestream

Entering a channel number configures both:
Livewire Source and Destination for the hybrid.
Destinations will be configured 'To source'.

To configure Livewire Sources and Destinations separately, use [Expert Mode](#)

Livewire – Basic Setup

The basic setup gives you the option of specifying a **channel number** and **name** for each the two stereo Livewire streams that can be created by the Xstream. The channel numbers must be unique. The name can be any name you wish to use to describe the codec. Try to choose a detailed name if you have more than one codec since this will be beneficial when you are setting up your Axia system.

The **Source Mode** should be set to **Livestream** for minimum latency.

The backfeeds of the codec are set automatically in this mode. They will be set for the same channel number as the source with "to source" as the mode. If you need to specify a different backfeed, you will need to use the Expert Setup shown below.

-- Expert Livewire configuration mode --

Livewire Sources			Livewire Destinations		
#	Name:	Channel:	Mode:	Channel:	Mode:
1	ZXS2 SRC 1	100	Livestream	100	To source
2	ZXS2 SRC 2	101	Livestream	101	To source

Apply

Livewire – Expert Setup

11.3 The AUDIO Menu – Xstream MX/MXP (mixer models)

See the previous section, if your Zephyr Xstream does not have a mixer section (model Xstream).

The *AUDIO* menu has items related to the four main mixer inputs; local mix 1; and local mix 2. You will find many useful items in the pages of this menu.

Don't forget that you can create *Location Setups* to easily recall the menu selections of the *AUDIO* menus. Even if the ISDN line is the same, these *Location Setups* can be used to program these parameters (i.e. for different shows or uses in a dedicated situation. See Section 5 (Guided Tour of the Menus) for more on *Setups*.

AUDIO - Screen 1 (Status)

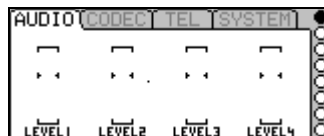

The first *AUDIO* menu has the individual levels for each of the Main Mixer inputs. These levels are post fader and therefore can be used to view relative levels of each input. Clip indicators for each input are also provided.



HOT TIP!

The clip indicators should display very rarely, if ever. If you see the clip indicator, you should change the CHx Gain setting for the input that is clipping. This is set in screens 2 through 5 for Inputs 1 through 4, respectively (see below).

AUDIO - Screens 2 - 5

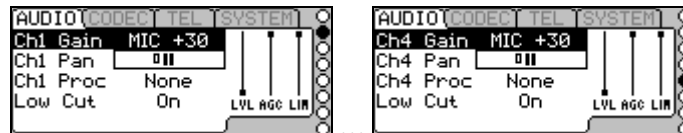

The second, third, fourth and fifth *AUDIO* menus allows adjustment of parameters for Main Mixer inputs 1-4, respectively. These screens are identical and have the following information:

Ch “x” Gain

This menu selection allows you to select from four different gain settings (2 mic. and 2 line) for Main Mixer input x. The options for this setting are:

MIC +44: -55 dBu (nom)

MIC +30: -40 dBu (nom)

Line Con: -10 dBu (nom)

Line Pro: +4 dBu (nom)

The nominal values given above assume the fader is mid-position and the AGC/Limiter (processor) is off

Ch "x" Pan

This menu selection is a "panorama" adjustment that allows you to vary the amount of audio sent to the A and B codec inputs. Note that this adjustment has no effect unless the input "x" has been assigned to both A and B using the front panel control.

Ch "x" Proc

This menu selection allows you to enable the built in AGC/Limiter (processor) for Main Mixer input "x". You will be able to see the level for input "x" as well as the AGC and Limiter working by looking at the small bar-graphs and gate indicator to the right side of this screen. The built in Omnia processor is quite sophisticated and offers the following options:

None:

This disables the input processor for channel "x".

Voice L:

(Voice Low) This is the least aggressive setting, intended to protect against minor level problems when running a live show. This provides AGC with no limiting. Ideal where you want the most natural sound in live situations where mixing could be difficult.

Voice M:

(Voice Medium) This is a moderate setting. It combines AGC with a small amount of limiting. This provides good dynamics control, and serves to "beef up" the voice. This setting is the most frequently used general purpose setting for voice.

Voice H:

(Voice High) This is an aggressive setting employing both AGC and limiting. This setting is perfect for easily excited talent such as sportscasters.



HOT TIP!

Please don't use the "voice" processor settings if your source includes musical material. The fast time constants used in the Voice M and Voice H settings will cause noticeable artifacts if used on most music.

Music:

This setting offers a slow AGC only.

Low Cut

This is a low cut (pop) filter designed to reduce wind and breath noise. Its characteristics are as follows:

- Cut off frequency: 80 Hz
- Slope: 3 dB per octave

AUDIO - Screens 6 & 7

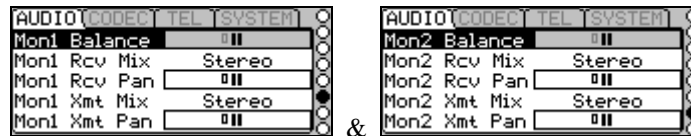

These screens are used to set up Local *Monitor Mix 1* (screen 6) and Local *Monitor Mix 2* (screen 7). The following options allow the operator to customize the Local Mixes as required for different applications and as needed to accommodate talents' needs. The following selections are offered.



HOT TIP!

*When planning your local mixes, remember that **Monitor Mix 2** feeds both the headphone jacks and line level jacks on the rear panel.*

Mon "x" Balance

This adjustment allows you to vary the ratio of *Send* to *Receive* audio in Local Mix "x". This control has no effect if both *SND* and *RCV* have not been selected on the front panel.

Mon "x" Rcv Mix

This parameter, in combination with *Mon "x" Rcv Pan* selection is useful for when only a single return channel is being sent from the far end. The default is stereo. The options are:

Stereo:

This choice routes the incoming (far end) audio to the headphones as received. The A channel audio appears on the Left side of the Local Mix and the B channel audio appears in the Right side of the Local Mix.

A:

This option routes the incoming A channel audio to both sides of the Local Mix.

B:

This option routes the incoming B channel audio to both sides of the Local Mix.

Note that the "A" or "B" options allow a single incoming signal to be output on both channels of the Local Mix.

Mono A + B:

This option sums (i.e. mixes) the incoming A & B audio channels and routes this to both sides of the Local Mix.

This can be particularly useful when the both a mix minus and a producer IFB (interruptible foldback) are being received, as it allows both feeds to be heard in both ears.

Mon "x" Rcv Pan

This control determines the ratio of the amount of the audio fed to the A (Left) and B (Right) channels of the Local Mix.

Mon "x" Xmt Mix

This option operates in the same way as Mon "x" Rcv mix, only the send audio is used. This is particularly useful when creating two separate mono mixes to be sent to two far end locations, as it can allow the talent to hear the correct return mix in both ears. The options are:

Stereo:

This choice routes the outgoing (near end) audio to the headphones just as transmitted by the codec section. The A channel audio appears on the Left side of the Local Mix and the B channel audio appears in the Right side of the Local Mix.

A:

This option routes the outgoing A channel audio to both sides of the Local Mix.

B:

This option routes the outgoing B channel audio to both sides of the Local Mix. Note that the "A" or "B" options allow a single outbound signal to be output on both channels of the Local Mix.

Mono A + B:

This option sums (i.e. mixes) the incoming A & B audio channels and routes this to both sides of the Local Mix

Mon "x" Xmt Pan

This control determines the ratio of the amount of the audio fed to the A (Left) and B (Right) channels of the Local Mix.

AUDIO - Menu 8

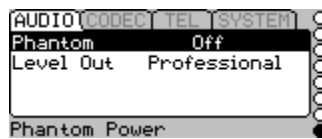

This menu has three options:

Phantom

This option allows you to disable (*Off*) or enable (*On*) phantom power for inputs 1 & 2. Phantom power provides a full 48 volts, and is fed to both inputs 1 & 2 when enabled.

Level Out: (Professional; Consumer)

This determines the nominal output level as follows:

Professional:

+4 dBu (nominal). Clip point is +22 dBu when used with balanced sources.

Consumer:

-10 dBu (nominal). Clip point is +8 dBu.

Assignment

This setting this to *Locked* locks the input assignments (A/B select) and monitor assignments (Send/Receive select) to their current settings.

Input Select (not present in 10 Base-T version hardware)

The MX/P Xstreams can be used on a Livewire Ethernet network. It is worth noting that the Livewire inputs bypass the mixer section and feed the codec directly. The input selection has the following options:

Mixer:

In this case, the output of the MX/P's mixer section feeds the codec. This can be considered the usual mode of operation for a MX/P Xstream

Livewire:

When this setting is selected, the mixer is disabled and the codecs input is fed from the Livewire channel(s) specified. Please refer to Section 8 for details on Livewire configuration.

11.4 The CODEC Menu

CODEC – Screen 1: Status

The screenshot shows a web interface with a navigation bar at the top containing: Home | Status | System | Telco | Codec | Audio | Autodial | LiveWire | LiveWire Meters | LiveWire QoS | Administration. The main content area is titled 'System Status' and contains the following information:

Unit Name	zxs
Uptime	0-00:16:05
Decoder	Unlocked

Below this is the 'SIP Status' section:

Source	0.0.0.0
Sessions	0
Decoder Changes	0
Bitrate Changes	0
Sample Rate Changes	0
Packets Received	0
Bytes Decoded	0
Overflow Events	0
Lost Packets	0
Destination	None
Overflow Events	0
Block Count	0
Bytes Sent	0
Bytes to Socket	0

At the bottom, there is a 'New Stream' button, an input field, and a 'Connect' button.

The screenshot shows a menu with the following settings:

Transmit	L3 Stereo
Receive	Auto (Search)
Rates	64 kbps, 32 kHz
Compat.	Zephyr

This page summarizes the *Transmit*, *Receive*, *Bitrate* & *Sample Rate* settings. *Transmit* will effect whether the far end can receive your audio *Receive* will effect whether you can receive audio from the far end. *Bitrate* and *Sample Rate* effect transmission in both directions

CODEC – Screen 2



Transmit:

The *Transmit* setting determines what standard (i.e. algorithm) is used to encode the audio to be sent to the far end. Each mode offers distinct advantages and disadvantages (see section 6.2 for additional information), as follows:

L3 Stereo and L3 J-Stereo

Until the release of the Zephyr Xstream, MPEG Layer-3 was the best available algorithm for sending stereo audio over 2 ISDN B channels. Joint (i.e. Joint Stereo) should be used for the majority of applications, as it eliminates the redundant transmission of the center channel information typical in most source material.

L3 Stereo is appropriate for situations where the audio transmitted will be subject to playback over Surround Sound systems (i.e. mostly for Television).

Use these Layer-3 stereo modes if the far end does not support AAC.

This mode offers 15 kHz audio frequency response if the *Sample Rate* is set to 32 or 16 kHz audio frequency response if the *Sample Rate* is set to 48 kHz.

L3 Mono 128

This is the best quality Layer-3 mode supported on the Xstream. Audio present on the A input will be encoded and transmitted. By using both B channels (i.e. 128 or 112 kbps) reduces the compression ratio by half and therefore gives superior fidelity. Since two B channels are required however, the transmission costs would be doubled. If lengthy sessions are to be performed over long distances, a mode that requires only a single B channel may be desirable.

Use L3 Mono 128 when mono transmission is needed, transmission costs are secondary, and the far end does not support AAC.

This mode offers 15 kHz audio frequency response if the *Sample Rate* is set to 32 or 22 kHz audio frequency response if the *Sample Rate* is set to 48 kHz.

Z

ZEPHYR CLASSIC VS XSTREAM COMPARISON!

While the Zephyr Classic cannot transmit Layer 3 Mono-128, it can receive audio coded in this way. Use the L3 Stereo Rcv mode to do so.

L3 Dual/Mono

The L3 Dual/Mono mode is a special mode. L3 Dual/Mono mode generates two L3 Mono encoded streams at 64 or 56 kbps each. The first stream encodes the audio on the A audio input. This stream is available on the first ISDN Bearer channel (or V.35/X.21 port) "Line 1".

The second stream is encoded using the audio on the B audio input. This stream is available on the second ISDN Bearer channel (or V.35/X.21 port) "Line 2".



HOT TIP!

*If you wish to feed identical audio down both channels you can do so by setting up the send mixer section (MX/MXP models) appropriately, or by setting the **Send Mix** option to "A + B" in the **AUDIO** menu (non-mixer model).*

The Dual transmit mode can be used on three ways:

- As a L3 "Mono 64" mode. In this case, only one ISDN channel is dialed up and the audio to be sent is fed to the corresponding input. This use is really a subset of our next example.
- As a "2 x L3 Mono 64 mode". In this case, the first ISDN channel is dialed up to "site X" and the second ISDN channel is dialed up to "site Y". In this case

site X will get the audio from audio input A and site Y will get the audio input into audio input B.

- Finally, the mode can be used to transmit two channels between two units. Both "lines" must be dialed up – Line 1 to Line 1, Line 2 to Line 2. It is important to understand the difference between this use of L3 Dual/Mono and the L3 Stereo and L3 J-Stereo modes.
 - a) L3 Dual/Mono keeps the two audio channels completely separate. In fact, it does not ensure that the two channels remain phase-aligned.
 - b) L3 Stereo keeps the two channels separate (i.e. there is no danger of cross-talk) and maintains phase-alignment between the two channels. However, the perceptual model used with L3 Stereo does assume that the listener will be hearing both channels simultaneously (i.e. that this is a stereo application). Therefore, the model takes into account that audio from one channel may mask audio from the other channel.
 - c) L3 J-stereo matrixes the two channels together and therefore a small amount of inter-channel interaction is possible.

L3 Dual offers 15 kHz audio frequency response when the *Sample Rate* is set to 32 kHz, or 16 kHz audio frequency response if the *Sample Rate* is set to 48 kHz.

Z

ZEPHYR CLASSIC VS XSTREAM COMPARISON!

Early Layer-3 Zephyr's call this mode "Mono/Dual". Later Layer2+3 Zephyrs call this mode "L3 Dual".



HOT TIP!

These different uses of the L3 Dual/Mono mode may require different receive modes depending on the use and the far end codec.

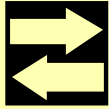

COMPATIBILITY TIP!

When two channels are required for transmission (i.e. for Stereo, J-Stereo, and Mono 128) an "inverse multiplex" (IMUX) scheme must be used to break the standard MPEG data stream into two streams for transmission.

In Layer-3, the Zephyr Xstream uses the FHG/Telos Zephyr IMUX protocol. Other Layer-3 codecs support this method, allowing for compatibility among different codec manufacturers.

The Telos IMUX used in AAC and AAC-LD is available on our website to encourage compatibility with other manufacturers that may choose to support AAC in the future.

AAC-LD Stereo

AAC-LD Joint

These work similarly to the equivalent Layer-3 modes (see above). Two connections are required. These (and the other AAC-LD modes) modes are important since they offer significantly lower delay than any mode other than G.722.

Offers 14 kHz audio frequency response.

AAC-LD Mono 64

This encodes a single mono bit stream, normally using the audio from input A. This bit stream is fed to both ISDN B channels so it can be to feed identical mono to two sites.

Offers 14 kHz audio frequency response.

AAC-LD Mono 128

This use both B channels transmit a single audio channel using the audio from input A. Both B channels are used for the best quality and "coding headroom" later in the transmission path.

Offers 16 kHz audio frequency response.

AAC J-stereo 64

This mode, while it offering reduced audio bandwidth, allows stereo transmission over a single B channel. The resulting coded bit stream is output over both B channels (if dialed) allowing the identical stereo audio to be sent to two sites simultaneously).

Offers 10 kHz audio frequency response when the *Sample Rate* is set to 48 kHz and 7 kHz audio frequency response when the *Sample Rate* is set to 32 kHz.

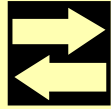

COMPATIBILITY TIP!

The Zephyr Xstream cannot receive two stereo feeds from the far end (after all, where would the audio be output?).

When connected to two different sites simultaneously, you can receive an audio feed back from each using G.722 or L3 Dual/Mono.

AAC Stereo

AAC J-Stereo

These work similarly to the equivalent Layer-3 modes (see above). Two connections are required. These modes are important since they offer the best quality ever over a single ISDN BRI circuit.

Offers 15 kHz audio frequency response, when the sample rate is set to 32 kHz and 20 kHz response when the sample rate is set to 48 kHz.

AAC Mono 128

This uses both B channels transmit a single audio channel using the audio from input A.

Offers 15 kHz audio frequency response when the sample rate is set to 32 kHz and 20 kHz response when the sample rate is set to 48 kHz.

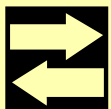

COMPATIBILITY TIP!

When two channels are required for transmission (i.e. for Stereo, J-Stereo, and Mono 128) an "inverse multiplex" (IMUX) scheme must be used to break the standard MPEG data stream into two streams for transmission.

In AAC and AAC-LD, the Zephyr Xstream uses the Telos Zephyr IMUX protocol.

AAC Mono 64

This encodes a single mono bit stream using the A audio input. This bit stream is fed to both ISDN B channels so it can be to feed identical mono to two sites.

Offers 15 kHz audio frequency response when the sample rate is set to 32 kHz and 20 kHz response when the sample rate is set to 48 kHz.

G.722 (Dual/Mono)

Compatible with many other brands of codecs. We use the SRT (Statistical Recovery Timing) method, which is the most common encountered by far.

G.722 acts similarly to the Dual modes discussed above. Audio input A is encoded and transmitted on "line 1" while Audio input B is transmitted over "line 2".

Offers 7.5 kHz audio frequency response. Delay is very low at 14 milliseconds.

L2 Stereo

L2 J-Stereo

These work similarly to the equivalent Layer-3 modes. Two connections are required.

L2 Stereo offers discrete stereo transmission with 7.8 kHz audio frequency response when the 48 kHz Sample rate is used if the transmission channel is 56 kbps. It offers 9.8 kHz frequency response when the 48 kHz Sample rate is used if the transmission channel is 64 kbps.

L2 J-Stereo offers 20 kHz audio frequency response when the sample rate is 48 kHz and 15 kHz response when the sample rate is set to 32 kHz.

	<p>HOT TIP!</p> <p><i>Of course you will want to use Layer 3 or AAC when supported at the far end.</i></p> <p><i>We strongly recommend Layer 2 Joint stereo over Layer 2 Stereo when transmitting stereo material in Layer 2 at 128kbps. While some loss of stereo image will occur, the reduced compression ratio required will provide noticeably improved fidelity (.i.e. reduced artifacts).</i></p> <p><i>Layer 2 stereo is appropriate only when the two channels to be transmitted are unrelated sonically and must therefore be kept separate.</i></p>
---	---

<h1>Z</h1>	<p>ZEPHYR CLASSIC VS XSTREAM COMPARISON!</p> <p><i>Some early Zephyr software releases refer to L2 Stereo as "L2 Dual". We changed the name for two reasons. This mode cannot be used to send two mono streams to two sites. And, because phase integrity of the two channels is maintained.</i></p>
------------	---

L2 Mono 128

This mode is very common mode used in the voice-over industry. It works in the same way as the other Mono 128 modes.

Offers 19Hz audio frequency response when the *Sample Rate* is set to 48 kHz and 15 kHz response when the *Sample Rate* is set to 32 kHz.

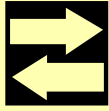

COMPATIBILITY TIP!

When two channels are required for transmission (i.e. for Stereo, J-Stereo, and Mono 128) an "inverse multiplex" (IMUX) scheme must be used to break the standard MPEG data stream into two streams for transmission.

In Layer-2, the Zephyr Xstream uses the CCS CDQ (TM) IMUX protocol. Most Layer-2 codecs support this method, allowing for compatibility among different codec manufacturers.

The Telos IMUX used in AAC and AAC-LD is published on our web site to support interoperability with other manufacturers implementing AAC and AAC-LD

L2 Mono 64

This encodes a single mono bitstream using the audio from the A input using the MPEG Layer-2 algorithm. Both 32 and 48 kHz sample rates are supported. This bit stream is fed to both ISDN B channels so it can be used to feed identical mono to two sites.

Offers 7.8 kHz audio frequency response if the transmission channel is 56 kbps. It offers 9.8 kHz frequency response when the transmission channel is 64 kbps.

L2 Half 64

This is the only mode in the Zephyr Xstream that supports 24 kHz for the sample rate. It is a mono mode. Other than the fact the 24 kHz sample rate is internally (and invisibly) used, its operation is the same as the other *Mono 64* modes.

Offers 8.6 kHz audio frequency response.

Receive:

Note that the easiest choice is to use the *Auto* selection. However, it can take longer to lock and achieve output audio, than if the correct *Receive* mode is set.

The appropriate *Receive* mode will be determined by the encoding or *Transmit* mode used at the far end. Section 10 (Applications Guide) includes charts detailing the correct *Receive* mode to use with the different *Transmit* modes for various codecs.

Until the Auto system has determined the correct receive mode to use, it will display (*Search*) for *Receive* mode on the default status and *CODEC* status screen. Once the correct *Receive* has been determined, that information will be displayed.

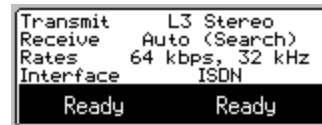

IMPORTANT!

The settings of the **Sample Rate** and **Bit Rate** (see below) are important as well as the **Transmit** and **Receive** settings. Note that these must be matched between the two units before the **AUTO Receive** mode will be able to function.

Note that if a transmission mode requiring two channels is used, and only one channel is dialed, the **AUTO** setting will not be able to find a match.

The bit rate will normally be changed automatically on incoming calls as this information is conveyed by the ISDN network.

It will be helpful to understand the following terminology when determining what *Receive* mode should be used:

64 - This is a Zephyr Xstream Transmit mode that requires only a single B channel to operate. The actual bit rate of that channel could be either 56 or 64 kbps. The correct *Receive* mode will also have "64" in it (for example "L2 64").

128 - This is a mono *Transmit* mode that requires two B channels (i.e. calls) to operate. The actual bit rate of those channels could be either 56 kbps (for a total of 112 kbps) or 64 kbps (for a total of 128 kbps). The correct *Receive* mode for a *Transmit* mode with "128" in the name will just have the name of the algorithm (for example "L2").

Dual/Mono - This is simply a special case of Mono 64. In the Dual Mono case the A audio Input source is sent over "Line 1" while the B audio Input source is sent over "Line 2".

J-Stereo - This is "Joint Stereo" and is the preferred stereo mode in most cases. The biggest exception is when stereo material will later be transmitted over a surround sound transmission system (i.e. for Video or Film production) in which case the Stereo mode should be used. All stereo modes require 2 B channels (2 calls) unless otherwise stated. The correct *Receive* mode for a *Transmit* mode with "J-Stereo" in the name will just have the name of the algorithm (for example "L2").

Stereo - This is "Discrete Stereo". The major use for this is when stereo material will later be transmitted over a surround sound transmission system (i.e. for Video or Film production) in. All stereo modes require 2 B channels (2 calls) unless otherwise stated. The correct *Receive* mode for a *Transmit* mode with "Stereo" in the name will just have the name of the algorithm (for example "L2") unless otherwise stated.

J-Stereo 64 - This mode, unique to AAC, is the only stereo transmission mode that does not require 2 B channels.

Half 64 - This is a special Layer-2 mode that operates at 24 kHz sample rate. The audio will be transmitted at 24 kHz sample rate regardless of the actual sample rate selected in the *CODEC* menu.

The Xstream's *Receive* modes are:

L3

Receives all Layer-3 modes except for the *L3 Dual/Mono* mode (and L3 mono streams at 56 or 64 kbps from other codecs).

L3 Dual/Mono

Can receive 1 or 2 L3 Mono streams at 56 or 64 kbps from other codecs. The audio bit stream connected to "Line 1" will be output on audio channel A, while the stream received on "Line 2" will be output on audio channel B.

L2

Receives all Layer-2 modes except for *L2 mono 64*.

L2 Mono 64

Receives *L2 Mono 64* (at 56 or 64 kbps) over "line" 1.

G.722

Receives *G.722*. Zephyr Xstream uses the Statistical Recovery Timing (SRT) synchronization method. This is a "Dual" mode and behaves the same way as the *L3 Dual/Mono* mode. The audio bit stream connected to "Line 1" will be output on audio channel A, while the stream received on "Line 2" will be output on audio channel B.

AUTO

This mode will attempt to determine the mode being sent from the far end and internally set the *Receive* mode to match. The *Sample Rate* must be matched for this to occur.

As the auto mode takes several seconds to determine the correct mode, there are times you may wish to use a specific setting for *Receive*. In this case, your receive mode must be set to decode the stream being sent from the far end. You will need to know the Transmit ("Xmt" or "Encoder") mode of the far end to set this correctly.

	<p>HOT TIP!</p> <p><i>The system will display the mode that was found by the AUTO algorithm on the default screen as well as the CODEC Status screen. You may wish to change your <i>Receive</i> setting to that mode. This will allow for the fastest audio lock if you disconnect and redial.</i></p>
---	--

AAC-LD

Receives all AAC-LD modes except for the *AAC-LD mono 64 mode*

AAC-LD Mono 64

Receives AAC-LD Mono 64 over "line" 1

AAC

Receives all AAC modes except for the *AAC mono 64* and *AAC J Stereo 64* modes

AAC 64

Receives AAC Mono 64 and AAC Stereo 64

	<p>HOT TIP!</p> <p><i>It is important to understand that the Transmit and Receive settings on two connected units may very well NOT match. This is because there are frequently times when it is appropriate to use a different coding mode coming versus going.</i></p> <p><i>The important thing to remember is that the local Transmit mode must be compatible with the Receive settings and capabilities of the far end unit.</i></p> <p><i>Whereas the local Receive mode must be compatible with the Transmit settings of the far end unit.</i></p>
--	--

Bitrate: (56 kbps; 64 kbps)

This is the bit rate used on each ISDN channel. This setting configures the codec section, and also tells the ISDN interface what rate call to place the call over the network. If both channels are dialed between the same two codecs, the available bit rate would be double this rate (i.e. 112 or 128 kbps) allowing the "Stereo" or "Mono 128" transmission modes.

This parameter should be matched between the Zephyr Xstream and the far end codec. Since the network must accommodate the rate selected, it is important to drop the call and redial if this parameter is changed during a call.

	<p>IMPORTANT!</p> <p><i>The Bitrate selection operates differently if the Interface selection in the third Tel screen is set to Ethernet or V.35 Single.</i></p> <p><i>For more about this option when used with those Interface selections see Appendix 6 (Special Operational Modes)</i></p>
--	--

	<p>COMPATIBILITY TIP!</p> <p><i>The Zephyr Xstream specifies the bit rate per channel. Since certain modes (i.e. stereo or mono-128) require two channels to operate, the total (aggregate) bit rate would be double the number displayed in these cases.</i></p> <p><i>This is important, as some other brands specify the total bit rate.</i></p>
--	--

	<p>ISDN TIP!</p> <p><i>Since this parameter specifies the bit rate placed over the dial up data network, it is important to understand the following: In some areas, only 56kbps or 64kbps service is available. In addition, since different network paths (trunk groups) are frequently used for the two rates, there are times where one rate may provide more reliable connections than the other.</i></p> <p><i>In our experience, the only sure way to know if a connection given between to particular points will work is to try it, first at 64kbps, and then at 56kbps, if the higher rate fails to connect (or is unreliable).</i></p>
--	--

	<p>HOT TIP!</p> <p><i>Since the network has to know the bit rate for a given call, this information is available to the Xstream on incoming calls. Therefore, the Xstream will switch to the rate of the incoming call.</i></p> <p><i>There is one exception however. If the Xstream already has a call in progress at a given rate, and a second call comes in (i.e. from a third codec) at the other rate, the unit will accept the call, but will not change bit rate (since that would cause a loss of audio to/from the original site). There will be no lock or audio from the site associated with the second call. In this case, the second site should drop the call, change rates to match, and redial.</i></p>
---	--

Sample (32 kHz; 48 kHz)

This is the digital sample rate used for transmission/reception of the coded audio by the codec section. Note that this rate may or may not be the same as the AES/EBU sample rate used on the input or output. The sample rate must be matched between your Zephyr Xstream and the codec at the far end for successful audio transmission. If the sample rate is not matched, you will either have: no lock, intermittent lock loss, or audio that sounds pitch shifted.

	<p>IMPORTANT TIP!</p> <ol style="list-style-type: none"> 1) <i>Zephyr Xstream only supports the 24kHz sample rate in MPEG Layer-2 (or when used in “IP streaming mode” where the selections for this menu are different). Therefore, the Sample Rate menu does not have this option. The “L2 Half 64” Transmit mode is used to achieve 24kHz operation in MPEG Layer-2.</i> 2) <i>The G.722 standard calls for a Sample Rate of 16kHz. This rate is used for G.722 regardless of the actual sample rate setting.</i>
---	--

	<p>HOT TIP!</p> <p><i>The sample rate choice affects the quality of your audio in three ways. Please keep the following in mind when selecting a sample rate for your application. Also, see Section 6 for additional information.</i></p> <ol style="list-style-type: none"> 1. <i>The higher the sample rate the greater the potential frequency response.</i> 2. <i>The greater the sample rate, the greater the number of bits in the raw digital audio stream. Since the ISDN channel capacity is fixed, the higher sample rate results in a higher compression ratio in the codec stage (i.e. there’s no such thing as free lunch).</i> <p><i>Therefore, paradoxically, the higher sample rate (all other factors being equal) will often result in lower quality audio (more compression artifacts). This will vary somewhat, depending on the source material. For this reason the 32 kHz sample rate is generally preferred over the 48 kHz rate.</i></p> <ol style="list-style-type: none"> 3. <i>The sample rate determines the “frame rate” through the DSP core. Therefore, the higher the sample rate, the lower the delay. This is one of the reasons we support the 48 kHz rate. This gives you the choice of reducing your delay by allowing a slight decrease in fidelity.</i> <p><i>Of course the powerful AAC-LD mode allows excellent audio performance along with low delay.</i></p>
---	--

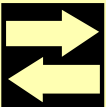
	<p>COMPATIBILITY TIP!</p> <p><i>Not all codecs support all sample rates. 32kHz is most commonly supported in MPEG Layer-3 whereas 48kHz is more commonly used in Layer-2.</i></p> <p><i>24kHz is sometimes seen in Layer-2. In this case set your Transmit or Receive to “L2 Half/24” and this Sample Rate will be used (regardless of the Sample Rate setting)</i></p> <p><i>16kHz is used with G.722 and is automatically employed whenever G.722 is used.</i></p>
---	---

	<p>ZEPHYR CLASSIC VS XSTREAM COMPARISON!</p> <p><i>Note: Not all Zephyrs support MPEG Layer-2. Very early units support MPEG Layer-3 and G.722 only.</i></p> <p><i>The Zephyr Classic and Zephyr Express do not support MPEG Layer-2 at the 32kHz Sample Rate. When communicating with a Zephyr or Zephyr Express in Layer-2, the 48 kHz sample rate should be used.</i></p>
---	--

	<p>IMPORTANT TIP!</p> <p><i>The Sample Rate selection operates differently if the Interface selection in the third Tel screen is set to Ethernet or V.35 Single.</i></p> <p><i>For more about this option when used with those Interface selections see Appendix 6 (Special Operational Modes)</i></p>
--	---

CODEC - Screen 3



A third press of the <CODEC> button shows the screen above.

The Compatibility option on this screen changes the format of the data used to transmit Layer 3 over ISDN for compatibility with some third-party codecs. You should leave this setting at Zephyr unless you are experiencing this particular incompatibility.

11.5 The TEL Menu

TEL – Screen 1: Status

```

AUDIO CODEC TEL SYSTEM
ISDN Status
Line 1: Ready
Line 2: Ready
...

AUDIO CODEC TEL SYSTEM
ISDN Status
Line 1: Conn 9280334
- 0:00:38
Line 2: Conn 2169280333
- 0:00:38
...
    
```

In ISDN or V.35 mode...

This screen shows the status of each of the two ISDN B channels. The status will vary depending on the *Interface* selected in the *ISDN* Menu, and can be as follows:

Status words when ISDN Interface is selected:

Inactive – This indicates that neither the built-in NT1 nor the S interface is active. This will be displayed if no ISDN line is present. It is also displayed on ETS 300 (Euro-ISDN) lines after periods of inactivity (the ETS 300 standard allows the central office switch to put the line to sleep).

SPID Pending – This option is only valid when the Telco selection of the TEL menu is set to "Nat.I-1" or "DMS Cust.". This indicates that the Xstreams internal NT1 has achieved "U synchronization" with the BRI circuit, or that the S interface connection to the external NT1 is active. This also could be displayed if the BRI is grossly misconfigured.

SPID Error - The SPID entered for the indicated channel is incorrect. You may have entered it wrong, or the Telco may have given you the wrong SPID (or entered the SPID incorrectly in their switch).

Ready – This indicates that an ISDN line is present. It indicates that all handshaking with the central office is complete and the line is ready to be used. Note: If *Ready* is displayed and the Xstream cannot make or receive calls you may have the *Telco* option set incorrectly or you may have omitted your *SPIDs*.

Conn: xxx - The channel is connected to "xxx". "xxx" is the caller ID of the calling party if available for calls originated from the far end, or the number dialed for calls originated by the Zephyr Xstream.

A call timer below, the line status, displays the length of time the call has been connected in the following format: Days-hours:minutes:seconds

Pending Seize - Outgoing call in progress; Request for call has been sent to the Telco switch and Zephyr Xstream is awaiting acknowledgment.

Seized - Outgoing call in progress; Telco switch has acknowledged the call request.

Proceeding - Outgoing call in progress. Telco switch has acknowledged the call request and is waiting for routing information from the network.

Outgoing Ring - Outgoing call in progress; far end has generated a call alert signal.

Ring: xxx - Incoming call from "xxx" has been detected and is being processed. "xxx" is the caller ID of the calling party, if available.

Accepting Call - Incoming call is being answered

Disconnecting - Request to disconnect has been made. Awaiting acknowledgement.

Ended - Request to disconnect has been made and the call has been cleared.

Inactive: The internal NT1 has not initialized. External NT1 (if any) is not active on the S interface. Also displayed on ETS300 lines that have been "deactivated" or put to sleep. Note this case is not unusual, and lines in this case will reawaken when used.

Note, this may also be displayed if the *Telco* setting in the *TEL* menu is set incorrectly.

ISDN TIP!

*If you reboot the Xstream and the line status shows **Ready & Ready**, but you cannot make or receive calls, check the following:*

*-Is the **Telco** selection in the **TEL** menu set correctly? Certain incorrect combinations may cause a false Ready indication.*

*-If your ISDN protocol requires **SPIDs**, have you entered them in the **TEL** menu (See below)?*

*-Is the **Interface** selection in the **TEL** menu set to **ISDN**? You won't be able to place calls if the ISDN interface is not selected.*



	<p>ISDN TIP!</p> <p>If the line status shows Ready & Ready and you can make calls, but cannot receive calls, check the following:</p> <p>-Is the Telco selection in the third TEL menu set correctly? If you have DMS Cust. ISDN (USA & Canada only) and your Telco is set to Natl. I-1 you may be able to place calls outgoing calls only.</p> <p>-Check your MSN/DN 1 & 2 entries in the second TEL menu. If incorrect numbers are entered here, you won't be able to receive calls. If you are in the USA these are required. Enter the correct DNs.</p>
---	--

Modem Status information when ISDN Modem Interface is selected (e.g. during or after an Xport mode call):

On Hook - POTS mode idle.

Off Hook - Line is in use.

Modem Detected - Modem carrier has been detected and modem training begun.

Connecting. - Modem "handshake start".

Connecting.. - Modem "Ranging" stage is complete.

Connecting... - Modem "Training" stage complete.

Connect - Modem connection is operational.

Connect Lock – Valid MPEG AacPlus data is being received and decoded.

Renegotiation Request - Far end has authorized modem re-negotiation. Audio will be re-established in 3-5 seconds. Or, far end has dropped the call. Or, modem operation is no longer possible, system will revert to Phone mode.

Retrain Request - Modem connection will be re-negotiated.

Modem Lost Sync - Modem connection has been lost; unit reverting to Phone mode

Status words when V.35 Interface is selected:

Inactive – This indicates that no V.35/X.21 clock signal is present on either V.35/X.21 port. Note: The *Bit Rate* setting in the *Codec* menu must be set appropriately. The front panel SYNC light also indicates the presence or absence of clock.

Active - This indicates that a valid V.35/X.21 clock is present on at least one of the two V.35/X.21 ports.

Conn – This indicates that a Carrier Detect (CD) signal is present for this V.35/X.21 channel. A valid V.35/X.21 clock is also present on one port. A call timer will be displayed on indicating the length of time CD has been asserted.

Status Screen when Ethernet Interface is selected:



The first Tel screen shows the number of attached decoders (players) whenever the *Interface* is set to *Ethernet*.

TEL – Screen 2:

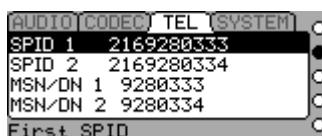

SPID 1

This is your first SPID (Service Profile Identifier) number. SPIDs are only used in the USA & Canada. If you have *ETS 300*, *INS 64* (Japan) or *AT&T Cust. (PTP)* for your ISDN protocol, you should leave this blank.

When you are using *Natl. I-1* or *DMS-100* for your *Telco* mode (see below), you must enter the correct Service Profile ID (SPID) numbers for the ISDN BRI here and below. Normally, the Telephone Company tells you this number when they confirm your order. Often it is found written on the line jack or punch block. *SPID1* corresponds to Line 1. Usually, the SPID is the area code+phone number+0101. However, we have seen some that include a two-digit prefix and a two-digit suffix, and many other variations are possible. See Appendix 4 for a list of known working SPIDs by Telephone Company.

Despite the last paragraph, you cannot assume anything about the SPID! If the above advice works, consider yourself lucky; if it doesn't work, there is no substitute for getting the correct SPID from your Telco!

Don't let the installer depart without leaving them. You've been warned!

For more on SPIDs see Section 7 (ISDN Basics) and Appendix 7,8 (Ordering ISDN).

SPID 2

This is the SPID for your second ISDN B channel. See above.



HOT TIP!

Most phone companies in the USA have settled on a standardized SPID format, based on the telephone number. This format is area code+7 digit phone number + 0101. For example, if your phone number were (321) 555-1234 then your SPID would be 32155512340101.

However, numerous formats were used in the past so older lines will probably be different. For a list of known working SPID formats, listed by telephone company, see Appendix 1.

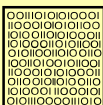

ISDN TIP!

In an emergency, to save a remote, you might be able to get a line to work without proper SPIDs by dialing into it. If it works, this fix is only temporary, and the line will fail to initialize next time the Zephyr Xstream is booted.

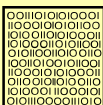

ISDN TIP!

*If you see **SPID ERROR** as your line status, your SPID for that channel is incorrect. In this case, check the SPID. For a list of known working SPID formats listed by telephone company see the Appendix. Section 13.4.5 (Deep Tech Information) has additional ISDN troubleshooting information.*

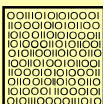

ISDN TIP!

TIPS ON SPIDS

1. Incorrectly entered SPIDs are the most common problem USA users have placing ISDN calls. Compare the SPIDs you have entered with the SPIDs provided to you by the phone company to be certain that you have entered them correctly. Do not add anything to your SPIDs.

2. Note that there are no hyphens, dashes (-), or spaces in SPIDs, so the system will not allow you to enter any non-numeric characters. If your installer has included them in the SPID, ignore them.

3. For a list of known working SPIDs by Telephone Company, see the Appendix 1.

4. If you have any questions about your SPIDs, call your phone company.

5. If you have AT&T Custom Point-to-Point or Euro-ISDN, you should not enter anything in the SPID fields.

ISDN TIP FOR BELLSOUTH CUSTOMERS!

Despite the fact the BellSouth originated the proposal for the standardised SPID (see above), many regional Bell South offices leave off the last two digits of the SPIDs when giving them to customers.

If you are a BellSouth customer and are given a SPID of the format: Area Code + 7 digits + 01 and you get "SPID Error" your correct SPID is probably Area Code + 7 digits + 0101 or Area Code + 7 digits + 0100.



MSN/DN 1 (Multiple Subscriber Number/Directory Number 1)

The use of this field depends on the ISDN protocol used on your ISDN BRI circuit.

Directory Numbers (National I-1 and DMS Cust.)

When you are using an ISDN protocol other than *ETS 300*, *INS 64*, or *AT&T Cust. (PTP)*, you must enter the "Directory Number" (DN) here. This is the first DN. This is simply the 7-digit telephone number.

A mis-entered DN will cause problems with incoming calls to that channel.

Multiple Subscriber numbers (ETS 300 and INS 64 only)

Used only when you are using the *ETS 300 Euro ISDN* or *INS 64 Japanese ISDN* for your Telco mode, and another ISDN device is sharing the line with the Zephyr Xstream. MSN1 corresponds to the first B channel. This is simply one of your assigned telephone numbers (often you will be assigned 3 or more).

If no MSNs are entered, the first call to any of the numbers associated with the ISDN circuit will ring in to the Xstream as "line 1" if that "line" is idle. If "line 1" is in use, the call will ring in on "line 2". This is precisely the same behavior as when a line with the "AT&T Custom PTP" protocol is used.

ETS-300 ISDN service frequently includes 3 MSNs. Typically one of these would be entered in all voice terminals, with the others entered in the Xstream.

A mis-entered MSN will cause problems with incoming calls to that channel. Since these are not needed, you should leave them blank unless specifically needed.

MSN/DN 2

The second MSN or DN. See above.

TEL – Screen 3:



Telco:

This is your ISDN protocol. This must be set correctly for the Xstream to make or receive calls. Select the correct value for your ISDN BRI circuit. Section 7 (ISDN Basics) has additional background information on ISDN.

The correct setting will be determined by the type of Central Office switch providing your ISDN service. Note that some switches offer more than one protocol. See below for a table showing the correct settings for commonly used switches.

TELCO SWITCH	BRI LINE PROTOCOL	CORRECT TELCO SETTING	NOTES:
AT&T/Lucent 5ESS	AT&T Custom Point to Point	AT&T Cust. (PTP)	No SPIDs. One phone number accesses both channels
AT&T/Lucent 5ESS	National ISDN-1 National ISDN-2	Natl. I-1	SPIDs required DNs required
NORTEL DMS-100	Custom Functional	DMS Cust.	SPIDs required DNs required
NORTEL DMS-100	National ISDN-1 National ISDN-2	Natl. I-1	SPIDs required DNs required
JAPAN NTT	Ins 64	Ins 64	No SPIDs MSNs may be used (optional)
EUROPE & Others (Various switches)	ETS 300	ETS300	NO SPIDs Used in most countries including Europe, Australia, South Africa, and most of South America. Multiple terminals frequently share the S interface. MSNs may be used (optional)

	<p>ISDN TIP!</p> <p>More on Telco Protocols: Guessing the Telco setting in Canada & USA:</p> <ul style="list-style-type: none"> * If you were given only a single phone number and no SPIDs try AT&T Cust (PTP). * If you were given 2 SPIDs with the format: 01+7 digit phone #+0 try AT&T Cust (PTP). * If you were given 2 SPIDs with the format: 01+7 digit phone #+000 or 01+7 digits +011 try Natl.I-1. * If you were given 2 SPIDs with the format: area code+7 digit phone #+4 digits (for example 0101, 0100, 0111, or 1111) try Natl.I-1. If that fails Try DMS Cust. * If you were given 2 SPIDs with the format: area code+7 digit phone #+1 digit (for example 1, or 0) try DMS Cust. If this fails try Natl.I-1. * If you were given 2 SPIDs with the format: area code+7digit phone #+2 digits (for example 01, 11, 02, or 00) try DMS Cust. If that fails try Natl.I-1. * If you were given 2 SPIDs with the format: area code+7digit phone #+3 digits (for example 000,001) try Natl.I-1. If that fails try DMS-Cust. * If you were given a single phone number and a single SPID with the format: of 01+7 digit phone#+0 try AT&T Cust (Do not enter this SPID). * If you were given a single phone number and a single SPID with the format: of 01+7 digit phone#+00 try Natl.I-1. If that fails try AT&T Cust. * If you were given a single phone number and a single SPID with the format: of area code+7digit phone#+4digits (for example 0101, 0100, 0111, or 1111) Try Natl.I-1. If that fails try DMS Cust.
---	--

<h1>Z</h1>	<p>ZEPHYR CLASSIC VS XSTREAM COMPARISON!</p> <p>Zephyr (classic) and ZephyrExpress use the Telco option "Natl I-1" for both the National ISDN protocol and the DMS Custom functional ISD protocol.</p> <p>Zephyr Xstream distinguishes between these two protocols so the correct choice must be made.</p>
------------	---

Auto Ans.

This determines if the Xstream will automatically connect to incoming voice calls, data calls, or both types of calls.

None

No calls will be answered automatically. Zephyr Xstream will make a warbling sound and the caller ID of the incoming call (if available) will be displayed. To accept the call press <SEL>. To reject the call press <▲> or <▼> then <SEL> and the far end party will get a "fast busy" ("engaged"/"congestion") for POTS or G.711 calls, or a "Call Rejected" cause 21 or "Normal call clearing" cause 16 for ISDN calls.

All

All calls, regardless of call types, will be answered automatically.

ISDN

Circuit Switch Data calls (i.e. callers from a Zephyr Xstream when the Call Type is set to "Zephyr") will be answered automatically. Circuit Switched Voice (i.e. POTS/G.711) calls are treated as if "none" was selected.

Phone

Circuit Switch Voice calls (i.e. callers from an Xport on a POTS line, a regular telephone, or a Zephyr Xstream when the Call Type is set to "Phone") will be answered automatically. Circuit Switched Data calls are treated as if "none" was selected.

Interface

The Interface selection will activate one of the following ports of the Zephyr Xstream

ISDN/ISDN Modem

Either of these selections will enable the Zephyr Xstream's built-in ISDN interface, if present. The *ISDN Modem* selection loads the code required to talk to the Zephyr Xport connected to a POTS (analog) line. When call is placed in *Phone Mode* (in the *DIAL* menu), the *Interface* setting will change between *ISDN* to *ISDN Modem* automatically. This will also occur when an incoming "voice" call is answered, and can be ignored by the user; if an ISDN mode call is subsequently made, or received, the unit will switch back to *ISDN* interface automatically.

A note regarding *Mode* detection and Interface switching of incoming calls:

The ISDN network will signal if a call is "voice" or "data" call. Since modems use POTS technology, calls from Xport are considered "voice" calls. In the case of a "data" call, no other information is needed; the Xstream will switch from the *ISDN Modem Interface* to *ISDN*, if necessary, and answer the call.

If the network indicates an incoming call is a "voice" call, the Xstream must determine if this is a call from a telephone, or from the modem of an Xport. Therefore, the Xstream switches the *Interface* selection from the *ISDN* to *ISDN Modem*, if necessary, answers the call, and then listens for a modem carrier tone. If no modem tone is detected, the unit un-mutes the audio and the call is considered a "Phone" *Mode* call. If a modem tone is detected, the Xstream's modem will begin negotiating with the Xport.

Therefore, all incoming "voice" calls have a short delay before audio is heard.

V.35 Split

This selection will enable the Xstream's built-in V.35/X.21 interface, if present.

The *V.35 Split* works the same way as the V.35 mode on the Zephyr classic. The same Inverse Multiplexing (IMUX) method will be used as if the *Interface* were set to *ISDN*. The codec selections in *V.35 Split* are also the same as for *ISDN*. Note that the line status words on the default *Tel* menus have different meanings when V.35 is selected (see above). See Appendix 6 (Special Operational Modes) for more information.

V.35 Single

This selection will enable the Xstream's built-in V.35/X.21 interface, if present. Section 9 (V.35/X.21) has more details on the operation of the V.35 interface.

In *Single V.35* mode a single MPEG compliant bitstream is generated and output over both V.35 ports. Note that the Line status words on the default menu and the *Tel* menu have different meanings when V.35 is selected. See Appendix 6 (Special Operational Modes) for more information.

	<p>IMPORTANT!</p> <p><i>The following selections in the CODEC menu will have different options when the Interface is set to V.35 Single.</i></p> <ul style="list-style-type: none"> • Transmit • Receive • Bit Rate <p><i>See Appendix 7 (Special Operational Modes) for additional Information.</i></p>
--	--

This selection adds additional flexibility to the Xstream. For example, a single 128 kbps dedicated synchronous circuit could be used instead of two 64 kbps circuits.

This also allows transmission of audio at 128 kbps and higher (up to 384 for Layer 2 and AAC, and up to 256kbps for Layer 3). Operating at such reduced compression ratios give maximum "coding headroom" for further perceptual coding cycles elsewhere the transmission chain. And, ITU "indistinguishable quality" audio is achieved with many of the coding algorithms at the higher bit rates.

Z	<p>ZEPHYR CLASSIC VS XSTREAM COMPARISON!</p> <p><i>The Zephyr classic's V.35 interface supports only the V.35 Split mode of operation.</i></p> <p><i>You asked for the ability to send a single 112 or 128 kbps bit stream. The Xstream offers this via the V.35 Single mode, as well as rates up to 384 kbps for use when quality is critical, or multiple coding cycles are anticipated.</i></p>
--	---

Ethernet (SIP) and Ethernet (RTP)

This selection enables Zephyr Xstream's built-in Ethernet interface for audio coding and/or decoding. This allows for transmission and reception of audio over Internet Protocol (IP) based networks.

The (SIP) and (RTP) designations refer to what protocol is used to establish communication. SIP (Session Initiation Protocol) connections are bi-directional. By 'dialing' another Zephyr Xstream, you request a return feed as well.

RTP (Real-time Transport Protocol) is a mono-directional, 'push only' mode. When you 'dial' another Zephyr Xstream in RTP mode, you send audio to the remote site, but receive nothing in return unless the remote operator manually initiates a connection back to the studio.

Appendix 6 covers this topic in detail.

	<p>IMPORTANT!</p> <p><i>The following menus will have different options when the Interface is set to Ethernet.</i></p> <ul style="list-style-type: none"> • CODEC • DIAL
--	--

Prefix:

This number is appended to the beginning of every number dialed. Useful when a "9" or other digit is required for access.

	<p>DEEP TECH NOTE!</p> <p><i>Long Distance services that rely on "in-band" tones (i.e. DTMF) to convey password information to the service provider cannot be accessed on Circuit Switched Data (Call type = Zephyr) data calls.</i></p> <p><i>This is because there is no audio path to send tones. Only if the network had an MPEG codec, would it be able to "hear" the tones.</i></p> <p><i>The entire call setup string is sent as digital information on the D channel.</i></p>
---	--

TEL - Screen 4

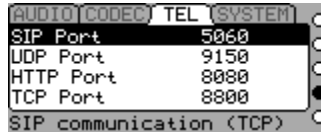

This screen has setup information that is only needed when using on off the *Ethernet* options for *Telco* (see above). For more information see Appendix 6, Special Operational Modes.

IP ports to be used by the streaming system are listed on the Telco configuration page in all modes. (HTTP page shown below)

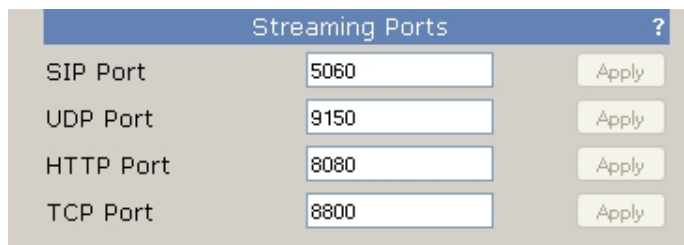

SIP Port (Default 5060)

SIP uses a TCP port, as its communication is bidirectional. The SIP port is what is used for the connection protocol, that layer that initiates the two RTP streams. The SIP port must match on both ends of a connection.

UDP Port (Default 9150)

RTP streams are sent and received over the UDP port. This port is used for both RTP and SIP modes, as SIP negotiates the creation of RTP streams. The UDP port must match on both ends of a connection.

HTTP Port (Default 8080)

The TCP port used for HTTP streaming only (normal web-pages are also served over HTTP, but these are sent over port 80, the usual port to which a web browser connects). A player which supports HTTP streams can connect using the usual port notation (e.g. <http://www.xxx.yyy.zzz:PORT>).

Note that prior to 3.0.1p, the Zephyr Xstream used port 8000 for HTTP streaming.

For stability, this streaming option should only be used for debugging, not on-air delivery or monitoring.

TCP Port (Default 8800) This port is currently unused.

TEL – Screen 5:



DTMF: (On; Off)

This enables/disables DTMF "Touch Tones" when connected on a voice call (i.e. call type = "phone"). These are useful for navigating through voice menu systems.

We offer the option of turning this off in the case that you may be entering information with the keyboard while dialed up on a voice call.

Redial

Sets the delay between automatic ISDN redials, or disables the feature. If an outgoing call is active when the Xstream loses ISDN connectivity or power, it will attempt to re-establish the call as soon as the error state is cleared (that is, when the ISDN comes back to life, or power is restored to the Xstream). You can adjust the time between these attempts, or disable them entirely. The redialing feature is also used when attempting to dial via contact closures and v.35 roll-over (see next item).

ISDN Backup

On an Xstream with both a v.35/x.21 card and an ISDN card, you can enable a rollover in case of v.35/x.21 failure. If you choose to enable this feature, this menu item will allow you to select a dial setup (any of your first ten) to be used. Note that by enabling this feature, you also allow ISDN calls to switch the Xstream from v.35/x.21 mode to ISDN mode (This is necessary because while one side of the high speed serial connection may see a failure, the other side could be operating as usual. In this case, when the side seeing the failure condition switches to ISDN mode and redials, the other side must respond to the ISDN request).

11.6 The SYSTEM Menu



SYSTEM - Screen 1



This menu gives summary and troubleshooting information about the system:

- Uptime - The times since the system was last powered up or rebooted.
- Loopmode - The currently selected *loop mode* set in the *SYSTEM* menu (see below).
- Version - Software version running on the unit
- Interface - The currently selected *Interface* in the *TEL* menu.

SYSTEM - Screen 2



This menu has the most frequently used *System* menu items. These are:

Contrast

This allows you to change the contrast of Xstream's LCD display to accommodate differing room lighting or viewing angles.

Volume

No, this doesn't belong in the *AUDIO* menu! This volume selection is to adjust the volume of the different sounds the Xstream makes when keys are pressed, calls connect or other things happen.

rs232

This allows you to easily set the bit rate of the Zephyr Xstream's RS-232 port on the rear panel. Rates from 300 bps to 57.6 kbps are supported. The other serial port parameters are:

- Data Bits: 8 bits
- Parity: None
- Stop Bits: 1
- Flow control: none

About

This gives you information about your Xstream.

SYSTEM - Screen 3

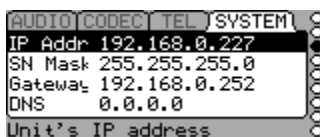

Pressing the *SYSTEM* button a third time shows this screen with the selections needed to configure your IP (Internet Protocol) settings. You won't need to enter this information to operate the unit from the front panel. You will need to enter this information if you will be connecting to the Xstream's Ethernet port (i.e. will be using the *Ethernet* mode, or will be controlling the unit remotely using this port).

You will also need to enter these items when the time comes to update the Xstream's operating software.

The screenshot shows a web browser interface for the Xstream device. At the top, there is a navigation menu with links: Home, Status, System, Telco, Codec, Audio, Autodial, LiveWire, LiveWire Meters, LiveWire QoS, and Administration. The main content area is divided into three sections:

- IP settings:** This section contains five input fields: Host name (containing '2K9-II'), Network address (containing '192.168.0.227'), Netmask (containing '255.255.255.0'), Gateway (containing '192.168.0.252'), and NTP server (containing '0.0.0.0').
- User password:** This section contains two input fields: 'New password' and 'Retype new password', both containing asterisks to indicate masked text.
- Firmware version:** This section shows the hardware revision as 'rev. 2'. It offers two radio button options: 'Primary Bank' (selected) and 'Secondary Bank'. The 'Secondary Bank' option is accompanied by a checkbox labeled 'commit this version to Bank 0'. A warning message below states: 'Warning: System will reboot after changing current bank.'

An 'Apply' button is located at the bottom center of the form.

IP Addr

This is the IP address for this Xstream. As with any computer on an IP network, the Zephyr Xstream must have an IP address before it can be used over the network. This address must be unique, so you'll have to ask whoever manages your network to give you this number. This is a "fixed" or "static" IP address.

If you plan to use the web browser to setup your Xstream, you will first have to set its IP address here. You may connect the Xstream to your LAN or use a crossover cable to your PC. Make sure the PC also has an IP address in the same range as the Xstream.

Actually, an IP address is a series of 4 numbers separated by periods. This is a numeric-only field; enter the numbers using the dial pad. Both # and * will give you a period. As usual, the ^ key will backspace if you make a mistake, or need to delete an old entry.

SN Mask

This is your subnet mask. The default 255.255.255.0 is usually fine. Change this only if your Network administrator tells you to. This is also an IP address, see the rules above.

The subnet mask is to determine the size of your "local" network. All packets addressed to a destination outside this "local" area are sent to the gateway node entered in the next selection.

Just as with the IP address, the Subnet mask is a series of 4 numbers separated by periods. Enter the numbers using the dial pad. Both # and * will give you a period. This is a numeric-only field; enter the digits as described above. As usual, the ^ key will backspace if you make a mistake or need to delete an old entry.

Gateway

This is needed only when using IP to communicate with other equipment outside your local network. It is required if you are downloading new software directly from the Telos FTP site. This is also an IP address, see the rules above.

This is the IP address of a gateway router connecting you to the internet. It is an IP address just as with the previous items and is entered in the same way. You will need to get this from your network administrator or internet service provider. This is a numeric-only field; enter the digits as described above.

DNS

DNS is needed only when downloading software directly from the Telos FTP site. This is an IP address, see the rules above.

This is the IP address of the DNS (Domain Name Server) you will be using. It is an IP address just as with the previous items and is entered in the same way. You will need to get this from your network administrator or internet service provider.



HOT TIP!

If you need to "borrow" the IP address of a Windows computer to use when updating your extreme, here are some tips:

- 1. Go to the MS-DOS command line of the Windows machine (Run " cmd <enter>" for Win 2000 or Win NT; or Run "command <enter>" for Win 95 or 98.*
- 2. From the command line type "ipconfig <enter>". The IP address, and default gateway for that machine will be displayed. Write down this information.*
- 3. Power off the computer that you just obtained this information from (or disconnect it from your network)*
- 4. Enter this IP address and gateway into the Xstream*
- 5. Connect the Xstream to your network.*
- 6. Be sure to delete these entries from the Xstream when you are finished. You can then power up the computer.*

SYSTEM - Screen 4

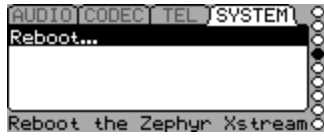

Current Versions

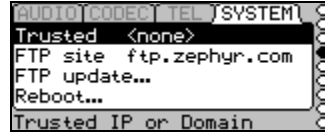

** Legacy Versions*

***Trusted**

<Reserved> There are no user settings.

***FTP Site**

This setting is used for updating earlier units. If this option is not present you have the later unit with the 100 Base-T Ethernet and Livewire capability. See Section 13 for how to upgrade the Xstream. This is the site to which the Xstream will download new software from. If your firewall allows FTP access, you can use the default which is ftp.telos-systems.com . Or, you can enter the IP address of a local FTP server.

This can be an IP address (see the rules above) or it can be an alphanumeric entry.

	<p>DEEP TECH NOTE!</p> <p><i>When an alphanumeric entry is present, a domain name server (DNS) is queried for the IP address of the computer using that domain. The reason we do so is that while the Zephyr.com domain will remain constant, the IP address of our FTP server (ftp.zephyr.com) might very well change periodically.</i></p> <p><i>See below for a HOT TIP! on how to determine the current IP address of a given FTP server.</i></p>
---	--

***FTP update**

This setting is used for updating earlier units. If this option is not present, you have the later unit with the 100 Base-T Ethernet and Livewire capability. This option initiates the software update process.

See Section 13 for additional information. You must enter an IP address and subnet mask (see above). You will also need a gateway and DNS if you will be downloading software directly from the Telos FTP site.

* Note: these options found only in older versions of the Zephyr Xstream.



IMPORTANT TIP!

The software download process must not be interrupted. Be sure your Xstream is connected to a reliable source of power before proceeding. Do not power off the unit until the software update is complete, or the unit has displayed an error and aborted the update process.



HOT TIP!

If you don't know a valid DNS (domain name sever) IP address, you can still update your Xstream by obtaining the IP address of the FTP computer as follows:

1. *Go to the MS-DOS command line of the Windows machine (Run " cmd <enter>" for Win 2000 or Win NT; or Run "command <enter>" for Win 95 or 98.*
2. *From the command line type "ping ftp.zephyr.com <enter>"*
3. *You should receive a reply. If you do not get a reply check with your IT manager for assistance - your firewall may not allow FTP access. The reply will include the current IP address of the Telos FTP server.*
4. *Enter this IP address as "FTP site" in the Xstream.*

Reboot

This option is used to restart the Xstream without cycling power. It can be handy. The Xstream is designed for long-term operation without user intervention. If you frequently experience problems that seem to be solved by rebooting, be sure to contact Telos with all relevant details so we can assist you in determining the cause.

SYSTEM - Screen 5

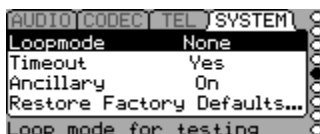

The fifth *SYSTEM* menu has options, as follows:

Loop mode

This allows you to activate various loop modes used to troubleshoot the unit and its environment. This should normally be set to *None*.

**HOT TIP!**

The **AUTO Receive** mode (in the **CODEC** menu) may not work in the **ISDN** loop mode depending on the **INTERFACE** option selected (in the **TEL** menu).

Therefore, we suggest manually setting the **Receive** mode when performing tests with this option.

Audio

Loop your input (analog or AES as the case may be) to your output. You should hear your own audio without any delay or coding artifacts.

ISDN

Send the data coming in the ISDN line back out that interface. Simultaneously, it loops the encoder's output to the decoder's input.

If your *Transmit* and *Receive CODEC* menu settings are compatible with each other, you should receive your own audio back with a delay and quality commensurate with the mode used. This tests approximately 70-85% of your Xstream's functionality, and makes an easy way to audition the various coding algorithms without an ISDN line present.

If you are connected to another via ISDN or V.35 and that site's *Transmit* and *Receive CODEC* menu settings are compatible with each other they should receive their own audio back with a delay and quality commensurate with the mode used.

V.35

Send the data coming in the ISDN line back out that interface. Valid V.35 clock must be present at the rate set for bit rate in the *CODEC* menu.

Timeout

This determines whether the system will return to the default screen after a period of inactivity. The default setting is "Yes" meaning that the system will return to the default menu after 120 seconds of inactivity.

Ancillary

The usual setting for this parameter is "On," which is the default. In the rare case of problems communicating with an obscure codec, you can try setting this "Off". When communicating with the Zephyr Xport this must be set to "On".

Restore Factory Defaults...

This selection allows you to clear all settings of your Xstream. All menu options will be returned to the factory default settings. Don't use this option unless you are sure you wish to erase these settings.

You will be prompted with a WARNING screen inquiring if you really wish to erase all your settings. Press the <SEL> button (or any of the MENU buttons) if you wish to abort.

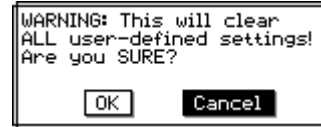

If you choose to proceed with erasing your settings, select *OK* by pressing <▼> or <▲> to select *OK*. Then press <SEL> to proceed.

In rare cases where the Zephyr Xstream's internal memory has become corrupted, the *Restore factory defaults* selection may help clear up the misbehavior of the unit.

SYSTEM - Screens 6 & 7

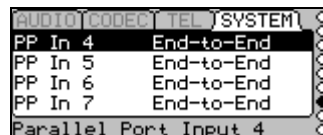
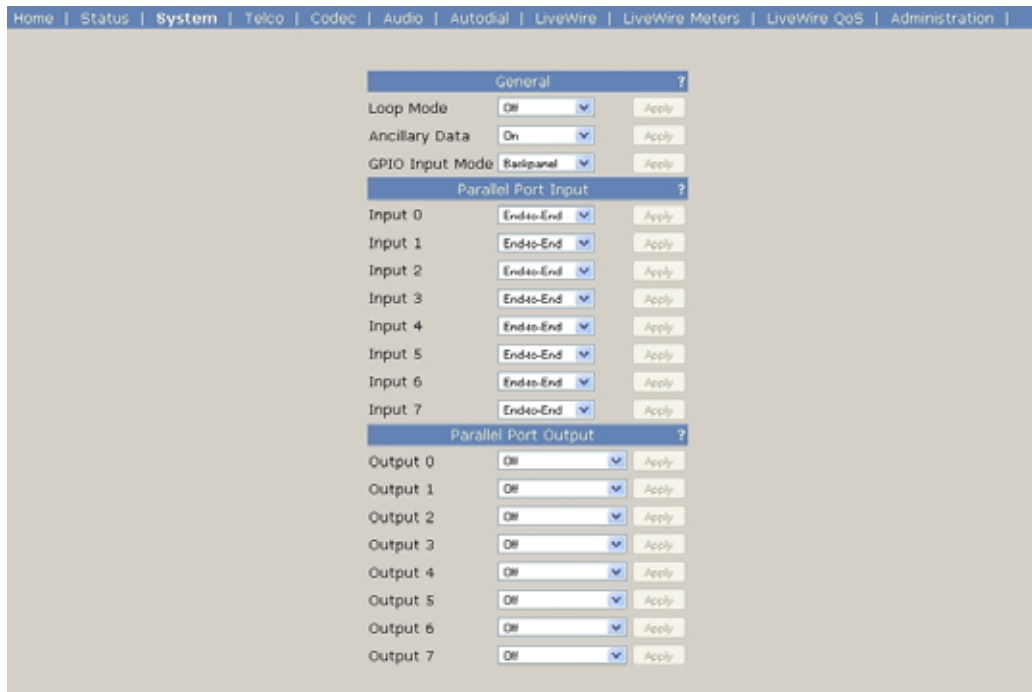

SYSTEM Menus 6 & 7 determine the function for each of the eight parallel inputs of the serial port. There are eight inputs, numbered 0 through 7. Each input can be set to any of the following values.

PP in 0 to PP in 7

End-to-End

This option is used to pass contact closure information to the far end using the ancillary data channel present in certain codec modes (see Sections 12.1, 3.2 & 3.4).

	<p>HOT TIP!</p> <p><i>An ancillary data channel will only be present in a given transmission direction if the receive codec is "locked" and one of the following codec modes is employed in that direction.</i></p> <p><i>AAC (all modes), AAC-LD (all modes), Layer 3 (all modes) Layer 2 mono 64</i></p>
---	---

<p style="font-size: 2em; font-weight: bold;">Z</p>	<p>ZEPHYR CLASSIC VS XSTREAM COMPARISON!</p> <p><i>NOTE:</i></p> <ol style="list-style-type: none"> 1. <i>The Zephyr Classic and Zephyr Express do not support Ancillary data in Layer 2.</i> 2. <i>In Layer 3 Zephyr Classic can send and receive ancillary data to and from a Zephyr Xstream. Inputs 0-3 on the Zephyr correspond to Outputs 0-3 on the Xstream and vice versa.</i>
---	--

Dial Setup 0 (Panic Dial)

Grounding an input set to this option will cause the Xstream to drop any active ISDN call (s) and to connect as specified in *Dial Setup 0*. Will remain connected so long as the associated input remains asserted (i.e. grounded).

	<p>HOT TIP!</p> <p><i>If there are no phone numbers entered in Dial Setup 0, triggering this input will merely cause the codec to hang up. If Dial Setup 0 includes codec information, these modes will be set as well. See Section 4.2 (introduction to the Menu system)</i></p>
---	--

Dial Setup 1...7

See above. Performs the same function for *Dial Setup 1...7*.

SYSTEM - Menus 8 & 9

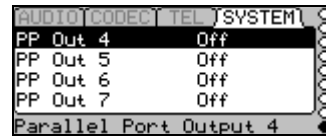
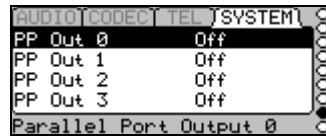

PP Out 0 to PP Out 7

SYSTEM Menus 8 & 9 determine the function for each of the eight outputs of the serial port. The option for reach output can be separately set to any of the following values. For more information on the Parallel port hardware interface see Sections 3.2 (Guided Tour of the Hardware - Non Mixer Version) and Section 3.3 (Guide Tour of the Hardware MX/P).

For more information on Livewire GPIO and how it applies to the Xstream's parallel ports, please see Section 8: LIVEWIRE – IP Audio.

ON

Forces this output to the "true" state. This will cause the input to sink current thereby activating an external device. This mode is intended for troubleshooting.

OFF

Forces this output to the "false" state. Input will become high impedance with regards to ground and will "float" to 5 volts due to the built in pull up resistor. This mode is intended for troubleshooting.

Mixer On (MX and MXP only)

Causes this output to go the "true" state whenever one of the front-panel mixer inputs is assigned to A, B or Both channels. This can be connected to a local "on-air" signal or can be connected to an input to pass this indication to the far end.

1 AND 2 Conn

Causes this output to go the "true" state whenever both Line 1 and Line 2 are in the "Connected" state (as indicated on the first *TEL* menu).

1 OR 2 Conn

Causes this output to go the "true" state whenever either Line 1 or Line 2 or both are in the "Connected" state (as indicated on the first *TEL* menu).

Line 2 Conn

Causes this output to go the "true" state whenever Line 1 is in the "Connected" state (as indicated on the first *TEL* menu).

Line 1 Conn

Causes this output to go the "true" state whenever Line 2 is in the "Connected" state (as indicated on the first *TEL* menu).

Lock A* AND B*

Causes this output to go the "true" state whenever both Lock A and Lock B are "on" (as indicated on the corresponding front panel LEDs).

Lock A* OR B*

Causes this output to go the "true" state whenever either Lock A or Lock B or both are in the "on" state (as indicated on the corresponding front panel LEDs).

Lock B*

Causes this output to go the "true" state whenever Lock A is in the "on" state (as indicated on the corresponding front panel LED).

Lock A*

Causes this output to go the "true" state whenever Lock A is in the "on" state (as indicated on the corresponding front panel LED).

* Some Xstreams have a "Lock 1" and "Lock 2" LEDs while others have "Lock A" and "Lock B" LEDs.

End-to-End

Causes this output to follow the state of the corresponding Input of a Zephyr to which it is locked. When no connection is present (or a coding mode is used that does not support ancillary data), this output will go to the false state.

11.7 Special Menus: Auto, Dial, & Drop

Step by step instructions on using these keys are located in Section 4.2. In this section we will go into additional details about the DIAL menu and will present advanced information about how the Dial Setups work under special circumstances.

The *DIAL* menu

The *DIAL* menu appears after the *Dial* button has been pressed and looks like the following:

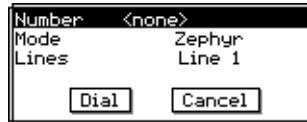

If you wish to dial a data call to another ISDN codec (*Mode* = Zephyr) you can simply enter the desired number and press <DIAL> again. A second call can be placed on "Line 2" by pressing <DIAL> a third time.

Pressing <DIAL> twice, without entering a number, will connect to the last number dialed on that line, in the same *Mode* used for the previous call, making it easy to reconnect if accidentally disconnected.

To drop all calls in progress, simply press <DROP> four times. This sequence is illustrated here.

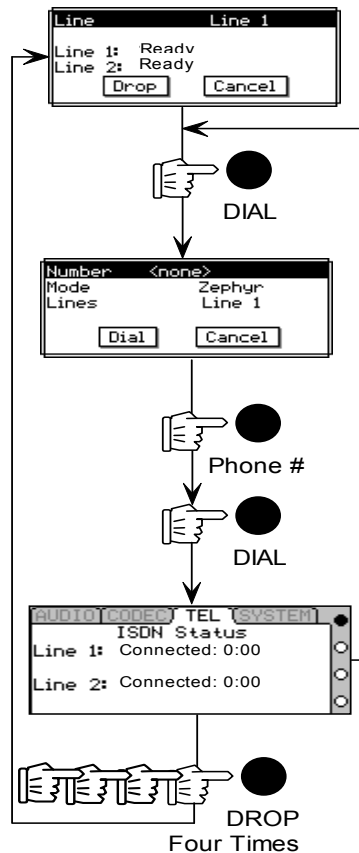

**IMPORTANT TIP!**

The **Number** field in the **DIAL** menu is different from other entry fields in the Zephyr Xstream. It is **NOT** necessary to press <SEL> before entering the number to be dialed.

While we like consistency, this field is used so often, it made sense to make it easier by doing this. It also makes operation more similar to the Zephyr classic.

If you wish to specify the *Line* to be used, or use a *Mode* other than the default (i.e. other than Zephyr) you can do so. After entering the number, press <SEL>, then use the <▲> or <▼> keys to move to the desired menu selection, and press <SEL> again to change the item. Repeat this process till all items are set as desired.

Once you have set the *Line* and *Mode* press <DIAL> to make the connection.

The available modes are:

- *Zephyr* - Places a "data" mode call at the rate indicated in the *CODEC* menu.
- *Phone* - Places a "voice" mode call according to the G.711 standard. This allows placing a call to any standard telephone line. In effect, this makes your Xstream into a telephone coupler.
- *Xport* - Places a "voice" mode call according to the G.711 standard and loads Xstream's modem code into DSP to allow communication with a Zephyr Xport connected to a POTS (analog) line. When call is made in this mode, the *Interface* setting, in the *TEL* menu, will change from *ISDN* to *ISDN Modem* automatically. This will also occur when an incoming "voice" mode call is answered and can be ignored by the user (if an ISDN mode call is subsequently made, or received, the unit will switch back to *ISDN* interface automatically).

A note regarding *Mode* detection of incoming calls:

The ISDN network will signal if a call is a "voice" or "data" call. Since modems use POTS technology, calls from an Xport on an analog line are considered "voice" calls. In the case of a "data" call no other information is needed; the Xstream will switch from the *ISDN Modem Interface* to *ISDN*, if necessary, and answer the call.

If the network indicates an incoming call is a "voice" call, the Xstream must determine if this is a call from a telephone, or from the modem of an Xport. Therefore, the Xstream will switch from the *ISDN Interface* to *ISDN MODEM*, if necessary, answer the call, and then listen for a modem tone. If no modem tone is detected, the unit un-mutes the audio and the call is considered an "Phone" *Mode* call. If a modem tone is detected the Xstream's modem will begin negotiating with the Xport.

Therefore, all incoming "voice" calls have a short delay before audio is heard.

The *DROP* menu

The *Drop* menu is activated by pressing the <*DROP*> button once. It looks like this:

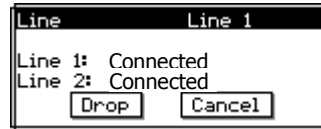

The system will default to *Line 1* if that line is in use. It will default to *Line 2* only if *Line 1* is not in use. Press <*DROP*> a second time to drop the line shown.

To drop a *Line* other than the line shown, press the <*SEL*> button, then press <▲> or <▼> to select the desired *Line(s)*. To drop the *Line(s)* press <*DROP*> again.

To easily clear both ISDN lines simply press <*DROP*> four times.

The *AUTO* menu

The *AUTO* menu is used to enter or activate *Dial Setups* and *Location Setups*.

Dial Setups

Dial Setups are very similar to the "Auto Dial Setups" used in the classic Zephyr. Each of the 100 dial setups consists of several pieces of information. See Section 4 (Basic Operation and Installation) for information on creating and using Setups.

- A *Setup* number – this 2 digit number (00 to 99) can be used to instantly access a given setup.
- An alphanumeric *Name*
- *Number 1* (optional) – A telephone number to be dialed on "Line 1"
- A "mode" for number 1 – Either *Zephyr* for a codec call, *Xport* for a call to a Zephyr Xport using a POTS line, or *Phone* for calls to a standard telephone.
- *Number 2* (optional) – A telephone number to be dialed on "Line 2"
- A "mode" for number 2
- *Include* selection. This allows you to include *CODEC* menu settings (optional) – This is a snapshot of all settings of the *CODEC* menu. This allows the unit to automatically change to the settings used with a given site based on the *Dial Setup* used.

	<p>HOT TIP!</p> <p>If you are using one of the Xstream's V.35 interface modes (see Section 9) you can use Dial Setups without phone numbers to conveniently changes modes.</p> <p>If a setup containing a phone number is activated while the Interface (in the third TEL menu) is set to V.35 Split, or V.35 single, the system will change the interface to ISDN so that the number(s) may be dialed.</p>
---	--

<p>Z</p>	<p>ZEPHYR CLASSIC VS XSTREAM COMPARISON</p> <p>The Zephyr Xstream's Dial Setups offer some important differences from the Zephyr's Auto Dial Setups:</p> <ol style="list-style-type: none"> 4. Inclusion of codec information is optional with the Xstream, whereas it is mandatory with the Zephyr. Inclusion of codec information is the default. 5. Xstream allows independent setups for Line 1 and Line 2 to be used. Zephyr does not allow access to Auto Dials if any line is in use. 6. Zephyr only allows Auto Dial Setups to place data (i.e. Zephyr) calls while Zephyr Xstream's Mode settings allow Dial Setups to place calls to an Xport using "Xport" Mode and a regular telephone using the "Phone" Mode.
----------	--

	<p>HOT TIP!</p> <p>You can use dial setups as a way to conveniently change your codec settings. Possibly to accommodate incoming calls from differing locations.</p> <p>Simple leave the Number 1 & Number 2 field blank, and set Include to Codec. As always, be sure to set the CODEC menu items to the proper settings before creating your setup.</p>
---	---

Location Setups

Location setups are a useful feature that allows you to pre-configure information about the ISDN line (**TEL** menu information) and the mixer setup/assignment information (**AUDIO** menu and **MX/MXP** front panel information) for frequently visited locations. Each dial setup consists of several pieces of information:

- A Setup number – this three-digit number can be used to instantly access a given *location setup*.
- An alphanumeric *Name*
- **TEL** menu settings – This is a snapshot of all settings of the **TEL** menu.
- **AUDIO** settings (optional) – This is a snapshot of all settings of the **AUDIO** menu. Note, the front panel Left/Right and Snd/Rcv mixer assignments on the Zephyr Xstream MX/MXP model's front panel are included along with the settings in the **AUDIO** menu.

Dial Setups when using V.35/X.21

Dial setups are sometimes used as a "short-cut" method of changing codec parameters when using the V.35 option. If you are using one of the Xstream's V.35 interface modes (see Section 9 - V.35/X.21 Interface) you can use *Dial Setups* without phone numbers to conveniently changes modes.

When a setup containing an entry for *Number 1* or *Number 2* (i.e. a phone number) is activated and the *Interface* (in the third TEL menu) is set to *V.35 Split* or *V.35 single* the system will change the interface to *ISDN* so that the number(s) may be dialed.

This arrangement allows for externally triggered ISDN backup in case of a failure of to a dedicated data facility. The Panic Dial feature could be used to activate this setup by an external device.

**HOT TIP!**

You are combining two features in this case, so be sure to understand the following:

- There is no method to use a setup to change from ISDN to V.35.*
- Therefore, your external panic dial trigger source should remain asserted.*
- You can manually switch back to V.35 and then drop the ISDN call to restore the V.35 connection.*
- Telnet or RS-232 commands allow for more sophisticated control options.*

Dial Setups using Panic Dial Closures

Configuring an input to use panic dial is covered in Section 11.6. The hardware specifications for the Parallel Control port are shown in Sections 3.2 & 3.4 (Guided Tour of the Hardware)

When a panic dial is triggered by asserting one of the inputs, the system takes the following actions:

1. Any ISDN call(s) present will be dropped
2. The *Dial Setup* indicated for the input asserted will be triggered
 - If one or more telephone numbers are present, the *Interface* setting (in the third TEL menu) will be set to *ISDN*.
 - If the setup "includes" CODEC settings, the codec will be configured to the settings stored when this *Dial Setup* was created.
 - The number entered as "number 1", if present, will be dialed.
 - If the first call completes the second call will be attempted (if two numbers are present)
3. The connection will be maintained until the input is no longer asserted.

**HOT TIPS!**

Users have found the following "Panic Dial Tricks" handy:

1. Mode reset. Create the **Dial Setup(s)** to be used without any phone numbers and to "include" codec information. Name them after the associated modes stored with the setup(s). You can now use push a momentary switch connected to the panic dial input(s) and Xstream will switch to a designated mode ready for an incoming call.

2. Drop and reset. Same as above. Since **Panic Dial** takes precedence over standard calls, you can push this momentary switch and drop a call and return to a default configuration (as programmed into the associated setup) ready for an incoming call.

Some users have done this with an external timer that automatically closes the contacts a few times a day. While the potential drawbacks are obvious, this can prevent 48 hour phone calls over the weekend!

3. Quick dialer. Connect a push button interlocking switch assembly (9 by 1 pole, single throw, interlocked such that only one can be pressed at a time). Leave one unconnected and connect the other 8 to the 8 logic inputs. Configure the inputs for Panic Dial. You can now call any of the first eight **Dial Setups** by pressing the appropriate button. Pushing the unconnected button would drop the call. When used in conjunction with an LED connected to an output, makes this a slick (but limited) remote control interface.

Alternatively, you can use a 8 pole rotary switch to select a line, and a simple toggle switch to connect or disconnect the call.

12 System Functions and Remote Control

12.1 Ancillary Data

Serial Data Transmission

The serial interface can be used to control the Zephyr Xstream, i.e. to change transmission modes or request status information. A Telnet session can also be used to perform this function.

The serial interface can be switched to transparent or ancillary data mode using the **atdt** command.

While the transparent mode is active, all data sent to the Zephyr Xstream's serial input is inserted into the coded audio signal and – provided there is an valid ISDN, V.35, or IP connection – transmitted to the receiving Zephyr. The latter will extract ancillary data information from the coded audio signal and output it on its own serial interface if it is in transparent mode.

- The ancillary data transmission is fully bi-directional and does not affect any ongoing audio transmission. The necessary bitrate to transmit ancillary data, however, is taken from the overall available line bitrate.
- Ancillary data that is fed into the Zephyr Xstream without having a connection will be lost.
- In Dual/Mono transmit mode ancillary data is transmitted to both sites. In Dual/Mono receive mode ancillary data line 2 is ignored.
- The ancillary data channel is an on-demand service, which means that the audio bitrate is only reduced if necessary. However, data can be transmitted continuously at up to 9600 kbps (Stereo and Mono-128) or 2400 kbps (Mono-64 and stereo-64). See below.
- Ancillary data is only available in certain modes, as outlined below:

TRANSMIT MODE	RATE (bps)
L3 Dual/Mono	2400
L3 Stereo/Jstereo	9600
L3 Mono 128	9600
AAC Mono 64 AAC-LD Mono 64	2400
AAC Stereo/Jstereo AAC-LD Stereo/Jstereo	9600
AAC Mono 128 AAC-LD Mono 128	9600
L2 Mono 64	2400
L2 Half 64	2400

Ancillary data is supported in these modes when the **Interface** option in the third **TEL** menu is set to **ISDN**, **Ethernet**, or **V.35 split**.

When set to **V.35 Single**, **Ancillary data operates at 9600bps**.



IMPORTANT!

*When the **Interface** option in the third **TEL** menu is set to **V.35 Single** ancillary data is possible in all permissible transmit modes at 9600 bps.*

How to Control Ancillary Data Transmission

Ancillary Data Commands

- **atdt** Immediately switches to transparent mode and disconnects any Telnet clients.
 - To switch off transparent mode and to gain access to control commands again, enter **+++**. (Do not transmit any data within a guard time of 1 second before giving this command.)
 - **+++** Switches off transparent mode and automatic transparent mode activation and return to Zephyr command interpreter.
- **atdt nobreak** Immediately switches to transparent mode and disconnects any Telnet clients. Unit will remain in transparent mode until a restore factory defaults is performed.

Contact Closures

For additional information on connecting to the parallel GPIO port see manual Sections 3.2 (Guided Tour of the Hardware - non mixer) and Section 3.4 Guided Tour of the Hardware MX/P and Section 11.6 - 11.7 (Detailed Menu Reference).

Parallel outputs may be affected either by the corresponding input at the remote Zephyr or Xstream (end-to-end operation), or can be used to monitor functions of the Xstream. See Section 11.6 for details on the menu selections affecting the contact closures functionality.

Normally, the closures are simply passed-through from one end to the other. The function of each input or output can be set using the front panel:

12.2 Remote Control

The Command Line Interface

The command line interface can be accessed in two ways: Via the RS-232 serial port or by using Telnet to access the unit over IP through the serial port.

RS-232 Port

The RS-232 serial port can be used for computer control of the system. Full status and control are available via this port, including ISDN dialing, storage of set-ups, etc.

The communication protocol is simple ASCII text, so it may be used easily with any computer and terminal emulation software. Some are using a palm top computer with macros to control their Xstreams in the field

Some "terminal emulation" software possibilities are:

- For the PC: Crosstalk, Procomm, MS Windows built-in HyperTerminal, etc.
- For the Macintosh: Z-Term, White Knight, etc.

The Zephyr Xstream may be connected locally to a personal computer, or to a modem for control from a remote site. There will be differences in the required cabling, as described in the Section 3. The Zephyr Xstream serial port is configured as DCE (Data Terminal Equipment), which means it looks like the connection on a modem, rather than on a computer.

- With local computer operation, a standard (non-null) cable is used.
- With a modem connection, a special "null modem" cable is required. For more information on the correct cable see Section 4.

Accessing the command line using the serial port

Note, this same command language is available using Telnet to access the Zephyr Xstream.

First connect the Xstream to a computer's serial port. Since the Xstream has a DCE interface you will need to use a straight through cable.

You will be using a computer "Terminal Emulation" program such as Windows HyperTerminal or ProComm for IBM compatibles or White Night or Z-term for the Mac. Configure this software to 8 bits, no parity, and 1 stop bit. Set the bit rate (may be called baud rate) to match the *rs232* selection in Xstream's *System* menu (usually 19200 bps).

Since HyperTerminal comes with Windows, we will give you some tips on using this particular software:

Start up HyperTerminal.

Click on the "new" button on the tool bar. You may see a prompt asking if it is ok to continue, click "ok". You should now see a **Connection Description** dialog box requesting that you name the setup and select an icon. Enter the desired name such as "Xstream on com 2" and click on an icon (we like the electron symbol which is last). Now click on "ok".

You will now see a **Phone Number** Dialog box. Enter the following information:

- Country code – Setting does not matter
- Area Code – Setting does not matter
- Phone Number – setting does not matter
- Connect Using - select the com port connected to the Zephyr Xstream

Now click on "ok". Next you will see a **Com Properties** Dialog box. Enter the following information:

- Bits Per Second - set to match *rs232* setting in the Xstream's *System* menu selection.
- Data Bits – set to 8
- Parity – set to none
- Stop Bits – set to "1"
- Flow control – set to "none"

Now click on "ok".

Once you have made the physical connections and programmed your terminal emulation software, you should see a blank terminal window. If all is ok you should see your own characters echoed back when you type. If not, check the settings and make sure you are properly connected. You may need to contact your software vendor for advice.

To enter the system type:

Login Telos <Enter> (if this does not work use Login <Enter>)

You will see the following response:

Logged in with user rights...

>>



To get a list of all available commands type: "help * <enter>" as shown below.

```
>>Help *
Built-in commands:

Name.....: printsender
Parameter..: -
Group.....: Multicast
Description: Show all defined Stream Senders.

Name.....: startsender
Parameter..: [<Host name|IP address>] [<port>] Group.....: Multicast
Description: Start an stream sender host.

Name.....: addsender
Parameter..: [<Host name|IP address>] [<port>] [<ttl>] Group.....: Multicast
Description: Add an stream sender host.

Name.....: zaesin
Parameter..: <analog | conv | sync >
Group.....: Zephyr-style
Description: Select AES/EBU input mode

Name.....: zaesout
Parameter..: <normal|32|44|48|ext|aesin>
Group.....: Zephyr-style
Description: Select AES/EBU ouput mode.

Name.....: zanswer
Parameter..: <A+|A-
Group.....: Zephyr-style
Description: Switch ISDN and phone auto-answer on/off

Name.....: zatdt
Parameter..: [auto|no|E[c]]
Group.....: Zephyr-style
Description: Set RS232 to transport mode, (use '+++ ' or to quit') Default: off

Name.....: zbaud
Parameter..: [<300|600|1200|2400|4800|9600|19200> [1|2]]
Group.....: Zephyr-style
Description: Set RS232 baudrate. The additional number of stopbits is ignored.

Name.....: zbitrate
Parameter..: <56/32|64/32|56/48|64/48>
Group.....: Zephyr-style
Description: Select line Bitrate/Sample rate in kbps/kHz, default: 56kbps/32kHz

Name.....: zconn
Parameter..: <1|2> <number> or <1..50>
Group.....: Zephyr-style
Description: Establish Zephyr-type ISDN connection on line 1 or 2 or activate a set up.

Name.....: zdirec
Parameter..: <line0..7> <number|->
Group.....: Zephyr-style
Description: Set or delete MSN resp. DN number.

Name.....: zdisc
Parameter..: <1|2|B>
Group.....: Zephyr-style
Description: Disconnect ISDN on line 1 or 2, or both

Name.....: zlevel
Parameter..: <-15 .. +4>
Group.....: Zephyr-style
```



USER'S MANUAL

Description: Select analog/AESEBU input level in dB.

Name.....: zlog
Parameter..: [SYS|ISDN|IMON|SEXT|TIME|ITIM]
Group.....: Zephyr-style
Description: Switch on a combination of logging channels. No parameter will switch off logging.

Name.....: zloop
Parameter..: <off|far|near>
Group.....: Zephyr-style
Description: Loop mode far, near or off, Default off

Name.....: znetwork
Parameter..: <ISDN|V35|Ethernet>
Group.....: Zephyr-style
Description: Select network: ISDN, ethernet or V.35

Name.....: zreset
Parameter..: -
Group.....: Zephyr-style
Description: Reset Zephyr (warm boot).

Name.....: zrxmode
Parameter..: <L3MO|L3ST|G722|L2|L2HALF|L2MO>
Group.....: Zephyr-style
Description: Select receive mode L3-mono, L3-stereo, G.722, Layer2 stereo, Layer2 24kHz, Layer2 mono, default: L3ST)

Name.....: zsetup
Parameter..: [<1..50>[<-|name <num1|-><num2|-><XmtMode><RcvMode><Rate>[<Compat>]]]
Group.....: Zephyr-style
Description: Display or define setup.

Name.....: zspids
Parameter..: <line0..7> <number|->
Group.....: Zephyr-style
Description: Set or delete SPID number.

Name.....: zstat
Parameter..: -
Group.....: Zephyr-style
Description: Zephyr Remote Stat information ...

Name.....: ztelco
Parameter..: <NI1|PTP|ETS300>
Group.....: Zephyr-style
Description: Select ISDN switch type.

Name.....: ztxmode
Parameter..: <L3DU|L3ST|L3JO|G722|L2MO|L2M128|L2DU|L2JO|L2HALF>
Group.....: Zephyr-style
Description: Select transmit mode. Layer3: dual mono, stereo, joint stereo, G.722, Layer2: mono, mono 128/112kbps, dual stereo, joint stereo, mono 24kHz. Default: L3DU)

Name.....: zver
Parameter..: -
Group.....: Zephyr-style
Description: Display version information.

Name.....: ethermode
Parameter..: [<l3 or aac>]
Group.....: Stream Decoder Description: Set the l3/aac streaming

Name.....: dcclient
Parameter..: [<host name or IP>] Group.....: Stream Decoder Description: Set All Decoder Clients



USER'S MANUAL

Name.....: etherrate
Parameter..: <8|12|14|16|18|20|24|32|40|48|56|64|80|96|112|128> Group.....:
Stream Decoder
Description: Choose bitrate for Ethernet operation.

Name.....: ipdchost
Parameter..: [<host name or IP>]
Group.....: Stream Decoder
Description: Set Decoder Host

Name.....: ?
Parameter..: 1: <none> 2: <command> 3: <'*>
Group.....: Misc
Description: Display list of available command & general help (1) or help for a given
command (2) or a detailed list of all commands (3)

Name.....: aes
Parameter..: -
Group.....: Audio
Description: Select AES/EBU for audio input.

Name.....: aesi
Parameter..: [<compare-sf>]
Group.....: Status
Description: Display info about AES/EBU receiver and transmitter chips. If 'compare -sf'
is specified this number will be used as a reference when measuring the incoming sample
frequency.

Name.....: aessrc
Parameter..: <int|32|44|48|rcv|sync>
Group.....: Audio
Description: Select AES/EBU output sample rate: 'int' uses the system sample rate and no
sample rate conversion is applied, '48' converts to 48kHz, '44' to 44.1kHz, '32' to 32
kHz and 'rcv' to the sample rate of the AES/EBU receiver.

Name.....: ancill
Parameter..: <+|->
Group.....: Misc
Description: Switch on/off ancillary data transmission and reception.

Name.....: analog
Parameter..: -
Group.....: Audio
Description: Select A/D converter for audio input.

Name.....: atdt
Parameter..: -
Group.....: Misc
Description: Enter transparent RS232 ancillary data mode. To return to normal console mode
enter '+++' after a guard time of 1 second.

Name.....: atdt nobreak
Parameter..: -
Group.....: Misc
Description: Enter transparent RS232 ancillary data mode. Unit will persist in this mode..

Name.....: autodial
Parameter..: [<index0..99> [<name> <number1|-> <z|v> <number2|-> <z|v> [codec|custo m]]
or <index0..99> <erase!> or <index0..99> !
If [custom], supply <enco> <deco> <bitrate> <samplerate> as per other commands
Group.....: Setup
Description: Store autodial setup. The 'name' must not contain any spaces. Underscores
will
be converted to spaces. Enter a dash for the phone number if no call should be made. 'z'
specifies a Zephyr-type call, 'v' a voice call. 'codec' stores the codec settings along
with
the setup. If no parameter is specified all setups will be displayed. If 'erase!' is
specified



USER'S MANUAL

with a setup index it is erased. If the exclamation mark is specified the autodial is activated. If only 'index' is specified this setup will be displayed.

Name.....: backlight
Parameter..: <0..0x7F>
Group.....: Misc
Description: Select the frontpanel LCD screen backlight.

Name.....: bitrate
Parameter..: <56|64>
Group.....: Codec
Description: Choose bitrate per ISDN channel (in kbps).

Name.....: buttonlock
Parameter..: <+|->
Group.....: Audio
Description: Enables/disables frontpanel mixer button locking.

Name.....: contrast
Parameter..: <0..0x7F>
Group.....: Misc
Description: Select the frontpanel LCD screen contrast.

Name.....: dec
Parameter..: [ancr|init|r|rlc]
Group.....: Status
Description: Display decoder status info or read ancillary (ancr) data or re-initialize access pointers (init) or read config table (r) or reset lost lock counter (rl c).

Name.....: decomode
Parameter..: <Auto|G722|L2M64|L2|L3D/M|L3|AAC64|AAC|AACLDM64|AACLD>
Group.....: Codec
Description: Choose decoding algorithm.

Name.....: delay
Parameter..: <msec>
Group.....: Misc
Description: Delay for the given amount of milli-seconds. Useful for batch commands.

Name.....: dtmf
Parameter..: <numbers|+|->
Group.....: ISDN
Description: Send DTMF tones to far end of a POTS connection or enable/disable DTMF tone transmission.

Name.....: enocode
Parameter..: <L3dual|L3mono128|L3joint|L3stereo|L2half64|L2mono64|L2mono128|L2joint|L2stereo|G722|AACmono64|AACmono128|AACjoint|AACstereo|AACjoint64|AACLDmono64|AACLDmono128|AACLDjoint|AACLDstereo>
Group.....: Codec
Description: Choose encoding algorithm.

Name.....: etherrate
Parameter..: <8|12|14|16|18|20|24|32|40|48|56|64|80|96|112|128>
Group.....: Codec
Description: Choose bitrate for Ethernet operation.

Name.....: eval
Parameter..: <expression>...
Group.....: Misc
Description: Evaluate a numerical expression.

Name.....: vars



Parameter..: -
Group.....: Status
Description: Display contents of available variables.

Name.....: fpdump
Parameter..: [<FTP server>
Group.....: Misc
Description: Dump out the contents of the currently visible frontpanel screen. This is the UU encoded version of the file TELOS.BMP. When a FTP server host name or IP is specified the data will be uploaded to this server under the name \pub\Screen.uue.

Name.....: help
Parameter..: 1: <none> 2: <command> 3: <'*'>
Group.....: Misc
Description: Display list of available command & general help (1) or help for a given command (2) or a detailed list of all commands (3)

Name.....: ingain
Parameter..: [<-15...+4>
Group.....: Audio
Description: Set input gain (in dB) for the stereo audio board.

Name.....: info
Parameter..: -
Group.....: Status
Description: Display various information on the hardware settings.

Name.....: ipmask
Parameter..: [<IP-mask>
Group.....: FTP/Telnet
Description: Enter IP mask or display current addresses. Decimal format is tried first.

Name.....: ipgate
Parameter..: [<gateway-IP>
Group.....: FTP/Telnet
Description: Enter gateway IP address or display current addresses. Decimal format is tried first.

Name.....: ipdns
Parameter..: [<dns-server-IP>
Group.....: FTP/Telnet
Description: Enter DNS server IP address or display current addresses. Decimal form at is tried first.

Name.....: ipaddr
Parameter..: [<IP-address>
Group.....: FTP/Telnet
Description: Enter IP address or display current addresses. Decimal format is tried first.

Name.....: ipping
Parameter..: <IP address|Host name> [packet-size]
Group.....: FTP/Telnet
Description: Ping remote host.

NOTE: "Result = -1" indicates the Ping has failed.

Name.....: ipftpreadsetup
Parameter..: <path+filename>
Group.....: Setup
Description: Read setups from the FTP server under the given path.

Name.....: ipftpsavesetup
Parameter..: <path+filename>
Group.....: Setup
Description: Store current setups on the FTP server under the given path.



USER'S MANUAL

Name.....: ipftphost
Parameter..: [<host name or IP>]
Group.....: FTP/Telnet
Description: Set or display the server that is used to download system and loadset software updates. Default is ftp.zephyr.com.

Name.....: ipupdate
Parameter..: [<file-name>]
Group.....: FTP/Telnet
Description: Connect to FTP server name or IP address and download the specified system code file into the SIMM. DO NOT SWITCH OFF UNIT DURING UPDATE!!

Name.....: iptelnet
Parameter..: [<kill <#|all>>|<msg <#|all|rs232> text>]
Group.....: FTP/Telnet
Description: Dump statistics on current telnet sessions or shutdown the telnet session with given number or shutdown all sessions or send a message to a given session or all sessions. Telnet session numbers start with 1.

Name.....: iptrusted
Parameter..: [<Host name|IP address>]
Group.....: FTP/Telnet
Description: Specify a host name or IP address (base 10) which is allowed to login thru Telnet and has the same rights as a RS232 session.

Name.....: isdnautoans
Parameter..: <off|phone|ISDN|all>
Group.....: ISDN
Description: Select ISDN autoanswer mode.

Name.....: isdni
Parameter..: [N|T]
Group.....: ISDN
Description: Display status information of all lines. If option N is specified this will print all SPID and DN/MSN numbers. Option T displays call times.

Name.....: isdnspid
Parameter..: <line0/1> <number|->
Group.....: ISDN
Description: Set or delete SPID number.

Name.....: isdndn
Parameter..: <line0/1> <number|->
Group.....: ISDN
Description: Set or delete MSN resp. DN number.

Name.....: isdnmsn
Parameter..: <line0/1> <number|->
Group.....: ISDN
Description: Set or delete MSN resp. DN number.

Name.....: isdndisc
Parameter..: [<line0/1>]
Group.....: ISDN
Description: Disconnect call on given line. If no line is specified all calls will be disconnected.

Name.....: isdnaccept
Parameter..: <line0/1>
Group.....: ISDN
Description: Accept incoming call on given line.

Name.....: isdncll
Parameter..: <line0/1> <number> <voice|data>
Group.....: ISDN
Description: Make outgoing call on given line.

Name.....: isdntelco
Parameter..: <5ESS|DMS100|NI1|Net3|Ins64>
Group.....: ISDN

Description: Select ISDN telco type. Unit must be reset in order for the change to take effect.

Name.....: levelin
 Parameter..: <cons|prof>
 Group.....: Audio
 Description: Select consumer or professional level for analog inputs.

Name.....: levelout
 Parameter..: <cons|prof>
 Group.....: Audio
 Description: Select consumer or professional level for analog outputs.

Name.....: location
 Parameter..: [<number0..29> [<name> [audio]]] or <number0..29> !
 Group.....: Misc
 Description: Store the current configuration as a location setup. If 'audio' is specified the current audio settings will be stored along with the setup. If no parameter is specified all location setups will be listed. If the exclamation mark is specified the location setup is activated.

Name.....: log
 Parameter..: [<dbg|ext|tcp|isdn|il2|il3|ie|istk>]
 Group.....: Misc
 Description: Switch on a combination of logging channels. No parameter will switch off logging.

	<p>IMPORTANT TIP!</p> <p><i>The most useful logs for troubleshooting ISDN problems are log isdn, il2, il3, and ie.</i></p> <p><i>We recommend turning off all logging modes by entering "Log <enter>" when you have completed your troubleshooting.</i></p>
---	--

Name.....: login
 Parameter..: <password> [<new password>]
 Group.....: Misc
 Description: Log into the command interpreter or change password. Use '-' to substitute for an empty password when changing.

Name.....: logoff
 Parameter..: -
 Group.....: Misc
 Description: Log off from the command interpreter.

Name.....: loop
 Parameter..: [<isdn|v35|mpeg|another|astereo|amicshort|amiclong>]
 Group.....: Test
 Description: Toggle various loop modes. If no parameter is specified switch off all loop modes.

Name.....: miclowcut
 Parameter..: [<mic1..4> <+|->]
 Group.....: Audio
 Description: Switch on/off the lowcut filter for the specified microphone input channel.

Name.....: micphant
 Parameter..: [<+/->]
 Group.....: Audio
 Description: Switch phantom power on (+) or off (-).



Name.....: micprocess
Parameter..: [<mic1..4> <VoiceL|VoiceM|VoiceH|Music|Off>]
Group.....: Audio
Description: Select the processing type for the specified microphone input.

Name.....: micpan
Parameter..: [<mic1..4> <-10...+10>]
Group.....: Audio
Description: Set the panning for the specified microphone input in case it is assigned to both input channels. -10 pans to the left, 10 pans to the right, 0 pans to the center.

Name.....: micassign
Parameter..: [<mic1..4> <L|R|B|->]
Group.....: Audio
Description: Assign the specified microphone input to the left, right, to both or no input channel.

Name.....: micgain
Parameter..: [<<mic1..4>|A> <linepro|linecons|mic+30|mic+44>]
Group.....: Audio
Description: Set mic board input sensitivity. If the microphone index is 'A' all inputs will be set to the given gain.

Name.....: monimix
Parameter..: [<monitor1/2> <snd|rcv> <L|R|M|S>]
Group.....: Audio
Description: Select source channel for either send or receive audio. L=left, R=right, M=mono left+right, S=stereo.

Name.....: monipan
Parameter..: [<monitor1/2> <snd|rcv> <-10...10>]
Group.....: Audio
Description: Select L/R balance for either send or receive audio.

Name.....: monibalance
Parameter..: [<monitor1/2> <-10...10>]
Group.....: Audio
Description: Select balance between send and receive audio. -10 enables send audio only, 10 enables receive audio only. Applies only if both send and receive are enabled for this monitor.

Name.....: moniassign
Parameter..: [<monitor1/2> <S|R|B|->]
Group.....: Audio
Description: Switch selected monitor to send audio, receive audio or both send and receive or off.

Name.....: monoin
Parameter..: <+|->
Group.....: Audio
Description: Switch audio going to the encoder to mono or stereo.

Name.....: network
Parameter..: <isdn|v35|v35hi|ethernet>
Group.....: Codec
Description: Select the network type for bitstream I/O.

Name.....: numbase
Parameter..: <bin|dec|hex|<2...16>> [def]
Group.....: Misc
Description: Set default number base for number input. This affects only the current session. If 'def' is specified then this will be the default number base for all future sessions.

Name.....: perfo
Parameter..: [r]
Group.....: Status
Description: TTYprint realtime kernel performance info and reset statistics. Optionally



reset statistics.

Name.....: pp
Parameter..: ['in' [val]|'out' [val]]
Group.....: Misc
Description: Override incoming or outgoing parallel port values. Return to normal operation if 'val' is not specified. Read current input & output value if no parameter is given.

Name.....: ppin
Parameter..: [<bit1..8> <endend|auto0|auto1|auto2|auto3|auto4|auto5|auto6|auto7>] or [<endend>]
Group.....: Misc
Description: Select operation mode for selected parallel port input bit or switch all bits to 'end-to-end' mode.

Name.....: ppout
Parameter..: [<bit1..8> <off|on|endend|lock1|lock2|lock1o2|lock1&2|conn1|conn2|conn1o2|conn1&2>] or [<off|on>]
Group.....: Misc
Description: Select operation mode for selected parallel port output bits or switch all outputs to 'off' or 'on' mode.

Name.....: reset
Parameter..: ['cold'|'pm'|'assert'|'fatal'|'loop']
Group.....: Misc
Description: Restart software by letting the watchdog bite. Option 'cold' forces a reset with global parameter reset. 'pm' trigger a pmdump due to access error. 'assert' calls TDEASSERTU, 'fatal' issues a reset by writing to fatal, 'loop' enters an endless loop and lets the watchdog bite.

Name.....: rs232baud
Parameter..: [<baudrate 300...57600>]
Group.....: Misc
Description: Select RS232 baud rate.

Name.....: sfq
Parameter..: <48|44|32>
Group.....: Codec
Description: Choose system sampling frequency.

Name.....: store
Parameter..: 1:<cmd parameter <: parameter...> 2:<clear> 3: <clear> <cmd> Group.....: Misc
Description: Store a command sequence in the batch memory (1) or delete all command sequences from batch memory (2) or delete a specified command (3).

Name.....: ti
Parameter..: [<taskname>]
Group.....: Status
Description: TTYprint information about specific or all existing tasks. Optionally reset task statistics after printout.

Name.....: time
Parameter..: [current time]
Group.....: Misc
Description: Display current system time and time difference to previous time command. If 'current time' is specified then it will be used to print out absolute time values in the ISDN log and in various other places.

Name.....: unitid
Parameter..: [ID string]
Group.....: Misc
Description: Enter or display the unit's ID string. This string can arbitrarily be chosen by the user.

Name.....: v35rate
Parameter..: [112|128|256|384]



Group.....: Codec
Description: Enter or display the V.35 highspeed encoder bitrate.

Name.....: v35deco
Parameter..: [l2|l3|aac|aacld]
Group.....: Codec
Description: Enter or display the V.35 highspeed decoder algorithm.

Name.....: v35enco
Parameter..: [l2mono|l2stereo|l2joint|l3mono|l3stereo|l3joint|aacmono|aacstereo|aac
joint|aacldmono|aacldstereo|aacldjoint]
Group.....: Codec
Description: Enter or display the V.35 highspeed encoder algorithm.

Name.....: version
Parameter..: 1: <none> 2: <'e'>
Group.....: Status
Description: TTYprint normal (1) or extended (2) version information.

Name.....: dcstop
Parameter..: [IP]
Group.....: Stream Decoder
Description: Stop Listen to far-end encoded stream.

Name.....: dcstart
Parameter..: [IP]
Group.....: Stream Decoder
Description: Listen to far-end encoded stream.

Name.....: loadweb
Parameter..: [<host> <all!|<name>>]
Group.....: Http
Description: Erase loadweb and download all files via FTP (all!) or download loadweb
names 'name' or display existing loadweb w/o argument.

Name.....: stophttp
Parameter..: -
Group.....: Http
Description: Stop the Http sub system ...

Name.....: starthttp
Parameter..: -
Group.....: Http
Description: Start the Http sub system ...

Name.....: ncstat
Parameter..: -
Group.....: Netcoder
Description: Netcoder: Query Netcoder Status and show how many clients are streamin g.

Name.....: ncdefault
Parameter..: -
Group.....: Netcoder
Description: Set The netcoder parameters to their default values.

Name.....: nclimit
Parameter..: -
Group.....: Netcoder
Description: Table of # of server connections supported at given bitrates.

Name.....: setHttpPort
Parameter..: [<Port>]
Group.....: Http
Description: Set Http port. default: 80

Name.....: settcpport
Parameter..: [<Port>]



Group.....: Http
Description: Set TCP port, default 1024

Name.....: setMp3port
Parameter..: [<Port>]
Group.....: Http
Description: Set Mp3 port default 8000

Batch commands:
<none>

Control via Ethernet using Telnet

You can connect to the same command line described above by using Telnet. To do this on a Windows machine, simply run Telnet. Then type :

Open 123.345.678.901 <enter>

(or select open from the file menu, depending on the Telnet client you are using).

Substitute the IP address of your Xstream for the IP address shown. You can now login to the Xstream and use the command language as described above.

Telnet is port 23. If you have difficulties with access through a firewall give this information to your network administrator.

Some versions of Hyper Terminal support Telnet sessions as well. Or, you may be able to enter the following in your browser: Telenet:123.345.678.901 <enter>

You will need to login in as described previously. Type: Login Telos <Enter> (if this does not work use Login <Enter>).

NOTE: The Password can only be changed using the RS-232 or Telnet command line. See section 12.2 for details.

Control via Ethernet with Web Browser

The Xstream can be controlled via a web browser. Of course the computer with the browser and the Xstream must be both connected to a TCP/IP network. Simply enter:
http://109.876.543.210/ (substitute the IP address of your Xstream) on your browser.

NOTE: The login procedure and web pages are different depending on whether you have the 10 Base-T or 100 Base-T (Livewire capable) hardware. Follow the corresponding instructions, below:

10 Base-T units (original hardware)

A login page will be displayed. For "password" type: "Telos <Enter>" (if this does not work use "<Enter>").

100 Base-T units (later, Livewire capable units)

You will need to login in. If requested for a user name, enter "user". By default, there is no password.



The Xstream's HTML browser interface has been tested with the following browsers (others will probably work as well).

- Firefox (Windows) 1.01
- Internet Explorer (Windows) versions: 5.00, 5.5, and 6.0

Zephyr Remote

Large facilities where it is desirable to centrally locate equipment, may wish to explore the Zephyr Remote Software package from Software Authority. Using it you can control an Xstream via Ethernet or may control multiple Zephyrs and/or Xstreams via serial port. See www.softwareauthority.com to download the program for free. If you like it, you can purchase a key that allows unrestricted operation by contacting Software Authority.



Panic Dial

Panic Dial also allows simple dialing control of the Xstream via the parallel control port. See Section 11.7 (Detailed Menu Reference) for more information.



13 DEEP TECH INFORMATION & TROUBLESHOOTING

	<p>IMPORTANT!</p> <p><i>As with any piece of modern electronic gear, it is advisable that precautions be taken to prevent damage caused by power surges. Standard line surge protectors can be used to offer some degree of protection. It is the user's responsibility to ensure protection adequate for their conditions is provided.</i></p> <p><i>Section 4 has specific recommendations.</i></p>
---	--

	<p>WARNING!</p> <p><i>This equipment is designed to be operated from a power source that includes a third "grounding" connection in addition to the power leads.</i></p> <p><i>Do not defeat this safety feature. In addition to creating a potentially hazardous situation, defeating this safety ground will prevent the internal line noise filter from functioning.</i></p>
---	--

	<p>IMPORTANT SAFETY INFORMATION!</p> <p><i>If fuse replacement is required, please note: For continued protection against fire, replace fuse only with same type and value.</i></p>	
---	---	---

13.1 Accessing the Hardware

	<p>IMPORTANT!</p> <p>Always disconnect AC (mains) power and Telephone Circuit Before removing the Zephyr Xstream's cover.</p> <p>Potentially lethal voltages are inside! Failure to observe the above warning may result in electric shock, injury or even death!</p> <p>Refer all servicing to qualified personnel.</p>	
---	---	---



CAUTION

The installation and servicing instructions in this manual are for use by qualified personnel only. To avoid electric shock do not perform any servicing other than that contained in the Operating Instructions unless you are qualified to do so. Refer all servicing to qualified service personnel.

To remove the top cover:

1. Remove power from unit
2. Remove top lid screws (14 or 18 screws) using a Phillips screwdriver. 6 screws top (these will be 1/16th inch Allen screws on model MXP), 4 or 6 screws on each side. Lift cover straight off the unit.

NOTE: On the Zephyr Xstream MXP the 6 screws on the top also hold the protective rubber bumpers. These require a 1/16 inch Allen driver to remove.

To replace the top cover:

1. Replace the lid. If you have a Zephyr Xstream MXP align the blue bumpers with their corresponding holes. Use the 6 Allen screws in those positions.
2. Fasten the lid using the 14 or 18 Phillips head screws removed in step 1.

Setting the nominal input level range (non-mixer version only)

The Xstream can support +4 dBu (Professional) / -11dBu (consumer) levels depending on the *Level In* Setting in the *Audio* menu. This is how the Xstream is shipped from the factory.

It is possible to shift the nominal inputs levels 4 dB lower (i.e. 4 dB more sensitive) therefore resulting in 0dBu(Professional)/-15dBu(Consumer) levels. This is done by changing JP5 & JP6 on the audio board. See below for the possible settings.

Early production units:

<i>JUMPER SETTING (JP5&6)</i>	<i>Menu Setting: Professional</i>	<i>Menu Setting: Consumer</i>
Right Pins	+4 dBu nom. (+22 clip)	-11 dBu nom. (+7 clip)
Left Pins	0 dBu nom. (+18 clip)	-15 dBu nom. (+3 clip)

Most units have the following jumpers:

<i>JUMPER SETTING (JP10 & 11)</i>	<i>Menu Setting: Professional</i>	<i>Menu Setting: Consumer</i>
Pins 1&2 and 5&6	+4 dBu nom. (+22 clip)	-11 dBu nom. (+7 clip)
Pins 2&3 and 4&5	0 dBu nom. (+18 clip)	-15 dBu nom. (+3 clip)

To change the input level operating range:

1. Remove the top cover as described above.
2. With the front of the Xstream facing you, look for the AES/EBU socket PC board protruding towards you from the rear panel. Below this board, at the bottom of the chassis, you will find jumper blocks JP5 & JP6 (early hardware revs) or JP10 & 11 (most units). Set the jumpers as desired (see tables above).
3. Replace the top cover as described above.
4. Set the *Input Level* Option in the *AUDIO* menu to “Consumer” or “Professional” as desired (see table, above).

Assigning the XLR outputs to monitor mix 1 (MX and MXP version only)

Newer model MX/P units allow the XLR outputs to be assigned to Local Mix 1 instead of Local Mix 2. To change this setting:

1. Remove the top cover as described above.
2. Note that there are two boards in the unit. The board to the left (when viewed from the front of the unit) is the MIC Audio Board.

3. Verify that the version number of this board is 1401-00008-006 (Rev F) or later.
4. Locate jumpers JP7 and JP8 on the MIC Audio Board. These are located near the left edge, about halfway back.
5. Move the jumper blocks from the *Normal* position (towards the back of the unit) to the *Monitor 1* position (towards the front of the unit).

Enabling PS2 power on the ISDN S interface

Early rev Xstreams have the ability to provide power on the ISDN S interface (to power a telephone for example).

Pins 7 & 8 of the ISDN S interface on these units can supply -48 VDC to an external device such as a telephone. This can be disabled, which is the default setting.

	<p>IMPORTANT TIP!</p> <p><i>Leave this power source disabled unless you know how you will be using it.</i></p> <p><i>Under no circumstances should this power be enabled if the "S" interface will be shared with a Zephyr Classic or ZephyrExpress.</i></p>
--	---

To enable PS2 power (if present):

1. Remove the top cover as described above.
2. If option cards are present in Interface slots B and C remove the ISDN card (if no other cards are installed you can change the jumper settings without removing the ISDN card).
3. Locate jumpers JP1 & JP3. These are located above the center of the connector that plugs into the motherboard.
4. Remove the jumper blocks from the top two pins of these headers and relocate connecting the lower 2 pins of those headers. (NOTE: JP2 should always be in the down position).
5. Replace the top cover as described above.

User installable sub-assemblies

The advent of surface mount technology has helped to lower the cost of electronics and improve their reliability. Unfortunately, this technology also requires specialized tools and knowledge for most repairs. High-speed DSP technology requires advanced training to

troubleshoot. Therefore, we expect that most repairs will need to be done by Telos or our authorized representatives. See page III for details on obtaining service or support.

However, there are a few sub-assemblies, which are field replaceable. You can purchase the following spare parts, if desired.

ISDN S + U Interface Telos Part # 1701-00023 (old # 9456-0000) for 10 Base-T hardware only

ISDN S + U Interface Telos Part # 1701-00153 (for 100 Base-T and 10 Base-T hardware. Requires software version 3.x or later)

V.35/X.21 Interface Option Card Telos Part # 1701-00006 (old # 9454-0000)

Zephyr Xstream Power Supply Telos Part # 1281-0006

Zephyr Xstream SIMM memory module (10 Base-T hardware version only) Telos Part # 1166-0005-XS-version (specify "Zephyr Xstream" and the desired version on your order)

NOTE: When installing the 1701-00023 ISDN S + U Interface be sure the following jumpers are correctly set:

JP2 must short pins 1 and 2 (down position)

JP1 and JP3 should be set as indicated above.

13.2 Updating Firmware

The procedure for updating units is one area where early units (with 10 Base-T Ethernet port) and newer Xstreams (with 100 Base-T Ethernet and Livewire) differ substantially. The early unit request updates from the FTP server specified in the System menu (this might be a local machine running a special updater/FTP server, or it might be a remote FTP server such as the one at Telos.

The newer units (with 100 Base-T) are updated via the web browser. In this case, the appropriate files are downloaded from Telos to the local machine. Then, from the web browser, the user specifies the path to the files when the update process is initiated.

Please consult the appropriate section for your unit.

NOTE: You can determine if your unit has the newer 100 Base-T hardware by checking your software version in the first *SYSTEM* screen. If your software version ends in "I" or "P" you have older 10 Base-T hardware. If your version ends in "B" or "R" you have the 100 Base-T hardware.

13.3 Updating Xstreams with the 100 Base-T hardware

The Xstream has two internal memory "banks". Each bank contains room for a complete version of operating software. This approach allows a software update download to be completed and checked without danger of making the unit inoperable if the download were to be incomplete or corrupted. It also provides an easy way to try a new software version and still return to the old version.

The software version in each bank is displayed on the *System Parameters* page as shown below. To change banks simply click in the "radio button" for the desired bank and then click on *Apply*.

IMPORTANT! The Xstream will reboot after you click *Apply* if you change the software version. This will disconnect any calls.

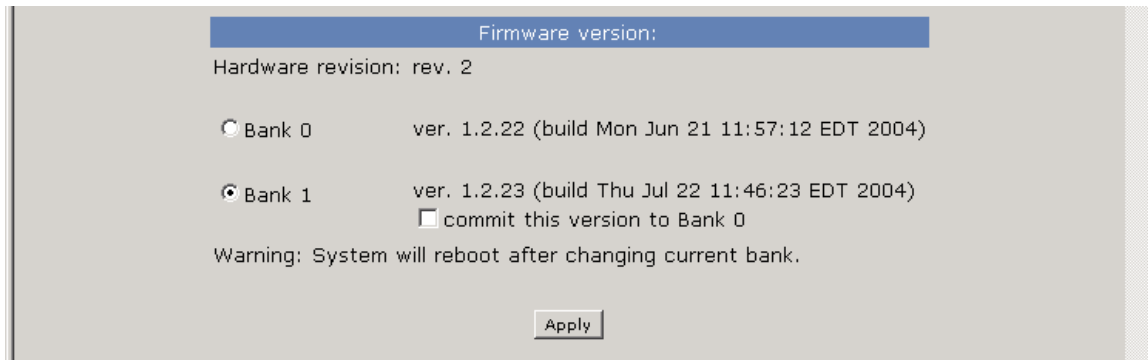

Saving Bank 1 Software

Software is always downloaded to bank 1 (the secondary bank). Downloading software (see below) will overwrite the software currently in this bank, if any. If you wish to save the software currently residing in bank 1 you can save it by moving it to bank 1 as follows:

1. Click on the *Commit this version to Bank 0* box (see below).
2. Click on *Apply*. The node will now reboot.

IMPORTANT! The node will reboot after you click *Apply* if you change the software version. This will result in loss of audio locally, and at any unit using the local sources. In addition you will reset your browser connection and will need to reconnect.

Downloading new software

A new software version can be downloaded into bank 1 as follows:

1. Go to the Telos web site: www.telos-systems.com and download the desired software update to your computer (this should be the computer that you will use to access the node's web page) by clicking on the link. Your local computer operating system should display a prompt to permit you to choose where you wish to locate the downloaded file. You can choose any convenient location, just be sure to note the drive and location where the file is to be saved.
2. Open a web browser and connect to the Xstream to be updated. Enter the complete path and file name for the software file (e.g. the file downloaded from the Telos site), or click on the *Browse* button to locate the file. Once the proper path and filename are displayed, click on *Apply* to download the file. The download process is lengthy. Consult the version notes for details.

3. A successful download will be indicated by the new version being displayed in the *Bank 1* field. If the download is unsuccessful the field for *Bank 1* would be blank.
4. Click on the *Bank 1* radio button and then *Apply* to reboot and run the new software version.

IMPORTANT! The node will reboot after you click *Apply* when changing between software versions. This will result in loss of audio locally, and at any unit using the local sources. In addition you will reset your browser connection and will need to reconnect.

13.4 Updating the original (10 Base-T) Xstream

Zephyr Xstream's software is stored on a re-programmable module. The Xstream can use FTP (File Transfer Protocol) over any IP network to download new firmware from an FTP server into the memory module. We advise you to contact Telos Customer Support (have your current software version and Serial number when you call) to discuss whether the latest version would better meet your needs. The Telos web site www.zephyr.com includes information on updating your Xstream. This information includes version notes describing the changes between the software version.

There are two basic scenario's. If your firewall allows FTP through, then the Xstream can download the new software directly from the Telos FTP site (ftp.telos-systems.com).

If your firewall does not allow direct FTP download, you will need to download our free tISFTP server software and the Xstream software files. This download can be initiated at the Telos web site. You will need to download this file archive to an IBM PC compatible machine on the local network. The readme file included in the archive has detailed instructions on setting up the Telos FTP server.

You will then use the IP address of your local FTP machine as the *FTP site* in the Zephyr Xstream's system menu and then initiate the update process. If you are unsure of the IP address for the computer you are using for the update, go to a DOS window and type "ipconfig <enter>".

To get to a DOS window go to the run window programs and type "command <enter>" (Win 3.1, 95, & 98) or "Cmd <enter>" (Win NT, 2000).

Detailed update procedures follow.

Updating 10 Base-T Xstreams from a local ftp updater.

First download the Telos ftp updater. This software will be run on a local Windows™ machine.

Software update step-by-step (Local Server)

1. You will need to know the IP address of the machine that will be running the ftp updater. You can find out your IP address by going to the MS-DOS window and typing: IPConfig <enter> . The information about this machine's network configuration will be displayed.

2. Start the Telos update server by double clicking.

It is important that the download process completed without interruption. If local power is not reliable, you might wish to place the Zephyr Xstream (and local FTP server, if used) on an un-interruptible power supply.

3. Connect the computer to be used for the update and the Zephyr Xstream to the same Ethernet network. The following diagram shows the usual connections. Note that a direct connection between the Xstream and the computer may be made, if the appropriate Ethernet "Crossover" cable is used. See Appendix 5 (Modular Cable Guide) for details on that cable, if needed.

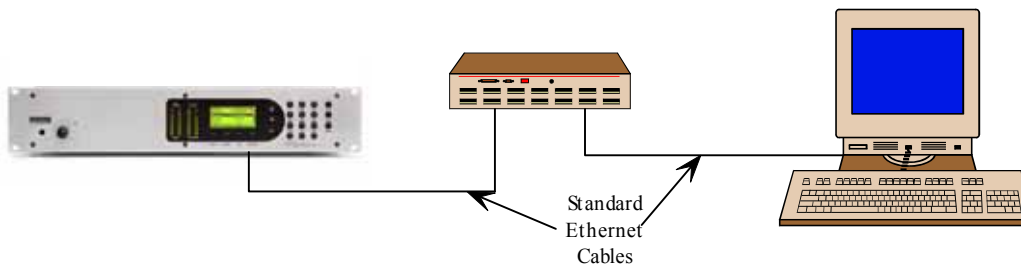

4. Program the following information into your Zephyr Xstream. Ask your network administrator if you need help.
5. Press the <SYSTEM> button three times
6. Enter the following information in this menu:

IP Address-

The IP address for this unit. As with any computer on an IP network, the Xstream must have an IP address before it can be used over the network.

SN Mask-

The subnet mask is to determine the size of your local network. All packets addressed to a destination outside this local area are sent to the gateway node entered in the next selection. Normally you should enter 255.255.255.0 here.

Press <SYSTEM> again and enter:

FTP site -

This is the IP address of the computer running the Telos Update FTP server.

7. Update the system

Select *FTP update...* and press <SEL>. Press <▲> or <▼> to choose *OK* . Press <SEL>.

The unit will reboot once the update is complete. It may also give a message about "invalid non volatile RAM values". This message is normal.

8. Press <SYSTEM> once and verify that the new software version is shown. If not, repeat the update. The update process is now complete.

NOTE: It is not abnormal for the system to display a message "Some corrupt non volatile values were detected". You can disregard this message.

Updating a 10 Base-T Xstream directly from the Telos ftp site

Note: This method is preferred if your firewall allows access to the Telos ftp site (<ftp.zephyr.com>). In this case, you need only a connection to the internet - a local computer is not needed.

If your firewall allows FTP (usually port 21) through, then the Xstream can download the new software directly from the Telos FTP site (<ftp.telos-systems.com>). If your firewall does not allow direct FTP download, see sections I and II, above.

Software update step-by-step (Telos Remote Server)

It is important that the download process completed without interruption. If local power is not reliable, you might wish to place the Zephyr Xstream on an uninterruptible power supply.

1. Connect the Zephyr Xstream to a network with internet access.
2. Program the following information into your Zephyr Xstream. Ask your network administrator if you need help.

Press the <SYSTEM> button three times and enter the following information in this menu:

IP Address –

(The IP address for this unit). As with any computer on an IP network, the Xstream must have an IP address before it can be used over the network.

SN Mask –

The subnet mask is to determine the size of your local network. All packets addressed to a destination outside this local area are sent to the gateway node entered in the next selection. Normally you should enter 255.255.255.0 here.

Gateway –

This is the IP address of a gateway router connecting you to the internet.

DNS –

This is the IP address of the DNS (Domain Name Server) you will be using.

Press <SYSTEM> and enter:

FTP site -

This would normally be ftp.zephyr.com if downloading from Telos FTP site.

3. Update the unit. Select FTP update... and press <SEL>. Press <▲> or <▼> to choose OK . Press <SEL>.

The unit will reboot once the update is complete. It may also give a message about "invalid non volatile RAM values". This message is normal.

4. Press <SYSTEM> once and verify that the new software version is shown. If not, repeat the update. The update process is complete.

NOTE: It is not abnormal for the system to display a message "Some corrupt non volatile values were detected". You can disregard this message.

HOT TIP!

If you need to "borrow" the IP address of a Windows computer to use when updating your Xstream, here are some tips:



1. Go to the MS-DOS command line of the Windows machine (Run " cmd <enter>" for Win XP, 2000 or Win NT; or Run "command <enter>" for Win 95 or 98.
2. From the command line type "ipconfig <enter>". The IP address, and default gateway for that machine will be displayed. Write down this information.
3. Power off the computer that you just obtained this information from (or disconnect it from your network)
4. Enter this IP address and gateway into the Xstream
5. Connect the Xstream to your network.
6. Be sure to delete these entries from the Xstream when you are finished. You can then power up the computer (or reconnect it to the network).

	<p>HOT TIP!</p> <p><i>If you don't know a valid DNS (domain name sever) IP address, you can still update your Xstream from the Telos ftp site by obtaining the current IP address of the Telos FTP server as follows:</i></p> <ol style="list-style-type: none">1. <i>Go to the MS-DOS command line of the Windows machine (Run " cmd <enter>" for Win 2000 or Win NT; or Run "command <enter>" for Win 95 or 98.</i>2. <i>From the command line type "ping ftp.zephyr.com <enter>"</i>3. <i>You should receive a reply. If you do not get a reply check with your IT manager for assistance. The reply will include the current IP address of the Telos FTP server.</i>4. <i>Enter this IP address as "FTP site" in the Xstream.</i>
---	---

Manual Replacement Method (10 Base-T hardware only)

The system's software is contained within a flash memory SIMM module, similar in size and form to those used for PC memory. *The following directions are for qualified service personnel only.* If you need to change this module, follow the procedure below:

	<p>HOT TIP!</p> <p><i>This method of updating your Xstream will result in losing your Location Setups and Dial Setups.</i></p>
---	--

1) Remove the top cover as described in Section 13.1.

2) Remove the old software SIMM

- Turn the right side of the unit towards you (the power supply will be away from you).
- Near the front of the main PC board (PWB) you will see a ribbon cable connector and a very small PC board (the SIMM module) directly to the right of it.
- Push gently outward on the two metal catches on either end of the SIMM module. It should pop toward you.
- Pivot the top of the SIMM module toward you and then lift it out. Note the grooved notch on the right end.

3) Install the new SIMM module.

- Locate the notch on the SIMM module to your right (towards the rear of the Xstream).
- At a 30 degree angle from vertical, insert the SIMM module into its socket. It should slide in with *no resistance*. The module will be angled towards you.
- Using your two thumbs push on the green area near either end of the SIMM module. The top of the SIMM module should pivot back and the catches on either side should click. If this does not happen remove the SIMM module (see step 3, above) and try again.

4) Reinstall top cover

5) You may need to reprogram some of your settings, check them after installing the new software.

Please return the old SIMM module to Telos, via regular US Mail. Your prompt return of this module will allow us to continue to offer you upgrades in the future, at the lowest possible cost.

13.5 Troubleshooting

The following sections discuss various areas where you may encounter challenges. We have categorized this section into logical problem areas to make it as painless as possible. Of course, you are always welcome to contact our support team if you get stuck!

13.6 General Troubleshooting Techniques

Thinking about Problem Solving

Despite best intentions, something could always go wrong. Sometimes troubleshooting a balky set-up can make even the toughest engineer a Maalox and Rogaine addict.

You can't fix any system without the right world view; a zeitgeist of suspicion tempered by trust in the laws of physics, curiosity dulled only by the determination to stay focused on a single problem, and a zealot's regard for the scientific method. Perhaps these are characteristics of all who successfully pursue the truth. In a world where we are surrounded by complexity, where we deal daily with equipment and systems only half-understood, it seems wise to follow understanding by an iterative loop of focus, hypothesis, and experiment.

The notions here apply whether you are solving problems at the system level or at the component level. At the system level, the actions you might take would be very different – checking cables, trying different menu settings – but the thinking is the same.

Too many times, we fall in love with our suppositions. We are quick to overtly or subconsciously assume the problem being chased is due to lousy design, the stupid phone company, or the manager's latest memo.

Armed with a healthy skeptical attitude, the basic philosophy of troubleshooting any system is to follow these steps:

- Observe the behavior to find the apparent problem;
- Observe collateral behavior to gain as much information as possible about the problem;
- Round up the usual suspects;
- Generate a hypothesis;
- Generate an experiment to test the hypothesis;
- Fix the problem;
- Then, repeat, if necessary, to attack additional problems.

Let us now cover each step of the troubleshooting sequence in detail.

Step 1. Observe the behavior to find the apparent bug. In other words, determine the bug's symptoms. Remember always that many problems are subtle and exhibit themselves via a confusing set of symptoms.

Step 2. Observe collateral behavior to gain as much information as possible about the problem. Does the LCD's problem correlate to an LED flashing? Try to avoid studying a problem in isolation, but at the same time be wary of trying to fix too many at the same time. No one is smart enough to deal with multiple problems all at once – unless they are all manifestations of something more fundamental.

Understand that if a problem relates to telephone network routing, that your results may vary call to call. If you suspect this may be the case, you should make repeated calls (as many as 15!) and note the success rate. You can then change something and retest to see if the success rate was affected by your experiment. Network related problems will frequently vary based on which party places the call, the long distance carrier, and the bit rate; you can try varying these.

Step 3. Round up the usual suspects. At the system level, always suspect the menu set-up, the cables, the Phone Company line setup, the punch-blocks, etc. At the component level, many computer problems stem from the same sources. Never, never, never forget to check Vcc!

Step 4. Generate a hypothesis. Before changing things, formulate a hypothesis about the cause of the problem. You probably don't have the information to do this without gathering more data.

Sometimes you will have no clue what the problem might be. Sometimes, when the pangs of desperation set in, it's worthwhile to try anything practically at random. You might find a bad plug, an unconnected line, or something unexpected. Look around, but be always on the prowl for a working hypothesis.

Step 5. Generate an experiment to test the hypothesis. Change the ISDN connection to a known good line; call known good phone or hybrid at the other end; if long-distance doesn't work, try a local call.

NOTE: You should plan your tests to eliminate 50% of the possible problems in one test, if possible. Just keep careful track so you know what you have eliminated.

Step 6. Fix the problem.

A Final Thought...

Constantly apply sanity checks. Many years ago the Firesign Theater put out an album called "Everything You Know is Wrong". Use that as your guiding philosophy in troubleshooting a Zephyr Xstream. For example, just because you checked the Telco line last night, and it was fine, does not mean that it's OK now.

At 3:00 AM when the problems seem intractable and you are ready to give up engineering, remember that the system has worked and will work. Never panic—you are smarter than it is.

13.6.1 Diagnostic Indicators

The Xstream has a number of diagnostic indicators to help in troubleshooting difficulties. They are:

SYNC status LED

When *ISDN* is selected for the *Interface* (in the 3rd *TEL* menu), the SYNC LED (above the *SEND* bargraph) should illuminate whenever power is applied. It also indicates that the Zephyr Xstream has basic functionality. If not, the Xstream has not completed its boot cycle, or major clock problems exist within the unit.

When *V.35* is selected for the *Interface* (in the 3rd *TEL* menu) the SYNC LED indicates that a clock is present at one of the V.35/X.21 digital ports, and it is at the correct frequency to match the *Bitrate* (as selected in the first *CODEC* menu). Since this clock is passed through from the CSU/DSU, it is the best indication that the CSU/DSU is connected and has at least basic functionality.

When in "Ethernet" mode for *Interface* in the *CODEC* menu the sync light will generally flash periodically for about 5 minutes after connection is established. This is due to the fact that with Ethernet there is no master clock source as there is in V.35 or ISDN mode, so one of the units must lock itself to the clock of the other unit. To do this without side effects the change is made very gradually and until the process is complete the SYNC LED may flash periodically.

RECEIVE Lock LEDs

The LOCK LED illuminates to indicate that the decoder is receiving valid data. When a *Receive* mode capable of independent operation using the two B channels (i.e. L3 Dual/Mono or G.722) is used, the *LOCK 1* LED indicates valid data for "Line 1" while the *LOCK 2* indicates this information for "Line 2". When a *Receive* mode is used that requires 112/128 kbps of data both LEDs illuminate once the correct pair of data-streams are detected. Both LEDs will also illuminate if a valid data stream is received in *V.35 Single* mode.

If this is flashing, or off, there is either an incorrect setting of the *Receive* mode, *Sample Rate*, or *Bit Rate* (these parameters are all set in the second *CODEC* menu). Or, there is corrupted data being received.

If incoming the data suffers from bit errors, the audio will be briefly muted and the appropriate *LOCK* LED will extinguish until valid data is received again.

When using Ethernet mode and receiving AAC, the lock light will flicker off when bad data is received, however error concealment may prevent the disruption from being audible in many cases. If this is occurring frequently you may wish to check your network and/or increase the buffering.

NT1 U sync LED

Zephyr Xstream's built-in NT1 has an LED on the ISDN interface card on the back of the unit. This LED is only applicable if you are using the Xstream's built in NT1; i.e. you are in the USA or Canada and connected directly to the 2-wire BRI "U" interface. Users outside the USA & Canada can disregard this LED.

Normal status is indicated by the LED being lit. Rapid flashing indicates loss of the ISDN line at the lowest (physical, OSI Layer 1) level, or use of the incorrect jack on the ISDN interface card (use the lower, RJ-11 style jack if you are using the built-in NT1; i.e. are connecting directly to the raw copper 2B1Q circuit). Slow flashing of this LED may indicate problems with the Zephyr Xstream.

ON

This means that the NT1 is fully operational, and OSI layer 1 is fully initialized with the BRI circuit and the rest of the Zephyr/Zephyr Xstream *

FLICKERING

A fast flash rate means the NT1 has not initialized to the U interface (i.e. the ISDN BRI circuit). It is normal for this to occur for about 30 seconds or less after the unit is rebooted, the ISDN circuit connected, or the ISDN reinitialized. If this state persists, the problem is most likely the ISDN circuit (about 80%) although it could be the Xstream's terminal adaptor card (about 20%).
 *

	<p>ISDN TIP!</p> <p><i>IF YOU ARE USING THE "RJ-45" ISDN "S INTERFACE" (4-wire) NOTE:</i></p> <p><i>The ISDN S interface is generally used outside of the USA & Canada. If you are not using the ISDN U (2-wire) interface you can disregard this LED. In that case, this LED will be flickering.</i></p>
---	--

FLASHING

A slow flash means the NT1 has completed initializing the U interface (the line side) and is initializing the S interface to the rest of the Zephyr Xstream. If this state persists for more than 40 seconds, it is most likely a hardware problem with the Zephyr Xstream. You should "reseat" the ISDN card. Check for foreign voltage on the ISDN (you should see about 48 volts DC [possibly pulsing] on the line) If the problem persists, contact Telos Customer Support.

OFF

This is an illegal state and should not occur. In rare cases this could be the ISDN circuit. If disconnecting the ISDN line causes the LED to begin flickering, suspect this. Otherwise, if the Zephyr Xstream seems to be booting up, it indicates a bad Terminal Adaptor Card (90%). You should "reseat" the ISDN card. If the problem persists, contact Telos Customer Support. **

ALTERNATING

If the state alternates between more than one state, and continues to cycle between those states, something is wrong. First, check to see if you have the ISDN plugged into the right jack. The ISDN (U interface) must be plugged into the "U" jack, which is the lower jack. This is an RJ11

style jack, just like on a standard telephone. If the problem continues, you should “reset” the ISDN card. This state could indicate a marginal ISDN line. If the problem persists, contact Telos Customer Support. *

NOTES:

** If you reboot the unit and the LED stays either off or on, even with no ISDN attached, there is a problem. If the Zephyr otherwise seems to be operational (i.e. the keyboard and LCD screen and meters are functioning) it indicates a bad Terminal Adaptor Card (95%). You should “reset” the ISDN card. If the problem persists, contact Telos Customer Support.

* If the phone company tests the line and claims it is ok, ask them what brand and model of “switch” you are on. Also, ask them if you are on “straight copper” or if you are on any kind of “repeater” or “loop extender”. Ask them how far you are from the switch or nearest repeater. Call Telos Customer Support and give them this information.

External NT1’s have one or more indicators, which can help differentiate line vs. Zephyr Xstream problems. See your NT1 manual for details.

The TEL Status Screen

The status of each B channel is shown here. Press the *TEL* button once to view this screen. The same status information is displayed on the default timeout screen.

The system tries to initialize the ISDN circuit upon boot up. ISDN circuits requiring SPIDS (generally needed in the USA & Canada, never needed outside these countries) will display *SPID Error* if the SPID for specific channel is incorrect.

Note that you may get a false *Ready* indication if the *TELCO* setting (in the second *TEL* menu) is set incorrectly or if no SPIDs are entered when they are required. For status of the NT1 observe the state of the Green LED next to the U interface.

Available line status messages are:

Inactive	No line connected, or connected to wrong jack on the Xstream. Or, ETS 300 permits the Telco to put a line to sleep. Inactivate will be displayed when this occurs.
SPID Pending	S interface is initialized and the SPID has been sent to the Telco switch and Xstream is waiting for it to be accepted. May also be seen intermittently before the S interface has initialized
SPID Error	The SPID sent to network has not been accepted by the switch (DMS Cust. and Natl I-1 only).
Ready	The unit sees a live ISDN S interface (i.e. external NT1 is present or internal NT1 has completed startup) and initial ISDN protocol initialization is complete.
Pending Seize	Outgoing call in process; Request for call has been sent to Telco switch.

Call Proceeding	Outgoing call in process; Telco switch has acknowledged the call request and is waiting for routing information from network.
Outgoing Ring	Outgoing call in process; far end has acknowledged the call and has generated a call alert signal (i.e. it is "ringing")
Accepting Call	Zephyr Xstream has accepted an incoming call and is waiting for the Telco switch to connect it.
Connected XXX	All signaling is complete - the voice channel is available for use. The number of the incoming call, if available, will be displayed.
Disconnecting	Request to disconnect has been made. Awaiting acknowledgment.
Ended	Request to disconnect has been acknowledged but call tear down is complete.
Ring	An incoming call request has been detected and is being processed. If auto ans. (in the <i>TEL</i> menu) is set appropriately, the system will answer the call momentarily.

13.6.2 Using Loop Modes for Troubleshooting

Loop Mode

This item allows the Zephyr Xstream to loop audio through the system.

- None
This is the normal operating mode. None of the loopback paths are turned on. Studio Input is sent as send audio, and caller audio is presented at Studio Out.
- V.35
This loops the incoming V.35/X.21 Receive data on each V.35/X.21 port back out the Xmit data pins on the same port. NOTE: a valid external V.35 clock is required.
- Audio
This loops the AES/EBU input (and analog signal inputs after Analog-to-Digital conversion) back to the AES/EBU output (and analog output via the Digital-to-Analog converter). With this mode engaged you can make signal to noise, THD, and frequency response measurements through the system to check the input and output stages.

- ISDN
 - This option causes two different things to happen.
 - a) Data coming in the ISDN interface (when *INTERFACE* is set to *ISDN*) is sent back out the same channel(s) of the interface. Therefore, the unit on the other end should be able to receive its own audio back (assuming it is configured for compatible Transmit and Receive modes). If this is the case, the network path is functioning.
 - b) Codec data from the encoder is passed back to the decoder (when *INTERFACE* is set to *ISDN*). Therefore, you should receive your own audio back (assuming it is configured for compatible Transmit and Receive modes) with delay and quality dependant on the coding mode used. This tests over 70% of the Xstream's functionality.

This mode can be used to audition the various coding modes even when no ISDN circuit is present.

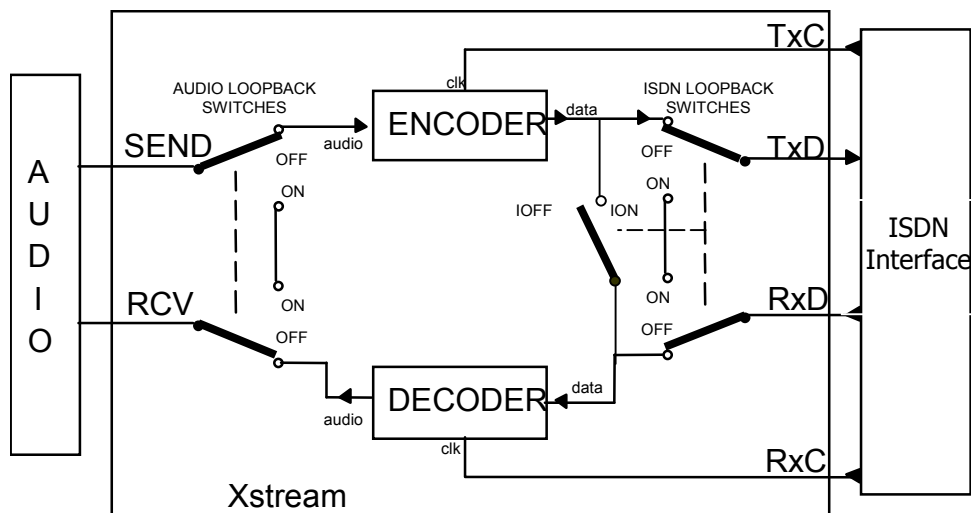

The AUDIO and ISDN loopback modes are illustrated above. The switches on the left side are activated for the AUDIO LOOPBACK mode while the switches on the right are activated for the ISDN LOOPBACK mode.

13.6.3 Audio Difficulties

Condition: ISDN Connecting OK, But No Audio

What is the state of the LOCK LEDs?

Check the LOCK LED. On means OK, connected and receiving valid data. If not illuminated, try cycling through receive modes to see if you can “find” the mode at the other end.

What happens when you call yourself?

Try calling yourself, from one ISDN line to the other (assuming you have both available). Use a 56 kbps rate first, as this is the most universal. Set Rcv mode to L3 Stereo and Xmt to L3 Dual or L3 Stereo) Audio should work in both directions. This confirms that the Zephyr is OK, and that the problem lies somewhere downstream, probably in the Telco’s connection facilities either between its own central office switching equipment or to the long-distance carrier you are trying to use.

What happens to your local audio when you try an ISDN loopback?

If successful, this eliminates over 70% of the Xstream circuitry as the culprit. Remaining suspects would be primarily the ISDN card, or the V.35 card (if relevant to your problem). Remember, Xmt and Rcv modes must be compatible.

Are the coding modes set properly?

The Xmt (transmit) and Rcv (receive) modes and the bitrate must be set in conjunction with those of the unit at the other end. The *Bit Rate* and *Sample Rate* setting must also match.

What happens if you try a different long distance carrier for the call?

What happens if you try the call at 56 vs 64 (or vice versa)?

What happens if you try reversing the direction of the call?

What happens if you try placing a local call as a long distance call?

Since most of the network uses separate transmit and receive paths, it is entirely possible to have a path in one direction but not the other. The above tests may force you through the network via a different path.

If local calls are ok, but long distance calls fail with all three major long distance carriers, then it is likely there is a trunk problem between your local CO and the tandem switch.

Condition: No Audio In Both Directions

Does the Zephyr Xstream’s loopback isolate the problem?

See above for tips on using the loopback modes.

On the other hand, if you can’t receive distant audio, but get a delayed version of your own transmitted signal, it’s possible that one of the Xstreams was left in the loopback mode. We’ve also run across situations where a piece of the Telco’s network gear was left in loopback mode.

Are the Xstream's modes set properly?

The Xstream's *Transmit Mode* and *Receive Mode* (both located in the second *CODEC* menu) must be set to the proper conditions at each end in order for the system to work. See Section 10 (Application Guide) and Section 11 (Detailed Menu Reference) for the correct settings.

Sometimes cycling between modes can clear a decode problem.

Is audio properly connected and configured?

Are the Zephyr Xstream's front panel *Send* bargraph meters indicating signal present at a correct level? If not, check audio connections and cables. Is the Input level setting in the *AUDIO* menu set correctly?

Condition: Audio In One Direction Only

This problem can be either analog or digital in nature. Unlike analog telephone lines, the two directions of a digital line are mostly independent. *It is possible to have a telephone channel failure in one direction only.* One of the following may serve to force you through the network via a different path.

What happens if you try a different long distance carrier for the call?

If you try the call at 56 vs 64 (or vice versa)?

Try reversing the direction of the call?

Try placing a local call as a long distance call?

Are audio signals and connections OK?

It goes without saying – it's got to be plugged-in to work. If the problem is only with one channel reversing A and B audio connections will help problem, isolation.

Do you have a good telephone network path in both directions?

Isolate the problem area by using the loopback techniques described above. Remember, if unit can lock to itself via the far end unit's loopback, then the network path is working.

Condition: Audio Distorted

Mixer models - *Is the AUDIO menu Ch "x" gain selection set correctly?*

Applying a line-level signal to a system configured for microphone levels will make for some pretty awful distortion. Check the clip indicators on the first *AUDIO* menu.

Check the setting of the *Proc X* in *AUDIO* menus 2-5. The *Voice Medium* and *Voice High* settings can be very aggressive.

Non Mixer models

-Is the AUDIO menu "Level In" selection set correctly? Are jumpers JP5 and JP6 set properly for your application?

Gain Trim set OK?

Check the *Send* bargraph meter for proper indication. Confirm that the top *Send* LED is flashing not at all. Input/send gain is set on the *AUDIO* menu screen.

Output setting correct?

The *Level Out* setting in the *AUDIO* menu should match to the equipment that accepts the Xstream's audio feed.

13.6.4 ISDN Difficulties

Condition: Can't Get ISDN "Ready" Indication

First try disconnecting the ISDN circuit(s) in question and waiting a full 60 seconds (leave the Zephyr Xstream on) and then reconnect the circuit.

Are you connected to the correct jack on the rear of the Zephyr Xstream?

If in the USA & Canada: you will probably be using the lower (RJ-11 style) jack.

Outside the USA & Canada: you will probably be using the upper (RJ-45 style) jack. Try dialing. Some Euro ISDN lines will show inactive until they are in use.

Are the jumpers correct on the ISDN Interface card?

JP2, if present, must be jumpered (newer cards no longer have this jumper).

What kind of ISDN do you have, and is the Xstream set to match it?

The telephone company should have given you the ISDN protocol when the line was ordered. If you find yourself in the field without this information, it is usually possible to piece together what you need.

- If you are outside the USA & Canada, you most likely have ETS 300 (Euro ISDN). If you are in Japan, you have INS64. These users do not need to enter SPIDs. MSNs are optional.
- If you are given SPIDs, you probably have National ISDN 1 (NI-1) or DMS 100 (DMS-Cust.) for your ISDN protocol. One SPID means one channel was activated, rather than the usual two. You won't be able to make a stereo connection. National ISDN 2 is backward compatible with the Zephyr Xstream (use Natl.I-1 for *Telco* in the third *TEL* menu)
- No SPIDs and only one phone number generally means AT&T Custom (PTP) protocol. Occasionally PTP users will be given a SPID (usually of the format 01xxxxyyy0). This can be ignored. AT&T Custom (PTP) might be called Lucent Custom (PTP).
- It is best to know both the ISDN protocol of your line as well as the brand and model of the Telco's central office switch itself. A given model of switch only supports a specific set of protocols, so this may help you infer the correct information. Also,

certain peculiarities may be specific to a given switch. Telos Customer Support will want to know your SPIDs and this information when assisting you.

You may be able to guess the correct *Telco* setting based on other available information:

- If you were given only a single phone number and no SPIDs try **AT&T Cust (PTP)**
- If you were given 2 SPIDs with the format: 01+7 digit phone #+0 try **AT&T Cust (PTP)**
- If you were given 2 SPIDs with the format: 01+7 digit phone #+000 or 01+7 digits +011 try **Natl.I-1**
- If you were given 2 SPIDs with the format: area code+7 digit phone #+4 digits (for example 0101, 0100, 0111, or 1111) try **Natl.I-1**. If that fails Try **DMS Cust**
- If you were given 2 SPIDs with the format: area code+7 digit phone #+1 digit (for example 1, or 0) try **DMS Cust**. If this fails try **Natl.I-1**
- If you were given 2 SPIDs with the format: area code+7digit phone #+2 digits (for example 01, 11, 02, or 00) try **DMS Cust**. If that fails try **Natl.I-1**
- If you were given 2 SPIDs with the format: area code+7digit phone #+3 digits (for example 000,001) try **Natl.I-1**. If that fails try **DMS-Cust**
- If you were given a single phone number and a single SPID with the format: of 01+7 digit phone#+0 try **AT&T Cust** (Do not enter this SPID)
- If you were given a single phone number and a single SPID with the format: of 01+7 digit phone#+00 try **Natl.I-1**. If that fails try **AT&T Cust**
- If you were given a single phone number and a single SPID with the format: of area code+7digit phone#+4digits (for example 0101, 0100, 0111, or 1111) Try **Natl.I-1**. If that fails try **DMS Cust**

	<p>ISDN TIP!</p> <p><i>TIPS ON SPIDS</i></p> <p><i>1. Incorrectly entered SPIDs are the most common problem USA/Canada users have placing ISDN calls. Compare the SPIDs you have entered with the SPIDs provided to you by the phone company to be certain that you have entered them correctly. Do not add anything to your SPIDs.</i></p> <p><i>2. Note that there are no hyphens, dashes (-), or spaces in SPIDs, so the system will not allow you to enter any non-numeric characters. If your installer has included them in the SPID, ignore them.</i></p> <p><i>3. For a list of known working SPIDs by Telephone Company see the Appendix 4.</i></p> <p><i>4. If you have any questions about your SPIDs, call your phone company.</i></p> <p><i>5. If you have AT&T Custom Point-to-Point or Euro-ISDN, you should not enter anything in the SPID fields.</i></p>
---	---

ISDN TIP FOR BELLSOUTH CUSTOMERS!

Despite the fact the BellSouth originated the proposal for the standardised SPID (see above) many regional Bell South offices leave off the last two digits of the SPIDs.

If you are a BellSouth customers and are given a SPID of the format: Area Code + 7 digits + 01 and you get "SPID Error" your correct SPID is probably Area Code + 7 digits + 0101 or Area Code + 7 digits + 0100.



In the case of Natl.I-1 or 2, and DMS-100 Custom. Carefully verify that you have the correct SPID from the Telco, and that you have properly entered it into the system. It must be correct in order for anything to work! We've seen a few cases where it was given incorrectly by Telco personnel, so it might be a good idea to re-check with them if things are pointing in this direction.

HOT TIP!

If you suspect the SPIDs given you are wrong, or the basic line provisioning (configuration) is incorrect, call the Telco and ask to speak to someone who can "log into the switch". They will probably need to have someone call you back. Only once you have this person on the line, and they are logged into the switch, ask them to look at the SPIDs programmed there. Also get this person's fax number and send them the ISDN ordering information from the Appendix of this manual.

Sometimes the information in the business office computer is wrong. By verifying what is programmed into the actual switch, you can save time and frustration.



We've included some useful diagnostic aids in the system to help you determine where a problem is originating. A good starting point is the ISDN status, accessible on the LCD by pressing the *Status* button:

Status Screen for ISDN troubleshooting

This screen shows the status of the ISDN connection for each B channel. You can determine if the line is connected and whether the line and the Xstream are successfully configured. In addition, information about calls is displayed here. One of the following status words will be shown for each active ISDN channel:

Available line status messages are:

Inactive – This indicates that neither the built-in NT1, nor the S interface is active. This will be displayed if no ISDN line is present (or is connected to the wrong jack on the Xstream). It is also displayed on ETS 300 (Euro-ISDN) lines after periods of inactivity (the ETS 300 standard allows the central office switch to put the line to sleep).

SPID Pending – This option is only valid when the Telco selection of the TEL menu is set to "Natl.I-1" or "DMS Cust.". Indicates that the S interface is initialized and the SPID has been sent to the Telco Switch and the Xstream is waiting for it to be accepted (it will be sent again if no reply is received). This may be briefly displayed before the S interface has come up.

SPID Error - This option is only valid when the Telco selection of the TEL menu is set to "Natl.I-1" or "DMS Cust.". The SPID entered for the indicated channel is has not been accepted by the Telco switch. You may have entered it wrong, or the Telco may have given you the wrong SPID (or entered the SPID incorrectly in their switch) or ISND protocol type.

Ready – This indicates that an ISDN S interface is active (i.e. external NT1 is present or internal NT1 has completed startup). It indicates that all handshaking with the central office is complete (the SPIDs, if required and entered, are correct) and the line is ready to be used.

Connected: xxx - The channel is connected to "xxx". "xxx" is the caller ID of the calling party, if available for calls originated from the far end. "xxx" is the number dialed for calls originated by the Zephyr Xstream. A call timer will be displayed on indicating the length of time the call has been connected.

Seize Pending - Outgoing call in progress; Request for call has been sent to the Telco switch and Zephyr Xstream is awaiting acknowledgment.

Seized - Outgoing call in progress. Waiting for local switch to acknowledge.

Proceeding - Outgoing call in progress. Telco switch has acknowledged the call request and is awaiting routing information from the network.

Outgoing Ring - Outgoing call in progress; far end has acknowledged the call and has generated a call alert signal (i.e. it is "ringing").

Ring: xxx - Incoming call from "xxx" has been detected and is being processed. "xxx" is the caller ID of the calling party, if available. If auto ans. (in the TEL menu) is set appropriately the system will answer the call momentarily.

Accepting Call - Zephyr Xstream has accepted an incoming call and is waiting for the Telco switch to connect it.

Disconnecting - Request to disconnect has been made. Awaiting acknowledgement.

Ended - Request to disconnect has been made and the call has been cleared.

Two caveats regarding the Ready indication: If you have this indication with the *Telco* set to *AT&T Cust. (PTP)* and you cannot dial, it is likely that your line is *Natl. I-1* or *DMS-100*. The AT&T custom protocol does not require SPIDs, so the Zephyr Xstream does not send or check them; it just assumes the line is OK in this regard, so it gives the Ready indication, though the line is waiting for the SPIDs. Also, be sure that the *SPID 1* and *SPID 2* fields (in the second TEL menu) are blank when using AT&T Cust. (PTP).

You will also get see a false Ready indication if no SPIDs are entered and your *Telco* is set to *Natl I-1* or *DMS Cust.*



IMPORTANT!

*It is normal for ETS300 lines to go **Inactive** when not used for a time. If the system can dial normally under these circumstances, this indication is not a cause for alarm.*

Is the problem only with one BRI circuit? Does the problem move when you switch the line to another ISDN unit?

If the problem remains with the line, then call your Telco. If you are supposed to be using the Xstream's built-in NT1 (i.e. the U interface) be sure to note if you have U Sync (note the green LED near the U jack on the rear of the Xstream). If you have a fast blinking U Sync light the problem is most likely your ISDN circuit. If the U Sync LED is lit solidly, then suspect a line configuration ("provisioning" in Telco-speak) problem (also review the information in the previous questions).

Are you using the Xstream's internal NT1 ? (USA & Canada only)

The LED indicator of the status of the ISDN connection is on the rear panel near the U jack. If the circuit is inactive, the LED will remain in the rapidly flashing state. This state indicates a loss of the ISDN BRI circuit at the lowest (physical) level. Try another line cord or try another line in to see if the same thing happens.

If the NT1 can contact the central office, the LED will blink slowly (about 1 Hz). If the LED remains in this state there is an internal Xstream problem or you could be connected to the wrong jack on the back (Users in USA & Canada should be using the lower, RJ11 style, jack). The LED will come on solidly when all handshaking is completed and the basic (low level) line connection is good.

If the LED stays on, with the ISDN disconnected, or does not come on at all, there is a hardware problem. See above for more on this LED.

Condition: Line 1 will accept call however Line 2 will not

*Have you entered Directory numbers in the **MSN/DN1 &2** entries in the **TEL** menu?*

These are required if you are using *DMS-Custom* or *Natl I-1* for your ISDN type.

Condition: Can place calls, or receive calls, but not both

If your line is using National ISDN and your *Telco* is set to *DMS Cust.*, or vice versa, you may see this behavior. Try the other setting.

If your line is using National ISDN or DMS-Custom, you must have your Directory Numbers entered to receive calls.

Condition: System says Ready but attempted calls do not complete (goes back to Ready or sits at Seize Pending)

Are your SPIDs and Telco setting correct?

We've included quite a few useful tips above on SPIDs and on how to guess your ISDN protocol. If SPIDs are required and have been omitted a false "Ready" may be displayed.

Can you dial from Line 1 to Line 2?

If you can successfully call from one line to the other, you know that your SPIDs and ISDN protocol settings for that line are correct and that the ISDN circuit itself is ok.

Try a call to another local number. Have the far end try this test as well.

Try calling yourself, both using both “call type – Zephyr” and “call type – phone”. Your line may be configured for only voice (CSV) or only data (CSD).

If you cannot complete this call try dialing with a 9, 8, 7, or 6 before the number. Sometimes ISDN lines are set up as Centrex service even if you did not request this.

Note the Cause Code or Words displayed when the Zephyr Xstream releases the line. See Appendix 3.

Is your long-distance carrier OK?

If you can successfully call locally, but long-distance calls don't go through, the Zephyr Xstream usually displays Far end disconnect, or No route available as the ISDN “Cause” phrase.

You may try a different by dialing the appropriate 10XXXXX prefix (in the USA & Canada only). Some codes we have found that are worth trying are:

1010222 (MCI)

1010288 (AT&T)

1010333 (Sprint)

You will dial as follows (dial prefix, if required) + 10xxxxx + 1 + area code + 7 digit phone number.

In the USA, you can determine who your long distance carrier is by dialing 1+700+555+4141 using the *PHONE* call type. If Intra-LATA long distance competition has reached your area you can determine your Intra-LATA long distance carrier by dialing 1+area code+700+4141.

What does the ISDN “Cause” phrase say?

This phrase, which will appear on the ISDN status screen whenever the line is released, comes directly from the telephone company equipment, and can be valuable for troubleshooting. Generally, these phrases are self-explanatory. Getting them means you are at least talking to the Central Office equipment. There is a full description of the phrases and their meaning in Appendix 3.

Condition: Intermittent ISDN Problems

These are among the most difficult kinds of problems to solve. Rest assured, however, that we have yet to lose one!

Does the problem occur on all of the ISDN BRI circuits or just a single BRI circuit?

If your Zephyr Xstream works fine on another circuit, then it is unlikely it is the cause of your troubles. Tell the Telco this, and give them the phone numbers for the good line.

If the problem is limited to a single BRI circuit (i.e. both “lines” on that BRI are showing the problem) then the problem is probably with that BRI circuit.

When using the built-in NT1, and the *U sync* LED occasionally cycles to the fast flashing state, then the line or NT1 is marginal.

What is consistent about the problem (look for patterns)?

Keep watching for a pattern. Enlist the help of the users. We've seen apparently random problems that we eventually discovered only occurred when it rained, or on a certain day each week, or at a certain time of day, or only when another line was in use. In other cases, difficulties were due to temperature or dirty AC power. Assume nothing, and suspect everything. Leave no stone unturned while searching for the answer.

Any other ISDN troubleshooting Tips?

An important tool for understanding fundamental compatibility problems is the Zephyr Xstream's integrated ISDN analyzer. This allows examination of the transactions between the Telco line and the Xstream, so that a judgment can be made as to whether the problem lies within the Xstream or with the programming of the Telco switch. This can be useful when the line itself tests good, but something is incorrectly configured at the Telco.

The usual cause of inability to dial problems is a Telco problem, such mis-programming.

If you are convinced that the problem lies with the ISDN line configuration, you may be able to convince the Telco to have an engineer look at the line with an analyzer. This works much like the Zephyr Xstream's internal analyzer, but with more detail, and in a format that is more readily understandable by telephone people. This procedure may sometimes be the only way to get attention to a line configuration problem. It is hard to deny evidence provided by their own gear.

In rare cases, there could be a software bug in the Zephyr Xstream that reacts badly to something coming from the ISDN line. Telos customer support will need the details about your lines, Zephyr Xstream version and configuration. They will probably need you to use the protocol analyzer and a PC to make a log of the problem and will then communicate this information to our engineering folks for analysis. It is critical that you give them a precise description of exactly what happens when the problem occurs, and at what point in the log we should focus our efforts (i.e. the problem happened 45 minutes after we began this log). We are happy to help, but we must rely on your eyes and ears to help you.

See Section 12 (System Functions and Remote Control) for information on connecting to the Xstream's serial or Ethernet port and using the command line interpreter to turn on ISDN logging. The most useful logs to enable for this purpose are "ISDN", il2, il3, and iie.

13.6.5 Ethernet Related Difficulties

Condition: Unable to Telnet into the Xstream

Is the Green link LED on the Ethernet jack lit? Is the "Link" LED on the hub or other equipment lit?

If there is no link light, the Ethernet link is not up. The most likely cause is a bad cable. Other possible causes are a possible failure of the Xstream's Ethernet port or a problem with the hub (or other device at the far end).

If you are connecting directly without an Ethernet hub, note that a special cable must be used (See Appendix 9 - Modular Cable Reference)

The Xstream's command line interface is on the default Telnet port (Port 23). Verify your Telnet client is using this port.

Does the Amber activity LED on the Ethernet illuminate occasionally?

Whenever there is an active Ethernet link, you should see occasional activity of this LED. Lack of activity may indicate a problem with the Xstream. Reboot the Xstream and re-check

Does the Xstream have an IP address entered? Does the Telnet computer have an IP address? Are they in the same IP range?

The Xstream uses IP (Internet Protocol). IP addresses are required. Each device on the network must have *unique* IP address.

Can you "Ping" the Xstream from the Telnet computer?

If you cannot "Ping" the Xstream there is most definitely a problem. Make sure the Xstream's IP address is entered correctly. Try to "Ping" some other computer from the Telnet computer to isolate the problem.

If you can "Ping" the Xstream, but you cannot Telnet into it, there may be a firewall between the two devices. Your network administrator should be able to open the firewall for Telnet access between these two IP addresses. (Note Telnet is port 23).

Condition: Unable to connect to a distant site using IP (i.e. to receive audio)

Can you "Ping" or "Telnet" to the distant Xstream from another computer on your local network?

If not see the condition above.

Can you ping the streaming machine from the Xstream?

Use the "ipping" command from Telnet or the serial port (note "result = -1" means failed while "result = 0" means success).

Is the distant Xstream configured for Ethernet operation?

Is/Are the appropriate Port(s) open on the firewall (or configured via port forwarding)? SIP operation requires 2 ports.

Condition: Able to connect and lock to a distant site using IP, but audio dropouts occur frequently

Do local LAN connections work ok (or with a greatly reduced number of dropouts)?

Increasing the buffer setting may help. Also note that the Xstream has error concealment technology when using AAC, so we recommend using that protocol for this reason.

Try increasing the buffer size in the *CODEC* menu

What QOS (Quality of Service) mechanism is in place on the IP path between the two sites?

Such QOS control is currently impossible if the path includes the public Internet. QOS options on a private network are limited. If no other equipment is sharing the IP link, then QOS is a non-issue. As soon as other equipment shares the link, it has the ability to use all bandwidth at times it needs it (when downloading or transferring a file, for example).

Your network equipment and IP link service provider *may* be able to assist with strategies. A qualified Information Technologist will be invaluable.

One crude strategy, when only a few devices will share the link, is to use the Ethernet port to limit bandwidth. For example, if your primary point-to-point link is at 100 Mbps (mega bits per second), and it is fed from a *single* Ethernet hub using an Ethernet 100 Base-T (100 megabit) hub you could connect a limited number of 10 Base-T (10 megabit) devices. In this case you should be able to use eight to nine 10 Base-T devices. These devices *must not* use 100 Base-T or they can swamp the 100 megabit connection.

The same setup could be used with smaller number of 10 Base-T connections if the link were at a lower rate (i.e. you could connect three 10 Base-T devices if the link were 50 Mbps).

Unfortunately, the usual case is that the point-to-point link is at a rate much lower than 10 mbps - often, 2.048 or 1.544 kbps (kilobits per second) or less. In this case, the simple strategy above cannot be used.

Another problem with IP delivery is "packet loss". Most IP providers do not guarantee a specific degree of packet loss. Note that there are some exceptions. In particular, MPLS-based services often provide more than one "class of service" or priority level which can allow the system designer to protect bandwidth for critical operations such as codecs.

What is the "packet loss" of the IP path?

Does the problem disappear if other devices are removed from the IP network (i.e. does it work if the IP network is not shared on either end)?

Condition: Unable to connect in IP streaming modes.

Your firewall and router may not be permitting the IP streams to pass to the Xstream. You may need to use port forwarding to pass the audio packets to the Xstream. At the minimum you must open the UDP port (default is 9150).

Condition: Unable to connect when using SIP mode.

If standard streaming works, and SIP streaming does not, then the proper port for SIP is probably not been opened up on the firewall. Both the SIP (default is 5060) and the UDP (default is 9150) ports must be available when SIP is used. Audio in only one direction can be caused by having the UDP port open only on one end.

13.6.6 Other Difficulties

Condition: Xstream powers up, but the writing on the LCD is too faint to read.

Possibly someone changed your contrast setting. We made this the first selection in the <SYSTEM> menu for a reason. Follow these steps:

1. Press the <TEL> button once.
2. Press the <SYSTEM> button twice.
3. Press the <SEL> button once.
4. Press the <▲> button repeatedly until the screen contrast is at the desired level. Press the <SEL> button to save your setting.

NOTE: The contrast is somewhat affected by temperature, so you may need to tweak this once the unit has come up to operating temperature.

Condition: No Basic Functionality

Does the Zephyr Xstream have power?

Whenever the unit is powered up the LCD display backlight should be on. If the *Interface* menu selection in the *ISDN* menu is set to "ISDN", the SYNC LED should be illuminated whenever power is applied. Is the switch on? Is the cord plugged-in? Does the outlet have power? Is the Xstream's fuse blown (see below)?

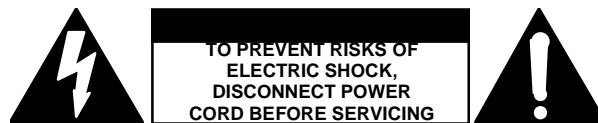

CAUTION

The installation and servicing instructions in this manual are for use by qualified personnel only. To avoid electric shock do not perform any servicing other than that contained in the Operating Instructions unless you are qualified to do so. Refer all servicing to qualified service personnel.

	<p>CAUTION - DANGER!!</p> <p><i>The Zephyr's power fuse is located inside the box, on the power supply module. To change it, you will have to remove the top cover. Be sure to remove AC power before opening the unit.</i></p> <p>For continued protection against fire, replace fuse only with same type and value.</p>
---	---

If fuse replacement is required, please note: **For continued protection against fire, replace fuse only with same type and value.** See the section Gaining Access for information and important cautions.

Does the Xstream have any functionality?

Upon initial power-up, the LCD shows "crosshairs", then briefly a black screen. Finally the version and the Zephyr Xstream logo.

During the initializing period, a self-test is performed. If there is a problem, this is reported on the LCD screen and progress is halted. The entire message should be noted for discussion with Telos customer support.

If the failure is does not involve a critical portion of the Xstream, you may be given the option to "continue". We give this option for emergency desperation use only - you will need to determine if you unit will work for the intended purpose. You should have the machine serviced as soon as possible if this happens.

If the unit does not reach the show the Zephyr Xstream logo and software version, suspect a problem with the system processor, system clocks, or memory.

If the "Crosshairs" are showing on the LCD screen, it may mean that the front panel and the main board have lost communication - possibly because the main board processor rebooted for some reason. Or, possibly because the main board did not boot up. In the former case, the unit may be able to accept calls and connect without front panel functionality. In that case, you may be able to use one of the remote control options to control the unit until the unit can be repaired.

14 SPECIFICATIONS & WARRANTY

14.1 Specifications

General

- Full duplex, high-fidelity codec using MPEG-2 AAC, MPEG-4 AAC-LD MPEG-2 Layer-3, MPEG-2 Layer-2, AACPlus, and G.722; fully compliant with international standards.

Frequency Response

(+0/-1dB, swept sine tone procedure)

- AAC all modes except Stereo 64: 20-19,800Hz at 48kHz fs., 20-15,000Hz at 32kHz fs.
- AAC Stereo 64: 20-10,000Hz at 48kHz fs., 20-7,000Hz at 32kHz fs
- AACPlus mono (for use reception from the Xport): 20 –15,000 Hz 48kHz fs
- Layer-3 all modes: 20-16,000Hz at 48kHz fs., 20-15,000Hz at 32kHz fs
- Layer-2 mono, dual-mono: 20 Hz-7.8kHz/9.8kHz
- Layer-2 mono 20 Hz- 8.6 kHz at 24 kHz fs.
- Layer-2 joint stereo: 20-20,000Hz at 48kHz fs. 20-15 kHz at 32kHz fs
- G.722: 20-7,500Hz.

THD+N

- Audio loopback, 48kHz fs, analog I/O, input at 1kHz +20dBu: 0.004%

Dynamic Range

- A Weighting, AAC, Layer-3 or 2 end-to-end: 101dB typical

Send Input

Active balanced with RF protection.

Zephyr Xstream:

- LINE: Settable to -11 or +4dBu (or -15 to 0 dBu) nominal level
- Clip point: 18 dB above chosen nominal level.
- Impedance: > 10K Ω (x2)
- Connector: XLR female/quarter-inch TRS combo connector.

Zephyr Xstream MX and MXP:

- LINE: -11 or +4dBu nominal level (switchable).
- MIC: Accepts -65 to -24 dBu in 2 ranges (switchable). Mic impedance \leq 1000 Ω
- Clip point: 15 dB above chosen nominal level.
- Impedance: Line > 10K (x2)
- Connector: XLR female/quarter-inch TRS combo connector.

Limiter

Zephyr Xstream MX and MXP only:

- Internal DSP-based AGC/limiter with Omnia[®] audio processing. Includes presets for music & voice, selectable per channel.

Zephyr Xstream:

- Analog soft-clipper prevents A/D converter overload without loss of dynamic range.

Line Bit Rates (ISDN)

- 56 or 64kbps per channel, front panel selectable.

Bit Rates (V.35/X.21)

- 56, 64, 112 (imuxed), 128 (imuxed), 96, 128, 256, 384 kbps front panel selectable.

Receive Output

- Active differential.
- Level: Front panel selectable for -10 or +4dBu, nominal.
- Impedance: < 33 Ω (x2)
- XLR male

AES/EBU Digital I/O (non-mixer version only)

- Sample rates supported: 32, 44.1 and 48kHz
- Rate conversion: Input and output independently selectable. Can be bypassed.
- Input clock: From external source or Telco clock.
- Output clock: From transmission sample rate, external source, or AES/EBU input.

Inverse Multiplex/Demultiplex

Internal channel splitting/combining of two network channels for stereo modes.

- AAC: Telos Zephyr™ protocol.
- AAC-LD: Telos Zephyr™ protocol.
- Layer-3: FHG/Telos Zephyr™ (Buchta) protocol.
- Layer-2: CCS CDQ™ protocol compatible.

Optional V.35/X.21 Direct Digital Interface

- Two ports, both V.35/X.21. Automatically selected when the appropriate cable is connected.

ISDN Interface

- Compatible with National ISDN, AT&T 5ESS custom, Northern Telecom DMS-100 custom, Siemens EWSD, INS 64(Japan) and EURO-ISDN (ETS-300). Compatibility and approval pending in some countries; contact Telos for current status.

LAN Interface

- 100Base-T Ethernet port using RJ-45 connector. Full Duplex Supports TCP/IP (HTML, Telnet and FTP).

ISDN Voice Telephone Mode

- Two channels using G.711 standard, μ -Law or A-Law. 300–3,400Hz. DTMF signaling provided (CCITT standard).

Remote Control and Ancillary Data

- RS-232 9-pin D-Sub female (DCE): Asynchronous; 8 data, no parity, 1/2 stop, 2400-57,600 bps.
- 100Base-T Ethernet port using RJ-45-style connector using Telnet or web browser (HTML).

- Bi-directional ancillary data: Serial connection at 2400 or 9600 (AAC and Layer 3) bps; eight contact closures (for end to end transmission or local status and control).

IP Support

- via Ethernet 100 Base-T Ethernet port.
- Uses fixed IP address
- Port 23 supports Telnet sessions
- Port 80 used for HTML browser interface
- Port 8080 supports MPEG streaming in MPEG Layer 3 or AAC
- Port 5060 for SIP signaling
- Port 21 used for FTP software updates (10 Base-T units only).

Software Upgrades

- Downloadable from Telos; browser based upload via 100Base-T Ethernet connection.

Control Ports

- Eight bi-directional inputs/outputs for end-to-end contact closure emulation.
- Inputs: Open collector, closure to ground. Integral pull up. Supports up to 24 volts DC inputs
- Outputs: Sink up to 125 mA to ground. Integral pull up to 5 volts (voltages greater than 5 volts may be used with external pull-ups)

Resolution

- Send Input: MPEG 24 bits; G.722 16 bits
- Receive Output: MPEG 24 bits; G.722 16 bits

Power Supply

- 90-240 VAC (50/60 Hz) auto-configuring.
- 100 watts peak

Dimensions, Zephyr Xstream and Zephyr Xstream MX

- 19" (48cm) standard rack mount front panel
- 17 1/8" (43cm) wide behind front panel
- 12 1/2" (32cm) deep
- 3 1/2" (9cm) high

Dimensions, Zephyr Xstream MXP

- 18 1/4" (46cm) wide
- 14" (36cm) deep
- 4 1/4" (11cm) high

Shipping weight

- 13 pounds (5.9 kg) (MXP)
- 9 pounds (4 kg) (non-mixer)

CE approved

All specifications subject to change without notice

14.2 Zephyr Xstream Limited Warranty

This Warranty covers “the Products,” which are defined as the various audio equipment, parts, software and accessories manufactured, sold and/or distributed by TLS Corp., d/b/a Telos Systems (hereinafter “Telos Systems”).

With the exception of software-only items, the Products are warranted to be free from defects in material and workmanship for a period of one year from the date of receipt by the end-user. Software-only items are warranted to be free from defects in material and workmanship for a period of 90 days from the date of receipt by the end-user.

This warranty is void if the Product is subject to Acts of God, including (without limitation) lightning; improper installation or misuse, including (without limitation) the failure to use telephone and power line surge protection devices; accident; neglect or damage.

EXCEPT FOR THE ABOVE-STATED WARRANTY, TELOS SYSTEMS MAKES NO WARRANTIES, EXPRESS OR IMPLIED (INCLUDING IMPLIED WARRANTIES OF MERCHANTABILITY AND FITNESS FOR A PARTICULAR PURPOSE).

In no event will Telos Systems, its employees, agents or authorized dealers be liable for incidental or consequential damages, or for loss, damage, or expense directly or indirectly arising from the use of any Product or the inability to use any Product either separately or in combination with other equipment or materials, or from any other cause.

In order to invoke this Warranty, notice of a warranty claim must be received by Telos Systems within the above-stated warranty period and warranty coverage must be authorized by Telos Systems. If Telos Systems authorizes the performance of warranty service, the defective Product must be delivered, shipping prepaid, to:

**Telos Systems
2101 Superior Avenue,
Cleveland, Ohio, USA
44114
RA Number: (as provided by Telos Support)**

Telos Systems at its option will either repair or replace the Product and such action shall be the full extent of Telos Systems’ obligation under this Warranty. After the Product is repaired or replaced, Telos Systems will return it to the party that sent the Product and Telos Systems will pay for the cost of shipping.

Telos Systems’ authorized dealers are not authorized to assume for Telos Systems any additional obligations or liabilities in connection with the dealers’ sale of the Products.

Telos products are to be used with registered protective interface devices which satisfy regulatory requirements in their country of use.

APPENDICES

Appendix 1: Codec Interoperability Information

The Xstream will communicate with G.722 and MPEG compliant codecs.

At the time of the release of this manual, we had tested interoperability with the following ISDN codecs.

CCS/Musicam

- CDQ 1000
- CDQ 2000
- CDQ Prima
- Roadrunner

Comrex

- Nexus
- DXP
- DXR

Dialog 4

- VP Pro
- Slimline (must set "compatibility" in Codec menu to "Slimline")

Telos

- Zephyr
- ZephyrExpress
- Zephyr Xport (over POTS or ISDN)

We continue to confirm interoperability with other codecs.



USER'S MANUAL

Appendix 2: Finding Public Codec User Lists

When you need to find a Zephyr Xstream, ZephyrExpress, Zephyr, or compatible codec to communicate with in another city, there are a number of resources to which you can turn. There are thousands of sites around the country – and the world – which offer a wide variety of services.

Some are music recording studios; some are broadcast stations; some are recording studios specializing in broadcast projects; and many are home studios belonging to announcers or producers. Some come with award-winning engineering or vocal talent, while others are offered “bare.” Chances are you’ll find what you are looking for somewhere below.

Telos World Wide Web site

<http://www.telos-systems.com> will connect you to a variety of information about Zephyr Xstream, Zephyr ZIP Codec, Zephyr iPort, and ISDN, including site pointers.

Audiobahn

A list of broadcasters and sound studios using codecs, maintained by Jay Rose’s Digital Playroom, a broadcast promo studio in Boston.

These sites have submitted their names so other professionals can call them for news feeds help with remotes, audio transfers, and so on. All services are optional, and fees are negotiated by the parties involved. The list is maintained as a public service to help you find each other... after that, it’s up to you.

Audiobahn is updated approximately once a month. Submission information is on the list, and has to follow a precise format. Comments may be sent by e-mail to: jay@dplay.com.

<http://www.dplay.com>

Digifon List

Dave Immer’s Digifon publishes a list of codec users around the world, heavily geared toward recording studios. Most (those using equipment which supports MPEG Layers II or III) are able to work with ZephyrXstream. Those that cannot (mostly APT-X, but some Dolby) are able to do so via various bridge services, including one offered by Digifon itself. The list is available on the World Wide Web. Send e-mail comments to immer@digifon.com.

<http://www.digifon.com>
203-254-0869
203-256-5723 (Fax)

EdNet

San Francisco, CA
415-274-8800

Service to recording studios and broadcasters. Operates about five hundred sites, mostly at recording studios. They handle billing and booking, etc. Provides "translation" service. Offer full tech support, ISDN line ordering, etc. Full-service Zephyr dealer.

Appendix 3: ISDN Cause Phrases/Values

When there is an ISDN event or problem in the network, a cause code appears on the LCD screen or ISDN protocol log that communicates information about the cause of the trouble. See section 12.2 for how to enable ISDN logging through the serial or Telnet port. These "Cause Values" are numbers generated by the network, which the Xstream translates to the associated phrases. When possible, we use those suggested by the Bellcore standard. Note that in some cases there may be more than one meaning. This can frequently be evaluated by whether the message has been received by the calling party or the called party, or by the ISDN protocol being used.

We have included the most common cause codes here. For a complete list, see <http://www.telos-systems.com/techtalk/default.htm> .

CLASS 1.1 (normal)

Cause No. 1 - Check number, redial (unallocated number)

This cause indicates that the called party cannot be reached because, although the called party number is in a valid format, it is not currently allocated (assigned).

Cause No. 2 - No route to network /Prefix 0 dialed in error

This cause indicates that the equipment sending this cause has received a request to route the call through a particular transit network which it does not recognize. The equipment sending this cause does not recognize the transit network either because the transit network does not exist or because that particular transit network, while it does exist, does not serve the equipment which is sending this cause.

or

This cause indicates the prefix 0 is invalid for the entered number

Cause No. 3 - No route to dest./Prefix 1 dialed in error

This cause indicates that the called party cannot be reached because the network through which the call has been routed does not serve the destination desired. This cause is supported on a network-dependent basis.

or

A 1 was dialed when not required. Redial without the 1.

Cause No. 4 – No prefix 1/Special Information Tone

The prefix 1 is not required for this number

or

This cause indicates that the called party cannot be reached for reasons that are of a long term nature and that a special information tone should be returned to the calling party.

Cause No. 10 – Prefix 1 not dialed (DMS Custom only)

Indicates that the prefix 1 was not included in the called party address and is required.

Cause No. 11 – Excessive Digits Received, call is proceeding

More digits were dialed than expected. Called number has been truncated to the expected number.

Cause No. 14 – Excess digits received, call is proceeding

More digits were dialed than expected. Called number has been truncated to the expected number.

Cause No. 16 - Far end disconnect (Normal call clearing)

This cause indicates that the call is being cleared because one of the users involved in the call has requested that the call be cleared. Under normal situations, the source of this cause is not the network.

Cause No. 17 - Busy, try again later (User busy)

This cause is used to indicate that the called party is unable to accept another call because the user busy condition has been encountered. This cause value may be generated by the called user or by the network. In the case of user determined user busy it is noted that the user equipment is compatible with the call.

Cause No. 18 - No far end response (No user responding)

This cause is used when a called party does not respond to a call establishment message with either an alerting or connect indication within the prescribed period of time allocated (before timer T303 or T310 has expired).

Cause No. 19 - No answer (No answer from user, user alerted)

This cause is used when the called user has provided an alerting indication, but not a connect indication within a prescribed period of time (before timer T301 has expired).

Cause No. 21 - Call rejected

This cause indicates that the equipment sending this cause does not wish to accept this call, although it could have accepted the call because the equipment sending this cause is neither busy nor incompatible.

This cause may also be generated by the network, indicating that the call was cleared due to a supplementary service constraint.

Cause No. 22 - Number changed

This cause is returned to a calling party when the called party number indicated by the calling party is no longer assigned. The new called party number may optionally be included in the

diagnostic field. If a network does not support this cause, cause no: 1, unallocated (unassigned) number shall be used.

Cause No. 26 – Non-selected user clearing

This cause indicates the user has not been awarded the incoming call.

Cause No. 27 – Destination out of order

This cause indicates that the destination indicated by the user cannot be reached because the interface to the destination is not functioning correctly. The term "not functioning correctly" indicates that a signal message was unable to be delivered to the remote party; e.g. a physical layer or data link layer failure at the remote party, or user equipment off-line.

May also indicate local unit has incorrect SPIDs.

Cause No. 28 - Incorrect number (invalid number format, address incomplete)/Special intercept announcement

This cause indicates that the called party cannot be reached because the called party number is not in a valid format or is not complete.

or

This cause indicates the user should be returned a Special Intercept Announcement.

Cause No. 31 - Network disconnect (Normal, unspecified)/Special intercept announcement: Call blocked because of group restrictions

This cause is used to report a normal event only when no other cause in the normal class applies.

or

This value indicates that a user from outside a basic business group (i.e. Centrex) violated an access restriction feature

CLASS 1.2 (Resource unavailable)

Cause No. 34 - No circuit available (circuit/channel congestion)

This cause indicates that there is no appropriate circuit/channel presently available to handle the call.

Cause No. 38 - Net out of order

This cause indicates that the network is not functioning correctly and that the condition is likely to last a relatively long period of time e.g. immediately re-attempting the call is not likely to be successful.

Cause No. 41 - Net problem, redial (Temporary Failure)

This cause indicates that the network is not functioning correctly and that the condition is not likely to last a long period of time; e.g. the user may wish to try another call attempt almost immediately. May also indicate a data link layer malfunction locally or at the remote network interface or that a call was cleared due to protocol error(s) at the remote network interface.

Cause No. 42 - Net busy, redial (Switching Equipment Congestion)

This cause indicates that the switching equipment generating this cause is experiencing a period of high traffic.

Cause No. 44 - No channel available (Requested circuit/channel not available)

This cause is returned when the circuit or channel indicated by the requesting entity cannot be provided by the other side of the interface.

Cause No. 47 - Resource unavailable/New Destination

This cause is used to report a resource unavailable event only when no other cause in the resource unavailable class applies.

or

This cause is used to indicate that the original destination is unavailable and to invoke redirection to a new destination.

CLASS 1.3 (service or option not available)

Cause No. 50 – Requested facility not subscribed

The cause is used to report that the user cannot use this feature because s/he has not subscribed to it.

Cause No. 51 – Bearer capability incompatible with service request

This cause indicates a user request for action was rejected because the action was incompatible with the capability of the call.

Cause No. 52 – Outgoing calls barred

This cause indicates that because of call screening provided by the network, the calling user is not permitted to make a call.

Cause No. 54 – Incoming calls barred

The user will not accept the call delivered in the SETUP message.

Cause No. 57 – Bearer capability (Data/voice) not authorized.

This cause indicates that the user has requested a bearer capability which is implemented by the equipment which generated this cause but the user is not authorized to use it. This is a common problem caused by wrong Telco provisioning of the line at the time of installation.

Cause No. 58 – Bearer capability not presently available

This caused indicates the user has requested a bearer capability which has been implemented by the equipment, but is not available at this time.

CLASS 1.4 (Service or option not implemented)

Cause No. 63 – Service or option not available, unspecified

This cause is used to report a service or option not available, only when no other cause in this class applies.

Cause No. 65 - Bearer Capability not implemented (Incompatible bear cap)

This cause indicates that the equipment sending this cause does not support the bearer capability requested.

Cause No. 66 – Channel type not implemented

This cause is returned when the called party has reached a channel type not supported.

Cause No. 69 – Requested facility not implemented

This cause indicates that the network (or node) does not support the requested bearer capability and therefore cannot be accessed at this time.

Cause No. 79 – Service or option not implemented, unspecified

This cause is used to report a service or option not implemented event only when no other cause in this class applies.

CLASS 1.5 (Invalid message; e.g. parameter out of range)

Cause No. 88 - Incompatible destination

This cause indicates that the equipment sending this cause has received a request to establish a call which has low layer compatibility, high layer compatibility or other compatibility attributes (e.g. data rate, DN sub-address) which cannot be accommodated. This cause can also be returned by a switch to a CPE when trying to route a call to an incompatible facility, or one without data capability.

Cause No. 90 – Destination Address Incomplete/Non-existent CUG

Used to indicate that the destination address is missing or incomplete
or

Used to indicate a non-existent Closed User Group

Cause No. 95 – Invalid message, unspecified

This cause indicates that the entity sending this cause has received an Invalid message, only when no other cause in this class applies.

CLASS 1.6 (Protocol error; e.g. unknown message)

Cause No. 96 – Mandatory Info missing

This cause indicates that the equipment sending this cause has received a message which is missing an information element which must be present in the message before that message can be processed.

Cause No. 97 - Message type non-existent or not implemented

This cause indicates that the equipment sending this cause has received a message with a message type it does not recognize either because this is a message not defined, or defined and not implemented by the equipment sending this cause.

Cause No. 98 – Message not compatible

This cause indicates that the message received is not compatible with the call state or the message type is non-existent or not implemented.

Cause No. 99 – Info non-existent or not implemented, call processed

This cause is sent when the equipment sending this cause has received a message which includes the information elements not recognized because the information element identifier is not defined or it is defined but not implemented by the equipment sending the cause. However, the information element is not required for the equipment sending the cause to process the message.

Cause No. 100 – Invalid information element contents

This cause is returned when the equipment sending this cause has received an information element that it has implemented; however one or more fields of the information element are coded in such a way (e.g., truncated, invalid extension bit, invalid field values, etc) that has not been implemented by the equipment sending this cause.

Cause No. 101 – Message not compatible with call state/Protocol error threshold

This cause is returned when the equipment sending this cause has received a message that procedures indicate is not a permissible message to receive at this time.

or

This cause indicates that the switch sending this cause is clearing the call because a threshold has been exceeded for multiple protocol errors during an active call.

Cause No. 102 - Timeout disconnect (Recovery on timer expiration)

This cause indicates that a procedure has been initiated by the expiry of a timer in association with error handling procedures.

Cause No. 111 – Protocol Error, unspecified

This cause is used to report a protocol error event only when no other cause in this class applies.

Among other things, this cause may be displayed if you failed to dial a “9” or “8” for an outside line, if required. Also may be returned if you have some types of restrictions as to the number of calls, etc.

CLASS 1.7 (Interworking class)

Cause No. 127 - SW56 disconnect (Internetworking, unspecified)

This cause indicates that an interworking call (usually a call to SW56 service) has ended. May also be seen in the case of a non specific rejection by your long distance carrier (try again at a different rate or with a different carrier)



USER'S MANUAL

Appendix 4: Known Working SPID Formats by Telco

SPIDs are only used in the USA & Canada. Your SPIDs may be different! Note, for each line there is only one configuration that will work. Your SPID is distinct from your telephone number, and does not necessarily contain your area code or telephone number (although this is generally the case).

A standardized SPID format for National ISDN of XXXYYYZZZZ0101 was phased in during 1996 and is used by most of the Telcos for new lines. Incorrect SPIDs will be indicated by a line status of "Wait" on the ISDN status screen.

Certain Telcos will leave the last "00" or "01" off the end of your SPID when giving it to you. For the latest list check Telos Systems' web page. Additional SPIDs can be found at INTEL's SPID Page: http://support.intel.com/support/isdn/SPID_Tip.htm .

XXX=Area code; YYY=NXX exchange; ZZZZ=phone number

Alltel (Ohio)

XXXYYYZZZZ0101

Ameritech

XXXYYYZZZZ0111

Or,

XXXYYYZZZZ011

Or,

01YYYZZZZ011

Or,

XXXYYYZZZZ01

Bell Atlantic

01YYYZZZZ00

Or,

01YYYZZZZ000

Or,

01XXXYYYZZZZ000

Or

XXXYYYZZZZ100

Bell Atlantic North (former NYNEX)

XXXYYYZZZZ0101

Or,

XXXYYYZZZZ0000

Bell Canada

XXXYYYZZZZ00

Or,

XXXYYYZZZZ0101

BellSouth

XXXYYYZZZZ0101

Or,

XXXYYYZZZZ0100

Or,

XXXYYYZZZZ01

Or,

01YYYZZZZ0

Or,

01YYYZZZZ000

Century Telephone

XXXYYYZZZZ00

Cincinnati Bell

01YYYYZZZZ000

Or,

SPID1 00YYYYZZZZ01

SPID2 00YYYYZZZZ02

Or,

00YYYYZZZZ01

Fort Mills Telephone

XXXYYYYZZZZ

Frontier Communications

01YYYYZZZZ000

GCI (Alaska)

XXXYYYYZZZZ00

GTE

XXXYYYYZZZZ0101

Or,

XXXYYYYZZZZ0001

Or

01YYYYZZZZ000

Or

XXXYYYYZZZZ00

Or

01YYYYZZZZ0

Or,

XXXYYYYZZZZ

Or

SPID1 XXXYYYYZZZZ00

SPID2 XXXYYYYZZZZ01

Or

SPID1 XXXYYYYZZZZ0000

SPID2 XXXYYYYZZZZ0001

Or

SPID1 XXXYYYYZZZZ0000

SPID2 XXXYYYYZZZZ0101

Nextlink/XO

XXXYYYYZZZZ

Or

XXXYYYYZZZZ1

Or,

XXXYYYYZZZZ0101 (if requested)

Northern Pittsburgh Telephone

XXXYYYYZZZZ000

Pacific Bell

XXXYYYYZZZZ0101

Or,

SPID1 XXXYYYYZZZZ01

SPID2 XXXYYYYZZZZ02

Or,

01YYYYZZZZ000

Or,

SPID1 XXXYYYYZZZZ1

SPID2 XXXYYYYZZZZ2

Or,

XXXYYYYZZZZ00

Or

XXXYYYYZZZZ

Quest - See US West

Rochester Telephone

01YYYYZZZZ0

SBC- See Pac Bell, Ameritech, SNET or Southwestern Bell

SNET (Southern New England Telephone)

01YYYYZZZZ00

Or,

01YYYYZZZZ000

Or,

XXXYYYYZZZZ0101

Southwestern Bell

XXXYYYYZZZZ0101

Or

XXXYYYYZZZZ

Or

01YYYYZZZZ000

Or

01YYYYZZZZ00

Or

XXXYYYYZZZZ01

Sprint/Centel

XXXYYYYZZZZ100

Or,

XXXYYYYZZZZ0000

Or,

SPID1 XXXYYYYZZZZ000

SPID2 XXXYYYYZZZZ100

Standard Telephone (GA)

SPID1 XXXYYYABCDCD

SPID2 XXXYYYEFGHGH (last two digits of
phone number repeated)

Verizon- See Bell Atlantic, Bell Atlantic North,
or GTE

Verizon West- See GTE

Vermont Telephone

XXXYYYYZZZZ0101

US West

XXXYYYYZZZZ1111

Or

01YYYYZZZZ00

Or

01YYYYZZZZ000



USER'S MANUAL

Appendix 5: Suggested Reading and References

ISDN

ISDN – A Practical Guide to Getting Up and Running; William A. Flanagan; Flatiron Publishing, Telecom Books, New York, 1996; www.telecombooks.com . Lots of nitty gritty deep technical information.

ISDN for Dummies; David Angell; IDG Books, Foster City, CA; 1995. Good practical information.

The ISDN Literacy Book; Gerald Hopkins; Addison Wesley, Reading PA, 1994. Lots of details on how ISDN came to be, how standards are written, etc.

Telephony

The Telephony Book – Understanding Telephone Systems & Services; Jane Laino; Telecom books, a division of Miller Freeman, USA, 1999; www.telecombooks.com . This book is a general introduction however it is a good starting point for those new to Telephony.

ABC of The Telephone –Anatomy of Telecommunications; ABC Teletraining; www.abcteletraining.com . A great introduction to all aspects of Telephony.

National Association of Broadcasters Engineering Handbook (10th Edition); National Association of Broadcasters, Washington, 2005; www.nab.org . Chapter 3.10 is written by our founder, Steve Church and contain a lot of new material. It will be available on the Tech Talk section of our website at: <http://telos-systems.com/>

Newton's Telecom Dictionary (21st Edition and counting) Harry Newton; Telecom books, New York; www.telecombooks.com . This book is more of an Encyclopedia than a dictionary. It is well worth the space on your bookshelf.

Understanding Telephone Electronics, Fourth Edition; Stephen J. Bigelow, Joseph J. Carr, and Steve Winder; Newnes, Boston, 2001. A somewhat more technical introduction to telephony. Focuses on POTS lines and terminals, but also covers digital theory and transmission.

Wiring (Network and Telephone)

Mike's Basic Guide to Cabling Computer's and Telephones; Mike Gorman; Prairie Wind Communications, Inc, 1997. This book is destined to be a classic. Its down to earth practical style, copious illustrations, and practical information covers all bases.

Technician's Handbook to Communications Wiring; Jim Abruzzino; CNC Press, Chantilly VT, 1999. This small book is concise, yet contains a lot of great information including proper technique for working with Cat. 5 cable and connectors.

The Axia Guide to Choosing Category Cable; Stephen Lampen, Belden Electronics. Available for download at: <http://www.axiaaudio.com/tech/cable/default.htm>

IP and Livewire

Introduction to Livewire – an Axia Audio publication. Available for download at:

<http://www.axiaaudio.com/manuals/files/IntroToLivewire2.1.pdf>

Practical IP and Telecom for Broadcast Engineering and Operations; Fred Huffman A title in the Focal Press Media Technology Professional Series (2004)

<http://www.elsevierdirect.com/product.jsp?isbn=9780240805894>

Other

Murphy's Law and Other Reasons Why Things Go Wrong!; Arthur Block; Price/Stern/Sloan Los Angeles; 1977. Essential for keeping proper perspective while troubleshooting.

The Dilbert Future-Thriving on Stupidity in the 21st Century; Scott Adams; Harper Business. New York; 1997. This book provides interesting perspective on ISDN.

Appendix 6: Streaming and Special Operational Modes

The Zephyr Xstream offers several special modes that, when selected, change its functionality, as well as its "personality".

Ethernet (IP) modes allows transmission and reception of audio streams over IP networks. Ideal for casual monitoring, or audio distribution over specially managed IP networks. Operation over xDSL or other IP based networks is possible in this mode. Error concealment is provided in AAC mode.

V.35 *Single* mode allows high-bitrate operation over synchronous data transport mechanisms including T1 (E1) and fractional T1 (E1).

We have deliberately separated these two modes as the correct settings for these applications (Internet streaming versus real time audio transmission over ISDN versus high-speed synchronous data channels) are different, and we thought that it would add unnecessary confusion to list all options when a number would not be useful for a given situation.

ETHERNET MODES

The Zephyr Xstream's *Ethernet* mode is used to generate streaming MP3 or AAC feeds. The Xstream supports Unicast operation only, however depending on the bitrate, multiple streams are permitted.

This mode is selected by changing the *Interface* selection in the third *TEL* menu to *Ethernet(SIP)*, or *Ethernet (RTP)*. Making this change will change the options for the *CODEC* menu. The *Dial* screen and first *TEL* screen will also change, showing status of the Streaming IP connections.

THE CODEC MENU IN ETHERNET MODE

The Codec menus will be different from those shown elsewhere in this manual when the *Interface* selection (in the 3rd *TEL* menu) has been set to *Ethernet*.

CODEC- Screen 1 (Status)

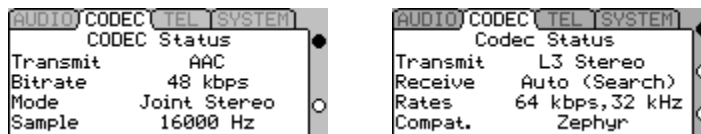

This screen shows the encoding algorithm, bit rate, mode (mono or stereo) and sample rate currently being used for encoding. These items will be optimized for the bit rate selected (see below)

CODEC – Screen 2



Transmit

The *Transmit* setting determines what standard (i.e. Algorithm) is used to encode the audio to be sent to the far end. Each mode offers distinct advantages and disadvantages (see section 6.2 for additional information), as follows:

AAC – THE MPEG AAC algorithm will be used

L3 – THE MPEG Layer 3 algorithm will be used

Bitrate

This allows selection of the desired bit rate for the streaming audio. The higher the bitrate, the better the fidelity. However, higher bitrates use up more bandwidth thereby increasing your transmission cost. See below.

On the other hand, the QOS (quality of service) of the IP network is less critical the lower the bit rate used.

Disconnect all clients

This allows you to terminate the connections to Xstreams (or other players) currently listening to the stream generated by the local Xstream

THE TEL MENU IN ETHERNET MODE

TEL - Screen 1 (Status)



This screen shows the number of client players (software players or Zephyr Xstreams) currently connected to the stream generated by this Xstream. This information is valuable as dropouts are more likely the greater the number of connected clients

The remaining *TEL* screens are identical in Ethernet mode as in ISDN or V.35 mode.

INTERNET BANDWIDTH REQUIREMENTS

The Xstream can serve a limited number of streams without a replication server. The following table indicates the allowable number of streams:

Bit Rate (per stream)	8	12	14	16	18	20	24	32	40	48	56	64	80	96	112	128
Allowable Streams	15	15	14	14	14	13	13	13	11	10	9	7	6	5	3	2

The formula for estimating the required bandwidth requirement is:

Required Bandwidth = Number of Unicast Listeners x (encoded audio stream bitrate x 1.1)

The following table shows estimated numbers of listeners for each Internet connection style, assuming a 16Kbps encoded audio bitstream rate (this does not imply this number streams are supported by the Xstream, however):

Connection Type	Bandwidth	Listeners
ISDN Basic Rate	128Kbps	8
T1	1.5Mbps	90
Ethernet LAN (10Mbit)	7 Mbps (10Mbps x .7)	350
T3	45 Mbps	2,700
Ethernet (100Mbit)	70 Mbps (100Mbps x .7)	4,000

Of course, you may not wish to allocate all of your available bandwidth to audio streaming.

STREAMING DEFINITIONS

Pull Only

The connection in this type of stream is initiated by the listener (client). The client contacts the sender (server), requesting a stream to be sent. The server sends a stream to the client, and the client sends no further messages to the server until the user disconnects. At disconnect time, the client sends a message to the server requesting that no more data be sent.

Push Only

The audio stream, in this instance, is initiated by the sender. The user specifies the client to which to send the stream, and the data is sent without any negotiation. The client decodes the audio it is sent, but has no control over when it starts or stops. The stream must be disconnected by the send-side user.

Bi-directional

Uses some combination of the above to initiate a stream in both directions. The user at either end can initiate the connection, and the software will negotiate both the push and the pull involved. Either end's user can likewise disconnect the call.

STREAMING MODES

Depending on the *Interface* selected in the TEL menu, the Xstreams streaming works differently. Here is a review of the different options:

HTTP

The familiar *Pull-Only* HTTP remains, however we strongly recommend the use of one of the following RTP based options. The Zephyr is still a server only, not a client. HTTP streaming is used primarily with desktop players (Audioactive Player, WinAmp, etc.) for confidence audio. It is not to be used on the public internet due to limitations in the Zephyr's TCP stack. If long-range/long-term HTTP streaming is required, a Shoutcast Server (or other stream replicator) can be used as a client.

RTP/UDP

Real-Time Protocol streams are *Push-only*. One server can send to several clients, who decode the audio if they are also in RTP streaming mode. RTP is a transport protocol, not a connection protocol, which is why it works in this way. The "connection protocol" is the user hitting the Dial button.

SIP

Unlike RTP, SIP is a connection protocol, not a transport protocol. SIP negotiates a bi-directional connection between the two units, behaving much like a telephone or ISDN call. Progress is related to the far side as well as the local user. The far end unit may be reported as busy (unlike RTP, which sends regardless of the readiness of the receiver), etc.

SIP uses RTP as its transport protocol. What this means, basically, is that SIP negotiates for each side of the connection to send an RTP, push-only stream to the other side. The result is a bi-directional connection.

PORTS (IP PORT)

Each IP device must have an IP address. However, each IP address can handle multiple connections, using different ports. Sort of like different extensions on the same office telephone system.

IP ports to be used by the streaming system are listed on the Telco configuration page in all modes.

Streaming Ports ?		
SIP Port	<input type="text" value="5060"/>	<input type="button" value="Apply"/>
UDP Port	<input type="text" value="9150"/>	<input type="button" value="Apply"/>
HTTP Port	<input type="text" value="8080"/>	<input type="button" value="Apply"/>
TCP Port	<input type="text" value="8800"/>	<input type="button" value="Apply"/>

SIP Port (Default 5060)

SIP uses a TCP port, as its communication is bidirectional. The SIP port is what is used for the connection protocol, that layer that initiates the two RTP streams. The SIP port must match on both ends of a connection.

UDP Port (Default 9150)

RTP streams are sent and received over the UDP port. This port is used for both RTP and SIP modes, as SIP negotiates the creation of RTP streams. The UDP port must match on both ends of a connection.

HTTP Port (Default 8080)

The TCP port used for HTTP streaming only (normal web-pages are also served over HTTP, but these are sent over port 80, the usual port to which a web browser connects). A player which supports HTTP streams can connect using the usual port notation (e.g. `http://www.xxx.yyy.zzz:PORT`).

Note that prior to 3.0.1p, the Zephyr Xstream used port 8000 for HTTP streaming.

TCP Port (Default 8800) This port is currently unused.

FIREWALLS AND ROUTERS

The Internet works because there is a central authority for doling out IP addresses. Any given connection to the internet is permitted to use some number of designated addresses which can be accessed by any machine that is also connected to the Internet. Most connections are limited to one IP, with many more machines needing access to the network. This is the basic purpose most routers.

When a device, such as the Xstream has a "public" (e.g. real) IP address it can be directly accessed through a router. However, if there is a firewall (which may be built into the router, or a separate box), or a "private" IP address the unit is not directly accessible. In these cases there are a few options, as outlined below.

Port Forwarding

Port forwarding is very simple. When you have two connected networks, with different numbering schemes, they must be connected by a router. The machines on either side of the router cannot access each other. The router itself can be accessed by machines on either network, however.

Port forwarding is basically telling the router that when it receives packets from the Wide Area Network on a given port, from those packets should be forwarded transparently to the specified address on the Local Area Network.

NAT (Network Address Translation)

This is a scheme by which a private network can make connections into a public network (such as the Internet) using only one address on the public net. An example is having 3 computers behind a router/firewall on a residential DSL line. The three computers have separate addresses on the local network, but only the Router's WAN IP is visible on the outer network.

NAT works because the router knows the format of TCP/IP packets. It can substitute its own IP into the packets that are outbound, then reinsert the proper LAN IP when a packet comes inbound from the WAN. This works because TCP is connection-based, so the router knows that all traffic on a given connection is destined for the machine that initiated it.

THE ZEPHYR XSTREAM BEHIND A FIREWALL

In our world, we will always have a studio codec and a remote codec so there are always two Xstreams to consider. For this discussion, we'll assume that the remote Zephyr Xstream is properly configured already. That way, we only need to discuss the considerations for the local machine. If each operator does this, both codecs will end up being configured properly.

To begin, for all of the scenarios presented below, the following procedure should be followed:

- Give the Zephyr a fixed IP address on the LAN. Usually, this is done by simply picking an unused address.
- Set the LAN subnet mask (usually 255.255.255.0 - get these numbers from the IT administrator)
- Set the gateway to the LAN address of the router
- Set the DNS to the server specified in the WAN/DHCP area of the router's information pages (optional).

HTTP Mode Not recommended for use over the public network. If it's behind a router, it really shouldn't be used.

RTP Mode

Sending

After configuring the Xstream as above, there are no special settings required to send an RTP stream only. Take the IP address given to you by the person you're calling. Press Dial. Enter the IP address. Press Dial again.

Contact the operator on some other channel to confirm receipt of the stream, as there is no reverse communication

Receiving

To receive an RTP stream from behind a firewall, you first need to set that firewall for port forwarding. On the router setting page, forward UDP port 9150 to the IP address the receiving Xstream. Contact the remote operator, and provide the WAN address of the router (retrieved from the router status page or IT admin). When the remote operator sends a stream to your machine, the router will automatically forward it to your Xstream. Note that you can only forward a port to one IP at a time, so if you are behind a firewall and you need to receive multiple streams, you'll have to forward other ports and have the remote admin change their UDP port to match yours.

SIP Mode

Since SIP mode is bidirectional, we'll discuss Dialing and Answering, rather than Sending and Receiving.

Answering

After configuring your Xstream, you'll need forward TCP port 5060 to the Xstream you wish to use. When this is done, follow the instructions for RTP Mode (Receiving) - forward UDP 9150 to the Xstream and give the remote operator the router's WAN address.

Dialing

Configure your Xstream as with SIP Mode (Answering). With your unit in Ethernet (SIP) mode, go to Codec(3) – Ethernet Settings. The field "RouterIP" (Renamed in current development build as "WAN IP") should be set to the router's WAN address, as shown on the router's status page. SIP includes IP information in its own protocol, above the TCP/IP layer, which cannot be automatically changed by the NAT router. If there is no router, or the Xstream is on a publicly-available IP address, the WAN IP should be set to 0.0.0.0.

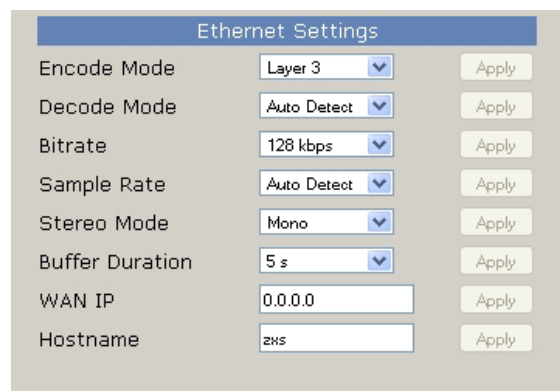

Ethernet Settings		
Encode Mode	Layer 3	Apply
Decode Mode	Auto Detect	Apply
Bitrate	128 kbps	Apply
Sample Rate	Auto Detect	Apply
Stereo Mode	Mono	Apply
Buffer Duration	5 s	Apply
WAN IP	0.0.0.0	Apply
Hostname	zxs	Apply

TRANSMITTING AN MPEG Layer 3 or AAC STREAM

Changing the Interface selection in the 3rd *TEL* menu to *Ethernet* will automatically start a stream. The bit rate and Transmit (coding mode) for that stream are determined in the *CODEC* menu (see above). The party(ies) connecting to this stream will need your IP address to connect to it.

RECEIVING IN ETHERNET MODE – The DIAL Menu

Connecting to a Stream from another Xstream

1. Press <*DIAL*>
2. Enter the IP address of the desired stream (use the <*> or <#> key of the "." character).
3. Press <*DIAL*> again

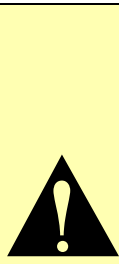

IMPORTANT TIP!

The system will automatically determine the coding mode and bit rate automatically.



HOT TIP!

IP addresses do not include leading Zeros If you are connecting to an IP address given to you as 012.345.000.789 the correct IP address would be 12.345.0.789

In SIP mode this will establish a two-way audio connection. In the case of RTP mode, "dialing" in this manner allows you to receive from that site. If they wish to receive your audio, they would need to "dial" you. Of course, they could receive from some other site simultaneously sending to your site. Multiple sites may connect simultaneously.

V.35 SINGLE Mode (high speed V.35/X.21 synchronous operation)

The menus and operation of the Xstream when using the *V.35 Split* setting of the *Interface* selection in the third *TEL* menu are identical to those for *ISDN* option for that parameter. This is documented in the main body of this manual.

When *V.35 Single* mode is set for *Interface* selection in the third *TEL* menu, certain menus change. We will document those settings here.

The *V.35 Single* mode is appropriate for situations where a single synchronous network connection at 96, 112, 128, 256, or 368kbps is available via a V.35 or X.21 interface.



HOT TIP!

Layer 3 offers operation at 112, 128, and 256 kbps only. This is because at 384 kbps Layer 2 or AAC is preferred over Layer 3.

96 kbps operation is offered only in AAC.

CODEC MENU in *V.35 Single* mode

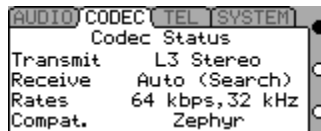

Transmit:

The *Transmit* setting determines what standard (i.e. Algorithm) is used to encode the audio to be sent to the far end. Identical audio streams will be output from both V.35/X.21 port. Each mode offers distinct advantages and disadvantages (see section 6.2 for additional information), as follows:

L3 Stereo and L3 J-Stereo

L3 Stereo is appropriate for situations where the audio transmitted will be subject to playback over Surround Sound systems (i.e. mostly for Television). In most other scenarios J-Stereo is preferred.

Offers 15 kHz audio frequency response if the *Sample Rate* is set to 32, or 20 kHz audio frequency response if the *Sample Rate* is set to 48 kHz.

L3 Mono

This encodes a single mono bitstream using a single audio input (the audio on channel A).

L3 mono offers 15 kHz audio frequency response if the *Sample Rate* is set to 32 or 20 kHz audio frequency response if the *Sample Rate* is set to 48 kHz.



HOT TIP!

*If you wish to feed a mix of the audio on channels A and B, you can do so by setting up the send mixer section (MX/MXP models) appropriately, or by setting the **Send Mix** option to "A + B" in the **AUDIO** menu (non-mixer model).*

AAC-LD Stereo

AAC-LD Joint

These work similarly to the equivalent Layer-3 modes (see above). These (and the other AAC-LD modes) modes are important since they offer significantly lower delay than any mode other than G.722.

Offers 14 kHz audio frequency response.

AAC-LD Mono

This encodes a single mono bitstream using a single audio input. Encodes the audio on channel A. Offers 16 kHz audio frequency response.

AAC Stereo

AAC J-Stereo

These work similarly to the equivalent Layer-3 modes (see above).

Offers 15 kHz audio frequency response, when the sample rate is set to 32 kHz and 20 kHz response when the sample rate is set to 48 kHz.

AAC Mono

This encodes a single mono bitstream using a single audio input. Encodes the audio on channel A. Offers 15 kHz audio frequency response when the sample rate is set to 32 kHz and 20 kHz response when the sample rate is set to 48 kHz.

L2 Stereo

L2 Joint

These work similarly to the equivalent Layer-3 modes.

Offers 20 kHz audio frequency response when the sample rate is 48 kHz and 15 kHz response when the sample rate is set to 32 kHz.

L2 Mono 128

This mode is very common mode used in the voice-over industry. It works in the same way as the other Mono 128 modes.

Offers 19 kHz audio frequency response when the sample rate is set to 48 kHz and 15 kHz response when the sample rate set to 32 kHz.

Receive:

The appropriate *Receive* mode will be determined by the encoding or *Transmit* mode used at the far end.

The Xstream's *Receive* modes in *V.35 Single* mode are:

L3

Receives all Layer-3 modes available in *V.35 Single* mode.

L2

Receives all Layer-2 modes available in *V.35 Single* mode.

AAC-LD

Receives all AAC-LD modes available in *V.35 Single* mode.

AAC

Receives all AAC modes available in *V.35 Single* mode.

BIT RATE

This determines the bit rate of the V.35 ports as well as the encoder and decoder. In *V.35 Single* mode the following rates are available: 96, 112, 128, 256, 384 kbps. Not all Bit Rates are supported in all algorithms.

SAMPLE RATE

This determines the sample rate used for the codec operation. Not all sample rates are supported at all bit rates. The following table summarizes the allowable sample rate and bit rate combinations supported in *Single V.35* mode.

ALGORITHM	BIT RATE (kbps)				
	96	112	128	256	384
AAC Stereo	32 kHz	32 kHz	32 kHz	32 kHz	32 kHz
	48 kHz	48 kHz	48 kHz	48 kHz	48 kHz
AAC Mono	32 kHz	32 kHz	32 kHz	48 kHz	Not Supported
	48 kHz	48 kHz	48 kHz		
AAC-LD Stereo	32 kHz	32 kHz	32 kHz	32 kHz	32 kHz
	48 kHz	48 kHz	48 kHz	48 kHz	48 kHz
AAC-LD Mono	32 kHz	32 kHz	32 kHz	48 kHz	Not Supported
	48 kHz	48 kHz	48 kHz		
Layer 2 Stereo	Not Supported	32 kHz	32 kHz	32 kHz	48 kHz
		48 kHz	48 kHz	48 kHz	
Layer 2 Mono	32 kHz	32 kHz	32 kHz	48 kHz	Not Supported
	48 kHz	48 kHz	48 kHz		
Layer 3 Stereo	32 kHz	32 kHz	32 kHz	32 kHz	Not Supported
	48 kHz	48 kHz	48 kHz	48 kHz	
Layer 3 Mono	32 kHz	32 kHz	32 kHz	48 kHz	Not Supported
	48 kHz	48 kHz	48 kHz		

CURIOSITY NOTE!

The MPEG standards do not define all possible combinations of sample rate and bit rate at 284 kbps and 384 kbps for each of the algorithms.

Since Layer 3 is intended for low bits rates, they did not propose that it be used at 384 kbps.

Similarly, at the higher bit rates the absence of coding artifacts makes 48 kHz operation possible without artifacts and hence the 32 kHz sample rates are not supported for mono.



Appendix 7: Ordering ISDN for ETS 300 (Euro ISDN)

This section applies to users in Europe and other countries where the Euro-ISDN ETS 300 standard is supported (Europe, much of South America, Australia, South Africa, Mexico, etc). Since there are virtually no options when ordering Euro ISDN, this section is probably not needed, however we thought we could help by summarizing what you will require.

If you live in a country outside of North America that does not support Euro-ISDN, your local Telos Systems representative should be able to provide you with information about ordering (and using) ISDN in your area. We assume you have read the description of ISDN in Section 7 (ISDN Basics) and are familiar with ISDN's basic concepts. If you have not read that section, doing so now will help you to better understand the information that follows.

On one ISDN BRI circuit, there are three simultaneous bi-directional channels: two 64kbps "bearer" or "B" channels for the transmission of user information and one 16kbps "data" or "D" channel for call set-up and status communication. That is why this is sometimes called 2B+D service. You can use the B channels, but only the phone companies and equipment manufacturers can usually use the D channel.

From the perspective of telephone network routing, each channel appears to be a separate line with its own number and independent dial-out capabilities. Since each has to be dialed or answered separately, they appear to be "lines" to users also. We refer to a B channel as a "line" on the Zephyr Xstream's menu.

ISDN comes into your facility on two wires, just like plain old telephone service (POTS). There the Telecom will install a NT1 (Network Termination) to provide you access to the S (4-wire) interface usually provided. You will be connecting this to the Zephyr Xstream's top (8-pin) jack.

Details, Details

In order to communicate accurately what it is you need, we think you should be familiar with the vocabulary used to describe ISDN. As with anything, for best results, it helps to know what you are talking about. For an in-depth glossary of terminology please check Appendix 9 or the Telos web site at <http://www.telos-systems.com> .

Names

We've seen Basic Rate Interface ISDN called by a number of names. The term "SØ" is sometimes used as a technical term for ISDN BRI. Of course, the term "BRI" is also used, mostly by Telecom technicians. The most common term we've seen in Europe is "ISDN-2".

Multiple Subscriber Numbers (MSN)

These are simply your phone numbers. The number of digits will vary depending on your area. Normally each ISDN BRI circuit will have three MSNs. MSNs are optional, and do not need to be entered in the Telos Equipment.

CSD and CSV

Recall that each ISDN BRI has two possible B channels. It is possible to order a line with one or both of the B channels enabled – and each may be used for voice and/or data use. Phone terminology for the class of service is CSV for Circuit Switched Voice connections and CSD for Circuit Switched Data connections. (In contrast to PSD, Packet Switched Data, this is possible, but irrelevant to our needs.)

CSD is used for codec connections. Even though you may be sending voice, the codec's output will be in data form and therefore must be handled transparently by the telephone network. This happens because the Zephyr Xstream indicates that this is a CSD call (over the D channel) when the call is set up.

CSV is for interworking with voice telephone service, and allows ISDN to interwork with analog phone lines and phones at the far end. CSV is *required* when communicating to a Zephyr Xport that is on a POTS line.

You will be ordering one or more ISDN BRI 2B+D circuits with CSD (required) and CSV on each B channel. Euro ISDN normally provides both CSV and CSD.

NT1s

The ISDN standard specifies two reference points, the "U" and the "S" interfaces. The U is the single-pair (2-wire) bare copper from the Telco CO. A device called a "Network Termination, Type 1" converts this to the two-pair (4-wire) S interface. The Zephyr Xstream includes a built-in NT1. This is for use in the USA & Canada. You should not connect to the U interface in other countries without first consulting the Telco. They may have regulations against doing so, and they will probably provide power for remote powering an NT1, and this power could damage your Zephyr Xstream's ISDN interface.

The older Zephyr classic units sold outside the USA may only have an S interface. If you plan on taking those units to Canada or North America you will need to rent or purchase an external NT1 for use while in those countries. One rental source is Silver Lake. See their website at www.silverlakeaudio.com.

PP vs PMP

The S interface allows for multiple terminals to be connected simultaneously. This is called Point to Multi-Point (PMP) operation. When a single terminal is used this is referred to as a Point to Point configuration (PP).

The Xstream can be used in either environment. If you intend to have other terminals share the S interface with the Xstream, you should make sure your Telco configures their switch properly to support this (PMP). You will also need to follow the correct termination rules if you will have multiple terminals.

Line Deactivation

The Euro ISDN standard allows ISDN BRI lines to be deactivated by the Telecom when not in use. It is impossible to distinguish a deactivated line from a line that is defective and out of service,

until a call attempt is made. If your application is critical, you may wish to request that the Telecom disable line deactivation.

FAXABLE ISDN ORDER FORMS FOR ETS 300

Following form may be used to place orders for ISDN lines in countries using the ETS 300 protocol. These should give the Telecom all of the information they need.

Complete the top portion of the form and send it to the Telco.



ISDN BRI LINE ORDERING INFORMATION
ETS 300 (not for use in USA & Canada)
Telos Zephyr Xstream

To: Telecom _____

Attention: _____

From: _____ Location for line: _____

Company: _____ Company: _____

Address: _____ Address: _____

City/Postal Code: _____ City/Postal Code: _____

Phone: _____ Phone: _____

Contact: _____ Contact: _____

Long distance carrier: _____

Date needed: _____ Termination date: _____

We request an ISDN Basic Rate Interface (ISDN-2, BRI, SØ) circuit for use with the Telos Zephyr Xstream digital audio transmission system. This device interfaces audio equipment to digital telephone services. It *requires* Circuit Switched Data (CSD). We may also use this to makes calls using Circuit Switched Voice (CSV) service. Therefore please provide alternate CSD/CSV on both B channels. Please advise the customer if there is an added cost for CSV.

Zephyr Xstream has an integral BRI terminal adapter, which supports the ETS 300 protocol. It can be used in a Point-to-Point (PP) or Point-to-Multipoint (PMP) configuration. Unless otherwise requested please provide for MP operation.

Modular Jack: We require a standard "S" (4-wire) interface on a *standard, eight-pin/4-conductor miniature modular jack (RJ-45 style)*, of which only the center four conductors will be used, as follows:

<u>Pin</u>	<u>Description</u>	<u>Pin</u>	<u>Description</u>
1	Not Used	5	Rcv (Net to TE) -
2	Not Used	6	Xmt (TE to Net) -
3	Xmt (TE to Net) +	7	Not Used
4	Rcv (Net to TE) +	8	Not Used

Line Deactivation (please provide the option specified below):

- o Line deactivation is acceptable. Please provide your default setting for this parameter.
- o We would prefer to know if lines are working at all times. Therefore, we request that you set the parameter "Deactivation Allow" to "NO" if this is possible.
- o Our application is critical and we need to monitor that lines are working at all times. Please set the switch parameter "Deactivation Allow" to "NO".

You may call the manufacturer of the Zephyr Xstream, Telos Systems, in the United States of America, at 216 241-7225 for any additional required information about ISDN compatibility. Ask for Telos Zephyr Xstream Customer Support.

Appendix 8: Ordering ISDN for the USA & Canada

This section applies to users in Canada & USA and is intended to help you when it comes time to order your ISDN lines. We assume you have read the description of ISDN in section 7 (ISDN Basics) and are familiar with ISDN's basic concepts. If you have not read that section, doing so now will help you to better understand the information that follows.

Because ISDN in the USA is complex, there is occasionally confusion about what it is and how to get it. If you know who to call and provide them with complete information, the ISDN ordering process can be simple and straightforward. This guide takes you through the process step-by-step. Telos Technical Support is available to answer any further questions you may have. Don't take "no" for an answer if your Telco does not understand your needs.

On one ISDN BRI circuit, there are three simultaneous bi-directional channels: two 64kbps "bearer" or "B" channels for the transmission of user information and one 16kbps "data" or "D" channel for call set-up and status communication. That is why this is sometimes called 2B+D service. You can use the B channels, but only the phone companies and equipment manufacturers can usually use the D channel. ISDN comes into your facility on two wires, just like plain old telephone service (POTS).

From the perspective of telephone network routing, each channel appears to be a separate line with its own number and independent dial-out capabilities. Since each has to be dialed or answered separately, they appear to be "lines" to users also. We refer to a B channel as a "line" on the Zephyr Xstream's menu.

The Zephyr Xstream's internal ISDN interface (sometimes called by its generic name "Terminal Adapter") is used to connect to digital ISDN telephone circuits. It easily adapts to the various types of service offered by the range of Central Office (CO) switches installed by telephone companies in the USA and Canada.

Ordering ISDN

Dealing with the Phone Company

As is often the case when broadcasters interface with phone people, the lines of communication on ISDN can get a little tangled.

The first order of business is to find someone who knows what ISDN is. While your usual account agent will be the normal entry point, you might be talking to several people before you find one who understands your needs.

Some of the regional Bell companies offer a single point of contact number for switched digital services, while some Telcos use "resellers". Note that in some cases the phone company will need to do a "loop qualification" (line loss test) before they can verify that ISDN will be available at your location.

Here are some contact numbers we use – if you have particularly positive or negative experiences with these offices, please let us know.

COMPANY	TELEPHONE NUMBER	WORLDWIDE WEB
<u>Ameritech</u>	800-TEAMDATA (800-832-6328)	www.ameritech.com
<u>Bell Atlantic</u>	800-570-ISDN (800-570-4736) (see below for former NYNEX regions) Residential 800-204-7332	www.ba.com
<u>Bell Atlantic North</u>	Call your account representative. If you do not know who s/he is, call; (former NYNEX) 800-GET-ISDN (800-438-4736)	www.nynex.com
<u>Bell South</u>	615-401-4347 (Lorilynn Smith)	www.bell.bellsouth.com
<u>Cincinnati Bell</u>	513-566-DATA (513-566-3282)	
<u>GTE</u>	800-GTE-4WCN (800-483-4926)	www.gte.com
<u>Natco</u>	800-775-6682 ext 288	www.natconet.com
<u>Nevada Bell</u>	Small Business 702-333-4811 Large business 702-688-7100	
<u>Pacific Bell</u>	800-4PB-ISDN (800-472-4736)	www.pacbell.com
<u>Rochester Tel</u>	716-777-4501 or 1234	
<u>SBC</u>	See Ameritech, Pac Bell, Nevada Bell, SNET, or Southwestern Bell	
<u>SNET</u>	800-430-4736	www.ntplx.net
<u>Stentor (Canada)</u>	800-578-4736 (Fax server, document 200 has a list of local numbers) For questions or assistance, call 403-945-8130	
<u>Southwestern Bell</u>	800-SWB-ISDN (800-792-4736)	www.sbc.com
<u>US West</u>	800-728-4949 (Fax server) small business 800-246-5226 For questions or assistance 206-447-4029	www.uswest.com
<u>Verizon</u>	See GTE, Bell Atlantic or Bell Atlantic North	

Details, Details

In order to communicate accurately what it is you need, we think you should be familiar with the vocabulary used to describe ISDN. As with anything, for best results, it helps to know what you are talking about. For an in-depth glossary of terminology please check Appendix 10 (Glossary) or Telos' web site at <http://www.telos-systems.com> .

Protocols

In a perfect world, all ISDN terminal equipment would work with all ISDN lines, without regard for such arcana as 5ESS, DMS100, CSV/CSD, SPIDs, etc. The USA ISDN "standard" had been evolving for several years. The good news is that it has now settled down, with most new installations using National ISDN-1 or National ISDN-2 (see below).

At their central offices, the telephone companies use AT&T/LUCENT 5ESS, Northern Telecom DMS100, or Siemens EWSD switching equipment. While each will work with the Zephyr Xstream, there are some differences, which need to be taken into account when lines are ordered and used. Each has a "protocol" – the language the user equipment and the telephone network use to converse (on the D channel) for setting up calls and the like.

There are standard protocols that all switches may provide, called National ISDN-1 (NI-1) and National ISDN-2 (NI-2). These protocols were standardized and specified by Bellcore, the technical lab jointly owned by the phone companies. However, both AT&T and Northern Telecom had versions of ISDN which predated the NI-1 standard and a few switches may not been upgraded to the new format. In that case you would need to use one of the older "custom" protocols.

There is also a newer NI-2 standard, but it is designed to be compatible with NI-1 for all of the basic functions and therefore is acceptable to device such as the Zephyr that use NI-1.

SPIDs

Service Profile Identification (SPID) numbers are required in all but one of the AT&T protocols. These numbers are given to the user by the phone company and *must be entered correctly* into the Zephyr Xstream in order for the connection to function. SPIDs usually consist of the phone number plus a few prefix or suffix digits (it may or may not include the area code). There is frequent confusion between phone numbers and SPIDs, even among Telco personnel. While the SPID frequently includes the corresponding phone number, this is not necessarily the case.

The intention of the SPID is to allow the Telco equipment to automatically adapt to various user requirements, by sensing different SPIDs from each type or configuration of user terminal. None of this matters with our application, but we must enter the SPIDs nevertheless. BellSouth has proposed, and most of the other telephone companies have agreed to implement, a standardized SPID for new installations. This has been implemented by most Telcos. The standard is area code+phone number+0101 (XXXYYYZZZ0101). See Appendix 4 for a list of SPID formats used by the Telcos prior to the standard.

Unless you are using the AT&T PTP protocol, your Telco service representative should give you one SPID for each B channel you order. *Don't let the phone company installer leave without*

providing you with the phone numbers of your B channels (often called "Directory Numbers", or "DNs") and your SPIDs!

Directory Number (DN)

These are simply your seven digit phone numbers, as would be listed in your local telephone directory, and need to be entered into your Zephyr Xstream. Normally each ISDN BRI circuit will have two DNs and two SPIDs. Each DN corresponds to a given SPID and when you enter this information, you must enter them to reflect this relationship.

CSD and CSV

Recall that each ISDN BRI has two possible B channels. It is possible to order a line with one or both of the B channels enabled – and each may be enabled for voice and/or data use. Phone terminology for the class of service is CSV for Circuit Switched Voice and CSD for Circuit Switched Data. (In contrast to PSD, Packet Switched Data, which is possible but irrelevant to our needs.)

CSV is not required for Telos Zephyr Xstream hi-fidelity audio connections. Even though you may be sending voice, the codec's output will be in a data form and must be handled transparently by the telephone network. This happens because the Zephyr Xstream indicates that this is a CSD call (over the D channel) when the call is set up.

CSV is for interworking with voice phone service and allows ISDN to interwork with analog phone lines and phones. CSV is *required* to place calls to a Zephyr Xport that is using a POTS line.

You will be ordering one or more ISDN BRI 2B+D circuits with CSD (required) and CSV (optional) on each B channel. Alternate CSD/CSV should be requested.

NT1s

The ISDN standard specifies two reference points, the "U" (2-wire) and the "S" (4-wire) interfaces. The U is the single-pair bare copper from the Telco CO. A device called a "Network Termination, Type 1" converts this to the two-pair S interface.

In Europe, Asia, South America, and most of the world, the NT1 is always provided by the phone company. The Zephyr Xstream provides both the U interface (on an 6-position 4-pin miniature "RJ-11 style" modular connector) and the S interface (on an 8-position 8-pin miniature "RJ-45 style" modular connector).

Terminals and Terminal Types

Any equipment connected to an ISDN line is a 'terminal' – whether phone, computer, or codec. "Point-to-point" lines support one terminal, while "multipoint" lines can have up to eight in some applications.

"Terminal Type" is a parameter sometimes requested by the phone people. The appropriate value for the Zephyr Xstream varies depending upon protocol and is included on the order forms.

IOC Capability Packages (provisioning package or ordering code)

Increasingly Telcos are using ISDN Ordering Code (IOC) capability packages for ISDN ordering (National ISDN protocol only). If your telephone company uses these, you need only tell them you need IOC package "S" and an RJ-11 style jack. We recommend that you fax them these forms in any case, just to be sure.

Long-Distance Digital Connectivity

Long-distance connectivity is routinely available in most parts of the USA from the "big-three" carriers: AT&T, Sprint, and MCI (not Worldcom, but MCI). Connectivity between any two given points is occasionally somewhat variable. The "dial 1+" default carrier may be chosen at the time you order the line, just as with traditional voice lines (Note: you must specify the carrier for each B channel). As with voice lines, you may choose a carrier on a per-call basis by prefixing the number with the 101XXXX carrier selection code.

You must dial the full number, including the 1 or 011 + country code following the prefix.

Some long-distance connections are limited to 56kbps/channel. This limitation is becoming more rare. There is no certain way to know in advance. In addition, some carriers may work at 64Kbps and not 56Kbps. So, you may need to try both.

The Zephyr Xstream provides standard rate adaptation (officially known as 'CCITT V.110') from 56 to 64 kbps and vice versa when required. Bitrate adaptation happens automatically within the Zephyr Xstream depending upon the rate selected by the calling party. Since the Zephyr Xstream cannot communicate at both rates simultaneously, it will ignore rate adaptation information on the second incoming call remaining at the rate set for the prior call.

In our experience, the only sure way to know if a connection given between to particular points will work is to try it, first at 64kbps and then at 56kbps if the higher rate fails.

FAXABLE ISDN ORDER FORMS For the USA & Canada

Following forms should be used to place orders for ISDN lines in the USA & Canada. Since ISDN is very complex in those countries, it is necessary to use these forms or you may experience problems. These should give the phone company all of the information they need. *The majority of installations, if ordered in writing, with this information, go smoothly.* If you do experience problems Telos technical support is here to help. You may also wish to look at our troubleshooting information in the Zephyr Xstream manual.

Complete the top portion of the form and send all three pages to the phone company. Keep the form handy and show it to the installer when he or she puts in your line and ask the installer to verify with the switch programmer (at the central office) that your line is configured as ordered.

**ISDN BRI LINE ORDERING INFORMATION
USA & Canada
Telos Zephyr Xstream, Zephyr or ZephyrExpress**

To: Telecom _____

Attention: _____

From:

Location for line:

Company: _____

Company: _____

Address: _____

Address: _____

City/State/ZIP: _____

City/State/ZIP: _____

Phone: _____

Phone: _____

Contact: _____

Contact: _____

Long distance carrier: _____

Date needed: _____

Termination date: _____

We request an ISDN Basic Rate Interface (BRI) circuit for use with the Telos Zephyr Xstream digital audio transmission system. This device interfaces audio equipment to digital telephone services. It *requires* Circuit Switched Data (CSD). We may also use this device to make calls using Circuit Switched Voice (CSV) service. We therefore request alternate CSD/CSV on each B channel. Please advise us if there is a cost penalty for having both CSD and CSV.

*If you use IOC (ISDN Order Code) Capability Packages, please use **Capability Package 'S'** (unless otherwise specified by the user). If you do not use IOCs, use the information on the pages that follow.*

Zephyr Xstream has an integral BRI terminal adapter that supports these protocols (see details on following pages):

- AT&T 5ESS: Custom Point-to-Point (5E4.2 or later), or National ISDN-1 or 2
- Northern Telecom DMS-100: Functional (PVC1), or National ISDN-1 or 2 (PVC2)
- Siemens EWSD: National ISDN-1 or 2

We can use any of the protocols given above. Please let us know which protocol you will provide and the switch. We will provide the NT1 and need a U interface with 2B1Q line coding on a *standard, six-position/4-pin RJ11-style modular jack (USOC SJA48)*, of which only the center two conductors will be used.

You may call the manufacturer of the Zephyr Xstream, Telos Systems, at +1 (216) 241-7225 for any additional required information about ISDN compatibility. Ask for Telos Zephyr Xstream Customer Support.

PROTOCOL: National ISDN-1 (or National ISDN-2)

From AT&T 5ESS, Northern Telecom DMS100, and Siemens EWSD.

If you use IOC Capability Packages, please use Capability Package 'S' *unless otherwise specified*.

CO Values

Line Type: National ISDN-1

Bearer Service: CSD/CSV on both channels (*CSD is required; CSV may be omitted if requested by user*)

TEI: One dynamic per number

Terminal Type: A

101XXXX Long distance access: Yes

Turn off features such as; packet mode data, multiple call appearances, Electronic Key Telephone Service (EKTS), shared directory numbers, accept special type of number, intercom groups, network resource selector (modem pools), message waiting, hunting, interLATA competition, etc.

NOTE for EWSD running NI-2: Switch must be programmed CLID=DN.

Note for AT&T/Lucent 5ESS on loop extended lines: Per Lucent Technologies, REX test must be disabled for this line using one of the following: ASDFI266 (Prohibit REX on BRI lines per office) or ASDFI267 (Prohibit REX on BRI lines per line).

Give your customer the following information:

- 1) Two SPID numbers, depending upon number of active B channels
- 2) Two Directory Numbers

PROTOCOL: Northern Telecom DMS100 "Functional" (Custom, PVC1)

Northern Telecom DMS100 switches BCS 31 and above.

CO Values

Line Type: Basic Rate, Functional

EKTS: No

Call Appearance Handling: No

Non-Initializing Terminal: No

Circuit Switched Service: Yes

Packet Switched Service: No

TEI: Dynamic

Bearer Service: CSD/CSV on both channels (*CSD is req'd; CSV may be omitted if requested by user*)

Give to your customer the following information:

- 1) Two SPID numbers, depending upon number of active B channels
- 2) Two Directory Numbers

PROTOCOL: AT&T Point-to-Point (Custom)

Software version 5E4.2 and above.

CO Values:

Line Type (DSL class): Point-to-Point (PTP)

B1 Service: On Demand (DMD)

B2 Service: On Demand (DMD)

Maximum B Channels (MaxChan): 2

CSV Channels: Any

Number of CSV calls: 1

CSD Channels: Any (*CSD is required; CSV may be omitted if requested by user*)

Number of CSD calls: 2

Terminal Type: A

Number Display: No

Call Appearance Pref:Idle

1010XXX Long Distance access: Yes

Turn off features such as; packet mode data, multiple call appearances, Electronic Key Telephone Service (EKTS), shared directory numbers, accept special type of number, intercom groups, network resource selector (modem pools), message waiting, hunting, interLata competition, etc.

Note for AT&T/Lucent 5ESS on loop extended lines: Per Lucent Technologies, REX test must be disabled for this line using one of the following: ASDFI266 (Prohibit REX on BRI lines per office) or ASDFI267 (Prohibit REX on BRI lines per line)

Give your customer the following information:

- 1) One Directory Number

PROTOCOL: AT&T Point-to-Multipoint (Custom)

Not supported by the Telos Zephyr Xstream.

Please provide National ISDN or AT&T Point-to-Point (Custom)

Appendix 9: Modular Cable Guide

This appendix is intended to be a reference tool that covers various modular telephone- style connectors used with your Xstream.



IMPORTANT!

Be very careful to label wiring using RJ- style connectors. In some cases, they have power on them, and there is a risk of applying this power to something that does not expect it. For this reason we suggest that you use different colored cables (or connector boots) on the ISDN S interface cables versus your Desktop Director & Ethernet cables

Pin Numbering on RJ Style Jacks

It is recommended practice to install modular wall jacks such that the pins are at the top of the cavity when viewed. This helps to protect the contacts from water when baseboards are mopped, and from dust. When the jack is oriented in this position (i.e. looking into the jack with the contact pins at the top) the pins are sequentially numbered left to right.

Note that some jacks may not have all pin positions populated, however the numbering would still begin with the first position. For instance, the "RJ- 11" style jack is a 6- position 4- pin jack. Therefore, it has pins 2,3,4, & 5. Pins 1 & 6 may be absent. Note that all but a few of the following cables use 8- position 8- pin miniature modular connectors (RJ- 45 style) on both ends. In today's rapidly changing facilities, it is worth considering using a universal system for most of these cables. This strategy allows the most flexibility since the same wiring configuration could be reused for a different purpose without doing anything but documenting the change!

Therefore, we recommend that you use the TIA/EIA- 568- A T568A cable specification. This specifies a Category 5 (Cat. 5) cable with 4 pairs wired straight through (both ends wired identically) as follows:

<i>PIN</i>	<i>COLOR</i>
1	White/Green
2	Green
3	White/Orange
4	Blue
5	White/Blue
6	Orange
7	White/Brown
8	Brown

TIA/EIA-568-A T568A color codes. Cat 5 cable is used and both ends are identical. The color conductor of each pair may or may not have a white stripe. The other half of the pair may be either white or white with a colored stripe. We will use this color coding in our examples.

Note that TIA/EIA- 568- A T568B is electrically equivalent, however the Green and Orange pairs are reversed as follows:

<i>PIN</i>	<i>COLOR</i>
1	White/Orange
2	Orange
3	White/Green
4	Blue
5	White/Blue
6	Green
7	White/Brown
8	Brown

TIA/EIA-568-A T568B color codes. Note that this is electrically Identical to TIA/EIA-568-A T568A, however the green and orange pairs are switched.



Hot Tip!

While TIA/EIA- 568- A T568A and TIA/EIA- 568- A T568B are electrically equivalent, care must be taken that both ends of a given cable utilize the same system. For that reason, we strongly recommend choosing one of the two standards and using It throughout your facility.

Standard 10Base-T Ethernet Cable Pin-out

Traditionally Ethernet 10Base- T cables use the Green and Orange pair of the TIA/EIA- 568- A T568A or TIA/EIA- 568- A T568B wiring configuration. The full 4- pair TIA/EIA- 568- A T568A or T568B configurations will work just fine (see above).

Crossover 10Base-T Ethernet Cable Pin-out

When connecting a 10Base- T device (such as a computer or the Zephyr Xstream) to a hub, a “straight through” cable is used (see above). Note that this implies that functionality of the jacks on the hub are different from those on the computer, since the “output” of one must correspond to the “input” of the other. Therefore, the standard cable will not work if you wish to connect a computer directly to the Zephyr Xstream. This can be accomplished with the special cable below.

<i>10Base-T Crossover Cable</i>		
<i>PIN</i>	<i>COLOR</i>	<i>PIN</i>
1	White/ Green	3
2	Green	6
3	White/Orange	1
4	Blue	Not Used
5	White/Blue	Not Used
6	Orange	2
7	White/Brown	Not Used
8	Brown	Not Used

This special Ethernet "crossover" cable is used when two computers (or a computer and another device such as a Zephyr Xstream) need to be connected without using an Ethernet hub.

ISDN U interface Cable Pin-out

The U interface, specified in the USA & Canada, is specified between the Telco and the user-provided NT1. The U interface is a robust interface meant for use on existing Telco copper plant. It is a single copper pair. It is provided on the center pair of either a 6- position 4- pin miniature modular jacks (RJ- 11 style) or a 8- position 8- pin miniature jack (RJ- 45 style). The standards specify the compatibility between the 6- position plug and 8- position jack so either can be used. For this reason, we prefer the 6- position connectors on cables, as they will work with either type of receptacle.

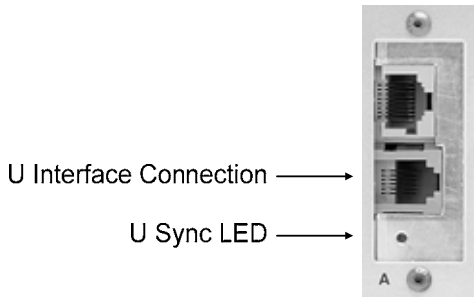

ISDN U interface cable (typical)

<i>PIN</i>	<i>FUNCTION</i>	<i>PIN</i>
1	Not Present	6
2	No Connection	5
3	Line (R)	4
4	Line (T)	3
5	No Connection	2
6	Not Present	1

Typical ISDN U interface cable. This is identical to a POTS telephone cord. Polarity should not matter, so a straight through cable is also acceptable.

ISDN U interface connector (USA & Canada only)

<i>PIN</i>	<i>FUNCTION</i>
1	No Connection
2	No Connection
3	Line (R)
4	Line (T)
5	No Connection
6	No Connection

ISDN U interface connector. Note, the polarity of the line connections should not matter.

ISDN S Interface Cable Pin-out

The S interface is standardized around the world and in most countries is the only designated ISDN termination for end users. It specifies an 8- conductor 8- position miniature modular (RJ-45 style) plug with 4 pairs as shown below (Identical to TIA/EIA- 568- A T568A). Unshielded twisted pair category 3 (or higher) cable should be used. We recommend category 5 cable. The cable details are shown below:



BRI S Interface cable.

Note: Pin 1 is to the left when viewed as above (with pins facing you and at the top).

ISDN S interface cable (Worldwide)

<i>PIN</i>	<i>COLOR</i>	<i>DESCRIPTION</i>	<i>PIN</i>
1	White/ Green	PS 3 power +/-ground (Optional)	1
2	Green	PS 3 power - (Optional)	2
3	White/Orange	Xmt (TE to NT1) to Network +	3
4	Blue	Rcv (NT1 to TE) from Network +	4
5	White/Blue	Rcv (NT1 to TE) from Network -	5
6	Orange	Xmt (TE to NT1) to Network -	6
7 ^A	White/Brown	PS 2 Power 48 VDC – (Optional)	7
8 ^B	Brown	PS 2 Power +/-ground (Optional)	8
Note A – Not used in Telos products			
Note B – Optional, not required if remote PS2 power is not needed			

ISDN S interface cable wiring diagram. Both ends are wired identically.

	<p>HOT TIP</p> <p><i>This cable has 4 twisted pairs wired “straight through” just like many cables normally used for Ethernet 10Base-T. The wiring configuration is the same as TIA/EIA- 568- A T568A (T568B is electrically equivalent).</i></p>
---	--

S Interface Connection →



<i>PIN</i>	<i>FUNCTION</i>
1	No Connection
2	No Connection
3	S Transmit to network +
4	S Receive from network +
5	S Receive from network -
6	S Transmit to network -
7	PS2 Power (- 48 VDC)
8	PS2 Power ground (+)

The S interface is a standard modular RJ-45 style jack with the pin-out shown above.



USER'S MANUAL

Appendix 10: Glossary

You'll get better results from the Telco if you understand, and speak, the lingo! We have tried to include the typical acronyms used by Telco personnel. We've put the definition under the most commonly used acronym. The most up- to- date version of this glossary is available at the Telos web site www.telos-systems.com

AMI Alternate Mark Inversion. A T1 line coding method. This is the older of the two commonly available. See line coding, T1. See Also B8ZS.

ANI – Automatic Number Identification A system, originally designed for use by Interexchange carriers (IECs), that transmits the “billed party number” along with a call. Note that the billed party number is not necessarily the number of the line placing the call. ANI predates SS7 and can operate with analog as well as digital trunks. See also CLID and Caller ID.

Asynchronous Data A form of serial data communication that is not clocked. To keep the bit stream synchronized, start and stop bits are added, which cuts down on throughput. RS- 232 computer data is commonly asynchronous data. In contrast to synchronous data.

B Channel - Bearer Channel. One of the multiple user channels on an ISDN circuit. Used to carry user's data; i.e. coded audio data in the case of Zephyr or ZephyrExpress.

B8ZS- Bipolar 8 (with) Zero Substitution. A T1 line coding method. This is the more modern line coding method of the two commonly available. See Line Coding, T1. See also AMI

Bearer Channel See B Channel

Behind the PBX This is our own term, and refers to when one privately owned phone system is tied to another privately owned phone system. The most common application is when a key system is connected to analog ports of a PBX. When it involves one PBX behind another, it is a limited Tandem application. See Tandem Switch and Tandem Tie Trunk Switching below.

Bell Labs. The basic research facility that was AT&T's primary research facility. Bell Labs was originally part of Western Electric and was spun off with Lucent Technologies when AT&T was broken up in 1984. Many very important discoveries were made at Bell Labs including the transistor, communications theory, and radio astronomy. The future of Bell Labs seems bleak at the time of this writing.

Bell Operating Company. See BOC. See also RBOC.

Bellcore- BELL COmmunications REsearch. See Telcordia. The research and development organization owned by the RBOCs. Bellcore represents the RBOCs in developing standards for Telco equipment and in testing equipment compliance to those standards. Bellcore also offers educational and training programs open to all interested parties. Now Telcordia. See Telcordia

BERT - 1) Bit Error Rate Test A test for digital lines which involves looping a data path and sending a test pattern. Data returning is compared to the sent data to check for errors. Depending on the “Test Pattern” used, BERTs may or may not uncover problems. A line, which only has occasional problems, will need a BERT of sufficient time duration to catch that intermittent problem. A five minute BERT of an ISDN BRI circuit will only catch severe problems.

2) Bit Error Rate Tester The test equipment used to perform a Bit Error Rate Test.

Billing Telephone Number The main phone number which all calls on hunt group or a PRI are billed to. This information may be required when configuring a PRI PBX.

Bit Error Rate The basic measure of errors on digital transmission paths. It is usually expressed as the number of errors per number of bits. For example, the allowable bit error rate on a BRI circuit is 1×10^{-7} (one bit error in 10⁷ bits or 1 error in 10 million bits).

Bit Error Rate Test See BERT

Bit Rate The capacity of a digital channel. ISDN calls are set up at a given bit rate, either 64Kbps or 56Kbps. The bit rate of a circuit- switched connection cannot be changed during a call. See Kbps.

BLEC Building Local Exchange Carrier. A LEC who covers the occupants of a single building (or a small group of buildings) only. Often Telecom services are provided by a BLEC as a service or incentive to potential tenants. If a BLEC offers Long Distance Service it is covered by the same regulations as any other LEC.

Blocking When a circuit switched call cannot be completed. The percentage of blocked calls to the number of calls attempted forms the basis of a statistic called "grade of service". While it is economically infeasible to build a network that would have no blocking, the Telcos are held accountable by the utility commissions to keep blocking below tariffed levels. The concept of blocking cannot be applied to packet networks (they just lose packets, instead), only circuit switched networks.

Blue Alarm Also called an Alarm Indicating Signal (AIS). A keep- alive signal sent if a problem occurs mid- span in a T- carrier system. The blue alarm signal is required because in some cases T- 1 repeaters will become unstable if inadequate 1's density is not maintained.

BOC - Bell Operating Company One of the regional telephone companies that were owned by AT&T before divestiture in 1984 (i.e. New England Telephone, Ohio Bell, etc). The 22 BOCs were divided among the RBOCs at divestiture. See RBOC.

Both Way Trunks see combination trunks.

BRI refers to ISDN **Basic Rate Interface** - The common form of ISDN with 2 "Bearer" Channels and one "D" channel. All three channels are on a single copper pair and encoded with type 2B1Q coding.

BRITE- Basic Rate Interface Transmission Extension. A technology where ordinary T- 1 trunks (or any other digital carrier system) are used to extend ISDN BRI service. BRITE uses 3 DS0 channel per BRI - One for each B channel and one for the D channel. See Repeater.

BTN See Billing Telephone Number.

Business Office The part of the phone company where you call if they mess up your bill, to report problems, and to order service. Not necessarily technically literate.

Called Party Address This is the destination phone number of a call delivered to a switch. For instance this could be the CLID of a call delivered to a PBX using DID or two- way trunks. See also DID.

Caller ID A CLASS feature on an analog line that provides the number of the calling line as a burst of FSK data (modem tones) following the first ring. Also called Calling Line Identification. See also CLASS.

Calling Line ID See CLID. See also Caller ID.

Calling Party Control See CPC.

CAS Channel Associated Signaling. A bit- based signaling method used on digital lines (such as T1) that is periodically inserted into the low order bit also used for the audio transmission. See Robbed Bit Signaling.

Cause Code A code returned by switching equipment to ISDN equipment as part of the call control signaling protocol. The cause code indicates that a network call- related event has occurred or has failed. Since these codes actually come from the network, the fact you are getting a cause code is an indication that that the ISDN circuit is operational at some level.

CCIS Common Channel Interoffice Signaling. A signaling system where network information such as address and routing information are handled externally to the actual communications (voice) path. SS7 (Signaling System 7) is the internationally standardized CCIS system. Deployment of CCIS increased efficiency since no communications (voice) channels are used merely to report an "all trunks busy" or "far end busy" conditions. It also decreased toll fraud substantially since it removed the potential for access to the signaling information that was inherent to in- band signaling schemes. CCIS also enables CLASS features as well as sophisticated re- routing features for "intelligent network" applications. See also in- band signaling. See also SS7.

Central Office See CO

Centrex - Central Exchange Service. An enhanced business telephone service intended to offer most of the features of a PBX but where the lines are all from the LEC out of a public switch. Offers CLASS- like features for business users such as 4- digit "inside" dialing, hold, transfer, attendant, etc.

CEPT- Conference on European Posts & Telecommunications. This is a European standards body that formerly set the standards for telephone interfaces for 26 countries.

CEPT Format The usual rate and frame format for E1 circuits. 2.048 mbps. See E1.

CEPT Rate See CEPT format. See also E1.

Channel An actual path you can talk or send data over. This is what you are paying the phone company for. For instance, ISDN BRI lines can be ordered with 1 or 2 active channels and these channels can be configured for voice calls (CSV), data calls (CSD) or both (alternate CSD/CSV). A channel does not necessarily have it's own unique telephone number. See ISDN.

Channel Associated Signaling See CAS. See also Robbed Bit Signaling.

Choke Exchange A telephone exchange, which is assigned to Radio and TV stations, Promoters, and other users that will be receiving large numbers of simultaneous calls. The idea is to group all of these users on a single exchange so when all routes into that exchange are in use "normal" users (on other exchanges) will not experience blocking of incoming or outgoing calls. Trunks from other local exchanges into the choke exchange are deliberately limited to just a few paths so callers will get an "all trunks busy" instead of completely blocking their local exchange. However, when one of the choke exchange users experiences a large number of calls (as when your station runs a contest) the other choke exchange users will be blocked because all trunks into the choke exchange will be busy. In the modern network, using CCIS signaling such as SS7, actual trunks are not used to convey "busy" or "all trunks busy" conditions. Thus blocking due to

a station contest should not occur as the busy status in response to a call attempt is conveyed over the separate SS7 network. Therefore, the need for choke exchanges has pretty much disappeared. Nonetheless, many Telcos still insist that Broadcasters use special choke lines for call- in lines. See blocking and concentration.

Circuit A physical path through which electrical signals can pass. It consists of a network of conductors and other components, separated by insulators. Technically this term cannot be applied to fiber optic or other “non-metallic” paths. See also channel.

Circuit Switched Data See CSD

Circuit Switching A system where a dedicated channel is allocated to the users of that call for the duration of that call. That channel is allocated for the duration of the call regardless if information is being transmitted at any given moment. Bandwidth through the channel is fixed, at no time may this bandwidth be exceeded. If this bandwidth is not used it is wasted. While inherently inefficient, the dependable and reliable nature of circuit switching makes it ideally suited to real- time voice and audio/video conferencing applications. When over loaded Circuit Switched networks will respond "all circuits are busy... try again later". This is in stark contrast packet switched networks or to systems where statistical multiplexing is used. See statistical multiplexing and Packet Switching.

CLASS- Custom Local Area Signaling Services. A variety of enhanced features (usually on analog lines) that take advantage of the ability of modern SS7 technology’s ability to transmit information about the calling party. CLASS includes such features as Caller ID, Automatic Callback, Call Trace (initiated by subscriber), Selective Call Screening, etc.

Clear Cause See Cause Code

CLEC- Competitive Local Exchange Carrier Your local telephone service provider who is one of the new- generation providers rather than a RBOC or Independent. A CLEC is really just an independent, albeit one formed after the divestiture of AT&T. See LEC and Independent.

CLI - Calling Line Identity European term for CLID. See CLID.

CLID- Calling Line Identification This is the ISDN and SS7 equivalent of Caller ID; I.E. the number of the calling party. See also Caller ID and ANI.

CO- Central Office The Telco facility to which your local telephone circuit lead. Contains “Switches” and “Trunks” as well as the local telephone circuits.

Codec- COder/DECoder A device which takes digitized audio and “codes” it in order to reduce the transmission bit rate and which can also simultaneously “decode” such coded audio. Strictly speaking, a codec does not include an ISDN terminal adapter and related equipment. Simple codecs are also used in digital telephony. These use a simple companding scheme to reduce channel noise.

COL - COnnected Line number European Term. The number to which you have connected. This may not be the number you dialed if call forwarding is used.

Combination Trunk A trunk (channel) which can both make and receive calls. This generally refers to analog ground start or loop start trunks, although the term can be applied to ISDN BRI or PRI channels as well. Each combination trunk normally has a telephone number, although they are frequently part of a hunt group and only one number may be published for that group.

Also called a Both Way Trunk. This is not the same as a Two-way DID trunk. See DID trunk, Hunt Group and Trunk.

Common Channel Interoffice Signaling See CCIS

Competitive Local Exchange Carrier See CLEC.

Concentration The basic premise is to share facilities wherever possible. For instance, while there may be thousands of customers served by a given Central Office, there will be substantially less than that number of calls which can be handled simultaneously. And, even fewer long distance calls can be made simultaneously. The art of Traffic Engineering is to have enough capacity that calls are rarely blocked, but no more than that number. See also Choke Exchange and Blocking.

CPC- Calling Party Control Sometimes referred to as "CPC Wink" or "disconnect supervision". A call supervision feature on an analog loop start line that provides the ability for a CO (Central Office) to signal the called party when the calling party hangs up. CPC allows the PBX, key system, or telephone answering device to reset the line so that it is ready to accept or initiate another call. CPC is accomplished by either a loop current drop or reversal. With some CO equipment, it is also provided if the called party drops the call. See also MCLD.

CPE- Customer Premise Equipment Customer owned equipment located at his/her facility, such as a CSU or terminal. In the USA and Canada, the NT1 is part of the CPE.

CPN - Called Party Number European Term. The number that has been dialed. See Called Party Address.

CSD- Circuit Switched Data A dial-up data communications channel which, once established, looks like a transparent data pipe. Also, the type of ISDN service required to utilize this capability of an ISDN circuit. In contrast to CSV.

CSU- Channel Service Unit The NCTE used in the USA & Canada to terminate a T1 line. Typically the CSU must be provided by the end user. See NCTE and DSX1

CSU/DSU A device which incorporates the functions of a CSU (Channel Service Unit) and a DSU (Data Service Unit) Most commonly it interfaces between a Switched- 56 or Dedicated Digital Service circuit and a user's data equipment such as the Zephyr.

CSV Circuit Switched Voice- A dial-up communications circuit for voice grade communication. Also, the type of ISDN service required to use this capability of an ISDN circuit. In contrast to CSD

Custom ISDN (USA & Canada) An ISDN protocol which pre-dates National ISDN- 1. In most cases National ISDN- 1 is also available. The Northern Telecom DMS-100 switch Supports "DMS Custom Functional" ISDN. The AT&T/Lucent 5ESS switch Supports "Custom Point-to-Point" (PTP) and Custom Point-to-MultiPoint (PMP). The ISDN protocol has no relation to where one may call. Telos equipment does not support PMP.

D Channel- Data/Delta Channel Depending on who you ask, it is Data or Delta. The channel which handles ISDN network-related data between the user's equipment and the Telco switch. Used to carry data to set up calls and receive calls. Some Telco's also allow users to use the D channel to access the packet data network, with appropriate terminal equipment.

D4 See Superframe. See also Line Format.

DCE- Data Communication Equipment When using serial communications such RS- 232, V.35, or X.21, the DCE is the device sending/receiving from the Telco line. i.e.: a modem or CSU/DSU. In contrast to DTE.

DDS- Digital Data System See Dedicated Digital Service.

Dedicated Circuit A permanent channel between two locations. As opposed to a Switched Circuit.

Dedicated Digital Service A "Hardwired" or "Nailed Up" digital circuit which is permanently connected between 2 points. Typically 56Kbps or 64Kbps. Dedicated digital lines are frequently cheaper than ISDN for full time service. Also called Digital Data System or DDS.

DID- Direct Inward Dialing The ability for an outside caller to dial to a PBX extension without going through an attendant or auto- attendant. See also DID Number and DID Trunk.

DID Extension or **DID station** A specific phone within a PBX which can be called from the public telephone network without going through an attendant or auto- attendant.

DID Number A phone number used to route calls from the telephone network to a specific phone in a PBX (the DID extension). DID requires special DID trunks or ISDN PRI "two-way DID" trunks. Blocks of DID numbers (typically 10 or 20, sometimes higher) are purchased from the LEC or CLEC for use on the PBX. The number of DID numbers usually substantially exceeds the number of trunks in the system.

DID Trunk- A Direct Inward Dialing Trunk. A trunk (channel) which can only receive calls. A group of telephone numbers (DID numbers) are associated with a given trunk group, however there is no one- to- one correspondence between the individual channels and these numbers. The PBX uses the DID number given it by the phone company to route the channel to the correct DID extension within the PBX. This allows some or all PBX stations to receive calls directly without going through an attendant (or auto attendant) Note that there are usually more DID numbers than there are DID trunks. See DID number and DID extension.

Direct Inward Dialing See DID

Directory Number (USA & Canada) Your seven digit telephone number (without the area code), as found in the telephone directory.

Directory 1&2 (Zephyr) The Utility menu on the Zephyr where the 7 digit Directory Numbers can be entered during set up. The Zephyr generally does not require these numbers.

DN See Directory Number. See also Directory 1 &2 and MSN/DN 1 &2.

DNIS- Dialed Number Identification Service A service, typically offered by a long distance company on 800 lines, that provides the number dialed by the caller. This allows a caller to receive specific treatment depending on the number dialed.

DP Dial Pulse. A method of sending address information by either 1) Causing brief interruptions in loop current. or 2) Causing brief changes of state of a bit on a digital circuit using Channel Associated Signaling. In other words, "rotary" or "pulse" dialing. See also DTMF and CAS.

DSØ- Digital Signal Level Zero The smallest unit of measure of the standard rate hierarchy used by the Telcos (i.e. all other rates are a multiple of the DSØ rate. For example, the T1 rate is 24 times the DSØ rate and the E1 rate is 32 times the DSØ rate). 64 kbps. See also B channel.

DS1- Digital Signal Level 1 The second level up the digital rate hierarchy used by the Telcos. This is 24 times the DSØ rate for a total of 1.544 mbps. See DSØ. See also T1.

DS2- Digital Signal Level 2 Data rate of 6.312 mbps (4 times the DS1 rate). See DSØ and DS1.

DS3- Digital Signal Level 3 Data rate of 43.232 mbps (28 times the DS1 rate). See DSØ and DS1.

DSL- Digital Subscriber Line Traditionally refers to an ISDN circuit or sometimes a T1 line, although the term is also frequently used to mean the next generation beyond ISDN. Sometimes xDSL is used to indicate that the writer is referring to any of a number of emerging DSL technologies.

DSU- Data Service Unit See CSU/DSU.

DSX- 1- Digital Cross Connect level 1 (USA & Canada, primarily) Defined as part of the DS1 (T1) specification and is a closely related signal. The type of signal switched by a Digital Cross-Connect System (DACCS). The FDL is stripped off at the DACS interface. DSX- 1 is also the type of signal that arrives at the user side of a CSU on a T1 line. A DSX- 1 cable is limited to 655 feet (200 meters).

DTE- Data Terminal Equipment When using serial communications such RS- 232, V.35, or X.21, the DTE is the device sending/receiving from a modem or CSU/DSU. In contrast to DCE.

DTMF – Dual Tone Multi Frequency The standard tone- pairs used on telephone terminals for dialing using in- band signaling. The standards define 16 tone- pairs (0- 9, #, * and A- F) although most terminals support only 12 of them (0- 9, * and #). These are also sometimes referred to as “Touch Tones”. Note that while digital data terminals have the same symbols, ISDN uses “common channel signaling” (over the D channel) and therefore does not necessarily generate any tones at all. However many terminals still generate the tones since they will still be used on occasion to access services (such as voicemail or automated attendant) at the far end using in-band tones.

E1 A common type of digital telephone trunk widely deployed outside the US and Canada. Has 31 available 64 kbps channels (called DSØ's) plus a sync/control channel for a total data rate of 2.048 mbps.

E- 1 See E1

ESF- Extended Superframe A type of Line format supported on T1 circuits. The Telco determines the line format and line encoding of your line. See Line Format.

ETS 300 The pan European ISDN protocol standardized by ETSI. This protocol is used throughout Europe and has been adopted in many other countries outside the USA & Canada. See also MSN.

ETSI - European Telecommunications Standards Institute Euro ISDN See ETS 300.

Exchange Another name for a Central Office (most often used in European countries). Also used in the USA & Canada to refer to a particular 3- digit prefix of a 7- digit telephone number. See CO.

Extended Superframe See ESF.

FDL- Facilities Data Link A bi- directional data link available on T1 circuits when the ESF line format is used. The FDL is primarily used by the Telco to poll the CSU for error statistics.

Four Wire A circuit path using separate pairs for send and receive. This term is also used when referring to digital channels that inherently have discrete send and receive paths, regardless of the number of pairs (or other media) used. See also Hybrid.

Frame A unit of data which is defined by the specific communications protocol used. See Line Format, T1.

Glare On a POTS line an incoming call is signaled by periodically applying an AC ring voltage to the line. Since there is a semi random period before the ring, and pauses between rings, it is possible to seize a line which is "about to ring" (and answer a call) when attempting to place an outgoing call. When this scenario happens it is called glare. Glare is much less likely if Ground Start or ISDN trunks are used. See also Ground Start Trunk.

GR- 303 See SLC- 96

Grade of service This is simply the ratio of calls blocked to total calls in a decimal form. Therefore, a grade of service of P.08 would represent 8% blocking. Telephone tariffs regulate the acceptable average grade of service which must be provided on public networks. See also Blocking.

Ground Start Trunk A type of telephone trunk where the request to make an outgoing call (i.e. request for dial tone) is made by briefly grounding the Tip conductor. Many PBX system use ground start trunks as they are less prone to glare than Loop start trunks. Ground start lines are sometimes used with equipment designed for Loop Start lines. This may or may not work - generally it serves to prevent outgoing calls while incoming calls work normally. Telcos may call these "ground start lines". See Loop Start Trunk. See also Glare.

HDB3- High Density Bipolar 3 An E1 line coding method. This is the more modern line coding method of the two commonly available. See Line Coding, T1. See also AMI and B8ZS

Hunt group A group of telephone channels configured so that if the first is busy (engaged) the call goes to the next channel, if that channel is busy it goes to the next channel, etc. Hunt groups may hunt from the highest to the lowest, the lowest to the highest, or on some other arbitrary pattern. But the order of hunting will usually be fixed, beginning with one channel and working through ("hunting") until an unused channel is found. The term may have originated back in the old manual switchboard days when the operator literally hunted for an unused jack to plug a cord into. This arrangement is very common in business scenarios where a single incoming number (the Listed Directory Number) is given to the public, but multiple incoming channels are supported. See also LDN.

Hybrid A device which converts from a two- wire signal such as POTS lines (or a 2- wire intercom) to a four-wire system (separate send and receive paths) such as used in the pro- audio world. While this task is theoretically quite simple, the fact the impedance of most phone lines varies widely across frequency complicates matters. The Telos 10 telephone system was the first practical DSP based hybrid and applied the then brand- new technology to this problem.

IEC - 1) InterExchange Carrier "Long Distance" carrier. Handles Interlata and interstate calls. Also referred to as IXC. **2) International Electrotechnical Committee** A European standards body best known for the power plug now used throughout the world for AC power cords for use on office equipment and computers.

IGMP (Internet Group Management Protocol) is a communications protocol used to manage the membership of Internet Protocol multicast groups. IGMP is used by IP hosts and adjacent multicast routers to establish multicast group memberships. IGMP is used by Livewire™ to manage multicast audio streams.

ILEC – Incumbent Local Exchange Carrier A local Exchange Carrier which entered the marketplace before the enactment of the 1996 Telecom act;. i.e. a telephone company which is neither an Indi nor an RBOC. See LEC and CLEC.

IMUX See Inverse Multiplexing

In Band Signaling A signaling system where network information such as address and routing information are handled over the communications (voice) path itself. Usually the information is represented in the form of audible tones, however DC loop current signaling also qualifies as In Band Signaling. See also CCIS.

Incumbent Local Exchange Carrier See ILEC. See also CLEC & LEC

Independent Any of the phone companies in existence at the time of divestiture that were not affiliated with the Bell System. See RBOC, LEC, and CLEC.

Indi See Independent.

Interconnect Company A vendor of telecommunications CPE other than a BOC or AT&T. This term was originated by AT&T and was meant to be derisive towards the fledgling industry when the courts said it was OK for end users to buy equipment from someone other than the Bell System. This industry flourished, in spite of AT&T's disdain, and ironically, the RBOCs were not allowed to sell CPE under the terms of the breakup of AT&T. With the current state of deregulation, the RBOCs are slowly re-entering this business.

Interexchange Carrier See IEC

Interwork The ability of two different type of networks to communicate seamlessly. For example, ISDN can interwork calls to both the POTS network and the Switched- 56 network.

Inverse multiplexing A method of breaking apart and later combining 2 data streams that does not involve the telephone network. Inverse multiplexing is the most common way of achieving this function in Codecs operating at 112 or 128kbps over ISDN.

IOC Capability Packages ISDN Ordering Code system. This system was devised by the National ISDN User's Forum and Bellcore to simplify ordering new ISDN lines in the USA and Canada. Using a single code specifies all line specifications. The Telos Zephyr, ZephyrExpress, TWO, and TWOx12 support IOC package "S". Search for document NIUF 428- 94 at NIUF's web page <http://www.niuf.nist.gov/> for more information.

ISDN Integrated Services Digital Network- A relatively new and highly flexible type of telephone service which allows dialing on digital channels with multiple bi- directional "Bearer" channels each with a capacity of 56 or 64 Kbps and a single bi- directional "D channel". See BRI and PRI.

ISDN Protocol The "language" used for communication between the Telco's switch and the customer's Terminal Adapter. Each ISDN circuit has one protocol, and the protocol has no effect on where or whom one may call. See ETS 300, National ISDN, and Custom ISDN.

ISDN 2 A term used in Europe for ISDN BRI. Also called SØ. Not to be confused with National ISDN- 2. See BRI.

ISDN 30 A term used in Europe for ISDN PRI. Also called S2M See PRI.

ISG – Incoming Service Grouping A Hunt Group. See Hunt Group

IXC- IntereXchange Carrier See IEC

Kbps KiloBits Per Second. Measure of digital channel capacity.

Key Telephone System A system that allows multiple telephones to share multiple pre-determined telephone lines. The system provides indicators to allow the user's to understand the status of each line available on a given phone. In its most basic form it is USER'S MANUAL up to the user to provide the intelligence to select an unused line, or answer a ringing line, for example. The Telos 10, Direct Interface Module, One- x- Six, TWOx12 and Series 2101 can be classified as Key Telephone Systems. See also PBX.

LATA- Local Access and Transport Area The area within which calls are routed by your Local Exchange Carrier (LEC). Under the divestiture of the Bell System calls going outside of this area must be handled by an Interexchange carrier (IEC). With the latest round of de- regulation the usual IEC companies are being allowed to compete in the IntraLATA long distance market and LECs are beginning to be permitted to handle InterLATA calls.

LDN- Listed Directory Number When a number of Telco channels share the same hunt group, it is customary to give out only one phone number for the group, although generally each channel will have its own number. The number given out is the "Listed Directory Number" since that is the number that would be listed in the Telephone Directory and given to customers. Sometimes called a Pilot Number. See also DN and Hunt Group.

LE - Local Exchange. European term for Central Office. See CO.

LEC- Local Exchange Carrier Your local telephone service provider which is either an RBOC or an Independent. In other words, a traditional phone company. In contrast to CLEC or IEC.

Line An electrical connection between a telephone service provider's switch (LEC or CLEC) and a telephone terminal or Key system. An electrical connection between a telephone service provider's switch and another switch is technically called a trunk. Note that some type of physical lines offer more than one channel. I.E. a BRI circuit has 2 channels, called B channels. This term is a confusing one, so we try to avoid using it. See Channel. See also Station Line.

Line card The circuit in the Telco switch to which your line is connected. On an ISDN circuit the line card performs a role analogous to the NT1 in adapting to and equalizing the circuit to establish OSI Layer 1.

Line Coding, T1 The clock signal for T1 is derived at the far end from the data bits themselves. Therefore, T1 lines have certain restrictions as to the data allowed. No more than 15 zeros shall be sent in a row; and average density of 12.5% ones must be maintained. The CSU is responsible to ensure that these requirements are met. The line encoding method, AMI or B8ZS determines exactly how these requirements are met while still allowing recovery of the original data at the far end. Your Telco will determine the method used on a specific circuit. B8ZS is preferred. E1 circuits have similar restrictions. HDB3 is preferred for E1 circuits.

Listed Directory Number See LDN

Line Encoding, T1 See Line Coding, T1.

Line Format, T1 Modern T1 circuits usually use either Superframe (sometimes called SF or D4) or Extended Superframe (sometimes called ESF) line formatting. The type of framing used is determined by your Telco. ESF is preferred. See ESF and SF

Line Side This is the side of a central office switch that the subscriber's telephone lines are connected to. The main reason for distinguishing between this and the trunk side is that certain customer related features (Such as CLASS and Centrex features) are inapplicable to trunks. See also Trunk Side. 2) The user side of a PBX. Also called the station side.

Line Termination See LT.

Livewire™ This is the trade name used by Axia Audio (a division of Telos-Systems) to describe the audio streams utilized in their networked audio system.

Local Access and Transport Area See LATA.

Local Exchange Carrier See LEC and CLEC.

Long Distance If your local Telco is a former Bell Operating Company then any call outside of your LATA or any Interstate call is considered long distance and is handled by an IEC. The above is true regardless of whether you are referring to a dedicated line or a dial up call. 2) However, under the current state of deregulation, toll calls within a LATA may now be covered by the IEC, and in some cases RBOCs are being permitted to handle InterLATA calls.

Loop The telephone circuit from the CO to the customer's premises. Generally refers to a copper cable circuit.

Loop Current Disconnect Supervision Another name for CPC. See CPC

Loop Qualification Process of actually measuring the loss on a prospective ISDN line to see if it can be used for ISDN service. The actual loss on the line (usually measured at 40 kHz) is the determining factor whether ISDN service can be offered without a repeater. Generally ISDN is available up to 18,000 feet from the serving Central Office. It may not be available within this range, or may be available further from the CO. Only a loop qualification can tell for sure. Not all Telcos will extend ISDN lines with repeaters.

Loop Start Line A plain old telephone line. The telephone terminal signals the "off hook" condition by allowing DC current to flow. See Ground Start Trunk. See also Glare.

Loop Start Trunk A plain old telephone line connected to a PBX switch. See Loop Start Line. The PBX signals the "off hook" condition by allowing DC current to flow. Ground Start Trunks are generally preferred for use on PBXs to prevent glare. See Ground Start Trunk. See also Glare. The Telco may call this a "Loop Start Line".

LOS Loss Of Signal. An LED or other indicator that illuminates if a signal is absent. This terminology is commonly used with T- 1 equipment.

LT - Line Termination The electrical and protocol specifications for the Central Office end of an ISDN line. If you wish to connect an ISDN terminal (such as a Zephyr Xstream) to a PBX the PBX must support LT ISDN. See also NT and Line Card

Lucent Technologies Company which now makes the former AT&T 5ESS switch, as well as various other piece of Telco gear and semiconductors. Lucent was split off from AT&T in 1996 and owns Bell Labs. As of approximately 1999 Lucent sold their telephone set manufacturing

business (and the right to use the AT&T name on telephone sets) to V- Tech. V- Tech is using the AT&T name and line as their high- end line. Lucent's PBX division was spun off in 2001 as AVAYA.

MCLD- Modifying Calling Line Disconnect The parameter on the Lucent 5ESS switch that determines if CPC is active. Should be set to "Yes" if CPC is required. See CPC

MSN/DN 1&2 (Zephyr Xstream) The Telco menu selections on the Xstream where the MSN (Euro & INS 64 ISDN) or 7 digit Directory Numbers (USA ISDN) can be entered during set up. The Zephyr Xstream generally does not require that these numbers be present. See Directory Number and MSN.

MSN- Multiple Subscriber Number (Euro ISDN) This is a telephone number associated with an ETS 300 BRI line. Providers of ETS 300 often give you three MSNs with a BRI, although additional MSNs can be purchased. An ISDN terminal will "ring" (provide an alerting signal) only when calls are made to the MSN (or MSNs) entered in that terminal. If a terminal has no MSNs entered, it will "ring" whenever there is a call to any of the MSN's on that BRI. See ETS 300 and DN.

National ISDN (USA & Canada) The US "standardized" multi- platform ISDN protocol. The first version is National ISDN- 1. As of mid 1996 National ISDN- 2 has been implemented in some areas and is fully backward compatible with National ISDN- 1.

NCTE – Network Channel Terminating Equipment. NCTE is a general term that can be applied to a CSU or NT1 or other equipment terminating a digital line at the customer's premises. In many countries, the NCTE is provided by the Telco. The USA is not one of those countries.

Network Channel Terminating Equipment See NCTE.

Network Termination See NT

NIUF- National ISDN User's Forum A user's group formed under the National Institute of Technology (NIST) in the USA. The NIUF is a neutral forum where the switch manufacturers and Telcos can get input from users and CPE manufacturers regarding the implementation of National ISDN. Among NIUF's successful projects have been the IOC ordering codes. Their web page is at <http://www.niuf.nist.gov/> . See National ISDN.

Nortel Manufacturer of the DMS- 100 switch as well as many other pieces of telecom and network equipment. Now called Nortel Networks.

Northern Telecom The Canadian company which was once the manufacturing arm of Bell Canada (it was called Northern Electric back then). Now called Nortel Networks. See Nortel.

NT - Network Termination The electrical and protocol specifications for the user end of an ISDN line. See also LT.

NT- 1 An alternative expression for NT1. See NT1

NT1- Network Termination Type 1 The termination at the customer premises of an ISDN BRI circuit. The NT1 performs the role of line termination of the "U" interface and Codes/Decodes from the line's 2B1Q coding scheme. The customer end of the NT1 interfaces using the "S" or "T" interface. The NT1 is frequently part of the "Terminal Adapter" and is built- in to Zephyr Xstream, Zephyr, ZephyrExpress, Telos TWO and TWOx12 systems sold in the USA & Canada. See also NCTE

NTBA- Network Termination Basic Access The term used for NT1 in some countries. See NT1. See also NCTE.

Packet Switching Packet Switched networks are more commonly associated with Computers, Local Area Networks, and the Internet. In a packet switched network the raw stream of data is broken into individual pieces, called packets. Each packet is routed through the data network, individually. This is somewhat analogous to taking the pages of a book and sending each page as a letter through the postal system. The page numbers would allow reassembly of the book no matter what order the pages were received at the far end. The end user does not know or care that the packets may travel a variety of routes. If a given page did not arrive in a reasonable length of time, one could request that this page be re- sent. Most packet switched systems allow packets to be discarded if the network capacity is exceeded (the postal system is not supposed to do this). This is accommodated by the higher- level protocol, which knows to request that a packet be re- sent if it does not arrive. Therefore, the typical behavior of a packet switched network when overloaded is that throughput decreases (i.e. the network "slows down") as the percentage of discarded packets increases. In stark contrast to Circuit Switched networks. See Circuit Switching.

PBX- Private Branch Exchange A privately owned switch. Basically, a PBX is a private "business" telephone system which also interfaces to the telephone network. In some circles 'PBX' implies a manual switchboard whereas 'PABX' (Private Automatic branch exchange) implies a PBX that supports dialing by end users. Many PBX's can now offer ISDN BRI service, usually over the S Interface. A few vendors are now offering BRI over the U interface as well. PRI over DSX- 1/T1 or E1 is also offered in some cases. Be wary of these ISDN protocols since they have not been as well tested as the versions running on "public" switches. They may or may not work with a given piece of CPE.

PIC- Primary Interexchange Carrier (USA) This is your default "1+" carrier used for interLATA calls. In some areas you may have two PICs, one for interLATA calls, and one for intraLATA long distance calls (in which case it stands for Primary Intraexchange Carrier). In some areas intraLATA long distance calls are still handled by your RBOC, in others you now have a choice. You may be able to discover who your current PIC is by dialing 700 555- 4141.

PMP (USA) AT&T "Custom Point to Multi- Point" Custom ISDN Protocol. Not supported by the Zephyr or ZephyrExpress. See Custom ISDN and ISDN Protocol.

POP - Point Of Presence The local facility where your IEC maintains a switch. This is where your long distance calls get routed so that your IEC can handle them. Also used to describe the local access point of an Internet Service Provider.

Port This is a pretty general term. Newton's Telecom Dictionary 10th edition defines a port as "An entrance to or an exit from a network". Many phone equipment vendors refer to ports as the physical interface between a Switch and a Line or Trunk. Product literature often refers to the number of ports on a phone system. In this context it refers to the number of phones or lines (or sometimes the combination) the system supports.

POT- Plain Old Telephone A black, rotary- dial desk phone. Usually a Western Electric model 500 set. Outdated term.

POTS – Plain Old Telephone Service Regular old- fashioned analog loop start phone service.

PRI ISDN

Primary Rate Interface A form of ISDN with 23 “B Channels” and one “D channel”. All 24 channels are on a single cable. Functionally related to T1 telephone circuits. In Europe PRI has 30 “B Channels” and one “D Channel” and one “Sync channel”. See also B channel and D channel.

Provisioning The act of configuring an ISDN or other telecommunications path. Also refers to the complete line configuration information.

PS2 Power Power provided on pins 7 and 8 of the “S” interface cable. This power is used so that a NT1 can provide power to a terminal (usually a phone). In some cases, it is used to allow a terminal to power an NT1. The USA versions of the Zephyr, ZephyrExpress, supply PS2 power in the “S” jack. The Zephyr Xstream and Telos TWO provide this on all versions. This power arrangement is also used in the Telos TWOx12 and 2101 Studio Interface to power Desktop Directors.

PTP (USA) AT&T “Custom Point to Point” Custom ISDN Protocol. Point- to- Point lines have only one incoming phone number which must be dialed twice to connect to both lines (the first call goes to “line 1” and the second call rolls over to “Line 2”. See Custom ISDN and ISDN Protocol.

QoS (Quality of Service) is the ability to provide different priority to different applications, users, or data flows, or to guarantee a certain level of performance to a data flow. For example, a required bit rate, delay, jitter, packet dropping probability and/or bit error rate may be guaranteed. Quality of service guarantees are important if the network capacity is shared, especially for real-time streaming multimedia applications such as Livewire™.

RBOC- Regional Bell Operating Company (USA) One of the regional companies formed when AT&T was forced out of the local telephone business. Each RBOC (or “baby bell”) owns a number of the former “Bell Operating Companies”. The Bell Operating Companies are the traditional local phone companies (pre- 1984), except where one’s service is from an “Independent” (non bell) telephone company or a CLEC. Due to their former association with the Bell System RBOCs are regulated by the FCC differently than are independent Telcos or CLECs. In many cases the Bell Operating Company structure is no longer used. For instance, here in Ohio we now deal directly with the RBOC, Ameritech, while the old Bell Operating Company, Ohio Bell Telephone, no longer exists. Another trend is mergers among the RBOCs (and in some cases the independents as well). See CLEC and LEC.

RD- Receive Data Data coming from the network, or DCE towards the DTE. Also, a light on a modem or CSU/DSU that lights to indicate presence of this signal.

Red Alarm An alarm state on a T- carrier circuit that indicates that the incoming signal (at the network interface) has lost frame for more than a few seconds. Normally a Yellow alarm is then returned (i.e. sent back) if a Red alarm is present. A Red Alarm indicates a loss of inbound signal; a Yellow alarm indicates (indirectly) a loss of outbound signal. See also Yellow alarm, Blue alarm, and LOS.

Regional Bell Operating Company See RBOC

Repeater A device intended to extend ISDN telephone service to sites further from the central office than could normally be served. i.e.: beyond 18,000 feet. ISDN repeater technologies include “BRITE”, “Virtual ISDN”, “Lightspan”, and “Total Reach”. Some Telcos do not use repeaters. Compatibility between a given NT1 (CPE) and a repeater is less certain than if that CPE were directly connected to the switch.

Robbed Bit Signaling A signaling scheme that “borrows” bits on each T1 channel for use as signaling channels. On SF T1’s there are two bits, the A bit and the B bit in each direction. On ESF T1’s there is also a C and D bit in each direction, although they are rarely used. Using these bits, various older analog trunk interfaces can be emulated over a T1. For instance, dial pulse address signaling using 10 pulse per second (rotary style) digit groups over these bits. Since robbed bit signaling interferes with the least significant bit, only 7 bits can be used for sensitive data applications, leaving only a 56kbps channel for data applications. See also CAS and CCIS.

Rollover See Hunt Group

S interface The electrical interface between the NT1 and the Terminal Adapter or other ISDN equipment. ISDN equipment with built- in NT1’s do not necessarily provide access to the S interface (the Zephyr Xstream, Zephyr, ZephyrExpress and Telos TWO do). Multiple devices can share an NT1 by connecting on the S interface. Also known as the S passive bus.

SØ European term for ISDN BRI. See BRI and ISDN2.

S2M European term for ISDN PRI. See PRI and ISDN 30

Sealing Current Unlike telegraphy, teletypewriter and POTS lines, most digital lines (such as ISDN) use a voltage rather than current mode of operation. Sealing Current allows a controlled amount of current to be passed through a telecom circuit for purposes of “healing” resistive faults caused by corrosion. Bellcore specifies sealing current on the ISDN U interface in the USA. The Siemens EWSD switch does not provide sealing current. Most other ISDN capable switches used in North America do.

SF- Superframe A type of Line format supported on T1 circuits. The Telco determines the line format and line encoding of your line. ESF is the preferred Line Format on T1 circuits. See Line Format.

Silence Suppression See Statistical Multiplexing.

SLC- 96 A Subscriber Loop Carrier Circuit system manufactured by AT&T (now Lucent). SLC- 96 has its own version of T1 framing between it and the CO. SLC- 96 and similar "SLIC" systems may or may not perform a concentration function. The interface is the Bellcore TR- 008 or the newer GR- 303 interfaces that are specialized versions of T1 intended to allow transparent transport of analog CLASS features such as Caller ID, Call Waiting, etc. The GR- 303 interface is specifically intended to be used as a common point of interconnection between alternative equipment, technologies, and/or networks (i.e. voice- over-DSL, voice- over- IP, etc)) and the public switched network. See the following link for additional information from Telcordia:

<http://www.telcordia.com/resources/genericreq/gr303/index.html>

SLIC 1) Subscriber Line Interface Circuit, see “Line Card”. 2) The equipment used with the AT&T (Lucent) SLCC Subscriber Loop Carrier Circuit, a system used to multiplex a number of subscriber loops onto a single circuit (usually a T1 circuit) to reduce fixed costs. 3) Also sometimes used generically for other brands of similar equipment. See also SLC- 96.

SPID- Service Profile Identifier On the “National ISDN”, “AT&T Custom PMP” and “Custom DMS” ISDN BRI protocols, the Telco switch must receive correct SPID(s) from the CPE before it will allow access to ISDN service. Intended to allow multiple configurations on ISDN lines shared among different types of CPE equipment. While your SPID may include your area code and telephone number, the SPID is distinct from the telephone number. For the National ISDN,

Custom PMP, and DMS custom ISDN protocols the equipment requires that the user to program SPIDs into it. Custom PTP and ETS 300 protocols do not require a SPID. No SPIDs are required for ISDN PRI protocols.

SS7 - Signaling System 7 The internationally adopted Common Channel Interactive Signaling (CCIS) system. Previous to SS7 the Bell System used SS6 which did not support the International Standards. SS7 does. It allows for substantially flexibility and power in dynamically routings calls. An SS7 database lookup is how a call to a mobile telephone user can handled transparently despite the fact that the user's location may change. Also used to determine what carrier should handle a given toll free call. See also CCIS.

Station Line A telephone circuit from a PBX to a telephone on that PBX. Since this is a telephone- to- switch connection it is considered to be a "line". See Line and Trunk

Station Side The user side of a PBX. The side of the switch that the telephones are attached. Also, occasionally called the 'line side'. The main reason for distinguishing between this and the trunk side is that certain customer related features (Such as Hold and Transfer) are inapplicable to trunks. See also Trunk Side.

Statistical Multiplexing A method of improving effective bandwidth of a Telco channel. Statistical Multiplexing takes advantage that there are typically many pauses in a conversation. By taking advantage of this fact, and not sending the pauses, improvements in efficiency can be made. Also referred to as silence suppression. See Circuit Switched.

Subscriber The customer of a Telecommunications company. This term dates back to when a local Telephone Company was formed at the specific request of a group of customers who agreed in advance to "subscribe" to the service.

Superframe See SF

Switch Telephone switching device which "makes the connection" when you place a call. Modern switches are specialized computers. ISDN service is provided from a "Digital" switch, most commonly (in the USA & Canada) an AT&T model "5ESS", Northern Telecom model "DMS-100", or Siemens model "EWSD". The switch, and related software running on it, will determine which ISDN protocol(s) will be available to customers connected to it. See also PBX.

Switch Type (ZephyrExpress) The utility menu item where the ISDN Protocol is selected. See Telco Setting and National ISDN.

Switched Circuit A channel which is not permanent in nature, but is connected through a switching device of some kind. The switching device allows a switched circuit to access many other switched circuits (the usual "dial up" type of telephone channels). Once the connection is made however, the complete capacity of the channel is available for use. As opposed to a dedicated circuit or a packet based connection.

Switched- 56 A type of digital telephone service developed in the mid 1980's which allows dialing on a single 56Kbps line. Each Switched- 56 circuit has 1 or 2 copper wire-pairs associated with it. You will need to know in advance if you will have the two- wire or four-wire version so you can procure the appropriate CSU/DSU. Switched- 56 is being rapidly replaced with ISDN, which is cheaper and more flexible. See also CSU/DSU.

Synchronous Data A form of serial data which uses a clock signal to synchronize the bit stream. Since, unlike asynchronous data, no start and stop bits are used, data throughput is higher than with asynchronous data. ISDN and T- 1 use Synchronous data. See also Asynchronous Data.

T- Link A proprietary Telos 2.048mbps channelized link. This link uses the DSX- 1 electrical protocol and has 30 channels at 64kbps each.

T1 A common type of digital telephone carrier widely deployed within the US, Canada, and Japan. Has 24 64Kbps channels (called DSØ's). The most common framing scheme for T1 "robs" bits for signaling leaving 56kbps per channel available for data use.

T-1 An alternative expression for T1. See T1.

TA - Terminal Adaptor. The electronic interface between an ISDN device and the NT1. The terminal adapter handles the dialing functions and interfaces to the user's data equipment as well as to the NT1 on the "S" or "T" interface.

Tandem Switch A switch which is between two others. It connects two trunks together. Long distance calls on a LEC line go through a long distance tandem that passes them through to the long distance provider's switch.

Tandem Tie Trunk Switching When a PBX switch allows a tie line call to dial out of the switch. For example, if switch "A" in Arkansas has a tie line to switch "B" in Boise, Boise could use the tie line to make calls from switch "A".

TD- Transmit Data Data coming from the DTE towards the DCE or network. Also, a light on a modem or CSU/DSU that lights to indicate presence of this signal.

TEI - Terminal Endpoint Identifier An OSI Layer 2 identifier used by an ISDN terminal to communicate with the serving CO. Most equipment uses a dynamic TEI assignment procedure

Telco- Telephone Company Your local telephone service provider. In the 21st century you generally have a choice of Telcos if you are a business in a major metropolitan area in the USA. Competition is coming to the Telecom industry around the world.

Telco Setting (Xstream, Zephyr, TWO, TWOx12) The menu selection where the ISDN protocol is selected. Choices are 'NatI I- 1' (for National ISDN), 'DMS Cust', (for DMS-100 Custom Functional ISDN), 'AT&T Cust' or 'PTP' (for AT&T Custom Point- to- Point), 'INS 64' (for Japanese ISDN) and 'ETS300' (for Euro- ISDN).

Telcordia Technologies Formerly Bellcore. The research and development organization owned by the telephone companies. Telcordia represents the phone companies in developing standards for Telco equipment and in testing equipment compliance to those standards. Promotes competition and compatibility through standards promoting interoperability such as GR- 303. Telcordia also offers educational and training programs open to all interested parties. Bellcore was sold to SAIC in 1997. Telcordia is responsive to both RBOCs and independent Telcos. Their web site is: <http://www.telcordia.com> . See GR- 303

Telephone Number See DN and MSN

Telos Customer Support +1 216.241.7225. Generally available from 9am to 6pm EST, but you can try at other times. You may also ask for assistance by emailing to support@telos-systems.com

Telos Test Line (Xstream, Zephyr & ZephyrExpress) 24 Hour test line which can be called to verify correct operation of your Zephyr or ZephyrExpress codec. Numbers are +1 216- 781- 9310 and +1 216- 781- 9311. The test line transmits in dual/mono mode at 32kHz and can be received in L3 Mono using one B channel or L3 Stereo using 2 B channels. Telos also maintains an identically configured test line in Freising, Germany at 49 81 61 42 061 (dial this number twice).

Terminal Adapter See TA

Tie Line See Tie Trunk.

Tie trunk A Trunk between two PBXs. Note, a tie line is a dedicated circuit, not a switched circuit. See Trunk.

TR- 008 See SLC- 96

Trouble Ticket A Telco "work order" used to track Customer Repairs within the Telco. If you call someone "inside" the Telco's repair department, they will need this number to proceed. It will also be needed whenever you call to check on the status of a repair. Always ask for this number when initiating a repair request.

Trunk A communications path between two switching systems. Note that many trunks may be on a single circuit (if that circuit has multiple channels). The trunks most users will deal with are between the Telco switch and a PBX. However, a Tie Trunk can connect two PBXs. See also Tie Trunk and Trunk Group

Trunk Group A number of telephone channels which are functionally related. Most common is the Hunt Group. Other common types include Incoming Trunk Groups and Outgoing Trunk Groups. See also Combination Trunks and Two- way DID Trunks.

Trunk Side 1) The side of a central office that faces the network. Historically many CO switches could not make trunk to trunk connections (as opposed to tandem and long distance switches, that are always used to connect trunk together). Hence the need to distinguish between the "line side" and the "trunk side" of the switch. See also Line Side.

2) The side of a PBX that connects to the Telco. Historically many PBXs could not make trunk to trunk connections. Hence the need to distinguish between the "line side" and the "trunk side" of the switch. Since a trunk is a switch- to- switch circuit, these circuits can be called trunks. Beware, even though you have a PBX, the Telco may still call these 'lines' (even though your PBX considers them trunks). See also Trunk and Line Side

Two- way DID trunk An ISDN PRI equipped for direct inward dialing. Most PBX trunks are related to a given phone number, either alone or as part of a hunt group. In the case of a "normal" (i.e. analog) DID Trunk, a group of phone numbers are associated with that DID trunk (or group of trunks) and incoming calls include the DID number, so the PBX can route that call to the correct DID extension. These are one- way (i.e. inward only) trunks. This is exactly how ISDN PRI functions, with the DID information coming in over the D channel. There is a big difference between a normal DID Trunk and a Two- way DID trunk over ISDN PRI. For one thing, ISDN PRI is digital. Another distinction is that you cannot dial out over a true DID trunk, while you can dial out over a PRI (hence the conflicting designation "Two Way Direct Inward Dialing Trunk").

Two Wire A circuit path where only a single pair of wires is used. A hybrid is used to convert from two wire to four wire circuits. No hybrid is perfect, and those used by the phone company can be poor. However, the hybrids in Telos TWO/2101 family are approaching perfection!

U Interface The interface between the ISDN "BRI" line and the "NT1". This can be considered the ISDN "phone jack" in the USA & Canada, and is frequently in the form of a RJ- 11 or RJ- 45 style telephone jack. The center 2 pins are used on these jacks.

V.35 A serial data interface/connector pin out for synchronous data. V.35 uses balanced signal and data lines. The Zephyr/Zephyr Xstream models 9X01, 9X00, support V.35 using part #9812 cable.

Variant The particular protocol (i.e. National ISDN- 1 or ETS 300) running on a specific switch. Not all variants are valid for a specific switch. The switch brand and model plus the variant defines the ISDN protocol. Applies to configuring the 2101. See ISDN Protocol.

Virtual ISDN An alternative to repeaters which uses a local Telco Switch to act as a repeater and which then sends the signal onto another switch which supports ISDN. See also Repeater.

Work Order See Trouble Ticket

X.21 A serial data interface for synchronous data popular in Europe. X.21 uses balanced data and unbalanced signal lines. The Zephyr models 9X01, and 9X00 support X.21 using part #9822 cable.

Yellow Alarm An alarm on a T- carrier circuit that is returned by the local equipment if it is in a Red Alarm state. A Red Alarm indicates a loss of inbound signal; a Yellow alarm indicates (indirectly) a loss of outbound signal. See Red Alarm, Blue Alarm and LOS.



USER'S MANUAL

INDEX

- AAC, 116
- AAC-LD, 120
- About, 108
- AC power (illustration), 37
- AC (mains) Requirements, 59
- Accessing the Hardware, 264
- AES Sync-In, 36
- AES/EBU
 - Detailed, 196
- AES/EBU Inputs & Outputs, 36
 - Rear Panel, 36
- Analog Inputs & Output (illustration & Pinouts), 33
- Ancillary Data
 - Constact Closures, 249
 - RS-232, 247
- Answers to frequently asked questions, 13
- Applications Guide
 - Choosing a Receive Mode, 179
 - Program Links, 177
 - Radio Remotes, 175
 - Voice-over applications, 174
- APPLICATIONS GUIDE, 167
- APT-X, 112
- audio coding, 111
- Audio Coding Refrence, 111
- Audio Menu, 61, 198
 - Detailed, 194
- Audio Menu (Mixer Version)
 - Guided Tour, 89
- Audio Menu (non-mixer version)
 - Guided Tour, 88
- Audiobahn, 301
- Auto Answer
 - Detailed, 223
 - Guided Tour, 104
- AUTO menu, 67, 242
- AUTO, DIAL, & DROP Keys, 22, 43
- Balance
 - Detailed, 200
 - Guided Tour, 91
- Basic Operation & Installation, 59
- Bit Rate
 - Guided Tour, 98
- Bit Rate (introduction), 79
- bit reservoir, 123
- Bitrate
 - Detailed, 213
- CASCADING, 126
- cascading coders, 126
- CCITT, 125
- Choosing the Best Coding Mode for Your Application, 128
- Clearing Memory
 - Restore factory Defaults, 110
- Codec Menu, 61
 - Guided Tour, 95
- CODEC Menu
 - Detailed, 203
- CODEC MENU
 - In Netcoder Mode, 317, 318
- Codec Settings: Transmit, Receive, Bit Rate, & Sample Rate, 78
- Codecs
 - Connecting to non-Telos Codecs. *See*
- Coding Method vs Fidelity
 - Quick Comparison, 172
- coding methods, 111
- Cold Boot. *See* Restore Factory Defaults
- Command Line Interface
 - Ethernet, 261
 - RS-232, 249
- Communications and Control Ports, 27
- Compatibility, 133
- Contrast, 108, 230
- Cooling Requirements, 59
- CSU/DSUs
 - Configuring, 165
- CSU's and DSU's, 160
- DEEP TECH INFORMATION & TROUBLESHOOTING, 263
- Delay
 - Mix Minus, 186
- Delay vs. Quality, 129
- Detailed Menu Reference, 189
- DIAL menu, 66, 240
- Dial Prefix

- Detailed, 227
- Guided Tour, 105
- Dial Setups
 - Activating a Dial Setup – Step by Step, 70
 - Creating Dial Setups – Step by step, 71
 - Editing, 72
 - Triggered by Closures, 244
 - When INterface is set to V.35, 244
- Digifon, 301
- Digital Data System
 - Using with V.35/X.21 Interface, 158
- Directory Numbers
 - Detailed, 221
 - Guided Tour, 103
 - Introduction, 138
- Drop menu, 67, 242
- DTMF
 - Detailed, 228
- dynamic range, 111
- EdNet, 302
- Enabling PS2 power, 266
- Entering Alphabetic Characters, 64
- Environmental Considerations, 59
- ETHERNET (NETCODER) MODE, 317
- Fast Access Menu Keys – AUDIO, CODEC, TEL, SYSTEM, 21
- filterbank, 113, 123
- Finding Public Codec User Lists, 301
- Fraunhofer, 124
- Front Panel (Non-mixer version), 19
- FTP Site, 233
- G.722, 112, 124, 125
- General Troubleshooting Techniques, 275
- GUIDED TOUR of the HARDWARE, 19
- Headphones 2 – 4, 56
- Hints & Ideas, 167
- HTML
 - Control via, 261
- Interface
 - Detailed, 224
 - Guided Tour, 105
- Introduction
 - Getting to Know the Xstream, 15
- Introduction to Audio Coding Technology, 111
- IP Settings, 230
- ISDN
 - Background, 135
 - Basic Rate Interface, 136
 - Can't get READY indication, 284
 - ETS-300 Order Form, 332
 - Order form for USA & Canada, 338
 - Ordering ISDN for the USA & Canada, 333
 - Protocol Setting, 222
 - Protocols, 142
 - Suggested Reading, 315
 - Telco Setting, 222
 - The Basics, 135
- ISDN Cause Codes, 303
- ISDN finding sites, 301
- ISDN Interface (illustration), 25, 45
- ISDN Status
 - Detailed, 286
 - When using built-in NT1, 288
- ISO/MPEG, 112
- Jacks and Connectors
 - Mixer Versions (MX/P), 44
 - non-mixer version, 24
- joint stereo, 123, 124
- Layer 2, 124, 127
- Layer 3, 112, 127
- LAYER 3, 122
- Lightning Protection, 60
- Local Monitor Mix 1 Jack & Volume Control, 38
- Local Monitor Mix 2 Outputs, 55
- Local Monitor Mix 2 Volume Controls, 39
- Location Setups, 73, 243
 - Editing, 76
- Location Setups – Set by Step
 - Creating Location Setups – Set by Step, 75
- Location Setups – Step by Step
 - Activating a Location Setup – Step by Step, 74
- Lock 1 & 2 LEDs, 41
- Long Distance Carriers
 - Troubleshooting, 289
- Long-Distance Digital Connectivity, 139, 337
- Loop mode, 234
- Loop Mode
 - Using for troubleshooting, 280
- Main Mixer Input Assign/Clip LEDs (illustration), 40
- Main Mixer Inputs, 54

masking, 112
 Menu System (introduction), 61
 Menu Tree, 83
 Menus
 Detailed Reference, 189
 Guided Tour, 83
 Meters and indicators, 40
 Mix-Minus, 186
 Mono-128, 124
 MPEG, 116
 MPEG LAYER 2, 124
multi-band compression, 114
 Multiple Codec Connections, 178
 multiple codecs, 126
 Multiple Subscriber numbers
 Detailed, 221
 Multiple Subscriber Numbers
 Guided Tour), 103
 Introduction, 138
Musicam, 124
 MX/MXP Front Panel (Mixer versions), 38
 MX/MXP Rear Panel (Mixer versions), 44
 Navigation and Menu Selection Keys, 21, 42
Netcoder Mode, 317
 NT1 U sync, 277
 NT1s, 141
 Numeric Keypad, 22, 42
 Ordering ISDN, 140
 Countries Using ETS 300, 329
 Pan
 Detailed, 199
 Guided Tour, 90
 Panic Dial, 244
 Parallel Control Port, 51
 Parellel Port Inputs
 Menus, 237
 Parellel Port Menus
 Outputs, 238
 perceptual coding, 111
 Perceptual Coding
 AAC-LD, 120
 Basic Principles, 112
 Cascading, 126
 Choosing the Best Coding Mode for Your
 Application, 128
 Choosing the Best Transmit Mode for your
 application (applications guide), 172
 G.722, 124
 Lossless, 112
 MPEG 2 AAC, 116
 MPEG-2 Layer 2, 124
 MPEG-2 Layer 3, 122
 Sample Rate, 132
 Phones and Remotes, 187
 Primary Menus; AUDIO, CODEC, TEL &
 SYS, 61
 Proc
 Detailed, 199
 Guided Tour, 90
 QoS (Quality of Service), 149
 QUICK RESULTS, 1
 Radio remotes, 175
 Rev Mix
 Guided Tour, 92
 Rear Panel (non-mixer version), 24
 Reboot, 109, 234
 Receive
 Guided Tour, 97
 Receive (introduction), 78
 Receive Bargraph, 21, 41
 Receive Lock, 277
 Receive Mix
 Detailed (MX/P only), 201
 Receive Mode
 Detailed, 210, 327
 Receiving in Ethernet Mode, 324
 redundancy, 123
 Remote Control, 249
 Restore Factory Defaults, 236
 RS232
 setting the bit rate, 230
 RS-232 (DCE) (illustration & Pinout), 47
 RS-232 (illustration), 27
 rs232 (setting the bit rate), 108
 RS-232 Port
 Remote Control via, 249
 S Interface (4 wire), 26
 S Interface (4 wire) for use worldwide, 46
 Sample Rate
 Detailed, 214

- Guided Tour, 99
- Sample Rate (introduction), 80
- SEDAT, 126, 127
- Send Bargraph, 20
- Setting the nominal input level range
 - (non-mixer only), 264, 265
- Software Updates, 267
- Special Menus; AUTO, DIAL, & DROP, 66
- Special Operational Modes
 - Ethernet Interface, 317
 - V.35 Single (high speed), 325
- SPECIFICATIONS, 295
- SPID Error, 217, 286
- SPIDs
 - Guided Tour, 102
 - Incorrect SPIDs, 217, 286
 - Introduction, 137
 - Known Working, 311
 - SPID Error, 217, 286
- statistical framing, 125
- Stereo vs Joint Stereo, 130
- Sub-assemblies
 - User Insallable, 266
- Suggested Reading, 315
- Switched 56
 - Introduction, 144
- SWITCHED 56
 - Connections, 156
- Sync, 276
- Sync LED, 20, 40
- System functions and Remote Control
 - Detailed, 247
- System Menu, 61
 - Guided Tour, 107
- SYSTEM Menu
 - Detailed, 229
- T1 Circuits
 - Using with the V.35/X.21 Interface, 157
- Tel Menu, 61
 - Guided Tour, 101
- TEL Menu
 - Detailed, 216
- Tel Status
 - Connected, 101
 - Ready, 101
 - When using Ethernet, 219
 - When using ISDN, 216
 - When using V.35, 218
- TEL Status Screen
 - Using to troubleshoot, 279
- Telco
 - Detailed, 222
- Telco Setting (ISDN Protocol)
 - Guide Tour, 104
- Test Lines
 - Phone numbers, v
- text entry, 22, 42, 64
- Transmit
 - Guided Tour, 96
- Transmit (introduction), 78
- Transmit Mode
 - Detailed, 204, 325
- Troubleshooting, 275
 - Audio, 281
 - Diagnostic Indicators, 276
 - Ethernet, 290
 - ISDN, 284
 - Long Distance Carrier, 289
 - Other Difficulties, 293
- TROUBLESHOOTING, 263
- U Interface (2 wire), 25, 45
- U Interface Sync LED, 25, 45
- Updating the Firmware, 267
- V.35
 - Control Leads, 165
 - Single Mode (high rates), 325
 - Single Port, 162
 - Two port operation, 163
- V.35 Interface
 - Single (high rate) operation, 225
 - Split operation, 224
- V.35 Single mode
 - Codec Menu, 325
- V.35/X.21 Interface
 - Cables, 161
 - Connections to the Interface, 159
- V.35/X.21 Interface Option, 27, 47, 145, 155, 267
- V.35/X.21 Interfaces
 - Uses for, 155
- V.35/X.21 Interrface

Installation, 155
Voice-over applications, 174
Volume, 230
Volume (front panel), 108

WARRANTY, 295, 298
Web Browser
 Control via, 261
Zephyr Remote, 262

Free Manuals Download Website

<http://myh66.com>

<http://usermanuals.us>

<http://www.somanuals.com>

<http://www.4manuals.cc>

<http://www.manual-lib.com>

<http://www.404manual.com>

<http://www.luxmanual.com>

<http://aubethermostatmanual.com>

Golf course search by state

<http://golfingnear.com>

Email search by domain

<http://emailbydomain.com>

Auto manuals search

<http://auto.somanuals.com>

TV manuals search

<http://tv.somanuals.com>