



**PHONECELL® SX4D GSM
DESKTOP PHONE**

**900 MHz VOICE MODEL
and
1800 MHz VOICE MODEL**

USER MANUAL

Digital call clarity and privacy at your fingertips

03/09/01

Part No. 56020401

PHONECELL® SX4D GSM
DESKTOP PHONE

900 MHz VOICE MODEL
and
1800 MHz VOICE MODEL

USER MANUAL

Introduction



Thank you for choosing the **Phonecell® SX4D GSM Desktop Phone** from Telular. This innovative product allows you to connect to a cellular network for voice communications flexibility.

Please follow this guide to unpack, set up and operate your new Phonecell® SX4D GSM Desktop Phone safely and properly.

*Telular is proud to welcome you as a valued customer.
Your satisfaction is our most important concern.*

**Telular Corporation
Corporate Headquarters
647 North Lakeview Parkway
Vernon Hills, Illinois 60061, USA**

TECHNICAL SUPPORT

Tel: 847-247-9400 · Fax: 847-247-0021

E-mail: mainoffice@telular.com · <http://www.telular.com>

Patents: Telular Corporation products are protected and manufactured under one or more of the following U.S. patents and related international patents and patents pending relating thereto: 4,658,096; 4,737,975; 4,775,997; 4,868,519; 4,922,517; 5,134,651; 5,361,297; 5,469,494; 5,046,085; 5,715,296; 5,812,637; 5,859,894; 5,946,616; 5,966,428; 6,035,220.

Trademarks: Telular Corporation owns the following registered trademarks: TELULAR, TELULAR plus design, CELJACK, PCSone, TELCEL, HEXAGON LOGO, PHONECELL, CELSERV, TELGUARD, and CPX.

**PLEASE SEE PAGES 7 and 8 FOR IMPORTANT
RESTRICTIONS ON USE, AS WELL AS, WARRANTY
AND INDEMNIFICATION**

Part No. **56020401**

©2001 Telular Corporation, all rights reserved.

SX4D GSM 900 · SX4D GSM 1800

2

USER MANUAL

Table of Contents

| | |
|---|----|
| Introduction | 2 |
| Technical Support..... | 2 |
| Safety Information | 4 |
| Important Notices | 7 |
| Getting Started | 9 |
| Unpacking Your Phonecell SX4D | 9 |
| Pre-Installation Checklist..... | 9 |
| Installation Summary | 10 |
| Step 1. Antenna Setup | 11 |
| Antenna Setup | 11 |
| Antenna Tips..... | 11 |
| Step 2. Connect Phonecell SX4D to AC Power | 12 |
| Step 3. SIM Card Installation and Setup | 13 |
| SIM PIN Programming | 14 |
| Step 4. Determine Phonecell SX4D Location | 16 |
| Step 5. Wall-Mount Installation | 17 |
| Wall-Mount Instructions..... | 17 |
| Phonecell SX4D Operation | 18 |
| LCD Display | 18 |
| Phonecell SX4D Power Mode | 19 |
| Phonecell SX4D Normal Mode | 19 |
| Phonecell SX4D Controls..... | 22 |
| How to Place a Call..... | 23 |
| How to Receive a Call..... | 23 |
| How to End a Call | 23 |
| Hookflash Function..... | 23 |
| Important Tones and Alerts..... | 23 |
| Variable Dial Time (<i>Auto SEND Delay</i>) Option..... | 24 |
| Zero Dial Delay for Frequently Called Numbers | 24 |
| Mobile Equipment Personalization (MEP)..... | 24 |
| Three-Digit Dialing..... | 24 |
| Using Supplementary Services | 24 |
| Phonecell SX4D Troubleshooting | 29 |
| Phonecell SX4D Programming | 30 |
| Phonecell SX4D Programming Mode Overview | 30 |
| Phonecell SX4D User-Programming Commands | 31 |
| Phonecell SX4D Technician-Programming Commands | 32 |

Safety Information

IMPORTANT!

To ensure safe and efficient operation, please read the following information and observe these guidelines whenever using your Phonecell SX4D.



Your **Phonecell SX4D GSM 900 and SX4D GSM 1800 Desktop Phones** function as both a radio transmitter and receiver. When it is ON, the Desktop Phone receives and sends out radio frequency (RF) energy. The **GSM 900** unit operates in the frequency range between 890 and 960 MHz, and the **GSM 1800** between 1710 MHz and 1880 MHz. Both employ commonly used phase/frequency modulation techniques. When you use your **Phonecell SX4D Desktop Phone**, the cellular system handling your call controls the power level at which your unit transmits. Nominal power output for the GSM 900 unit is **2 watts** and for the GSM 1800 unit is **1 watt**.

Exposure to RF (Radio Frequency) Energy

In 1991, the Institute of Electrical and Electronics Engineers (*IEEE*), and in 1992, the American National Standards Institute (*ANSI*), updated the 1982 ANSI Standard for safety levels with respect to human exposure to RF energy. After reviewing the available body of research, more than 120 scientists, engineers and physicians from universities, government health agencies and industry developed this updated Standard. In March, 1993, the U.S. Federal Communications Commission (*FCC*) proposed the adoption of this updated Standard.

The design of your Telular Phonecell SX4D complies with this updated Standard. Of course, if you want to limit RF exposure even further than the updated ANSI Standard, you may choose to control the duration of your calls and operate your phone in the most power-efficient manner.

Safe Operation Requirement

Do not operate your Phonecell SX4D when any person is within 1 inch (2,5 cm) of the antenna.

Temperature Environment

Operating Temperature: From -10°C (14°F) to +50°C (122°F);
Up to 95% relative humidity (non-condensing)

Storage Temperature: From -20°C (-4°F) to +60°C (140°F);
Up to 95% relative humidity (non-condensing)



WARNING!

Your Phonecell SX4D must be placed or mounted on a flat surface to allow proper ventilation. Do not block the air vents or the space beneath your Phonecell SX4D as this could cause the unit to overheat and fail.

Safety Information - continued



Antenna Care and Replacement

Do not use the Phonecell SX4D with a damaged antenna. If a damaged antenna comes into contact with the skin, a minor burn may result. Have your antenna replaced by a qualified technician immediately. Use only a manufacturer-approved antenna. Unauthorized antennas, modifications, or attachments could damage the Phonecell SX4D.

Driving



Check the laws and regulations on the use of cellular products in the areas where you drive. Some jurisdictions prohibit your using a cellular device while driving a vehicle. Even if your jurisdiction does not have such a law, we strongly suggest that, for safety reasons, the driver use extreme caution when operating the cellular device while the vehicle is in motion. Always obey the law.

Electronic Devices

Most modern electronic equipment is shielded from RF energy. However, RF energy from cellular devices may affect inadequately shielded electronic equipment.

RF energy may affect improperly installed or inadequately shielded electronic operating and entertainment systems in motor vehicles. Check with the manufacturer or its representative to determine if these systems are adequately shielded from external RF energy. You should also check with the manufacturer of any equipment that has been added to your vehicle.

Consult the manufacturer of any personal medical devices (*such as pacemakers, hearing aids, etc.*) to determine if they are adequately shielded from external RF energy.

Turn your Phonecell SX4D OFF in health care facilities when any regulations posted in the areas instruct you to do so. Hospitals or health care facilities may be using equipment that could be sensitive to external RF energy.

Aircraft



Turn OFF your Phonecell SX4D before boarding any aircraft.

- Use it on the ground only with crew permission.
- Do not use it in the air.

To prevent possible interference with aircraft systems, U.S. Federal Aviation Administration (*FAA*) regulations require you to have permission from a crew member to use your cellular phone (*or any other cellular product*) while the plane is on the ground. To prevent interference with aircraft systems, FCC regulations prohibit using your cellular device while the plane is in the air.

Children

Do not allow children to play with your Phonecell SX4D to prevent damage to the unit.

Blasting Areas

Construction crews often use remote control RF devices to set off explosives. Therefore, to avoid interfering with blasting operations, turn your Phonecell SX4D OFF when in a "blasting area" or in areas posted: "Turn off two-way radio."

Safety Information - continued

Potentially Explosive Atmospheres



Turn your Phonecell SX4D OFF when in any area with a potentially explosive atmosphere. It is rare, but your Phonecell SX4D or its accessories could generate sparks. Sparks in such areas could cause an explosion or fire resulting in bodily injury or even death.

Areas with a potentially explosive atmosphere are often, but not always, clearly marked. They include fueling areas such as gas stations; below deck on boats; fuel or chemical transfer or storage facilities; areas where the air contains chemicals or particles, such as grain, dust, or metal powders; and any other area where you would normally be advised to turn off your vehicle engine.

Do not transport or store flammable gas, liquid or explosives in the area of your Phonecell or accessories.

Vehicles using liquefied petroleum gas (such as propane or butane) must comply with the National Fire Protection Standard (FPA-58). For a copy of this standard, contact the National Fire Protection Association, One Batterymarch Park, Quincy, MA 02269, Attn: Publications Sales Division.

FCC Part 15 Class B Compliance

The **Phonecell SX4D GSM 900** and **GSM 1800** models have been tested and found to comply with the limits for a Class B digital device, pursuant to Part 15 of the FCC rules. These limits are designed to provide reasonable protection against harmful interference in a residential installation. This equipment generates, uses and can radiate radio frequency energy and, if not installed and used in accordance with the instructions, may cause harmful interference to radio communications. However, there is no guarantee that interference will not occur in a particular installation. If this equipment does cause harmful interference to radio or television reception, which can be determined by turning the equipment OFF and ON, the user is encouraged to try to correct the interference by one or more of the following measures:

- Reorient or relocate the antenna.
- Increase the separation between the equipment and the terminal.
- Connect the equipment into an outlet on a circuit different from that to which the terminal is connected.
- Consult your Authorized Telular Distributor or an experienced radio/TV technician for help.

GSM Type Acceptance

The cellular mobile radio, known as TC-2101 and located inside the **Phonecell SX4D GSM 900** model, has GSM Type Acceptance BAPT/98/6270, dated 14 October 98. The **Phonecell SX4D GSM 900** operates on 900 MHz GSM networks.

The cellular mobile radio, known as TC-2201 and located inside the **Phonecell SX4D GSM 1800** model, has GSM Type Acceptance BAPT/NC/000005, dated 18 May 2000. The **Phonecell SX4D GSM 1800** operates on 1800 MHz GSM networks.

Important Notices

TERMS AND CONDITIONS FOR USE OF PHONECELL® PRODUCTS ("Product")

These Terms and Conditions are a legal contract between you and Telular Corporation for the title to and use of the Product. BY RETAINING AND USING THE PRODUCT AFTER RECEIPT OF IT, YOU AGREE TO THE TERMS AND CONDITIONS INCLUDING WARRANTY DISCLAIMERS, LIMITATIONS OF LIABILITY AND INDEMNIFICATION PROVISIONS BELOW. IF YOU DO NOT AGREE TO THE TERMS AND CONDITIONS, DO NOT USE THE PRODUCT AND IMMEDIATELY RETURN THE UNUSED PRODUCT FOR A COMPLETE REFUND. You agree to accept sole responsibility for any misuse of the Product by you; and, in addition, any negligent or illegal act or omission of your or your agents, contractors, servants, employees, or other users of the Product so long as the Product was obtained from you, in the use and operation of the Product.

INDEMNIFICATION OF TELULAR CORPORATION ("TELULAR")

YOU SHALL INDEMNIFY, DEFEND AND HOLD HARMLESS TELULAR FOR ANY OF THE COST, INCLUDING REASONABLE ATTORNEYS' FEES, AND FROM CLAIMS ARISING OUT OF YOU, YOUR CLIENTS' OR OTHER THIRD PARTIES' USE OR OPERATION OF THE PRODUCT: (i) FOR MISUSE OR IN A MANNER NOT CONTEMPLATED BY YOU AND TELULAR OR INCONSISTENT WITH THE PROVISIONS OF THIS MANUAL; (ii) IN AN ILLEGAL MANNER OR AGAINST PUBLIC POLICY; (iii) IN A MANNER SPECIFICALLY UNAUTHORIZED IN THIS MANUAL; (iv) IN A MANNER HARMFUL OR DANGEROUS TO THIRD PARTIES; (v) FROM CLAIMS BY ANYONE RESPECTING PROBLEMS, ERRORS OR MISTAKES OF THE PRODUCT; OR (vi) COMBINATION OF THE PRODUCT WITH MATERIAL, MODIFICATION OF THE PRODUCT OR USE OF THE PRODUCT IN AN ENVIRONMENT NOT PROVIDED, OR PERMITTED, BY TELULAR IN WRITING. THE PARTIES SHALL GIVE EACH OTHER PROMPT NOTICE OF ANY SUCH COST OR CLAIMS AND COOPERATE, EACH WITH THE OTHER, TO EFFECTUATE THIS INDEMNIFICATION, DEFENSE AND HOLD HARMLESS.

WARRANTY

I. WHAT THIS WARRANTY COVERS AND FOR HOW LONG:

TELULAR CORPORATION ("Telular") warrants to a distributor Buyer, or to a customer only if the customer is a Buyer directly from Telular, that the Products (including accessories) shall comply with the applicable Specifications and shall be free from defects in material and workmanship under normal use and service for a period of fifteen (15) months from date of shipment from Telular. Telular, at its option, shall at no charge either repair, replace or refund the purchase price of the Product during the warranty period, provided it is returned by Buyer in accordance with the terms of this warranty to the Telular designated repair center. Repair or replacement, at Telular's option, may include the replacement of parts, boards or Products with functionally equivalent reconditioned items. Repaired and replacement items are warranted for the balance of the original warranty period. All replaced items shall become the property of Telular. **SUCH ACTION ON THE PART OF TELULAR SHALL BE THE FULL EXTENT OF TELULAR'S LIABILITY HEREUNDER, AND BUYERS EXCLUSIVE REMEDY.** Buyer shall be responsible for all costs and expenses incurred by Buyer including without limitation any handling, labor or transportation charges. **OTHER THAN AFORESAID, THIS EXPRESS WARRANTY IS EXTENDED BY TELULAR TO BUYER ONLY AND NOT TO BUYER'S CUSTOMERS OR USERS OF BUYER'S PRODUCTS.**

II. HOW TO OBTAIN WARRANTY SERVICE

Product covered under this warranty shall only be accepted from and returned to Buyer's designated repair center. Buyer's dealers, distributors, agents, and end users cannot submit items to Telular under this warranty. To receive warranty service an RMA number must first be obtained from Telular Technical Support. The defective or non-compliant Product should be sent by Buyer freight pre-paid to: Telular Corporation, 647 North Lakeview Parkway, Vernon Hills, IL 60061, USA or other designated location. The product must be packaged in the original carton and packing material or an equivalent package and must have the assigned RMA number clearly marked on the carton. Returned Product received without an RMA number will be returned to the sender.

III. WARRANTY CONDITIONS:

This is the complete warranty for the Products manufactured by Telular and sold to Buyer. Telular assumes no obligation or liability for additions or modifications to this warranty unless made in writing and signed by an officer of Telular. Unless made in separate written agreement between Telular and Buyer, Telular does not warrant the installation, field maintenance or service of the Products or parts.

Important Notices - continued

TELULAR CANNOT BE RESPONSIBLE IN ANY WAY FOR ANY ANCILLARY EQUIPMENT NOT FURNISHED BY TELULAR WHICH IS ATTACHED TO OR USED IN CONNECTION WITH THE PRODUCTS OR FOR OPERATION OF THE PRODUCTS WITH ANY ANCILLARY EQUIPMENT AND ALL SUCH EQUIPMENT IS EXPRESSLY EXCLUDED FROM THIS WARRANTY. FURTHERMORE, TELULAR CANNOT BE RESPONSIBLE FOR ANY DAMAGE TO THE PRODUCTS RESULTING FROM THE USE OF ANCILLARY EQUIPMENT NOT FURNISHED BY TELULAR FOR USE WITH THE PRODUCTS.

WHEN THE PRODUCT IS USED IN CONJUNCTION WITH ANCILLARY OR PERIPHERAL EQUIPMENT NOT MANUFACTURED BY TELULAR, TELULAR DOES NOT WARRANT THE OPERATION OF THE PRODUCT/PERIPHERAL COMBINATION, AND TELULAR SHALL HONOR NO WARRANTY CLAIM WHERE THE PRODUCT IS USED IN SUCH A COMBINATION AND IT IS DETERMINED BY TELULAR THAT THERE IS NO FAULT WITH THE PRODUCT. TELULAR DISCLAIMS LIABILITY FOR RANGE, COVERAGE, AVAILABILITY, OR OPERATION OF THE CELLULAR SYSTEM WHICH IS PROVIDED BY THE CARRIER.

IV. WHAT THIS WARRANTY DOES NOT COVER:

(a) Subsequent upgrades and enhancements to the Product. (b) Defects, non-compliance or damage resulting from use of the Product in other than its normal and customary manner or environment. (c) Defects, non-compliance or damage from misuse, lightening, accident or neglect. (d) Defects, non-compliance or damage from improper testing, operation, maintenance, installation, adjustment, or any alteration or modification of any kind. (e) Product disassembled or repaired in such a manner as to adversely affect performance or prevent adequate inspection and testing to verify any warranty claim. (f) Product which has had the serial number removed or made illegible. (g) Defects, non-compliance or damage due to spills of food or liquid. (h) All plastic surfaces and all other externally exposed parts that are scratched or damaged due to customer normal use. (i) Costs and expenses, including without limitation handling, labor and transportation, incurred in returning Product for warranty service to Telular's Repair Center. (j) Repair, programming or servicing by someone other than Telular.

V. GENERAL PROVISIONS:

THIS WARRANTY IS GIVEN IN LIEU OF ALL OTHER EXPRESS OR STATUTORY WARRANTIES. IMPLIED WARRANTIES, INCLUDING WITHOUT LIMITATION IMPLIED WARRANTIES OF MERCHANTABILITY, FITNESS FOR A PARTICULAR PURPOSE, TITLE, INFRINGEMENT, DELIVERY, NEGLIGENCE AND PERSONAL INJURY, ARE DISCLAIMED. FURTHER, AS THE CELLULAR CARRIER IS NOT CONTROLLED BY TELULAR, NO WARRANTY IS MADE AS TO COVERAGE, AVAILABILITY OR GRADE OF SERVICE PROVIDED BY THE CELLULAR CARRIER. IN NO EVENT SHALL TELULAR BE LIABLE FOR DAMAGES IN EXCESS OF THE PURCHASE PRICE OF THE PRODUCT, FOR ANY LOSS OF USE, LOSS OF TIME, INCONVENIENCE, COMMERCIAL LOSS, LOST PROFITS OR SAVINGS OR OTHER INCIDENTAL, SPECIAL OR CONSEQUENTIAL DAMAGES ARISING OUT OF THE USE OR INABILITY TO USE SUCH PRODUCT TO THE FULL EXTENT SUCH MAY BE DISCLAIMED BY LAW. SOME JURISDICTIONS DO NOT ALLOW THE EXCLUSION OR LIMITATIONS OF INCIDENTAL OR CONSEQUENTIAL DAMAGES OR LIMITATION ON HOW LONG AN IMPLIED WARRANTY LASTS.

VI. SOFTWARE PROVISIONS:

Laws in the United States and other countries preserve for Telular certain exclusive rights for copyrighted Telular software such as the exclusive rights to reproduce in copies and distribute copies of such Telular software. Telular software may be copied into, used in and redistributed with only the Product associated with such Telular software. No other use, including without limitation, disassembly of such Telular software or exercise of exclusive rights in such Telular software is permitted and Telular reserves all rights not expressly granted in this Limited Commercial Warranty.

Getting Started...

Un-Packing Your Phonecell SX4D

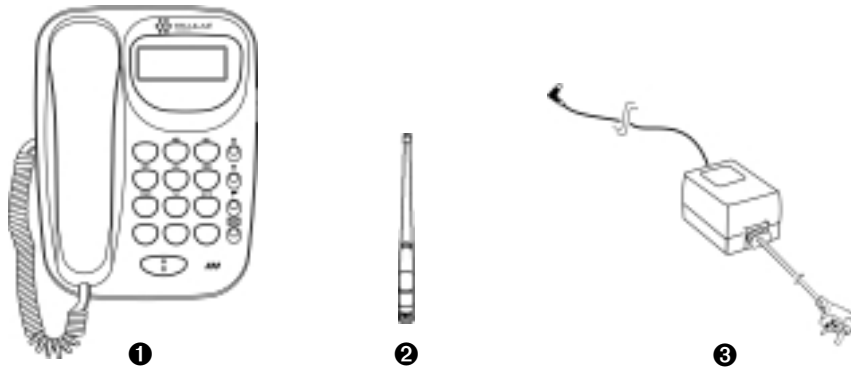

The **Phonecell SX4D GSM 900** and **SX4D GSM 1800** come with the following:

- ❶ Phonecell SX4D Desktop Phone
- ❷ Antenna
- ❸ 6 VDC Power Supply (AC-to-DC)

Carefully remove the unit from the shipping carton and check for evidence of shipping damage. **If damage is found, contact your Authorized Telular Distributor or shipping agent immediately.**

Pre-Installation Checklist

Before attempting **Phonecell SX4D** installation, make sure you have the following components, tools and materials.

Additional Components Needed

| Qty. | Description | Supplied | Not Supplied |
|------|--|----------|--------------|
| 1 | Mini-SIM (<i>Subscriber ID Module</i>) Card* | | ✓ |

*Supplied by your Network Service Provider

Tools & Materials Needed – for Wall-Mount Installation Only

| Qty. | Description | Supplied | Not Supplied |
|------|-----------------------------------|----------|--------------|
| 1 | Drill & Drill Bit | | ✓ |
| 1 | Screwdriver | | ✓ |
| 2 | 1½-inch (3.75 cm) Mounting Screws | | ✓ |

Optional Components

| Qty. | Description | Supplied | Not Supplied |
|------|---|----------|--------------|
| 6 | AAA Alkaline Batteries (<i>The Phonecell SX4D does not support Rechargeable Batteries</i>) | | ✓ |

Installation Summary

The following steps summarize the installation of the **Phonocell SX4D**. These steps are explained in detail in the remainder of this manual.

Step 1. Antenna Setup (page 11)

- Connect the antenna. Finger-tighten the antenna; do not overtighten.

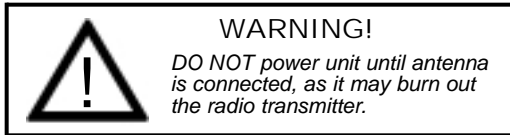

Step 2. Connect the Phonocell SX4D to AC Power (page 12)

- Connect the DC barrel connector of the power supply to the rear panel receptacle of the Phonocell SX4D.
- Then, connect the wall 6 VDC power supply to AC power.

NOTE: If your **Phonocell SX4D** did not come with a pre-installed mini-SIM (*Subscriber Identity Module*) card, you need to perform the SIM Card Installation and Setup procedure in Step 3. Then, return to this Step 2.

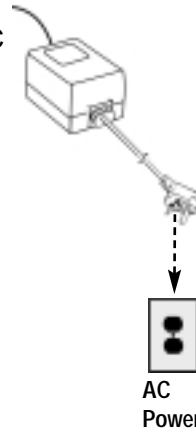

Step 3. SIM Card Installation & Setup (pages 13 - 15)

- If your Phonocell did not come with a pre-installed mini-SIM card, you need to perform the SIM Card Installation and SIM PIN Setup.
- **Otherwise, continue to Step 4.**

Step 4. Determine Phonocell SX4D Location (page 16)

- Determine the desired location for the Phonocell SX4D.

Step 5. Optional Wall-Mount Installation (page 17)

- The Phonocell SX4D may be mounted on a wall. After you have selected a location and made the necessary connections, your Phonocell SX4D is ready for wall-mounting.



Step 1. Antenna Setup

The **Phonocell SX4D** comes with an antenna. However, your coverage area may require a higher-gain antenna for optimal call clarity and performance. The Phonocell SX4D is compatible with a variety of antenna options, including magnetic-mount and Yagi models – *not supplied*.

Your Phonocell receives operating commands from the cellular network and relies upon signal strength for proper operation. Therefore, finding an antenna location with good signal strength is critical for optimal call clarity. After you choose a good location, connect the antenna, test the signal strength and adjust the location accordingly.

Antenna Setup:

Connect the antenna to the TNC antenna connector on the rear panel of the Phonocell SX4D - *see Figure 1*.

Antenna Tips:

- Locate the antenna above ground and as close to windows (or exterior walls) as possible - *see Figure 2*.
- Standard, magnetic-mount and elevated feed antennas must always point directly upward.
- Yagi antennas must be directed toward the service provider's nearest cellular tower.
- Keep antenna cable as short as possible – long cables may reduce call quality.
- Never splice antenna cable.

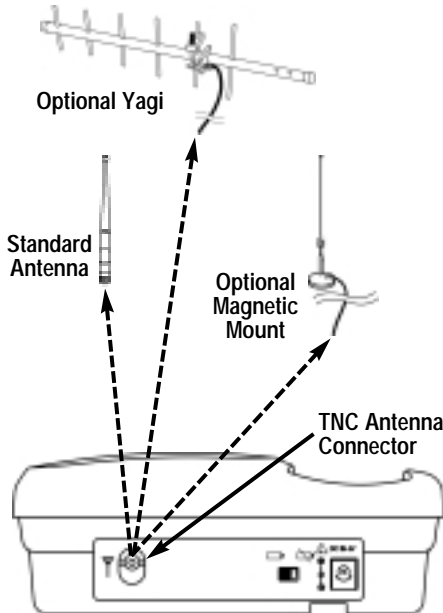

Figure 1 – Phonocell SX4D antenna options.

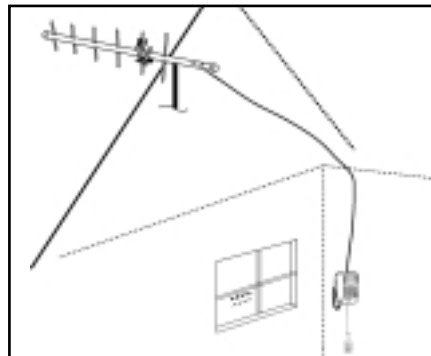
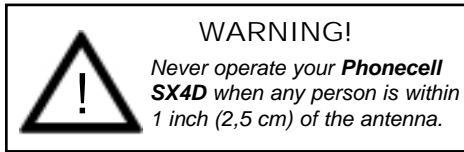

Figure 2 – Optional Yagi antenna installed on the building's exterior. Be sure to direct the antenna toward your service provider's nearest cellular tower.

Step 2. Connect Phonecell SX4D to AC Power

- 1) Connect the DC barrel connector of the 6 VDC Power Supply to the rear panel receptacle of the Phonecell SX4D - **see Figure 3.**



- 2) Plug the 6 VDC power supply into the AC socket - **see Figure 4.**

Wait for the unit to acquire service - **see the Phonecell SX4D Operation section of this manual.**

Emergency Battery Backup

The Phonecell SX4D can accommodate six (6) standard AAA alkaline batteries (not supplied) for operation when AC power is not available. To install batteries, set the unit upside down, remove the screw to the battery access door, press the battery access door tab and remove the battery access door. Install the batteries and reinstall the battery access door - **see Figure 9.**

A switch is used to select either AC or internal battery operation - **see Figure 17.** When the battery operation is selected, the Phonecell SX4D will operate for approximately 10 minutes of talk time with fresh batteries.

NOTE: The Phonecell SX4D does not support rechargeable AAA batteries.

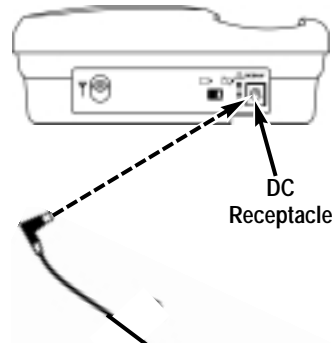

Figure 3 – Wall 6 VDC, 3-wire power supply DC connection.

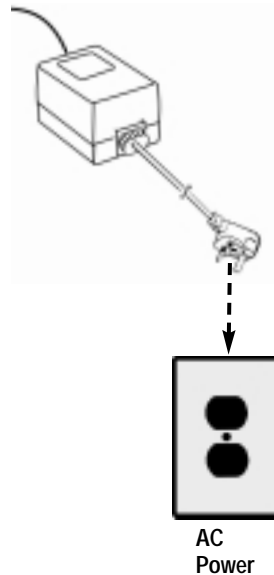

Figure 4 – 6 VDC power supply connection to AC power.

Step 3. SIM Card Installation and Setup

IMPORTANT!

If your **Phonecell SX4D** did NOT come with a pre-installed mini-SIM (*Subscriber Identity Module*) card, OR if you're experiencing SIM card-related problems, follow the steps below. **Otherwise, continue with STEP 5.**

How to Install the Mini-SIM Card

The GSM module within the Phonecell SX4D requires a Subscriber Identification Module (*SIM*) for normal operation. The service provider supplies a SIM card, which carries the account information needed to operate the Phonecell. The mini-SIM compartment is on the back of the Phonecell - see **Figure 5**.

NOTE: If your mini-SIM card is already installed, skip to the SIM PIN Programming section on page 14. If you don't have a mini-SIM card, contact your network service provider.

- 1) Remove the 6 VDC power supply.
- 2) Remove the SIM compartment cover by removing the screw - see **Figure 6**.
- 3) Open the SIM compartment holder.
- 4) Line up the mini-SIM card with the arrow on the SIM card holder.
- 5) Gently insert the mini-SIM card in the slot of the SIM card holder - see **Figure 6**.
- 6) Close the SIM card holder.
NOTE: If you insert the SIM card improperly, the holder will not close. Do not force the holder shut. Make sure the SIM card is aligned properly with the directional arrow on the holder.
- 7) Reattach the SIM compartment cover with the screw.
- 8) Attach the 6 VDC power supply.
- 9) Proceed with SIM PIN Programming.

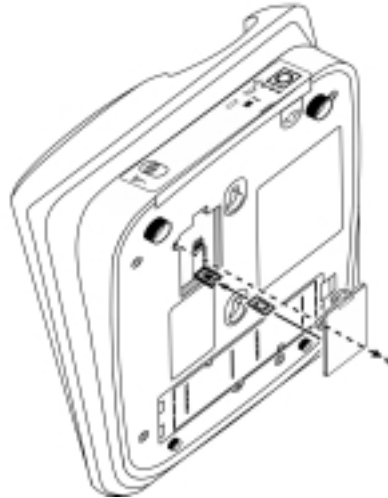

Figure 5 – Mini-SIM Compartment.

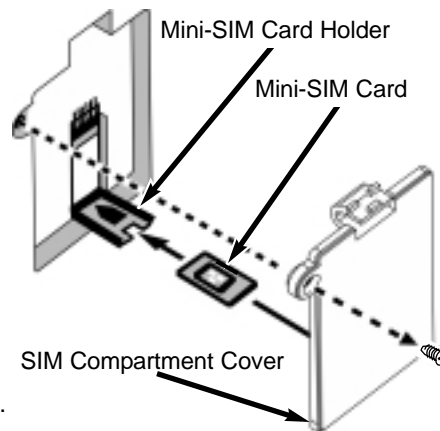

Figure 6 – Mini-SIM Card Installation.

SIM PIN Programming

The mini-SIM may require entry of a Personal Identification Number (*PIN*). The PIN is a four- to eight-digit number provided with the SIM card. If the service provider has set the SIM to require PIN entry, the Phonecell will request the PIN each time it is powered ON or the SIM is removed and replaced. The PIN can be stored within the Phonecell for automatic entry when required. To use the automatic PIN entry feature, the PIN must be correctly programmed and automatic PIN entry must be enabled.

If PIN entry is requested while automatic PIN entry is disabled, the Phonecell SX4D emits a non-registered service tone. The SIM PIN can be manually entered at that time:

Press: **<4-digit SIM number> #**

If entry is successful, the non-registered service tone will be replaced by service dial tone.

IMPORTANT!

You must enter the PIN correctly. After three attempts to load an incorrect PIN, the SIM will be blocked and the SIM card will have to be unblocked. If you do not have the unblocking key, the SIM will have to be returned to the service provider for reactivation. **See *How to Unblock a SIM PIN to unblock a SIM card*.**

How to Set a New PIN in the SIM

REMINDER: Automatic PIN entry must be disabled - *before and while the SIM PIN is changed* - until programming of the new PIN and Auto PIN Entry (see previous page) is completed.

- 1) Lift up the handset (*take off-hook*).
- 2) Press: * * 04 * <old_PIN> * <new PIN> * <new PIN> #

NOTE: You must know the old PIN to change it and the new PIN must be 4 to 8 digits (0 – 9) in length.

- 3) Incorrect entry of the old PIN will be indicated by a short, three tone sequence of rising frequencies. Hang up the handset and start over at step 1 with the correct old PIN.

Incorrect length (less than 4 or more than 8 digits) of the new PIN or not entering the same value in both new PIN entries will result in silence. Hang up the telephone handset and start over at step1.

Correct entry will be confirmed by a short beep. Hang up the handset.

*For Example: To set up a new SIM with PIN "5678", where the old PIN is "1234," dial: * * 04 * 1 2 3 4 * 5 6 7 8 * 5 6 7 8 #*

NOTE: In case of PIN2, substitute the following step 2:

SIM PIN Programming - continued

2) Press: * * 042 * <old_PIN2> * <new PIN2> * <new PIN2> #



NOTE: You must know the old PIN2 to change it and the new PIN2 must be 4 to 8 digits (0 – 9) in length.

*For Example: To set up a new SIM with PIN2 "5678", where the old PIN2 is "1234," dial: * * 042 * 1 2 3 4 * 5 6 7 8 * 5 6 7 8 #*

NOTE: This procedure will change the PIN encoded on the SIM. It will not change the PIN stored in the Phonenumber SX4D for automatic entry of the PIN when requested by the GSM module. (See previous page for instructions on how to enter the auto-entry PIN value).

How to Unblock a SIM PIN

Use the following key sequence to unblock a SIM card:

- 1)  Press: * * 05 * <PIN unblocking key> * <new PIN> * <new PIN>
- 2)  Press: * * 052 * <PIN2 unblocking key> * <new PIN2> * <new PIN2>

NOTE: This procedure will change the PIN encoded on the SIM. It will not change the PIN stored in the Phonenumber SX4D for automatic entry of the PIN when requested by the GSM module. (See previous page for instructions on how to enter the auto-entry PIN value).

Enter Automatic PIN Entry Option

The following key sequence is used to enable or disable the automatic PIN entry:

Label: ENABLE AUTO PIN
Data: <auto_PIN> * <PIN>

The auto PIN value is set to **0** to disable automatic PIN entry; set to **1** to enable automatic PIN entry. If the auto PIN value is neither **0** nor **1**, it is considered invalid. The factory default value is **0** (disabled). The factory default setting for the PIN is "1234".

Enter PIN For Automatic PIN Entry

The following key sequence is used to change the SIM PIN for automatic PIN entry:

Label: CHANGE AUTO PIN
Data: <old_PIN> * <new_PIN>

The factory default setting for the PIN is "1234". The new SIM PIN is supplied by the service provider with a new SIM.

NOTE: This command does not change the PIN encoded on the SIM by the service provider. It only changes the PIN supplied for automatic PIN entry by the FWT to match that encoded on the SIM. See the *SIM Card Installation and Setup* section of this manual for instructions to change the PINs encoded on the SIM.

Step 4. Determine Phonecell SX4D Location

The Phonecell SX4D operates using the existing cellular network and relies upon the cellular signal for proper operation. It is highly recommended that you place the unit in a location with a strong cellular signal. The strength and quality of the cellular signal is one of the most important factors in achieving high-quality telephone communications.

The Phonecell SX4D will usually be placed on a desk or table, but may be hung on a wall if that is more convenient for the user. For best results, the unit should be mounted near a window or on an exterior wall - *see Figure 7 and Figure 8.*

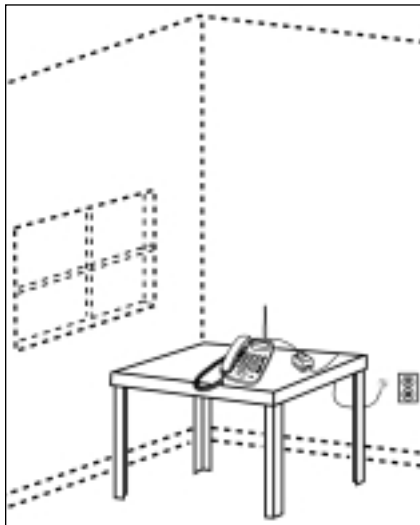

Figure 7 – Phonecell SX4D placed on a flat surface (desk/table). For best results, the antenna should be pointed up and the Phonecell SX4D should be placed near a window (*or exterior walls*).

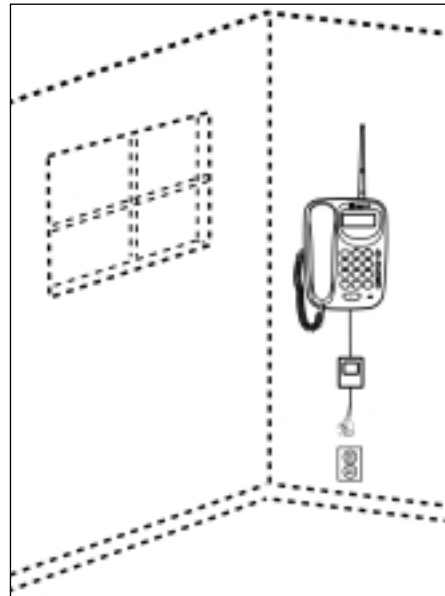

Figure 8 – Phonecell SX4D mounted on a wall. For best results, the antenna should be pointed up and the Phonecell SX4D should be placed near a window (*or exterior walls*).

Step 5. Optional Wall-Mount Installation

Your Phonecell SX4D may be mounted on a wall. Be sure to test call quality in the selected location before you permanently mount the Phonecell SX4D to the wall.

Pre-Installation Tips:

- Make sure the location is dry, away from overhead water pipes, and protected from weather conditions.
- The area should be free of airborne contaminants.
- The Phonecell SX4D power supply should be located within two meters (six feet) of an AC power outlet.

Wall-Mount Instructions:

- 1) The Phonecell SX4D comes equipped with a handset mounting clip for wall-mounting applications. Remove the clip from the cradle - **see Figures 10 and 11.**
- 2) Insert the handset mounting clip with the tab pointing up - **see Figures 10 and 11.**
- 3) To mount the Phonecell SX4D on a wall, mark two hole locations 83 mm (3-1/4 inches) apart. Use the tick marks on the edge of this page as a template. These hole locations match the mounting hooks on the back of the unit - **see Figure 9.**
- 4) Using the two hole locations marked above, drill two holes into the wall.
- 5) Install the screws (not supplied), into the wall, leaving a gap (approximately 3 mm (1/8 inch)) between screw head and wall.
- 6) Mount the Phonecell SX4D onto the screws - **see Figure 12.**

83 mm (3-1/4 inches)

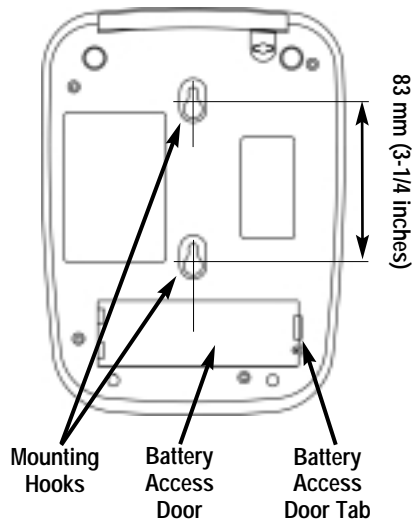

Figure 9 – Phonecell SX4D mounting hooks and battery access door located on the back of the unit.

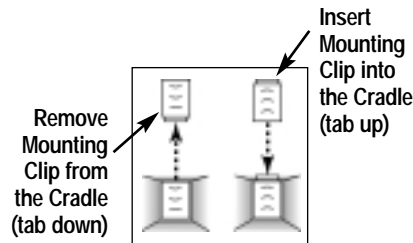

Figure 10 – Handset mounting clip assembly for wall-mount applications.



Figure 12

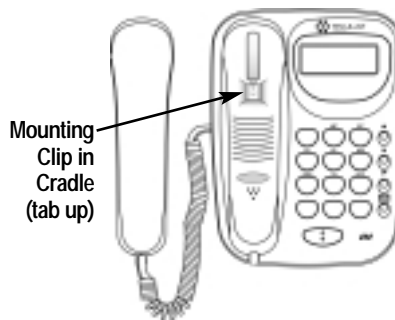

Figure 11 – Handset mounting clip assembly.

Phonocell SX4D Operation

Once your **Phonocell SX4D** is installed, it is ready for operation.

LCD Display

The Phonocell SX4D's LCD displays three rows of information: Legends, Dialed Digits and Alpha - see **Figure 13**.

Legends

The *top row* consists of the following legends and icons:

- **PM** - Indicates programming mode. Used only in the *Programming Mode*.
- **NEW** - Indicates a change in stored data. Used only in the *Programming Mode*.
- **Call Timer** - Indicates the time (minutes and seconds) of a call. Used only in the *Normal Mode*.
- **Battery** - Indicates that the Phonocell SX4D is operating on the internal batteries. Used in all modes.

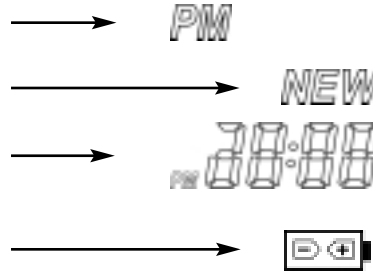

Dialed Digits

The *middle row* is used to display dialed digits from the keypad, as well as incoming Caller ID information. Numeric digits from 0-9, the star (*) key, and the hash (#) key are included.

Alpha

The *bottom row* is used to display Received Signal Strength, In-Use Indicator, Roam Indicator and Cellular Service State Indicator.

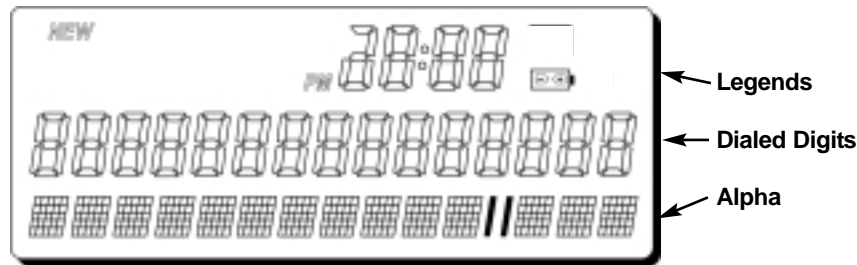

Figure 13 – Phonocell SX4D LCD Display.

Phonocell SX4D Operation - continued

Phonocell SX4D Normal Power Mode

When the Phonocell SX4D is powered on, the unit automatically proceeds through the following steps:

| <u>Time Elapsed</u> | <u>LCD Display</u> |
|----------------------------|----------------------------|
| 16 seconds | "Initializing" |
| 2 seconds | All LCD fields illuminated |
| 2 seconds | Phonocell software version |
| 2 seconds | Radio software version |
| | Normal mode of operation |

NOTE: When the AC/Battery switch is changed, the normal operation screen is displayed for one second, then the normal Power Mode sequence will commence.

NOTE: When exiting the Programming Mode, the normal operation screen will be displayed.

Phonocell SX4D Normal Mode

The Phonocell SX4D operates in the Normal Mode. The functions of the Phonocell SX4D are displayed on the LCD.

Legends Row (Top Row)

Battery

The *Battery* icon appears only when the Phonocell SX4D is operating on its internal batteries.



Call-Timer

The *Call Timer* icon appears when the Phonocell SX4D begins a connected phone call. The call timer begins as all zeros and increments every subsequent second. The timer will roll over back to 0:00 after 29:59. When the handset is placed on-hook (ends call), the call timer stops and displays the accumulated call time for thirty seconds. The *Call Timer* icon is then turned off.



If the handset goes off-hook and a digit is pressed within the thirty second period, the call time display will immediately turn blank.

Phonecell SX4D Operation - continued

Phonecell SX4D Normal Mode

- continued

Dialed Digits (Middle Row)

Outgoing Calls

When you make an outgoing call (the handset is off-hook), the numeric digits entered are displayed on the LCD Display - see **Figure 14**.

- The star (*) key displays "-."
- The hash (#) key displays "≡."

NOTE: When the handset is on-hook and keys are pressed, numeric digits are displayed only when the Phonecell SX4D is in the programming mode.

Dialed digits move from right to left as they are entered. The dialed digit row is completely cleared when the handset goes on-hook in the *Normal Mode*.

Incoming Calls

When the Phonecell SX4D receives an incoming call, the Dialed Digits row displays the incoming call number (Caller ID) when the on-hook call *Alert* sounds. The incoming call number display is turned off when the call is answered (handset is off-hook). Caller ID will also be shown for off-hook call alerts.

NOTE: The incoming call number (Caller ID) feature requires that Caller ID is provided by the cellular network. If the service is not provided, or the caller ID is blocked or unknown, the display remains blank on incoming calls.

Alpha (Bottom Row)

The Alpha Row displays the following status information:

- Received Signal Strength
- Roam Indicator
- In-Use Indicator
- Cellular Service Indicator

Received Signal Strength

The Received Signal Strength is displayed by the first 11 characters (from left to right) in the Alpha Row - see **Figure 15**. Received signal strength can be displayed by either a signal strength bar graph or a direct readout of the signal strength in dBm.

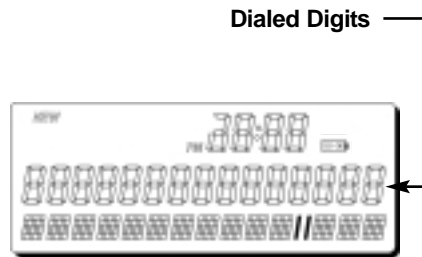

Figure 14 – Phonecell SX4D LCD Display

Phonocell SX4D Operation - continued

Phonocell SX4D Normal Mode

- continued

Direct Readout Mode displays the signal strength as "-XXXDBM", where **XXX** refers to the signal strength. The factory setting is the Direct Readout Mode. This setting is field programmable - see the Phonocell SX4D *Programming* section of this manual.

Signal Strength Bar Graph displays the signal strength as a series of solid block characters. The stronger the signal, the more characters are illuminated from left to right.

NOTE: The 12th character (from left to right) is used as a separator only and does not provide information - see **Figure 15**. A "|" character is displayed and is always illuminated.

In-Use Indicator

The In-Use Indicator displays a "U" in the 14th character position when the Phonocell SX4D is in use (i.e. call data is sent to the cellular base station). The 14th character remains blank when the Phonocell SX4D is not in use.

Cellular Service Indicator

The Cellular Service Indicator displays the cellular status in the 15th character position with the following:

- **N** = No service
- **L** = Limited (non-registered) service
- **S** = Service
- **R** = Roaming

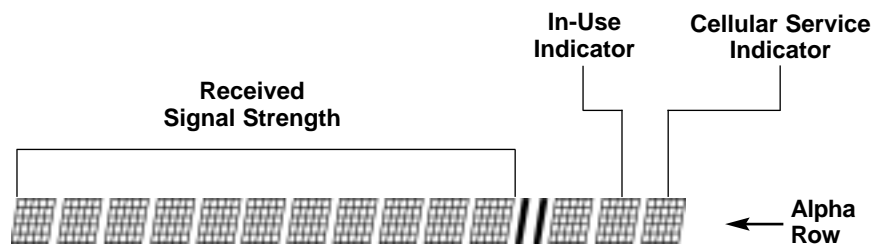

Figure 15 – Phonocell SX4D LCD - Alpha Row.

Phonecell Operation - continued

Phonecell SX4D Controls

Front Panel

All controls for the Phonecell SX4D are located on the front panel - **see Figure 16**. Pressing any of the front panel controls will cause the unit to beep for approximately 100 milliseconds when the key is depressed.

Keypad

The keypad includes all digits 0 through 9 and special characters hash (#) and star (*). All data entry and programming activities are performed using the keypad.

Flash

 The flash key is used to produce a hookflash. See the *Hookflash Function* section of this manual.

Redial

 The redial key redials the last dialed phone number.

Up/Down Keys

 When off-hook, the Up/Down keys control the volume of the earpiece in the handset. The available range is ± 12 dB of the nominal earpiece output level. Each adjustment increment is 6 dB. The volume setting persists until changed by the user, or the volume setting is returned to nominal by resetting the Phonecell (power Off/On).

Voicemail Retrieval

 The *Voicemail Retrieval* key causes the Phonecell SX4D to dial a programmable DTMF digit string, allowing the user to retrieve voicemail messages. To program the voicemail retrieval number, see the *Programming Commands* section of this manual.

NOTE: The Voicemail Retrieval feature is dependent upon network availability.

Back Panel

AC/Battery Switch

The AC/Battery switch allows the user to switch between external power (wall cube) and internal (emergency) battery - **see Figure 17**.

NOTE: When the setting of the AC/Battery switch is changed, the Phonecell SX4D resets itself prior to resuming normal operation - see the *Phonecell SX4D Power Mode* section of this manual.

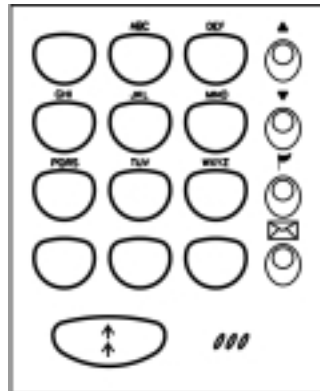
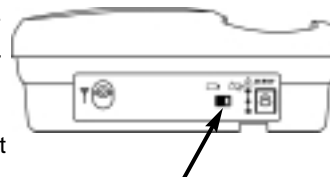

Figure 16 – Phonecell SX4D front panel.



AC/Battery Switch

Figure 17 – Phonecell SX4D back panel.

IMPORTANT!

The AC/Battery switch should be left in the AC position unless the user needs to make a call using the emergency batteries (the batteries provide a useful call time of about 10 minutes before replacement is required).

Phonocell Operation - continued

How to Place a Call

- 1) Pick up your Phonocell SX4D handset (*your phone is now "off-hook"*).
- 2) Listen for dial tone (*If service is not available, a No-Service tone is produced and the letter "N" is displayed on the LCD in the Alpha (bottom) row. Hang-up the Phonocell SX4D and try again. If the No-Service tone continues and the "N" continues to be displayed, contact your service provider to make sure cellular service is activated.*).
- 3) Dial the phone number.

How to Receive a Call

- When your Phonocell SX4D rings, pick up the handset and begin talking.

How to End a Call

- Hang-up the phone (*place the handset back onto the Phonocell SX4D cradle*).

The Hookflash Function

When you initiate the Hookflash function, it automatically lets you:

- Speed up the connection after you dial a phone number.
- Answer an incoming call that occurs when you're dialing a phone number.
- Use special (*supplementary*) cellular services which may be available in your cellular service area.

How to Use the Hookflash Function

There are two ways to initiate the Hookflash function:

- Press the "**FLASH**" key on your Phonocell SX4D.
- Press the hang-up or switch-hook mechanism on your Phonocell SX4D once quickly (*approximately 1/2-second*).

Important Tones and Alerts

No-Service Tone – When cellular service is not available, the receiver emits a No-Service (*fast-beeping*) tone instead of the normal (*steady*) dial tone.

ROH (Receiver Off-Hook) Tone – If the Phonocell SX4D handset remains off-hook (*off its cradle*) with no dialing activity for 30 seconds, the receiver emits an ROH tone for 45 seconds.

Incoming Call Alert – If you're dialing a number and an incoming call occurs, the receiver will emit an audible ring. To answer the incoming call:

- Press the "**FLASH**" button once. This will connect the incoming call.
- OR hang-up immediately. This will cause the phone to start ringing.

Roam Dial Tone – When cellular service is available, but the Phonocell SX4D is in a Roam area, the receiver may emit a different dial tone to indicate the roaming condition. However, unless the Phonocell SX4D is re-programmed in the field, the factory default tone is set the same as normal service dial tone.

Phonocell Operation - continued

Variable Dial Time (Auto SEND Delay) Option

When you place a call, your Phonocell SX4D automatically sends the phone number over the cellular network after you dial the last digit. However, to make sure you have enough time to dial the last digit, a 3-second *Auto SEND Delay* is programmed into the unit at the factory. To change the *Auto SEND Delay setting*, see the *User Programming Commands* section of this manual.

Zero Dial Delay for Frequently Called Numbers

A new patented feature enables the Phonocell SX4D to recognize your frequently called phone numbers and send them immediately – without the 3-second Auto SEND Delay. The Phonocell SX4D stores a list of up to 50 different numbers in its memory. This list contains the last 50 numbers that have been called at least twice successfully.

NOTE: Cycling (*turning OFF/ON*) the power will erase the current list. A new list will be started when power is re-applied. To enable or disable this feature, see the *User Programming Commands* section of this manual.

Mobile Equipment Personalization (MEP)

The terminal will support all five lock type features of GSM 02.22. Personalization features check information stored in the terminal which limits the SIMs with which the terminal will operate. Factory default is all lock types set to be deactivated. Please contact Telular Corporation if you need more information on this feature.

Three-Digit Dialing

In many countries, three-digit dialing is needed to access emergency services, information services, and voicemail. The Phonocell SX4D accepts three-digit dialing.

Using Standard Supplementary Services

Your **Phonocell SX4D** is compatible with a variety of special services, including:

- Call Forwarding
 - Call Barring
 - Call Waiting
 - Three-Way Calling
 - Caller ID
 - Voice Mail
- and more...

Depending upon your cellular provider, these services may be available on a subscription basis. However, certain dialing sequences must be entered. ***Please consult your service provider for the dialing instructions for your system.***

Standard supplementary services are defined as those supplementary services handled while not in a call. Depending on the supplementary service, several commands may be available. The command list is defined below:

Phonecell Operation - continued

Registration - The programming by the user of information to enable subsequent operation of a service. This action involves input of specific supplementary information. For example, when call-forwarding registration is initiated by the user, a forwarding number must be supplied.

Erasure - The deletion of information stored against a particular service by a previous registration.

Activation - An action taken by the Desktop Phone user to enable a previously registered process to run.

Deactivation - An action taken by the Desktop phone user to terminate the process started at activation.

Depending on the supplementary service, additional parameters may be required to successfully complete an operation, such as phone number or password. Some supplementary services have optional parameters, such as Teleservice and/or Delay settings. Delay is the amount of time to wait before completing performance of a service that has a condition controlling its activity; for example, call forward on no answer waits an amount of time equal to the "delay" for the phone to be answered before declaring no answer and forwarding the call.

Teleservice: 10 = All Teleservices, 11 = Speech, 12 = Data, 13 = Fax, 16 = SMS, 19 = All Teleservices except SMS.

Delay: 5-30 seconds

PhoneNo: Up to 20 digits (0-9)

NOTE: <send> is provided by the hookflash function -see the **Hookflash Function** section of this manual (pg 24).

Call Forwarding Unconditional:

Allows a called subscriber to have the network send immediately all incoming calls, or just those associated with a specific teleservice, addressed to the called subscriber's directory number to another directory number.

```
Register:  * * 21 * Ph No * Teleservice # <Send>
           or
           * 21 * Ph No * Teleservice # <Send>
Erase:     ## 21 * Teleservice # <Send>
Activate:  * 21 * Teleservice # <Send>
Deactivate: # 21 * Teleservice # <Send>
```

Call Forwarding on Mobile Subscriber Busy:

Allows a called subscriber to have the network send immediately all incoming calls, or just those associated with a specific basic service group, addressed to the called subscriber's directory number and which meet "subscriber busy" to another directory number.

```
Register:  * * 67 * Ph No * Teleservice # <Send>
           or
           * 67 * Ph No * Teleservice # <Send>
Erase:     ## 67 * Teleservice # <Send>
Activate:  * 67 * Teleservice # <Send>
Deactivate: # 67 * Teleservice # <Send>
```

Phoncell Operation - continued

Call Forwarding on No Reply:

Allows a called subscriber to have the network send all incoming calls, or just those associated with a specific basic service group, addressed to the called subscriber's directory number and which meet "no reply" for a specific amount of time to another directory number.

Register: * * 61 * Ph No * Teleservice * Delay # <Send>
Erase: # # 61 * Teleservice # <Send>
Activate: * 61 * Teleservice # <Send>
Deactivate: # 61 * Teleservice # <Send>

Call Forwarding on Mobile Subscriber Not Reachable:

Allows a called subscriber to have the network send all incoming calls, or just those associated with a specific Teleservice group, addressed to the called mobile subscriber's directory number, but which is determined to be "not reachable", to another directory number.

Register: * * 62 * Ph No * Teleservice # <Send>
Erase: # # 62 * Teleservice # <Send>
Activate: * 62 * Teleservice # <Send>
Deactivate: # 62 * Teleservice # <Send>

Call Forwarding All Call Forwarding:

Allows a called subscriber to have the network send-after the stated delay-all incoming calls, or just those associated with a specific teleservice, addressed to the called subscriber's directory number to another directory number.

Register: * * 002 * Ph No * Teleservice * Delay #
<Send>
Erase: # # 002 * Teleservice # <Send>
Activate: * 002 * Teleservice # <Send>
Deactivate: # 002 * Teleservice # <Send>

Call Forwarding Conditional Call Forwarding:

Register: * * 004 * Ph No * Teleservice * Delay #
<Send>
Erase: # # 004 * Teleservice # <Send>
Activate: * 004 * Teleservice # <Send>
Deactivate: # 004 * Teleservice # <Send>

Calling Line Identification Restriction:

If subscribed to in temporary mode, enable the calling party to countermand the subscribed-to presentation of its line identity to the called party for a specific call (i.e., the next call) only. (If subscribed to in permanent mode, the network will prevent presentation of the calling party's line identity to the calling party for every outgoing call.)

If subscribed to in temporary mode with default value "presentation restricted," the user may suppress CLIR, for the specific call only:

Register: * 31 # Call Phone Number <Send>

If subscribed to in temporary mode with default value "presentation not restricted," the user may invoke CLIR, for the specific call only:

Register: # 31 # Call Phone Number <Send>

Phoncell Operation - continued

Barring of All Outgoing Calls:

Allows a subscriber to have barring of certain categories of outgoing calls according to a barring program which is selected from a set of one or more barring programs chosen at provision time and is valid for all outgoing calls, or just those associated with a specific Teleservice.

Activate: * 33 * Password * TeleService # <Send>
Deactivate: # 33 * Password * TeleService # <Send>

Barring of Outgoing International Calls:

Outgoing call setup possibilities exist only to subscribers of the PLMN(s) and the fixed network(s) of the country where the mobile subscriber is presently located.

Activate: * 331 * Password * TeleService # <Send>
Deactivate: # 331 * Password * TeleService # <Send>

Barring of Outgoing International Calls Except Those Directed to the Home PLMN Country:

Outgoing call setup possibilities exist only to subscribers of the PLMN(s) and the fixed network(s) of the country where the subscriber is presently located or to subscribers of the home PLMN country of the served subscriber and to subscribers of the fixed network(s) in the home PLMN country.

Activate: * 332 * Password * TeleService # <Send>
Deactivate: # 332 * Password * TeleService # <Send>

Barring of All Incoming Calls:

Allows a subscriber to have barring of certain categories of incoming calls according to a barring program which is selected from a set of one or more barring programs chosen at provision time and is valid for all incoming calls, or just those associated with a specific basic service group.

Activate: * 35 * Password * TeleService # <Send>
Deactivate: # 35 * Password * TeleService # <Send>

Barring of Incoming Calls when Roaming Outside the Home PLMN Country:

Calls which are terminated for the served subscriber is barred if the subscriber is roaming outside the home PLMN country.

Activate: * 351 * Password * TeleService # <Send>
Deactivate: # 351 * Password * TeleService # <Send>

All Call Barring:

On activation all calls is barred; on deactivation all call barring is disabled.

Activate: * 330 * Password * TeleService # <Send>
Deactivate: # 330 * Password * TeleService # <Send>

All Outgoing Call Barring:

On activation all outgoing calls is barred; on deactivation all outgoing call barring is disabled.

Activate: * 333 * Password * TeleService # <Send>
Deactivate: # 333 * Password * TeleService # <Send>

Phoncell Operation - continued

All Incoming Call Barring:

On activation all incoming calls are barred; on deactivation all call barring is disabled.

Activate: * 353 * Password * TeleService # <Send>

Deactivate: # 353 * Password * TeleService # <Send>

Unstructured Supplementary Services:

Allows a user and a PLMN operator-defined application to communicate in a way that is transparent to the terminal and to intermediate network entities.

“any characters defined in GSM 03.08 Default Alphabet” # <Send>

or

“1 or 2 characters defined in GSM 03.08 Default Alphabet” # <Send>

Phonocell SX4D Troubleshooting

Cellular Telephone Service is Not Working

If the cellular telephone service is not working, contact your cellular provider.

Unable to Receive Incoming Calls

Verify that the Phonocell SX4D is "on-hook" (*hung up*).

Moisture or Ventilation Problems

Visually inspect your Phonocell SX4D's enclosure. Moisture can damage the equipment. Ventilation is also very important. If there are moisture or ventilation problems, move your Phonocell SX4D to correct as necessary, see the *Temperature Environment* section of this manual.

No Power

To properly operate, the Phonocell SX4D must either be connected to AC power or have the required batteries loaded in the battery compartment. Upon loss of power to the Phonocell SX4D, verify proper connection to AC. If AC power is unavailable, verify that the batteries are in good condition and that the battery switch is in the battery power active position.

Battery Backup Failure

The Phonocell SX4D can accommodate 6 standard AAA alkaline batteries for operation when AC power is not available. A switch is used to select either AC or internal battery operation. When the internal battery operation is selected, the Phonocell SX4D will operate for approximately 10 minutes of talk time with fresh batteries. Replace the batteries if necessary.

NOTE: The Phonocell SX4D does not support rechargeable batteries



WARNING!

Only Authorized Service Personnel should remove the cover of your Phonocell SX4D. For further assistance, contact your Authorized Telular Representative. Please have the model and serial number ready (model and serial numbers are located on the label on the bottom of the unit).

Phonocell SX4D Programming

Phonocell SX4D Programming Mode Overview

The Phonocell SX4D has several programmable options for unique customer or network applications. These options are stored in the Phonocell SX4D's non-volatile memory and are retained during power cycling.

Programming Mode

The Phonocell SX4D's non-volatile memory can be accessed in the *Programming Mode*. The handset must be "on-hook" before entering the programming mode. *Normal Mode* operation is suspended during programming and is available when the programming mode is exited.

Enter Programming Mode

To enter the user programming mode, simultaneously press the "Flash" and star (*) keys. The *PM (Programming Mode)* icon will illuminate on the LCD.

Programming Mode Overview:

1. Stored data appears on the *Dialed Digits* (middle) row of the LCD.
2. A descriptive label appears on the *Alpha* (bottom) row of the LCD. The label order is identical in both the user and technician command modes.
3. The *Up/Down* keys are used to scroll through the menu items.
4. Pressing any numeric key(or, if allowed, the * or # key) when a label is displayed causes:
 - The *Dialed Digits* row to turn off
 - The *NEW* icon to illuminate
 - The pressed key to appear at the rightmost *Dialed Digits* row position.
5. Pressing the Redial key after a numeric entry will attempt to store the data.
6. A correct entry will cause the *NEW* icon to disappear and the new stored data to be displayed on the *Dialed Digits* row.
7. An incorrect entry causes the *Dialed Digits* row to flash. When a numeric key is then pressed, it causes:
 - The *Dialed Digits* row to turn off
 - The *NEW* icon to remain illuminated
 - The pressed key to appear at the rightmost *Dialed Digits* row position.
8. When entering data, the *NEW* icon is illuminated. Pressing the Flash key at any time will cancel the operation and redisplay the stored data on the *Dialed Digits* row. The *NEW* icon will then turn off.

During programming, the unit automatically proceeds through the following steps:

| Time Elapsed | LCD Display |
|---------------------|--------------------------|
| 1 second | Blank |
| 1 second | Programming |
| 1 second | Blank |
| | Normal mode of operation |

Phonocell SX4D Programming - continued

Exit Programming Mode

The programming mode can be exited by any one of the following:

1. Go "off-hook" (pick up handset)
2. Failure to enter the correct password three times (technician mode only)
3. Failure to enter any digit within two minutes.

The *PM (Programming Mode)* icon is then turned off, returning the Phonocell SX4D to the *Normal Mode*.

Phonocell SX4D User-Programming Commands

The following commands are displayed when in the user programming mode. An **<entered value>** is comprised of the digits 0 through 9.

How to Enter Call Alert Volume

The following key sequence is used to enter the volume of the call alert:

Label: CALL ALERT VOL
Data: <volume>

The volume value is set to **0** for off; **1** for low; and **2** for high. If the volume value is greater than 2, it is considered invalid. The factory default is **2**.

Enter Auto Send Delay

The following key sequence is used to enter the auto send delay:

Label: AUTO SEND DELAY
Data: <delay>

If the delay is not in the range of **2** to **20** seconds, it is considered invalid. The factory default is **3**.

Enter RSSI Display Type Option

The following key sequence is used to select the RSSI display option:

Label: RSSI DISPLAY
Data: <type>

The type value is set to **0** for direct readout in dBm or **1** for bar graph. If the RSSI display type value is greater than 1, it is considered invalid. The factory default is **0**.

Enter LCD Display Contrast

The following key sequence is used to enter the LCD Display Contrast:

Label: LCD CONTRAST
Data: <contrast>

If the LCD contrast is not in the range of **0** (darkest contrast) to **19** (lightest contrast), it is considered invalid. The factory default is **10**.

Enter Zero-Delay Dial

The following key sequence is used to enter the Zero Delay Dial option:

Label: ZERO-DELAY DIAL
Data: <zero-delay dial>

The zero delay dial value is set to **0** for Disable and **1** for Enable. The factory default is **1** (Enable).

Phonocell SX4D Programming - continued

IMPORTANT!



The following commands may be used by a trained service technician to change the configuration of the Phonocell SX4D. **WARNING:** these commands are intended for use by trained service technicians only. Untrained users could damage the Phonocell SX4D, violate local regulations and breach the service agreement with the cellular provider. For further assistance, please contact your Authorized Telular Representative.

Phonocell SX4D Technician Commands

The following commands are to be used by trained field technicians to set up the Phonocell SX4D for operation in the network. Since these commands can directly affect the proper operation of the unit, there is an additional level of security to prevent casual access.

While in the *User Programming* mode, the technician presses the flash and redial keys simultaneously. A "PASSWORD" label will be displayed on the alpha row. The technician enters the password. As the password digits are entered from the keypad, only the center segment of the dialed digits row will illuminate. Note that as an exception to entry rule #4, the *NEW* icon will not illuminate, since the password data is not being changed. When the technician presses the Redial key, the password is processed. If the password is correct, the "DTRCT" label is displayed on the alpha row. If not, the incorrect entry rule #7 will be followed, except that the *NEW* icon will not be illuminated. If the user fails to enter the correct password after three tries, the programming mode is exited without flashing the dialed digit row.

The following commands are displayed when the technician enters the programming mode. In the following sections, an **<entered value>** is comprised of the digits 0 through 9.

Enter Dial Tone After Remote Call Terminate Option

The following key sequence is used to enter the dial tone after remote call terminate option:

Label: DTRCT
Data: <dial tone option>

The dial tone value is set to **0** for no tone after a remote on-hook; **1** to enable dial tone after remote on hook. If the value is neither 0 nor 1, it is considered invalid. The factory default is **1**.

Enter Post Receiver Off-Hook Option

The following key sequence is used to enter the post receiver off-hook option:

Label: POST ROH
Data: <post ROH option>

The post ROH value is set to **0** for continuous ROH tone; **1** to disable ROH tone and periodically check for an on-hook condition. If the post ROH value is neither 0 nor 1, it is considered invalid. The factory default is **1**.

Phonocell SX4D Programming - continued

Enter Periodic Self Test Time Option

The following key sequence is used to program periodic self test time interval:

Label: SELF TEST TIME
Data: <self-test interval>

The self-test interval is programmed in 1-minute increments from **1** to **65,535**. A value of **0** disables periodic self test. If the value is not between 0 and 65,535, inclusive, it will be considered invalid. The factory default is **180**.

Enter Dial Tone Type Selection Option

The following key sequence is used to select the dial tone type option:

Label: DIAL TONE TYPE
Data: <dial tone frequency>

The dial tone frequency selection option value is set to **0** to select the North American dial tone frequency pair (350 + 440 Hz); set to **1** to select European dial tone frequency (425 Hz). If the dial tone frequency selection option value is neither 0 nor 1, it is considered invalid and the Phonocell will not update or store this value; the currently stored value will remain. The factory default is **1**.

Enter In-Call DTMF Signaling Option

The following key sequence is used to select if in-call DTMF signaling is enabled:

Label: IN CALL DTMF
Data: <in-call DTMF signaling enabled>

The in-call DTMF signaling value is set to **0** for disabled or **1** for enabled. If the in-call DTMF signaling value is neither 0 nor 1, it is considered invalid. The factory default is **1**.

Enter Mobile Equipment Personalization for SIM

The following key sequence is used to enter the MEP option:

Label: MEP: SIM
Data: <MEP Operation> * <MEP Password>

MEP operation value is set to **0** to deactivate personalization; **1** to activate personalization; **2** to disable personalization; **3** is reserved for future use. If the MEP operation value is not in the range 0 to 3, it is considered invalid. The MEP password is a special value available only to authorized personnel. The factory default is set to **0** deactivated.

Enter Mobile Equipment Personalization for Network

The following key sequence is used to enter the MEP option:

Label: MEP: NETWORK
Data: <MEP Operation> * <MEP Password>

MEP operation value is set to **0** to deactivate personalization; **1** to activate personalization; **2** to disable personalization; **3** is reserved for future use. If the MEP operation value is not in the range 0 to 3, it is considered invalid. The MEP password is a special value available only to authorized personnel. The factory default is set to **0** deactivated.

Phonocell SX4D Programming - continued

Enter Mobile Equipment Personalization for Network Subset

The following key sequence is used to enter the MEP option:

Label: MEP: NETWRK SUB

Data: <MEP Operation> * <MEP Password>

MEP operation value is set to **0** to deactivate personalization; **1** to activate personalization; **2** to disable personalization; **3** is reserved for future use. If the MEP operation value is not in the range 0 to 3, it is considered invalid. The MEP password is a special value available only to authorized personnel. The factory default is set to **0** deactivated.

Enter Mobile Equipment Personalization for Corporate

The following key sequence is used to enter the MEP option:

Label: MEP: CORPORATE

Data: <MEP Operation> * <MEP Password>

MEP operation value is set to **0** to deactivate personalization; **1** to activate personalization; **2** to disable personalization; **3** is reserved for future use. If the MEP operation value is not in the range 0 to 3, it is considered invalid. The MEP password is a special value available only to authorized personnel. The factory default is set to **0** deactivated.

Enter Mobile Equipment Personalization for Service Provider

The following key sequence is used to enter the MEP option:

Label: MEP: SERV PROVD

Data: <MEP Operation> * <MEP Password>

MEP operation value is set to **0** to deactivate personalization; **1** to activate personalization; **2** to disable personalization; **3** is reserved for future use. If the MEP operation value is not in the range 0 to 3, it is considered invalid. The MEP password is a special value available only to authorized personnel. The factory default is set to **0** deactivated.

Enter Voicemail Retrieval Digit String

The following key sequence is used to enter the Voicemail Retrieval Digit String:

Label: VOICE MAIL NUM

Data: < voicemail retrieval digit string >

This command will accept the digits 0 through 9. If the Voicemail Retrieval Digit String is **less than 3 characters or more than 10 characters**, it is considered invalid and the Phonocell SX4D will not update or store this value; the currently stored value will remain. The factory default is unprogrammed.

©2001 TELULAR CORPORATION
Part No. 56020401

Free Manuals Download Website

<http://myh66.com>

<http://usermanuals.us>

<http://www.somanuals.com>

<http://www.4manuals.cc>

<http://www.manual-lib.com>

<http://www.404manual.com>

<http://www.luxmanual.com>

<http://aubethermostatmanual.com>

Golf course search by state

<http://golfingnear.com>

Email search by domain

<http://emailbydomain.com>

Auto manuals search

<http://auto.somanuals.com>

TV manuals search

<http://tv.somanuals.com>