



PHONECELL® SX3e AMPS FIXED WIRELESS TERMINAL

USER MANUAL

Total communications freedom at your fingertips...voice/fax/data.

06/25/01

Part No. **56017302**

Introduction

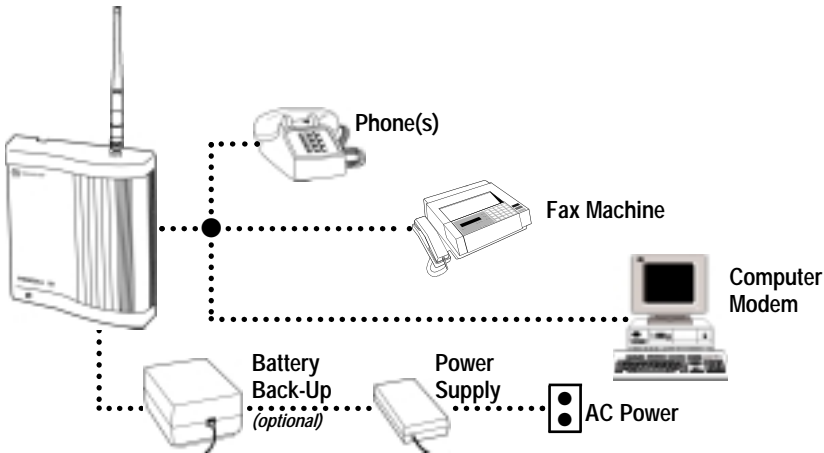

Thank you for choosing the **Phonecell SX3** Fixed Wireless Terminal from Telular. This innovative product lets you connect up to five pieces of standard telephone equipment into a cellular network for total communications flexibility.

Please follow this guide to unpack, set up and operate your new Phonecell safely and properly.

*Telular is proud to welcome you as a valued customer.
Your satisfaction is our most important concern.*

**Telular Corporation
Corporate Headquarters
647 North Lakeview Parkway
Vernon Hills, Illinois 60061, USA**

TECHNICAL SUPPORT

Tel: 847-247-9400 • Fax: 847-247-0021

E-mail: mainoffice@telular.com • <http://www.telular.com>

Patents: Telular Corporation products are protected and manufactured under one or more of the following U.S. patents and related international patents and patents pending relating thereto: 4,658,096; 4,737,975; 4,775,997; 4,868,519; 4,922,517; 5,134,651; 5,361,297; 5,469,494; 5,046,085; 5,715,296.

Trademarks: Telular Corporation owns the following registered trademarks: TELULAR and design, TELULAR, CELJACK, MAXJACK, TELCEL, HEXAGON LOGO, PHONECELL, CELSERV, TELGUARD, CPX, and AXCELL.

Part No. 56017302

©2001 Telular Corporation, all rights reserved.

Table of Contents

Introduction	2
Technical Support	2
Getting Started	
Unpacking the Phonecell SX3e	4
Pre-Installation Checklist	4
Installation Summary	5
Step 1. Choose an Antenna Location	6
How to Connect the Antenna	7
Step 2. Plug in Your Telephone	8
Connect Your Telephone	8
Place a Call – Adjust Your FWT	8
Adding More Phones.....	8
Additional Telephone Equipment.....	8
Step 3. NAM/Phone Number Setup	9
Optional A-Key (<i>Authentication Code</i>) Setup.....	11
Step 4. Install Your Phonecell	
Wall-Mount Installation	12
Desktop/Tabletop Installation.....	13
Phonecell SX3e Operation	
How to Use the LED Display	14
How to Place a Call.....	14
How to Receive a Call.....	14
How to End a Call	14
Hookflash Function.....	14
Important Tones and Alerts.....	15
How to Adjust the Volume Level.....	15
Fax/Data Transmission.....	15
Variable Dial Time (<i>Auto SEND Delay</i>) Option.....	16
Special Cellular Services.....	16
Data After SEND (<i>In-Call DTMF Signaling</i>) Option	17
Zero Dial Delay for Frequently Called Numbers	17
Phonecell SX3e Troubleshooting	18
Important Safety Information	19
AMPS Technician Programming	
How to Enter the Programming Mode.....	22
How to Set the Access Overload Class (<i>ACCOLC</i>)	23
How to Set the Access Method (<i>EX</i>) Option	23
How to Set the Roam Option.....	23
How to Set the Dial Tone After Remote On-Hook Option	23
How to Set the Post-Receiver Off-Hook (<i>ROH</i>) Option.....	24
How to Set the Pulse Dial Option	24
How to Initiate a Ring-Back Request.....	24
How to Restore the Factory Default Settings	24
How to Enable/Disable the Zero Dial Delay Option	24

Getting Started...

Un-Packing Your Phonecell SX3e



❶



❷



❸

The **Phonecell SX3e** comes with the following:

- ❶ Phonecell SX3e Fixed Wireless Terminal (FWT)
- ❷ Mounting Bracket with Two Screws
- ❸ Four Rubber Feet for Desktop/Tabletop Use*
(*Do not attach feet if wall-mounting the Phonecell.)

Carefully remove the unit from the shipping carton and check for evidence of shipping damage. **If damage is found, contact your Authorized Telular Distributor or shipping agent immediately.**

Pre-Installation Checklist

Before attempting **Phonecell SX3e** installation, make sure you have the following components, tools and materials.

Components Needed

Qty.	Description	Supplied	Not Supplied
1	External Power Supply with AC Line Cord		✓
1	Antenna (<i>Spike, Magnetic-Mount, or Yagi</i>)		✓
1	RJ-11 Modular Phone Cord (<i>Length varies according to your specific installation and the number of phones you plan to connect</i>)		✓
1	RJ-11 Phone Line Splitter (<i>if you plan to connect more than one telephone device</i>)		✓

Tools & Materials Needed (for Wall-Mount Installation Only)

Qty.	Description	Supplied	Not Supplied
1	Drill & Drill Bit		✓
1	Screwdriver		✓
2	1½-inch (3.75 cm) Mounting Screws		✓

Installation Summary

There are four steps to installing the **Phonecell SX3e** FWT properly. These steps are summarized below and explained in detail in the remainder of this manual.

Step 1. Choose an Antenna Location (pg. 6-7)

- Choose a location.
- Next, connect power to the FWT and turn the unit ON.
- Then, connect the antenna (*not supplied*).
- Check the cellular signal strength and move the antenna until you achieve the best signal possible.



Step 2. Plug In Your Phone (page 8)

- Once the antenna is connected, hook up a phone.
- Then, make a test call to check noise levels, and adjust the antenna location accordingly.
- NOTE: If your **Phonecell SX3e** is not pre-programmed for NAM (*Number Assignment Module*) information, you'll need to perform the NAM/Phone Number Setup in Step 3. Then, return to this step (2).
- Plug in additional phones, Fax and/or Modem.

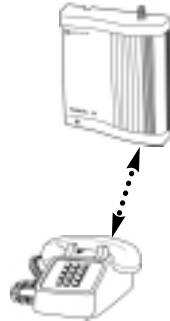

Step 3. NAM/Phone Number Setup (pg. 9-11)

- If your **Phonecell** was not pre-programmed for NAM information, you need to perform the NAM/Phone Number Setup procedure.
- Otherwise, continue to Step 4.



Step 4. Wall or Desk Installation (pg. 12-13)

- After you've selected a location and made all the necessary connections and adjustments, your **Phonecell SX3e** is ready for either wall-mounting or desktop/tabletop use.



Step 1. Choose an Antenna Location



Your **Phonecell SX3** receives operating commands from the cellular network and relies upon signal strength for proper operation. Therefore, finding an antenna location with good signal strength is critical for call quality.

ANTENNA LOCATION TIPS:

- Locate the antenna above ground and as close to windows (or exterior walls) as possible – see Fig. 1.
- Try to install the antenna in an uninhabited area (i.e. closets, attics, etc.) to ensure a minimum separation of 16 inches (40 cm) between the antenna and the inhabitants.
- Preferably, the antenna should be mounted on the building's exterior – see Fig. 2.
- High-gain ("Yagi") antennas must be directed toward your service provider's nearest cell tower.
- Spike antennas must be pointed upward.
- Keep antenna cable as short as possible – long cable runs affect call quality.
- Never splice antenna cable.

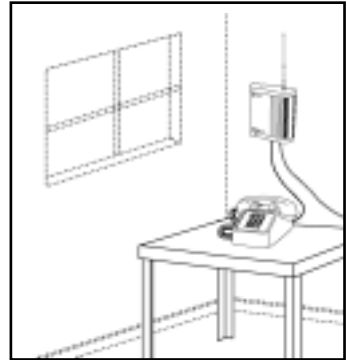

Fig. 1 Optional spike antenna pointed upward and located near the window for optimum signal strength.

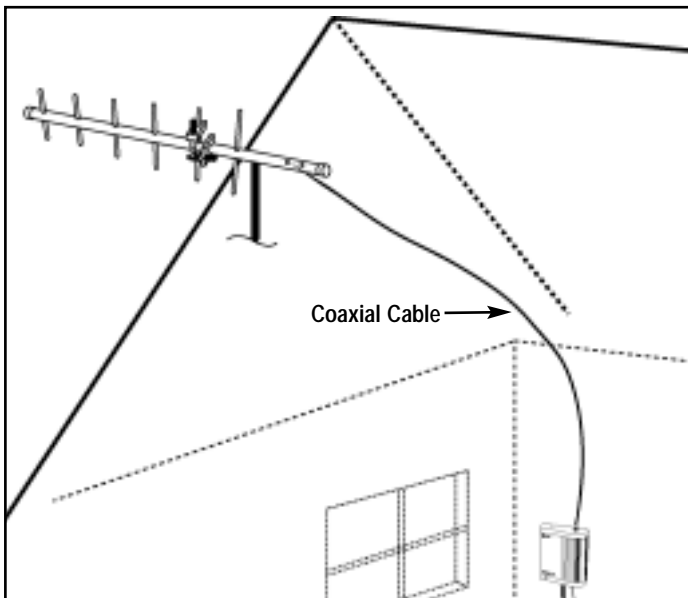

Fig. 2 Optional high-gain antenna installed on the building's exterior. Always direct the antenna toward the nearest cell tower of your service provider.

Antenna Location & Setup – Continued

How to Connect the Antenna:

- 1) Connect the Power Supply to the DC “PWR” port on the back of the Phonecell – **see Figure 3**.
- 2) Connect the AC line cord from the power supply to the AC power source. After approximately 10 seconds, the LED indicator on the front of the FWT should turn RED – **see Figure 4**
- 3) Connect an antenna to the TNC antenna connector on top of the FWT – **see Figure 5**.
- 4) Test the cellular signal strength by checking the LED indicator on the front of your Phonecell:
 - RED = No Service
 - YELLOW = Moderate signal
 - GREEN = Good signal.
- 5) Move the antenna from one location to another until you achieve the best signal strength possible.

TIP:

Many things can obstruct the cellular signal, and moving the antenna as little as one meter (3 feet) can dramatically improve signal strength and call reception.

- 6) When you're getting a strong (GREEN) signal, you're ready for the next step – connecting a phone and making a call.

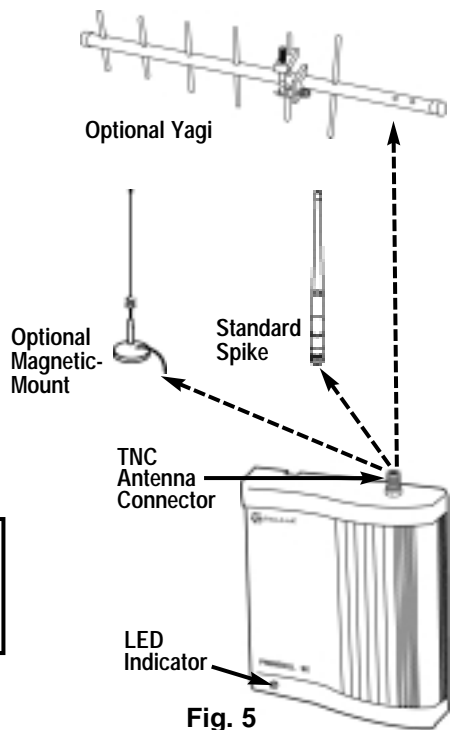
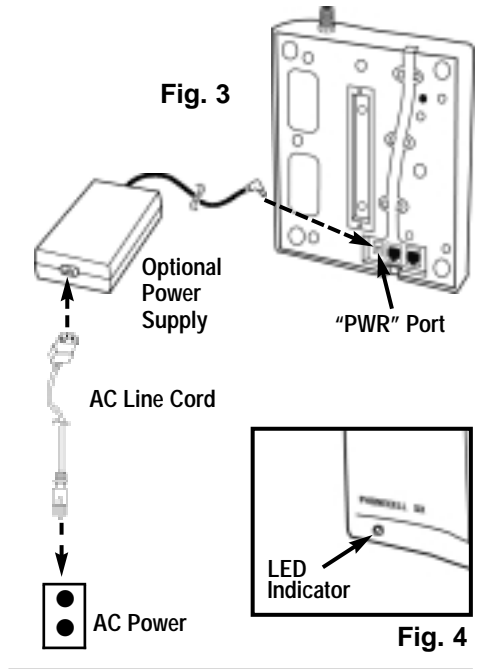
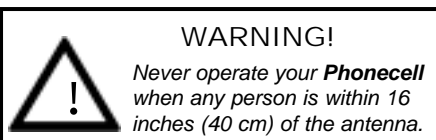

Step 2. Plug In Your Telephone

The **Phonecell SX3** lets you connect up to 5 pieces of standard telephone equipment into a cellular network. Follow the steps below for quick installation.

Connect Your Telephone:

- 1) Locate the modular (*RJ-11*) line port on your phone and plug in one end of a standard (*RJ-11*) phone cord.
- 2) Connect the other end of the cord to the RJ-11 port on the back of your **Phonecell SX3e** – see Fig. 6.

Place a Call – Adjust Your FWT:

- 1) Pick up the phone receiver and listen for dial tone.
- 2) If you hear dial tone, make a call.
- 3) While you're talking with the other party, listen for static and echo. If you hear either, move the antenna until you find the spot where voice conversation is strong, and static and echo are minimized.

NOTE: If you are unsuccessful in dialing out, it's probably due to one of the following:

- The antenna location needs to be adjusted – see **Step 1, page 6-7.**
- The NAM/Phone Number needs to be set up – see **Step 3, page 9-11.**
- Your cellular phone number has not been activated – **contact your cellular service provider.**

Adding More Phones?

Plug in an RJ-11 line splitter (*not supplied*) to connect additional phones to your FWT – see Fig. 7. **NOTE: you can only make one phone call at a time.**

Additional Telephone Equipment:

If you plan to use a device other than a telephone with your **Phonecell SX3** (*such as a modem*), make sure that device will work with a normal wired telephone line.

Fax Machines – Connect a fax machine the same way it needs to be set up for use on a regular wired telephone line.

PBX/KSU Systems – *PABX installation should only be performed by experienced telephone technicians.*

Fig. 6

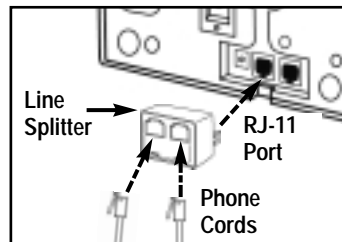
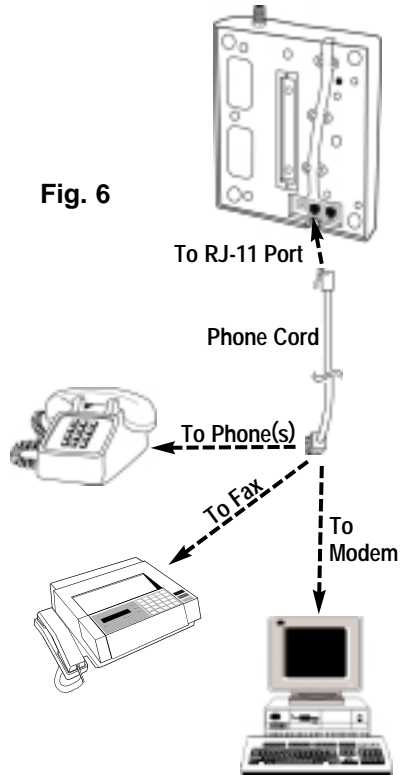

Fig. 7 Optional RJ-11 Line Splitter lets you connect additional phone equipment to your **Phonecell SX3e**.

IMPORTANT!

Make sure the wiring from the telephone equipment to your **Phonecell SX3** is properly protected from all transient voltages, including lightning.



Step 3. NAM/Phone Number Setup



IMPORTANT!

If your Phonecell was **NOT** pre-programmed for NAM (Number Assignment Module/Phone Number) information, follow the steps below. **Otherwise, continue to STEP 4 – pages 12–13.**

You can program the **Phonecell SX3** with an ordinary tone-dial (DTMF) telephone, which is sometimes referred to as a POTS (Plain Old Telephone Service) phone. **NOTE: this programming mode is not accessible while you're in a call.**

Step #1 - Pick up the POTS handset and listen for a tone (either a steady dial tone or a beeping no-service tone).

Step #2 - Enter the Master-Programming mode by pressing:

 **# * 0 * 1 2 3 4 4 3 2 1 #**

The dial tone should change to a different, steady "Programming" tone and the LED indicator on the front of your Phonecell should blink alternately RED and GREEN to indicate that you're now in the programming mode. **You now have two minutes to begin the programming steps below.**

Step #3 - Press:  **# * 1 * _ _ _ _ _ #**

The spaces represent your **10-digit** telephone number. (This is also called a Mobile Identification Number, or MIN.) If you enter the number incorrectly, you'll hear three short tones followed by the programming tone; if correct, you'll hear the programming tone again.

Step #4 - Press:  **# * 5 * _ _ _ _ _ #**

The spaces represent your **1- to 5-digit** System Identifier (SID), which ranges from **0** to **32,767**. This information identifies your cellular service provider. (For example, to set up 555, enter **#*5*555#**.) If you enter the SID incorrectly, you'll hear three short tones followed by the programming tone; if correct, you'll hear the programming tone again.

NOTE: depending upon whether you enter an odd SID or an even SID, the Phonecell will automatically set the remaining NAM parameters to AMPS standards – **as shown in the table below.**

Automatically Set NAM Parameters	AMPS Standards	
	Odd SID	Even SID
Initial Dedicated Control Channel	333	334
First Paging Channel	333	334
Number of Dedicated Control Channels	21	21
Preferred System	A	B
Roam Option (to override, see page 23)	Enabled	Enabled

If you need to override any of the settings, continue with the following steps (#5–8). Otherwise, hang up. The flashing LED indicator will become solid GREEN. *Phone number setup is complete.*

Continued...

NAM/Phone Number Setup – Override Commands

NOTE: The following NAM Parameters are automatically set by the SID value in Step #4 on the previous page. These steps (5–7) are only needed if you want to override the standard AMPS settings listed on the previous page. **Otherwise, continue to Step 4 – Wall-Mount or Desktop Installation, pages 12–13.**

Step #5a - How to Override the Initial Dedicated Control Channel and First Paging Channel.

If you have an “A” cellular service provider with an odd SID (System Identifier), enter the following 2-part key sequence. Otherwise, continue to Step #5b.

1) First press:  # * 24 * _ _ _ _ #

2) Next press:  # * 4 * _ _ _ _ #

(Note: enter the same 1- to 4-digit channel in both steps above.)

The spaces represent your 1- to 4-digit Initial Dedicated Control Channel and First Paging Channel. When you turn on your Phonedcell, these channels help the service provider find you and vice-versa.

NOTE: The default setting is channel 333 for "A" service providers. To change the setting, you must enter a 1- to 4-digit number in the range of 0 to 1023. (For example, to set up channel 565, enter #*24*565#.) If you enter the channel incorrectly, you'll hear three short tones followed by the programming tone; if correct, you'll hear the programming tone again.

Step #5b - If you have a “B” cellular service provider with an even SID (System Identifier), enter the following 2-part key sequence.

1) First press:  # * 25 * _ _ _ _ #

2) Next press:  # * 4 * _ _ _ _ #

(Note: enter the same 1- to 4-digit channel in both steps above.)

The spaces represent your 1- to 4-digit Initial Dedicated Control Channel and First Paging Channel. When you turn on your Phonedcell, these channels help the service provider find you and vice-versa.

NOTE: the default setting is channel 334 for "B" service providers. To change the setting, you must enter a 1- to 4-digit number in the range of 0 to 1023. (For example, to set up channel 566, enter #*25*566#.) If you enter the channel incorrectly, you'll hear three short tones followed by the programming tone; if correct, you'll hear the programming tone again.

Continued...

NAM/Phone Number Setup – Override Commands

Step #6 - How to Override the Number of Dedicated Control Channels.





Press:  # * 26 * _ _ #

The spaces represent your **2-digit** range of Dedicated Control Channels. When you first turn on the Phonecell, it automatically scans up to 21 control channels looking for your cellular provider. Then, it locks onto the strongest signal. NOTE: the factory default setting is **21** channels. To change the number of channels, you must enter a **2-digit** value in the range of **01** to **21**. (For instance, to set up 9 control channels, enter: #*26*09#.) If you enter the range incorrectly, you'll hear three short tones followed by the programming tone; if correct, you'll hear the programming tone again.

Step #7 - How to Override the System Preference.

Press:  # * 7 * _ #

The space represents your **1-digit** system preference.

- enter:  **0** for System "A" preferred
- enter:  **1** for System "B" preferred
- enter:  **2** for System "A" only
- enter:  **3** for System "B" only.

This sets the preference for your cellular provider. If you enter the preference incorrectly, you'll hear three short tones followed by the programming tone; if correct, you'll hear the programming tone again.

Step #8 - Hang up. The flashing LED indicator will become solid GREEN.

Optional A-Key (Authentication Code) Programming

Depending upon your cellular service provider, you may be required to enter an Authentication Code (*A-Key*) before you make or receive any calls. **Contact your service provider to determine whether A-Key is required.**

The A-Key is a cellular system solution to prevent cloning, counterfeiting and cellular fraud. It's a unique, 6- to 26-digit code provided by your service provider that validates your MIN (*Mobile Identification Number*) and ESN (*Electronic Serial Number*) before you make or receive calls. Once you've entered the A-Key, your Phonecell automatically verifies the code with the cellular provider before every call. There's no need to re-program the unit, unless you switch to a new service provider or change your MIN.

Use the following key sequence to program the A-Key:

Press:  # * 27 * <A-Key> #

The < > brackets represent your **6- to 26-digit** A-Key (*Authentication code*), which is supplied by your cellular service provider. If the A-key is less than 6 or more than 26 digits, it is considered invalid and the SX3i will not update or store this; the currently stored value will remain.



IMPORTANT!

For security reasons, your complete A-Key is never transmitted over the phone. However, you should keep the number in a safe place to prevent counterfeiting, fraud or cloning.

Step 4. Install Your Phonecell

After you've selected a location and made all the necessary connections, your **Phonecell SX3** is ready for wall-mounting or desktop installation.

PRE-INSTALLATION TIPS:

- *Make sure the location is dry, away from overhead water pipes, and protected from weather conditions.*
- *The area should be free of airborne contaminants.*
- *The Phonecell should be located within 2 meters (6 feet) of an AC power outlet.*

4a. Wall-Mount Instructions:

- 1) Hold the mounting bracket against the wall and mark two holes for the long mounting screws—*see Fig. 8.*
- 2) Remove the bracket and drill two holes for the long mounting screws—*see Figure 9.*
- 3) Install the long mounting screws into the wall, leaving about 1/8-inch (3 mm) gap between the screw heads and the wall—*see Fig. 10.*
- 4) Attach the mounting bracket to the back of the **Phonecell SX3** using the short screws provided—*see Fig. 11.*
- 5) Align the holes on the mounting bracket with the two wall-mounted screws. Then, mount the Phonecell onto the screws and slide it downward until the screw heads lock into the bracket and the unit is secure—*see Figure 12.*

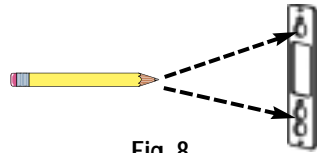

Fig. 8

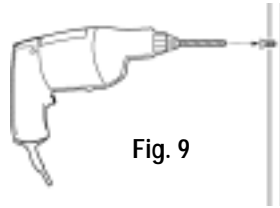

Fig. 9

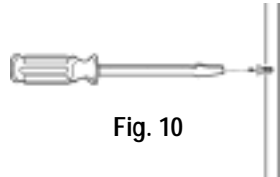

Fig. 10

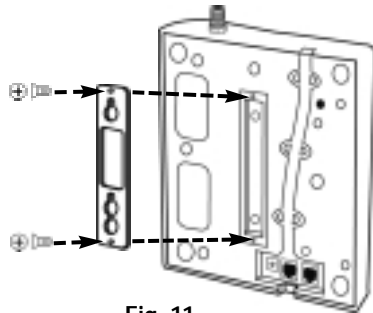

Fig. 11



Fig. 12

4b. Desktop/Tabletop Installation

After all connections are made, turn your **Phonecell SX3** face-down and attach the four rubber feet to the bottom—see **Figure 13**. Your **Phonecell SX3** is now ready for use on a desktop, tabletop or other flat surface*.

***NOTE:** Do not attach the rubber feet if the unit is to be wall-mounted.

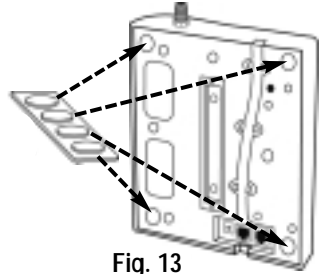

Fig. 13



IMPORTANT!

Your **Phonecell SX3** must be placed or mounted on a flat, level surface to allow proper ventilation. Do not block the air vents or the space beneath your Phonecell as this could cause the unit to overheat and fail.

Phonecell Operation

Once your **Phonecell SX3** is installed and tested, it's ready for operation.

How to Use the LED Status Indicator

- 1) Plug in the AC power supply .
- 2) Wait approximately 10 seconds for the unit to initialize.
- 3) Then, the LED indicator on the front of your Phonecell will turn ON. The *LED Status Table* below describes the modes and operation of this 3-color indicator.

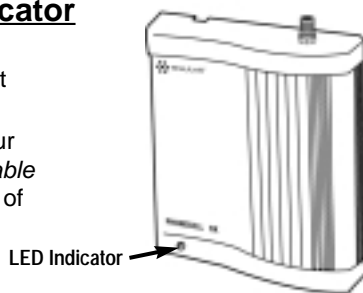

LED Status Table

LED Color	LED Activity	Description
RED	Flashing	Malfunction. Hardware fault detected
RED	Continuous	No cellular service
YELLOW	Continuous	Moderate cellular signal strength, voice
YELLOW	Flashing	Moderate signal strength, fax /data
GREEN	Continuous	Best cellular signal strength, voice
GREEN	Flashing	Best signal strength, fax/data
RED/GREEN	Flashing	Diagnostic/programming mode
OFF	None	No Power

How to Place a Call

- 1) Pick up your telephone handset (*your phone is now "off-hook"*).
- 2) Listen for dial tone (*If service is not available, a No-Service tone is produced. Hang-up the phone and try again.*)
- 3) Dial the phone number.

How to Receive a Call

- When your telephone rings, pick up the handset and begin talking.

How to End a Call

- Hang-up the phone (*place the handset back onto the telephone cradle*).

The Hookflash Function

When you initiate the Hookflash function, it automatically lets you:

- Speed up the connection after you dial a phone number.
- Answer an incoming call that occurs when you're dialing a phone number.
- Use special (*supplementary*) cellular services which may be available in your cellular service area (*see Special Cellular Services on page 16*).

How to Use the Hookflash Function

Depending upon your phone, there are two ways to initiate the Hookflash function:

- Press the dedicated "HOOKFLASH" or "FLASH" key on your telephone.
- Press the hang-up or switch-hook mechanism on your phone once quickly (*approximately 1/2-second*).

Important Tones and Alerts

No-Service Tone – When cellular service is not available, the receiver emits a No-Service (*fast-beeping*) tone instead of the normal (*steady*) dial tone.

ROH (Receiver Off-Hook) Tone – If the telephone equipment remains off-hook (*off its cradle*) with no dialing activity for 45 seconds, the receiver emits an ROH tone for 60 seconds.

Incoming Call Alert – If you're dialing a number and an incoming call occurs, the receiver will emit an audible ring. To answer the incoming call:

- Press the "HOOKFLASH" button once. This will connect the incoming call.
- OR hang-up immediately. This will cause the phone to start ringing.

How to Adjust the Volume Level

If the volume level on your phone is too high or too low, you can adjust the levels using the keypad on your telephone. **Note: your telephone must be in Tone-Dial (DTMF) mode to adjust the levels.**

To Increase Audio Level - Increase the audio level in steps by pressing:

 # * 8 (also known as # * Up)

Continue to press # * 8 until the desired level is reached.

To Decrease Audio Level - Decrease the audio level in steps by pressing:

 # * 3 (also known as # * Down)

Continue to press # * 3 until the desired level is reached.

NOTE: The default setting lets you adjust the audio up to three (3) steps in either direction (*Up or Down*).

Fax/Data Transmission

Automatic Level Setting (ALS)

When your Phonocell SX3 detects a fax or modem call, it automatically adjusts the Transmit and Receive audio levels for optimum data transmission. After the fax/data transmission is completed, the FWT resets the audio levels to their previous settings.

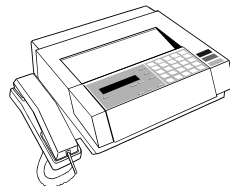

Fax/Modem Compatibility

Your Phonocell is compatible with all Group 3 facsimile machines and computer modems. Depending upon the type of modem used and the cellular network's capability, data transmission rates of 2400 baud and higher are normally possible.



Phonocell Operation – Continued

Variable Dial Time (Auto SEND Delay) Option

When you place a call, your **Phonocell SX3** automatically sends the phone number over the cellular network after you dial the last digit – just like a landline phone. However, to make sure you have enough time to dial the last digit, a 3-second *Auto SEND Delay* is programmed into the unit. This delay also affects Special Functions such as *Call Forwarding* (see *Special Cellular Services* below).

You can set the Auto SEND Delay from **2** to **20** seconds using an ordinary tone-dial (*DTMF*) phone, which is sometimes referred to as a POTS (*Plain Old Telephone Service*) phone. Note: you cannot change the delay while you're making a call.

How To Adjust the Auto SEND Delay - Pick up the telephone handset and listen for dial tone. Then, enter the User-Programming mode by pressing:

 # * 0 * 1 2 3 4 5 6 7 8 #

The dial tone should change to a steady “Programming” tone and the LED indicator on the front of your Phonocell should blink alternately RED and GREEN to indicate that you're now in the Programming mode.

Next, press:  # * 11 * <Auto SEND Delay> #

The < > brackets represent the Auto SEND Delay. You must enter a value between **2** and **20** seconds. (For instance, to enter a 5-second delay, press: # * 11 * 5 #.)

If you enter the delay incorrectly, you'll hear three short beeps followed by the programming tone. That's your cue to re-try the steps above. If correct, you'll hear the programming tone again. Hang up. Your Phonocell is ready for use.

Special Cellular Services

Your **Phonocell SX3** is compatible with a variety of special services such as call forwarding, call waiting, and more. Depending upon your cellular provider, these services may be available on a subscription basis. However, certain dialing sequences must be entered, which vary among service providers. Please consult your service provider for the dialing instructions for your system.

Call Forwarding – After you hear a dial tone on your telephone handset, dial the code required by the service provider, wait for a minimum of **3** seconds or press the HOOKFLASH.* Your Phonocell automatically transmits the call-forwarding information. Listen for the cellular carrier response. Then, hang up the phone. If you don't wait for the response, your forwarding request may not be fulfilled.

**You can set this delay for 2 to 20 seconds. See the Variable Dial Time section above. NOTE: please wait 1 second longer than the delay programmed (i.e. for the 3-second delay mentioned above, wait 4 seconds).*

Call Waiting – If your cellular provider requires codes to be entered involving digits **1-9**, *****, and **#** to answer a waiting call, the Out-of-Band Signaling option must be enabled. See the *Data After SEND* option on page 17.

Phonecell Operation – Continued

Three-Way Conference Calls - For three-way conference calls, the Out-of-Band Signaling option must be enabled. Pressing the HOOKFLASH function transmits the SEND command. *Please see the Data After SEND option below.*

Voice Mail – Out-of-Band Signaling may need to be disabled to interact with remote voice mail systems to prevent double-pulsing. *See the Data After SEND option below.*

Authentication (A-Key) – Depending upon your cellular provider, you may be required to enter an Authentication Code (A-Key) before you make or receive any calls. A-Key is a cellular system solution to prevent cloning, counterfeiting and cellular fraud. *To program the A-Key function, see the Technician Programming Section – page 25.*

Data After SEND (In-Call Signaling) Option

Depending upon your cellular provider, the Data After SEND option may need to be *Enabled* or *Disabled* to use special cellular features such as call waiting, three-way conference calls, voice mail, etc. *Please consult your service provider for the required Data After Send/In-Call DTMF Signaling configuration.*

The Data After SEND option is disabled (*Out-of-Band signaling*) at the factory. To change the Data After SEND setting, follow the steps below.





How To Set the In-Call DTMF Signaling Option - Pick up the handset and listen for dial tone. Then, enter the User-Programming mode by pressing:

 # * 0 * 1 2 3 4 5 6 7 8 #

The dial tone should change to a steady “Programming” tone and the LED indicator on the front of your Phonecell should blink alternately RED and GREEN to indicate that you’re now in the Programming mode.

Next, press:  # * 10 * <in-call DTMF option> #

The < > brackets represents the in-call DTMF signaling option. You must enter a value between 0 and 3:

- enter  0 for In-Band Signaling;
- enter  1 for Out-of-Band Signaling;
- enter  2 for both In-Band and Out-of-Band signaling;
- enter  3 for neither.

If you enter the option incorrectly, you’ll hear three short beeps followed by the programming tone. That’s your cue to re-try the steps above. If correct, you’ll hear the programming tone again. Hang up. Your Phonecell is ready for use.

Zero Dial Delay for Frequently Called Numbers

A new patent-pending feature enables the Phonecell to recognize your frequently called phone numbers and send them immediately—without the 3-second Auto SEND Delay. The Phonecell stores a list of up to 50 numbers in its memory. This list contains any number that you’ve called at least twice successfully. NOTE: cycling (*turning ON/OFF*) the power will erase the current list. A new list will be started when power is re-applied. *To enable or disable this feature, see page 24.*

Phonocell SX3 Troubleshooting

Telephone Service is Not Working

If the telephone service is not working, first check the operation of the telephone equipment and wiring connected to your **Phonocell SX3**. Test the equipment on a different service or piece of equipment to ensure proper operation, or connect a known good telephone device to the R-J-11 port on the **Phonocell SX3** unit. This will verify the condition of the telephone equipment and the internal wiring of the telephone service to ensure that it's working properly. If the telephone system or wiring is not working properly, replace or repair the equipment as required. Otherwise, contact your cellular provider or your authorized Telular distributor.

Unable to Receive Incoming Calls

If more than one telephone or telephone device is connected to your Phonocell, make sure that all devices are "on-hook" (*hung up*). If one extension is "off-hook" (*off its cradle*), none of the extensions on your phone line will ring when an incoming call occurs.

Moisture or Ventilation Problems

Visually inspect your **Phonocell** unit's enclosure. Moisture can damage the equipment. Ventilation is also very important. If there are moisture or ventilation problems, move your **Phonocell SX3** to correct as necessary.

No Power

The LED lamp on the front of your **Phonocell SX3** indicates the unit's power condition. If the LED is RED, YELLOW or GREEN, your Phonocell is receiving power. If the power cord is connected and the LED lamp is not lit, the Phonocell is not receiving power. Verify that the AC power source and its corresponding circuit breaker are functioning properly.

Battery Backup Failure

If you're using the optional Battery Backup Unit, the unit must be connected to AC power for at least 24 hours to fully charge the batteries before they'll back up your **Phonocell SX3**. Verify that the batteries have been charged for at least 24 hours and that the power source and its corresponding circuit breaker are functioning properly. Then, examine the batteries for wear and corrosion. Replace the batteries if necessary.



WARNING!

*Only Authorized Service Personnel should remove the cover of your **Phonocell SX3**. For further assistance, contact your Authorized Telular Representative. Please have your unit's model and serial number ready.*

Safety Information



IMPORTANT!

*To ensure safe and efficient operation, please read the following information and observe these guidelines whenever using your **Phonecell SX3 FWT**.*



Your **Phonecell SX3 FWT** (*Fixed Wireless Terminal*) functions as both a radio transmitter and receiver. When it is ON, the FWT receives and sends out radio frequency (RF) energy. The unit may operate in frequency ranges between 824 MHz and 894 MHz. The FWT employs commonly used frequency modulation (FM) techniques. When you use your **Phonecell SX3**, the cellular system handling your call controls the power level at which your unit transmits. The power level can range from **0.006-watt** to **3 watts**.

Exposure to RF (Radio Frequency) Energy

In 1991, the Institute of Electrical and Electronics Engineers (IEEE), and in 1992, the American National Standards Institute (ANSI), updated the 1982 ANSI Standard for safety levels with respect to human exposure to RF energy. After reviewing the available body of research, more than 120 scientists, engineers and physicians from universities, government health agencies and industry developed this updated Standard. In March, 1993, the U.S. Federal Communications Commission (FCC) proposed the adoption of this updated Standard.

The design of your Telular **Phonecell SX3 FWT** complies with this updated Standard. Of course, if you want to limit RF exposure even further than the updated ANSI Standard, you may choose to control the duration of your calls and operate your phone in the most power-efficient manner.

Safe Operation Requirement

Do not operate your Phonecell SX when any person is within 16 inches (40 cm) of the antenna.

Antenna Care and Replacement



Do not use the FWT with a damaged antenna. If a damaged antenna comes into contact with the skin, a minor burn may result. Have your antenna replaced by a qualified technician immediately. Use only a manufacturer-approved antenna. Unauthorized antennas, modifications, or attachments could damage the FWT and will void the Grant of Type Acceptance.



WARNING!

*Your **Phonecell SX3** must be placed or mounted on a flat, level surface to allow proper ventilation. Do not block the air vents or the space beneath your Phonecell as this could cause the unit to overheat and fail.*

Safety Information – Continued

Driving



Check the laws and regulations on the use of cellular products in the areas where you drive. Some jurisdictions prohibit your using a cellular device while driving a vehicle. Even if your jurisdiction does not have such a law, we strongly suggest that,

for safety reasons, the driver use extreme caution when operating the cellular device while the vehicle is in motion. Always obey the law.

Electronic Devices

Most modern electronic equipment is shielded from RF energy. However, RF energy from cellular devices may affect inadequately shielded electronic equipment.

RF energy may affect improperly installed or inadequately shielded electronic operating and entertainment systems in motor vehicles. Check with the manufacturer or its representative to determine if these systems are adequately shielded from external RF energy. You should also check with the manufacturer of any equipment that has been added to your vehicle.

Consult the manufacturer of any personal medical devices (*such as pacemakers, hearing aids, etc.*) to determine if they are adequately shielded from external RF energy.

Turn your **Phoncell SX3** FWT OFF in health care facilities when any regulations posted in the areas instruct you to do so. Hospitals or health care facilities may be using equipment that could be sensitive to external RF energy.

Aircraft



Turn OFF your **Phoncell SX3** before boarding any aircraft.

- Use it on the ground only with crew permission.
- Do not use it in the air.

To prevent possible interference with aircraft systems, U.S.

Federal Aviation Administration (*FAA*) regulations require you to have permission from a crew member to use your cellular phone (*or any other cellular product*) while the plane is on the ground. To prevent interference with aircraft systems, FCC regulations prohibit using your cellular phone system while the plane is in the air.

Children

Do not allow children to play with your **Phoncell** to prevent damage to the unit.

Blasting Areas



Construction crews often use remote control RF devices to set off explosives. Therefore, to avoid interfering with blasting operations, turn your **Phoncell SX3** OFF when in a "blasting area" or in areas posted: "Turn off two-way radio."

Potentially Explosive Atmospheres



Turn your **Phonecell SX3** OFF when in any area with a potentially explosive atmosphere. It is rare, but your **Phonecell SX3** or its accessories could generate sparks. Sparks in such areas could cause an explosion or fire resulting in bodily injury or even death.

Areas with a potentially explosive atmosphere are often, but not always, clearly marked. They include fueling areas such as gas stations; below deck on boats; fuel or chemical transfer or storage facilities; areas where the air contains chemicals or particles, such as grain, dust, or metal powders; and any other area where you would normally be advised to turn off your vehicle engine.

Do not transport or store flammable gas, liquid or explosives in the area of your **Phonecell SX3** or accessories.

Vehicles using liquefied petroleum gas (such as propane or butane) must comply with the National Fire Protection Standard (FPA-58). For a copy of this standard, contact the National Fire Protection Association, One Batterymarch Park, Quincy, MA 02269, Attn: Publications Sales Division.

FCC Part 15 Class B Compliance

This **Phonecell SX3** model has been tested and found to comply with the limits for a Class B digital device, pursuant to Part 15 of the FCC rules. These limits are designed to provide reasonable protection against harmful interference in a residential installation. This equipment generates, uses and can radiate radio frequency energy and, if not installed and used in accordance with the instructions, may cause harmful interference to radio communications. However, there is no guarantee that interference will not occur in a particular installation. If this equipment does cause harmful interference to radio or television reception, which can be determined by turning the equipment OFF and ON, the user is encouraged to try to correct the interference by one or more of the following measures:

- Reorient or relocate the antenna.
- Increase the separation between the equipment and the terminal.
- Connect the equipment into an outlet on a circuit different from that to which the terminal is connected.
- Consult your Authorized Telular Distributor or an experienced radio/TV technician for help.

AMPS Technician Programming

IMPORTANT!



*The following commands may be used by a trained service technician to change the configuration of the **Phoncell SX3**. **WARNING:** these commands are intended for use by trained service technicians only. Untrained users could damage the Phoncell, violate local regulations and breach the service agreement with the cellular provider. For further assistance, please contact your Authorized Telular Representative.*

AMPS Technician Programming Commands

The **Phoncell SX3** can be programmed on location with an ordinary telephone, which is sometimes referred to as a POTS (*Plain Old Telephone Set*) phone.

NOTE: the Technician Programming mode is not accessible while in a call.

In the following sections, an **<entered value>** is comprised of the digits **0** through **9**. The digits **'*** and **'#'** are considered invalid when used inside an **<entered value>**, and will cause that command/value to be rejected.

When you enter the programming mode, a timer is started. If there are no key entries within any 2-minute period, the FWT will revert to its normal mode. Going on-hook (*hanging up the phone*) will exit the programming mode.

How to Enter the Technician Programming Mode

Use the following access code to enter the Programming mode:

Press:  **# * 0 * 1 2 3 4 4 3 2 1 #**

The access code is **8** digits. If the access code is not 8 digits or does not match the stored access code, the Technician Programming mode cannot be entered. This code is pre-programmed during production and cannot be changed in the field.

If you enter the access code correctly, the dial tone should change to a different, steady "Programming" tone and the LED indicator on the front of the Phoncell will blink alternately RED and GREEN to indicate that you're in the programming mode.

Technician Programming Commands – Continued

How to Set the Access Overload Class (ACCOLC)

Use the following key sequence to set the ACCOLC:

Press:  # * 2 * < ACCOLC > #

The < > brackets represent the **2-digit** ACCOLC. You must enter a 2-digit value between **00** and **15**, otherwise the FWT will not update or store this value; the existing stored parameter will remain. (For example, to program the FWT for ACCOLC 8, enter: # * 2 * 08 #.)

How to Set the Access Method (EX) Option

Use the following key sequence to set the EX option:

Press:  # * 3 * <EX option> #

The < > brackets represent the **1-digit** EX option:

enter:  **1** if the FWT must always send the full MIN (*Mobile Identification Number*) when accessing the system

enter:  **0** if not.

You must enter either **0** or **1**, otherwise the FWT will not update or store this value; the existing stored parameter will remain. The factory default setting is **1**.

How to Set the Roam Option

Use the following key sequence to set the Roam option:

Press:  # * 6 * <Roam option> #

The < > brackets represent the **1-digit** Roam option:

enter:  **0** to enable roaming

enter:  **1** to disable roaming.

You must enter either **0** or **1**, otherwise the FWT will not update or store this value; the existing stored parameter will remain. The factory default setting is **0**.

How to Set the Dial Tone After Remote On-Hook Option

Use the following key sequence to set the Dial Tone After Remote On-Hook option:

Press:  # * 8 * <Dial Tone option> #

The < > brackets represent the **1-digit** dial tone option:

enter:  **0** for no dial tone after a remote on-hook

enter:  **1** to enable dial tone after remote on-hook.

You must enter either **0** or **1**, otherwise the FWT will not update or store this value; the existing stored parameter will remain. The factory default setting is **1**.

Technician Programming Commands – Continued

How to Set the Post-Receiver Off-Hook (ROH) Option

Use the following key sequence to set the post-ROH option:

Press:  # * 9 * <Post-ROH option> #

The < > brackets represent the **1-digit** post-ROH option:

enter:  0 for continuous ROH tone

enter:  1 to turn off ROH tone and periodically check for an on-hook condition.

You must enter either **0** or **1**, otherwise the FWT will not update or store this value and the existing stored parameter will remain. The factory default setting is **1**.

How to Set the Pulse Dial Option

Use the following key sequence to set the Pulse Dial option:

Press:  # * 12 * <Pulse Dial option> #

The < > brackets represent the **1-digit** Pulse Dial option:

enter:  0 to disable pulse dialing capability

enter:  1 to enable pulse dialing capability.

You must enter either **0** or **1**, otherwise the FWT will not update or store this value; the existing factory default setting is **1**.

How to Initiate a Ring-Back Request

Use the following key sequence to initiate an immediate Ring Back:

Press:  # * 13 * #

There is no Ring Back value to be entered; the command activates when the phone is placed on-hook.

How to Restore the Factory Default Settings

Use the following key sequence to restore the factory default settings:

Press:  # * 15 * #

There is no Restore Defaults value to be entered; the command activates immediately. If you enter a value, it will be invalid and the FWT will not restore the factory defaults. **Note:** NAM (*Phone Number Setup*) data is not affected by this command and will not be changed.

How to Enable/Disable the Zero Dial Delay Option

Use the following key sequence to set the Zero Dial Delay option:

Press:  # * 21 * <Zero Dial Delay option> #

The < > brackets represent the **1-digit** Zero Dial Delay option:

enter:  0 to disable Zero Dial Delay option

enter:  1 to enable Zero Dial Delay option

You must enter either **0** or **1**, otherwise the FWT will not update or store this value; the existing stored parameter will remain. The factory default setting is **1**.

Technician Programming Commands – Continued

How to Enter the Periodic Self Test Option

Use the following key sequence to program the periodic self test:

Press:  # * 76 * <self test interval> #

The self test interval is programmed in 1 minute intervals from 1 to 65,535. A value of 0 disables the self test. If the value is not between 9 and 65,535 it will be considered invalid. The factory default setting is **180**.

Free Manuals Download Website

<http://myh66.com>

<http://usermanuals.us>

<http://www.somanuals.com>

<http://www.4manuals.cc>

<http://www.manual-lib.com>

<http://www.404manual.com>

<http://www.luxmanual.com>

<http://aubethermostatmanual.com>

Golf course search by state

<http://golfingnear.com>

Email search by domain

<http://emailbydomain.com>

Auto manuals search

<http://auto.somanuals.com>

TV manuals search

<http://tv.somanuals.com>